



CODE OF FEDERAL REGULATIONS

Title 49 Transportation

Parts 100 to 177

Revised as of October 1, 2014

Containing a codification of documents
of general applicability and future effect

As of October 1, 2014

Published by the Office of the Federal Register
National Archives and Records Administration
as a Special Edition of the Federal Register



U.S. GOVERNMENT OFFICIAL EDITION NOTICE

Legal Status and Use of Seals and Logos

The seal of the National Archives and Records Administration (NARA) authenticates the Code of Federal Regulations (CFR) as the official codification of Federal regulations established under the Federal Register Act. Under the provisions of 44 U.S.C. 1507, the contents of the CFR, a special edition of the Federal Register, shall be judicially noticed. The CFR is prima facie evidence of the original documents published in the Federal Register (44 U.S.C. 1510).

It is prohibited to use NARA's official seal and the stylized Code of Federal Regulations logo on any republication of this material without the express, written permission of the Archivist of the United States or the Archivist's designee. Any person using NARA's official seals and logos in a manner inconsistent with the provisions of 36 CFR part 1200 is subject to the penalties specified in 18 U.S.C. 506, 701, and 1017.

Use of ISBN Prefix

This is the Official U.S. Government edition of this publication and is herein identified to certify its authenticity. Use of the 0-16 ISBN prefix is for U.S. Government Printing Office Official Editions only. The Superintendent of Documents of the U.S. Government Printing Office requests that any reprinted edition clearly be labeled as a copy of the authentic work with a new ISBN.



U.S. GOVERNMENT PRINTING OFFICE

U.S. Superintendent of Documents • Washington, DC 20402-0001

<http://bookstore.gpo.gov>

Phone: toll-free (866) 512-1800; DC area (202) 512-1800

Table of Contents

	<i>Page</i>
Explanation	v
Title 49:	
SUBTITLE B—OTHER REGULATIONS RELATING TO TRANSPORTATION	
Chapter I—Pipeline and Hazardous Materials Safety Administration, Department of Transportation	5
Finding Aids:	
Table of CFR Titles and Chapters	883
Alphabetical List of Agencies Appearing in the CFR	903
List of CFR Sections Affected	913

Cite this Code: CFR

*To cite the regulations in
this volume use title,
part and section num-
ber. Thus, 49 CFR 105.5
refers to title 49, part
105, section 5.*

Explanation

The Code of Federal Regulations is a codification of the general and permanent rules published in the Federal Register by the Executive departments and agencies of the Federal Government. The Code is divided into 50 titles which represent broad areas subject to Federal regulation. Each title is divided into chapters which usually bear the name of the issuing agency. Each chapter is further subdivided into parts covering specific regulatory areas.

Each volume of the Code is revised at least once each calendar year and issued on a quarterly basis approximately as follows:

Title 1 through Title 16.....	as of January 1
Title 17 through Title 27.....	as of April 1
Title 28 through Title 41.....	as of July 1
Title 42 through Title 50.....	as of October 1

The appropriate revision date is printed on the cover of each volume.

LEGAL STATUS

The contents of the Federal Register are required to be judicially noticed (44 U.S.C. 1507). The Code of Federal Regulations is prima facie evidence of the text of the original documents (44 U.S.C. 1510).

HOW TO USE THE CODE OF FEDERAL REGULATIONS

The Code of Federal Regulations is kept up to date by the individual issues of the Federal Register. These two publications must be used together to determine the latest version of any given rule.

To determine whether a Code volume has been amended since its revision date (in this case, October 1, 2014), consult the "List of CFR Sections Affected (LSA)," which is issued monthly, and the "Cumulative List of Parts Affected," which appears in the Reader Aids section of the daily Federal Register. These two lists will identify the Federal Register page number of the latest amendment of any given rule.

EFFECTIVE AND EXPIRATION DATES

Each volume of the Code contains amendments published in the Federal Register since the last revision of that volume of the Code. Source citations for the regulations are referred to by volume number and page number of the Federal Register and date of publication. Publication dates and effective dates are usually not the same and care must be exercised by the user in determining the actual effective date. In instances where the effective date is beyond the cut-off date for the Code a note has been inserted to reflect the future effective date. In those instances where a regulation published in the Federal Register states a date certain for expiration, an appropriate note will be inserted following the text.

OMB CONTROL NUMBERS

The Paperwork Reduction Act of 1980 (Pub. L. 96-511) requires Federal agencies to display an OMB control number with their information collection request.

Many agencies have begun publishing numerous OMB control numbers as amendments to existing regulations in the CFR. These OMB numbers are placed as close as possible to the applicable recordkeeping or reporting requirements.

PAST PROVISIONS OF THE CODE

Provisions of the Code that are no longer in force and effect as of the revision date stated on the cover of each volume are not carried. Code users may find the text of provisions in effect on any given date in the past by using the appropriate List of CFR Sections Affected (LSA). For the convenience of the reader, a “List of CFR Sections Affected” is published at the end of each CFR volume. For changes to the Code prior to the LSA listings at the end of the volume, consult previous annual editions of the LSA. For changes to the Code prior to 2001, consult the List of CFR Sections Affected compilations, published for 1949-1963, 1964-1972, 1973-1985, and 1986-2000.

“[RESERVED]” TERMINOLOGY

The term “[Reserved]” is used as a place holder within the Code of Federal Regulations. An agency may add regulatory information at a “[Reserved]” location at any time. Occasionally “[Reserved]” is used editorially to indicate that a portion of the CFR was left vacant and not accidentally dropped due to a printing or computer error.

INCORPORATION BY REFERENCE

What is incorporation by reference? Incorporation by reference was established by statute and allows Federal agencies to meet the requirement to publish regulations in the Federal Register by referring to materials already published elsewhere. For an incorporation to be valid, the Director of the Federal Register must approve it. The legal effect of incorporation by reference is that the material is treated as if it were published in full in the Federal Register (5 U.S.C. 552(a)). This material, like any other properly issued regulation, has the force of law.

What is a proper incorporation by reference? The Director of the Federal Register will approve an incorporation by reference only when the requirements of 1 CFR part 51 are met. Some of the elements on which approval is based are:

- (a) The incorporation will substantially reduce the volume of material published in the Federal Register.
- (b) The matter incorporated is in fact available to the extent necessary to afford fairness and uniformity in the administrative process.
- (c) The incorporating document is drafted and submitted for publication in accordance with 1 CFR part 51.

What if the material incorporated by reference cannot be found? If you have any problem locating or obtaining a copy of material listed as an approved incorporation by reference, please contact the agency that issued the regulation containing that incorporation. If, after contacting the agency, you find the material is not available, please notify the Director of the Federal Register, National Archives and Records Administration, 8601 Adelphi Road, College Park, MD 20740-6001, or call 202-741-6010.

CFR INDEXES AND TABULAR GUIDES

A subject index to the Code of Federal Regulations is contained in a separate volume, revised annually as of January 1, entitled CFR INDEX AND FINDING AIDS. This volume contains the Parallel Table of Authorities and Rules. A list of CFR titles, chapters, subchapters, and parts and an alphabetical list of agencies publishing in the CFR are also included in this volume.

An index to the text of “Title 3—The President” is carried within that volume. The Federal Register Index is issued monthly in cumulative form. This index is based on a consolidation of the “Contents” entries in the daily Federal Register.

A List of CFR Sections Affected (LSA) is published monthly, keyed to the revision dates of the 50 CFR titles.

REPUBLICATION OF MATERIAL

There are no restrictions on the republication of material appearing in the Code of Federal Regulations.

INQUIRIES

For a legal interpretation or explanation of any regulation in this volume, contact the issuing agency. The issuing agency’s name appears at the top of odd-numbered pages.

For inquiries concerning CFR reference assistance, call 202–741–6000 or write to the Director, Office of the Federal Register, National Archives and Records Administration, 8601 Adelphi Road, College Park, MD 20740-6001 or e-mail fedreg.info@nara.gov.

SALES

The Government Printing Office (GPO) processes all sales and distribution of the CFR. For payment by credit card, call toll-free, 866-512-1800, or DC area, 202-512-1800, M-F 8 a.m. to 4 p.m. e.s.t. or fax your order to 202-512-2104, 24 hours a day. For payment by check, write to: US Government Printing Office – New Orders, P.O. Box 979050, St. Louis, MO 63197-9000.

ELECTRONIC SERVICES

The full text of the Code of Federal Regulations, the LSA (List of CFR Sections Affected), The United States Government Manual, the Federal Register, Public Laws, Public Papers of the Presidents of the United States, Compilation of Presidential Documents and the Privacy Act Compilation are available in electronic format via www.ofr.gov. For more information, contact the GPO Customer Contact Center, U.S. Government Printing Office. Phone 202-512-1800, or 866-512-1800 (toll-free). E-mail, ContactCenter@gpo.gov.

The Office of the Federal Register also offers a free service on the National Archives and Records Administration’s (NARA) World Wide Web site for public law numbers, Federal Register finding aids, and related information. Connect to NARA’s web site at www.archives.gov/federal-register.

The e-CFR is a regularly updated, unofficial editorial compilation of CFR material and Federal Register amendments, produced by the Office of the Federal Register and the Government Printing Office. It is available at www.ecfr.gov.

CHARLES A. BARTH,
Director,
Office of the Federal Register.
October 1, 2014.

THIS TITLE

Title 49—TRANSPORTATION is composed of nine volumes. The parts in these volumes are arranged in the following order: Parts 1–99, parts 100–185, parts 186–199, parts 200–299, parts 300–399, parts 400–599, parts 600–999, parts 1000–1199, part 1200 to End. The first volume (parts 1–99) contains current regulations issued under subtitle A—Office of the Secretary of Transportation; the second volume (parts 100–185) and the third volume (parts 186–199) contain the current regulations issued under chapter I—Pipeline and Hazardous Materials Safety Administration (DOT); the fourth volume (parts 200–299) contains the current regulations issued under chapter II—Federal Railroad Administration (DOT); the fifth volume (parts 300–399) contains the current regulations issued under chapter III—Federal Motor Carrier Safety Administration (DOT); the sixth volume (parts 400–599) contains the current regulations issued under chapter IV—Coast Guard (DHS), chapter V—National Highway Traffic Safety Administration (DOT); the seventh volume (parts 600–999) contains the current regulations issued under chapter VI—Federal Transit Administration (DOT), chapter VII—National Railroad Passenger Corporation (AMTRAK), and chapter VIII—National Transportation Safety Board; the eighth volume (parts 1000–1199) contains the current regulations issued under chapter X—Surface Transportation Board and the ninth volume (part 1200 to End) contains the current regulations issued under chapter X—Surface Transportation Board, chapter XI—Research and Innovative Technology Administration, and chapter XII—Transportation Security Administration, Department of Transportation. The contents of these volumes represent all current regulations codified under this title of the CFR as of October 1, 2014.

In the volume containing parts 100–185, see §172.101 for the Hazardous Materials Table. The Federal Motor Vehicle Safety Standards appear in part 571.

Redesignation tables for chapter III—Federal Motor Carrier Safety Administration, Department of Transportation and chapter XII—Transportation Security Administration, Department of Transportation appear in the Finding Aids section of the fifth and ninth volumes.

For this volume, Ann Worley was Chief Editor. The Code of Federal Regulations publication program is under the direction of John Hyrum Martinez, assisted by James Hemphill.

Title 49—Transportation

(This book contains parts 100 to 177)

SUBTITLE B—OTHER REGULATIONS RELATING TO TRANSPORTATION

	<i>Part</i>
CHAPTER I—Pipeline and Hazardous Materials Safety Administration, Department of Transportation	105

Subtitle B—Other Regulations Relating to Transportation

CHAPTER I—PIPELINE AND HAZARDOUS MATERIALS SAFETY ADMINISTRATION, DEPARTMENT OF TRANSPORTATION

SUBCHAPTER A—HAZARDOUS MATERIALS AND OIL TRANSPORTATION

<i>Part</i>		<i>Page</i>
100–104	[Reserved]	
105	Hazardous Materials Program definitions and general procedures	7
106	Rulemaking procedures	13
107	Hazardous materials program procedures	19
109	Department of Transportation hazardous material procedural regulations	74
110	Hazardous materials public sector training and planning grants	82

SUBCHAPTER B—OIL TRANSPORTATION

130	Oil spill prevention and response plans	90
-----	---	----

SUBCHAPTER C—HAZARDOUS MATERIALS REGULATIONS

171	General information, regulations, and definitions ..	93
172	Hazardous materials table, special provisions, hazardous materials communications, emergency response information, training requirements, and security plans	139
173	Shippers—general requirements for shipments and packagings	434
174	Carriage by rail	752
175	Carriage by aircraft	777
176	Carriage by vessel	799
177	Carriage by public highway	859

SUBCHAPTER A—HAZARDOUS MATERIALS AND OIL TRANSPORTATION

PARTS 100–104 [RESERVED]

PART 105—HAZARDOUS MATERIALS PROGRAM DEFINITIONS AND GENERAL PROCEDURES

Subpart A—Definitions

Sec.

105.5 Definitions.

Subpart B—General Procedures

105.15 Defined terms used in this subpart.

OBTAINING GUIDANCE AND PUBLIC INFORMATION

105.20 Guidance and interpretations.

105.25 Reviewing public documents.

105.26 Obtaining records on file with PHMSA.

105.30 Information made available to the public and request for confidential treatment.

SERVING DOCUMENTS

105.35 Serving documents in PHMSA proceedings.

105.40 Designated agents for non-residents.

SUBPOENAS

105.45 Issuing a subpoena.

105.50 Serving a subpoena.

105.55 Refusal to obey a subpoena.

AUTHORITY: 49 U.S.C. 5101–5127; 49 CFR 1.53.

SOURCE: 67 FR 42951, June 25, 2002, unless otherwise noted.

EDITORIAL NOTE: Nomenclature changes to part 105 appear at 70 FR 56087, Sept. 23, 2005.

Subpart A—Definitions

§ 105.5 Definitions.

(a) This part contains the definitions for certain words and phrases used throughout this subchapter (49 CFR parts 105 through 110). At the beginning of each subpart, the Pipeline and Hazardous Materials Safety Administration (“PHMSA” or “we”) will identify the defined terms that are used within the subpart—by listing them—and refer the reader to the definitions in this part. This way, readers will know that PHMSA has given a term a precise

meaning and will know where to look for it.

(b) Terms used in this part are defined as follows:

Associate Administrator means Associate Administrator for Hazardous Materials Safety, Pipeline and Hazardous Materials Safety Administration.

Approval means written consent, including a competent authority approval, from the Associate Administrator or other designated Department official, to perform a function that requires prior consent under subchapter C of this chapter (49 CFR parts 171 through 180).

Competent Authority means a national agency that is responsible, under its national law, for the control or regulation of some aspect of hazardous materials (dangerous goods) transportation. Another term for Competent Authority is “Appropriate authority” which is used in the International Civil Aviation Organization’s (ICAO) Technical Instructions for the Safe Transport of Dangerous Goods by Air. The Associate Administrator is the United States Competent Authority for purposes of 49 CFR part 107.

Competent Authority Approval means an approval by the competent authority that is required under an international standard (for example, the ICAO Technical Instructions for the Safe Transport of Dangerous Goods by Air and the International Maritime Dangerous Goods Code). Any of the following may be considered a competent authority approval if it satisfies the requirement of an international standard:

(1) A specific regulation in subchapter A or C of this chapter.

(2) A special permit or approval issued under subchapter A or C of this chapter.

(3) A separate document issued to one or more persons by the Associate Administrator.

Federal hazardous material transportation law means 49 U.S.C. 5101 *et seq.*

File or *Filed* means received by the appropriate PHMSA or other designated office within the time specified

in a regulation or rulemaking document.

Hazardous material means a substance or material that the Secretary of Transportation has determined is capable of posing an unreasonable risk to health, safety, and property when transported in commerce, and has designated as hazardous under section 5103 of Federal hazardous materials transportation law (49 U.S.C. 5103). The term includes hazardous substances, hazardous wastes, marine pollutants, elevated temperature materials, materials designated as hazardous in the Hazardous Materials Table (see 49 CFR 172.101), and materials that meet the defining criteria for hazard classes and divisions in part 173 of subchapter C of this chapter.

Hazardous Materials Regulations or *HMR* means the regulations at 49 CFR parts 171 through 180.

Indian tribe has the same meaning given that term in section 4 of the Indian Self-Determination and Education Assistance Act (25 U.S.C. 450b).

Person means an individual, firm, co-partnership, corporation, company, association, or joint-stock association (including any trustee, receiver, assignee, or similar representative); or a government or Indian tribe (or an agency or instrumentality of any government or Indian tribe) that transports a hazardous material to further a commercial enterprise or offers a hazardous material for transportation in commerce. Person does not include the following:

- (1) The United States Postal Service.
- (2) Any agency or instrumentality of the Federal government, for the purposes of 49 U.S.C. 5123 (civil penalties) and 5124 (criminal penalties).
- (3) Any government or Indian tribe (or an agency or instrumentality of any government or Indian tribe) that transports hazardous material for a governmental purpose.

Political subdivision means a municipality; a public agency or other instrumentality of one or more States, municipalities, or other political body of a State; or a public corporation, board, or commission established under the laws of one or more States.

Preemption determination means an administrative decision by the Asso-

ciate Administrator that Federal hazardous materials law does or does not void a specific State, political subdivision, or Indian tribe requirement.

Regulations issued under Federal hazardous material transportation law include this subchapter A (parts 105–110) and subchapter C (parts 171–180) of this chapter, certain regulations in chapter I (United States Coast Guard) of title 46, Code of Federal Regulations, and in chapters III (Federal Motor Carrier Safety Administration) and XII (Transportation Security Administration) of subtitle B of this title, as indicated by the authority citations therein.

Special permit means a document issued by the Associate Administrator under the authority of 49 U.S.C. 5117 permitting a person to perform a function that is not otherwise permitted under subchapter A or C of this chapter, or other regulations issued under 49 U.S.C. 5101 et seq. (e.g., Federal Motor Carrier Safety routing requirements). The terms “special permit” and “exemption” have the same meaning for purposes of subchapter A or C of this chapter or other regulations issued under 49 U.S.C. 5101 through 5127. An exemption issued prior to October 1, 2005 remains valid until it is past its expiration date, terminated by the Associate Administrator, or is issued as a special permit, whichever occurs first.

State means a State of the United States, the District of Columbia, the Commonwealth of Puerto Rico, the Commonwealth of the Northern Mariana Islands, the Virgin Islands, American Samoa, Guam, or any other territory or possession of the United States designated by the Secretary.

Transports or Transportation means the movement of property and loading, unloading, or storage incidental to the movement.

Waiver of Preemption means a decision by the Associate Administrator to forego preemption of a non-Federal requirement—that is, to allow a State, political subdivision or Indian tribe requirement to remain in effect. The non-Federal requirement must provide at least as much public protection as the Federal hazardous materials transportation law and the regulations

issued under Federal hazardous materials transportation law, and may not unreasonably burden commerce.

[67 FR 42951, June 25, 2002, as amended at 68 FR 52846, Sept. 8, 2003; 70 FR 56087, Sept. 23, 2005; 70 FR 73158, Dec. 9, 2005]

Subpart B—General Procedures

§ 105.15 Defined terms used in this subpart.

The following defined terms (see subpart A of this part) appear in this subpart: Approval; Federal hazardous material transportation law; Hazardous material; Hazardous materials regulations; Indian tribe; Preemption determination; Special permit; State; Transportation; Waiver of preemption

[67 FR 42951, June 25, 2002, as amended at 70 FR 73159, Dec. 9, 2005]

OBTAINING GUIDANCE AND PUBLIC INFORMATION

§ 105.20 Guidance and interpretations.

(a) *Hazardous materials regulations.* You can obtain information and answers to your questions on compliance with the hazardous materials regulations (49 CFR parts 171 through 180) and interpretations of those regulations by contacting PHMSA's Office of Hazardous Materials Safety as follows:

(1) Call the Hazardous Materials Information Center at 1-800-467-4922 (in Washington, DC, call (202) 366-4488). The Center is staffed from 9 a.m. through 5 p.m. Eastern time, Monday through Friday except Federal holidays. After hours, you can leave a recorded message and your call will be returned by the next business day.

(2) E-mail the Hazardous Materials Information Center at infoctr@dot.gov.

(3) Obtain hazardous materials safety information via the Internet at <http://www.phmsa.dot.gov>.

(4) Send a letter, with your return address and a daytime telephone number, to: Standards and Rulemaking Division, Pipeline and Hazardous Materials Safety Administration, Attn: PHH-10, U.S. Department of Transportation, East Building, 1200 New Jersey Avenue, SE., Washington, DC 20590-0001.

(b) *Federal hazardous materials transportation law and preemption.* You can

obtain information and answers to your questions on Federal hazardous materials transportation law, 49 U.S.C. 5101 *et seq.*, and Federal preemption of State, local, and Indian tribe hazardous material transportation requirements, by contacting PHMSA's Office of the Chief Counsel as follows:

(1) Call the office of the Chief Counsel at (202) 366-4400 from 9 a.m. to 5 p.m. Eastern time, Monday through Friday except Federal holidays.

(2) Access information from the Office of the Chief Counsel via the Internet at <http://www.phmsa.dot.gov>.

(3) Send a letter, with your return address and a daytime telephone number, to: Office of the Chief Counsel, Pipeline and Hazardous Materials Safety Administration, Attn: PHC-10, U.S. Department of Transportation, East Building, 1200 New Jersey Avenue, SE., Washington, DC 20590-0001.

(4) Contact the Office of the Chief Counsel for a copy of applications for preemption determinations, waiver of preemption determinations, and inconsistency rulings received by PHMSA before February 1, 1997.

[70 FR 56087, Sept. 23, 2005, as amended at 72 FR 55682, Oct. 1, 2007; 76 FR 56310, Sept. 13, 2011]

§ 105.25 Reviewing public documents.

PHMSA is required by statute to make certain documents and information available to the public. You can review and copy publicly available documents and information at the locations described in this section.

(a) *DOT Docket Management System.* Unless a particular document says otherwise, the following documents are available for public review and copying at the Department of Transportation's Docket Management System, West Building Ground Floor, Room W12-140, 1200 New Jersey Avenue, SE., Washington, DC 20590-0001, or for review and downloading through the Internet at <http://www.regulations.gov>.

(1) Rulemaking documents in proceedings started after February 1, 1997, including notices of proposed rulemaking, advance notices of proposed rulemaking, public comments, related FEDERAL REGISTER notices, final rules, appeals, and PHMSA's decisions in response to appeals.

§ 105.26

(2) Applications for special permits numbered DOT-E or DOT-SP 11832 and above. Also available are supporting data, memoranda of any informal meetings with applicants, related FEDERAL REGISTER notices, public comments, and decisions granting or denying applications for special permits.

(3) Applications for preemption determinations and waiver of preemption determinations received by PHMSA after February 1, 1997. Also available are public comments, FEDERAL REGISTER notices, and PHMSA's rulings, determinations, decisions on reconsideration, and orders issued in response to those applications.

(b) *Office of Pipeline and Hazardous Materials Safety Administration's Office of Hazardous Materials Safety.* (1) You may obtain documents (e.g., proposed and final rules, notices, letters of clarification, safety notices, DOT forms and other documents) by contacting the Hazardous Materials Information Center at 1-800-467-4922 or through the Internet at <http://www.phmsa.dot.gov>.

(2) Upon your written request, we will make the following documents and information available to you:

(i) Appeals under 49 CFR part 107 and PHMSA's decisions issued in response to those appeals.

(ii) Records of compliance order proceedings and PHMSA compliance orders.

(iii) Applications for approvals, including supporting data, memoranda of any informal meetings with applicants, and decisions granting or denying approvals applications.

(iv) Applications for special permits numbered below DOT-E or DOT-SP 11832 and related background information are available for public review and copying at the Office of Hazardous Materials Safety, Approvals and Permits Division, U.S. Department of Transportation, PHH-30, East Building, 1200 New Jersey Avenue, SE., Washington, DC 20590-0001.

(v) Other information about PHMSA's hazardous materials program required by statute to be made available to the public for review and copying and any other information PHMSA decides should be available to the public.

49 CFR Ch. I (10-1-14 Edition)

(3) Your written request to review documents should include the following:

(i) A detailed description of the documents you wish to review.

(ii) Your name, address, and telephone number.

(4) Send your written request to: Associate Administrator for Hazardous Materials Safety, Pipeline and Hazardous Materials Safety Administration, Attn: PHH-1, U.S. Department of Transportation, East Building, 1200 New Jersey Avenue, SE., Washington, DC 20590-0001.

[70 FR 56088, Sept. 23, 2005, as amended at 70 FR 73159, Dec. 9, 2005; 72 FR 55682, Oct. 1, 2007; 76 FR 56310, Sept. 13, 2011]

§ 105.26 Obtaining records on file with PHMSA.

To obtain records on file with PHMSA, other than those described in § 105.25, you must file a request with PHMSA under the Freedom of Information Act (FOIA) (5 U.S.C. 552). The procedures for filing a FOIA request are contained in 49 CFR part 7.

§ 105.30 Information made available to the public and request for confidential treatment.

When you submit information to PHMSA during a rulemaking proceeding, as part of your application for special permit or approval, or for any other reason, we may make that information publicly available unless you ask that we keep the information confidential.

(a) *Asking for confidential treatment.* You may ask us to give confidential treatment to information you give to the agency by taking the following steps:

(1) Mark "confidential" on each page of the original document you would like to keep confidential.

(2) Send us, along with the original document, a second copy of the original document with the confidential information deleted.

(3) Explain why the information you are submitting is confidential (for example, it is exempt from mandatory public disclosure under the Freedom of Information Act, 5 U.S.C. 552 or it is information referred to in 18 U.S.C. 1905).

(b) *PHMSA Decision*. PHMSA will decide whether or not to treat your information as confidential. We will notify you, in writing, of a decision to grant or deny confidentiality at least five days before the information is publicly disclosed, and give you an opportunity to respond.

[67 FR 42951, June 25, 2002, as amended at 70 FR 73159, Dec. 9, 2005]

SERVING DOCUMENTS

§ 105.35 Serving documents in PHMSA proceedings.

(a) *Service by PHMSA*. We may serve the document by one of the following methods, except where a different method of service is specifically required:

(1) Registered or certified mail.

(i) If we serve a document by registered or certified mail, it is considered served when mailed.

(ii) An official United States Postal Service receipt from the registered or certified mailing is proof of service.

(iii) We may serve a person's authorized representative or agent by registered or certified mail, or in any other manner authorized by law. Service on a person's authorized agent is the same as service on the person.

(2) Personal service.

(3) Publication in the FEDERAL REGISTER.

(4) Electronic service. (i) Service by electronic means if consented to in writing by the party to be served.

(ii) For all special permits and approvals actions, electronic service is authorized.

(b) *Service by others*. If you are required under this subchapter to serve a person with a document, serve the document by one of the following methods, except where a different method of service is specifically required:

(1) Registered or certified mail.

(i) If you serve a document by registered or certified mail, it is considered served when mailed.

(ii) An official United States Postal Service receipt from the registered or certified mailing is proof of service.

(iii) You may serve a person's authorized representative or agent by registered or certified mail or in any other manner authorized by law. Service on a

person's authorized agent is the same as service on the person.

(2) Personal service.

(3) Electronic service.

(i) In a proceeding under §107.317 of this subchapter (an administrative law judge proceeding), you may electronically serve documents on us.

(ii) Serve documents electronically through the Internet at <http://www.regulations.gov>.

[67 FR 42951, June 25, 2002, as amended at 72 FR 55682, Oct. 1, 2007; 76 FR 460, Jan. 5, 2011]

§ 105.40 Designated agents for non-residents.

(a) *General requirement*. If you are not a resident of the United States but are required by this subchapter or subchapter C of this chapter to designate a permanent resident of the United States to act as your agent and receive documents on your behalf, you must prepare a designation and file it with us.

(b) *Agents*. An agent, also known as "agent for service of process":

(1) May be an individual, a firm, or a domestic corporation.

(2) May represent any number of principals.

(3) May not reassign responsibilities under a designation to another person.

(c) *Preparing a designation*. Your designation must be written and dated, and it must contain the following information:

(1) The section in the HMR that requires you to file a designation.

(2) A certification that the designation is in the correct legal form required to make it valid and binding on you under the laws, corporate bylaws, and other requirements that apply to designations at the time and place you are making the designation.

(3) Your full legal name, the principal name of your business, and your mailing address.

(4) A statement that your designation will remain in effect until you withdraw or replace it.

(5) The legal name and mailing address of your agent.

(6) A declaration of acceptance signed by your agent.

(d) Each designation must be submitted to: Approvals and Permits Division, Pipeline and Hazardous Materials

§ 105.45

Safety Administration, Attn: PHH-30, U.S. Department of Transportation, East Building, 1200 New Jersey Avenue SE., Washington, DC 20590-0001 or by electronic mail to: *specialpermits@dot.gov* or *approvals@dot.gov* as appropriate.

(e) *Designations are binding.* You are bound by your designation of an agent, even if you did not follow all the requirements in this section, until we reject your designation.

[67 FR 42951, June 25, 2002, as amended at 70 FR 56088, Sept. 23, 2005; 70 FR 73159, Dec. 9, 2005; 72 FR 55682, Oct. 1, 2007; 75 FR 27211, May 14, 2010; 76 FR 56310, Sept. 13, 2011; 78 FR 15321, Mar. 11, 2013]

SUBPOENAS

§ 105.45 Issuing a subpoena.

(a) *Subpoenas explained.* A subpoena is a document that may require you to attend a proceeding, produce documents or other physical evidence in your possession or control, or both. PHMSA may issue a subpoena either on its initiative or at the request of someone participating in a proceeding. Anyone who requests that PHMSA issue a subpoena must show that the subpoena seeks information that will materially advance the proceeding.

(b) *Attendance and mileage expenses.*
(1) If you receive a subpoena to attend a proceeding under this part, you may receive money to cover attendance and mileage expenses. The attendance and mileage fees will be the same as those paid to a witness in a proceeding in the district courts of the United States.

(2) If PHMSA issues a subpoena to you based upon a request, the requester must serve a copy of the original subpoena on you, as required in §105.50. The requester must also include attendance and mileage fees with the subpoena unless the requester asks PHMSA to pay the attendance and mileage fees because of demonstrated financial hardship and PHMSA agrees to do so.

(3) If PHMSA issues a subpoena at the request of an officer or agency of the Federal government, the officer or agency is not required to include attendance and mileage fees when serving the subpoena. The officer or agency

49 CFR Ch. I (10–1–14 Edition)

must pay the fees before you leave the hearing at which you testify.

§ 105.50 Serving a subpoena.

(a) *Personal service.* Anyone who is not an interested party and who is at least 18 years of age may serve you with a subpoena and fees by handing the subpoena and fees to you, by leaving them at your office with the individual in charge, or by leaving them at your house with someone who lives there and is capable of making sure that you receive them. If PHMSA issues a subpoena to an entity, rather than an individual, personal service is made by delivering the subpoena and fees to the entity's registered agent for service of process or to any officer, director or agent in charge of any of the entity's offices.

(b) *Service by mail.* You may be served with a copy of a subpoena and fees by certified or registered mail at your last known address. Service of a subpoena and fees may also be made by registered or certified mail to your agent for service of process or any of your representatives at that person's last known address.

(c) *Other methods.* You may be served with a copy of a subpoena by any method where you receive actual notice of the subpoena and receive the fees before leaving the hearing at which you testify.

(d) *Filing after service.* After service is complete, the individual who served a copy of a subpoena and fees must file the original subpoena and a certificate of service with the PHMSA official who is responsible for conducting the hearing.

§ 105.55 Refusal to obey a subpoena.

(a) *Quashing or modifying a subpoena.* If you receive a subpoena, you can ask PHMSA to overturn ("quash") or modify the subpoena within 10 days after the subpoena is served on you. Your request must briefly explain the reasons you are asking for the subpoena to be quashed or modified. PHMSA may then do the following:

(1) Deny your request.

(2) Quash or modify the subpoena.

(3) Grant your request on the condition that you satisfy certain specified requirements.

(b) *Failure to obey.* If you disobey a subpoena, PHMSA may ask the Attorney General to seek help from the United States District Court for the appropriate District to compel you, after notice, to appear before PHMSA and give testimony, produce subpoenaed documents or physical evidence, or both.

PART 106—RULEMAKING PROCEDURES

Subpart A—PHMSA Rulemaking Documents

- Sec.
- 106.5 Defined terms used in this subpart.
- 106.10 Process for issuing rules.
- 106.15 Advance notice of proposed rulemaking.
- 106.20 Notice of proposed rulemaking.
- 106.25 Revising regulations without first issuing an ANPRM or NPRM.
- 106.30 Final rule.
- 106.35 Interim final rule.
- 106.40 Direct final rule.
- 106.45 Tracking rulemaking actions.

Subpart B—Participating in the Rulemaking Process

- 106.50 Defined terms used in this subpart.
- 106.55 Public participation in the rulemaking process.

WRITTEN COMMENTS

- 106.60 Filing comments.
- 106.65 Required information for written comments.
- 106.70 Where and when to file comments.
- 106.75 Extension of time to file comments.

PUBLIC MEETINGS AND OTHER PROCEEDINGS

- 106.80 Public meeting procedures.
- 106.85 Requesting a public meeting.
- 106.90 Other rulemaking proceedings.

PETITIONS FOR RULEMAKING

- 106.95 Requesting a change to the regulations.
- 106.100 Required information for a petition for rulemaking.
- 106.105 PHMSA response to a petition for rulemaking.

APPEALS

- 106.110 Appealing a PHMSA action.
- 106.115 Required information for an appeal.
- 106.120 Appeal deadline.
- 106.125 Filing an appeal.
- 106.130 PHMSA response to an appeal.

AUTHORITY: 49 U.S.C. 5101–5127; 49 CFR 1.53.

SOURCE: 67 FR 42954, June 25, 2002, unless otherwise noted.

EDITORIAL NOTE: Nomenclature changes to part 106 appear at 70 FR 56088, Sept. 23, 2005.

Subpart A—PHMSA Rulemaking Documents

§ 106.5 Defined terms used in this subpart.

The following defined terms (see part 105, subpart A, of this subchapter) appear in this subpart: File; Person; State.

§ 106.10 Process for issuing rules.

(a) PHMSA (“we”) uses informal rulemaking procedures under the Administrative Procedure Act (5 U.S.C. 553) to add, amend, or delete regulations. To propose or adopt changes to a regulation, PHMSA may issue one or more of the following documents. We publish the following rulemaking documents in the FEDERAL REGISTER unless we name and personally serve a copy of a rule on every person subject to it:

- (1) An advance notice of proposed rulemaking.
- (2) A notice of proposed rulemaking.
- (3) A final rule.
- (4) An interim final rule.
- (5) A direct final rule.

(b) Each of the rulemaking documents in paragraph (a) of this section generally contains the following information:

- (1) The topic involved in the rulemaking document.
- (2) PHMSA’s legal authority for issuing the rulemaking document.
- (3) How interested persons may participate in the rulemaking proceeding (for example, by filing written comments or making oral presentations).
- (4) Whom to call if you have questions about the rulemaking document.
- (5) The date, time, and place of any public meetings being held to discuss the rulemaking document.
- (6) The docket number and regulation identifier number (RIN) for the rulemaking proceeding.

[67 FR 42954, June 25, 2002, as amended at 70 FR 56088, Sept. 23, 2005]

§ 106.15

§ 106.15 Advance notice of proposed rulemaking.

An advance notice of proposed rulemaking (ANPRM) tells the public that PHMSA is considering an area for rulemaking and requests written comments on the appropriate scope of the rulemaking or on specific topics. An advance notice of proposed rulemaking may or may not include the text of potential changes to a regulation.

§ 106.20 Notice of proposed rulemaking.

A notice of proposed rulemaking (NPRM) contains PHMSA's specific proposed regulatory changes for public comment and contains supporting information. It generally includes proposed regulatory text.

§ 106.25 Revising regulations without first issuing an ANPRM or NPRM.

PHMSA may add, amend, or delete regulations without first issuing an ANPRM or NPRM in the following situations:

(a) We may go directly to a final rule or interim final rule if, for good cause, we find that a notice of proposed rulemaking is impracticable, unnecessary, or contrary to the public interest. We must place that finding and a brief statement of the reasons for it in the final rule or interim final rule.

(b) We may issue a direct final rule (see § 106.40).

§ 106.30 Final rule.

A final rule sets out new regulatory requirements and their effective date. A final rule will also identify issues raised by commenters in response to the notice of proposed rulemaking and give the agency's response.

§ 106.35 Interim final rule.

An interim final rule is issued without first issuing a notice of proposed rulemaking and accepting public comments and sets out new regulatory requirements and their effective date. PHMSA may issue an interim final rule if it finds, for good cause, that notice and public procedure are impracticable, unnecessary, or contrary to the public interest. PHMSA will clearly set out this finding in the interim final rule. After receiving and reviewing

49 CFR Ch. I (10–1–14 Edition)

public comments, as well as any other relevant documents, PHMSA may revise the interim final rule and then issue a final rule.

§ 106.40 Direct final rule.

A direct final rule makes regulatory changes and states that the regulatory changes will take effect on a specified date unless PHMSA receives an adverse comment or notice of intent to file an adverse comment within the comment period—generally 60 days after the direct final rule is published in the FEDERAL REGISTER.

(a) *Actions taken by direct final rule.* We may use direct final rulemaking procedures to issue rules that do any of the following:

(1) Make minor substantive changes to regulations.

(2) Incorporate by reference the latest edition of technical or industry standards.

(3) Extend compliance dates.

(4) Make noncontroversial changes to regulations. We must determine and publish a finding that use of direct final rulemaking, in this situation, is in the public interest and unlikely to result in adverse comment.

(b) *Adverse comment.* An adverse comment explains why a rule would be inappropriate, or would be ineffective or unacceptable without a change. It may challenge the rule's underlying premise or approach. Under the direct final rule process, we do not consider the following types of comments to be adverse:

(1) A comment recommending another rule change, in addition to the change in the direct final rule at issue, unless the commenter states why the direct final rule would be ineffective without the change.

(2) A frivolous or irrelevant comment.

(c) *Confirmation of effective date.* We will publish a confirmation document in the FEDERAL REGISTER, generally within 15 days after the comment period closes, if we have not received an adverse comment or notice of intent to file an adverse comment. The confirmation document tells the public the effective date of the rule—either the date stated in the direct final rule or at least 30 days after the publication

date of the confirmation document, whichever is later.

(d) *Withdrawing a direct final rule.* (1) If we receive an adverse comment or notice of intent to file an adverse comment, we will publish a document in the FEDERAL REGISTER before the effective date of the direct final rule advising the public and withdrawing the direct final rule in whole or in part.

(2) If we withdraw a direct final rule because of an adverse comment, we may incorporate the adverse comment into a later direct final rule or may publish a notice of proposed rulemaking.

(e) *Appeal.* You may appeal PHMSA's issuance of a direct final rule (see §106.115) only if you have previously filed written comments (see §106.60) to the direct final rule.

§ 106.45 Tracking rulemaking actions.

The following identifying numbers allow you to track PHMSA's rulemaking activities:

(a) *Docket number.* We assign an identifying number, called a docket number, to each rulemaking proceeding. Each rulemaking document that PHMSA issues in a particular rulemaking proceeding will display the same docket number. This number allows you to do the following:

(1) Associate related documents that appear in the FEDERAL REGISTER.

(2) Search the DOT Docket Management System ("DMS") for information on particular rulemaking proceedings—including notices of proposed rulemaking, public comments, petitions for rulemaking, appeals, records of additional rulemaking proceedings and final rules. There are two ways you can search the DMS:

(i) Visit the public docket room and review and copy any docketed materials during regular business hours. The DOT Docket Management System is located at the U.S. Department of Transportation, West Building Ground Floor, Room W12-140, 1200 New Jersey Avenue, SE., Washington, DC 20590-0001.

(ii) View and download docketed materials through the Internet at <http://www.regulations.gov>.

(b) *Regulation identifier number.* The Department of Transportation pub-

lishes a semiannual agenda of all current and projected Department of Transportation rulemakings, reviews of existing regulations, and completed actions. This semiannual agenda appears in the Unified Agenda of Federal Regulations that is published in the FEDERAL REGISTER in April and October of each year. The semiannual agenda tells the public about the Department's—including PHMSA's—regulatory activities. The Department assigns a regulation identifier number (RIN) to each individual rulemaking proceeding in the semiannual agenda. This number appears on all rulemaking documents published in the FEDERAL REGISTER and makes it easy for you to track those rulemaking proceedings in both the FEDERAL REGISTER and the semiannual regulatory agenda itself, as well as to locate all documents in the Docket Management System pertaining to a particular rulemaking.

[70 FR 56088, Sept. 23, 2005, as amended at 72 FR 55682, Oct. 1, 2007]

Subpart B—Participating in the Rulemaking Process

§ 106.50 Defined terms used in this subpart.

The following defined terms (see part 105, subpart A, of this subchapter) appear in this subpart: File; Person; Political subdivision; State.

§ 106.55 Public participation in the rulemaking process.

You may participate in PHMSA's rulemaking process by doing any of the following:

(a) File written comments on any rulemaking document that asks for comments, including an advance notice of proposed rulemaking, notice of proposed rulemaking, interim final rule, or direct final rule.

(b) Ask that we hold a public meeting in any rulemaking proceeding and participate in any public meeting that we hold.

(c) File a petition for rulemaking that asks us to add, amend, or delete a regulation.

(d) File an appeal that asks us to re-examine our decision to issue all or part of a final rule, interim final rule, or direct final rule.

§ 106.60

WRITTEN COMMENTS

§ 106.60 Filing comments.

Anyone may file written comments about proposals made in any rulemaking document that requests public comments, including any State government agency, any political subdivision of a State, and any interested person invited by PHMSA to participate in the rulemaking process.

§ 106.65 Required information for written comments.

Your comments must be in English and must contain the following:

(a) The docket number of the rulemaking document you are commenting on, clearly set out at the beginning of your comments.

(b) Information, views, or arguments that follow the instructions for participation that appear in the rulemaking document on which you are commenting.

(c) All material that is relevant to any statement of fact in your comments.

(d) The document title and page number of any material that you reference in your comments.

§ 106.70 Where and when to file comments.

(a) Unless you are told to do otherwise in the rulemaking document on which you are commenting, send your comments to us in either of the following ways:

(1) By mail to: Docket Management System, U.S. Department of Transportation, West Building Ground Floor, Room W12-140, 1200 New Jersey Avenue, SE., Washington, DC 20590-0001.

(2) Through the Internet at <http://www.regulations.gov>.

(b) Make sure that your comments reach us by the deadline set out in the rulemaking document on which you are commenting. We will consider late filed comments to the extent possible.

(c) We may reject comments that are not relevant to the rulemaking. We may reject comments you file electronically if you do not follow the elec-

49 CFR Ch. I (10-1-14 Edition)

tronic filing instructions at the DOT Web site.

[67 FR 42954, June 25, 2002, as amended at 69 FR 54044, Sept. 7, 2004; 72 FR 55682, Oct. 1, 2007]

§ 106.75 Extension of time to file comments.

You may ask for more time to file comments on a rulemaking proceeding. If PHMSA grants your request, it is granted to all persons. We will notify the public of the extension by publishing a document in the FEDERAL REGISTER. If PHMSA denies your request, PHMSA will notify you of the denial. To ask for more time, you must do the following:

(a) File a request for extension at least ten days before the end of the comment period established in the rulemaking document.

(b) Show that you have good cause for the extension and that an extension is in the public interest.

(c) Include the docket number of the rulemaking document you are seeking additional time to comment on, clearly set out at the beginning of your request.

(d) Send your request to: Docket Management System, U.S. Department of Transportation, West Building Ground Floor, Room W12-140, 1200 New Jersey Avenue, SE., Washington, DC 20590-0001.

[67 FR 42954, June 25, 2002, as amended at 72 FR 55682, Oct. 1, 2007]

PUBLIC MEETINGS AND OTHER PROCEEDINGS

§ 106.80 Public meeting procedures.

A public meeting is a non-adversarial, fact-finding proceeding conducted by a PHMSA representative. Generally, public meetings are announced in the FEDERAL REGISTER. Interested persons are invited to attend and to present their views to the agency on specific issues. There are no formal pleadings and no adverse parties, and any regulation issued afterward is not necessarily based exclusively on the record of the meeting. Sections 556 and 557 of the Administrative Procedure Act (5 U.S.C. 556 and 557) do not apply to public meetings under this part.

§ 106.85 Requesting a public meeting.

(a) You may ask for a public meeting by filing a written request with PHMSA no later than 20 days before the expiration of the comment period specified in the rulemaking document. Send your request for a public meeting to: Docket Management System, U.S. Department of Transportation, West Building Ground Floor, Room W12-140, 1200 New Jersey Avenue, SE., Washington, DC 20590-0001.

(b) PHMSA will review your request and, if you have shown good cause for a public meeting, we will grant it and publish a notice of the meeting in the FEDERAL REGISTER.

[67 FR 42954, June 25, 2002, as amended at 72 FR 55682, Oct. 1, 2007]

§ 106.90 Other rulemaking proceedings.

During a rulemaking proceeding, PHMSA may invite you to do the following:

(a) Participate in a conference at which minutes are taken.

(b) Make an oral presentation.

(c) Participate in any other public proceeding to ensure that PHMSA makes informed decisions during the rulemaking process and to protect the public interest, including a negotiated rulemaking or work group led by a facilitator.

PETITIONS FOR RULEMAKING

§ 106.95 Requesting a change to the regulations.

You may ask PHMSA to add, amend, or delete a regulation by filing a petition for rulemaking as follows:

(a) For regulations in 49 CFR parts 110, 130, 171 through 180, submit the petition to: Standards and Rulemaking Division, Pipeline and Hazardous Materials Safety Administration, Attn: PHH-10, U.S. Department of Transportation, East Building, 1200 New Jersey Avenue, SE., Washington, DC 20590-0001.

(b) For regulations in 49 CFR parts 105, 106, or 107, submit the petition to: Office of the Chief Counsel, Pipeline and Hazardous Materials Safety Administration, Attn: PHC-10, U.S. Department of Transportation, East

Building, 1200 New Jersey Avenue, SE., Washington, DC 20590-0001.

[70 FR 56089, Sept. 23, 2005, as amended at 72 FR 55683, Oct. 1, 2007; 76 FR 56310, Sept. 13, 2011]

§ 106.100 Required information for a petition for rulemaking.

(a) You must include the following information in your petition for rulemaking:

(1) A summary of your proposed action and an explanation of its purpose.

(2) The language you propose for a new or amended rule, or the language you would delete from a current rule.

(3) An explanation of your interest in your proposed action and the interest of anyone you may represent.

(4) Information and arguments that support your proposed action, including relevant technical and scientific data available to you.

(5) Any specific cases that support or demonstrate the need for your proposed action.

(b) If the impact of your proposed action is substantial, and data or other information about that impact are available to you, we may ask that you provide information about the following:

(1) The costs and benefits of your proposed action to society in general, and identifiable groups within society in particular.

(2) The direct effects, including preemption effects under section 5125 of Federal hazardous materials transportation law, of your proposed action on States, on the relationship between the Federal government and the States, and on the distribution of power and responsibilities among the various levels of government. (See 49 CFR part 107, subpart C, regarding preemption.)

(3) The regulatory burden of your proposed action on small businesses, small organizations, small governmental jurisdictions, and Indian tribes.

(4) The recordkeeping and reporting burdens of your proposed action and whom they would affect.

(5) The effect of your proposed action on the quality of the natural and social environments.

§ 106.105

§ 106.105 PHMSA response to a petition for rulemaking.

We will review and respond to your petition for rulemaking as follows:

If your petition is . . .	And if we determine that . . .	Then . . .
(a) Incomplete	We may return your petition with a written explanation.
(b) Complete ..	Your petition does not justify a rule-making action.	We will notify you in writing that we will not start a rule-making proceeding.
(c) Complete ..	Your petition does justify a rule-making action.	We will notify you in writing that we will start a rulemaking proceeding.

APPEALS

§ 106.110 Appealing a PHMSA Action.

You may appeal the following PHMSA actions:

(a) PHMSA’s issuance of a final rule or PHMSA’s withdrawal of a notice of proposed rulemaking under the rule-making procedures in this part. However, you may appeal PHMSA’s issuance of a direct final rule only if you previously filed comments to the direct final rule (see § 106.40(e)).

(b) Any PHMSA decision on a petition for rulemaking.

§ 106.115 Required information for an appeal.

(a) *Appeal of a final rule or withdrawal of a notice of proposed rulemaking.* If you appeal PHMSA’s issuance of a final rule or PHMSA’s withdrawal of a notice of proposed rulemaking, your appeal must include the following:

(1) The docket number of the rule-making you are concerned about, clearly set out at the beginning of your appeal.

(2) A brief statement of your concern about the final rule or the withdrawal of notice of proposed rulemaking at issue.

(3) An explanation of why compliance with the final rule is not practical, reasonable, or in the public interest.

(4) If you want PHMSA to consider more facts, the reason why you did not present those facts within the time given during the rulemaking process for public comment.

(b) *Appeal of a decision.* If you appeal PHMSA’s decision on a petition for rulemaking, you must include the following:

(1) The contested aspects of the decision.

(2) Any new arguments or information.

§ 106.120 Appeal deadline.

(a) *Appeal of a final rule or withdrawal of a notice of proposed rulemaking.* If you appeal PHMSA’s issuance of a final rule or PHMSA’s withdrawal of a proposed rulemaking, your appeal document must reach us no later than 30 days after the date PHMSA published the regulation or the withdrawal notice in the FEDERAL REGISTER. After that time, PHMSA will consider your appeal to be a petition for rulemaking under § 106.100.

(b) *Appeal of a decision.* If you appeal PHMSA’s decision on a petition for rulemaking, your appeal document must reach us no later than 30 days from the date PHMSA served you with written notice of PHMSA’s decision.

[70 FR 56089, Sept. 23, 2005]

§ 106.125 Filing an appeal.

Send your appeal to: Docket Management System, U.S. Department of Transportation, West Building Ground Floor, Room W12-140, 1200 New Jersey Avenue, SE., Washington, DC 20590-0001.

[67 FR 42954, June 25, 2002, as amended at 72 FR 55682, Oct. 1, 2007]

§ 106.130 PHMSA response to an appeal.

Unless PHMSA provides otherwise, filing an appeal will not keep a final rule from becoming effective. We will handle an appeal according to the following procedures:

(a) *Appeal of a final rule or withdrawal of a notice of proposed rulemaking.* (1) We may consolidate your appeal with other appeals of the same rule.

(2) We may grant or deny your appeal, in whole or in part, without further rulemaking proceedings, unless granting your appeal would result in the issuance of a new final rule.

(3) If we decide to grant your appeal, we may schedule further proceedings and an opportunity to comment.

(4) PHMSA will notify you, in writing, of the action on your appeal within 90 days after the date that PHMSA published the final rule or withdrawal of notice of proposed rulemaking at issue in the FEDERAL REGISTER. If we do not issue a decision on your appeal within the 90-day period and we anticipate a substantial delay, we will notify you directly about the delay and will give you an expected decision date. We will also publish a notice of the delay in the FEDERAL REGISTER.

(b) *Appeal of a decision.* (1) We will not consider your appeal if it merely repeats arguments that PHMSA has previously rejected.

(2) PHMSA will notify you, in writing, of the action on your appeal within 90 days after the date that PHMSA served you with written notice of its decision on your petition for rulemaking. If we do not issue a decision on your appeal within the 90-day period, and we anticipate a substantial delay, we will notify you directly about the delay and will give you an expected decision date.

PART 107—HAZARDOUS MATERIALS PROGRAM PROCEDURES

Subpart A—Definitions

Sec.

107.1 Definitions.

Subpart B—Special Permits

- 107.101 Purpose and scope.
- 107.105 Application for special permit.
- 107.107 Application for party status.
- 107.109 Application for renewal.
- 107.111 Withdrawal.
- 107.113 Application processing and evaluation.
- 107.117 Emergency processing.
- 107.121 Modification, suspension or termination of special permit or grant of party status.
- 107.123 Reconsideration.
- 107.125 Appeal.
- 107.127 Availability of documents for public inspection.

Subpart C—Preemption

- 107.201 Purpose and scope.
- 107.202 Standards for determining preemption.

PREEMPTION DETERMINATIONS

- 107.203 Application.
- 107.205 Notice.
- 107.207 Processing.
- 107.209 Determination.
- 107.211 Petition for reconsideration.
- 107.213 Judicial review.

WAIVER OF PREEMPTION DETERMINATIONS

- 107.215 Application.
- 107.217 Notice.
- 107.219 Processing.
- 107.221 Determination.
- 107.223 Petition for reconsideration.
- 107.227 Judicial review.

Subpart D—Enforcement

- 107.301 Delegated authority for enforcement.
- 107.303 Purpose and scope.
- 107.305 Investigations.

COMPLIANCE ORDERS AND CIVIL PENALTIES

- 107.307 General.
- 107.309 Warning letters.
- 107.310 Ticketing.
- 107.311 Notice of probable violation.
- 107.313 Reply.
- 107.315 Admission of violations.
- 107.317 Informal response.
- 107.319 Request for a hearing.
- 107.321 Hearing.
- 107.323 ALJ's decision.
- 107.325 Appeals.
- 107.327 Compromise and settlement.
- 107.329 Maximum penalties.
- 107.331 Assessment considerations.

CRIMINAL PENALTIES

- 107.333 Criminal penalties generally.
- 107.335 Referral for prosecution.
- 107.336 Limitation on fines and penalties.

INJUNCTIVE ACTION

- 107.337 Injunctions generally.
- 107.338 Prohibition of hazardous materials operations.
- 107.339 Imminent hazards.

APPENDIX A TO SUBPART D OF PART 107—GUIDELINES FOR CIVIL PENALTIES

Subpart E—Designation of Approval and Certification Agencies

- 107.401 Purpose and scope.
- 107.402 Application for designation as an approval or certification agency.
- 107.403 Designation of certification agencies.
- 107.404 Conditions of designation.

§ 107.1

107.405 [Reserved]

Subpart F—Registration of Cargo Tank and Cargo Tank Motor Vehicle Manufacturers, Assemblers, Repairers, Inspectors, Testers, and Design Certifying Engineers

- 107.501 Scope.
- 107.502 General registration requirements.
- 107.503 Registration statement.
- 107.504 Period of registration, updates, and record retention.

Subpart G—Registration of Persons Who Offer or Transport Hazardous Materials

- 107.601 Applicability.
- 107.606 Exceptions.
- 107.608 General registration requirements.
- 107.612 Amount of fee.
- 107.616 Payment procedures.
- 107.620 Recordkeeping requirements.

Subpart H—Approvals, Registrations and Submissions

- 107.701 Purpose and scope.
- 107.705 Registrations, reports, and applications for approval.
- 107.709 Processing of an application for approval, including an application for renewal or modification.
- 107.711 Withdrawal.
- 107.713 Approval modification, suspension or termination.
- 107.715 Reconsideration.
- 107.717 Appeal.

Subpart I—Approval of Independent Inspection Agencies, Cylinder Requalifiers, and Non-domestic Chemical Analyses and Tests of DOT Specification Cylinders

- 107.801 Purpose and scope.
- 107.803 Approval of an independent inspection agency (IIA).
- 107.805 Approval of cylinder and pressure receptacle requalifiers.
- 107.807 Approval of non-domestic chemical analyses and tests.
- 107.809 Conditions of UN pressure receptacle approvals.

AUTHORITY: 49 U.S.C. 5101–5128, 44701; Pub. L. 101–410 section 4 (28 U.S.C. 2461 note); Pub. L. 104–121 sections 212–213; Pub. L. 104–134 section 31001; Pub. L. 112–141 section 33006; 49 CFR 1.81 and 1.97.

EDITORIAL NOTE: Nomenclature changes to part 107 appear at 67 FR 61011, Sept. 27, 2002, 70 FR 56089, Sept. 23, 2005, and 70 FR 73159, Dec. 9, 2005.

49 CFR Ch. I (10–1–14 Edition)

Subpart A—Definitions

§ 107.1 Definitions.

All terms defined in 49 U.S.C. 5102 are used in their statutory meaning. Other terms used in this part are defined as follows:

Acting knowingly means acting or failing to act while

(1) Having actual knowledge of the facts giving rise to the violation, or

(2) Having the knowledge that a reasonable person acting in the same circumstances and exercising due care would have had.

Administrator means the Administrator, Pipeline and Hazardous Materials Safety Administration or his or her delegate.

Applicant means the person in whose name a special permit, approval, registration, a renewed or modified special permit or approval, or party status to a special permit is requested to be issued.

Application means a request under subpart B of this part for a special permit, a renewal or modification of a special permit, party status to a special permit, or a request under subpart H of this part for an approval, or renewal or modification of an approval.

Approval means written consent, including a competent authority approval, from the Associate Administrator or other designated Department official, to perform a function that requires prior consent under subchapter C of this chapter (49 CFR parts 171 through 180).

Approval Agency means an organization or a person designated by the PHMSA to certify packagings as having been designed, manufactured, tested, modified, marked or maintained in compliance with applicable DOT regulations.

Associate Administrator means the Associate Administrator for Hazardous Materials Safety, Pipeline and Hazardous Materials Safety Administration.

Competent Authority means a national agency that is responsible, under its national law, for the control or regulation of some aspect of hazardous materials (dangerous goods) transportation. Another term for Competent Authority is “Appropriate authority,” which is

used in the International Civil Aviation Organization's (ICAO) Technical Instructions for the Safe Transport of Dangerous Goods by Air. The Associate Administrator is the United States Competent Authority for purposes of this part 107.

Competent Authority Approval means an approval by the competent authority that is required under an international standard (for example, the ICAO Technical Instructions for the Safe Transport of Dangerous Goods by Air and the International Maritime Dangerous Goods Code). Any of the following may be considered a competent authority approval if it satisfies the requirement of an international standard:

- (1) A specific regulation in subchapter A or C of this chapter.
- (2) A special permit or approval issued under subchapter A or C of this chapter.
- (3) A separate document issued to one or more persons by the Associate Administrator.

DOT or Department means U.S. Department of Transportation.

Federal hazardous material transportation law means 49 U.S.C. 5101 *et seq.*

Filed means received by the appropriate PHMSA or other designated office within the time specified in a regulation or rulemaking document.

Holder means the person in whose name a special permit or approval has been issued.

Imminent Hazard means the existence of a condition which presents a substantial likelihood that death, serious illness, severe personal injury, or substantial endangerment to health, property, or the environment may occur before the reasonably foreseeable completion of an administrative hearing or other formal proceeding initiated to abate the risks of those effects.

Incident means an event resulting in the unintended and unanticipated release of a hazardous material or an event meeting incident reporting requirements in §171.15 or §171.16 of this chapter.

Indian Tribe has the same meaning given that term in section 4 of the Indian Self-Determination and Education Assistance Act (25 U.S.C. 450b).

Investigation includes investigations authorized under 49 U.S.C. 5121 and inspections authorized under 49 U.S.C. 5118 and 5121.

Manufacturing special permit means a special permit from compliance with specified requirements that otherwise must be met before representing, marking, certifying (including requalifying, inspecting, and testing), selling or offering a packaging or container as meeting the requirements of subchapter C of this chapter governing its use in the transportation in commerce of a hazardous material. A manufacturing special permit is a special permit issued to a manufacturer of packagings who does not offer for transportation or transport hazardous materials in packagings subject to the special permit.

Party means a person, other than a holder, authorized to act under the terms of a special permit.

Person means an individual, firm, co-partnership, corporation, company, association, or joint-stock association (including any trustee, receiver, assignee, or similar representative); or a government or Indian tribe (or an agency or instrumentality of any government or Indian tribe) that transports a hazardous material to further a commercial enterprise or offers a hazardous material for transportation in commerce. Person does not include the following:

- (1) The United States Postal Service.
- (2) Any agency or instrumentality of the Federal government, for the purposes of 49 U.S.C. 5123 (civil penalties) and 5124 (criminal penalties.)
- (3) Any government or Indian tribe (or an agency or instrumentality of any government or Indian tribe) that transports hazardous material for a governmental purpose.

Registration means a written acknowledgment from the Associate Administrator that a registrant is authorized to perform a function for which registration is required under subchapter C of this chapter (e.g., registration in accordance with 49 CFR 178.503 regarding marking of packagings). For purposes of subparts A through E, "registration" does not include registration under subpart F or G of this part.

Report means information, other than an application, registration or part thereof, required to be submitted to the Associate Administrator pursuant to this subchapter, subchapter B or subchapter C of this chapter.

Respondent means a person upon whom the PHMSA has served a notice of probable violation.

Special permit means a document issued by the Associate Administrator, or other designated Department official, under the authority of 49 U.S.C. 5117 permitting a person to perform a function that is not otherwise permitted under subchapters A or C of this chapter, or other regulations issued under 49 U.S.C. 5101 *et seq.* (e.g., Federal Motor Carrier Safety routing requirements).

State means a State of the United States, the District of Columbia, the Commonwealth of Puerto Rico, the Commonwealth of the Northern Mariana Islands, the Virgin Islands, American Samoa, Guam, or any other territory or possession of the United States designated by the Secretary.

Transports or *transportation* means the movement of property and loading, unloading, or storage incidental to the movement.

[Amdt. 107–3, 41 FR 38170, Sept. 9, 1976]

EDITORIAL NOTE: For FEDERAL REGISTER citations affecting §107.1, see the List of CFR Sections Affected, which appears in the Finding Aids section of the printed volume and at www.fdsys.gov.

Subpart B—Special Permits

SOURCE: Amdt. 107–38, 61 FR 21095, May 9, 1996, unless otherwise noted.

§ 107.101 Purpose and scope.

This subpart prescribes procedures for the issuance, modification and termination of special permits from requirements of this subchapter, subchapter C of this chapter, or regulations issued under chapter 51 of 49 U.S.C.

§ 107.105 Application for special permit.

(a) *General.* Each application for a special permit or modification of a special permit and all supporting docu-

ments must be written in English and submitted for timely consideration at least 120 days before the requested effective date and conform to the following requirements:

(1) The application, including a table of contents, must:

(i) Be submitted to the Associate Administrator for Hazardous Materials Safety (Attention: General Approvals and Permits, PHH-31), Pipeline and Hazardous Materials Safety Administration, U.S. Department of Transportation, East Building, 1200 New Jersey Avenue, SE., Washington, DC 20590-0001;

(ii) Be submitted with any attached supporting documentation by facsimile (fax) to: (202) 366-3753 or (202) 366-3308;

(iii) Be submitted electronically by e-mail to: specialpermits@dot.gov; or

(iv) Be submitted using PHMSA's online system (table of contents omitted) at: <http://www.phmsa.dot.gov/hazmat/regs/sp-a>.

(2) The application must state the name, mailing address, physical address(es) of all known locations where the special permit would be used, e-mail address (if available), and telephone number of the applicant. If the applicant is not an individual, the application must state the company name, mailing address, physical address(es) of all known locations where the special permit would be used, e-mail address (if available), and telephone number of an individual designated as the point of contact for the applicant for all purposes related to the application, the name of the company Chief Executive Officer (CEO) or president, or ranking officer; and the Dun and Bradstreet Data Universal Numbering System (D-U-N-S) identifier.

(3) If the applicant is not a resident of the United States, in addition to the information listed in paragraph (a)(2) of this section, the application must identify and designate an agent that is a permanent resident of the United States for service in accordance with § 105.40 of this part.

(4) For a manufacturing special permit, in addition to the information listed in paragraph (a)(2) of this section, the application must state the name and street address of each of the

facilities of the applicant where manufacturing under the special permit will occur, and the symbol of the packaging manufacturer ("M" number), if applicable.

(5) For persons required to be registered in accordance with Subpart F or G of this part, in addition to the information listed in paragraph (a)(2) of this section, the application must provide the registration number or the name of the company to which the registration number is assigned if different from the applicant. For persons not required to be registered in accordance with Subpart F or G of this part, in addition to the information listed in paragraph (a)(2) of this section, the application must provide a statement indicating that registration is not required.

(b) *Confidential treatment.* To request confidential treatment for information contained in the application, the applicant must comply with §105.30(a).

(c) *Description of special permit proposal.* The application must include the following information that is relevant to the special permit proposal:

(1) A citation of the specific regulation from which the applicant seeks relief;

(2) The proposed mode or modes of transportation, including a description of all operational controls required;

(3) A detailed description of the proposed special permit (*e.g.*, alternative packaging, test, procedure, activity, or hazard communication, including marking and labeling requirements) including, as appropriate, written descriptions, drawings, flow charts, plans and other supporting documents;

(4) A specification of the proposed duration or schedule of events for which the special permit is sought;

(5) A statement outlining the applicant's basis for seeking relief from compliance with the specified regulations and, if the special permit is requested for a fixed period, a description of how compliance will be achieved at the end of that period. For transportation by air, a statement outlining the reason(s) the hazardous material is being transported by air if other modes are available;

(6) If the applicant seeks emergency processing specified in §107.117, a statement of supporting facts and reasons;

(7) Identification and description, including an estimated quantity of each shipment of the hazardous materials planned for transportation under the special permit or;

(8) Description of each packaging, including specification or special permit number, as applicable, to be used in conjunction with the requested special permit;

(9) For alternative packagings, documentation of quality assurance controls, package design, manufacture, performance test criteria, in-service performance and service-life limitations;

(10) An estimate of the number of operations expected to be conducted or number of shipments to be transported under the special permit;

(11) An estimate of the number of packagings expected to be manufactured under the special permit, if applicable;

(12) A statement as to whether the special permit being sought is related to a compliance review, inspection activity, or enforcement action; and

(13) When a Class 1 material is forbidden for transportation by aircraft except under a special permit (*see* Columns 9A and 9B in the table in 49 CFR 172.101), a certification from an applicant for a special permit to transport such Class 1 material on passenger-carrying or cargo-only aircraft with a maximum certificated takeoff weight of less than 12,500 pounds that no person within the categories listed in 18 U.S.C. 842(i) will participate in the transportation of the Class 1 material.

(14) A statement indicating whether the applicant will be acting as a shipper (offeror), carrier or both under the terms of the special permit.

(d) *Justification of special permit proposal.* The application must demonstrate that a special permit achieves a level of safety at least equal to that required by regulation, or if a required safety level does not exist, is consistent with the public interest. At a minimum, the application must provide the following:

(1) Information describing all relevant shipping and incident experience

§ 107.107

49 CFR Ch. I (10–1–14 Edition)

of which the applicant is aware that relates to the application; and

(2) A statement identifying any increased risk to safety or property that may result if the special permit is granted, and a description of the measures to be taken to address that risk; and

(3) Either:

(i) Substantiation, with applicable analyses, data or test results (*e.g.*, failure mode and effect analysis), that the proposed alternative will achieve a level of safety that is at least equal to that required by the regulation from which the special permit is sought; or

(ii) If the regulations do not establish a level of safety, an analysis that identifies each hazard, potential failure mode and the probability of its occurrence, and how the risks associated with each hazard and failure mode are controlled for the duration of an activity or life-cycle of a packaging.

[76 FR 460, Jan. 5, 2011, as amended at 76 FR 44500, July 26, 2011; 76 FR 43524, July 20, 2011; 76 FR 56310, Sept. 13, 2011]

§ 107.107 Application for party status.

(a) Any person eligible to apply for a special permit may apply to be a party to an application or an existing special permit, other than a manufacturing special permit.

(b) Each application filed under this section must conform to the following requirements:—

(1) The application must:

(i) Be submitted to the Associate Administrator for Hazardous Materials Safety (Attention: General Approvals and Permits, PHH-31), Pipeline and Hazardous Materials Safety Administration, U.S. Department of Transportation, East Building, 1200 New Jersey Avenue, SE., Washington, DC 20590-0001;

(ii) Be submitted with any attached supporting documentation by facsimile (fax) to: (202) 366-3753 or (202) 366-3308; or

(iii) Be submitted by electronically by e-mail to: specialpermits@dot.gov, or on-line at: <http://www.phmsa.dot.gov/hazmat/regs/sp-a>.

(2) The application must identify by number the special permit application or special permit to which the applicant seeks to become a party.

(3) The application must state the name, mailing address, physical address(es) of all known locations where the special permit would be used, e-mail address (if available), and telephone number of the applicant. If the applicant is not an individual, the application must state the company name, mailing address, physical address(es) of all known locations where the special permit would be used, e-mail address (if available), and telephone number of an individual designated as the point of contact for the applicant for all purposes related to the application, the name of the company Chief Executive Officer (CEO), president, or ranking executive officer and the Dun and Bradstreet Data Universal Numbering System (D-U-N-S) identifier. In addition, each applicant must state why party status to the special permit is needed and must submit a certification of understanding of the provisions of the special permit to which party status is being requested.

(4) If the applicant is not a resident of the United States, the application must identify and designate an agent that is a permanent resident of the United States for service in accordance with § 105.40 of part.

(5) For a Class 1 material that is forbidden for transportation by aircraft except under a special permit (*see* Columns 9A and 9B in the table in 49 CFR 172.101), a certification from an applicant for party status to a special permit to transport such Class 1 material on passenger-carrying or cargo-only aircraft with a maximum certificated takeoff weight of less than 12,500 pounds that no person within the categories listed in 18 U.S.C. 842(i) will participate in the transportation of the Class 1 material.

(6) The applicant must certify that the applicant has not previously been granted party status to the special permit. If the applicant has previously been granted party status, the applicant must follow renewal procedures as specified in § 107.109.

(7) A statement indicating whether the applicant will be acting as a shipper (offeror), carrier or both under the terms of the special permit.

(c) The Associate Administrator may grant or deny an application for party

status in the manner specified in §107.113(e) and (f) of this subpart.

(d) A party to a special permit is subject to all terms of that special permit, including the expiration date. If a party to a special permit wishes to renew party status, the special permit renewal procedures set forth in §107.109 apply.

[76 FR 461, Jan. 5, 2011, as amended at 76 FR 44500, July 26, 2011; 76 FR 43524, July 20, 2011; 76 FR 56310, Sept. 13, 2011]

§ 107.109 Application for renewal.

(a) Each application for renewal of a special permit or party status to a special permit must conform to the following requirements:

(1) The application must:

(i) Be submitted to the Associate Administrator for Hazardous Materials Safety (Attention: General Approvals and Permits, PHH-31), Pipeline and Hazardous Materials Safety Administration, U.S. Department of Transportation, East Building, 1200 New Jersey Avenue, SE., Washington, DC 20590-0001;

(ii) Be submitted with any attached supporting documentation submitted in an appropriate format by facsimile (fax) to: (202) 366-3753 or (202) 366-3308; or

(iii) Be submitted electronically by e-mail to: specialpermits@dot.gov; or online at: <http://www.phmsa.dot.gov/hazmat/regs/sp-a>.

(2) The application must identify by number the special permit for which renewal is requested.

(3) The application must state the name, mailing address, physical address(es) of all known new locations not previously identified in the application where the special permit would be used and all locations not previously identified where the special permit was used, e-mail address (if available), and telephone number of the applicant. If the applicant is not an individual, the application must state the name, mailing address, physical address(es) of all known new locations not previously identified in the application where the special permit would be used and all locations not previously identified where the special permit was used, e-mail address (if available), and telephone number of an individual designated as the

point of contact for the applicant for all purposes related to the application, the name of the company Chief Executive Officer (CEO), president, or ranking executive officer, and the Dun and Bradstreet Data Universal Numbering System (D-U-N-S) identifier. In addition, each applicant for renewal of party status must state why party status to the special permit is needed and must submit a certification of understanding of the provisions of the special permit to which party status is being requested.

(4) The application must include either a certification by the applicant that the original application, as it may have been updated by any application for renewal, remains accurate (*e.g.*, all section references, shipping descriptions, *etc.*) and complete; or include an amendment to the previously submitted application as is necessary to update and ensure the accuracy and completeness of the application, with certification by the applicant that the application as amended is accurate and complete.

(5) The application must include a statement describing all relevant operational, shipping, and incident experience of which the applicant is aware in connection with the special permit since its issuance or most recent renewal. If the applicant is aware of no incidents, the applicant must so certify. When known to the applicant, the statement must indicate the approximate number of shipments made or packages shipped, as applicable, and the number of shipments or packages involved in any loss of contents, including loss by venting other than as authorized in subchapter C.

(6) When a Class 1 material is forbidden for transportation by aircraft, except under a special permit (*see* Columns 9A and 9B in the table in 49 CFR 172.101), an application to renew a special permit to transport such Class 1 material on passenger-carrying or cargo-only aircraft with a maximum certificated takeoff weight of less than 12,500 pounds must certify that no person within the categories listed in 18 U.S.C. 842(i) will participate in the transportation of the Class 1 material.

§ 107.111

(7) If the renewal is requested after the expiration date of the special permit, the following information is required:

(i) The reason the special permit authorization was allowed to expire;

(ii) A certification statement that no shipments were transported after the expiration date of the special permit, or a statement describing any transportation under the terms of the special permit after the expiration date, if applicable; and

(iii) A statement describing the action(s) the applicant will take to ensure future renewal is requested before the expiration date.

(8) If no operations or shipments have been made since the issuance or renewal of the special permit, the applicant must provide specific justification as to why the special permit should be renewed.

(9) A statement indicating whether the applicant will be acting as a shipper (offeror), carrier or both under the terms of the special permit.

(b) If, at least 60 days before an existing special permit expires the holder files an application for renewal that is complete and conforms to the requirements of this section, the special permit will not expire until final administrative action on the application for renewal has been taken.

[76 FR 462, Jan. 5, 2011, as amended at 76 FR 44501, July 26, 2011; 76 FR 43524, July 20, 2011; 76 FR 56310, Sept. 13, 2011]

§ 107.111 Withdrawal.

An application may be withdrawn at any time before a decision to grant or deny it is made. Withdrawal of an application does not authorize the removal of any related records from the PHMSA dockets or files. Applications that are eligible for confidential treatment under §105.30 will remain confidential after the application is withdrawn. The duration of this confidential treatment for trade secrets and commercial or financial information is indefinite, unless the party requesting the confidential treatment of the materials notifies the Associate Administrator that the confidential treatment is no longer required.

49 CFR Ch. I (10–1–14 Edition)

§ 107.113 Application processing and evaluation.

(a) The Associate Administrator reviews an application for a special permit, modification of a special permit, party to a special permit, or renewal of a special permit to determine if it is complete and conforms with the requirements of this subpart. This determination will be made within 30 days of receipt of the application for a special permit, modification of a special permit, or party to a special permit, and within 15 days of receipt of an application for renewal of a special permit. If an application is determined to be incomplete, the applicant is informed of the deficiency.

(b) An application, that is not a renewal, party to, or emergency special permit application, and is determined to be complete is docketed. Notice of the application is published in the FEDERAL REGISTER, and an opportunity for public comment is provided. All comments received during the comment period are considered before final action is taken on the application.

(c) No public hearing or other formal proceeding is required under this subpart before the disposition of an application. Unless emergency processing under §107.117 is requested and granted, applications are usually processed in the order in which they are filed.

(d) During the processing and evaluation of an application, the Associate Administrator may conduct an on-site review or request additional information from the applicant. A failure to cooperate with an on-site review may result in the application being deemed incomplete and subsequently being denied. If the applicant does not respond to a written or electronic request for additional information within 30 days of the date the request was received, the application may be deemed incomplete and denied. However, if the applicant responds in writing or by electronic means within the 30-day period requesting an additional 30 days within which it will gather the requested information, the Associate Administrator may grant the 30-day extension.

(e) The Associate Administrator may grant or deny an application, in whole or in part. In the Associate Administrator's discretion, an application may

be granted subject to provisions that are appropriate to protect health, safety or property. The Associate Administrator may impose additional provisions not specified in the application or remove conditions in the application that are unnecessary.

(f) The Associate Administrator may grant an application on finding that—

(1) The application complies with this subpart;

(2) The application demonstrates that the proposed alternative will achieve a level of safety that:

(i) Is at least equal to that required by the regulation from which the special permit is sought, or

(ii) If the regulations do not establish a level of safety, is consistent with the public interest and adequately will protect against the risks to life and property inherent in the transportation of hazardous materials in commerce;

(3) The application states all material facts, and contains no materially false or materially misleading statement;

(4) The applicant meets the qualifications required by applicable regulations; and

(5) The applicant is fit to conduct the activity authorized by the special permit. This assessment may be based on information in the application, prior compliance history of the applicant, and other information available to the Associate Administrator.

(g) An applicant is notified in writing or by electronic means whether the application is granted or denied. A denial contains a brief statement of reasons.

(h) The initial special permit terminates according to its terms or, if not otherwise specified, 24 months from the date of issuance. A subsequent renewal of a special permit terminates according to its terms or, if not otherwise specified, 48 months after the date of issuance. A grant of party status to a special permit, unless otherwise stated, terminates on the date that the special permit expires.

(i) The Associate Administrator, on determining that an application concerns a matter of general applicability and future effect and should be the subject of rulemaking, may initiate rulemaking under part 106 of this chapter

in addition to or instead of acting on the application.

(j) The Associate Administrator publishes in the FEDERAL REGISTER a list of all special permit grants, denials, and modifications and all special permit applications withdrawn under this section.

[Amdt. 107-38, 61 FR 21095, May 9, 1996, as amended at 67 FR 61011, Sept. 27, 2002; 70 FR 73161, Dec. 9, 2005; 76 FR 463, Jan. 5, 2011]

§ 107.117 Emergency processing.

(a) An application is granted emergency processing if the Associate Administrator, on the basis of the application and any inquiry undertaken, finds that—

(1) Emergency processing is necessary to prevent significant injury to persons or property (other than the hazardous material to be transported) that could not be prevented if the application were processed on a routine basis; or

(2) Emergency processing is necessary for immediate national security purposes or to prevent significant economic loss that could not be prevented if the application were processed on a routine basis.

(b) Where the significant economic loss is to the applicant, or to a party in a contractual relationship to the applicant with respect to the activity to be undertaken, the Associate Administrator may deny emergency processing if timely application could have been made.

(c) A request for emergency processing on the basis of potential economic loss must reasonably describe and estimate the potential loss.

(d) An application submitted under this section must conform to §107.105 to the extent that the receiving Department official deems necessary to process the application. An application on an emergency basis must be submitted to the Department modal contact official for the initial mode of transportation to be utilized, as follows:

(1) *Certificate-Holding Aircraft*: The Federal Aviation Administration Civil Aviation Security Office that serves

§ 107.121

49 CFR Ch. I (10–1–14 Edition)

the place where the flight will originate or that is responsible for the aircraft operator's overall aviation security program. The nearest Civil Aviation Security Office may be located by calling the FAA Duty Officer, 202-267-3333 (any hour).

(2) *Noncertificate-Holding Aircraft (Those Which Operate Under 14 CFR Part 91)*: The Federal Aviation Administration Civil Aviation Security Office that serves the place where the flight will originate. The nearest Civil Aviation Security Office may be located by calling the FAA Duty Officer, 202-267-3333 (any hour).

(3) *Motor Vehicle Transportation*: Chief, Hazardous Materials Division, Federal Motor Carrier Safety Administration, U.S. Department of Transportation, Washington, DC 20590-0001, 202-385-2400 (day); 1-800-424-8802 (night).

(4) *Rail Transportation*: Staff Director, Hazardous Materials Division, Office of Safety Assurance and Compliance, Federal Railroad Administration, U.S. Department of Transportation, Washington, DC 20590-0001, 202-493-6248 or 202-493-6244 (day); 1-800-424-8802 (night).

(5) *Water Transportation*: Chief, Hazardous Materials Standards Division, Office of Operating and Environmental Standards, U.S. Coast Guard, U.S. Department of Homeland Security, Washington, DC 20593-0001; 202-372-1420 (day); 1-800-424-8802 (night).

(e) On receipt of all information necessary to process the application, the receiving Department official transmits to the Associate Administrator, by the most rapid available means of communication, an evaluation as to whether an emergency exists under §107.117(a) and, if appropriate, recommendations as to the conditions to be included in the special permit. If the Associate Administrator determines that an emergency exists under §107.117(a) and that, with reference to the criteria of §107.113(f), granting of the application is in the public interest, the Associate Administrator grants the application subject to such terms as necessary and immediately notifies the applicant. If the Associate Administrator determines that an emergency does not exist or that granting of the application is not in

the public interest, the applicant immediately is so notified.

(f) A determination that an emergency does not exist is not subject to reconsideration under §107.123 of this part.

(g) Within 90 days following issuance of an emergency special permit, the Associate Administrator will publish, in the FEDERAL REGISTER, a notice of issuance with a statement of the basis for the finding of emergency and the scope and duration of the special permit.

[Amdt. 107-38, 61 FR 21095, May 9, 1996, as amended at 62 FR 51556, Oct. 1, 1997; 64 FR 51914, Sept. 27, 1999; 65 FR 58618, Sept. 29, 2000; 66 FR 45377, Aug. 28, 2001; 67 FR 61011, Sept. 27, 2002; 70 FR 56090, Sept. 23, 2005; 75 FR 53596, Sept. 1, 2010; 76 FR 463, Jan. 5, 2011]

§107.121 Modification, suspension or termination of special permit or grant of party status.

(a) The Associate Administrator may modify a special permit or grant of party status on finding that:

(1) Modification is necessary so that the special permit reflects current statutes and regulations; or

(2) Modification is required by changed circumstances to meet the standards of §107.113(f).

(b) The Associate Administrator may modify, suspend or terminate a special permit or grant of party status, as appropriate, on finding that:

(1) Because of a change in circumstances, the special permit or party status no longer is needed or no longer would be granted if applied for;

(2) The application contained inaccurate or incomplete information, and the special permit or party status would not have been granted had the application been accurate and complete;

(3) The application contained deliberately inaccurate or incomplete information; or

(4) The holder or party knowingly has violated the terms of the special permit or an applicable requirement of this chapter in a manner demonstrating the holder or party is not fit to conduct the activity authorized by the special permit.

(c) Except as provided in paragraph (d) of this section, before a special permit or grant of party status is modified, suspended, or terminated, the Associate Administrator notifies the holder or party in writing or by electronic means of the proposed action and the reasons for it, and provides an opportunity to show cause why the proposed action should not be taken.

(1) Within 30 days of receipt of notice of the proposed action, the holder or party may file a response in writing or by electronic means that shows cause why the proposed action should not be taken.

(2) After considering the holder's or party's response, or after 30 days have passed without response since receipt of the notice, the Associate Administrator notifies the holder or party in writing or by electronic means of the final decision with a brief statement of reasons.

(d) The Associate Administrator, if necessary to avoid a risk of significant harm to persons or property, may, in the notification, declare the proposed action immediately effective.

[76 FR 463, Jan. 5, 2011]

§ 107.123 Reconsideration.

(a) An applicant for special permit, a special permit holder, or an applicant for party status to a special permit may request that the Associate Administrator reconsider a decision under § 107.113(g), § 107.117(e) or § 107.121(c) of this part. The request must—

(1) Be in writing or by electronic means and filed within 20 days of receipt of the decision;

(2) State in detail any alleged errors of fact and law;

(3) Enclose any additional information needed to support the request to reconsider; and

(4) State in detail the modification of the final decision sought.

(b) The Associate Administrator grants or denies, in whole or in part, the relief requested and informs the requesting person in writing or by electronic means of the decision. If necessary to avoid a risk of significant harm to persons or property, the Associate Administrator may, in the notification,

declare the action immediately effective.

[76 FR 463, Jan. 5, 2011]

§ 107.125 Appeal.

(a) A person who requested reconsideration under § 107.123 and is denied the relief requested may appeal to the Administrator. The appeal must—

(1) Be in writing or by electronic means and filed within 30 days of receipt of the Associate Administrator's decision on reconsideration; (2) state in detail any alleged errors of fact and law;

(2) State in detail any alleged errors of fact and law;

(3) Enclose any additional information needed to support the appeal; and

(4) State in detail the modification of the final decision sought.

(b) The Administrator, if necessary to avoid a risk of significant harm to persons or property, may declare the Associate Administrator's action effective pending a decision on appeal.

(c) The Administrator grants or denies, in whole or in part, the relief requested and informs the appellant in writing or by electronic means of the decision. The Administrator's decision is the final administrative action.

[Amdt. 107-38, 61 FR 21095, May 9, 1996, as amended at 76 FR 463, Jan. 5, 2011]

§ 107.127 Availability of documents for public inspection.

(a) Documents related to an application under this subpart, including the application itself, are available for public inspection, except as specified in paragraph (b) of this section, at the Office of the Associate Administrator for Hazardous Materials Safety, Pipeline and Hazardous Materials Safety Administration, Approvals and Permits Division, U.S. Department of Transportation, East Building, PHH-30, 1200 New Jersey Avenue, SE., Washington, DC 20590-0001. Office hours are 8:30 a.m. to 5 p.m., Monday through Friday, except Federal holidays when the office is closed. Copies of available documents may be obtained as provided in part 7 of this title. Documents numbered 11832 and above may also be viewed at the website address <http://www.regulations.gov>.

(b) Documents available for inspection do not include materials determined to be withheld from public disclosure under § 105.30 and in accordance with the applicable provisions of section 552(b) of title 5, United States Code, and part 7 of this title.

[Amdt. 107–38, 61 FR 21095, May 9, 1996, as amended at 65 FR 58618, Sept. 29, 2000; 66 FR 45377, Aug. 28, 2001; 67 FR 61011, Sept. 27, 2002; 70 FR 73162, Dec. 9, 2005; 72 FR 55683, Oct. 1, 2007; 76 FR 56310, Sept. 13, 2011]

Subpart C—Preemption

§ 107.201 Purpose and scope.

(a) This subpart prescribes procedures by which:

(1) Any person, including a State, political subdivision, or Indian tribe, directly affected by a requirement of a State, political subdivision, or Indian tribe, may apply for a determination as to whether that requirement is preempted under 49 U.S.C. 5125.

(2) A State, political subdivision, or Indian tribe may apply for a waiver of preemption with respect to any requirement that the State, political subdivision, or Indian tribe acknowledges to be preempted by 49 U.S.C. 5125, or that has been determined by a court of competent jurisdiction to be so preempted.

(b) For purposes of this subpart “political subdivision” includes a municipality; a public agency or other instrumentality of one or more States, municipalities, or other political subdivisions of a State; or a public corporation, board, or commission established under the laws of one or more States.

(c) [Reserved]

(d) An application for a preemption determination that includes an application for a waiver of preemption will be treated and processed solely as an application for a preemption determination.

[Amdt. 107–3, 41 FR 38171, Sept. 9, 1976, as amended by Amdt. 107–24, 56 FR 8622, Feb. 28, 1991; Amdt. 107–25, 57 FR 20428, May 13, 1992; Amdt. 107–32, 59 FR 49130, Sept. 26, 1994; Amdt. 107–35, 60 FR 49108, Sept. 21, 1995; Amdt. 107–38, 61 FR 21098, May 9, 1996; 68 FR 52846, Sept. 8, 2003; 71 FR 30067, May 25, 2006]

§ 107.202 Standards for determining preemption.

(a) Except as provided in § 107.221 and unless otherwise authorized by Federal law, any requirement of a State or political subdivision thereof or an Indian tribe that concerns one of the following subjects and that is not substantively the same as any provision of the Federal hazardous materials transportation law, a regulation issued under the Federal hazardous material transportation law, or a hazardous material transportation security regulation or directive issued by the Secretary of Homeland Security that concerns that subject, is preempted:

(1) The designation, description, and classification of hazardous material.

(2) The packing, repacking, handling, labeling, marking, and placarding of hazardous material.

(3) The preparation, execution, and use of shipping documents pertaining to hazardous material and requirements related to the number, content, and placement of those documents.

(4) The written notification, recording, and reporting of the unintentional release in transportation of hazardous material and other written hazardous materials transportation incident reporting involving State or local emergency responders in the initial response to the incident.

(5) The design, manufacturing, fabrication, marking, maintenance, reconditioning, repairing, or testing of a packaging or a container which is represented, marked, certified, or sold as qualified for use in the transportation of hazardous material.

(b) Except as provided in § 107.221 and unless otherwise authorized by Federal law, any requirement of a State or political subdivision or Indian tribe is preempted if—

(1) It is not possible to comply with a requirement of the State, political subdivision, or Indian tribe and a requirement under the Federal hazardous material transportation law, a regulation issued under the Federal hazardous material transportation law, or a hazardous material transportation security regulation or directive issued by the Secretary of Homeland Security;

(2) The requirement of the State, political subdivision, or Indian tribe, as

applied or enforced, is an obstacle to accomplishing and carrying out the Federal hazardous material transportation law, a regulation issued under the Federal hazardous material transportation law, or a hazardous material transportation security regulation or directive issued by the Secretary of Homeland Security.

(3) It is preempted under 49 U.S.C. 5125 (c).

(c) A State, political subdivision, or Indian tribe may impose a fee related to transporting hazardous material only if the fee is fair and used for a purpose related to transporting hazardous material, including enforcement and planning, developing and maintaining a capability for emergency response.

(d) For purposes of this section, “substantively the same” means that the non-Federal requirement conforms in every significant respect to the Federal requirement. Editorial and other similar *de minimis* changes are permitted.

[Amdt. 107-24, 56 FR 8622, Feb. 28, 1991, as amended by Amdt. 107-25, 57 FR 20428, May 13, 1992; Amdt. 107-29, 58 FR 51527, Oct. 1, 1993; Amdt. 107-32, 59 FR 49130, Sept. 26, 1994; Amdt. 107-38, 61 FR 21098, May 9, 1996; Amdt. 107-39, 61 FR 51337, Oct. 1, 1996; 68 FR 52847, Sept. 8, 2003; 77 FR 60939, Oct. 5, 2012]

PREEMPTION DETERMINATIONS

§ 107.203 Application.

(a) With the exception of highway routing matters covered under 49 U.S.C. 5125(c), any person, including a State or political subdivision thereof or an Indian tribe, directly affected by any requirement of a State or political subdivision thereof or an Indian tribe, may apply to the Chief Counsel for a determination as to whether that requirement is preempted by § 107.202(a), (b), or (c).

(b) Each application filed under this section for a determination must:

(1) Be submitted to the Chief Counsel:

(i) By mail addressed to the Chief Counsel, Pipeline and Hazardous Materials Safety Administration, U.S. Department of Transportation, East Building, PHC-1, 1200 New Jersey Avenue, SE., Washington, DC 20590-0001;

(ii) By facsimile to 202-366-7041; or

(iii) Electronically to the Chief Counsel at *phmsachiefcounsel@dot.gov*.

(2) Set forth the text of the State or political subdivision or Indian tribe requirement for which the determination is sought;

(3) Specify each requirement of the Federal hazardous materials transportation law, regulations issued under the Federal hazardous material transportation law, or hazardous material transportation security regulations or directives issued by the Secretary of Homeland Security with which the applicant seeks the State or political subdivision or Indian tribe requirement to be compared;

(4) Explain why the applicant believes the State or political subdivision or Indian tribe requirement should or should not be preempted under the standards of § 107.202; and

(5) State how the applicant is affected by the State or political subdivision or Indian tribe requirement.

(c) The filing of an application for a determination under this section does not constitute grounds for noncompliance with any requirement of the Federal hazardous materials transportation law, regulations issued under the Federal hazardous material transportation law, or hazardous material transportation security regulations or directives issued by the Secretary of Homeland Security.

(d) Once the Chief Counsel has published notice in the FEDERAL REGISTER of an application received under paragraph (a) of this section, no applicant for such determination may seek relief with respect to the same or substantially the same issue in any court until final action has been taken on the application or until 180 days after filing of the application, whichever occurs first. Nothing in § 107.203(a) prohibits a State or political subdivision thereof or Indian tribe, or any other person directly affected by any requirement of a State or political subdivision thereof or Indian tribe, from seeking a determination of preemption in any court of

§ 107.205

competent jurisdiction in lieu of applying to the Chief Counsel under paragraph (a) of this section.

[Amdt. 107-24, 56 FR 8622, Feb. 28, 1991, as amended by Amdt. 107-25, 57 FR 20428, May 13, 1992; Amdt. 107-32, 59 FR 49131, Sept. 26, 1994; Amdt. 107-38, 61 FR 21098, May 9, 1996; 68 FR 52847, Sept. 8, 2003; 71 FR 30067, May 25, 2006; 72 FR 55683, Oct. 1, 2007]

§ 107.205 Notice.

(a) If the applicant is other than a State, political subdivision, or Indian tribe, the applicant shall mail a copy of the application to the State, political subdivision, or Indian tribe concerned accompanied by a statement that the State, political subdivision, or Indian tribe may submit comments regarding the application to the Chief Counsel. The application filed with the Chief Counsel must include a certification that the applicant has complied with this paragraph and must include the names and addresses of each State, political subdivision, or Indian tribe official to whom a copy of the application was sent.

(b) The Chief Counsel will publish notice of, including an opportunity to comment on, an application in the FEDERAL REGISTER and may notify in writing any person readily identifiable as affected by the outcome of the determination.

(c) Each person submitting written comments to the Chief Counsel with respect to an application filed under this section must send a copy of the comments to the applicant and certify to the Chief Counsel that he or she has complied with this requirement. The Chief Counsel may notify other persons participating in the proceeding of the comments and provide an opportunity for those other persons to respond. Late-filed comments are considered so far as practicable.

[Amdt. 107-38, 61 FR 21098, May 9, 1996, as amended at 71 FR 30067, May 25, 2006]

§ 107.207 Processing.

(a) The Chief Counsel may initiate an investigation of any statement in an application and utilize in his or her evaluation any relevant facts obtained by that investigation. The Chief Counsel may solicit and accept submissions from third persons relevant to an appli-

49 CFR Ch. I (10-1-14 Edition)

cation and will provide the applicant an opportunity to respond to all third person submissions. In evaluating an application, the Chief Counsel may consider any other source of information. The Chief Counsel on his or her own initiative may convene a hearing or conference, if he or she considers that a hearing or conference will advance his or her evaluation of the application.

(b) The Chief Counsel may dismiss the application without prejudice if:

(1) He or she determines that there is insufficient information upon which to base a determination; or

(2) He or she requests additional information from the applicant and it is not submitted.

[Amdt. 107-3, 41 FR 38171, Sept. 9, 1976, as amended by Amdt. 107-24, 56 FR 8621, 8622, Feb. 28, 1991; Amdt. 107-38, 61 FR 21098, May 9, 1996; 71 FR 30067, May 25, 2006]

§ 107.209 Determination.

(a) Upon consideration of the application and other relevant information received, the Chief Counsel issues a determination.

(b) The determination includes a written statement setting forth the relevant facts and the legal basis for the determination, and provides that any person aggrieved thereby may file a petition for reconsideration with the Chief Counsel.

(c) The Chief Counsel provides a copy of the determination to the applicant and to any other person who substantially participated in the proceeding or requested in comments to the docket to be notified of the determination. A copy of each determination is placed on file in the public docket. The Chief Counsel will publish the determination or notice of the determination in the FEDERAL REGISTER, at which time the determination becomes a final agency action.

(d) A determination issued under this section constitutes an administrative determination as to whether a particular requirement of a State or political subdivision or Indian tribe is preempted under the Federal hazardous materials transportation law. The fact that a determination has not been issued under this section with respect to a particular requirement of a State

or political subdivision or Indian tribe carries no implication as to whether the requirement is preempted under the Federal hazardous materials transportation law.

[Amdt. 107-24, 56 FR 8623, Feb. 28, 1991, as amended by Amdt. 107-25, 57 FR 20428, May 13, 1992; Amdt. 107-32, 59 FR 49131, Sept. 26, 1994; Amdt. 107-38, 61 FR 21098, May 9, 1996; 68 FR 52847, Sept. 8, 2003; 71 FR 30067, May 25, 2006]

§ 107.211 Petition for reconsideration.

(a) Any person aggrieved by a determination issued under § 107.209 may file a petition for reconsideration. The petition must be filed with the Chief Counsel, in the same manner specified for filing an application in § 107.203(b), within 20 days of publication of the determination in the FEDERAL REGISTER.

(b) The petition must contain a concise statement of the basis for seeking review, including any specific factual or legal error alleged. If the petition requests consideration of information that was not previously made available to the Chief Counsel, the petition must include the reasons why such information was not previously made available.

(c) The petitioner shall mail a copy of the petition to each person who participated, either as an applicant or commenter, in the preemption determination proceeding, accompanied by a statement that the person may submit comments concerning the petition to the Chief Counsel within 20 days. The petition filed with the Chief Counsel must contain a certification that the petitioner has complied with this paragraph and include the names and addresses of all persons to whom a copy of the petition was sent. Late-filed comments are considered so far as practicable.

(d) The Chief Counsel will publish the decision on the petition for reconsideration or notice of the decision in the FEDERAL REGISTER, at which time the decision on the petition for reconsideration becomes a final agency action.

[Amdt. 107-25, 57 FR 20428, May 13, 1992, as amended by Amdt. 107-38, 61 FR 21099, May 9, 1996; 71 FR 30067, May 25, 2006]

§ 107.213 Judicial review.

A party to a proceeding under § 107.203(a) may seek review of a determination of the Chief Counsel by filing a petition, within 60 days after the determination becomes final, in the United States Court of Appeals for the District of Columbia or in the Court of Appeals for the United States for the circuit in which the person resides or has its principal place of business.

[71 FR 30068, May 25, 2006]

WAIVER OF PREEMPTION
DETERMINATIONS

§ 107.215 Application.

(a) With the exception of requirements preempted under 49 U.S.C. 5125(c), a State or political subdivision thereof, or Indian tribe may apply to the Chief Counsel for a waiver of preemption with respect to any requirement that the State or political subdivision thereof or Indian tribe acknowledges to be preempted under the Federal hazardous materials transportation law, or that has been determined by a court of competent jurisdiction to be so preempted. The Chief Counsel may waive preemption with respect to such requirement upon a determination that such requirement—

(1) Affords an equal or greater level of protection to the public than is afforded by the requirements of the Federal hazardous material transportation law or the regulations issued thereunder, and

(2) Does not unreasonably burden commerce.

(b) Each application filed under this section for a waiver of preemption determination must:

(1) Be submitted to the Chief Counsel:

(i) By mail addressed to the Chief Counsel, Pipeline and Hazardous Materials Safety Administration, U.S. Department of Transportation, East Building, PHC-1, 1200 New Jersey Avenue, SE., Washington, DC 20590-0001;

(ii) By facsimile to 202-366-7041; or

(iii) Electronically to the Chief Counsel at phmsachiefcounsel@dot.gov.

(2) Set forth the text of the State or political subdivision requirement for

§ 107.217

which the determination is being sought;

(3) Include a copy of any court order and any ruling issued under §107.209 having a bearing on the application;

(4) Contain an express acknowledgment by the applicant that the State, political subdivision, or Indian tribe requirement is preempted under Federal hazardous materials transportation law, unless it has been so determined by a court of competent jurisdiction or in a determination issued under §107.209;

(5) Specify each requirement of the Federal hazardous materials transportation law that preempts the State, political subdivision, or Indian tribe requirement;

(6) State why the applicant believes the State, political subdivision or Indian tribe requirements affords an equal or greater level of protection to the public than is afforded by the requirements of the Federal hazardous material transportation law or the regulations issued thereunder;

(7) State why the applicant believes the State, political subdivision or Indian tribe requirement does not unreasonably burden commerce; and

(8) Specify what steps the State, political subdivision or Indian tribe is taking to administer and enforce effectively its inconsistent requirement.

[Amdt. 107-3, 41 FR 38171, Sept. 9, 1976, as amended by Amdt. 107-22, 55 FR 39978, Oct. 1, 1990; Amdt. 107-24, 56 FR 8621, 8623, Feb. 28, 1991; 56 FR 15510, Apr. 17, 1991; Amdt. 107-23, 56 FR 66156, Dec. 20, 1991; Amdt. 107-25, 57 FR 20428, May 13, 1992; Amdt. 107-32, 59 FR 49131, Sept. 26, 1994; Amdt. 107-38, 61 FR 21099, May 9, 1996; 68 FR 52847, Sept. 8, 2003; 71 FR 30068, May 25, 2006; 72 FR 55683, Oct. 1, 2007]

§ 107.217 Notice.

(a) The applicant shall mail a copy of the application and any subsequent amendments or other documents relating to the application to each person who is reasonably ascertainable by the applicant as a person who will be affected by the determination sought. The copy of the application must be accompanied by a statement that the person may submit comments regarding the application within 45 days. The application must include a certification that the application has complied with this paragraph and must in-

49 CFR Ch. I (10-1-14 Edition)

clude the names and addresses of each person to whom the application was sent.

(b) Notwithstanding the provisions of paragraph (a) of this section, if the State or political subdivision determines that compliance with paragraph (a) of this section would be impracticable, the applicant shall:

(1) Comply with the requirements of paragraph (a) of this section with regard to those persons whom it is reasonable and practicable to notify; and

(2) Include with the application a description of the persons or class or classes of persons to whom notice was not sent.

(c) The Chief Counsel may require the applicant to provide notice in addition to that required by paragraphs (a) and (b) of this section, or may determine that the notice required by paragraph (a) of the section is not impracticable, or that notice should be published in the FEDERAL REGISTER. Late-filed comments are considered so far as practicable.

(d) The Chief Counsel may notify any other persons who may be affected by the outcome of a determination on the application.

(e) Any person submitting written comments with respect to an application filed under this section shall send a copy of the comments to the applicant. The person shall certify that he has complied with the requirements of this paragraph. The Chief Counsel may notify other persons participating in the proceeding of the comments and provide an opportunity for those other persons to respond.

[Amdt. 107-3, 41 FR 38171, Sept. 9, 1976, as amended by Amdt. 107-24, 56 FR 8621, Feb. 28, 1991; Amdt. 107-25, 57 FR 20429, May 13, 1992; Amdt. 107-38, 61 FR 21099, May 9, 1996; 71 FR 30068, May 25, 2006]

§ 107.219 Processing.

(a) The Chief Counsel may initiate an investigation of any statement in an application and utilize in his or her evaluation any relevant facts obtained by that investigation. The Chief Counsel may solicit and accept submissions from third persons relevant to an application and will provide the applicant an opportunity to respond to all third person submissions. In evaluating an

application, the Chief Counsel on his or her own initiative may convene a hearing or conference, if he or she considers that a hearing or conference will advance his or her evaluation of the application.

(b) The Chief Counsel may dismiss the application without prejudice if:

(1) He or she determines that there is insufficient information upon which to base a determination;

(2) Upon his or her request, additional information is not submitted by the applicant; or

(3) The applicant fails to provide the notice required by §107.217.

(c) The Chief Counsel will only consider an application for waiver of preemption determination if—

(1) The applicant State or political subdivision thereof or Indian tribe expressly acknowledges in its application that the State or political subdivision or Indian tribe requirement for which the determination is sought is inconsistent with the requirements of the Federal hazardous materials transportation law, regulations issued under the Federal hazardous material transportation law, or hazardous material transportation security regulations or directives issued by the Secretary of Homeland Security.

(2) The State or political subdivision thereof or Indian tribe requirement has been determined by a court of competent jurisdiction or in a ruling issued under §107.209 to be inconsistent with the requirements of the Federal hazardous materials transportation law, regulations issued under the Federal hazardous material transportation law, or hazardous material transportation security regulations or directives issued by the Secretary of Homeland Security.

(d) When the Chief Counsel has received all substantive information it considers necessary to process an application for a waiver of preemption determination, it serves notice of that fact upon the applicant and all other persons who received notice of the proceeding pursuant to §107.217.

(e) To the extent possible, each application for a waiver of preemption determination will be acted upon in a manner consistent with the disposition

of previous applications for waiver of preemption determinations.

[Amdt. 107-3, 41 FR 38171, Sept. 9, 1976, as amended by Amdt. 107-24, 56 FR 8621, 8623, Feb. 28, 1991; Amdt. 107-32, 59 FR 49131, Sept. 26, 1994; Amdt. 107-38, 61 FR 21099, May 9, 1996; 65 FR 58618, Sept. 29, 2000; 68 FR 52847, Sept. 8, 2003; 69 FR 54044, Sept. 7, 2004; 71 FR 30068, May 25, 2006]

§ 107.221 Determination.

(a) After considering the application and other relevant information received or obtained during the proceeding, the Chief Counsel issues a determination.

(b) The Chief Counsel may issue a waiver of preemption only on finding that the requirement of the State or political subdivision thereof or Indian tribe affords the public a level of safety at least equal to that afforded by the requirements of the Federal hazardous material transportation law or the regulations issued thereunder and does not unreasonably burden commerce. In determining if the requirement of the State or political subdivision thereof or Indian tribe unreasonably burdens commerce, the Chief Counsel considers:

(1) The extent to which increased costs and impairment of efficiency result from the requirement of the State or political subdivision thereof or Indian tribe.

(2) Whether the requirement of the State or political subdivision thereof or Indian tribe has a rational basis.

(3) Whether the requirement of the State or political subdivision thereof or Indian tribe achieves its stated purpose.

(4) Whether there is need for uniformity with regard to the subject concerned and if so, whether the requirement of the State or political subdivision thereof or Indian tribe competes or conflicts with those of other States or political subdivisions thereof or Indian tribes.

(c) The determination includes a written statement setting forth relevant facts and legal bases and providing that any person aggrieved by the determination may file a petition for reconsideration with the Chief Counsel.

(d) The Chief Counsel provides a copy of the determination to the applicant

§ 107.223

and to any other person who substantially participated in the proceeding or requested in comments to the docket to be notified of the determination. A copy of the determination is placed on file in the public docket. The Chief Counsel will publish the determination or notice of the determination in the FEDERAL REGISTER, at which time the determination becomes a final agency action.

(e) A determination under this section constitutes an administrative finding of whether a particular requirement of a State or political subdivision thereof or Indian tribe is preempted under the Federal hazardous materials transportation law, or whether preemption is waived.

[Amdt. 107-38, 61 FR 21099, May 9, 1996, as amended at 68 FR 52848, Sept. 8, 2003; 71 FR 30068, May 25, 2006]

§ 107.223 Petition for reconsideration.

(a) Any person aggrieved by a determination under §107.221 may file a petition for reconsideration. The petition must be filed with the Chief Counsel, in the same manner specified for filing an application in §107.215(b), within 20 days of publication of the determination in the FEDERAL REGISTER.

(b) The petition must contain a concise statement of the basis for seeking review, including any specific factual or legal error alleged. If the petition requests consideration of information that was not previously made available to the Chief Counsel, the petition must include the reasons why such information was not previously made available.

(c) The petitioner shall mail a copy of the petition to each person who participated, either as an applicant or commenter, in the waiver of preemption proceeding, accompanied by a statement that the person may submit comments concerning the petition to the Chief Counsel within 20 days. The petition filed with the Chief Counsel must contain a certification that the petitioner has complied with this paragraph and include the names and addresses of all persons to whom a copy of the petition was sent. Late-filed comments are considered so far as practicable.

49 CFR Ch. I (10-1-14 Edition)

(d) The Chief Counsel will publish the decision on the petition for reconsideration or notice of the decision in the FEDERAL REGISTER, at which time the decision on the petition for reconsideration becomes a final agency action.

[Amdt. 107-25, 57 FR 20429, May 13, 1992, as amended by Amdt. 107-38, 61 FR 21099, May 9, 1996; 71 FR 30068, May 25, 2006]

§ 107.227 Judicial review.

A party to a proceeding under §107.215(a) may seek review of a determination of the Chief Counsel by filing a petition, within 60 days after the determination becomes final, in the United States Court of Appeals for the District of Columbia or in the Court of Appeals for the United States for the circuit in which the person resides or has its principal place of business.

[71 FR 30068, May 25, 2006]

Subpart D—Enforcement

SOURCE: Amdt. 107-11, 48 FR 2651, Jan. 20, 1983, unless otherwise noted.

§ 107.301 Delegated authority for enforcement.

Under redelegation from the Administrator, Pipeline and Hazardous Materials Safety Administration, the Associate Administrator for Hazardous Materials Safety and the Office of the Chief Counsel exercise their authority for enforcement of the Federal hazardous material transportation law, this subchapter, and subchapter C of this subchapter, in accordance with §1.53 of this title.

[Amdt. 107-11, 48 FR 2651, Jan. 20, 1983, as amended by Amdt. 107-24, 56 FR 8621, Feb. 28, 1991; Amdt. 107-32, 59 FR 49131, Sept. 26, 1994]

§ 107.303 Purpose and scope.

This subchapter describes the various enforcement authorities exercised by the Associate Administrator for Hazardous Materials Safety and the Office of Chief Counsel and the associated sanctions and prescribes the procedures governing the exercise of those authorities and the imposition of those sanctions.

[Amdt. 107-11, 48 FR 2651, Jan. 20, 1983, as amended by Amdt. 107-15, 51 FR 34986, Oct. 1, 1986; Amdt. 107-24, 56 FR 8621, Feb. 28, 1991]

§ 107.305 Investigations.

(a) *General.* In accordance with its delegated authority under part 1 of this title, the Associate Administrator may initiate investigations relating to compliance by any person with any provisions of this subchapter or subchapter C of this chapter, or any special permit, approval, or order issued thereunder, or any court decree relating thereto. The Associate Administrator encourages voluntary production of documents in accordance with and subject to §105.45, and hearings may be conducted, and depositions taken pursuant to 49 U.S.C. 5121(a). The Associate Administrator may conduct investigative conferences and hearings in the course of any investigation.

(b) *Investigations and Inspections.* Investigations under 49 U.S.C. 5121(a) are conducted by personnel duly authorized for that purpose by the Associate Administrator. Inspections under 49 U.S.C. 5121(c) are conducted by Hazardous Materials Enforcement Specialists or Hazardous Materials Compliance Investigators, also known as “hazmat investigators” or “investigators,” whom the Associate Administrator has designated for that purpose.

(1) An investigator will, on request, present his or her credentials for examination, but the credentials may not be reproduced.

(2) An investigator may administer oaths and receive affirmations in any matter under investigation by the Associate Administrator.

(3) An investigator may gather information by reasonable means including, but not limited to, interviews, statements, photocopying, photography, and video- and audio-recording.

(4) With concurrence of the Director, Field Operations, Pipeline and Hazardous Materials Safety Administration, an investigator may issue a subpoena for the production of documentary or other tangible evidence if, on the basis of information available to the investigator, the documents and evidence materially will advance a determination of compliance with this subchapter or subchapter C. Service of a subpoena shall be in accordance with §105.50. A person to whom a subpoena is directed may seek review of the subpoena by applying to the Office of Chief

Counsel in accordance with §105.55(a). A subpoena issued under this paragraph may be enforced in accordance with §105.55(b).

(c) *Notification.* Any person who is the subject of an Associate Administrator investigation and who is requested to furnish information or documentary evidence is notified as to the general purpose for which the information or evidence is sought.

(d) *Termination.* When the facts disclosed by an investigation indicate that further action is unnecessary or unwarranted at that time, the person being investigated is notified and the investigative file is closed without prejudice to further investigation by the Associate Administrator.

(e) *Confidentiality.* Information received in an investigation under this section, including the identity of the person investigated and any other person who provides information during the investigation, shall remain confidential under the investigatory file exception, or other appropriate exception, to the public disclosure requirements of 5 U.S.C. 552.

[Amdt. 107-11, 48 FR 2651, Jan. 20, 1983, as amended by Amdt. 107-24, 56 FR 8621, Feb. 28, 1991; Amdt. 107-32, 59 FR 49131, Sept. 26, 1994; Amdt. 107-38, 61 FR 21099, May 9, 1996; 66 FR 45377, Aug. 28, 2001; 67 FR 61011, Sept. 27, 2002; 73 FR 4711, Jan. 28, 2008; 76 FR 56311, Sept. 13, 2011]

COMPLIANCE ORDERS AND CIVIL
PENALTIES

§ 107.307 General.

(a) When the Associate Administrator and the Office of Chief Counsel have reason to believe that a person is knowingly engaging or has knowingly engaged in conduct which is a violation of the Federal hazardous material transportation law or any provision of this subchapter or subchapter C of this chapter, or any exemption, special permit, or order issued thereunder, for which the Associate Administrator or the Office of Chief Counsel exercise enforcement authority, they may—

(1) Issue a warning letter, as provided in §107.309;

(2) Initiate proceedings to assess a civil penalty, as provided in either §107.310 or §107.311;

§ 107.309

49 CFR Ch. I (10–1–14 Edition)

(3) Issue an order directing compliance, regardless of whether a warning letter has been issued or a civil penalty assessed; and

(4) Seek any other remedy available under the Federal hazardous material transportation law.

(b) In the case of a proceeding initiated for failure to comply with an exemption or special permit, the allegation of a violation of a term or condition thereof is considered by the Associate Administrator and the Office of Chief Counsel to constitute an allegation that the special permit holder or party to the special permit is failing, or has failed to comply with the underlying regulations from which relief was granted by the special permit.

[Amdt. 107–11, 48 FR 2651, Jan. 20, 1983, as amended by Amdt. 107–32, 59 FR 49131, Sept. 26, 1994; Amdt. 107–36, 61 FR 7183, Feb. 26, 1996; 66 FR 45377, Aug. 28, 2001; 70 FR 73162, Dec. 9, 2005]

§ 107.309 Warning letters.

(a) The Associate Administrator may issue a warning letter to any person whom the Associate Administrator believes to have committed a probable violation of the Federal hazardous material transportation law or any provision of this subchapter, subchapter C of this chapter, or any special permit issued thereunder.

(b) A warning letter issued under this section includes:

(1) A statement of the facts upon which the Associate Administrator bases its determination that the person has committed a probable violation;

(2) A statement that the recurrence of the probable violations cited may subject the person to enforcement action; and

(3) An opportunity to respond to the warning letter by submitting pertinent information or explanations concerning the probable violations cited therein.

[Amdt. 107–11, 48 FR 2651, Jan. 20, 1983, as amended by Amdt. 107–15, 51 FR 34986, Oct. 1, 1986; Amdt. 107–24, 56 FR 8621, Feb. 28, 1991; Amdt. 107–32, 59 FR 49131, Sept. 26, 1994; Amdt. 107–36, 61 FR 7183, Feb. 26, 1996; 66 FR 45377, Aug. 28, 2001]

§ 107.310 Ticketing.

(a) For an alleged violation that does not have a direct or substantial impact on safety, the Associate Administrator may issue a ticket.

(b) The Associate Administrator issues a ticket by mailing it by certified or registered mail to the person alleged to have committed the violation. The ticket includes:

(1) A statement of the facts on which the Associate Administrator bases the conclusion that the person has committed the alleged violation;

(2) The maximum penalty provided for by statute, the proposed full penalty determined according to PHMSA's civil penalty guidelines and the statutory criteria for penalty assessment, and the ticket penalty amount; and

(3) A statement that within 45 days of receipt of the ticket, the person must pay the penalty in accordance with paragraph (d) of this section, make an informal response under § 107.317, or request a formal administrative hearing under § 107.319.

(c) If the person makes an informal response or requests a formal administrative hearing, the Associate Administrator forwards the inspection report, ticket and response to the Office of the Chief Counsel for processing under §§ 107.307–107.339, except that the Office of the Chief Counsel will not issue a Notice of Probable Violation under § 107.311. The Office of the Chief Counsel may impose a civil penalty that does not exceed the proposed full penalty set forth in the ticket.

(d) Payment of the ticket penalty amount must be made in accordance with the instructions on the ticket.

(e) If within 45 days of receiving the ticket the person does not pay the ticket amount, make an informal response, or request a formal administrative hearing, the person has waived the right to make an informal response or request a hearing, has admitted the violation and owes the ticket penalty amount to PHMSA.

[Amdt. 107–36, 61 FR 7183, Feb. 26, 1996, as amended at 66 FR 45377, Aug. 28, 2001]

§ 107.311 Notice of probable violation.

(a) The Office of Chief Counsel may serve a notice of probable violation on

a person alleging the violation of one or more provisions of the Federal hazardous material transportation law or any provision of this subchapter or subchapter C of this chapter, or any special permit, or order issued thereunder.

(b) A notice of probable violation issued under this section includes the following information:

(1) A citation of the provisions of the Federal hazardous material transportation law, an order issued thereunder, this subchapter, subchapter C of this chapter, or the terms of any special permit issued thereunder which the Office of Chief Counsel believes the respondent is violating or has violated.

(2) A statement of the factual allegations upon which the demand for remedial action, a civil penalty, or both, is based.

(3) A statement of the respondent's right to present written or oral explanations, information, and arguments in answer to the allegations and in mitigation of the sanction sought in the notice of probable violation.

(4) A statement of the respondent's right to request a hearing and the procedures for requesting a hearing.

(5) In addition, in the case of a notice of probable violation proposing a compliance order, a statement of the proposed actions to be taken by the respondent to achieve compliance.

(6) In addition, in the case of a notice of probable violation proposing a civil penalty:

(i) A statement of the maximum civil penalty for which the respondent may be liable;

(ii) The amount of the preliminary civil penalty being sought by the Office of Chief Counsel, constitutes the maximum amount the Chief Counsel may seek throughout the proceeding; and

(iii) A description of the manner in which the respondent makes payment of any money due the United States as a result of the proceeding.

(c) The Office of Chief Counsel may amend a notice of probable violation at any time before issuance of a compliance order or an order assessing a civil penalty. If the Office of Chief Counsel alleges any new material facts or seeks new or additional remedial action or an increase in the amount of the proposed

civil penalty, it issues a new notice of probable violation under this section.

[Amdt. 107-11, 48 FR 2651, Jan. 20, 1983, as amended at 50 FR 45730, Nov. 1, 1985; Amdt. 107-24, 56 FR 8624, Feb. 28, 1991; Amdt. 107-32, 59 FR 49131, Sept. 26, 1994; Amdt. 107-35, 60 FR 49108, Sept. 21, 1995; Amdt. 107-36, 61 FR 7184, Feb. 26, 1996]

§ 107.313 Reply.

(a) Within 30 days of receipt of a notice of probable violation, the respondent must either:

(1) Admit the violation under § 107.315;

(2) Make an informal response under § 107.317; or

(3) Request a hearing under § 107.319.

(b) Failure of the respondent to file a reply as provided in this section constitutes a waiver of the respondent's right to appear and contest the allegations and authorizes the Chief Counsel, without further notice to the respondent, to find the facts to be as alleged in the notice of probable violation and issue an order directing compliance or assess a civil penalty, or, if proposed in the notice, both. Failure to request a hearing under paragraph (a)(3) of this section constitutes a waiver of the respondent's right to a hearing.

(c) Upon the request of the respondent, the Office of Chief Counsel may, for good cause shown and filed within the 30 days prescribed in the notice of probable violation, extend the 30-day response period.

§ 107.315 Admission of violations.

(a) In responding to a notice of probable violation issued under § 107.311, the respondent may admit the alleged violations and agree to accept the terms of a proposed compliance order or to pay the amount of the preliminarily assessed civil penalty, or, if proposed in the notice, both.

(b) If the respondent agrees to the terms of a proposed compliance order, the Chief Counsel issues a final order prescribing the remedial action to be taken by the respondent.

(c) Payment of a civil penalty, when the amount of the penalty exceeds \$10,000, must be made by wire transfer, through the Federal Reserve Communications System (Fedwire), to the account of the U.S. Treasury. Detailed

§ 107.317

instructions on making payments by wire transfer may be obtained from the Financial Operations Division (AMZ-120), Federal Aviation Administration, Mike Monroney Aeronautical Center, P.O. Box 25082, Oklahoma City, OK 73125.

(d) Payment of a civil penalty, when the amount of the penalty is \$10,000 or less, must be made either by wire transfer, as set forth in paragraph (c) of this section, or certified check or money order payable to "U.S. Department of Transportation" and submitted to the Financial Operations Division (AMZ-120), Federal Aviation Administration, Mike Monroney Aeronautical Center, P.O. Box 25082, Oklahoma City, OK 73125.

[Amdt. 107-11, 48 FR 2651, Jan. 20, 1983, as amended by Amdt. 107-23, 57 FR 45453, Oct. 1, 1992; Amdt. 107-29, 58 FR 51527, Oct. 1, 1993; Amdt. 107-38, 61 FR 21100, May 9, 1996; 68 FR 52848, Sept. 8, 2003]

§ 107.317 Informal response.

(a) In responding to a notice of probable violation under §107.311, the respondent may submit to the official who issued the notice, written explanations, information, or arguments in response to the allegations, the terms of a proposed compliance order, or the amount of the preliminarily assessed civil penalty.

(b) The respondent may include in his informal response a request for a conference. Upon the request of the respondent, the conference may be either in person or by telephone. A request for a conference must set forth the issues the respondent will raise at the conference.

(c) Upon receipt of a request for a conference under paragraph (b) of this section, the Chief Counsel's Office, in consultation with the Associate Administrator, arranges for a conference as soon as practicable at a time and place of mutual convenience.

(d) The respondent's written explanations, information, and arguments as well as the respondent's presentation at a conference are considered by the Chief Counsel in reviewing the notice of probable violation. Based upon a review of the proceeding, the Chief Counsel may dismiss the notice of probable violation in whole or in part. If he does

49 CFR Ch. I (10-1-14 Edition)

not dismiss it in whole, he issues an order directing compliance or assessing a civil penalty, or, if proposed in the notice, both.

[Amdt. 107-11, 48 FR 2651, Jan. 20, 1983, as amended by Amdt. 107-23, 56 FR 66157, Dec. 20, 1991; 66 FR 45377, Aug. 28, 2001]

§ 107.319 Request for a hearing.

(a) In responding to a notice of probable violation under §107.311, the respondent may request a formal administrative hearing on the record before an Administrative Law Judge (ALJ) obtained by the Office of the Chief Counsel.

(b) A request for a hearing under paragraph (a) of this section must:

(1) State the name and address of the respondent and of the person submitting the request if different from the respondent;

(2) State which allegations of violations, if any, are admitted; and

(3) State generally the issues to be raised by the respondent at the hearing. Issues not raised in the request are not barred from presentation at the hearing; and

(4) Be addressed to the official who issued the notice.

(c) After a request for a hearing that complies with the requirements of paragraph (b) of this section, the Chief Counsel obtains an ALJ to preside over the hearing and notifies the respondent of this fact. Upon assignment of an ALJ, further matters in the proceeding generally are conducted by and through the ALJ, except that the Chief Counsel and respondent may compromise or settle the case under §107.327 of this subpart without order of the ALJ or voluntarily dismiss the case under Rule 41(a)(1) of the Federal Rules of Civil Procedure without order of the ALJ; in the event of such a compromise, settlement or dismissal, the Chief Counsel expeditiously will notify the ALJ thereof.

(d) At any time after requesting a formal administrative hearing but prior to the issuance of a decision and final order by the ALJ, the respondent may withdraw such request in writing, thereby terminating the jurisdiction

of the ALJ in the case. Such a withdrawal constitutes an irrevocable waiver of respondent's right to such a hearing on the facts, allegations, and proposed sanction presented in the notice of probable violation to which the request for hearing relates.

[Amdt. 107-11, 48 FR 2651, Jan. 20, 1983, as amended at 48 FR 17094, Apr. 21, 1983; Amdt. No. 107-19, 54 FR 22899, May 30, 1989]

§ 107.321 Hearing.

(a) To the extent practicable, the hearing is held in the general vicinity of the place where the alleged violation occurred or at a place convenient to the respondent. Testimony by witnesses shall be given under oath and the hearing shall be recorded verbatim.

(b) Hearings are conducted in accordance with the Federal Rules of Evidence and Federal Rules of Civil Procedure; however, the ALJ may modify them as he determines necessary in the interest of a full development of the facts. In addition, the ALJ may:

- (1) Administer oaths and affirmations;
- (2) Issue subpoenas as provided by § 105.45;
- (3) Adopt procedures for the submission of motions, evidence, and other documents pertinent to the proceeding;
- (4) Take or cause depositions to be taken;
- (5) Rule on offers of proof and receive relevant evidence;
- (6) Examine witnesses at the hearing;
- (7) Convene, recess, reconvene, adjourn and otherwise regulate the course of the hearing;
- (8) Hold conferences for settlement, simplification of the issues, or any other proper purpose; and
- (9) Take any other action authorized by, or consistent with, the provisions of this subpart and permitted by law which may expedite the hearing or aid in the disposition of an issue raised therein.

(c) The official who issued the notice of probable violation, or his representative, has the burden of proving the facts alleged therein.

(d) The respondent may appear and be heard on his own behalf or through counsel of his choice. The respondent or his counsel may offer relevant information including testimony which he

believes should be considered in opposition to the allegations or which may bear on the sanction being sought and conduct such cross-examination as may be required for a full disclosure of the facts.

[Amdt. 107-11, 48 FR 2651, Jan. 20, 1983, as amended at 67 FR 61011, Sept. 27, 2002]

§ 107.323 ALJ's decision.

(a) After consideration of all matters of record in the proceeding, the ALJ shall issue an order dismissing the notice of probable violation in whole or in part or granting the sanction sought by the Office of Chief Counsel in the notice. If the ALJ does not dismiss the notice of probable violation in whole, he issues an order directing compliance or assessing a civil penalty, or, if proposed in the notice, both. The order includes a statement of the findings and conclusions, and the reasons therefore, on all material issues of fact, law, and discretion.

(b) If, within 20 days of receipt of an order issued under paragraph (a) of this section, the respondent does not submit in writing his acceptance of the terms of an order directing compliance, or, where appropriate, pay a civil penalty, or file an appeal under § 107.325, the case may be referred to the Attorney General with a request that an action be brought in the appropriate United States District Court to enforce the terms of a compliance order or collect the civil penalty.

§ 107.325 Appeals.

(a) *Hearing proceedings.* A party aggrieved by an ALJ's decision and order issued under § 107.323, may file a written appeal in accordance with paragraph (c) of this section with the Administrator, Office of the Administrator, Pipeline and Hazardous Materials Safety Administration, East Building, 1200 New Jersey Avenue, SE., Washington, DC 20590-0001.

(b) *Non-Hearing proceedings.* A respondent aggrieved by an order issued under § 107.317, may file a written appeal in accordance with paragraph (c) of this section with the Administrator, Office of the Administrator, Pipeline and Hazardous Materials Safety Administration, East Building, 1200 New

§ 107.327

Jersey Avenue, SE., Washington, DC 20590-0001.

(c) An appeal of an order issued under this subpart must:

(1) Be filed within 20 days of receipt of the order by the appealing party; and

(2) State with particularity the findings in the order that the appealing party challenges, and include all information and arguments pertinent thereto.

(d) If the Administrator, PHMSA, affirms the order in whole or in part, the respondent must comply with the terms of the decision within 20 days of the respondent's receipt thereof, or within the time prescribed in the order. If the respondent does not comply with the terms of the decision within 20 days of receipt, or within the time prescribed in the order, the case may be referred to the Attorney General for action to enforce the terms of the decision.

(e) The filing of an appeal stays the effectiveness of an order issued under §107.317 or §107.323. However, if the Administrator, PHMSA, determines that it is in the public interest, he may keep an order directing compliance in force pending appeal.

[70 FR 56090, Sept. 23, 2005, as amended at 72 FR 55683, Oct. 1, 2007]

§ 107.327 **Compromise and settlement.**

(a) At any time before an order issued under §107.317 or §107.323 is referred to the Attorney General for enforcement, the respondent or the Office of Chief Counsel may propose a compromise as follows:

(1) In civil penalty cases, the respondent or Chief Counsel may offer to compromise the amount of the penalty by submitting an offer for a specific amount to the other party. An offer of compromise by the respondent shall be submitted to the Chief Counsel who may, after consultation with the Associate Administrator, accept or reject it.

(i) A compromise offer stays the running of any response period then outstanding.

(ii) If a compromise is agreed to by the parties, the respondent is notified in writing. Upon receipt of payment by Office of Chief Counsel, the respondent

49 CFR Ch. I (10-1-14 Edition)

is notified in writing that acceptance of payment is in full satisfaction of the civil penalty proposed or assessed, and Office of Chief Counsel closes the case with prejudice to the respondent.

(iii) If a compromise cannot be agreed to, the respondent is notified in writing and is given 10 days or the amount of time remaining in the then outstanding response period, whichever is longer, to respond to whatever action was taken by the Office of Chief Counsel or the Administrator, PHMSA.

(2) In compliance order cases, the respondent may propose a consent agreement to the Chief Counsel. If the Chief Counsel accepts the agreement, he issues an order in accordance with its terms. If the Chief Counsel rejects the agreement, he directs that the proceeding continue. An agreement submitted to the Chief Counsel must include:

(i) A statement of any allegations of fact which the respondent challenges;

(ii) The reasons why the terms of a compliance order or proposed compliance order are or would be too burdensome for the respondent, or why such terms are not supported by the record in the case;

(iii) A proposed compliance order suitable for issuance by the Chief Counsel;

(iv) An admission of all jurisdictional facts; and

(v) An express waiver of further procedural steps and all right to seek judicial review or otherwise challenge or contest the validity of the order.

(b) Notwithstanding paragraph (a)(1) of this section, the respondent or Office of Chief Counsel may propose to settle the case. If the Chief Counsel agrees to a settlement, the respondent is notified and the case is closed without prejudice to the respondent.

[Amdt. 107-11, 48 FR 2651, Jan. 20, 1983, as amended at 50 FR 45730, Nov. 1, 1985; Amdt. 107-24, 56 FR 8621, Feb. 28, 1991; 56 FR 15510, Apr. 17, 1991; Amdt. 107-29, 58 FR 51527, Oct. 1, 1993; 66 FR 45377, Aug. 28, 2001]

§ 107.329 **Maximum penalties.**

(a) A person who knowingly violates a requirement of the Federal hazardous material transportation law, an order issued thereunder, this subchapter,

subchapter C of the chapter, or a special permit or approval issued under this subchapter applicable to the transportation of hazardous materials or the causing of them to be transported or shipped is liable for a civil penalty of not more than \$75,000 for each violation, except the maximum civil penalty is \$175,000 if the violation results in death, serious illness or severe injury to any person or substantial destruction of property. There is no minimum civil penalty, except for a minimum civil penalty of \$450 for violations relating to training. When the violation is a continuing one, each day of the violation constitutes a separate offense.

(b) A person who knowingly violates a requirement of the Federal hazardous material transportation law, an order issued thereunder, this subchapter, subchapter C of the chapter, or a special permit or approval issued under this subchapter applicable to the design, manufacture, fabrication, inspection, marking, maintenance, reconditioning, repair or testing of a package, container, or packaging component which is represented, marked, certified, or sold by that person as qualified for use in the transportation of hazardous materials in commerce is liable for a civil penalty of not more than \$75,000 for each violation, except the maximum civil penalty is \$175,000 if the violation results in death, serious illness or severe injury to any person or substantial destruction of property. There is no minimum civil penalty, except for a minimum civil penalty of \$450 for violations relating to training.

[78 FR 22800, Apr. 17, 2013]

§ 107.331 Assessment considerations.

After finding a knowing violation under this subpart, the Office of Chief Counsel assesses a civil penalty taking the following into account:

- (a) The nature and circumstances of the violation;
- (b) The extent and gravity of the violation;
- (c) The degree of the respondent's culpability;
- (d) The respondent's prior violations;
- (e) The respondent's ability to pay;
- (f) The effect on the respondent's ability to continue in business; and

(g) Such other matters as justice may require.

[Amdt. 107-11, 48 FR 2651, Jan. 20, 1983, as amended by Amdt. 107-30, 58 FR 50500, Sept. 27, 1993; Amdt. 107-38, 61 FR 21100, May 9, 1996]

CRIMINAL PENALTIES

§ 107.333 Criminal penalties generally.

A person who knowingly violates §171.2(1) of this title or willfully or recklessly violates a requirement of the Federal hazardous material transportation law or a regulation, order, special permit, or approval issued thereunder shall be fined under title 18, United States Code, or imprisoned for not more than 5 years, or both, except the maximum amount of imprisonment shall be 10 years in any case in which the violation involves the release of a hazardous material which results in death or bodily injury to any person.

[71 FR 8487, Feb. 17, 2006]

§ 107.335 Referral for prosecution.

If the Associate Administrator becomes aware of a possible willful violation of the Federal hazardous material transportation law, this subchapter, subchapter C of this chapter, or any special permit, or order issued thereunder, for which the Associate Administrator exercises enforcement responsibility, it shall report it to the Office of the Chief Counsel, Pipeline and Hazardous Materials Safety Administration, U.S. Department of Transportation, Washington, DC 20590-0001. If appropriate, the Chief Counsel refers the report to the Department of Justice for criminal prosecution of the offender.

[Amdt. 107-11, 48 FR 2651, Jan. 20, 1983, as amended by Amdt. 107-22, 55 FR 39978, Oct. 1, 1990; Amdt. 107-24, 56 FR 8621, Feb. 28, 1991; 56 FR 15510, Apr. 17, 1991; Amdt. 107-32, 59 FR 49131, Sept. 26, 1994; Amdt. 107-35, 60 FR 49108, Sept. 21, 1995; 66 FR 45377, Aug. 28, 2001]

§ 107.336 Limitation on fines and penalties.

If a State or political subdivision or Indian tribe assesses any fine or penalty determined by the Secretary to be appropriate for a violation concerning a subject listed in §107.202(a), no additional fine or penalty may be assessed

§ 107.337

for such violation by any other authority.

[Amdt. 107-24, 56 FR 8624, Feb. 28, 1991]

INJUNCTIVE ACTION

§ 107.337 Injunctions generally.

Whenever it appears to the Office of Chief Counsel that a person has engaged, or is engaged, or is about to engage in any act or practice constituting a violation of any provision of the Federal hazardous material transportation law, this subchapter, subchapter C of this chapter, or any special permit, or order issued thereunder, for which the Office of Chief Counsel exercises enforcement responsibility, the Administrator, PHMSA, or his delegate, may request the Attorney General to bring an action in the appropriate United States District Court for such relief as is necessary or appropriate, including mandatory or prohibitive injunctive relief, interim equitable relief, and punitive damages as provided by 49 U.S.C. 5122(a).

[Amdt. 107-11, 48 FR 2651, Jan. 20, 1983, as amended by Amdt. 107-32, 59 FR 49131, Sept. 26, 1994]

§ 107.338 Prohibition of hazardous materials operations.

As provided for in subpart E of part 109 of this subchapter, a person who fails to pay a civil penalty in accordance with agreed upon installments or in full within prescribed time lines, is prohibited from conducting hazardous materials operations and shall immediately

49 CFR Ch. I (10-1-14 Edition)

cease all hazardous materials operations.

[79 FR 46199, Aug. 7, 2014]

§ 107.339 Imminent hazards.

Whenever it appears to the Office of the Chief Counsel that there is a substantial likelihood that death, serious illness, or severe personal injury will result from the transportation of a particular hazardous material or hazardous materials container, before a compliance order proceeding or other administrative hearing or formal proceeding to abate the risk of that harm can be completed, the Administrator, PHMSA, or his delegate, may bring an action under 49 U.S.C. 5122(b) in the appropriate United States District Court for an order suspending or restricting the transportation of that hazardous material or those containers or for such other equitable relief as is necessary or appropriate to ameliorate the hazard.

[Amdt. 107-11, 48 FR 2651, Jan. 20, 1983, as amended by Amdt. 107-15, 51 FR 34987, Oct. 1, 1986; Amdt. 107-32, 59 FR 49131, Sept. 26, 1994]

APPENDIX A TO SUBPART D OF PART 107—GUIDELINES FOR CIVIL PENALTIES

I. This appendix sets forth the guidelines PHMSA uses (as of October 2, 2013) in making initial baseline determinations for civil penalties. The first part of these guidelines is a list of baseline amounts or ranges for frequently-cited probable violations. Following the list of violations are general guidelines PHMSA uses in making penalty determinations in enforcement cases.

II. LIST OF FREQUENTLY CITED VIOLATIONS

Violation description	Section or cite	Baseline assessment
General Requirements		
A. Registration Requirements: Failure to register as an offeror or carrier of hazardous material and pay registration fee:	107.608, 107.612.	
1. Small business or not-for-profit	\$1,200 + \$600 each additional year.
2. All others	\$3,500 + \$1,000 each additional year.
B. Training Requirements:		
1. Failure to provide initial training to hazmat employees (general awareness, function-specific, safety, and security awareness training):	172.702.	
a. More than 10 hazmat employees	\$1,500 for each area.
b. 10 hazmat employees or fewer	\$1,000 for each area.

Violation description	Section or cite	Baseline assessment
2. Failure to provide recurrent training to hazmat employees (general awareness, function-specific, safety, and security awareness training).	172.702	\$1,000 for each area.
3. Failure to provide in-depth security training when a security plan is required but has not been developed.	172.702	Included in penalty for no security plan.
4. Failure to provide in-depth security training when a security plan is required and has been developed.	172.702	\$3,100.
5. Failure to create and maintain training records:	172.704.	
a. More than 10 hazmat employees	\$1,000.
b. 10 hazmat employees or fewer	\$600.
C. Security Plans:		
1. Failure to develop a security plan; failure to adhere to security plan:	172.800.	
a. Section 172.504 Table 1 materials	\$9,300.
b. Packing Group I	\$7,500.
c. Packing Group II	\$5,600.
d. Packing Group III	\$3,700.
2. Incomplete security plan or incomplete adherence (one or more of four required elements missing).	One-quarter (25 percent) of above for each element.
3. Failure to update a security plan to reflect changing circumstances.	172.802(b)	One-third (33 percent) of baseline for no plan.
4. Failure to put security plan in writing; failure to make all copies identical.	172.800(b)	One-third (33 percent) of baseline for no plan.
D. Notification to a Foreign Shipper: Failure to provide a foreign offeror or forwarding agent written information of HMR requirements applicable to a shipment of hazardous materials within the United States, at the place of entry into the United States:	171.22(f).	
1. Packing Group I and § 172.504 Table 1 materials	\$9,300.*
2. Packing Group II	\$5,500.*
3. Packing Group III	\$1,800.*

*The baseline applied to the importer shall be equal to or less than the baseline applied to the foreign offeror or forwarding agent.

Violation description	Section or cite	Baseline assessment
E. Special Permits and Approvals:		
1. Offering or transporting a hazardous material, or otherwise performing a function covered by a special permit or approval, without authorization:	171.2.	
a. After the special permit or approval has expired.	\$1,200 + \$600 for each additional year.
b. After the special permit or approval has been terminated.	\$5,000 to \$25,000.
2. Failure to comply with a provision of a special permit or approval (when no other baseline is applicable):	171.2.	
a. That relates to safety	\$4,000 and up.
b. That does not relate to safety	\$500 and up.
3. Failure to maintain a copy of the special permit in the transport vehicle or facility, when required by the terms of the special permit.	Special Permit	\$1,000.
4. Use an approval or approval symbol issued to another person.	Approval, Various	\$9,000.

Offeror Requirements—All hazardous materials

A. Undeclared Shipment:	172.200, 172.300, 172.400, 172.500.	
1. Offering for transportation a hazardous material without shipping papers, package markings, labels, and placards (where required):		
a. Packing Group I and § 172.504 Table 1 materials.	\$30,000 and up.
b. Packing Group II	\$20,000.
c. Packing Group III	\$17,500.
d. Consumer Commodity, ORM-D	\$5,000.
2. Offering for transportation a hazardous material that is misclassified on the shipping paper, markings, labels, and placards (including improper treatment as consumer commodity, ORM-D):		

Violation description	Section or cite	Baseline assessment
a. Packing Group I and § 172.504 Table I materials.	\$20,000.
b. Packing Group II	\$12,000.
c. Packing Group III	\$8,000.
3. Offering for transportation a forbidden hazardous material:		
a. Packing Group I and § 172.504 Table I materials.	\$35,000.
b. Packing Group II	\$25,000.
c. Packing Group III	\$20,000.
4. Offering for transportation a lithium battery, without shipping papers, package markings, labels, or placards (when required):		
a. For air transport	\$40,000.
b. For ground transport	\$20,000.
B. Shipping Papers:		
1. Failure to provide a shipping paper for a shipment of hazardous materials or accepting hazardous materials for transportation without a shipping paper:	172.201, 177.817(a).	
a. Packing Group I and § 172.504 Table 1 materials.	\$7,500.
b. Packing Group II	\$5,600.
c. Packing Group III	\$3,700.
2. Failure to follow one or more of the three approved formats for listing hazardous materials and non-hazardous materials on a shipping paper.	172.201(a)(1)	\$1,500.
3. Failure to retain shipping papers as required	172.201(e)	\$1,200.
4. Failure to include a proper shipping name in the shipping description or using an incorrect proper shipping name:	172.202.	
a. Packing Group I and § 172.504 Table 1 materials.	\$2,000.
b. Packing Group II	\$1,500.
c. Packing Group III	\$1,000.
5. Failure to include a hazard class/division number in the shipping description:	172.202.	
a. Packing Group I and § 172.504 Table 1 materials.	\$2,000.
b. Packing Group II	\$1,500.
c. Packing Group III	\$1,000.
6. Failure to include an identification number in the shipping description:	172.202.	
a. Packing Group I and § 172.504 Table 1 materials.	\$2,500.
b. Packing Group II	\$1,800.
c. Packing Group III	\$1,200.
7. Using an incorrect hazard class:	172.202.	
a. That does not affect compatibility requirements.	\$1,000.
b. That affects compatibility requirements:		
i. Packing Group I and § 172.504 Table 1 materials.	\$7,500.
ii. Packing Group II	\$5,600.
iii. Packing Group III	\$3,700.
8. Using an incorrect identification number:	172.202.	
a. That does not change the response information.	\$1,000.
b. That changes response information:		
i. Packing Group I and § 172.504 Table 1 materials.	\$7,500.
ii. Packing Group II	\$5,600.
iii. Packing Group III	\$3,700.
9. Failure to include the Packing Group or using an incorrect Packing Group:	172.202.	
a. Packing Group I and § 172.504 Table 1 materials.	\$1,700.
b. Packing Group II and III	\$1,300.
10. Using a shipping description that includes additional unauthorized information (extra or incorrect words).	172.202	\$1,000.
11. Using a shipping description not in required sequence.	172.202	\$600.

Violation description	Section or cite	Baseline assessment
12. Failure to include the total quantity of hazardous material covered by a shipping description (including net explosive mass).	172.202	\$600.
13. Failure to include any of the following on a shipping paper, as required: Special permit number; "Limited Quantity or "Ltd Qty;" "RQ" for a hazardous substance; technical name in parentheses for a listed generic or "n.o.s." material; or marine pollutant.	172.203(a), (b), (c)(2), (k), (l) ..	\$600.
14. Failure to indicate poison inhalation hazard on a shipping paper.	172.203(m)	\$2,500.
15. Failure to include or sign the required shipper's certification on a shipping paper.	172.204	\$1,000.
C. Emergency Response Information Requirements:		
1. Providing incorrect emergency response information with or on a shipping paper:	172.602.	
a. No significant difference in response	\$1,000.
b. Significant difference in response:		
i. Packing Group I and § 172.504 Table 1 materials.	\$7,500.
ii. Packing Group II	\$5,600.
iii. Packing Group III	\$3,700.
2. Failure to include an emergency response telephone number on a shipping paper.	172.604	\$3,200.
3. Failure to have the emergency response telephone number monitored while a hazardous material is in transportation; or listing the number in a manner that it is not readily identifiable or cannot be found easily and quickly (e.g., multiple telephone numbers); or failing to include the name, contract number, or other unique identifier of the person registered with the emergency response provider.	172.604	\$1,600.
4. Listing an emergency response telephone number on a shipping paper that causes emergency responders delay in obtaining emergency response information (e.g., listing a telephone number that not working, incorrect, or otherwise not capable of providing required information).	172.604	\$3,200 to \$5,200
D. Package Marking Requirements:		
1. Failure to mark the proper shipping name and identification number on a package:	172.301(a).	
a. Packing Group I and § 172.504 Table 1 materials.	\$6,000.
b. Packing Group II	\$4,500.
c. Packing Group III	\$3,000.
2. Marking a package with an incorrect shipping name and identification number:	172.301(a).	
a. That does not change the response information:		
i. Packing Group I and § 172.504 Table 1 materials.	\$3,700.
ii. Packing Group II	\$2,700.
iii. Packing Group III	\$2,200.
b. That changes the response information:		
i. Packing Group I and § 172.504 Table 1 materials.	\$9,500.
ii. Packing Group II	\$7,100.
iii. Packing Group III	\$4,700.
3. Failure to mark the proper shipping name on a package or marking an incorrect shipping name on a package:	172.301(a).	
a. Packing Group I and § 172.504 Table 1 materials.	\$2,000.
b. Packing Group II	\$1,500.
c. Packing Group III	\$1,000.
4. Failure to mark the identification number on a package:	172.301(a).	
a. Packing Group I and § 172.504 Table 1 materials.	\$2,500.
b. Packing Group II	\$1,800.
c. Packing Group III	\$1,200.
5. Marking a package with an incorrect identification number:	172.301(a).	

Violation description	Section or cite	Baseline assessment
a. That does not change the response information.	\$1,000.
b. That changes the response information:		
i. Packing Group I and § 172.504 Table 1 materials.	\$7,500.
ii. Packing Group II	\$5,600.
iii. Packing Group III	\$3,700.
6. Failure to include the required technical name(s) in parentheses for a listed generic or "n.o.s." entry.	172.301(c)	\$600.
7. Failure to mark "non-odorized" on a cylinder containing liquefied petroleum gas.	172.301(f)	\$2,000.
8. Marking a package as containing hazardous material when it contains no hazardous material.	172.303(a)	\$1,000.
9. Failure to locate required markings away from other markings that could reduce their effectiveness.	172.304(a)(4)	\$1,000.
10. Failure to mark a package containing liquid hazardous materials with required orientation markings:	172.312.	
a. Packing Group I and § 172.504 Table 1 materials.	\$4,000.
b. Packing Group II	\$3,500.
c. Packing Group III	\$3,000.
11. Failure to mark "Biohazard on an infectious substance or "Inhalation Hazard" on a package containing a poison by inhalation hazard.	172.313(a), 172.323	\$4,000.
12. Failure to apply limited quantity marking or "RQ" marking on a non-bulk package containing a hazardous substance.	172.315, 172.324(b)	\$600.
13. Listing the technical name of a select agent hazardous material when it should not be listed.	172.301(b)	\$1,600.
14. Failure to apply a "Keep away from heat," marine pollutant, or elevated temperature ("HOT") marking.	172.317, 172.322, 172.325	\$1,200.
15. Failure to properly mark a bulk container	172.331, 172.334, 172.336, 172.338.	\$1,000.
E. Package Labeling Requirements:		
1. Failure to label a package or applying a label that represents a hazard other than the hazard presented by the hazardous material in the package.	172.400	\$7,000.
2. Placing a label on a package that does not contain a hazardous material.	172.401(a)	\$1,000.
3. Failure to place a required subsidiary label on a package:..	172.402.	
a. Packing Group I and § 172.504 Table 1 materials.	\$3,100.
b. Packing Group II	\$1,800.
c. Packing Group III	\$600.
4. Placing a label on a different surface of the package than, or away from, the proper shipping name.	172.406(a)	\$1,000.
5. Placing an improper size label on a package	172.407(c)	\$1,000.
6. Placing a label on a package that does not meet color specification requirements (depending on the variance).	172.407(d)	\$1,000.
7. Failure to place a Cargo Aircraft Only label on a package intended for air transportation, when required.	172.402(c)	\$5,000.
8. Failure to place a Cargo Aircraft Only label on a package containing a primary lithium battery or failure to mark a package containing a primary lithium battery as forbidden for transport on passenger aircraft:	172.402(c), 172.102(c)(1) Special Provision 188, 189, 190.	
a. For air transport	\$10,000.
b. For ground transport	\$1,000.
9. Failure to provide an appropriate class or division number on an explosive label.	172.411	\$3,100.
F. Placarding Requirements:		
1. Improperly placarding a freight container or vehicle containing hazardous materials:	172.504.	
a. Packing Group I and § 172.504 Table 1 materials.	\$1,200 to \$11,200.
b. Packing Group II and III	\$1,000 to \$9,000.

Violation description	Section or cite	Baseline assessment
2. Failure to placard a freight container or vehicle containing hazardous materials (no placard at all):	172.504.	
a. Packing Group I and § 172.504 Table 1 materials.	\$12,000.
b. Packing Group II and III	\$8,500.
G. Packaging Requirements:		
1. Failure to comply with package testing requirements for small quantities, excepted quantities, de minimis, materials of trade, limited quantities, and ORM-D.	173.4, 173.4a, 173.4b, 173.6, 173.156, 173.306.	\$1,000 to \$5,000.
2. Offering a hazardous material for transportation in an unauthorized non-UN standard or non-specification packaging (includes failure to comply with the terms of a special permit authorizing use of a non-standard or non-specification packaging):	Various.	
a. Packing Group I, § 172.504 Table 1 materials, and Division 2.3 gases.	\$11,200.
b. Packing Group II and Divisions 2.1 and 2.2 gases.	\$8,700.
c. Packing Group III	\$6,200.
3. Offering a hazardous material for transportation in a package that was not retested as required:	Various.	
a. Packing Group I and § 172.504 Table 1 materials.	\$8,000.
b. Packing Group II	\$5,000.
c. Packing Group III	\$3,000.
4. Offering a hazardous material for transportation in an improper package:	Various.	
a. When Packing Group I material is packaged in a Packing Group III package.	\$8,000.
b. When Packing Group I material is packaged in a Packing Group II package.	\$5,000.
c. When Packing Group II material is packaged in a Packing Group III package.	\$3,000.
5. Offering a hazardous material for transportation in a packaging (including a packaging manufactured outside the United States) that is torn, damaged, has hazardous material present on the outside of the package, or is otherwise not suitable for shipment.	Various	\$7,500.
6. Offering a hazardous material for transportation in a self-certified packaging that has not been subjected to design qualification testing:	178.601, Various.	
a. Packing Group I and § 172.504 Table 1 materials.	\$13,500.
b. Packing Group II	\$10,500.
c. Packing Group III	\$7,500.
7. Offering a hazardous material for transportation in a packaging that has been successfully tested to an applicable UN standard but is not marked with the required UN marking (including missing specification plates).	173.32(d), 173.24(c)	\$4,500.
8. Failure to close a UN standard packaging in accordance with the closure instructions:	173.22(a)(4).	
a. Packing Group I and § 172.504 Table 1 materials.	\$2,000 to \$5,000.
b. Packing Group II	\$1,000 to \$4,000.
c. Packing Group III	\$500 to \$3,000.
9. Offering a hazardous material for transportation in a packaging that leaks during conditions normally incident to transportation:	173.24(b).	
a. Packing Group I and § 172.504 Table 1 materials.	\$16,500.
b. Packing Group II	\$11,200.
c. Packing Group III	\$7,500.
10. Overfilling or underfilling a package so that the effectiveness is substantially reduced:	173.24(b).	
a. Packing Group I and § 172.504 Table 1 materials.	\$11,200.
b. Packing Group II	\$7,500.
c. Packing Group III	\$3,700.
11. Failure to ensure packaging is compatible with hazardous material lading.	173.24(e)	\$9,000 to \$12,000.
12. Failure to mark an overpack as required	173.25(a)(4)	\$3,700.

Violation description	Section or cite	Baseline assessment
13. Packaging incompatible materials in an overpack	173.25(a)(5)	\$9,300.
14. Marking a package “overpack” when the inner packages do not meet the requirements of the HMR:	173.25(a).	
a. Packing Group I and § 172.504 Table 1 materials.		\$15,000.
b. Packing Group II		\$10,000.
c. Packing Group III		\$7,000.
15. Failure to comply with additional requirements for transportation by aircraft.	173.27	\$1,000 to \$10,000.
16. Filling an IBC, portable tank, or cargo tank (DOT, UN, or IM) that is out of test and offering hazardous materials for transportation in that IBC or portable tank. (Penalty amount depends on number of units and time out of test.).	173.32(a), 173.33(a)(3), 180.352, 180.407, 180.605.	
a. Packing Group I and § 172.504 Table 1 materials:		
i. All testing overdue		\$8,700.
ii. Only periodic (5 year) tests overdue or only intermediate periodic (2.5 year) tests overdue.		\$4,600.
b. Packing Group II:		
i. All testing overdue		\$6,600.
ii. Only periodic (5 year) tests overdue or only intermediate periodic (2.5 year) tests overdue.		\$3,300.
c. Packing Group III:		
i. All testing overdue		\$4,600.
ii. Only periodic (5 year) tests overdue or only intermediate periodic (2.5 year) tests overdue.		\$2,300.
17. Manifolding cylinders without conforming to manifolding requirements.	173.301(g)	\$3,700 and up.
18. Failure to ensure a cargo tank motor vehicle in metered delivery service has an operational off-truck remote shut-off activation device.	173.315(n)(3)	\$2,500.
19. Offering a hazardous material in a cargo tank motor vehicle when the material does not meet compatibility requirements with the tank or other lading or residue.	173.33	\$15,000.
20. Failure to provide the required outage in a portable tank that results in a release of hazardous materials:.	173.32(f)(6).	
a. Packing Group I and § 172.504 Table 1 materials.		\$15,000.
b. Packing Group II		\$11,200.
c. Packing Group III		\$7,500.
Offeror Requirements—Specific hazardous materials		
A. Cigarette Lighters:		
1. Offering for transportation an unapproved cigarette lighter, lighter refill, or similar device, equipped with an ignition element and containing fuel.	173.21(i)	\$7,500.
2. Failure to include the cigarette lighter test report identifier on the shipping paper.	173.308(d)(1)	\$1,000.
3. Failure to mark the approval number on the package.	173.308(d)(2)	\$1,000.
B. Class 1—Explosives:		
1. Failure to mark the package with the EX number for each substance contained in the package or, alternatively, indicate the EX number for each substance in association with the description on the shipping description.	172.320	\$1,000.
2. Offering an unapproved explosive for transportation:.	173.54, 173.56(b).	
a. Division 1.4 fireworks meeting the chemistry requirements of APA Standard 87–1.		\$5,000.
b. Division 1.3 fireworks meeting the chemistry requirements of APA Standard 87–1.		\$7,500.
c. All other explosives (including forbidden)		\$12,500 and up.

Violation description	Section or cite	Baseline assessment
3. Offering an unapproved explosive for transportation that minimally deviates from an approved design in a manner that does not impact safety:	173.54, 173.56(b).	
a. Division 1.4	\$3,000.
b. Division 1.3	\$4,000.
c. All other explosives	\$6,000.
4. Offering a leaking or damaged package of explosives for transportation:	173.54(c).	
a. Division 1.3 and 1.4	\$12,500.
b. All other explosives	\$16,500.
5. Offering a Class 1 material that is fitted with its own means of ignition or initiation, without providing protection from accidental actuation.	173.60(b)(5)	\$15,000.
6. Packaging explosives in the same outer packaging with other materials.	173.61	\$9,300.
7. Transporting a detonator on the same vehicle as incompatible materials using the approved method listed in 177.835(g)(3) without meeting the requirements of IME Standard 22.	177.835(g)(3)	\$10,000.
C. Class 7—Radioactive Materials:		
1. Failure to include required additional entries for radioactive material on a shipping paper, or providing incorrect information for these additional entries.	172.203(d)	\$2,000 to \$5,000.
2. Failure to mark the gross mass on the outside of a package of Class 7 material that exceeds 110 pounds.	172.310(a)	\$1,000.
3. Failure to mark each package with the words "Type A" or "Type B," as appropriate.	172.310(b)	\$3,700.
4. Placing a label on Class 7 material that understates the proper label category.	172.403	\$6,200.
5. Placing a label on Class 7 material that fails to contain (or has erroneous) entries for the name of the radionuclide(s), activity, and transport index.	172.403(g)	\$2,000 to \$5,000.
6. Failure to meet one or more of the general design requirements for a package used to ship a Class 7 material.	173.410	\$6,200.
7. Failure to comply with the industrial packaging (IP) requirements when offering a Class 7 material for transportation.	173.411	\$6,200.
8. Failure to provide a tamper-indicating device on a Type A package used to ship a Class 7 material.	173.412(a)	\$5,000.
9. Failure to meet the additional design requirements of a Type A package used to ship a Class 7 material.	173.412(b)–(i)	\$6,200.
10. Failure to meet the performance requirements for a Type A package used to ship a Class 7 material.	173.412(j)–(l)	\$11,200.
11. Offering a DOT specification 7A packaging without maintaining complete documentation of tests and an engineering evaluation or comparative data:	173.415(a), 173.461.	
a. Tests and evaluation not performed	\$13,500.
b. Test performed but complete records not maintained.	\$2,500 to \$6,200.
12. Offering any Type B, Type B(U), or Type B(M) packaging that failed to meet the approved DOT, NRC or DOE design, as applicable.	173.416	\$16,500.
13. Offering a Type B packaging without registering as a party to the NRC approval certificate:	173.471(a).	
a. Never obtained approval	\$3,700.
b. Holding an expired certificate	\$1,200.
14. Failure to meet one or more of the special requirements for a package used to ship more than 0.1 kg of uranium hexafluoride.	173.420	\$13,500.
15. Offering Class 7 materials for transportation as a limited quantity without meeting the requirements for a limited quantity.	173.421(a)	\$8,000.
16. Offering a multiple-hazard limited quantity Class 7 material without addressing the additional hazard.	173.423(a)	\$600 to \$3,100.
17. Offering Class 7 materials for transportation under exceptions for radioactive instruments and articles while failing to meet the applicable requirements.	173.424	\$6,200 to \$12,500.

Violation description	Section or cite	Baseline assessment
18. Offering Class 7 low specific activity (LSA) materials or surface contaminated objects (SCO) while failing to comply with applicable transport requirements (including, an external dose rate that exceeds an external radiation level of 10 mSv/h at 3 meters from the unshielded material).	173.427	\$7,500 to \$12,500.
19. Offering Class 7 LSA materials or SCO as exclusive use without providing specific instructions to the carrier for maintenance of exclusive use shipment controls.	173.427(a)(6)	\$1,200.
20. Offering in excess of a Type A quantity of a Class 7 material in a Type A packaging.	173.431	\$15,000.
21. Offering a package that exceeds the permitted radiation level or transport index.	173.441	\$12,500.
22. Offering a package without determining the level of removable external contamination, or that exceeds the limit for removable external contamination.	173.443	\$6,200 and up.
23. Storing packages of radioactive material in a group with a total criticality safety index of more than 50.	173.447(a)	\$6,200 and up.
24. Offering for transportation or transporting aboard a passenger aircraft any single package or overpack of Class 7 material with a transport index greater than 3.0.	173.448(e)	\$6,200 and up.
25. Exporting a Type B, Type B(U), Type B(M), or fissile package without obtaining a U.S. Competent Authority Certificate or, after obtaining a U.S. Competent Authority Certificate, failing to submit a copy to the national competent authority of each country into or through which the package is transported.	173.471(d)	\$3,700.
26. Offering or exporting special form radioactive materials without maintaining a complete safety analysis or Certificate of Competent Authority, as required.	173.476(a), (b)	\$3,700.
27. Shipping a fissile material as fissile-exempt without meeting one of the exemption requirements or otherwise not complying with fissile material requirements.	173.417, 173.453, 173.457	\$12,500.
28. Offering Class 7 fissile materials while failing to have a DOT Competent Authority Certificate or NRC Certificate of Compliance, as required, or failing to meet the requirements of the applicable Certificate.	173.417	\$1,000 to \$12,500.
D. Class 2—Compressed Gases in Cylinders:		
1. Filling and offering a cylinder with compressed gas when the cylinder is out of test or after its authorized service life:	173.301(a)(6), (a)(7).	
a. Table 1 and compressed gas in solution	\$10,000 to \$15,000.
b. Division 2.1 gases	\$7,500 to \$10,000.
c. Division 2.2 gases	\$5,000 to \$7,500.
2. Overfilling cylinders:	Various.	
a. Division 2.3 gases	\$15,000.
b. Division 2.1 gases	\$10,000.
c. Division 2.2 gases	\$7,500.
d. Aerosols, limited quantities, consumer commodities	\$5,000.
3. Failure to check each day the pressure of a cylinder charged with acetylene that is representative of that day's compression, after the cylinder has cooled to a settled temperature, or failure to keep a record of this test for 30 days.	173.303(d)	\$6,200.
4. Offering a limited quantity of a compressed gas in a metal container for the purpose of propelling a nonpoisonous material and failure to heat the cylinder until the pressure is equivalent to the equilibrium pressure at 131 °F, without evidence of leakage, distortion, or other defect.	173.306(a)(3)	\$1,800 to \$5,000.
5. Offering a limited quantity of a compressed gas in a metal container intended to expel a nonpoisonous material, while failing to subject the filled container to a hot water bath, as required.	173.306(a)(3)(v)	\$5,000.

Violation description	Section or cite	Baseline assessment
6. Offering liquefied petroleum gas for permanent installation on consumer premises when the requirements are not met.	173.315(j)	\$7,500 to \$10,000.
E. Oxygen Generators Offered by Air:		
1. Offering an unapproved oxygen generator for transportation.	173.168	\$25,000.
2. Offering an oxygen generator for transportation without installing a means of preventing actuation, as required.	173.168	\$12,500 to \$25,000.
3. Offering an oxygen generator as spent when the ignition and chemical contents were still present.	172.102(c)(1) Special Provision 61.	\$35,000.
F. Batteries:	173.159, 173.185, 173.21(c).	
1. Offering lithium batteries in transportation that have not been tested:		
a. Ground transport	\$15,000.
b. Air transport	\$30,000.
2. Offering lithium batteries in transportation that have been assembled from tested cells, but have not been tested.	\$5,000 + 25 percent increase for each additional design.
3. Failure to create records of design testing	\$2,500 to \$9,300.
4. Offering lithium batteries in transportation that have not been protected against short circuit.	\$15,000.
5. Offering lithium batteries in transportation in unauthorized packages.	\$12,500.
6. Offering lead acid batteries in transportation in unauthorized packages.	\$10,000.
7. Offering lithium batteries in transportation on passenger aircraft or misclassifying them for air transport.	\$30,000.
8. Failure to prepare batteries so as to prevent damage in transit.	\$6,000.

Manufacturing, Reconditioning, Retesting Requirements

A. Activities Subject to Approval:		
1. Failure to report in writing a change in name, address, ownership, test equipment, management, or test personnel.	171.2(c), Approval Letter	\$700 to \$1,500.
2. Failure by an independent inspection agency of specification cylinders to satisfy all inspector duties, including inspecting materials, and verifying materials of construction and cylinders comply with applicable specifications.	178.35(c)(1), (2), (3)	\$5,000 to \$16,500.
3. Failure to properly complete or retain inspector's report for specification packages.	178.25(c)(4), Various	\$4,000.
4. Failure to have a cylinder manufacturing registration number/symbol, when required.	Various	\$2,500.
B. Packaging Manufacturers (General):		
1. Failure of a manufacturer or distributor to notify each person to whom the packaging is transferred of all the requirements not met at the time of transfer, including closure instructions.	178.2(c)	\$3,100.
2. Failure to comply with specified construction requirements for non-bulk packagings:	178.504 to 178.523.	
a. Packing Group I and § 172.504 Table 1 materials.	\$12,000.
b. Packing Group II	\$8,000.
c. Packing Group III	\$4,000.
3. Fail testing: Failure to ensure a packaging certified as meeting the UN standard is capable of passing the required performance testing (depending on size of package):	178.601(b), 178.609, part 178 subparts O, Q.	
a. Infectious substances	\$16,500.
b. Packing Group I and § 172.504 Table 1 materials.	\$13,500 to \$16,500.
c. Packing Group II	\$10,500 to \$13,500.
d. Packing Group III	\$7,500 to \$10,500.
4. No testing: Certifying a packaging as meeting a UN standard when design qualification testing was not performed (depending on size of package):	178.601(d), 178.609, part 178 subparts O, Q.	
a. Infectious substances	\$16,500.
a. Packing Group I and § 172.504 table 1 materials.	\$13,500 to \$16,500.
b. Packing Group II	\$10,500 to \$13,500.

Violation description	Section or cite	Baseline assessment
c. Packing Group III	\$7,500 to \$10,500.
5. Failure to conduct periodic testing on UN standard packaging (depending on length of time, Packing Group, and size of package).	178.601(e), part 178 subparts O, Q.	\$2,500 to \$16,500.
6. Improper testing: Failure to properly conduct testing for UN standard packaging (e.g., testing with less weight than marked on packaging; drop testing from lesser height than required; failing to condition fiberboard boxes before design test) (depending on size of package):		
a. Design qualification testing:	178.601(d), 178.609, part 178 subparts O, Q.	
i. Infectious substances	\$13,500.
ii. Packing Group I	\$10,500 to \$13,500.
iii. Packing Group II	\$7,500 to \$10,500.
iv. Packing Group III	\$2,500 to \$7,500.
b. Periodic testing:	178.601(e), 178.609.	
i. Infectious substances	\$10,500.
ii. Packing Group I	\$7,000 to \$10,500.
iii. Packing Group II	\$4,000 to \$7,000.
iv. Packing Group III	\$600 to \$4,000.
7. Failure to keep complete and accurate testing records:	178.601(l).	
a. No records kept	\$5,000.
b. Incomplete or inaccurate records	\$1,200 to \$3,700.
8. Improper marking of UN certification	178.503	\$600 per item.
C. Drum Manufacturers & Reconditioners:		
1. Failure to properly conduct a production leakproofness test on a new or reconditioned drum:	178.604(b), (d), 173.28(b)(2)(i).	
a. Improper testing:		
i. Packing Group I	\$3,000.
ii. Packing Group II	\$2,500.
iii. Packing Group III	\$2,000.
b. No testing performed:		
i. Packing Group I	\$6,200.
ii. Packing Group II	\$5,000.
iii. Packing Group III	\$3,700.
2. Marking incorrect tester information on a reused drum:	173.28(b)(2)(ii).	
a. Incorrect information	\$1,000.
b. Unauthorized use of another's information	\$9,000.
3. Representing, marking, or certifying a drum as a reconditioned UN standard packaging when the drum does not meet a UN standard..	173.28(c)	\$7,500 to \$13,500.
4. Representing, marking, or certifying a drum as altered from one UN standard to another, when the drum has not been altered.	173.28(d)	\$600
D. IBC and Portable Tank Requalification:		
1. Failure to properly test and inspect IBCs or portable tanks.	180.352, 180.603.	
a. Packing Group I	\$10,000.
b. Packing Group II	\$7,500.
c. Packing Group III	\$5,000.
2. Failure to properly mark an IBC or portable tank with the most current retest and/or inspection information.	180.352(e), 178.703(b), 180.605(k).	\$600 per item.
3. Failure to keep complete and accurate records of IBC or portable tank retest and reinspection:	180.352(f), 180.605(l).	
a. No records kept	\$5,000.
b. Incomplete or inaccurate records	\$1,200 to \$3,700.
4. Failure to make inspection and test records available to a DOT representative upon request.	180.352(g), 49 U.S.C. 5121(b)(2).	\$1,200.
5. Failure to perform tests (internal visual, leakproofness) on an IBC as part of a repair.	180.352(d)	\$3,700 to \$6,200.
6. Failure to perform routine maintenance on an IBC	180.350(c)	\$2,500.
E. Cylinder Manufacturers & Rebuilders:		
1. Manufacturing, representing, marking, certifying, or selling a DOT high-pressure cylinder that was not inspected and verified by an approved independent inspection agency.	178.35	\$10,000 to \$25,000.
2. Failure to mark a registration number/symbol on a cylinder, when required.	178.35, Various	\$1,000.

Violation description	Section or cite	Baseline assessment
3. Failure to mark the date of manufacture or lot number on a DOT-39 cylinder.	178.65(i)	\$3,700.
4. Failure to have a chemical analysis performed in the U.S. for a material manufactured outside the U.S., without an approval.	107.807, 178.35	\$6,200.
5. Failure to comply with defect and attachment requirements, safety device requirements, or marking requirements.	178.35(d), (e), (f)	\$5,000.
6. Failure to meet wall thickness requirements	Various	\$9,300 to \$18,700.
7. Failure to heat treat cylinders prior to testing	Various	\$6,200 to \$18,700.
8. Failure to conduct a complete visual internal examination.	Various	\$3,100 to \$7,700.
9. Failure to conduct a hydrostatic test, or conducting a hydrostatic test with inaccurate test equipment.	Various	\$3,100 to \$7,700.
10. Failure to conduct a flattening test	Various	\$9,300 to \$18,700.
11. Failure to conduct a burst test on a DOT-2P, 2Q, 2S, or 39 cylinder.	178.33-8, 178.33a-8, 178.33b-8, 178.65(f)(2).	\$6,200 to \$18,700.
12. Failure to maintain required inspector's reports: ..	178.35, Various.	
a. No reports at all	\$5,000.
b. Incomplete or inaccurate reports	\$1,200 to \$3,700.
13. Failure to complete or retain manufacturer's reports.	178.35(g)	\$6,200.
14. Representing a DOT-4 series cylinder as repaired or rebuilt to the requirements of the HMR without being authorized by the Associate Administrator.	180.211(a)	\$10,000 to \$25,000.
F. Cargo Tank Motor Vehicles:		
1. Failure to maintain complete cargo tank test reports, as required:	180.417(b), (c).	
a. No records	\$5,000.
b. Incomplete records	\$1,200 to \$3,700.
2. Failure to have a cargo tank tested or inspected (e.g., visual, thickness, pressure, leakproofness).	180.407(c)	\$8,000 and up; increase by 25 percent for each additional.
3. Failure to mark a cargo tank with test and inspection markings.	180.415	\$600 each item.
4. Failure to retain a cargo tank's data report and Certificates or design certification.	178.320(b), 178.337-18, 178.338-19, 178.345-15.	\$6,200.
5. Failure to mark a special permit number on a cargo tank.	172.301(c)	\$1,800.
6. Constructing a cargo tank or cargo tank motor vehicle not in accordance with a special permit or design certification.	178.320(b), Special Permit	\$13,500.
7. Failure to mark manhole assemblies on a cargo tank motor vehicle manufactured after October 1, 2004.	178.345-5(e)	\$4,500.
8. Failure to apply specification plate and name plate:..	178.337-17, 178.338-18, 178.345-14.	
a. No marking	\$4,500.
b. Incomplete marking	\$600 per item.
9. Failure to conduct monthly inspections and tests of discharge system in cargo tanks.	180.416(d)	\$2,500.
G. Cylinder Requalification:		
1. Certifying or marking as retested a non-specification cylinder.	180.205(a)	\$1,000.
2. Failure to have retester's identification number (RIN).	180.205(b)	\$5,000.
3. Failure to have current authority due to failure to renew a RIN.	180.205(b)	\$2,500 + \$600 each additional year.
4. Marking a RIN before successfully completing a hydrostatic retest.	180.205(b)	\$1,000.
5. Representing, marking, or certifying a cylinder as meeting the requirements of a special permit when the cylinder was not maintained or retested in accordance with the special permit.	171.2(c), (e), 180.205(c), Special Permit.	\$2,500 to \$7,500.
6. Failure to conduct a complete visual external and internal examination.	180.205(f)	\$2,600 to \$6,500.
7. Performing hydrostatic retesting without confirming the accuracy of the test equipment or failing to conduct hydrostatic testing.	180.205(g)(1), 180.205(g)(3) ...	\$2,600 to \$6,500.
8. Failure to hold hydrostatic test pressure for 30 seconds or sufficiently longer to allow for complete expansion.	180.205(g)(5)	\$3,800.

Violation description	Section or cite	Baseline assessment
9. Failure to perform a second retest, after equipment failure, at a pressure increased by the lesser of 10 percent or 100 psi (includes exceeding 90percent of test pressure prior to conducting a retest).	180.205(g)(5)	\$3,800.
10. Failure to condemn a cylinder when required (e.g., permanent expansion exceeds 10 percent of total expansion [5percent for certain special permit cylinders], internal or external corrosion, denting, bulging, evidence of rough usage).	180.205(i)	\$7,500 to \$13,500.
11. Failure to properly mark a condemned cylinder or render it incapable of holding pressure.	180.205(i)(2)	\$1,000 to \$5,000.
12. Failure to notify the cylinder owner in writing when a cylinder has been condemned.	180.205(i)(2)	\$1,200.
13. Failure to perform hydrostatic retesting at the minimum specified test pressure.	180.209(a)	\$2,600 to \$6,500.
14. Marking a star on a cylinder that does not qualify for that mark.	180.209(b)	\$2,500 to \$5,000.
15. Marking a "+" sign on a cylinder without determining the average or minimum wall stress by calculation or reference to CGA Pamphlet C–5.	173.302a(b)	\$2,500 to \$5,000.
16. Marking a cylinder in or on the sidewall when not permitted by the applicable specification.	180.213(b)	\$7,500 to \$13,500.
17. Failure to maintain legible markings on a cylinder	180.213(b)(1)	\$1,000.
18. Marking a DOT 3HT cylinder with a steel stamp other than a low-stress steel stamp.	180.213(c)(2)	\$7,500 to \$13,500.
19. Improper marking of the RIN or retest date on a cylinder.	180.213(d)	\$1,000.
20. Marking an FRP cylinder with steel stamps in the FRP area of the cylinder such that the integrity of the cylinder is compromised.	Special Permit	\$7,500 to \$13,500.
21. Failure to comply with eddy current examination requirements for DOT 3AL cylinders manufactured of aluminum alloy 6351–T6, when applicable.	Appendix C to part 180	\$2,600 to \$6,500.
22. Failure to maintain current copies of the HMR, DOT special permits, and CGA Pamphlets applicable to inspection, retesting, and marking activities.	180.215(a)	\$700 to \$1,500.
23. Failure to keep complete and accurate records of cylinder reinspection and retest:	180.215(b).	
a. No records kept	\$5,000.
b. Incomplete or inaccurate records	\$1,200 to \$3,700.

Carrier Requirements

A. Incident Notification:		
1. Failure to provide immediate telephone/online notification of a reportable hazardous materials incident reportable under 171.15(b).	171.15	\$6,000.
2. Failure to file a written hazardous material incident report within 30 days of discovering a hazardous materials incident reportable under 171.15(b) or 171.16(a).	171.16	\$4,000.
3. Failure to include all required information in hazardous materials incident notice or report or failure to update report.	171.15, 171.16	\$1,000.
B. Shipping Papers:		
1. Failure to retain shipping papers for 1 year after a hazardous material (or 3 years for a hazardous waste) is accepted by the initial carrier.	174.24(b), 175.33(c), 176.24(b), 177.817(f).	\$1,200.
C. Stowage/Attendance/Transportation Requirements:		
1. Transporting packages of hazardous material that have not been secured against movement.	Various	\$3,700 and up.
2. Failure to properly segregate hazardous materials	Various	\$9,300 and up.
3. Failure to remove a package containing hazardous materials from a motor vehicle before discharge of its contents:	177.834(h).	
a. Packing Group I and § 172.504 Table 1 materials.	\$5,000.
b. Packing Group II	\$3,000.
c. Packing Group III	\$1,000.

Violation description	Section or cite	Baseline assessment
4. Transporting explosives in a motor vehicle containing metal or other articles or materials likely to damage the explosives or any package in which they are contained, without segregating in different parts of the load or securing them in place in or on the motor vehicle and separated by bulkheads or other suitable means to prevent damage.	177.835(j)	\$6,500 and up.
5. Failure to attend Class 1 explosive materials during transportation.	177.835(k)	\$3,000.
6. Transporting railway track torpedoes outside of flagging kits, in violation of DOT-E 7991.	171.2(b), (e)	\$8,700.
7. Failure to carry a hazmat registration letter or number in the transport vehicle.	107.620(b)	\$1,000.
8. Transporting Class 7 (radioactive) material having a total transport index greater than 50.	177.842(a)	\$6,200 and up.
9. Transporting Class 7 (radioactive) material without maintaining the required separation distance.	177.842(b)	\$6,200 and up.
10. Failure to comply with radiation survey requirements of a special permit that authorizes the transportation of Class 7 (radioactive) material having a total transportation index exceeding 50.	171.2(b), (e), Special Permit ...	\$6,200 and up.

The baseline penalty amounts in Part II are used as a starting amount or range appropriate for the normal or typical nature, extent, circumstances, and gravity of the probable violations frequently cited in enforcement reports. PHMSA must also consider any additional factors, as provided in 49 U.S.C. 5123(c) and 49 CFR 107.331, including the nature, circumstances, extent and gravity of a violation, the degree of culpability and compliance history of the respondent, the financial impact of the penalty on the respondent, and other matters as justice requires. Consequently, at each stage of the administrative enforcement process, up to and including issuance of a final order or decision on appeal, PHMSA can adjust the baseline amount in light of the specific facts and circumstances of each case.

As part of this analysis, PHMSA reviews the factors outlined in the next section, *Miscellaneous Factors Affecting Penalty Amounts*, the safety implications of the violation, the pervasiveness of the violation, and all other relevant information. PHMSA considers not only what happened as a result of the violation, but also what could have happened as a result of continued violation of the regulations. As a general matter, one or more specific instances of a violation are presumed to reflect a respondent's general manner of operations, rather than isolated occurrences.

PHMSA may draw factors relevant to the statutory considerations from the initial information gathered by PHMSA's Office of Hazardous Materials Safety Field Operations, the respondent in response to an exit briefing, ticket, or Notice of Probable Violation (NOPV), or information otherwise available to us. We will generally apply the specific statutory factors that are outlined in the next section, *Miscellaneous Factors Affecting Penalty Amounts*, in the following order:

1. Select the appropriate penalty amount within a specific baseline or range, with appropriate increases or decreases depending on the packing group or material involved and other information regarding the frequency or duration of the violation, the culpability of the respondent, and the actual or potential consequences of the violation.
2. Apply decreases for a reshipper or carrier that reasonably relied on an offeror's non-compliant preparation of a hazardous materials shipment.
3. Apply increases for multiple counts of the same violation.
4. Apply increases for prior violations of the HMR within the past six years.
5. Apply decreases for corrective actions.
6. Apply decreases for respondent's inability to pay or adverse effect on its ability to continue in business.

After each adjustment listed above, PHMSA will use the new modified baseline to calculate each subsequent adjustment. PHMSA will apply adjustments separately to each individual violation. All penalty assessments will be subject to additional adjustments as appropriate to reflect other matters as justice requires.

A. Respondents That Reship

A person who either receives hazardous materials from another company and reships them (reshipper), or accepts a hazardous material for transportation, and transports that material (carrier), is responsible for ensuring that the shipment complies in all respects with Federal hazardous materials transportation law. In both cases, the reshipper or carrier independently may be subject to enforcement action if the shipment does not comply.

Depending on all the circumstances, however, the person who originally prepared the

shipment and placed it into transportation may have greater culpability for the non-compliance than the reshipper or carrier who reasonably relies on the shipment as received and does not open or alter the package before the shipment continues in transportation. PHMSA will consider the specific knowledge and expertise of all parties, as well as which party is responsible for compliance under the regulations, when evaluating the culpability of a reshipper or carrier. PHMSA recognizes that a reshipper or carrier may have reasonably relied upon information from the original shipper and may reduce the applicable baseline penalty amount up to 25 percent.

B. Penalty Increases for Multiple Counts

A main objective of PHMSA's enforcement program is to obtain compliance with the HMR and the correction of violations which, in many cases, have been part of a company's regular course of business. As such, there may be multiple instances of the same violation. Examples include a company shipping various hazardous materials in the same unauthorized packaging, shipping the same hazardous material in more than one type of unauthorized packaging, shipping hazardous materials in one or more packages with the same marking errors, or using shipping papers with multiple errors.

Under 49 U.S.C. 5123(a), each violation of the HMR and each day of a continuing violation (except for violations pertaining to packaging manufacture or qualification) is subject to a civil penalty up to \$75,000 or \$175,000 for a violation occurring on or after October 1, 2012. As such, PHMSA generally will treat multiple occurrences that violate a single regulatory provision as separate violations and assess the applicable baseline penalty for each distinct occurrence of the violation. PHMSA will generally consider multiple shipments or, in the case of package testers, multiple package designs, to be multiple occurrences; and each shipment or package design may constitute a separate violation.

PHMSA, however, will exercise its discretion in each case to determine the appropriateness of combining into a single violation what could otherwise be alleged as separate violations and applying a single penalty for multiple counts or days of a violation, increased by 25 percent for each additional instance, as directed by 49 U.S.C. 5123(c). For example, PHMSA may treat a single shipment containing three items or packages that violate the same regulatory provision as a single violation and apply a single baseline penalty with a 50 percent increase for the two additional items or packages; and PHMSA may treat minor variations in a package design for a package tester as a single violation and apply a single baseline pen-

alty with a 25 percent increase for each additional variation in design.

When aggravating circumstances exist for a particular violation, PHMSA may handle multiple instances of a single regulatory violation separately, each meriting a separate baseline or increase the civil penalty by 25 percent for each additional instance. Aggravating factors may include increased safety risks, continued violation after receiving notice, or separate and distinct acts. For example, if the multiple occurrences each require their own distinct action, then PHMSA may count each violation separately (e.g., failure to obtain approvals for separate fireworks devices).

C. Penalty Increases for Prior Violations

The baseline penalty in the List of Frequently Cited Violations assumes an absence of prior violations. If a respondent has prior violations of the HMR, generally, PHMSA will increase a proposed penalty.

When setting a civil penalty, PHMSA will review the respondent's compliance history and determine if there are any finally-adjudicated violations of the HMR initiated within the previous six years. Only cases or tickets that have been finally-adjudicated will be considered (i.e., the ticket has been paid, a final order has been issued, or all appeal remedies have been exhausted or expired). PHMSA will include prior violations that were initiated within six years of the present case; a case or ticket will be considered to have been initiated on the date of the exit briefing for both the prior case and the present case. If multiple cases are combined into a single Notice of Probable Violation or ticket, the oldest exit briefing will be used to determine the six-year period. If a situation arises where no exit briefing is issued, the date of the Notice of Probable Violation or Ticket will be used to determine the six-year period. PHMSA may consider prior violations of the Hazardous Materials Regulations from other DOT Operating Administrations.

The general standards for increasing a baseline proposed penalty on the basis of prior violations are as follows:

1. For each prior civil or criminal enforcement case—25 percent increase over the pre-mitigation recommended baseline penalty.
2. For each prior ticket—10 percent increase over the pre-mitigation recommended baseline penalty.
3. If a respondent is cited for operating under an expired special permit and previously operated under an expired special permit (as determined in a finally-adjudicated civil, criminal, or administrative enforcement case or a ticket), PHMSA will increase the civil penalty 100 percent.
4. If a respondent is cited for the exact same violation that it has been previously

cited for within the six-year period (in a finally-adjudicated civil, criminal, or administrative enforcement case or a ticket), PHMSA will increase the baseline for that violation by 100 percent. This increase will apply only when the present violation is identical to the previous violation and applies only to the specific violation that has recurred.

5. A baseline proposed penalty (both for each individual violation and the combined total) will not be increased more than 100 percent on the basis of prior violations.

D. Corrective Action

PHMSA may lower a proposed penalty when a respondent's documented corrective action has fixed an alleged violation. Corrective action should demonstrate not only that the specific deficiency is corrected but also that any systemic corrections have been addressed to prevent recurrence of the violation.

The two primary factors that determine the reduction amount are the extent and timing of the corrective action. In other words, PHMSA will determine the amount of mitigation based on how much corrective action a respondent completes and how soon after the exit briefing it performs corrective action. Comprehensive systemic action to prevent future violations may warrant greater mitigation than actions that simply target violations identified during the inspection. Actions taken immediately (within the 30 calendar day period that respondents have to respond to an exit briefing, or upon approval of Field Operations) may warrant greater mitigation than actions that are not taken promptly.

PHMSA may consider a respondent's corrective action to assess mitigation at various stages in the enforcement process, including: (1) AFTER an inspection and before an NOPV is issued; (2) on receipt of an NOPV; or (3) after receipt of an NOPV. In order to reduce a civil penalty for corrective action, PHMSA must receive satisfactory documentation that demonstrates the corrective action was completed. If a corrective action is of a type that cannot be documented (e.g., no longer using a particular packaging), then a respondent may provide a signed affidavit describing the action it took. The affidavit must begin with the affirmative oath "I hereby affirm under the penalties of perjury that the below statements are true and correct to the best of my knowledge, information and belief," in accordance with 28 U.S.C. 1746.

Generally, corrective action credit may not exceed 25 percent. Mitigation is applied to individual violations and fact patterns but should not be considered to be automatic reduction. Thus, in a case with two violations, if corrective action for the first violation is more extensive than for the second, the pen-

alty for the first will be mitigated more than that for the second. If a respondent has previously committed the same violation, however, as determined in a finally-adjudicated civil, criminal, or administrative enforcement case or a ticket, PHMSA will not apply any reduction for corrective action.

In determining the appropriate civil penalty reduction, PHMSA will consider the extent to which the respondent corrected the violation and any risks or harms it created, the respondent's actions to prevent the violation from recurring, improvements to overall company practices to address a widespread compliance issue, and how quickly the corrective action was performed. In general, PHMSA will apply the following reductions for corrective action, subject to the facts and circumstances of individual cases and respondents. If a respondent has given full documentation of timely corrective action and PHMSA does not believe that anything else can be done to correct the violation or improve overall company practices, we will generally reduce the civil penalty by no more than 25 percent. As noted above, a 25 percent reduction is not automatic. We will reduce the penalty up to 20 percent when a respondent promptly and completely corrected the cited violation and has taken substantial steps toward comprehensive improvements. PHMSA will generally apply a reduction up to 15 percent when a respondent has made substantial and timely progress toward correcting the specific violation as well as overall company practices, but additional actions are needed. A reduction up to 10 percent is appropriate when a respondent has taken significant steps toward addressing the violation, but minimal or no steps toward correcting broader company policies to prevent future violations. PHMSA may reduce a penalty up to 5 percent when a respondent made untimely or minimal efforts toward correcting the violation.

E. Financial Considerations

PHMSA may mitigate a proposed penalty when a respondent documents that the penalty would either (1) exceed an amount that the respondent is able to pay, or (2) have an adverse effect on the respondent's ability to continue in business. These criteria relate to a respondent's entire business, and not just the product line or part of its operations involved in a violation. PHMSA may apply this mitigation by reducing the civil penalty or instituting a payment plan.

PHMSA will only mitigate a civil penalty based on financial considerations when a respondent supplies financial documentation demonstrating one of the factors above. A respondent may submit documentation of financial hardship at any stage to receive mitigation or an installment payment plan.

§ 107.401

Documentation includes tax records, a current balance sheet, profit and loss statements, and any other relevant records. Evidence of a respondent's financial condition is used only to decrease a penalty, and not to increase it.

In evaluating the financial impact of a penalty on a respondent, PHMSA will consider all relevant information on a case-by-case basis. Although PHMSA will determine financial hardship and appropriate penalty adjustments on an individual basis, in general, we will consider the following factors.

1. The overall financial size of the respondent's business and information on the respondent's balance sheet, including the current ratio (current assets to current liabilities), the nature of current assets, and net worth (total assets minus total liabilities).

2. A current ratio close to or below 1.0 may suggest that the company would have difficulty in paying a large penalty or in paying it in a single lump sum.

3. A small amount of cash on hand (representing limited liquidity), even with substantial other current assets (such as accounts receivable or inventory), may suggest a company would have difficulty in paying a penalty in a single lump sum.

4. A small or negative net worth may suggest a company would have difficulty in paying a penalty in a single lump sum. Notwithstanding, many respondents have paid substantial civil penalties in installments even though net worth was negative. For this reason, negative net worth alone does not always warrant reduction of a proposed penalty or even, in the absence of factors discussed above, a payment plan.

When PHMSA determines that a proposed penalty poses a significant financial hardship, we may reduce the proposed penalty and/or implement an installment payment plan. The appropriateness of these options will depend on the circumstances of the case.

When an installment payment plan is appropriate, the length of the payment plan should be as short as possible, but may be adjusted as necessary. PHMSA will not usually exceed six months for a payment plan. In unusual circumstances, PHMSA may extend the period of a payment plan. For example, the duration of a payment plan may reflect fluctuations in a company's income if its business is seasonal or if the company has documented specific reasons for current non-liquidity.

[78 FR 60733, Oct. 2, 2013]

49 CFR Ch. I (10–1–14 Edition)

Subpart E—Designation of Approval and Certification Agencies

§ 107.401 Purpose and scope.

(a) This subpart establishes procedures for the designation of agencies to issue certificates and certifications for types of packagings designed, manufactured, tested, or maintained in conformance with the requirements of this subchapter, subchapter C of this chapter, and standards set forth in the United Nations (U.N.) Recommendations (Transport of Dangerous Goods), and for lighters, portable tanks, multi-element gas containers, and Division 1.4G consumer fireworks in conformance with the requirements of this subchapter. Except for certifications of compliance with U.N. packaging standards, this subpart does not apply unless made applicable by a rule in subchapter C of this chapter.

(b) The Associate Administrator may issue approval certificates and certifications addressed in paragraph (a) of this section.

[78 FR 42473, July 16, 2013]

§ 107.402 Application for designation as a certification agency.

(a) Any organization or person seeking to be approved as a certification agency must apply in writing to the Associate Administrator for Hazardous Materials Safety (PHH-32), Department of Transportation, East Building, 1200 New Jersey Avenue SE., Washington DC 20590-0001. Alternatively, the application in an appropriate format may be submitted by facsimile (fax) to: (202) 366-3753 or (202) 366-3308 or by electronic mail (email) to: approvals@dot.gov. Each application must be signed and certified to be correct by the applicant or, if the applicant is an organization, by an authorized officer or official representative of the organization. Any false statement or representation, or the knowing and willful concealment of a material fact, may subject the applicant to prosecution under the provisions of 18 U.S.C. 1001, and result in the denial or termination of a designation.

(b) Each application for approval as a certification agency must be in English and include the following information:

(1) Information required by the provisions in subpart H of this part;

(2) Name and address of the applicant, including place of incorporation if a corporation. In addition, if the applicant is not a resident of the United States, the name and address of a permanent resident of the United States designated in accordance with §105.40 of this subchapter to serve as agent for service of process. A person approved as a certification agency is not a PHMSA agent or representative;

(3) A statement acknowledging that the Associate Administrator or a designated official may inspect, on demand, its records and facilities in so far as they relate to the certification activities and will cooperate in the conduct of such inspections; and

(4) Any additional information relevant to the applicant's qualifications, upon request of the Associate Administrator or a designated official.

(c) *UN Third-Party Packaging Certification Agency*. In addition to the requirements in paragraph (b) of this section, the application must include the following information:

(1) A listing, by DOT specification (or special permit) number, or U.N. designation, of the types of packagings for which certification authority is sought;

(2) A statement showing proof that the applicant has:

(i) The ability to review and evaluate design drawings, design and stress calculations;

(ii) The knowledge of the applicable regulations of subchapter C of this chapter and, when applicable, U.N. standards;

(iii) The ability to conduct or monitor and evaluate test procedures and results; and

(iv) The ability to review and evaluate the qualifications of materials and fabrication procedures.

(3) A statement that the applicant will perform its functions independent of the manufacturers and owners of the packagings concerned.

(4) If the applicant's principal place of business is in a country other than the United States, a copy of the des-

ignation from the Competent Authority of that country delegating to the applicant an approval or designated agency authority for the type of packaging for which a DOT designation is sought, and a statement that the Competent Authority also delegates similar authority to U.S. Citizens or organizations having designations under this subpart from PHMSA.

(d) *Fireworks Certification Agency*. Prior to reviewing, and certifying Division 1.4G consumer fireworks (UN0336) for compliance with the APA Standard 87-1 (IBR, see §171.7 of this chapter, a person must apply to, and be approved by, the Associate Administrator to act as an Fireworks Certification Agency.

(1) *Fireworks Certification Agency applicant requirements*. The Fireworks Certification Agency applicant must—

(i) Be a U.S. citizen, or for non-U.S. citizens, have a designated U.S. agent representative as specified in §105.40;

(ii) Employ personnel with work experience in manufacturing or testing of fireworks or explosives; or a combination of work experience in manufacturing or testing of fireworks or explosives and a degree in the physical sciences or engineering from an accredited university;

(iii) Have the ability to:

(A) Review design drawings, and applications to certify that they are in accordance with the APA Standard 87-1; and

(B) Verify that the applicant has certified the thermal stability test procedures and results.

(iv) Must be independent of and not owned by any consumer fireworks manufacturer, distributor, import or export company, or proprietorship.

(2) *Fireworks Certification Agency application submittal requirements*. In addition to the requirements of paragraphs (b) and (d)(1) of this section, the Fireworks Certification Agency application must include—

(i) Name, address, and country of each facility where Division 1.4G consumer fireworks applications are reviewed and certified;

(ii) A detailed description of the qualifications of each individual the applicant proposes to employ to review, and certify that the requirements

§ 107.403

specified by part 173 of this chapter and the APA Standard 87-1 have been met;

(iii) Written operating procedures to be used by the Fireworks Certification Agency to review and certify that a Division 1.4G consumer fireworks application meets the requirements specified in the APA Standard 87-1;

(iv) Name, address, and principal business activity of each person having any direct or indirect interest in the applicant greater than three percent and any direct or indirect ownership interest in each subsidiary or division of the applicant; and

(v) A statement that the applicant will perform its functions independent of the manufacturers, transporters, importers, and owners of the fireworks.

(e) *Lighter Certification Agency.* Prior to examining and testing lighters (UN1057) for compliance with the requirements of §173.308 of this chapter a person must apply to, and be approved by, the Associate Administrator to act as a lighter certification agency. In addition to paragraph (b) of this section, the application must include the following information:

(1) Name and address of each facility where lighters are examined and tested; and

(2) Detailed description of the applicant's qualifications and ability to, examine and test lighters and certify that the requirements specified by §173.308 of this chapter have been met.

(f) *Portable tank and MEGC Certification Agencies.* Prior to inspecting portable tanks or multi-element gas containers (MEGCs) for compliance with the requirements of §180.605(k) of this chapter, requirements for periodic testing, inspection and repair of portable tanks, and §178.74 of this chapter, approval of MEGCs, a person must apply to, and be approved by, the Associate Administrator to act as a certification agency. In addition to paragraph (b) of this section, the application must provide the following information:

(1) Name and address of each facility where the portable tank or MEGC is examined and tested; and

(2) Detailed description of the applicant's qualifications and ability to, examine and test portable tanks or MEGCs and certify that the require-

49 CFR Ch. I (10-1-14 Edition)

ments specified by §178.273 of this chapter, specifications for UN portable tanks, or §178.74 of this chapter, approval of MEGCs, of this chapter have been met.

[78 FR 42473, July 16, 2013, as amended at 78 FR 60750, Oct. 2, 2013]

§ 107.403 Designation of certification agencies.

(a) If the Associate Administrator determines that an application contains all the required information, the applicant is sent a letter of designation and assigned an identification code.

(b) If the Associate Administrator determines that an application does not contain all the required information, the application is denied and the applicant is sent a written notice containing all the reasons for the denial.

(c) Within 30 days of an initial denial of an application under paragraph (b) of this section, the applicant may file an amended application. If the application is denied by the Associate Administrator of Hazardous Materials Safety, the applicant may, within 20 days of receipt of the decision, request reconsideration by the Associate Administrator as set forth in §107.715. If the reconsideration is denied by the Associate Administrator, the applicant may appeal the Associate Administrator's decision, within 30 days of the Associate Administrator's decision, to the Administrator of PHMSA, as specified in §107.717.

(d) The Associate Administrator may modify, suspend, or terminate an approval submitted under this subpart as set forth in §107.713.

[Amdt. 107-13, 50 FR 10062, Mar. 13, 1985, as amended by Amdt. 107-23, 56 FR 66157, Dec. 20, 1991; Amdt. 107-32, 59 FR 49131, Sept. 26, 1994; 66 FR 45377, Aug. 28, 2001; 78 FR 42474, July 16, 2013]

§ 107.404 Conditions of designation.

(a) Each designation made under this subpart contains the following conditions:

(1) The designated approval or certification agency may use only testing equipment that it has determined, through personal inspection, to be suitable for the purpose.

(2) Each approval certificate and certification issued by the designated approval agency must contain the name and identification code of the approval agency.

(3) Each approval certificate and certification must be in a format acceptable to the Associate Administrator.

(b) The designated approval agency shall notify the Associate Administrator within 20 days after the date there is any change in the information submitted under §107.402.

(c) The designated approval agency shall comply with all of the terms and conditions stated in its letter of designation under the subpart.

(d) Nothing in this part relieves a manufacturer or owner of a packaging of responsibility for compliance with any of the applicable requirements of this title.

[Amdt. 107-13, 50 FR 10062, Mar. 13, 1985, as amended by Amdt. 107-23, 56 FR 66157, Dec. 20, 1991; 66 FR 45377, Aug. 28, 2001]

§ 107.405 [Reserved]

Subpart F—Registration of Cargo Tank and Cargo Tank Motor Vehicle Manufacturers, Assemblers, Repairers, Inspectors, Testers, and Design Certifying Engineers

§ 107.501 Scope.

(a) This subpart establishes a registration procedure for persons who are engaged in the manufacture, assembly, inspection and testing, certification, or repair of a cargo tank or a cargo tank motor vehicle manufactured in accordance with a DOT specification under subchapter C of this chapter or under terms of a special permit issued under this part.

(b) Persons engaged in continuing qualification and maintenance of cargo tanks and cargo tank motor vehicles must be familiar with the requirements set forth in part 180, subpart E, of this chapter.

[Amdt. 107-20, 55 FR 37047, Sept. 7, 1990]

§ 107.502 General registration requirements.

(a) *Definitions:* For purposes of this subpart—

(1) *Assembly* means the performance of any of the following functions when the function does not involve welding on the cargo tank wall:

(i) The mounting of one or more tanks or cargo tanks on a motor vehicle or to a motor vehicle suspension component;

(ii) The installation of equipment or components necessary to meet the specification requirements prior to the certification of the cargo tank motor vehicle; or

(iii) The installation of linings, coatings, or other materials to the inside of a cargo tank wall.

(2) The terms *Authorized Inspector*, *Cargo tank*, *Cargo tank motor vehicle*, *Design Certifying Engineer*, *Registered Inspector*, and *Person* are defined in §171.8 of this chapter.

(3) The terms *cargo tank wall* and *manufacturer* are defined in §178.320(a), and *repair* is defined in §180.403 of this chapter.

(b) No person may engage in the manufacture, assembly, certification, inspection or repair of a cargo tank or cargo tank motor vehicle manufactured under the terms of a DOT specification under subchapter C of this chapter or a special permit issued under this part unless the person is registered with the Department in accordance with the provisions of this subpart. A person employed as an inspector or design certifying engineer is considered to be registered if the person's employer is registered.

(c) A person who performs functions which are subject to the provisions of this subpart may perform only those functions which have been identified to the Department in accordance with the procedures of this subpart.

(d) Registration statements must be in English, contain all of the information required by this subpart, and be submitted to: FMCSA Hazardous Materials Division—MC-ECH, West Building, MC-ECH, 1200 New Jersey Avenue, SE., Washington, DC 20590.

(e) Upon determination that a registration statement contains all the information required by this subpart, the Department will send the registrant a letter confirming receipt of the registration application and assigning a registration number to that person. A

§ 107.503

separate registration number will be assigned for each cargo tank manufacturing, assembly, repair facility or other place of business identified by the registrant.

[Amdt. 107-20, 54 FR 25003, June 12, 1989; 55 FR 37047, Sept. 7, 1990, as amended by Amdt. 107-22, 55 FR 39978, Oct. 1, 1990; Amdt. 107-23, 56 FR 66157, Dec. 20, 1991; Amdt. 107-28, 58 FR 46873, Sept. 3, 1993; Amdt. 107-39, 61 FR 51337, Oct. 1, 1996; 67 FR 61011, Sept. 27, 2002; 68 FR 19273, Apr. 18, 2003; 72 FR 55683, Oct. 1, 2007]

§ 107.503 Registration statement.

(a) Each registration statement must be in English and contain the following information:

- (1) Name;
- (2) Street address, mailing address and telephone number for each facility or place of business;
- (3) A statement indicating whether the facility uses mobile testing/inspection equipment to perform inspections, tests, or repairs at a location other than the address listed in paragraph (a)(2) of this section.

(4) A statement signed by the person responsible for compliance with the applicable requirements of this chapter, certifying knowledge of those requirements and that each employee who is a Registered Inspector or Design Certifying Engineer meets the minimum qualification requirements set forth in §171.8 of this chapter for "Registered Inspector" or "Design Certifying Engineer". The following language may be used.

I certify that all Registered Inspectors and Design Certifying Engineers used in performance of the prescribed functions meet the minimum qualification requirements set forth in 49 CFR 171.8, that I am the person responsible for ensuring compliance with the applicable requirements of this chapter, and that I have knowledge of the requirements applicable to the functions to be performed.

(5) A description of the specific functions to be performed on cargo tanks or cargo tank motor vehicles, e.g.:

- (i) Manufacture,
- (ii) Assembly,
- (iii) Inspection and testing (specify type, e.g., external or internal visual inspection, lining inspection, hydrostatic pressure test, leakage test, thickness test),
- (iv) Certification,

- (v) Repair, or
- (vi) Equipment manufacture;

(6) An identification of the types of DOT specification and special permit cargo tanks or cargo tank motor vehicles which the registrant intends to manufacture, assemble, repair, inspect, test or certify;

(7) A statement indicating whether the registrant employs Registered Inspectors or Design Certifying Engineers to conduct certification, inspection or testing functions addressed by this subpart. If the registrant engages a person who is not an employee of the registrant to perform these functions, provide the name, address and registration number of that person; and

(8) If the registrant is not a resident of the United States, the name and address of a permanent resident of the United States designated in accordance with §105.40 to serve as agent for service of process.

(b) In addition to the information required under paragraph (a) of this section, each person who manufactures a cargo tank or cargo tank motor vehicle must submit a copy of the manufacturer's current ASME Certificate of Authorization for the use of the ASME "U" stamp.

(c) In addition to the information required under paragraph (a) of this section, each person who repairs a cargo tank or cargo tank motor vehicle must submit a copy of the repair facility's current National Board Certificate of Authorization for the use of the "R" stamp or ASME Certificate of Authorization for the use of the ASME "U" stamp. Any person who repairs MC-series cargo tanks which are not certified to the ASME Code must submit a copy of the National Board or ASME Certificate of Authorization to PHMSA before June 30, 1992.

[Amdt. 107-20, 54 FR 25003, June 12, 1989; 55 FR 37047, Sept. 7, 1990; 57 FR 365, Jan. 6, 1992; Amdt. 107-32, 59 FR 49131, Sept. 26, 1994; Amdt. 107-39, 61 FR 51337, Oct. 1, 1996; 63 FR 52846, Oct. 1, 1998; 68 FR 19273, Apr. 18, 2003]

§ 107.504 Period of registration, updates, and record retention.

(a) Registration will be for a maximum of six years from the date of the original registration.

(b) Any correspondence with the Department must contain the registrant's name and registration number.

(c) A registration must be renewed every six years or within thirty days of reissuance of an ASME or National Board Certification, whichever occurs first, by submitting an up-to-date registration statement containing the information prescribed by §107.503. Any person initially registered under the provisions of §107.502 and who is in good standing is eligible for renewal.

(d) A registrant shall provide written notification to the Department within thirty days of any of the following occurrences:

(1) Any change in the registration information submitted under §107.503;

(2) Replacement of the person responsible for compliance with the requirements in §107.503(a)(4). If this occurs, the registrant shall resubmit the required certification;

(3) Loss of ASME or National Board Certificate of Authorization; or

(4) A change in function; such as, from assembly to manufacture, an addition of a function, or a change to the types of inspections, tests or certifications of cargo tanks or cargo tank motor vehicles.

(e) Each registrant shall maintain a current copy of the registration information submitted to the Department and a current copy of the registration number identification received from the Department at the location identified in §107.503(a)(2) during such time the person is registered with the Department and for two years thereafter.

(f) The issuance of a registration number under this subpart is not an approval or endorsement by the Department of the qualifications of any person to perform the specified functions.

[Amdt. 107-20, 54 FR 25003, June 12, 1989; 55 FR 37048, Sept. 7, 1990, as amended by Amdt. 107-20, 56 FR 27875, June 17, 1991; Amdt. 107-37, 61 FR 18931, Apr. 29, 1996; 71 FR 54390, Sept. 14, 2006]

Subpart G—Registration of Persons Who Offer or Transport Hazardous Materials

SOURCE: Amdt. No. 107-26, 57 FR 30630, July 9, 1992, unless otherwise noted.

§ 107.601 Applicability.

(a) The registration and fee requirements of this subpart apply to any person who offers for transportation, or transports, in foreign, interstate or intrastate commerce—

(1) A highway route-controlled quantity of a Class 7 (radioactive) material, as defined in §173.403 of this chapter;

(2) More than 25 kg (55 pounds) of a Division 1.1, 1.2, or 1.3 (explosive) material (see §173.50 of this chapter) in a motor vehicle, rail car or freight container;

(3) More than one L (1.06 quarts) per package of a material extremely toxic by inhalation (*i.e.*, "material poisonous by inhalation," as defined in §171.8 of this chapter, that meets the criteria for "hazard zone A," as specified in §173.116(a) or §173.133(a) of this chapter);

(4) A shipment of a quantity of hazardous materials in a bulk packaging (see §171.8 of this chapter) having a capacity equal to or greater than 13,248 L (3,500 gallons) for liquids or gases or more than 13.24 cubic meters (468 cubic feet) for solids;

(5) A shipment in other than a bulk packaging of 2,268 kg (5,000 pounds) gross weight or more of one class of hazardous materials for which placarding of a vehicle, rail car, or freight container is required for that class, under the provisions of subpart F of part 172 of this chapter; or

(6) Except as provided in paragraph (b) of this section, a quantity of hazardous material that requires placarding, under provisions of subpart F of part 172 of this chapter.

(b) Paragraph (a)(6) of this section does not apply to those activities of a farmer, as defined in §171.8 of this chapter, that are in direct support of the farmer's farming operations.

(c) In this subpart, the term "shipment" means the offering or loading of hazardous material at one loading facility using one transport vehicle, or the transport of that transport vehicle.

[65 FR 7309, Feb. 14, 2000, as amended at 67 FR 61011, Sept. 27, 2002]

§ 107.606 Exceptions.

(a) The following are excepted from the requirements of this subpart:

§ 107.608

(1) An agency of the Federal government.

(2) A State agency.

(3) An agency of a political subdivision of a State.

(4) An Indian tribe.

(5) An employee of any of those entities in paragraphs (a)(1) through (a)(4) of this section with respect to the employee's official duties.

(6) A hazmat employee (including, for purposes of this subpart, the owner-operator of a motor vehicle that transports in commerce hazardous materials, if that vehicle at the time of those activities, is leased to a registered motor carrier under a 30-day or longer lease as prescribed in 49 CFR part 376 or an equivalent contractual agreement).

(7) A person domiciled outside the United States, who offers solely from a location outside the United States, hazardous materials for transportation in commerce, *provided* that the country of which such a person is a domiciliary does not require persons domiciled in the United States, who solely offer hazardous materials for transportation to the foreign country from places in the United States, to file a registration statement or to pay a registration fee.

(b) Upon making a determination that persons domiciled in the United States, who offer hazardous materials for transportation to a foreign country solely from places in the United States, must file registration statements or pay fees to that foreign country, the U.S. Competent Authority will provide notice of such determination directly to the Competent Authority of that foreign country and by publication in the FEDERAL REGISTER. Persons who offer hazardous materials for transportation to the United States from that foreign country must file a registration statement and pay the required fee no later than 60 days following publication of the determination in the FEDERAL REGISTER.

[Amdt. 107-34, 60 FR 27233, May 23, 1995, as amended at 63 FR 52847, Oct. 1, 1998; 72 FR 24538, May 3, 2007]

§ 107.608 General registration requirements.

(a) Each person subject to this subpart must submit a complete and accu-

49 CFR Ch. I (10-1-14 Edition)

rate registration statement on DOT Form F 5800.2 not later than June 30 for each registration year, or in time to comply with paragraph (b) of this section, whichever is later. Each registration year begins on July 1 and ends on June 30 of the following year.

(b) No person required to file a registration statement may transport a hazardous material or cause a hazardous material to be transported or shipped, unless such person has on file, in accordance with §107.620, a current Certificate of Registration in accordance with the requirements of this subpart.

(c) A registrant whose name or principal place of business has changed during the year of registration must notify PHMSA of that change by submitting an amended registration statement not later than 30 days after the change.

(d) Copies of DOT Form F 5800.2 and instructions for its completion may be obtained from the Outreach, Training and Grants Division, PHH-50, U.S. Department of Transportation, Washington, DC 20590-0001, by calling 202-366-4109, or via the Internet at <http://phmsa.dot.gov/hazmat/registration>.

(e) If the registrant is not a resident of the United States, the registrant must attach to the registration statement the name and address of a permanent resident of the United States, designated in accordance with §105.40, to serve as agent for service of process.

[Amdt. No. 107-26, 57 FR 30630, July 9, 1992, as amended by Amdt. 107-31, 59 FR 32932, June 27, 1994; 65 FR 7309, Feb. 14, 2000; 67 FR 61011, Sept. 27, 2002; 70 FR 56090, Sept. 23, 2005; 72 FR 55683, Oct. 1, 2007; 76 FR 56311, Sept. 13, 2011]

§ 107.612 Amount of fee.

(a) For purposes of determining the applicable annual registration fee specified in paragraph (b) of this section, the following classification applies to each person required to register and pay a registration fee:

(1) *Small business.* A person that qualifies as a small business, under criteria specified in 13 CFR part 121 applicable to the North American Industry Classification System (NAICS) code that describes that person's primary commercial activity.

Pipeline and Haz. Matls. Safety Admin., DOT

§ 107.620

(2) *Not-for-profit organization.* An organization exempt from taxation under 26 U.S.C. 501(a).

(3) *Other than a small business or not-for-profit organization.* Each person that does not meet the criteria specified in paragraph (a)(1) or (a)(2) of this section.

(b) Each person subject to the requirements of this subpart must pay the processing fee specified in paragraph (c) of this section and the annual registration fee set forth in the following table:

Registration year	Small business	Not-for-profit organization	Other than small business or not-for-profit organization
2014–2015 and later	\$250	\$250	\$2,575
2013–2014	125	125	1,300
2012–2013, 2011–2012, 2010–2011	250	250	2,575
2009–2010, 2008–2009, 2007–2008, 2006–2007	250	250	975
2005–2006, 2004–2005, 2003–2004	125	125	275
2002–2003, 2001–2002, 2000–2001	275	(¹)	1,975
1999–2000 and earlier	250	250	250

¹ Fee appropriate for small or other than small business.

(c) Each person submitting a registration statement must pay the following processing fee in addition to the registration fees specified in paragraph (b) of this section:

(1) For registration years 2000–2001 and later, the processing fee is \$25 for each registration statement filed. A single statement may be filed for one, two, or three registration years as provided in § 107.616(c).

(2) For registration years 1999–2000 and earlier, the processing fee is \$50 for each registration statement filed. A separate statement must be filed for each registration year.

[78 FR 23506, Apr. 19, 2013]

§ 107.616 Payment procedures.

(a) Each person subject to the requirements of this subpart must mail the registration statement and payment in full to the U.S. Department of Transportation, Hazardous Materials Registration, P.O. Box 530273, Atlanta, GA 30353–0273, or submit the statement and payment electronically through the Department’s e-Commerce Internet site. Access to this service is provided at <http://phmsa.dot.gov/hazmat/registration>. A registrant required to file an amended registration statement under § 107.608(c) must mail it to the same address or submit it through the same Internet site.

(b) Payment must be made by certified check, cashier’s check, personal check, or money order in U.S. funds

and drawn on a U.S. bank, payable to the U.S. Department of Transportation and identified as payment for the “Hazmat Registration Fee,” or by completing an authorization for payment by credit card or other electronic means of payment acceptable to the Department on the registration statement or as part of an Internet registration as provided in paragraph (a) of this section.

(c) Payment must correspond to the total fees properly calculated in the “Amount Due” block of the DOT form F 5800.2. A person may elect to register and pay the required fees for up to three registration years by filing one complete and accurate registration statement.

[Amdt. 107–26, 57 FR 30630, July 9, 1992, as amended by Amdt. 107–26, 58 FR 12545, Mar. 5, 1993; 65 FR 7310, Feb. 14, 2000; 67 FR 58345, Sept. 16, 2002; 68 FR 1346, Jan. 9, 2003; 71 FR 54390, Sept. 14, 2006; 72 FR 24538, May 3, 2007; 76 FR 56311, Sept. 13, 2011]

§ 107.620 Recordkeeping requirements.

(a) Each person subject to the requirements of this subpart, or its agent designated under § 107.608(e), must maintain at its principal place of business for a period of three years from the date of issuance of each Certificate of Registration:

- (1) A copy of the registration statement filed with PHMSA; and
- (2) The Certificate of Registration issued to the registrant by PHMSA.

§ 107.701

(b) After January 1, 1993, each motor carrier subject to the requirements of this subpart must carry a copy of its current Certificate of Registration issued by PHMSA or another document bearing the registration number identified as the "U.S. DOT Hazmat Reg. No." on board each truck and truck tractor (not including trailers and semi-trailers) used to transport hazardous materials subject to the requirements of this subpart. The Certificate of Registration or document bearing the registration number must be made available, upon request, to enforcement personnel.

(c) In addition to the requirements of paragraph (a) of this section, after January 1, 1995, each person who transports by vessel a hazardous material subject to the requirements of this subpart must carry on board the vessel a copy of its current Certificate of Registration or another document bearing the current registration number identified as the "U.S. DOT Hazmat Reg. No."

(d) Each person subject to this subpart must furnish its Certificate of Registration (or a copy thereof) and all other records and information pertaining to the information contained in the registration statement to an authorized representative or special agent of DOT upon request.

[Amdt. No. 107-26, 57 FR 30630, July 9, 1992, as amended at 57 FR 37902, Aug. 21, 1992; Amdt. 107-26, 58 FR 12545, Mar. 5, 1993; Amdt. 107-31, 59 FR 32932, June 27, 1994]

Subpart H—Approvals, Registrations and Submissions

SOURCE: Amdt. 107-38, 61 FR 21100, May 9, 1996, unless otherwise noted.

§ 107.701 Purpose and scope.

(a) This subpart prescribes procedures for the issuance, modification and termination of approvals, and the submission of registrations and reports, as required by this chapter.

(b) The procedures of this subpart are in addition to any requirements in subchapter C of this chapter applicable to a specific approval, registration or report. If compliance with both a specific requirement of subchapter C of this chapter and a procedure of this subpart

49 CFR Ch. I (10-1-14 Edition)

is not possible, the specific requirement applies.

(c) Registration under subpart F or G of this part is not subject to the procedures of this subpart.

[Amdt. 107-38, 61 FR 21100, May 9, 1996; Amdt. 107-38, 61 FR 27948, June 3, 1996]

§ 107.705 Registrations, reports, and applications for approval.

(a) A person filing a registration, report, or application for an approval, or a renewal or modification of an approval subject to the provisions of this subpart must—

(1) File the registration, report, or application with the Associate Administrator for Hazardous Materials Safety (Attention: Approvals, PHH-32), Pipeline and Hazardous Materials Safety Administration, U.S. Department of Transportation, East Building, 1200 New Jersey Avenue, SE., Washington, DC 20590-0001. Alternatively, the document with any attached supporting documentation in an appropriate format may be filed by facsimile (fax) to: (202) 366-3753 or (202) 366-3308 or by electronic mail (e-mail) to: approvals@dot.gov.

(2) Identify the section of the chapter under which the registration, report, or application is made;

(3) If a report is required by an approval, a registration or a special permit, identify the approval, registration or special permit number;

(4) Provide the name, street and mailing addresses, e-mail address optional, and telephone number of the person on whose behalf the registration, report, or application is made and, if different, the person making the filing;

(5) If the person on whose behalf the filing is made is not a resident of the United States, provide a designation of agent for service in accordance with § 105.40;

(6) Provide a description of the activity for which the registration or report is required; and

(7) Provide additional information as requested by the Associate Administrator, if the Associate Administrator determines that a filing lacks pertinent information or otherwise does not comply with applicable requirements.

(b) In addition to the provisions in paragraph (a) for an approval, an application for an approval, or an application for modification or renewal of an approval, the applicant must provide—

(1) A description of the activity for which the approval is required;

(2) The proposed duration of the approval;

(3) The transport mode or modes affected, as applicable;

(4) Any additional information specified in the section containing the approval; and

(5) For an approval which provides exceptions from regulatory requirements or prohibitions—

(i) Identification of any increased risk to safety or property that may result if the approval is granted, and specification of the measures that the applicant considers necessary or appropriate to address that risk; and

(ii) Substantiation, with applicable analyses or evaluations, if appropriate, demonstrating that the proposed activity will achieve a level of safety that is at least equal to that required by the regulation.

(c) For an approval with an expiration date, each application for renewal or modification must be filed in the same manner as an original application. If, at least 60 days before an existing approval expires the holder files an application for renewal that is complete and conforms to the requirements of this section, the approval will not expire until final administrative action on the application for renewal has been taken. Operation under an expired approval not filed within 60 days of the expiration date is prohibited. This paragraph does not limit the authority of the Associate Administrator to modify, suspend or terminate an approval under § 107.713.

(d) To request confidential treatment for information contained in the application, the applicant shall comply with § 105.30(a).

[Amdt. 107-38, 61 FR 21100, May 9, 1996, as amended at 65 FR 50457, Aug. 18, 2000; 67 FR 61011, Sept. 27, 2002; 70 FR 56090, Sept. 23, 2005; 70 FR 73162, Dec. 9, 2005; 72 FR 55683, Oct. 1, 2007; 79 FR 15043, Mar. 18, 2014]

§ 107.709 Processing of an application for approval, including an application for renewal or modification.

(a) No public hearing or other formal proceeding is required under this subpart before the disposition of an application.

(b) At any time during the processing of an application, the Associate Administrator may request additional information from the applicant. If the applicant does not respond to a written request for additional information within 30 days of the date the request was received, the application may be deemed incomplete and denied. However, if the applicant responds in writing within the 30-day period requesting an additional 30 days within which it will gather the requested information, the Associate Administrator may grant the 30-day extension.

(c) The Associate Administrator may grant or deny an application, in whole or in part. At the Associate Administrator's discretion, an application may be granted subject to provisions that are appropriate to protect health, safety and property. The Associate Administrator may impose additional provisions not specified in the application, or delete conditions in the application which are unnecessary.

(d) The Associate Administrator may grant an application on finding that—

(1) The application complies with this subpart;

(2) The application demonstrates that the proposed activity will achieve a level of safety that—

(i) Is at least equal to that required by the regulation, or

(ii) If the regulations do not establish a level of safety, is consistent with the public interest and adequately will protect against the risks to life and property inherent in the transportation of hazardous materials in commerce;

(3) The application states all material facts, and contains no materially false or materially misleading statement;

(4) The applicant meets the qualifications required by applicable regulations; and

(5) The applicant is fit to conduct the activity authorized by the approval, or renewal or modification of approval.

§ 107.711

This assessment may be based on information in the application, prior compliance history of the applicant, and other information available to the Associate Administrator.

(e) Unless otherwise specified in this chapter or by the Associate Administrator, an approval in which a term is not specified does not expire.

(f) The Associate Administrator notifies the applicant in writing of the decision on the application. A denial contains a brief statement of reasons.

§ 107.711 Withdrawal.

An application may be withdrawn at any time before a decision to grant or deny it is made. Withdrawal of an application does not authorize the removal of any related records from the PHMSA dockets or files. Applications that are eligible for confidential treatment under §105.30 will remain confidential after the application is withdrawn. The duration of this confidential treatment for trade secrets and commercial or financial information is indefinite, unless the party requesting the confidential treatment of the materials notifies the Associate Administrator that the confidential treatment is no longer required.

[Amdt. 107-38, 61 FR 21100, May 9, 1996, as amended at 67 FR 61011, Sept. 27, 2002]

§ 107.713 Approval modification, suspension or termination.

(a) The Associate Administrator may modify an approval on finding that—

(1) Modification is necessary to conform an existing approval to relevant statutes and regulations as they may be amended from time to time; or

(2) Modification is required by changed circumstances to enable the approval to continue to meet the standards of §107.709(d).

(b) The Associate Administrator may modify, suspend or terminate an approval, as appropriate, on finding that—

(1) Because of a change in circumstances, the approval no longer is needed or no longer would be granted if applied for;

(2) The application contained inaccurate or incomplete information, and the approval would not have been

49 CFR Ch. I (10–1–14 Edition)

granted had the application been accurate and complete;

(3) The application contained deliberately inaccurate or incomplete information; or

(4) The holder knowingly has violated the terms of the approval or an applicable requirement of this chapter in a manner demonstrating lack of fitness to conduct the activity for which the approval is required.

(c) Except as provided in paragraph (d) of this section, before an approval is modified, suspended or terminated, the Associate Administrator notifies the holder in writing of the proposed action and the reasons for it, and provides an opportunity to show cause why the proposed action should not be taken.

(1) The holder may file a written response with the Associate Administrator within 30 days of receipt of notice of the proposed action.

(2) After considering the holder's or party's written response, or after 30 days have passed without response since receipt of the notice, the Associate Administrator notifies the holder in writing of the final decision with a brief statement of reasons.

(d) The Associate Administrator, if necessary to avoid a risk of significant harm to persons or property, may in the notification declare the proposed action immediately effective.

§ 107.715 Reconsideration.

(a) An applicant or a holder may request that the Associate Administrator reconsider a decision under §107.709(f) or §107.713(c). The request must:

(1) Be in writing and filed within 20 days of receipt of the decision;

(2) State in detail any alleged errors of fact and law;

(3) Enclose any additional information needed to support the request to reconsider; and

(4) State in detail the modification of the final decision sought.

(b) The Associate Administrator considers newly submitted information on a showing that the information could not reasonably have been submitted during application processing.

(c) The Associate Administrator grants or denies, in whole or in part,

the relief requested and informs the requesting person in writing of the decision.

§ 107.717 Appeal.

(a) A person who requested reconsideration under §107.715 may appeal to the Administrator the Associate Administrator's decision on the request. The appeal must:

(1) Be in writing and filed within 30 days of receipt of the Associate Administrator's decision on reconsideration;

(2) State in detail any alleged errors of fact and law;

(3) Enclose any additional information needed to support the appeal; and

(4) State in detail the modification of the final decision sought.

(b) The Administrator, if necessary to avoid a risk of significant harm to persons or property, may declare the Associate Administrator's action effective pending a decision on appeal.

(c) The Administrator grants or denies, in whole or in part, the relief requested and informs the appellant in writing of the decision on appeal. The Administrator's decision on appeal is the final administrative action.

Subpart I—Approval of Independent Inspection Agencies, Cylinder Requalifiers, and Non-domestic Chemical Analyses and Tests of DOT Specification Cylinders

SOURCE: 67 FR 51639, Aug. 8, 2002, unless otherwise noted.

§ 107.801 Purpose and scope.

(a) This subpart prescribes procedures for—

(1) A person who seeks approval to be an independent inspection agency to perform tests, inspections, verifications and certifications of DOT specification cylinders or UN pressure receptacles as required by parts 178 and 180 of this chapter;

(2) A person who seeks approval to engage in the requalification (*e.g.* inspection, testing, or certification), rebuilding, or repair of a cylinder manufactured in accordance with a DOT specification or a pressure receptacle in accordance with a UN standard,

under subchapter C of this chapter or under the terms of a special permit issued under this part;

(3) A person who seeks approval to perform the manufacturing chemical analyses and tests of DOT specification cylinders, special permit cylinders, or UN pressure receptacles outside the United States.

(b) No person may engage in a function identified in paragraph (a) of this section unless approved by the Associate Administrator in accordance with the provisions of this subpart. Each person must comply with the applicable requirements in this subpart. In addition, the procedural requirements in subpart H of this part apply to the filing, processing, and termination of an approval issued under this subpart.

[67 FR 51639, Aug. 8, 2002, as amended at 71 FR 33873, June 12, 2006; 78 FR 60750, Oct. 2, 2013]

§ 107.803 Approval of an independent inspection agency (IIA).

(a) *General.* Prior to performing cylinder inspections and verifications required by parts 178 and 180 of this chapter, a person must apply to the Associate Administrator for an approval as an independent inspection agency. A person approved as an independent inspection agency is not an PHMSA agent or representative.

(b) *Criteria.* No applicant for approval as an independent inspection agency may be engaged in the manufacture of cylinders for use in the transportation of hazardous materials, or be directly or indirectly controlled by, or have a financial involvement with, any entity that manufactures cylinders for use in the transportation of hazardous materials, except for providing services as an independent inspector.

(c) *Application information.* Each applicant must submit an application in conformance with §107.705 containing the information prescribed in §107.705(a). In addition, the application must contain the following information:

(1) Name and address of each facility where tests and inspections are to be performed.

(2) Detailed description of the inspection and testing facilities to be used by the applicant.

§ 107.805

49 CFR Ch. I (10–1–14 Edition)

(3) Detailed description of the applicant's qualifications and ability to perform the inspections and to verify the inspections required by part 178 of this chapter or under the terms of a special permit issued under this part.

(4) Name, address, and principal business activity of each person having any direct or indirect ownership interest in the applicant greater than three percent and any direct or indirect ownership interest in each subsidiary or division of the applicant.

(5) Name of each individual whom the applicant proposes to employ as an inspector and who will be responsible for certifying inspection and test results, and a statement of that person's qualifications.

(6) An identification or qualification number assigned to each inspector who is supervised by a certifying inspector identified in paragraph (c)(5) of this section.

(7) A statement that the applicant will perform its functions independent of the manufacturers and owners of the cylinders.

(8) If the applicant's principal place of business is in a country other than the United States, the Associate Administrator may approve the applicant on the basis of an approval issued by the Competent Authority of the country of manufacture. The Competent Authority must maintain a current listing of approved IIAs and their identification marks. The applicant must provide a copy of the designation from the Competent Authority of that country delegating to the applicant an approval or designated agency authority for the type of packaging for which a DOT or UN designation is sought; and

(9) The signature of the person certifying the approval application and the date on which it was signed.

(d) *Facility inspection.* Upon the request of the Associate Administrator, the applicant must allow the Associate Administrator or the Associate Administrator's designee to inspect the applicant's facilities and records. The person seeking approval must bear the cost of the inspection.

(e) After approval, the Associate Administrator may authorize, upon request, the independent inspection agency to perform other inspections and

functions for which the Associate Administrator finds the applicant to be qualified. Such additional authorizations will be noted on each inspection agency's approval documents.

[67 FR 51639, Aug. 8, 2002, as amended at 68 FR 24659, May 8, 2003; 71 FR 33873, June 12, 2006; 78 FR 60750, Oct. 2, 2013]

§ 107.805 Approval of cylinder and pressure receptacle requalifiers.

(a) *General.* A person must meet the requirements of this section to be approved to inspect, test, certify, repair, or rebuild a cylinder in accordance with a DOT specification or a UN pressure receptacle under subpart C of part 178 or subpart C of part 180 of this chapter, or under the terms of a special permit issued under this part.

(b) *Independent Inspection Agency Review.* Each applicant must arrange for an independent inspection agency, approved by the Associate Administrator pursuant to this subpart, to perform a review of its inspection or requalification operation. The person seeking approval must bear the cost of the inspection. A list of approved independent inspection agencies is available from the Associate Administrator at the address listed in §107.705. Assistance in obtaining an approval is available from the same address.

(c) *Application for approval.* If the inspection performed by an independent inspection agency is completed with satisfactory results, the applicant must submit a letter of recommendation from the independent inspection agency, an inspection report, and an application containing the information prescribed in §107.705(a). In addition, the application must contain—

(1) The name of the facility manager;

(2) The types of DOT specification or special permit cylinders, or UN pressure receptacles that will be inspected, tested, repaired, or rebuilt at the facility;

(3) A certification that the facility will operate in compliance with the applicable requirements of subchapter C of this chapter; and

(4) The signature of the person making the certification and the date on which it was signed.

(d) *Issuance of requalifier identification number (RIN).* The Associate Administrator issues a RIN as evidence of approval to requalify DOT specification or special permit cylinders, or UN pressure receptacles if it is determined, based on the applicant's submission and other available information, that the applicant's qualifications and, when applicable, facility are adequate to perform the requested functions in accordance with the criteria prescribed in subpart C of part 180 of this subchapter.

(e) *Expiration of RIN.* Unless otherwise provided in the issuance letter, an approval expires five years from the date of issuance, provided the applicant's facility and qualifications are maintained at or above the level observed at the time of inspection by the independent inspection agency, or at the date of the certification in the application for approval for requalifiers only performing inspections made under § 180.209(g) of this chapter.

(f) *Exceptions.* Notwithstanding the requirements in paragraphs (b) and (c) of this section, a person who only performs inspections in accordance with § 180.209(g) of this chapter may submit an application that, in addition to the information prescribed in § 107.705(a), identifies the DOT specification/special permit cylinders to be inspected; certifies the requalifier will operate in compliance with the applicable requirements of subchapter C of this chapter; certifies the persons performing inspections have been trained and have the information contained in each applicable CGA pamphlet incorporated by reference in § 171.7 of this chapter applicable to the requalifiers' activities; and includes the signature of the person making the certification and the date on which it was signed. Each person must comply with the applicable requirements in this subpart. In addition, the procedural requirements in subpart H of this part apply to the filing, processing and termination of an approval issued under this subpart. No person may requalify a DOT specification/special permit cylinder in accordance with § 180.209(g) of this chapter unless that person has been issued a RIN as provided in paragraph (d) of this section.

(g) Each holder of a current RIN shall report in writing any change in its name, address, ownership, testing equipment, or management or personnel performing any function under this section, to the Associate Administrator (PHH-32) within 20 days of the change.

[67 FR 51639, Aug. 8, 2002, as amended at 68 FR 24659, May 8, 2003; 68 FR 55544, Sept. 26, 2003; 70 FR 56090, Sept. 23, 2005; 70 FR 73162, Dec. 9, 2005; 71 FR 33873, June 12, 2006; 76 FR 56311, Sept. 13, 2011]

§ 107.807 Approval of non-domestic chemical analyses and tests.

(a) *General.* A person who seeks to manufacture DOT specification or special permit cylinders outside the United States must seek an approval from the Associate Administrator to perform the chemical analyses and tests of those cylinders outside the United States.

(b) *Application for approval.* Each applicant must submit an application containing the information prescribed in § 107.705(a). In addition, the application must contain—

(1) The name, address, and a description of each facility at which cylinders are to be manufactured and chemical analyses and tests are to be performed;

(2) Complete details concerning the dimensions, materials of construction, wall thickness, water capacity, shape, type of joints, location and size of openings and other pertinent physical characteristics of each specification or special permit cylinder for which approval is being requested, including calculations for cylinder wall stress and wall thickness, which may be shown on a drawing or on separate sheets attached to a descriptive drawing;

(3) The name of the independent inspection agency to be used; and

(4) The signature of the person making the certification and the date on which it was signed.

(c) *Facility inspections.* Upon the request of the Associate Administrator, the applicant must allow the Associate Administrator or the Associate Administrator's designee to inspect the applicant's cylinder manufacturing and testing facilities and records, and must provide such materials and cylinders

§ 107.809

for analyses and tests as the Associate Administrator may specify. The applicant or holder must bear the cost of the initial and subsequent inspections, analyses, and tests.

§ 107.809 Conditions of UN pressure receptacle approvals.

(a) Each approval issued under this subpart contains the following conditions:

(1) Upon the request of the Associate Administrator, the applicant or holder must allow the Associate Administrator or the Associate Administrator's designee to inspect the applicant's pressure receptacle manufacturing and testing facilities and records, and must provide such materials and pressure receptacles for analyses and tests as the Associate Administrator may specify. The applicant or holder must bear the cost of the initial and subsequent inspections, analyses, and tests.

(2) Each holder must comply with all of the terms and conditions stated in the approval letter issued under this subpart.

(b) In addition to the conditions specified in §107.713, an approval may be denied or if issued, suspended or terminated if the Competent Authority of the country of manufacture fails to initiate, maintain or recognize an IIA approved under this subpart; fails to recognize UN standard packagings manufactured in accordance with this subchapter; or implements a condition or limitation on United States citizens or organizations that is not required of its own citizenry.

[71 FR 33874, June 12, 2006]

PART 109—DEPARTMENT OF TRANSPORTATION HAZARDOUS MATERIAL PROCEDURAL REGULATIONS

Subpart A—Definitions

Sec.

109.1 Definitions.

Subpart B—Inspections and investigations

109.3 Inspections and investigations.

109.5 Opening of packages.

109.7 Removal from transportation.

109.9 Transportation for examination and analysis.

49 CFR Ch. I (10–1–14 Edition)

109.11 Assistance of properly qualified personnel.

109.13 Closing packages/safe resumption of transportation.

109.15 Termination.

109.16 Notification of enforcement measures.

Subpart C—Emergency Orders

109.17 Emergency orders.

109.19 Petitions for review of emergency orders.

109.21 Remedies generally.

Subpart D—Equipment

109.25 Equipment.

Subpart E—Prohibition on Hazardous Materials Operations After Nonpayment of Penalties

109.101 Prohibition of hazardous materials operations.

109.103 Notice of nonpayment of penalties.

AUTHORITY: 49 U.S.C. 5101–5128, 44701; Pub. L. 101–410 Sec. 4 (28 U.S.C. 2461 note); Pub. L. 104–121 Secs. 212–213; Pub. L. 104–134 Sec. 31001; 49 CFR 1.81, 1.97.

SOURCE: 76 FR 11592, Mar. 2, 2011, unless otherwise noted.

Subpart A—Definitions

§ 109.1 Definitions.

For purposes of this part, all terms defined in 49 U.S.C. 5102 are used in their statutory meaning. Other terms used in this part are defined as follows:

Administrator means the head of any operating administration within the Department of Transportation, and includes the Administrators of the Federal Aviation Administration, Federal Motor Carrier Safety Administration, Federal Railroad Administration, and Pipeline and Hazardous Materials Safety Administration, to whom the Secretary has delegated authority in part 1 of this title, and any person within an operating administration to whom an Administrator has delegated authority to carry out this part.

Agent of the Secretary or *agent* means a Federal officer, employee, or agent authorized by the Secretary to conduct inspections or investigations under the Federal hazardous material transportation law.

Chief Safety Officer or *CSO* means the Assistant Administrator of the Pipeline and Hazardous Materials Safety Administration.

Emergency order means an emergency restriction, prohibition, recall, or out-of-service order set forth in writing.

Freight container means a package configured as a reusable container that has a volume of 64 cubic feet or more, designed and constructed to permit being lifted with its contents intact and intended primarily for containment of smaller packages (in unit form) during transportation.

Immediately adjacent means a packaging that is in direct contact with the hazardous material or is otherwise the primary means of containment of the hazardous material.

Imminent hazard means the existence of a condition relating to hazardous material that presents a substantial likelihood that death, serious illness, severe personal injury, or a substantial endangerment to health, property, or the environment may occur before the reasonably foreseeable completion date of a formal proceeding begun to lessen the risk of that death, illness, injury, or endangerment.

In writing means unless otherwise specified, the written expression of any actions related to this part, rendered in paper or digital format, and delivered in person; via facsimile, commercial delivery, U.S. Mail; or electronically.

Objectively reasonable and articulable belief means a belief based on particularized and identifiable facts that provide an objective basis to believe or suspect that a package may contain a hazardous material.

Out-of-service order means a written requirement issued by the Secretary, or a designee, that an aircraft, vessel, motor vehicle, train, railcar, locomotive, other vehicle, transport unit, transport vehicle, freight container, portable tank, or other package not be moved or cease operations until specified conditions have been met.

Packaging means a receptacle and any other components or materials necessary for the receptacle to perform its containment function in conformance with the minimum packing requirements of this subchapter. For ra-

dioactive materials packaging, see §173.403 of subchapter C of this chapter.

Perishable hazardous material means a hazardous material that is subject to significant risk of speedy decay, deterioration, or spoilage, or hazardous materials consigned for medical use, in the prevention, treatment, or cure of a disease or condition in human beings or animals where expeditious shipment and delivery meets a critical medical need.

Properly qualified personnel means a company, partnership, proprietorship, or individual who is technically qualified to perform designated tasks necessary to assist an agent in inspecting, examining, opening, removing, testing, or transporting packages.

Related packages means any packages in a shipment, series or group of packages that can be traced to a common nexus of facts, including, but not limited to: The same offeror or packaging manufacturer; the same hazard communications information (marking, labeling, shipping documentation); or other reasonable and articulable facts that may lead an agent to believe such packages are related to a package that may pose an imminent hazard. Packages that are located within the same trailer, freight container, unit load device, *etc.* as a package removed subject to this enhanced authority without additional facts to substantiate its nexus to an imminent hazard are not "related packages" for purposes of removal. The related packages must also demonstrate that they may pose an imminent hazard. They must exhibit a commonality or nexus of origin, which may include, but are not limited to, a common offeror, package manufacturer, marking, labeling, shipping documentation, hazard communications, *etc.*

Remove means to keep a package from entering the stream of transportation in commerce; to take a package out of the stream of transportation in commerce by physically detaining a package that was offered for transportation in commerce; or stopping a package from continuing in transportation in commerce.

Safe and expeditious means prudent measures or procedures designed to minimize delay.

Subpart B—Inspections and Investigations

§ 109.3 Inspections and Investigations.

(a) *General authority.* An Administrator may initiate an inspection or investigation to determine compliance with Federal hazardous material transportation law, or a regulation, order, special permit, or approval prescribed or issued under the Federal hazardous material transportation law, or any court decree or order relating thereto.

(b) *Inspections and investigations.* Inspections and investigations are conducted by designated agents of the Secretary who will, upon request, present their credentials for examination. Such an agent is authorized to:

(1) Administer oaths and receive affirmations in any matter under investigation.

(2) Gather information by any reasonable means, including, but not limited to, gaining access to records and property (including packages), interviewing, photocopying, photographing, and video- and audio-recording in a reasonable manner.

(3) Serve subpoenas for the production of documents or other tangible evidence if, on the basis of information available to the agent, the evidence is relevant to a determination of compliance with the Federal hazardous material transportation law, regulation, order, special permit, or approval prescribed or issued under the Federal hazardous material transportation law, or any court decree or order relating thereto. Service of a subpoena shall be in accordance with the requirements of the agent's operating administration as set forth in 14 CFR 13.3 (Federal Aviation Administration); 49 CFR 209.7 (Federal Railroad Administration), 49 U.S.C. 502(d), 5121(a) (Federal Motor Carrier Safety Administration), and 49 CFR 105.45–105.55 (Pipeline and Hazardous Materials Safety Administration).

§ 109.5 Opening of packages.

(a) *In general.* Except as provided in paragraph (b):

(1) Stop movement of the package in transportation and gather information from any person to learn the nature and contents of the package;

(2) Open any overpack, outer packaging, or other component of the package that is not immediately adjacent to the hazardous materials contained in the package and examine the inner packaging(s) or packaging components.

(b) *Perishable hazardous material.* To ensure the expeditious transportation of a package containing a perishable hazardous material, an agent will utilize appropriate alternatives before exercising an authority under paragraph (a) of this section.

[76 FR 11592, Mar. 2, 2011, as amended at 78 FR 60763, Oct. 2, 2013]

§ 109.7 Removal from transportation.

An agent may remove a package and related packages in a shipment or a freight container from transportation in commerce for up to forty-eight (48) hours when the agent has an objectively reasonable and articulable belief that the packages may pose an imminent hazard. The agent must record this belief in writing as soon as practicable and provide written notification stating the reason for removal to the person in possession.

§ 109.9 Transportation for examination and analysis.

(a) An agent may direct a package to be transported to a facility for examination and analysis when the agent determines that:

(1) Further examination of the package is necessary to evaluate whether the package conforms to subchapter C of this chapter;

(2) Conflicting information concerning the package exists; or

(3) Additional investigation is not possible on the immediate premises.

(b) In the event of a determination in accordance with paragraph (a) of this section, an agent may:

(1) Direct the offeror of the package, or other person responsible for the package, to have the package transported to a facility where the material may be examined and analyzed;

(2) Direct the packaging manufacturer or tester of the packaging to have the package transported to a facility where the packaging may be tested in accordance with the HMR; or

(3) Direct the carrier to transport the package to a facility capable of conducting such examination and analysis.

(c) The 48-hour removal period provided in §109.7 may be extended in writing by the Administrator pending the conclusion of examination and analysis under this section.

§ 109.11 Assistance of properly qualified personnel.

An agent may authorize properly qualified personnel to assist in the activities conducted under this part if the agent is not properly qualified to perform a function that is essential to the agent's exercise of authority under this part or when safety might otherwise be compromised by the agent's performance of such a function.

§ 109.13 Closing packages and safe resumption of transportation.

(a) *No imminent hazard found.* If, after an agent exercises an authority under §109.5, the agent finds that no imminent hazard exists, and the package otherwise conforms to applicable requirements in subchapter C of this chapter, the agent will:

(1) Assist in preparing the package for safe and prompt transportation, when practicable, by reclosing the package in accordance with the packaging manufacturer's closure instructions or other appropriate closure method;

(2) Mark and certify the reclosed package to indicate that it was opened and reclosed in accordance with this part;

(3) Return the package to the person from whom the agent obtained it, as soon as practicable; and

(4) For a package containing a perishable hazardous material, assist in resuming the safe and expeditious transportation of the package as soon as practicable after determining that the package presents no imminent hazard.

(b) *Imminent hazard found.* If an imminent hazard is found to exist after an agent exercises an authority under §109.5, the Administrator or his/her designee may issue an out-of-service order prohibiting the movement of the package until the package has been brought into compliance with sub-

chapter C of this chapter. Upon receipt of the out-of-service order, the person in possession of, or responsible for, the package must remove the package from transportation until it is brought into compliance.

(c) *Package does not contain hazardous material.* If, after an agent exercises an authority under §109.5, the agent finds that a package does not contain a hazardous material, the agent shall securely close the package, mark and certify the reclosed package to indicate that it was opened and reclosed, and return the package to transportation.

(d) *Non-compliant package.* If, after an agent exercises an authority under §109.5, the agent finds that a package contains hazardous material and does not conform to requirements in subchapter C of this chapter, but does not present an imminent hazard, the agent will return the package to the person in possession of the package at the time the non-compliance is discovered for appropriate corrective action. A non-compliant package may not continue in transportation until all identified non-compliance issues are resolved.

§ 109.15 Termination.

When the facts disclosed by an investigation indicate that further action is not warranted under this part at the time, the Administrator will close the investigation without prejudice to further investigation and notify the person being investigated of the decision. Nothing herein precludes civil enforcement action at a later time related to the findings of the investigation.

§ 109.16 Notification of enforcement measures.

In addition to complying with the notification requirements in §109.7 of this part, an agent, after exercising an authority under this subpart, will immediately take reasonable measures to notify the offeror and the person in possession of the package, providing the reason for the action being taken, the results of any preliminary investigation including apparent violations of subchapter C of this chapter, and

§ 109.17

any further action that may be warranted.

[78 FR 60763, Oct. 2, 2013]

Subpart C—Emergency Orders

§ 109.17 Emergency Orders.

(a) *Determination of imminent hazard.* When an Administrator determines that a violation of a provision of the Federal hazardous material transportation law, or a regulation or order prescribed under that law, or an unsafe condition or practice, constitutes or is causing an imminent hazard, as defined in §109.1, the Administrator may issue or impose emergency restrictions, prohibitions, recalls, or out-of-service orders, without advance notice or an opportunity for a hearing. The basis for any action taken under this section shall be set forth in writing which must—

(1) Describe the violation, condition, or practice that constitutes or is causing the imminent hazard;

(2) Set forth the terms and conditions of the emergency order;

(3) Be limited to the extent necessary to abate the imminent hazard; and,

(4) Advise the recipient that, within 20 calendar days of the date the order is issued, recipient may request review; and that any request for a formal hearing in accordance with 5 U.S.C. 554 must set forth the material facts in dispute giving rise to the request for a hearing; and

(5) Set forth the filing and service requirements contained in §109.19(f), including the address of DOT Docket Operations and of all persons to be served with the petition for review.

(b) *Out-of-service order.* An out-of-service order is issued to prohibit the movement of an aircraft, vessel, motor vehicle, train, railcar, locomotive, transport unit, transport vehicle, or other vehicle, or a freight container, portable tank, or other package until specified conditions of the out-of-service order have been met.

(1) Upon receipt of an out-of-service order, the person in possession of, or responsible for, the package must remove the package from transportation until it is brought into compliance with the out-of-service order.

49 CFR Ch. I (10–1–14 Edition)

(2) A package subject to an out-of-service order may be moved from the place where it was found to present an imminent hazard to the nearest location where the package can be brought into compliance, provided that the agent who issued the out-of-service order is notified before the move.

(3) The recipient of the out-of-service order must notify the operating administration that issued the order when the package is brought into compliance.

(4) Upon receipt of an out-of-service order, a recipient may appeal the decision of the agent issuing the order to PHMSA's Chief Safety Officer. A petition for review of an out-of-service order must meet the requirements of §109.19.

(c) *Recalls.* PHMSA's Associate Administrator, Office of Hazardous Materials Safety, may issue an emergency order mandating the immediate recall of any packaging, packaging component, or container certified, represented, marked, or sold as qualified for use in the transportation of hazardous materials in commerce when the continued use of such item would constitute an imminent hazard. All petitions for review of such an emergency order will be governed by the procedures set forth at §109.19.

§ 109.19 Petitions for review of emergency orders.

(a) *Petitions for review.* A petition for review must—

(1) Be in writing;

(2) State with particularity each part of the emergency order that is sought to be amended or rescinded and include all information, evidence and arguments in support thereof;

(3) State whether a formal hearing in accordance with 5 U.S.C. 554 is requested, and, if so, the material facts in dispute giving rise to the request for a hearing; and,

(4) Be filed and served in accordance with §109.19(f).

(b) *Response to the petition for review.* An attorney designated by the Office of Chief Counsel of the operating administration issuing the emergency order may file and serve, in accordance with §109.19(f), a response, including appropriate pleadings, within five calendar

days of receipt of the petition by the Chief Counsel of the operating administration issuing the emergency order.

(c) *Chief Safety Officer Responsibilities.*

(1) *Hearing requested.* Upon receipt of a petition for review of an emergency order that includes a formal hearing request and states material facts in dispute, the Chief Safety Officer shall immediately assign the petition to the Office of Hearings. Unless the Chief Safety Officer issues an order stating that the petition fails to set forth material facts in dispute and will be decided under paragraph (c)(2) of this section, a petition for review including a formal hearing request will be deemed assigned to the Office of Hearings three calendar days after the Chief Safety Officer receives it.

(2) *No hearing requested.* For a petition for review of an emergency order that does not include a formal hearing request or fails to state material facts in dispute, the Chief Safety Officer shall issue an administrative decision on the merits within 30 days of receipt of the petition. The Chief Safety Officer's decision constitutes final agency action.

(d) *Hearings.* Formal hearings shall be conducted by an Administrative Law Judge assigned by the Chief Administrative Law Judge of the Office of Hearings. The Administrative Law Judge may:

(1) Administer oaths and affirmations;

(2) Issue subpoenas as provided by the appropriate agency regulations (49 CFR 209.7, 49 CFR 105.45, 14 CFR 13.3, and 49 U.S.C. 502 and 31133);

(3) Adopt the relevant Federal Rules of Civil Procedure for the United States District Courts for the procedures governing the hearings when appropriate;

(4) Adopt the relevant Federal Rules of Evidence for United States Courts and Magistrates for the submission of evidence when appropriate;

(5) Take or cause depositions to be taken;

(6) Examine witnesses at the hearing;

(7) Rule on offers of proof and receive relevant evidence;

(8) Convene, recess, adjourn or otherwise regulate the course of the hearing;

(9) Hold conferences for settlement, simplification of the issues, or any other proper purpose; and,

(10) Take any other action authorized by or consistent with the provisions of this part and permitted by law that may expedite the hearing or aid in the disposition of an issue raised therein.

(e) *Parties.* The petitioner may appear and be heard in person or by an authorized representative. The operating administration issuing the emergency order shall be represented by an attorney designated by its respective Office of Chief Counsel.

(f) *Filing and service.* (1) Each petition, pleading, motion, notice, order, or other document submitted in connection with an order issued under this subpart must be filed (commercially delivered or submitted electronically) with: U.S. Department of Transportation, Docket Operations, M-30, West Building Ground Floor, Room W12-140, 1200 New Jersey Avenue, SE., Washington, DC 20590. All documents filed will be published on the Department's docket management Web site, <http://www.regulations.gov>. The emergency order shall state the above filing requirements and the address of DOT Docket Operations.

(2) *Service.* Each document filed in accordance with paragraph (f)(1) of this section must be concurrently served upon the following persons:

(i) Chief Safety Officer (*Attn:* Office of Chief Counsel, PHC), Pipeline and Hazardous Materials Safety Administration, U.S. Department of Transportation, 1200 New Jersey Avenue, SE., East Building, Washington, DC 20590 (*facsimile:* 202-366-7041) (*electronic mail:* PHMSAChiefCounsel@dot.gov);

(ii) The Chief Counsel of the operating administration issuing the emergency order;

(iii) If the petition for review requests a formal hearing, the Chief Administrative Law Judge, U.S. Department of Transportation, Office of Hearings, M-20, Room E12-320, 1200 New Jersey Avenue, SE., Washington, DC 20590 (*facsimile:* 202-366-7536).

(iv) Service shall be made personally, by commercial delivery service, or by electronic means if consented to in writing by the party to be served, except as otherwise provided herein. The

§ 109.21

emergency order shall state all relevant service requirements and list the persons to be served and may be updated as necessary. The emergency order shall also be published in the FEDERAL REGISTER as soon as practicable after its issuance.

(3) Certificate of service. Each order, pleading, motion, notice, or other document shall be accompanied by a certificate of service specifying the manner in which and the date on which service was made.

(4) The emergency order shall be served by “hand delivery,” unless such delivery is not practicable, or by electronic means if consented to in writing by the party to be served.

(5) Service upon a person’s duly authorized representative, agent for service, or an organization’s president constitutes service upon that person.

(g) *Report and recommendation.* The Administrative Law Judge shall issue a report and recommendation at the close of the record. The report and recommendation shall:

(1) Contain findings of fact and conclusions of law and the grounds for the decision based on the material issues of fact or law presented on the record;

(2) Be served on the parties to the proceeding; and

(3) Be issued no later than 25 days after receipt of the petition for review by the Chief Safety Officer.

(h) *Expiration of order.* If the Chief Safety Officer, or the Administrative Law Judge, where appropriate, has not disposed of the petition for review within 30 days of receipt, the emergency order shall cease to be effective unless the Administrator issuing the emergency order determines, in writing, that the imminent hazard providing a basis for the emergency order continues to exist. The requirements of such an extension shall remain in full force and effect pending decision on a petition for review unless stayed or modified by the Administrator.

(i) *Reconsideration.*

(1) A party aggrieved by the Administrative Law Judge’s report and recommendation may file a petition for reconsideration with the Chief Safety Officer within one calendar day of service of the report and recommendation. The opposing party may file a response

49 CFR Ch. I (10–1–14 Edition)

to the petition within one calendar day of service of a petition for reconsideration.

(2) The Chief Safety Officer shall issue a final agency decision within three calendar days of service of the final pleading, but no later than 30 days after receipt of the original petition for review.

(3) The Chief Safety Officer’s decision on the merits of a petition for reconsideration constitutes final agency action.

(j) *Appellate review.* A person aggrieved by the final agency action may petition for review of the final decision in the appropriate Court of Appeals for the United States as provided in 49 U.S.C. 5127. The filing of the petition for review does not stay or modify the force and effect of the final agency.

(k) *Time.* In computing any period of time prescribed by this part or by an order issued by the Administrative Law Judge, the day of filing of the petition for review or of any other act, event, or default from which the designated period of time begins to run shall not be included. The last day of the period so computed shall be included, unless it is a Saturday, Sunday, or Federal holiday, in which event the period runs until the end of the next day which is not one of the aforementioned days.

§ 109.21 Remedies generally.

An Administrator may request the Attorney General to bring an action in the appropriate United States district court seeking temporary or permanent injunctive relief, punitive damages, assessment of civil penalties as provided by 49 U.S.C. 5122(a), and any other appropriate relief to enforce the Federal hazardous material transportation law, regulation, order, special permit, or approval prescribed or issued under the Federal hazardous material transportation law.

Subpart D—Equipment

SOURCE: 78 FR 60763, Oct. 2, 2013, unless otherwise noted.

§ 109.25 Equipment.

When an agent exercises an authority under subpart B of this part, the agent

shall use the appropriate safety, handling, and other equipment authorized by his or her operating administration's equipment requirements for hazardous material inspectors and investigators.

Subpart E—Prohibition on Hazardous Materials Operations After Nonpayment of Penalties

SOURCE: 79 FR 46199, Aug. 7, 2014, unless otherwise noted.

§ 109.101 Prohibition of hazardous materials operations.

(a) *Definition of hazardous materials operations.* For the purposes of this subpart, hazardous materials operations means any activity regulated under the Federal hazardous material transportation law, this subchapter or subchapter C of this chapter, or an exemption or special permit, approval, or registration issued under this subchapter or under subchapter C of this chapter.

(b) *Failure to pay civil penalty in full.* A respondent that fails to pay a hazardous material civil penalty in full within 90 days after the date specified for payment by an order of the Pipeline and Hazardous Materials Safety Administration, Federal Aviation Administration, Federal Motor Carrier Safety Administration, or Federal Railroad Administration is prohibited from conducting hazardous materials operations and shall immediately cease all hazardous materials operations beginning on the next day (*i.e.*, the 91st). The prohibition shall continue until payment of the penalty has been made in full or at the discretion of the agency issuing the order an acceptable payment plan has been arranged.

(c) *Civil penalties paid in installments.* On a case by case basis, a respondent may be allowed to pay a civil penalty pursuant to a payment plan, which may consist of installment payments. If the respondent fails to make an installment payment contained in the payment plan on the agreed upon schedule, the payment plan shall be null and void and the full outstanding balance of the civil penalty shall be payable immediately. A respondent that fails to pay the full outstanding

balance of its civil penalty within 90 days after the date of the missed installment payment shall be prohibited from conducting hazardous materials operations beginning on the next day (*i.e.*, the 91st). The prohibition shall continue until payment of the outstanding balance of the civil penalty has been made in full, including any incurred interest or until at the discretion of the agency issuing the order another acceptable payment plan has been arranged.

(d) *Appeals to Federal Court.* If the respondent appeals an agency order issued pursuant to § 109.103 to a Federal Circuit Court of Appeals, the terms and payment due date of the order are not stayed unless the Court so specifies.

(e) *Applicability to ticketing.* This section does not apply to a respondent who fails to pay a civil penalty assessed by a ticket issued pursuant to § 107.310 of this subchapter.

(f) *Applicability to debtors.* This section does not apply to a respondent who is unable to pay a civil penalty because the respondent is a debtor in a case under chapter 11, title 11, United States Code. A respondent who is a debtor in a case under chapter 11, title 11, United States Code must provide the following information to the agency decision maker identified in the original agency order or on its certificate of service.

(1) The chapter of the Bankruptcy Code under which the bankruptcy proceeding is filed;

(2) The bankruptcy case number;

(3) The court in which the bankruptcy proceeding was filed; and

(4) Any other information requested by the agency to determine a debtor's bankruptcy status.

(g) *Penalties for prohibited hazardous materials operations.* A respondent that continues to conduct hazardous materials operations in violation of this section may be subject to additional penalties, including criminal prosecution pursuant to 49 U.S.C. 5124.

§ 109.103 Notice of nonpayment of penalties.

(a) If a full payment of a civil penalty, or an installment payment as part of agreed upon payment plan, has not been made within 45 days after the

date specified for payment by the final agency order, the agency may issue a cessation of hazardous materials operations order to the respondent.

(b) The cessation of hazardous materials operations order issued under this section shall include the following information:

(1) A citation to the statutory provision or regulation the respondent was found to have violated and to the terms of the order or agreement requiring payment;

(2) A statement indicating that if the respondent fails to pay the full outstanding balance of the civil penalty within 90 days after the payment due date, the respondent shall be prohibited from conducting any activity regulated under the Federal hazardous material transportation law, this subchapter or subchapter C of this chapter, or an exemption or special permit, approval, or registration issued under this subchapter or under subchapter C of this chapter;

(3) A statement describing the respondent's options for responding to the order which will include an option to file an appeal for reconsideration of the cessation of operations order within 20 days of receipt of the order; and

(4) A description of the manner in which the respondent can make payment of any money due the United States as a result of the proceeding (*i.e.*, the full outstanding balance of the civil penalty).

(c) The cessation of hazardous materials operation order will be delivered by personal service, unless such service is impossible or impractical. If personal service is impossible or impractical then service may be made by certified mail or commercial express service. If a respondent's principal place of business is in a foreign country, it will be delivered to the respondent's designated agent (as prepared in accordance with §105.40 of this subchapter).

PART 110—HAZARDOUS MATERIALS PUBLIC SECTOR TRAINING AND PLANNING GRANTS

Sec.

110.1 Purpose.

110.5 Scope.

110.7 Control Number under the Paperwork Reduction Act.

110.10 Eligibility.

110.20 Definitions.

110.30 Grant application.

110.40 Activities eligible for funding.

110.50 Disbursement of Federal funds.

110.60 Cost sharing for planning and training.

110.70 Financial administration.

110.80 Procurement.

110.90 Grant monitoring, reports, and records retention.

110.100 Enforcement.

110.110 After-grant requirements.

110.120 Deviation from this part.

110.130 Disputes.

AUTHORITY: 49 U.S.C. 5101–5127; 49 CFR 1.53.

SOURCE: Amdt. 110–1, 57 FR 43067, Sept. 17, 1992, unless otherwise noted.

EDITORIAL NOTE: Nomenclature changes to part 110 appear at 70 FR 56090, Sept. 23, 2005.

§ 110.1 Purpose.

This part sets forth procedures for reimbursable grants for public sector planning and training in support of the emergency planning and training efforts of States, Indian tribes, and local communities to deal with hazardous materials emergencies, particularly those involving transportation. These grants will enhance the implementation of the Emergency Planning and Community Right-to-Know Act of 1986 (42 U.S.C. 11001).

§ 110.5 Scope.

(a) This part applies to States and Indian tribes and contains the program requirements for public sector training and planning grants to support hazardous materials emergency planning and training efforts.

(b) The requirements contained in 49 CFR part 18, “Uniform Administrative Requirements for Grants and Cooperative Agreements to State and Local Governments”, apply to grants issued under this part.

(c) Copies of standard forms and OMB circulars referenced in this part are available from the HMTUSA Grants Manager, Pipeline and Hazardous Materials Safety Administration, U.S. Department of Transportation, East Building, 1200 New Jersey Avenue, SE., Washington DC 20590–0001.

[Amdt. 110–1, 57 FR 43067, Sept. 17, 1992, as amended at 72 FR 55683, Oct. 1, 2007]

§ 110.7 Control Number under the Paperwork Reduction Act.

The Office of Management and Budget control number assigned to collection of information in §§ 110.30, 110.70, 110.80, and 110.90 is 2137-0586.

§ 110.10 Eligibility.

This part applies to States and Indian tribes. States may apply for planning and training grants. Federally-recognized Indian tribes may apply for training grants.

§ 110.20 Definitions.

Unless defined in this part, all terms defined in 49 U.S.C. 5102 are used in their statutory meaning and all terms defined in 49 CFR part 18 and OMB Circular A-102, with respect to administrative requirements for grants, are used as defined therein. Other terms used in this part are defined as follows:

Allowable costs means those costs that are: eligible, reasonable, necessary, and allocable to the project permitted by the appropriate Federal cost principles, and approved in the grant.

Associate Administrator means the Associate Administrator for Hazardous Materials Safety, Pipeline and Hazardous Materials Safety Administration.

Budget period means the period of time specified in the grant agreement during which the project manager may expend or obligate project funds.

Cost review means the review and evaluation of costs to determine reasonableness, allocability, and allowability.

Indian country means Indian country as defined in 18 U.S.C. 1151. That section defines Indian country as all land within the limits of any reservation under the jurisdiction of the U.S. Government, notwithstanding the issuance of any patent, and, including rights-of-way running through the reservation; all dependent Indian communities within the borders of the United States whether within the original or subsequently acquired territory thereof, and whether within or without the limits of a State; and all Indian allotments, the Indian titles to which have not been extinguished, including rights-of-way running through the same.

Indian tribe means a tribe "Federally-recognized" by the Secretary of the Interior under 25 CFR 272.2.

Local Emergency Planning Committee (LEPC) means a committee appointed by the State Emergency Response Commission under section 301(c) of the Emergency Planning and Community Right-to-Know Act of 1986 (42 U.S.C. 11001(c)) that includes at a minimum, representatives from each of the following groups or organizations: elected State and local officials; law enforcement, firefighting, civil defense, first aid, health, local environmental, hospital, and transportation personnel; broadcast and print media; community groups; and owners and operators of facilities subject to the emergency planning requirements.

National curriculum means the curriculum required to be developed under 49 U.S.C. 5115 and necessary to train public sector emergency response and preparedness teams, enabling them to comply with performance standards as stated in 49 U.S.C. 5115(c).

Political subdivision means a county, municipality, city, town, township, local public authority (including any public and Indian housing agency under the United States Housing Act of 1937 (42 U.S.C. 1401 *et seq.*), school district, special district, intrastate district, council of governments (whether or not incorporated as a nonprofit corporation under State law), any other regional or interstate government entity, or any agency or instrumentality of a local government.

Project means the activities and tasks identified in the grant agreement.

Project manager means the State or Indian tribal official designated in a grant as the recipient agency's principal program contact with the Federal Government.

Project officer means the Federal official designated in a grant as the program contact with the project manager. The project officer is responsible for monitoring the project.

Project period means the length of time specified in a grant for completion of all work associated with that project.

State Emergency Response Commission (SERC) means the State Emergency Response Commission appointed by the

§ 110.30

49 CFR Ch. I (10–1–14 Edition)

Governor of each State and Territory under the Emergency Planning and Community Right-to-Know Act of 1986.

Statement of Work means that portion of a grant that describes the purpose and scope of activities and tasks to be carried out as part of the proposed project.

[Amdt. 110–1, 57 FR 43067, Sept. 17, 1992, as amended by Amdt. 110–3, 59 FR 49132, Sept. 26, 1994; 66 FR 45377, Aug. 28, 2001]

§ 110.30 Grant application.

(a) *General.* An applicant for a planning or training grant shall use only the standard application forms approved by the Office of Management and Budget (OMB) (SF-424 and SF-424A) under the Paperwork Reduction Act of 1980 (44 U.S.C. 3502). Applicants are required to submit an original and two copies of the application package to: Grants Manager, Pipeline and Hazardous Materials Safety Administration, U.S. Department of Transportation, East Building, 1200 New Jersey Avenue, SE., Washington, DC 20590–0001. Applications received on or before January 1st and July 1st of each year will be considered in that cycle of the semi-annual review and award process. An initial round of the review and award process will consider applications received on or before November 15, 1992. Requests and continuation applications must include an original and two copies of the affected pages; previously submitted pages with information that is still current do not have to be resubmitted. The application must include the following:

(1) Application for Federal Assistance for non-construction programs (SF-424) and Budget sheets (SF-424A). A single application may be used for both planning and training if the budgets for each are entered separately on all budget sheets.

(2) For States, a letter from the Governor designating the State agency that is authorized to apply for a grant and to provide the written certifications required to receive a grant.

(3) For Indian tribes, a letter from the tribal government, governing body, or tribal council to the effect that the applicant is authorized to apply for a grant and to provide the written certifications required to receive a grant.

(4) A written statement explaining whether the State or tribe assesses and collects fees on the transportation of hazardous materials and whether such assessments or fees are used solely to carry out purposes related to the transportation of hazardous materials.

(5) A statement designating a project manager and providing the name, position, address and phone number of that individual who will be responsible for coordinating the funded activities with other agencies/organizations.

(6) A project narrative statement of the goals and objectives of the proposed project, project design, and long range plans. The proposed grant project and budget periods may be one or more years.

(7) A statement of work in support of the proposed project that describes and sets priorities for the activities and tasks to be conducted, the costs associated with each activity, the number and types of deliverables and products to be completed, and a schedule for implementation.

(8) A description of the major items of costs needed to implement the statement of work and a copy of any cost or price analysis if conducted.

(9) *Drug-Free Workplace Certification.* The applicant must certify as specified in appendix C of 49 CFR part 29 that it will comply with the Drug-Free Workplace Act of 1988 (Pub. L. 100–690, title V, subtitle D; 51 U.S.C. 701 *et seq.*).

(10) *Anti-Lobbying Certification.* The applicant must certify as specified in appendix A of 49 CFR part 20 that no Federal funds will be expended to pay any person for influencing or attempting to influence an officer or employee of any agency, a Member of Congress, an officer or employee of Congress, or an employee of a Member of Congress (section 319 of Pub. L. 101–121, 31 U.S.C. 1352).

(11) *Debarment and Suspension Certification.* The applicant must certify as specified in subpart G of 49 CFR part 29 that it will not make an award or permit any award to any party which is debarred or suspended or is otherwise excluded from or ineligible for participation in Federal assistance programs.

(b) *Planning.* In addition to the requirements specified in paragraph (a)

of this section, eligible State applicants must include the following in their application package:

(1) A written certification that the State is complying with sections 301 and 303 of the Emergency Planning and Community Right-to-Know Act of 1986, including a brief explanation of how compliance has been achieved.

(2) A written statement specifying the aggregate expenditure of funds of the State, exclusive of Federal funds, for each of its last five fiscal years for developing, improving, and implementing emergency plans under the Emergency Planning and Community Right-to-Know Act of 1986, including an explanation specifying the sources of these funds. A written certification that the State's aggregate expenditures, as defined by the State, of funds for this purpose, exclusive of Federal funds, will not fall below the average level of its expenditures for its last five fiscal years. The applicant may not claim any of these expenditures for cost-sharing.

(3) A written statement agreeing to make at least 75 percent of the Federal funds awarded available to LEPCs and an explanation of how the applicant intends to make such funds available to them for developing, improving, or implementing emergency plans.

(4) Designation of a project manager to serve as contact for coordinating planning funds under this program.

(5) A project narrative statement of the goals and objectives of each proposed project, including the following:

(i) A background statement describing the applicant's long-term goals and objectives with respect to:

(A) The current abilities and authorities of the applicant's program for preparedness planning;

(B) The need to sustain or increase program capability;

(C) Current degree of participation in or intention to assess the need for a regional hazardous materials emergency response team; and

(D) The impact that the grant will have on the program.

(ii) A discussion of whether the applicant's program currently knows, or intends to assess, transportation flow patterns of hazardous materials within

the State and between that State and another State.

(iii) A schedule for implementing the proposed grant activities.

(iv) A statement describing the ways in which planning will be monitored by the project manager.

(v) A statement indicating that all members of the State Emergency Response Commission were provided the opportunity to review the grant application.

(c) *Training.* In addition to the requirements specified in paragraph (a) of this section, eligible State and Indian tribe applicants must include the following in their application package:

(1) For a State applicant, a written certification explaining how the State is complying with sections 301 and 303 of the Emergency Planning and Community Right-to-Know Act.

(2) A written statement specifying the aggregate expenditure of funds of the State or Indian tribe, exclusive of Federal funds, for each of its last five fiscal years for training public sector employees to respond to accidents and incidents involving hazardous materials, including an explanation specifying the sources of these funds. A written certification that the applicant's aggregate expenditure, as defined by the State or tribe, of funds for this purpose, exclusive of Federal funds, will not fall below the average level of its expenditures for its last five fiscal years. The applicant may not claim any of these expenditures for cost-sharing purposes.

(3) For a State applicant, a written statement agreeing to make at least 75 percent of the Federal funds awarded available for the purpose of training public sector employees employed or used by political subdivisions. A State applicant may elect to pass all or some portion of the grant on to political subdivisions for this purpose. The applicant must include a specific explanation of how it intends to meet this requirement.

(4) Designation of a primary point of contact for coordinating training funded under this program. Identification of a single repository for copies of course materials delivered under the grant as specified in §110.90 of this part.

§ 110.40

49 CFR Ch. I (10–1–14 Edition)

(5) A project narrative statement of the long-range goals and objectives of each proposed project, including the following:

(i) A background statement describing:

(A) The current hazardous materials training program(s);

(B) Training audience, including numbers and levels of training and accreditation program for each level or criterion required to advance to the next level;

(C) Estimated total number of persons to be trained under the proposed project;

(D) The ways in which training grants will support the integrated delivery of training to meet the needs of individualized geographic and resource needs and time considerations of local responders. When appropriate, a statement describing how the proposed project will accommodate the different training needs for rural versus urban environments; and

(E) The impact that the grant and the National Curriculum will have on the program.

(ii) A statement describing how the National Curriculum will be used or modified to train public sector employees at the local level to respond to accidents and incidents involving hazardous materials.

(iii) A statement describing the ways in which effectiveness of training will be monitored by the project manager, including, but not limited to, examinations, critiques, and instructor evaluations.

(iv) A schedule for implementing the proposed training grant activities.

(v) A statement indicating that all members of the State or Tribal Emergency Response Commission were provided the opportunity to review the grant application.

[Amdt. 110–1, 57 FR 43067, Sept. 17, 1992, as amended by Amdt. 110–3, 59 FR 49132, Sept. 26, 1994; 70 FR 73162, Dec. 9, 2005; 72 FR 55683, Oct. 1, 2007]

§ 110.40 Activities eligible for funding.

(a) *Planning.* Eligible State applicants may receive funding for the following activities:

(1) Development, improvement, and implementation of emergency plans re-

quired under the Emergency Planning and Community Right-to-Know Act of 1986, as well as exercises which test the emergency plan. Enhancement of emergency plans to include hazard analysis as well as response procedures for emergencies involving transportation of hazardous materials, including radioactive materials.

(2) An assessment to determine flow patterns of hazardous materials within a State, between a State and another State or Indian country, and development and maintenance of a system to keep such information current.

(3) An assessment of the need for regional hazardous materials emergency response teams.

(4) An assessment of local response capabilities.

(5) Conduct of emergency response drills and exercises associated with emergency preparedness plans.

(6) Provision of technical staff to support the planning effort.

(7) Additional activities the Associate Administrator deems appropriate to implement the scope of work for the proposed project plan and approved in the grant.

(b) *Training.* Eligible State and Indian tribe applicants may receive funding for the following activities:

(1) An assessment to determine the number of public sector employees employed or used by a political subdivision who need the proposed training and to select courses consistent with the National Curriculum.

(2) Delivery of comprehensive preparedness and response training to public sector employees. Design and delivery of preparedness and response training to meet specialized needs. Financial assistance for trainees and for the trainers, if appropriate, such as tuition, travel expenses to and from a training facility, and room and board while at the training facility.

(3) Emergency response drills and exercises associated with training, a course of study, and tests and evaluation of emergency preparedness plans.

(4) Expenses associated with training by a person (including a department, agency, or instrumentality of a State or political subdivision thereof or an Indian tribe) and activities necessary to monitor such training including, but

not limited to examinations, critiques and instructor evaluations.

(5) Provision of staff to manage the training effort designed to result in increased benefits, proficiency, and rapid deployment of local and regional responders.

(6) Additional activities the Associate Administrator deems appropriate to implement the scope of work for the proposed project and approved in the grant.

[Amdt. 110-1, 57 FR 43067, Sept. 17, 1992, as amended by 66 FR 45377, Aug. 28, 2001]

§ 110.50 Disbursement of Federal funds.

(a) Preaward expenditures may not be reimbursed.

(b) Reimbursement may not be made for a project plan unless approved in the grant award.

(c) If a recipient agency seeks additional funds, the amendment request will be evaluated on the basis of needs, performance and availability of funds. An existing grant is not a commitment of future Federal funding.

§ 110.60 Cost sharing for planning and training.

(a) The recipient agency must provide 20 percent of the direct and indirect costs of all activities covered under the grant award program with non-Federal funds. Recipients may either use cash (hard-match), in-kind (soft-match) contributions, or a combination of in-kind plus hard-match to meet this requirement. In-kind (soft-match) contributions are in addition to the maintenance of effort required of recipients of grant awards. The types of contributions allowed are as follows:

(1) Any funds from a State, local, or other non-Federal source used for an eligible activity as defined in § 110.40 in this part.

(2) The dollar equivalent value of an eligible activity as defined in § 110.40 of this part provided by a State, local, or other non-Federal source.

(3) The value of participants' salary while attending a planning or training activity contained in the approved grant application provided by a State, local, or other non-Federal source.

(4) Additional types of in-kind contributions the Associate Administrator deems appropriate.

(b) Funds used for matching purposes under any other Federal grant or cooperative agreement may not be used for matching purposes. The funds expended by a recipient agency to qualify for the grant may not be used for cost-sharing purposes.

(c) Acceptable contributions for matching and cost sharing purposes must conform to 49 CFR part 18.

[Amdt. 110-1, 57 FR 43067, Sept. 17, 1992, as amended by Amdt. 110-3, 59 FR 49132, Sept. 26, 1994; 66 FR 45377, Aug. 28, 2001]

§ 110.70 Financial administration.

(a) A State must expend and account for grant funds in accordance with State laws and procedures for expending and accounting for its own funds. Fiscal control and accounting procedures of the State, as well as its subgrantees and cost-type contractors, must be sufficient to:

(1) Permit the preparation of reports required by 49 CFR part 18 and this part, including the tracing of funds provided for planning to a level of expenditure adequate to establish that at least 75 percent of the funds provided were made available to LEPCs for developing, improving, and implementing emergency plans; and the tracing of funds provided for training to a level of expenditure adequate to establish that at least 75 percent of the funds provided were made available for the purposes of training public sector employees employed or used by political subdivisions.

(2) Permit the tracing of funds to a level of expenditure adequate to establish that such funds have not been used in violation of the restrictions and prohibitions of applicable statutes.

(b) The financial management systems of Indian tribes and any subgrantees must meet the standards of 49 CFR 18.20, including the ability to trace funds provided for training to a level of expenditure adequate to establish that at least 75 percent of the funds provided were made available for the purposes of training public sector employees employed or used by political subdivisions.

§ 110.80

(c) Advances shall be made to States and Indian tribes consistent with 49 CFR part 18 and 31 CFR part 205. The Associate Administrator shall base these advances on demonstrated need, which will be determined on a case-by-case basis, considering such factors as State/Tribal budget constraints and reductions in amounts budgeted for hazardous materials activities. To obtain an advance, a State or Indian tribe must comply with the following requirements:

(1) A letter from the Governor or Tribal leader or their designee is required specifying the extenuating circumstances requiring the funding advance for the grant;

(2) The maximum advance request may not be more than \$25,000 for each State or Indian tribe;

(3) Recipients of advance funding must obligate those funds within 3 months of receipt;

(4) Advances including interest will be deducted from the initial reimbursement to the State or Indian tribe; and

(5) The State or Indian tribe will have its allocation of current grant funds reduced and will not be permitted to apply for future grant funds until the advance is covered by a request for reimbursement. For example, if \$25,000 is advanced for personnel costs, this advance would be deducted from the initial reimbursement in the year the advance was made.

(d) To be allowable, costs must be eligible, reasonable, necessary, and allocable to the approved project in accordance with OMB Circular A-87 and included in the grant award. Costs incurred prior to the award of any grant are not allowable. Recipient agencies are responsible for obtaining audits in accordance with the Single Audit Act of 1984 (31 U.S.C. 7501), 49 CFR part 90, and OMB Circular A-128. Audits shall be made by an independent auditor in accordance with generally accepted government auditing standards covering financial and compliance audits. The Associate Administrator may audit a recipient agency at any time.

[Amdt. 110-1, 57 FR 43067, Sept. 17, 1992, as amended by 66 FR 45377, Aug. 28, 2001]

49 CFR Ch. I (10-1-14 Edition)

§ 110.80 Procurement.

Project managers shall use procurement procedures and practices which reflect applicable State laws and regulations and Federal requirements as specified in 49 CFR 18.36.

§ 110.90 Grant monitoring, reports, and records retention.

(a) *Grant monitoring.* Project managers are responsible for managing the day-to-day operations of grant, subgrant and contract-supported activities. Project managers must monitor performance of supported activities to assure compliance with applicable Federal requirements and achievement of performance goals. Monitoring must cover each program, function, activity, or task covered by the grant. Monitoring and reporting requirements for planning and training are contained in this part; general grant reporting requirements are specified in 49 CFR 18.40.

(b) *Reports.* (1) The project manager shall submit a performance report at the completion of an activity for which reimbursement is being requested or with a request to amend the grant. The final performance report is due 90 days after the expiration or termination of the grant.

(2) Project managers shall submit an original and two copies of all performance reports. Performance reports for planning and training must include comparison of actual accomplishments to the stated goals and objectives established for the performance period, and the reasons for not achieving those goals and objectives, if applicable.

(3) Project managers shall report developments or events that occur between the required performance reporting dates which have significant impact upon the planning and training activity such as:

(i) Problems, delays, or adverse conditions which will impair the ability to meet the objective of the grant; and

(ii) Favorable developments which enable meeting time schedules and objectives sooner or at less cost than anticipated or producing more beneficial results than originally planned.

(4) Financial reporting, except as provided in §110.70 and 49 CFR 18.41, shall be supplied quarterly using Standard

Form 270, Request for Advance or Reimbursement, to report the status of funds. The project manager shall report separately on planning and training.

(c) *Records retention.* In accordance with 49 CFR 18.42, all financial and programmatic records, supporting documents, statistical records, training materials, and other documents generated under a grant shall be maintained by the project manager for three years from the date the project manager submits the final financial status report (SF 269) or Request for Advance or Reimbursement (SF 270). The project manager shall designate a repository and single-point of contact for planning and for training, or both, for these purposes. If any litigation, claim, negotiation, audit or other action involving the records has been started before the expiration of the 3-year period, the records must be retained until completion of the action and resolution of all issues which arise from it, or until the end of the regular 3-year period, whichever is later.

§ 110.100 Enforcement.

If a recipient agency fails to comply with any term of an award (whether stated in a Federal statute or regulation, an assurance, a State plan or application, a notice of award, or elsewhere) a noncompliance action may be taken as specified in 40 CFR 18.43. The recipient agency may appeal any such actions as specified in 49 CFR part 18. Costs incurred by the recipient agency during a suspension or after termination of an award are not allowable unless the Associate Administrator authorizes it in writing. Grant awards may be terminated in whole or in part with the consent of the recipient at any agreed upon effective date, or by the recipient upon written notification.

[Amdt. 110-1, 57 FR 43067, Sept. 17, 1992, as amended by 66 FR 45377, Aug. 28, 2001]

§ 110.110 After-grant requirements.

The Associate Administrator will close out the award upon determination that all applicable administrative actions and all required work of the grant are complete in accordance with subpart D of 49 CFR part 18. The project manager must submit all financial, performance, and other reports required as a condition of the grant, within 90 days after the expiration or termination of the grant. This time frame may be extended by the Associate Administrator for Hazardous Materials Safety for cause.

[Amdt. 110-1, 57 FR 43067, Sept. 17, 1992, as amended by 66 FR 45377, Aug. 28, 2001]

§ 110.120 Deviation from this part.

Recipient agencies may request a deviation from the non-statutory provisions of this part. The Associate Administrator will respond to such requests in writing. If appropriate, the decision will be included in the grant agreement. Request for deviations from part 110 must be submitted to: Grants Manager, Pipeline and Hazardous Materials Safety Administration, U.S. Department of Transportation, East Building, 1200 New Jersey Avenue, SE., Washington, DC 20590-0001.

[Amdt. 110-1, 57 FR 43067, Sept. 17, 1992, as amended by Amdt. 110-3, 59 FR 49132, Sept. 26, 1994; 66 FR 45377, Aug. 28, 2001; 72 FR 55683, Oct. 1, 2007]

§ 110.130 Disputes.

Disputes should be resolved at the lowest level possible, beginning with the project manager and the project officer. If an agreement cannot be reached, the Administrator, PHMSA, will serve as the dispute resolution official, whose decision will be final.

SUBCHAPTER B—OIL TRANSPORTATION

PART 130—OIL SPILL PREVENTION AND RESPONSE PLANS

- Sec.
- 130.1 Purpose.
- 130.2 Scope.
- 130.3 General requirements.
- 130.5 Definitions.
- 130.11 Communication requirements.
- 130.21 Packaging requirements.
- 130.31 Response plans.
- 130.33 Response plan implementation.

AUTHORITY: 33 U.S.C 1321; 49 CFR 1.81 and 1.97.

SOURCE: Amdt. 130-2, 61 FR 30541, June 17, 1996, unless otherwise noted.

§ 130.1 Purpose.

This part prescribes prevention, containment and response planning requirements of the Department of Transportation applicable to transportation of oil by motor vehicles and rolling stock.

§ 130.2 Scope.

(a) The requirements of this part apply to—

(1) Any liquid petroleum oil in a packaging having a capacity of 3,500 gallons or more; and

(2) Any liquid petroleum or non-petroleum oil in a quantity greater than 42,000 gallons per packaging.

(b) The requirements of this part have no effect on—

(1) The applicability of the Hazardous Materials Regulations set forth in subchapter C of this chapter; and

(2) The discharge notification requirements of the United States Coast Guard (33 CFR part 153) and EPA (40 CFR part 110).

(c) The requirements of this part do not apply to—

(1) Any mixture or solution in which oil is in a concentration by weight of less than 10 percent.

(2) Transportation of oil by aircraft or vessel.

(3) Any petroleum oil carried in a fuel tank for the purpose of supplying fuel for propulsion of the transport vehicle to which it is attached.

(4) Oil transport exclusively within the confines of a non-transportation-

related or terminal facility in a vehicle not intended for use in interstate or intrastate commerce (see 40 CFR part 112, appendix A).

(d) The requirements in § 130.31(b) of this part do not apply to mobile marine transportation-related facilities (see 33 CFR part 154).

§ 130.3 General requirements.

No person may offer or accept for transportation or transport oil subject to this part unless that person—

(a) Complies with this part; and

(b) Has been instructed on the applicable requirements of this part.

§ 130.5 Definitions.

In this subchapter: *Animal fat* means a non-petroleum oil, fat, or grease derived from animals, not specifically identified elsewhere in this part.

Contract or other means is:

(1) A written contract with a response contractor identifying and ensuring the availability of the necessary personnel or equipment within the shortest practicable time;

(2) A written certification by the owner or operator that the necessary personnel or equipment can and will be made available by the owner or operator within the shortest practicable time; or

(3) Documentation of membership in an oil spill response organization that ensures the owner's or operator's access to the necessary personnel or equipment within the shortest practicable time.

EPA means the U.S. Environmental Protection Agency.

Liquid means a material that has a vertical flow of over two inches (50 mm) within a three-minute period, or a material having one gram or more liquid separation, when determined in accordance with the procedures specified in ASTM D 4359-84, "Standard Test Method for Determining Whether a Material is a Liquid or a Solid," 1990 edition, which is incorporated by reference.

NOTE: This incorporation by reference has been approved by the Director of the Federal

Register in accordance with 5 U.S.C. 552(a) and 1 CFR part 51. A copy may be obtained from the American Society for Testing and Materials, 1916 Race Street, Philadelphia, PA 19103. Copies may be inspected at the Office of Hazardous Materials Safety, Office of Hazardous Materials Standards, Room 8422, DOT headquarters building, 400 7th St., SW, Washington, DC 20590, or at the National Archives and Records Administration (NARA). For information on the availability of this material at NARA, call 202-741-6030, or go to: http://www.archives.gov/federal_register/code_of_federal_regulations/ibr_locations.html.

Maximum extent practicable means the limits of available technology and the practical and technical limits on an owner or operator of an onshore facility in planning the response resources required to provide the on-water recovery capability and the shoreline protection and cleanup capability to conduct response activities for a worst-case discharge of oil in adverse weather.

Non-petroleum oil means any animal fat, vegetable oil or other non-petroleum oil.

Oil means oil of any kind or in any form, including, but not limited to, petroleum, fuel oil, sludge, oil refuse, and oil mixed with wastes other than dredged spoil.

NOTE: This definition does not include hazardous substances (see 40 CFR part 116).

Other non-petroleum oil means a non-petroleum oil of any kind that is not an animal fat or vegetable oil.

Packaging means a receptacle and any other components or materials necessary for the receptacle to perform its containment function in conformance with the packaging requirements of this part. A compartmented tank is a single packaging.

Person means an individual, firm, corporation, partnership, association, State, municipality, commission, or political subdivision of a State, or any interstate body, as well as a department, agency, or instrumentality of the executive, legislative or judicial branch of the Federal Government.

Petroleum oil means any oil extracted or derived from geological hydrocarbon deposits, including fractions thereof.

Qualified individual means an individual familiar with the response plan, trained in his or her responsibilities in implementing the plan, and authorized,

on behalf of the owner or operator, to initiate all response activities identified in the plan, to enter into response-related contracts and obligate funds for such contracts, and to act as a liaison with the on-scene coordinator and other responsible officials. The qualified individual must be available at all times the owner or operator is engaged in transportation subject to part 130 (alone or in conjunction with an equally qualified alternate), must be fluent in English, and must have in his or her possession documentation of the required authority.

Transports or Transportation means any movement of oil by highway or rail, and any loading, unloading, or storage incidental thereto.

Vegetable oil means a non-petroleum oil or fat derived from plant seeds, nuts, kernels or fruits, not specifically identified elsewhere in this part.

Worst-case discharge means "the largest foreseeable discharge in adverse weather conditions," as defined at 33 U.S.C. 1321(a)(24). The largest foreseeable discharge from a motor vehicle or rail car is the capacity of the cargo container. The term "maximum potential discharge," used in §130.31(a), is synonymous with "worst-case discharge."

[Amdt. 130-2, 61 FR 30541, June 17, 1996, as amended by 66 FR 45378, Aug. 28, 2001; 67 FR 61011, Sept. 27, 2002; 69 FR 18803, Apr. 9, 2004]

§ 130.11 Communication requirements.

(a) No person may offer oil subject to this part for transportation unless that person provides the person accepting the oil for transportation a document indicating the shipment contains oil.

(b) No person may transport oil subject to this part unless a readily available document indicating that the shipment contains oil is in the possession of the transport vehicle operator during transportation.

(c) A material subject to the requirements of this part need not be specifically identified as oil when the shipment document accurately describes the material as: aviation fuel, diesel fuel, fuel oil, gasoline, jet fuel, kerosene, motor fuel, or petroleum.

§ 130.21

49 CFR Ch. I (10–1–14 Edition)

§ 130.21 Packaging requirements.

Each packaging used for the transportation of oil subject to this part must be designed, constructed, maintained, closed, and loaded so that, under conditions normally incident to transportation, there will be no release of oil to the environment.

§ 130.31 Response plans.

(a) No person may transport oil subject to this part unless that person has a current basic written plan that:

(1) Sets forth the manner of response to discharges that may occur during transportation;

(2) Takes into account the maximum potential discharge of the contents from the packaging;

(3) Identifies private personnel and equipment available to respond to a discharge;

(4) Identifies the appropriate persons and agencies (including their telephone numbers) to be contacted in regard to such a discharge and its handling, including the National Response Center; and

(5) For each motor carrier, is retained on file at that person's principal place of business and at each location where dispatching of motor vehicles occurs; and for each railroad, is retained on file at that person's principal place of business and at the dispatcher's office.

(b) No person may transport an oil subject to this part in a quantity greater than 1,000 barrels (42,000 gallons) unless that person has a current comprehensive written plan that:

(1) Conforms with all requirements specified in paragraph (a) of this section;

(2) Is consistent with the requirements of the National Contingency Plan (40 CFR part 300) and Area Contingency Plans;

(3) Identifies the qualified individual having full authority to implement removal actions, and requires immediate communications between that indi-

vidual and the appropriate Federal official and the persons providing spill response personnel and equipment;

(4) Identifies, and ensures by contract or other means the availability of, private personnel (including address and phone number), and the equipment necessary to remove, to the maximum extent practicable, a worst case discharge (including a discharge resulting from fire or explosion) and to mitigate or prevent a substantial threat of such a discharge;

(5) Describes the training, equipment testing, periodic unannounced drills, and response actions of facility personnel, to be carried out under the plan to ensure the safety of the facility and to mitigate or prevent the discharge, or the substantial threat of such a discharge; and

(6) Is submitted, and resubmitted in the event of any significant change, to the Federal Railroad Administrator (for tank cars), or to the Federal Highway Administrator (for cargo tanks) at East Building, 1200 New Jersey Avenue, SE., Washington, DC 20590-0001.

(Approved by the Office of Management and Budget under control number 2137-0591)

[Amdt. 130-2, 61 FR 30541, June 17, 1996, as amended at 72 FR 55683, Oct. 1, 2007; 76 FR 56311, Sept. 13, 2011]

§ 130.33 Response plan implementation.

If, during transportation of oil subject to this part, a discharge occurs—into or on the navigable waters of the United States; on the adjoining shorelines to the navigable waters; or that may affect natural resources belonging to, appertaining to, or under the exclusive management authority of, the United States—the person transporting the oil shall implement the plan required by §130.31, in a manner consistent with the National Contingency Plan, 40 CFR part 300, or as otherwise directed by the Federal on-scene coordinator.

SUBCHAPTER C—HAZARDOUS MATERIALS REGULATIONS

PART 171—GENERAL INFORMATION, REGULATIONS, AND DEFINITIONS

Sec.

Subpart A—Applicability, General Requirements, and North American Shipments

- 171.1 Applicability of Hazardous Materials Regulations (HMR) to persons and functions.
- 171.2 General requirements.
- 171.3 Hazardous waste.
- 171.4 Marine pollutants.
- 171.6 Control numbers under the Paperwork Reduction Act.
- 171.7 Reference material.
- 171.8 Definitions and abbreviations.
- 171.9 Rules of construction.
- 171.10 Units of measure.
- 171.11 [Reserved]
- 171.12 North American Shipments.
- 171.12a [Reserved]
- 171.14 [Reserved]

Subpart B—Incident Reporting, Notification, BOE Approvals and Authorization

- 171.15 Immediate notice of certain hazardous materials incidents.
- 171.16 Detailed hazardous materials incident reports.
- 171.17–171.18 [Reserved]
- 171.19 Approvals or authorizations issued by the Bureau of Explosives.
- 171.20 Submission of Examination Reports.
- 171.21 Assistance in investigations and special studies.

Subpart C—Authorization and Requirements for the Use of International Transport Standards and Regulations

- 171.22 Authorization and conditions for the use of international standards and regulations.
- 171.23 Requirements for specific materials and packagings transported under the ICAO Technical Instructions, IMDG Code, Transport Canada TDG Regulations, or the IAEA Regulations.
- 171.24 Additional requirements for the use of the ICAO Technical Instructions.
- 171.25 Additional requirements for the use of the IMDG Code.
- 171.26 Additional requirements for the use of the IAEA Regulations.

AUTHORITY: 49 U.S.C. 5101–5128, 44701; Pub. L. 101–410 section 4 (28 U.S.C. 2461 note); Pub. L. 104–134, section 31001; 49 CFR 1.81 and 1.97.

EDITORIAL NOTE: Nomenclature changes to part 171 appear at 70 FR 56090, Sept. 23, 2005.

Subpart A—Applicability, General Requirements, and North American Shipments

§ 171.1 Applicability of Hazardous Materials Regulations (HMR) to persons and functions.

Federal hazardous materials transportation law (49 U.S.C. 5101 *et seq.*) directs the Secretary of Transportation to establish regulations for the safe and secure transportation of hazardous materials in commerce, as the Secretary considers appropriate. The Secretary is authorized to apply these regulations to persons who transport hazardous materials in commerce. In addition, the law authorizes the Secretary to apply these regulations to persons who cause hazardous materials to be transported in commerce. The law also authorizes the Secretary to apply these regulations to persons who manufacture or maintain a packaging or a component of a packaging that is represented, marked, certified, or sold as qualified for use in the transportation of a hazardous material in commerce. Federal hazardous material transportation law also applies to anyone who indicates by marking or other means that a hazardous material being transported in commerce is present in a package or transport conveyance when it is not, and to anyone who tampers with a package or transport conveyance used to transport hazardous materials in commerce or a required marking, label, placard, or shipping description. Regulations prescribed in accordance with Federal hazardous materials transportation law shall govern safety aspects, including security, of the transportation of hazardous materials that the Secretary considers appropriate. In 49 CFR 1.53, the Secretary delegated authority to issue regulations for the safe and secure transportation of hazardous materials in commerce to the Pipeline and Hazardous Materials Safety Administrator. The Administrator issues the Hazardous Materials Regulations (HMR; 49 CFR

parts 171 through 180) under that delegated authority. This section addresses the applicability of the HMR to packagings represented as qualified for use in the transportation of hazardous materials in commerce and to pre-transportation and transportation functions.

(a) *Packagings.* Requirements in the HMR apply to each person who manufactures, fabricates, marks, maintains, reconditions, repairs, or tests a packaging or a component of a packaging that is represented, marked, certified, or sold as qualified for use in the transportation of a hazardous material in commerce, including each person under contract with any department, agency, or instrumentality of the executive, legislative, or judicial branch of the Federal government who manufactures, fabricates, marks, maintains, reconditions, repairs, or tests a packaging or a component of a packaging that is represented, marked, certified, or sold as qualified for use in the transportation of a hazardous material in commerce.

(b) *Pre-transportation functions.* Requirements in the HMR apply to each person who offers a hazardous material for transportation in commerce, causes a hazardous material to be transported in commerce, or transports a hazardous material in commerce and who performs or is responsible for performing a pre-transportation function, including each person performing pre-transportation functions under contract with any department, agency, or instrumentality of the executive, legislative, or judicial branch of the Federal government. Pre-transportation functions include, but are not limited to, the following:

- (1) Determining the hazard class of a hazardous material.
- (2) Selecting a hazardous materials packaging.
- (3) Filling a hazardous materials packaging, including a bulk packaging.
- (4) Securing a closure on a filled or partially filled hazardous materials package or container or on a package or container containing a residue of a hazardous material.
- (5) Marking a package to indicate that it contains a hazardous material.

(6) Labeling a package to indicate that it contains a hazardous material.

(7) Preparing a shipping paper.

(8) Providing and maintaining emergency response information.

(9) Reviewing a shipping paper to verify compliance with the HMR or international equivalents.

(10) For each person importing a hazardous material into the United States, providing the shipper with timely and complete information as to the HMR requirements that will apply to the transportation of the material within the United States.

(11) Certifying that a hazardous material is in proper condition for transportation in conformance with the requirements of the HMR.

(12) Loading, blocking, and bracing a hazardous materials package in a freight container or transport vehicle.

(13) Segregating a hazardous materials package in a freight container or transport vehicle from incompatible cargo.

(14) Selecting, providing, or affixing placards for a freight container or transport vehicle to indicate that it contains a hazardous material.

(c) *Transportation functions.* Requirements in the HMR apply to transportation of a hazardous material in commerce and to each person who transports a hazardous material in commerce, including each person under contract with any department, agency, or instrumentality of the executive, legislative, or judicial branch of the Federal government who transports a hazardous material in commerce. Transportation of a hazardous material in commerce begins when a carrier takes physical possession of the hazardous material for the purpose of transporting it and continues until the package containing the hazardous material is delivered to the destination indicated on a shipping document, package marking, or other medium, or, in the case of a rail car, until the car is delivered to a private track or siding. For a private motor carrier, transportation of a hazardous material in commerce begins when a motor vehicle driver takes possession of a hazardous

material for the purpose of transporting it and continues until the driver relinquishes possession of the package containing the hazardous material at its destination and is no longer responsible for performing functions subject to the HMR with respect to that particular package. Transportation of a hazardous material in commerce includes the following:

(1) *Movement.* Movement of a hazardous material by rail car, aircraft, motor vehicle, or vessel (except as delegated by Department of Homeland Security Delegation No. 0170 at 2(103)).

(2) *Loading incidental to movement of a hazardous material.* Loading of packaged or containerized hazardous material onto a transport vehicle, aircraft, or vessel for the purpose of transporting it, including blocking and bracing a hazardous materials package in a freight container or transport vehicle, and segregating a hazardous materials package in a freight container or transport vehicle from incompatible cargo, when performed by carrier personnel or in the presence of carrier personnel. For a bulk packaging, loading incidental to movement is filling the packaging with a hazardous material for the purpose of transporting it when performed by carrier personnel or in the presence of carrier personnel (except as delegated by Department of Homeland Security Delegation No. 0170 at 2(103)), including transloading.

(3) *Unloading incidental to movement of a hazardous material.* Removing a package or containerized hazardous material from a transport vehicle, aircraft, or vessel; or for a bulk packaging, emptying a hazardous material from the bulk packaging after the hazardous material has been delivered to the consignee when performed by carrier personnel or in the presence of carrier personnel or, in the case of a private motor carrier, while the driver of the motor vehicle from which the hazardous material is being unloaded immediately after movement is completed is present during the unloading operation. (Emptying a hazardous material from a bulk packaging while the packaging is on board a vessel is subject to separate regulations as delegated by Department of Homeland Security Delegation No. 0170 at 2(103).)

Unloading incidental to movement includes transloading.

(4) *Storage incidental to movement of a hazardous material.* Storage of a transport vehicle, freight container, or package containing a hazardous material by any person between the time that a carrier takes physical possession of the hazardous material for the purpose of transporting it until the package containing the hazardous material has been delivered to the destination indicated on a shipping document, package marking, or other medium, or, in the case of a private motor carrier, between the time that a motor vehicle driver takes physical possession of the hazardous material for the purpose of transporting it until the driver relinquishes possession of the package at its destination and is no longer responsible for performing functions subject to the HMR with respect to that particular package.

(i) Storage incidental to movement includes—

(A) Storage at the destination shown on a shipping document, including storage at a transloading facility, provided the original shipping documentation identifies the shipment as a through-shipment and identifies the final destination or destinations of the hazardous material; and

(B) A rail car containing a hazardous material that is stored on track that does not meet the definition of “private track or siding” in §171.8, even if the car has been delivered to the destination shown on the shipping document.

(ii) Storage incidental to movement does not include storage of a hazardous material at its final destination as shown on a shipping document.

(d) *Functions not subject to the requirements of the HMR.* The following are examples of activities to which the HMR do not apply:

(1) Storage of a freight container, transport vehicle, or package containing a hazardous material at an offeror facility prior to a carrier taking possession of the hazardous material for movement in transportation in commerce or, for a private motor carrier, prior to a motor vehicle driver

§ 171.1

49 CFR Ch. I (10–1–14 Edition)

taking physical possession of the hazardous material for movement in transportation in commerce.

(2) Unloading of a hazardous material from a transport vehicle or a bulk packaging performed by a person employed by or working under contract to the consignee following delivery of the hazardous material by the carrier to its destination and departure from the consignee's premises of the carrier's personnel or, in the case of a private carrier, departure of the driver from the unloading area.

(3) Storage of a freight container, transport vehicle, or package containing a hazardous material after its delivery by a carrier to the destination indicated on a shipping document, package marking, or other medium, or, in the case of a rail car, storage of a rail car on private track.

(4) Rail and motor vehicle movements of a hazardous material exclusively within a contiguous facility boundary where public access is restricted, except to the extent that the movement is on or crosses a public road or is on track that is part of the general railroad system of transportation, unless access to the public road is restricted by signals, lights, gates, or similar controls.

(5) Transportation of a hazardous material in a motor vehicle, aircraft, or vessel operated by a Federal, state, or local government employee solely for noncommercial Federal, state, or local government purposes.

(6) Transportation of a hazardous material by an individual for non-commercial purposes in a private motor vehicle, including a leased or rented motor vehicle.

(7) Any matter subject to the postal laws and regulations of the United States.

(e) *Requirements of other Federal agencies.* Each facility at which pre-transportation or transportation functions are performed in accordance with the HMR may be subject to applicable standards and regulations of other Federal agencies.

(f) *Requirements of state and local government agencies.* (1) Under 49 U.S.C. 5125, a requirement of a state, political subdivision of a state, or an Indian tribe is preempted, unless otherwise

authorized by another Federal statute or DOT issues a waiver of preemption, if—

(i) Complying with both the non-Federal requirement and Federal hazardous materials transportation law, the regulations issued under Federal hazardous material transportation law or a hazardous material transportation security regulation or directive issued by the Secretary of Homeland Security is not possible;

(ii) The non-Federal requirement, as applied or enforced, is an obstacle to accomplishing and carrying out Federal hazardous materials transportation law, the regulations issued under Federal hazardous material transportation law, or a hazardous material transportation security regulation or directive issued by the Secretary of Homeland Security;

(iii) The non-Federal requirement is not substantively the same as a provision of Federal hazardous materials transportation law, the regulations issued under Federal hazardous material transportation law, or a hazardous material transportation security regulation or directive issued by the Secretary of Homeland Security with respect to—

(A) The designation, description, and classification of hazardous material;

(B) The packing, repacking, handling, labeling, marking, and placarding of hazardous material;

(C) The preparation, execution, and use of shipping documents related to hazardous material and requirements related to the number, contents, and placement of those documents;

(D) The written notification, recording, and reporting of the unintentional release of hazardous material; or

(E) The design, manufacturing, fabricating, marking, maintenance, reconditioning, repairing, or testing of a package or container represented, marked, certified, or sold as qualified for use in transporting hazardous material.

(iv) A non-Federal designation, limitation or requirement on highway routes over which hazardous material may or may not be transported does not comply with the regulations in subparts C and D of part 397 of this title; or

(v) A fee related to the transportation of a hazardous material is not fair or is used for a purpose that is not related to transporting hazardous material, including enforcement and planning, developing, and maintaining a capability for emergency response.

(2) Subject to the limitations in paragraph (f)(1) of this section, each facility at which functions regulated under the HMR are performed may be subject to applicable laws and regulations of state and local governments and Indian tribes.

(3) The procedures for DOT to make administrative determinations of preemption are set forth in subpart E of part 397 of this title with respect to non-Federal requirements on highway routing (paragraph (f)(1)(iv) of this section) and in subpart C of part 107 of this chapter with respect to all other non-Federal requirements.

(g) *Penalties for noncompliance.* Each person who knowingly violates a requirement of the Federal hazardous material transportation law, an order issued under Federal hazardous material transportation law, subchapter A of this chapter, or a special permit or approval issued under subchapter A or C of this chapter is liable for a civil penalty of not more than \$75,000 for each violation, except the maximum civil penalty is \$175,000 if the violation results in death, serious illness or severe injury to any person or substantial destruction of property. There is no minimum civil penalty, except for a minimum civil penalty of \$450 for a violation relating to training.

[68 FR 61937, Oct. 30, 2003; 70 FR 20031, Apr. 15, 2005, as amended at 70 FR 73162, Dec. 9, 2005; 71 FR 8488, Feb. 17, 2006; 71 FR 44931, Aug. 8, 2006; 74 FR 68702, Dec. 29, 2009; 75 FR 53596, Sept. 1, 2010; 78 FR 22800, Apr. 17, 2013]

§ 171.2 General requirements.

(a) Each person who performs a function covered by this subchapter must perform that function in accordance with this subchapter.

(b) Each person who offers a hazardous material for transportation in commerce must comply with all applicable requirements of this subchapter, or an exemption or special permit, approval, or registration issued under this subchapter or under subchapter A

of this chapter. There may be more than one offeror of a shipment of hazardous materials. Each offeror is responsible for complying with the requirements of this subchapter, or an exemption or special permit, approval, or registration issued under this subchapter or subchapter A of this chapter, with respect to any pre-transportation function that it performs or is required to perform; however, each offeror is responsible only for the specific pre-transportation functions that it performs or is required to perform, and each offeror may rely on information provided by another offeror, unless that offeror knows or, a reasonable person, acting in the circumstances and exercising reasonable care, would have knowledge that the information provided by the other offeror is incorrect.

(c) Each person who performs a function covered by or having an effect on a specification or activity prescribed in part 178, 179, or 180 of this subchapter, an approval issued under this subchapter, or an exemption or special permit issued under subchapter A of this chapter, must perform the function in accordance with that specification, approval, an exemption or special permit, as appropriate.

(d) No person may offer or accept a hazardous material for transportation in commerce or transport a hazardous material in commerce unless that person is registered in conformance with subpart G of part 107 of this chapter, if applicable.

(e) No person may offer or accept a hazardous material for transportation in commerce unless the hazardous material is properly classed, described, packaged, marked, labeled, and in condition for shipment as required or authorized by applicable requirements of this subchapter or an exemption or special permit, approval, or registration issued under this subchapter or subchapter A of this chapter.

(f) No person may transport a hazardous material in commerce unless the hazardous material is transported in accordance with applicable requirements of this subchapter, or an exemption or special permit, approval, or registration issued under this subchapter or subchapter A of this chapter. Each

carrier who transports a hazardous material in commerce may rely on information provided by the offeror of the hazardous material or a prior carrier, unless the carrier knows or, a reasonable person, acting in the circumstances and exercising reasonable care, would have knowledge that the information provided by the offeror or prior carrier is incorrect.

(g) No person may represent, mark, certify, sell, or offer a packaging or container as meeting the requirements of this subchapter governing its use in the transportation of a hazardous material in commerce unless the packaging or container is manufactured, fabricated, marked, maintained, reconditioned, repaired, and retested in accordance with the applicable requirements of this subchapter. No person may represent, mark, certify, sell, or offer a packaging or container as meeting the requirements of an exemption, a special permit, approval, or registration issued under this subchapter or subchapter A of this chapter unless the packaging or container is manufactured, fabricated, marked, maintained, reconditioned, repaired, and retested in accordance with the applicable requirements of the exemption, special permit, approval, or registration issued under this subchapter or subchapter A of this chapter. The requirements of this paragraph apply whether or not the packaging or container is used or to be used for the transportation of a hazardous material.

(h) The representations, markings, and certifications subject to the prohibitions of paragraph (g) of this section include:

(1) Specification identifications that include the letters “ICC”, “DOT”, “CTC”, “MC”, or “UN”;

(2) Exemption, special permit, approval, and registration numbers that include the letters “DOT”, “EX”, “M”, or “R”; and

(3) Test dates associated with specification, registration, approval, retest, exemption, or special permit markings indicating compliance with a test or retest requirement of the HMR, or an exemption, special permit, approval, or registration issued under the HMR or under subchapter A of this chapter.

(i) No person may certify that a hazardous material is offered for transportation in commerce in accordance with the requirements of this subchapter unless the hazardous material is properly classed, described, packaged, marked, labeled, and in condition for shipment as required or authorized by applicable requirements of this subchapter or an exemption or special permit, approval, or registration issued under this subchapter or subchapter A of this chapter. Each person who offers a package containing a hazardous material for transportation in commerce in accordance with the requirements of this subchapter or an exemption or special permit, approval, or registration issued under this subchapter or subchapter A of this chapter, must assure that the package remains in condition for shipment until it is in the possession of the carrier.

(j) No person may, by marking or otherwise, represent that a container or package for transportation of a hazardous material is safe, certified, or in compliance with the requirements of this chapter unless it meets the requirements of all applicable regulations issued under Federal hazardous material transportation law.

(k) No person may, by marking or otherwise, represent that a hazardous material is present in a package, container, motor vehicle, rail car, aircraft, or vessel if the hazardous material is not present.

(l) No person may alter, remove, deface, destroy, or otherwise unlawfully tamper with any marking, label, placard, or description on a document required by Federal hazardous material transportation law or the regulations issued under Federal hazardous material transportation law. No person may alter, deface, destroy, or otherwise unlawfully tamper with a package, container, motor vehicle, rail car, aircraft, or vessel used for the transportation of hazardous materials.

(m) No person may falsify or alter an exemption or special permit, approval, registration, or other grant of authority issued under this subchapter or subchapter A of this chapter. No person may offer a hazardous material for transportation or transport a hazardous material in commerce under an

exemption or special permit, approval, registration or other grant of authority issued under this subchapter or subchapter A of this chapter if such grant of authority has been altered without the consent of the issuing authority. No person may represent, mark, certify, or sell a packaging or container under an exemption or special permit, approval, registration or other grant of authority issued under this subchapter or subchapter A of this chapter if such grant of authority has been altered without the consent of the issuing authority.

[68 FR 61937, Oct. 30, 2003, as amended at 70 FR 43643, July 28, 2005; 70 FR 73162, Dec. 9, 2005]

§ 171.3 Hazardous waste.

(a) No person may offer for transportation or transport a hazardous waste (as defined in §171.8 of this subchapter) in interstate or intrastate commerce except in accordance with the requirements of this subchapter.

(b) No person may accept for transportation, transport, or deliver a hazardous waste for which a manifest is required unless that person:

(1) Has marked each motor vehicle used to transport hazardous waste in accordance with §390.21 of this title even though placards may not be required;

(2) Complies with the requirements for manifests set forth in §172.205 of this subchapter; and

(3) Delivers, as designated on the manifest by the generator, the entire quantity of the waste received from the generator or a transporter to:

(i) The designated facility or, if not possible, to the designated alternate facility;

(ii) The designated subsequent carrier; or

(iii) A designated place outside the United States.

NOTE: Federal law specifies penalties up to \$250,000 fine for an individual and \$500,000 for a company and 5 years imprisonment for the willful discharge of hazardous waste at other than designated facilities. 49 U.S.C. 5124.

(c) If a discharge of hazardous waste or other hazardous material occurs during transportation, and an official of a State or local government or a

Federal agency, acting within the scope of his official responsibilities, determines that immediate removal of the waste is necessary to prevent further consequence, that official may authorize the removal of the waste without the preparation of a manifest. [NOTE: In such cases, EPA does not require carriers to have EPA identification numbers.]

NOTE 1: EPA requires shippers (generators) and carriers (transporters) of hazardous wastes to have identification numbers which must be displayed on hazardous waste manifests. See 40 CFR parts 262 and 263. (Identification number application forms may be obtained from EPA regional offices.)

NOTE 2: In 40 CFR part 263, the EPA sets forth requirements for the cleanup of releases of hazardous wastes.

[Amdt. 171-53, 45 FR 34586, May 22, 1980, as amended by Amdt. 171-53, 45 FR 74648, Nov. 10, 1980; Amdt. 171-78, 49 FR 10510, Mar. 20, 1984; Amdt. 171-107, 54 FR 40068, Sept. 29, 1989; Amdt. 171-111, 55 FR 52466, Dec. 21, 1990; 56 FR 66157, Dec. 20, 1991; Amdt. 171-2, 59 FR 49132, Sept. 26, 1994; Amdt. 171-141, 61 FR 21102, May 9, 1996; 73 FR 57004, Oct. 1, 2008]

§ 171.4 Marine pollutants.

(a) Except as provided in paragraph (c) of this section, no person may offer for transportation or transport a marine pollutant, as defined in §171.8, in intrastate or interstate commerce except in accordance with the requirements of this subchapter.

(b) The requirements of this subchapter for the transportation of marine pollutants are based on the provisions of Annex III of the 1973 International Convention for Prevention of Pollution from Ships, as modified by the Protocol of 1978 (MARPOL 73/78).

(c) *Exceptions.* Except when all or part of the transportation is by vessel, the requirements of this subchapter specific to marine pollutants do not apply to non-bulk packagings transported by motor vehicle, rail car or aircraft.

[Amdt. 171-116, 57 FR 52934, Nov. 5, 1993, as amended by Amdt. 107-39, 61 FR 51337, Oct. 1, 1996; 73 FR 4712, Jan. 28, 2008]

§ 171.6 Control numbers under the Paperwork Reduction Act.

(a) *Purpose and scope.* This section collects and displays the control numbers assigned to the HMR collections of

§ 171.6

49 CFR Ch. I (10–1–14 Edition)

information by the Office of Management and Budget (OMB) under the Paperwork Reduction Act of 1995. This section complies with the requirements of 5 CFR 1320.7(f), 1320.12, 1320.13 and 1320.14 (OMB regulations implementing the Paperwork Reduction Act of 1995) for the display of control numbers assigned by OMB to collections of information of the HMR.

(b) *OMB control numbers.* The table in paragraph (b)(2) of this section sets forth the control numbers assigned to

collection of information in the HMR by the Office of Management and Budget (OMB) under the Paperwork Reduction Act of 1995.

(1) Column 1 lists the OMB control number assigned to the HMR collections of information. Column 2 contains the Report Title of the approved collection of information. Column 3 lists the part(s) or section(s) in 49 CFR identified or described in the collection of information.

(2) Table.

Current OMB control No.	Title	Title 49 CFR part or section where identified and described
2137–0014	Cargo Tank Specification Requirements	§§ 107.503, 107.504, 178.320, 178.337, 178.338, 178.345, 180.407, 180.409, 180.413, 180.417.
2137–0018	Inspection and Testing of Portable Tanks and Intermediate Bulk Containers.	§§ 173.24, 173.32, 178.3, 178.255, 178.273, 178.274, 178.703, 178.801, 180.352, 180.605.
2137–0022	Testing, Inspection, and Marking Requirements for Cylinders.	§§ 173.5b, 173.302a, 173.303, 173.304, 173.309, 178.2, 178.3, 178.35, 178.44, 178.45, 178.46, 178.57, 178.59, 178.60, 178.61, 178.68, 180.205, 180.207, 180.209, 180.211, 180.213, 180.215, 180.217, appendix C to part 180.
2137–0034	Hazardous Materials Shipping Papers and Emergency Response Information.	§§ 172.200, 172.201, 172.202, 172.203, 172.204, 172.505, 172.600, 172.602, 172.604, 172.606, 173.6, 173.7, 173.22, 173.56, 174.24, 174.26, 174.114, 175.30, 175.31, 175.33, 176.24, 176.27, 176.30, 176.36, 176.89, 177.817.
2137–0039	Hazardous Materials Incidents Reports	§§ 171.15, 171.16, 171.21.
2137–0051	Rulemaking and Special Permit Petitions	§§ 105.30, 105.40, 106.95, 106.110, 107.105, 107.107, 107.109, 107.113, 107.117, 107.121, 107.123, 107.125, 107.205, 107.211, 107.215, 107.217, 107.219, 107.221, 107.223.
2137–0510	RAM Transportation Requirements	Part 173, subpart I, §§ 173.22, 173.411, 173.415, 173.416, 173.417, 173.457, 173.471, 173.472, 173.473, 173.476.
2137–0542	Flammable Cryogenic Liquids	§§ 173.318, 177.816, 177.840, 180.405.
2137–0557	Approvals for Hazardous Materials	§§ 107.402, 107.403, 107.405, 107.502, 107.503, 107.705, 107.713, 107.715, 107.717, 107.803, 107.805, 107.807, 110.30, 172.101, 172.102, Special Provisions 19, 26, 53, 55, 60, 105, 118, 121, 125, 129, 131, 133, 136, B45, B55, B61, B69, B77, B81, N10, N72, 173.2a, 173.4, 173.7, 173.21, 173.22, 173.24, 173.31, 173.38, 173.51, 173.56, 173.58, 173.59, 173.124, 173.128, 173.159, 173.166, 173.171, 173.214, 173.222, 173.224, 173.225, 173.245, 173.301, 173.305, 173.306, 173.314, 173.315, 173.316, 173.318, 173.334, 173.340, 173.411, 173.433, 173.457, 173.471, 173.472, 173.476, 174.50, 174.63, 175.8, 175.85, 175.701, 175.703, 176.168, 176.340, 176.704, 178.3, 178.35, 178.47, 178.53, 178.273, 178.274, 178.503, 178.509, 178.605, 178.606, 178.608, 178.801, 178.813, 180.213.

Pipeline and Haz. Matls. Safety Admin., DOT

§ 171.7

Current OMB control No.	Title	Title 49 CFR part or section where identified and described
2137-0559	(Rail Carriers and Tank Car Tank Requirements) Requirements for Rail Tank Car Tanks—Transportation of Hazardous Materials by Rail..	§§ 172.102, Special provisions: B45, B46, B55, B61, B69, B77, B78, B81; 173.10, 173.31, 174.20, 174.50, 174.63, 174.104, 174.114, 174.204, 179.3, 179.4, 179.5, 179.6, 179.7, 179.11, 179.18, 179.22, 179.100-9, 179.100-12, 179.100-13, 179.100-16, 179.100-17, 179.102-4, 179.102-17, 179.103-1, 179.103-2, 179.103-3, 179.103-5, 179.200-10, 179.200-14, 179.200-15, 179.200-16, 179.200-17, 179.200-19, 179.201-3, 179.201-8, 179.201-9, 179.220-4, 179.220-7, 179.220-8, 179.220-13, 179.220-15, 179.220-17, 179.220-18, 179.220-20, 179.220-22, 179.300-3, 179.300-7, 179.300-9, 179.300-12, 179.300-13, 179.300-15, 179.300-20, 179.400-3, 179.400-4, 179.400-11, 179.400-13, 179.400-16, 179.400-17, 179.400-19, 179.400-20, 179.500-5, 179.500-8, 179.500-12, 179.500-18, 180.505, 180.509, 180.515, 180.517.
2137-0572	Testing requirements for non-bulk packages	§§ 173.168, 178.2, 178.601, appendix C to part 178, appendix D to part 178.
2137-0582	Container Certification Statement	§§ 176.27, 176.172.
2137-0586	Hazardous Materials Public Sector Training and Planning Grants.	Part 110.
2137-0591	Response Plans for Shipments of Oil	Part 130.
2137-0595	Cargo Tank Motor Vehicles in Liquefied Compressed Gas Service.	§§ 173.315, 178.337-8, 178.337-9, 180.405, 180.416.
2137-0612	Hazardous Materials Security Plans	Part 172, subpart I, §§ 172.800, 172.802, 172.804.
2137-0613	Subsidiary Hazard Class and Number/Type of Packagings.	§§ 172.202, 172.203
2137-0620	Inspection and Testing of Meter Provers	Part 173, subpart A, § 173.5a.
2137-0621	Requirements for United Nations (UN) Cylinders	§§ 173.301, 173.304, 173.304b, 178.69, 178.70, 178.74, 178.75, 180.207, 180.209, 180.212, 180.215, 180.217.

[Amdt. 171-111, 56 FR 66157, Dec. 20, 1991]

EDITORIAL NOTE: For FEDERAL REGISTER citations affecting § 171.6, see the List of CFR Sections Affected, which appears in the Finding Aids section of the printed volume and at www.fdsys.gov.

§ 171.7 Reference material.

(a) *Matter incorporated by reference—*
 (1) *General.* There is incorporated, by reference in parts 171-180 of this subchapter, matter referred to that is not specifically set forth. This matter is hereby made a part of the regulations in parts 171-180 of this subchapter. The matter subject to change is incorporated only as it is in effect on the date of issuance of the regulation referring to that matter. The material listed in paragraphs (b) through (bb) of this section has been approved for incorporation by reference by the Director of the Federal Register in accordance with 5 U.S.C. 552(a) and 1 CFR part 51. Material is incorporated as it exists on the date of the approval and a notice of any change in the material will be published in the FEDERAL REG-

ISTER. Matters referenced by footnote are included as part of the regulations of this subchapter.

(2) *Accessibility of materials.* All incorporated matter is available for inspection at:

(i) The Office of Hazardous Materials Safety, Office of Hazardous Materials Standards, East Building, PHH-10, 1200 New Jersey Avenue SE., Washington, DC 20590-0001. For information on the availability of this material at PHH-10, call 1-800-467-4922, or go to: <http://www.phmsa.dot.gov>; and

(ii) The National Archives and Records Administration (NARA). For information on the availability of this material at NARA, call 202-741-6030, or go to: http://www.archives.gov/federal_register/

§ 171.7

49 CFR Ch. I (10–1–14 Edition)

code_of_federal_regulations/ibr_locations.html.

(b) *Air Transport Association of America*, 1301 Pennsylvania Avenue NW., Washington, DC 20004-1707.

(1) ATA Specification No. 300 Packaging of Airline Supplies, Revision 19, July 31, 1996, into § 172.102.

(2) [Reserved]

(c) *The Aluminum Association*, 1525 Wilson Blvd., Suite 6000, Arlington, VA 22209, telephone 703-358-2960, <http://www.aluminum.org>.

(1) Aluminum Standards and Data, Seventh Edition, June 1982, into §§ 172.102; 178.65.

(2) *Welding Aluminum: Theory and Practice*, 2002 Fourth Edition, into § 178.68.

(d) *American National Standards Institute, Inc.*, 25 West 43rd Street, New York, NY 10036.

(1) ANSI/ASHRAE 15-94, Safety Code for Mechanical Refrigeration, 1944, into §§ 173.306; 173.307.

(2) ANSI N14.1 Uranium Hexafluoride—Packaging for Transport, 1971 Edition, into §§ 173.417; 173.420.

(3) ANSI N14.1 Uranium Hexafluoride—Packaging for Transport, 1982 Edition, into §§ 173.417; 173.420.

(4) ANSI N14.1 Uranium Hexafluoride—Packaging for Transport, 1987 Edition, into §§ 173.417; 173.420.

(5) ANSI N14.1 Uranium Hexafluoride—Packaging for Transport, 1990 Edition, into §§ 173.417; 173.420.

(6) ANSI N14.1 Uranium Hexafluoride—Packaging for Transport, 1995 Edition, into §§ 173.417; 173.420.

(7) ANSI N14.1 Uranium Hexafluoride—Packaging for Transport, 2001 Edition, into §§ 173.417; 173.420.

(e) *American Petroleum Institute*, 1220 L Street NW., Washington, DC 20005-4070.

(1) API Recommended Practice Closures of Underground Petroleum Storage Tanks, 3rd Edition, March 1996, into § 172.102.

(2) [Reserved]

(f) *American Pyrotechnics Association (APA)*, P.O. Box 30438, Bethesda, MD

20824, (301) 907-8181, www.americanpyro.com.

(1) APA Standard 87-1, Standard for Construction and Approval for Transportation of Fireworks, Novelties, and Theatrical Pyrotechnics, December 1, 2001 version into § 173.56.

(2) [Reserved]

(g) *American Society of Mechanical Engineers*, ASME International, 22 Law Drive, P.O. Box 2900, Fairfield, NJ 07007-2900, telephone 1-800-843-2763 or 1-973-882-1170, <http://www.asme.org>.

(1) ‘ASME Code’; ASME Code, Sections II (Parts A and B), V, VIII (Division 1), and IX of 1998 Edition of American Society of Mechanical Engineers Boiler and Pressure Vessel Code, into §§ 172.102; 173.5b; 173.24b; 173.32; 173.306; 173.315; 173.318; 173.420; 178.245-1; 178.245-3; 178.245-4; 178.245-6; 178.245-7; 178.255-1; 178.255-2; 178.255-14; 178.255-15; 178.270-2; 178.270-3; 178.270-7; 178.270-9; 178.270-11; 178.270-12; 178.271-1; 178.272-1; 178.273; 178.274; 178.276; 178.277; 178.320; 178.337-1; 178.337-2; 178.337-3; 178.337-4; 178.337-6; 178.337-16; 178.337-18; 178.338-1; 178.338-2; 178.338-3; 178.338-4; 178.338-5; 178.338-6; 178.338-13; 178.338-16; 178.338-18; 178.338-19; 178.345-1; 178.345-2; 178.345-3; 178.345-4; 178.345-7; 178.345-14; 178.345-15; 178.346-1; 178.347-1; 178.348-1; 179.400-3; 180.407.

(2) ASME B31.4-1998 Edition, Pipeline Transportation Systems for Liquid Hydrocarbons and other Liquids, Chapters II, III, IV, V and VI, November 11, 1998, into § 173.5a.

(h) *American Society for Testing and Materials*, 100 Barr Harbor Drive, West Conshohocken, PA 1942, telephone (610) 832-9585, <http://www.astm.org>. Copies of historical standards or standards that ASTM does not have may be purchased from: Engineering Societies Library, 354 East 47th Street, New York, NY 10017.

(1) ASTM A 20/A 20M-93a Standard Specification for General Requirements for Steel Plates for Pressure Vessels, 1993, into §§ 178.337-2; 179.102-4; 179.102-1; 179.102-17.

(2) ASTM A 47-68 Malleable Iron Castings, 1968, into § 179.200-15.

(3) ASTM A 53/A 53M-06a (ASTM A 53) Standard Specification for Pipe, Steel, Black and Hot-Dipped, Zinc-Coated, Welded and Seamless, 2006, into § 173.5b.

- (4) ASTM A 106/A 106M-06a (ASTM A 106) Standard Specification for Seamless Carbon Steel Pipe for High-Temperature Service, 2006, into §173.5b.
- (5) ASTM A 240/A 240M-99b Standard Specification for Heat-Resisting Chromium and Chromium-Nickel Stainless Steel Plate, Sheet and Strip for Pressure Vessels, 1999, into §§178.57; 178.358-5; 179.100-7; 179.100-10; 179.102-1; 179.102-4; 179.102-17; 179.200-7; 179.201-5; 179.220-7; 179.300-7; 179.400-5.
- (6) ASTM A 242-81 Standard Specification for High-Strength Low-Alloy Structural Steel, 1981, into §178.338-2.
- (7) ASTM A 262-93a Standard Practices for Detecting Susceptibility to Intergranular Attack in Austenitic Stainless Steels, 1993, into 179.100-7; 179.200-7; 179.201-4.
- (8) ASTM A 285-78 Pressure Vessel Plates, Carbon Steel, Low- and Intermediate-Tensile Strength, 1978, into §179.300-7.
- (9) ASTM A 300-58 Steel Plates for Pressure Vessels for Service at Low Temperatures, 1958, into §178.337-2.
- (10) ASTM A 302/A 302M-93 Standard Specification for Pressure Vessel Plates, Alloy Steel, Manganese-Molybdenum and Manganese-Molybdenum Nickel, 1993, into §179.100-7; 179.200-7; 179.220-7.
- (11) ASTM A 333-67 Seamless and Welded Steel Pipe for Low-Temperature Service, 1967, into §178.45.
- (12) ASTM A 370-94 Standard Test 179.102-1; 179.102-4; Methods and Definitions for Mechanical Testing of Steel Products, 1994, into §§179.102-17; 179.102-1; 179.102-4.
- (13) ASTM A 441-81 Standard Specification for High-Strength Low-Alloy Structural Manganese Vanadium Steel, 1981, into §178.338-2.
- (14) ASTM A 514-81 Standard Specification for High-Yield Strength Quenched and Tempered Alloy Steel Plate, Suitable for Welding, 1981, into §178.338-2.
- (15) ASTM A 515/A 515M-03 Standard Specification for Pressure Vessel Plates, Carbon Steel, for Intermediate- and Higher-Temperature Service, 2003, into §179.300-7.
- (16) ASTM A 516/A 516M-90 Standard Specification for Pressure Vessel Plates, Carbon Steel, for Moderate and Lower-Temperature Service, 1990, into §178.337-2; 179.100-7; 179.102-1; 179.102-2; 179.102-4; 179.102-17; 179.200-7; 179.220-7; 179.300-7.
- (17) ASTM A 537/A 537M-91 Standard Specification for Pressure Vessel Plates, Heat-Treated, Carbon-Manganese-Silicon Steel, 1991, into §179.100-7; 179.102-4; 179.102-17.
- (18) ASTM A 572-82 Standard Specification for High-Strength Low-Alloy Columbium-Vanadium Steels of Structural Quality, 1982, into §178.338-2.
- (19) ASTM A 588-81 Standard Specification for High-Strength Low-Alloy Structural Steel with 50 Ksi Minimum Yield Point to 4 in. Thick, 1981, into §178.338-2.
- (20) ASTM A 606-75 Standard Specification for Steel Sheet and Strip Hot-Rolled and Cold-Rolled, High-Strength, Low-Alloy, with Improved Atmospheric Corrosion Resistance, 1975 (Reapproved 1981), into §178.338-2.
- (21) ASTM A 607-98 Standard Specification for Steel, Sheet and Strip, High-Strength, Low-Alloy, Columbium or Vanadium, or Both, Hot-Rolled and Cold-Rolled, 1998, into §178.338-2.
- (22) ASTM A 612-72a High Strength Steel Plates for Pressure Vessels for Moderate and Lower Temperature Service, 1972, into §178.337-2.
- (23) ASTM A 633-79a Standard Specification for Normalized High-Strength Low-Alloy Structural Steel, 1979 Edition, into §178.338-2.
- (24) ASTM A 715-81 Standard Specification for Steel Sheet and Strip, Hot-Rolled, High-Strength, Low-Alloy with Improved Formability, 1981, into §178.338-2.
- (25) ASTM A 1008/A 1008M-03 Standard Specification for Steel, Sheet, Cold-Rolled, Carbon, Structural, High-Strength Low-Alloy and High Strength Low-Alloy with Improved Formability, 2003, into §178.338-2; 178.345-2.
- (26) ASTM A 1011/A 1011M-03a Standard Specification for Steel, Sheet and Strip, Hot-Rolled, Carbon, Structural, High-Strength Low Alloy and High Strength Low-Alloy with Improved Formability, 2003, into §178.338-2; 178.345-2.
- (27) ASTM B 162-93a Standard Specification for Nickel Plate, Sheet, and Strip, 1993, into §173.249; 179.200-7.
- (28) ASTM B 209-93 Standard Specification for Aluminum and Aluminum-

§ 171.7

Alloy Sheet and Plate, 1993, into § 179.100-7; 179.200-7; 179.220-7.

(29) ASTM B 221-76 Aluminum Alloy Extruded Bars, Rods, Shapes, and Tubes, 1976, into § 178.46.

(30) ASTM B 557-84 Tension Testing Wrought and Cast Aluminum and Magnesium-Alloy Products, 1984, into § 178.46.

(31) ASTM B 580-79 Standard Specification for Anodic Oxide Coatings on Aluminum, (Re-approved 2000), into § 173.316; 173.318; 178.338-17.

(32) ASTM D 56-05, Standard Test Method for Flash Point by Tag Closed Cup Tester, approved May 1, 2005, into § 173.120.

(33) ASTM D 86-07a, Standard Test Method for Distillation of Petroleum Products at Atmospheric Pressure, approved April 1, 2007, into § 173.121.

(34) ASTM D 93-08, Standard Test Methods for Flash Point by Pensky-Martens Closed Cup Tester, approved October 15, 2008, into § 173.120.

(35) ASTM D 1078-05, Standard Test Method for Distillation Range of Volatile Organic Liquids, approved May 15, 2005, into § 173.121.

(36) ASTM D 1238-90b Standard Test Method for Flow Rates of Thermoplastics for Extrusion Plastometer, 1990, into § 173.225.

(37) ASTM D 1709-01 Standard Test Methods for Impact Resistance of Plastic Film by the Free-Falling Dart Method, 2001, into § 173.197.

(38) ASTM D 1835-97 Standard Specification for Liquefied Petroleum (LP) Gases, 1997, into § 180.209.

(39) ASTM D 1838-64 Copper Strip Corrosion by Liquefied Petroleum (LP) Gases, 1964, into § 173.315.

(40) ASTM D 1922-00a Standard Test Method for Propagation Tear Resistance of Plastic Film and Thin Sheeting by Pendulum Method, 2000, into § 173.197.

(41) ASTM D 3278-96 (Reapproved 2004) E1, Standard Test Methods for Flash Point of Liquids by Small Scale Closed-Cup Apparatus, approved November 1, 2004, into § 173.120.

(42) ASTM D 3828-07a, Standard Test Methods for Flash Point by Small Scale Closed Cup Tester, approved July 15, 2007, § 173.120.

(43) ASTM D 4206-96 Standard Test Method for Sustained Burning of Liq-

49 CFR Ch. I (10-1-14 Edition)

uid Mixtures Using the Small Scale Open-Cup Apparatus, 1996, into § 173.120.

(44) ASTM D 4359-90 Standard Test Method for Determining Whether a Material is a Liquid or a Solid, 1990 into § 171.8.

(45) ASTM E 8-99 Standard Test Methods for Tension Testing of Metallic Materials, 1999, into § 178.36; 178.37; 178.38; 178.39; 178.44; 178.45; 178.50; 178.51; 178.53; 178.55; 178.56; 178.57; 178.58; 178.59; 178.60; 178.61; 178.68.

(46) ASTM E 23-98 Standard Test Methods for Notched Bar Impact Testing of Metallic Materials, 1998, into § 178.57.

(47) ASTM E 112-88 Standard Test Methods for Determining Average Grain Size, 1988, into § 178.44.

(48) ASTM E 112-96 Standard Test Methods for Determining Average Grain Size, 1996 Edition, into § 178.274; part 178, appendix A.

(49) ASTM E 114-95 Standard Practice for Ultrasonic Pulse-Echo Straight-Beam Examination by the Contact Method, 1995, into § 178.45.

(50) ASTM E 213-98 Standard Practice for Ultrasonic Examination of Metal Pipe and Tubing, into § 178.45.

(51) ASTM E 290-97a Standard Test Methods for Bend Testing of Material for Ductility, published February 1998, into § 178.37.

(i) [Reserved]

(j) *American Welding Society*, 550 NW. Le Jeune Road, Miami, Florida 33126.

(1) AWS Code B 3.0; Standard Qualification Procedure; 1972 (FRB 3.0-41, rev. May 1973), into §§ 178.356-2, 178.358-2.

(2) AWS Code D 1.0; Code for Welding in Building Construction (FR D 1.0-66, 1966), into §§ 178.356-2; 178.358-2.

(k) *Association of American Railroads*, American Railroads Building, 50 F Street NW., Washington, DC 20001; telephone (877) 999-8824, <http://www.aar.org/publications.com>.

(1) AAR Manual of Standards and Recommended Practices, Section C—Part III, Specifications for Tank Cars, Specification M-1002, (AAR Specifications for Tank Cars), December 2000, § 173.31; 179.6; 179.7; 179.15; 179.16; 179.20; 179.22; 179.100-9; 179.100-10; 179.100-12; 179.100-13; 179.100-14; 179.100-18; 179.101-1; 179.102-1; 179.102-4; 179.102-17; 179.103-5; 179.200-7; 179.200-9; 179.200-10; 179.200-

11; 179.200-13; 179.200-17; 179.200-22; 179.201-6; 179.220-6; 179.220-7; 179.220-10; 179.220-11; 179.220-14; 179.220-18; 179.220-26; 179.300-9; 179.300-10; 179.300-15; 179.300-17; 179.400-5; 179.400-6; 179.400-8; 179.400-11; 179.400-12; 179.400-15; 179.400-18; 179.400-20; 179.400-25; 180.509; 180.513; 180.515; 180.517.

(2) AAR Manual of Standards and Recommended Practices, Section I, Specially Equipped Freight Car and Intermodal Equipment, 1988, into § 174.55; 174.63.

(3) AAR Specifications for Design, Fabrication and Construction of Freight Cars, Volume 1, 1988, into § 179.16.

(4) AAR Standard 286; AAR Manual of Standards and Recommended Practices, Section C, Car Construction Fundamentals and Details, Standard S-286, Free/Unrestricted Interchange for 286,000 lb Gross Rail Load Cars (Adopted 2002; Revised: 2003, 2005, 2006), into 179.13.

(1) *Chlorine Institute, Inc.*, 1300 Wilson Boulevard, Arlington, VA 22209.

(1) Chlorine Institute Emergency Kit "A" for 100-lb. & 150 lb. Chlorine Cylinders (with the exception of repair method using Device 8 for side leaks), Edition 10, June 2003, into 173.3.

(2) Chlorine Institute Emergency Kit "B" for Chlorine Ton Containers (with the exception of repair method using Device 9 for side leaks), Edition 9, June 2003, into 173.3.

(3) Type 1 JQ 225, Dwg., H51970, Revision F, November 1996, into § 173.315.

(4) Type 1 JQ 225, Dwg., H50155, Revision H, November 1996, into § 173.315.

(5) Section 3, Pamphlet 57, Emergency Shut-Off Systems for Bulk Transfer of Chlorine, Edition 4, October 2003, into § 177.840.

(6) Section 3, Pamphlet 166, Angle Valve Guidelines for Chlorine Bulk Transportation, 1st Edition, October 2002, into § 178.337-9.

(7) Standard Chlorine Angle Valve Assembly, Dwg. 104-8, July 1993, into § 178.337-9.

(8) Excess Flow Valve with Removable Seat, Dwg. 101-7, July 1993, into § 178.337-8.

(9) Excess Flow Valve with Removable Basket, Dwg. 106-6, July 1993, into § 178.337-8.

(10) Standards for Housing and Manway Covers for Steel Cargo Tanks, Dwgs. 137-1 and 137-2, September 1, 1982, into § 178.337-10.

(1) Typical Manway Arrangement Chlorine Cargo Tank, Dwg 137-5, November 1996, into 178.337-10.

(m) *Canadian General Standards Board*, Place du Portage III, 6B1 11 Laurier Street, Gatineau, Quebec, Canada K1A 1G6.

(1) National Standard of Canada (CAN/CGSB 43.147-2005) Construction, Modification, Qualification, Maintenance, and Selection and Use of Means of Containment for the Handling, Offering for Transport, or Transportation of Dangerous Goods by Rail, into § 171.12.

(2) [Reserved]

(n) *Compressed Gas Association (CGA)*, 1235 Jefferson Davis Highway, Arlington, VA 22202.

(1) CGA Pamphlet C-3, Standards for Welding on Thin-Walled Steel Cylinders, 1994, into § 178.47; 178.50; 178.51; 178.53; 178.55; 178.56; 178.57; 178.58; 178.59; 178.60; 178.61; 178.65; 178.68; 180.211.

(2) CGA C-5, Cylinder Service Life—Seamless Steel High Pressure Cylinders, 1991 (reaffirmed 1995), into § 173.302a.

(3) CGA Pamphlet C-6, Standards for Visual Inspection of Steel Compressed Gas Cylinders, 1993, into § 172.102, § 173.3, 173.198, 180.205, 180.209, 180.211, 180.411, 180.519.

(4) CGA Pamphlet C-6.1, Standards for Visual Inspection of High Pressure Aluminum Compressed Gas Cylinders, 2002, Fourth Edition, into § 180.205; 180.209.

(5) CGA Pamphlet C-6.2, Guidelines for Visual Inspection and Requalification of Fiber Reinforced High Pressure Cylinders, 1996, Third Edition, into § 180.205.

(6) CGA Pamphlet C-6.3, Guidelines for Visual Inspection and Requalification of Low Pressure Aluminum Compressed Gas Cylinders, 1991, into § 180.205; 180.209.

(7) CGA C-7, Guide to Preparation of Precautionary Labeling and Marking of Compressed Gas Containers, Appendix A, issued 2004 (8th Edition), into § 172.400a.

(8) CGA Pamphlet C-8, Standard for Requalification of DOT-3HT Cylinder Design, 1985, into § 180.205; 180.209.

§ 171.7

49 CFR Ch. I (10–1–14 Edition)

(9) CGA Pamphlet C-11, Recommended Practices for Inspection of Compressed Gas Cylinders at Time of Manufacture, 2001, Third Edition, into § 178.35.

(10) CGA Pamphlet C-12, Qualification Procedure for Acetylene Cylinder Design, 1994, into § 173.301; 173.303; 178.59; 178.60.

(11) CGA Pamphlet C-13, Guidelines for Periodic Visual Inspection and Requalification of Acetylene Cylinders, 2000, Fourth Edition, into § 173.303; 180.205; 180.209.

(12) CGA Pamphlet C-14, Procedures for Fire Testing of DOT Cylinder Pressure Relief Device Systems, 1979, into § 173.301; 173.323.

(13) CGA Pamphlet G-2.2, Guideline Method for Determining Minimum of 0.2% Water in Anhydrous Ammonia, 1985, Second Edition, Reaffirmed 1997, into § 173.315.

(14) CGA Pamphlet G-4.1, Cleaning Equipment for Oxygen Service, 1985, into § 178.338–15.

(15) CGA Pamphlet P-20, Standard for the Classification of Toxic Gas Mixtures, 1995, into § 173.115.

(16) CGA Pamphlet P-20, Standard for the Classification of Toxic Gas Mixtures, 2003, Third Edition, into § 173.115.

(17) CGA S-1.1, Pressure Relief Device Standards—Part 1—Cylinders for Compressed Gases, (with the exception of paragraph 9.1.1.1), Twelfth Edition, 2005, into § 173.301, 173.304a 178.75.

(18) CGA Pamphlet S-1.2, Safety Relief Device Standards Part 2—Cargo and Portable Tanks for Compressed Gases, 1980, into § 173.315; 173.318; 178.276; 178.277.

(19) CGA S-7, Method for Selecting Pressure Relief Devices for Compressed Gas Mixtures in Cylinders, 2005, into § 173.301.

(20) CGA Technical Bulletin TB-2, Guidelines for Inspection and Repair of MC-330 and MC-331 Cargo Tanks, 1980, into § 180.407; 180.413.

(21) CGA Technical Bulletin TB-25, Design Considerations for Tube Trailers, 2008 Edition, into § 173.301.

(o) *Department of Defense (DOD)*, 2461 Eisenhower Avenue, Alexandria, VA 22331.

(1) DOD TB 700-2; NAVSEAINST 8020.8B; AFTO 11A-1-47; DLAR 8220.1:

Explosives Hazard Classification Procedures, January 1998, into § 173.56.

(2) Packaging of Hazardous Material, DLAD 4145.41/AR 700-143/AFJI 24-210/NAVSUPINST 4030.55B/MCO 4030.40B, January 14, 2000, into § 173.7.

(p) [Reserved]

(q) *General Services Administration*, Specification Office, Room 6662, 7th and D Street, S.W., Washington, DC 20407.

(1) Federal Specification RR-C-901D, Cylinders, Compressed Gas: Seamless Shatterproof, High Pressure DOT 3AA Steel, and 3AL Aluminum, February 21, 2003, into §§ 173.302; 173.336; 173.337.

(2) [Reserved]

(r) *Institute of Makers of Explosives*, 1120 19th Street NW., Suite 310, Washington, DC 20036-3605.

(1) IME Standard 22, IME Safety Library Publication No. 22, Recommendations for the Safe Transportation of Detonators in a Vehicle with Certain Other Explosive Materials, February 2007, into §§ 173.63; 177.835.

(2) [Reserved]

(s) *International Atomic Energy Agency (IAEA)*, P.O. Box 100, Wagramer Strasse 5, A-1400 Vienna, Austria. Also available from: Bernan Associates, 4611-F Assembly Drive, Lanham, MD 20706-4391, USA; or Renouf Publishing Company, Ltd., 812 Proctor Avenue, Ogdensburg, New York 13669, USA.

(1) No. TS-R-1 (ST-1, Revised), Regulations for the Safe Transport of Radioactive Material, (IAEA Regulations), 1996 Edition (Revised), into § 171.22; 171.23; 171.26, 173.415, 173.416, 173.417, 173.473.

(2) [Reserved]

(t) *International Civil Aviation Organization* (“ICAO”), 999 University Street, Montréal, Quebec H3C 5H7, Canada, 1-514-954-8219, <http://www.icao.int>. ICAO Technical Instructions available from: INTEREG, International Regulations, Publishing and Distribution Organization, P.O. Box 60105, Chicago, IL 60660.

(1) Technical Instructions for the Safe Transport of Dangerous Goods by Air (ICAO Technical Instructions), 2013-2014 Edition, into §§ 171.8; 171.22; 171.23; 171.24; 172.101; 172.202; 172.401; 172.512; 172.519; 172.602; 173.56; 173.320; 175.10, 175.33; 178.3.

(2) [Reserved]

(u) International Electrotechnical Commission (IEC), 3 rue de Varembe, P.O. Box 131, CH—1211, GENEVA 20, Switzerland.

(1) IEC 62282-6-100:2010(E), Fuel cell technologies—Part 6-100: Micro fuel cell power systems—Safety, Edition 1.0, March 2010, into §§ 173.230; 175.10.

(2) 62282-6-100 Amend. 1 IEC 2012(E), Amendment 1 to IEC 62282-6-100: Fuel cell technologies—Part 6-100: Micro fuel cell power systems—Safety, Edition 1.0, October 2012, into §§ 173.230; 175.10

(v) *International Maritime Organization* (“IMO”), 4 Albert Embankment, London, SE1 7SR, United Kingdom or New York Nautical Instrument & Service Corporation, 140 West Broadway, New York, NY 10013, +44 (0) 20 7735 7611, <http://www.imo.org>.

(1) International Convention for the Safety of Life at Sea, 1974, Consolidated Edition (SOLAS), Chapter II-2, Construction—Fire protection, fire detection and fire extinction, Regulation 19, Carriage of dangerous goods, Fifth Edition 2009, into §§ 176.63, 176.84.

(2) International Maritime Dangerous Goods Code (IMDG Code), Incorporating Amendment 36-12 (English Edition), 2011, into §§ 171.22; 171.23; 171.25; 172.101 172.202; 172.203 172.401; 172.502; 172.519; 172.602; 173.21; 173.56; 176.2; 176.5; 176.11; 176.27; 176.30; 176.83; 176.84; 176.140; 176.720; 178.3; 178.274.

(w) *International Organization for Standardization*, Case Postale 56, CH-1211, Geneve 20, Switzerland, <http://www.iso.org>. Also available from: ANSI 25, West 43rd Street, New York, NY 10036, 1-212-642-4900, <http://www.ansi.org>.

(1) ISO 535-1991(E) Paper and board—Determination of water absorptiveness—Cobb method, 1991, into § 178.516; 178.707; 178.708.

(2) ISO 1496-1: 1990 (E)—Series 1 freight containers—Specification and testing, Part 1: General cargo containers. Fifth Edition, (August 15, 1990), into § 173.411.

(3) ISO 1496-3(E)—Series 1 freight containers—Specification and testing—Part 3: Tank containers for liquids, gases and pressurized dry bulk, Fourth edition, March 1995, into § 178.74; 178.75; 178.274.

(4) ISO 1516:2002(E), Determination of flash/no flash—Closed cup equilibrium

method, Third Edition, 2002-03-01, into § 173.120.

(5) ISO 1523:2002(E), Determination of flash point—Closed cup equilibrium method, Third Edition, 2002-03-01, into § 173.120.

(6) ISO 2431-1984(E) Standard Cup Method, 1984, into § 173.121.

(7) ISO 2592:2000(E), Determination of flash and fire points—Cleveland open cup method, Second Edition, 2000-09-15, into § 173.120.

(8) ISO 2719:2002(E), Determination of flash point—Pensky-Martens closed cup method, Third Edition, 2002-11-15, into § 173.120.

(9) ISO 2919-1980(E) Sealed radioactive sources—Classification, 1980, into § 173.469.

(10) ISO 3036-1975(E) Board—Determination of puncture resistance, 1975, into § 178.708.

(11) ISO 3405:2000(E), Petroleum products—Determination of distillation characteristics at atmospheric pressure, Third Edition, 2000-03-01, into § 173.121.

(12) ISO 3574-1986(E) Cold-reduced carbon steel sheet of commercial and drawing qualities, into § 178.503; part 178, appendix C.

(13) ISO 3679:2004(E), Determination of flash point—Rapid equilibrium closed cup method, Third Edition, 2004-04-01, into § 173.120.

(14) ISO 3680:2004(E), Determination of flash/no flash—Rapid equilibrium closed cup method, Fourth Edition, 2004-04-01, into § 173.120.

(15) ISO 3807-2(E), Cylinders for acetylene—Basic requirements—Part 2: Cylinders with fusible plugs, First edition, March 2000, into §§ 173.303; 178.71.

(16) ISO 3924:1999(E), Petroleum products—Determination of boiling range distribution—Gas chromatography method, Second Edition, 1999-08-01, into § 173.121.

(17) ISO 4126-1:2004(E): Safety devices for protection against excessive pressure—Part 1: Safety valves, Second edition 2004-02-15, into § 178.274.

(18) ISO 4126-7:2004(E): Safety devices for protection against excessive pressure—Part 7: Common data, First Edition 2004-02-15 into § 178.274.

(19) ISO 4126-7:2004/Cor.1:2006(E): Safety devices for protection against excessive pressure—Part 7: Common data,

Technical Corrigendum 1, 2006–11–01, into §178.274.

(20) ISO 4626:1980(E), Volatile organic liquids—Determination of boiling range of organic solvents used as raw materials, First Edition, 1980–03–01, into §173.121.

(21) ISO 4706:2008(E), Gas cylinders—Refillable welded steel cylinders—Test pressure 60 bar and below, First Edition, 2008–04–15, Corrected Version, 2008–07–01, into §178.71.

(22) ISO 6406(E), Gas cylinders—Seamless steel gas cylinders—Periodic inspection and testing, Second edition, February 2005, into §180.207.

(23) ISO 6892 Metallic materials—Tensile testing, July 15, 1984, First Edition, into §178.274.

(24) ISO 7225(E), Gas cylinders—Precautionary labels, Second Edition, July 2005, into §178.71.

(25) ISO 7866(E), Gas cylinders—Refillable seamless aluminum alloy gas cylinders—Design, construction and testing, First edition, June 1999, into §178.71.

(26) ISO 8115 Cotton bales—Dimensions and density, 1986 Edition, into §172.102.

(27) ISO 9809–1(E): Gas cylinders—Refillable seamless steel gas cylinders—Design, construction and testing—Part 1: Quenched and tempered steel cylinders with tensile strength less than 1100 MPa., First edition, June 1999, into §§178.71; 178.75.

(28) ISO 9809–2(E): Gas cylinders—Refillable seamless steel gas cylinders—Design, construction and testing—Part 2: Quenched and tempered steel cylinders with tensile strength greater than or equal to 1100 MPa., First edition, June 2000, into §§178.71; 178.75.

(29) ISO 9809–3 (E): Gas cylinders—Refillable seamless steel gas cylinders—Design, construction and testing—Part 3: Normalized steel cylinders, First edition, December 2000, into §§178.71; 178.75.

(30) ISO 9978:1992(E)—Radiation protection—Sealed radioactive sources—Leakage test methods, First Edition, (February 15, 1992), into §173.469.

(31) ISO 10156:2010(E): Gases and gas mixtures—Determination of fire potential and oxidizing ability for the selection of cylinder valve outlets, Third edition, 2010–04–01, into §173.115.

(32) ISO 10156:2010/Cor.1:2010(E): Gases and gas mixtures—Determination of fire potential and oxidizing ability for the selection of cylinder valve outlets, Technical Corrigendum 1, 2010–09–01, into §173.115.

(33) ISO 10297:2006(E), Transportable gas cylinders—Cylinder valves—Specification and type testing, Second Edition, 2006–01–15, into §173.301b; 178.71.

(34) ISO 10461:2005(E), Gas cylinders—Seamless aluminum-alloy gas cylinders—Periodic inspection and testing, Second Edition, 2005–02–15 and Amendment 1, 2006–07–15, into §180.207.

(35) ISO 10462 (E), Gas cylinders—Transportable cylinders for dissolved acetylene—Periodic inspection and maintenance, Second edition, February 2005, into §180.207.

(36) ISO 10692–2:2001(E), Gas cylinders—Gas cylinder valve connections for use in the micro-electronics industry—Part 2: Specification and type testing for valve to cylinder connections, First Edition, 2001–08–01, into §173.40.

(37) ISO 11114–1(E), Transportable gas cylinders—Compatibility of cylinder and valve materials with gas contents—Part 1: Metallic materials, First edition, October 1997, into §§173.301b; 178.71.

(38) ISO 11114–2(E), Transportable gas cylinders—Compatibility of cylinder and valve materials with gas contents—Part 2: Non-metallic materials, First edition, December 2000, into §§173.301b; 178.71.

(39) ISO 11117:2008(E): Gas cylinders—Valve protection caps and valve guards—Design, construction and tests, Second edition, 2008–09–01, into §173.301b.

(40) ISO 11117:2008/Cor.1:2009(E): Gas cylinders—Valve protection caps and valve guards—Design, construction and tests, Technical Corrigendum 1, 2009–05–01, into §173.301b.

(41) ISO 11118(E), Gas cylinders—Non-refillable metallic gas cylinders—Specification and test methods, First edition, October 1999, into §178.71.

(42) ISO 11119–1(E), Gas cylinders—Gas cylinders of composite construction—Specification and test methods—Part 1: Hoop-wrapped composite gas cylinders, First edition, May 2002, into §178.71.

(43) ISO 11119-2(E), Gas cylinders—Gas cylinders of composite construction—Specification and test methods—Part 2: Fully wrapped fibre reinforced composite gas cylinders with load-sharing metal liners, First edition, May 2002, into §178.71.

(44) ISO 11119-3(E), Gas cylinders of composite construction—Specification and test methods—Part 3: Fully wrapped fibre reinforced composite gas cylinders with non-load-sharing metallic or non-metallic liners, First edition, September 2002, into §178.71.

(45) ISO 11120(E), Gas cylinders—Refillable seamless steel tubes of water capacity between 150 L and 3000 L—Design, construction and testing, First edition, March 1999, into §§178.71; 178.75.

(46) ISO 11621(E), Gas cylinders—Procedures for change of gas service, First edition, April 1997, into §§173.302, 173.336, 173.337.

(47) ISO 11623(E), Transportable gas cylinders—Periodic inspection and testing of composite gas cylinders, First edition, March 2002, into §180.207.

(48) ISO 13340:2001(E) Transportable gas cylinders—Cylinder valves for non-refillable cylinders—Specification and prototype testing, First edition, 2004-04-01, into §§173.301b; 178.71.

(49) ISO 13736:2008(E), Determination of flash point—Abel closed-cup method, Second Edition, 2008-09-15, into §173.120.

(50) ISO 16111:2008(E), Transportable gas storage devices—Hydrogen absorbed in reversible metal hydride, First Edition, 2008-11-15, into §§173.301b; 173.311; 178.71.

(51) ISO 18172-1:2007(E), Gas cylinders—Refillable welded stainless steel cylinders—Part 1: Test pressure 6 MPa and below, First Edition, 2007-03-01, into §178.71.

(52) ISO 20703:2006(E), Gas cylinders—Refillable welded aluminum-alloy cylinders—Design, construction and testing, First Edition, 2006-05-01, into §178.71.

(x) *National Board of Boiler and Pressure Vessel Inspectors*, 1055 Crupper Avenue, Columbus, Ohio 43229.

(1) NB-23, National Board Inspection Code, A Manual for Boiler and Pressure Vessel Inspectors, 1992 Edition, into §180.413.

(2) [Reserved]

(y) *National Fire Protection Association*, 1 Batterymarch Park, Quincy, MA, 02169-7471 1-617-770-3000, <http://www.nfpa.org>.

(1) NFPA 58-Liquefied Petroleum Gas Code, 2001 Edition, into §§173.5, 173.315.

(2) NFPA 498-Standards for Safe Havens and Interchange Lots for Vehicles Transporting Explosives, 2010 Edition, into §177.835.

(z) *National Institute of Standards and Technology*, Department of Commerce, 5285 Port Royal Road, Springfield, VA 22151.

(1) USDC, NBS Handbook H-28 (1957), 1957 Handbook of Screw-Thread Standards for Federal Services, December 1966 Edition, into §§179.2; 178.45; 178.46.

(2) [Reserved]

(aa) *Organization for Economic Co-operation and Development (OECD)*, OECD Publications and Information Center, 2001 L Street, N.W., Suite 700, Washington, DC 20036.

(1) Test No. 404: Acute Dermal Irritation/Corrosion, OECD Guidelines for the Testing of Chemicals, Section 4: Health Effects, adopted April 24, 2002, into §173.137.

(2) Test No. 430: In Vitro Skin Corrosion: Transcutaneous Electrical Resistance Test (TER), OECD Guidelines for the Testing of Chemicals, Section 4: Health Effects, adopted April 13, 2004, into §173.137.

(3) OECD (2004), Test No. 431: In Vitro Skin Corrosion: Human Skin Model Test, OECD Guidelines for the Testing of Chemicals, Section 4: Health Effects, OECD Publishing, adopted April 13, 2004, into §173.137.

(4) Test No. 435: In Vitro Membrane Barrier Test Method for Skin Corrosion, OECD Guidelines for the Testing of Chemicals, Section 4: Health Effects, adopted July 19, 2006, into §173.137.

(bb) *Transport Canada*, TDG Canadian Government Publishing Center, Supply and Services, Canada, Ottawa, Ontario, Canada K1A 0S9, 416-973-1868, <http://www.tc.gc.ca>.

(1) Transportation of Dangerous Goods Regulations (Transport Canada TDG Regulations), into §§171.12; 171.22; 171.23; 172.401; 172.502; 172.519; 172.602; 173.31; 173.32; 173.33.

(i) SOR 2001-286, including Clear Language Amendments, August 2001.

(ii) SOR/2002-306 August 8, 2002.

§ 171.7

49 CFR Ch. I (10–1–14 Edition)

- (iii) SOR/2003–273 July 24, 2003
- (iv) SOR/2003–400 December 3, 2003
- (v) SOR/2005–216 July 13, 2005
- (vi) SOR/2005–279 September 21, 2005
- (vii) SOR/2008–34 February 7, 2008
- (viii) SOR/2007–179 July 31, 2007
- (2) [Reserved]
- (cc) *Truck Trailer Manufacturers Association*, 1020 Princess Street, Alexandria, Virginia 22314.
 - (1) TTMA RP No. 61–98, Performance of manhole and/or Fill Opening Assemblies on MC 306, DOT 406, Non-ASME MC 312 and Non-ASME DOT 412 Cargo Tanks, June 1, 1998, into § 180.405.
 - (2) TTMA RP No. 81–97, Performance of Spring Loaded Pressure Relief Valves on MC 306, MC 307, MC 312, DOT 406, DOT 407, and DOT 412 Tanks, July 1, 1997 Edition, into §§ 178.345–10; 178.346–3.
 - (3) TTMA TB No. 107, Procedure for Testing In-Service Unmarked and/or Uncertified MC 306 and Non-ASME MC

- 312 Type Cargo Tank Manhole Covers, June 1, 1998 Edition, into § 180.405.
 - (dd) *United Nations*, Publications, 2 United Nations Plaza, Room DC2–853, New York, NY 10017, 1–212–963–8302, <http://unp.un.org>.
 - (1) UN Recommendations on the Transport of Dangerous Goods, Model Regulations (UN Recommendations), 17th revised edition, Volumes I and II (2011), into §§ 171.8; 171.12; 172.202; 172.401; 172.407; 172.502; 173.22; 173.24; 173.24b; 173.40; 173.56; 173.192; 173.302b; 173.304b; 178.75; 178.274.
 - (2) UN Recommendations on the Transport of Dangerous Goods, Manual of Tests and Criteria, (Manual of Tests and Criteria), into §§ 172.102; 173.21; 173.56; 173.57; 173.58; 173.60; 173.115; 173.124; 173.125; 173.127; 173.128; 173.137; 173.185; 173.220; part 173, appendix H; 178.274:
 - (i) Fifth revised edition (2009).
 - (ii) Fifth revised edition, amendment 1 (2011).

TABLE 1 TO 49 CFR 171.7—MATERIALS NOT INCORPORATED BY REFERENCE

Source and name of material	49 CFR reference
<i>American Biological Safety Association</i> 1202 Allanson Road, Mundelein, IL 60060: Risk Group Classification for Infectious Agents, 1998	173.134.
<i>American Institute of Chemical Engineers (AIChE)</i> , 3 Park Avenue New York, NY 10016–5991: Process Safety Progress Journal, Vol. 21, No. 2, Example of a Test Method for Venting Sizing: OPPSD/SPI Methodology.	Note to § 173. 225(h)(3)(vi).
<i>American Society for Testing and Materials</i> , 100 Barr Harbor Drive, West Conshohocken, PA 19428 (Noncurrent ASTM Standards are available from: Engineering Societies Library, 354 East 47th Street, New York, NY 10017): ASTM E 380–89 Standards for Metric Practice	171.10
<i>Association of American Railroads</i> , American Railroads Building, 50 F Street, NW., Washington, DC 20001: AAR Catalog Nos. SE60CHT; SE60CC; SE60CHTE; SE60CE; SE60DC; SE60DE	179.14
AAR Catalog Nos. SE67CC; SE67CE; SE67BHT; SE67BC; SE67BHTE; SE67BE	179.14
AAR Catalog Nos. SE68BHT; SE68BC; SE68BHTE; SE68BE	179.14
AAR Catalog Nos. SE69AHT; SE69AE	179.14
AAR Catalog Nos. SF70CHT; SF70CC; SF70CHTE; SF70CE	179.14
AAR Catalog Nos. SF73AC; SF73AE; SF73AHT; SF73AHTE	179.14
AAR Catalog Nos. SF79CHT; SF79CC; SF79CHTE; SF79CE	179.14
<i>Bureau of Explosives</i> , Hazardous Materials Systems (BOE), Association of American Railroads, American Railroads Building, 50 F Street NW., Washington, DC 20001: Fetterley’s Formula (The Determination of the Relief Dimensions for Safety Valves on Containers in which Liquefied gas is charged and when the exterior surface of the container is exposed to a temperature of 1,200 °F.).	173.315
Intermodal Loading Guide for Products in Closed Trailers and Containers, issued June 2001.	174.55; 174.101; 174.112; 174.115.
Pamphlet 6, Illustrating Methods for Loading and Bracing Carload and Less-Than-Carload Shipments of Explosives and Other Dangerous Articles, 1962.	174.55; 174.101; 174.112; 174.115; 174.290.
Pamphlet 6A (includes appendix No. 1, October 1944 and appendix 2, December 1945), Illustrating Methods for Loading and Bracing Carload and Less-Than-Carload Shipments of Loaded Projectiles, Loaded Bombs, etc., 1943.	174.101; 174.290
Pamphlet 6C, Illustrating Methods for Loading and Bracing Trailers and Less-Than-Trailer Shipments of Explosives and Other Dangerous Articles Via Trailer-on-Flatcar (TOFC) or Container-on-Flatcar (COFC), 1985.	174.55; 174.63; 174.101; 174.112; 174.115
Emergency Handling of Hazardous Materials in Surface Transportation, 1989	171.7
<i>Centers for Disease Control and Prevention</i> 1600 Clifton Road, Atlanta, GA 30333: Biosafety in Microbiological and Biomedical Laboratories, Fourth Edition, April 1999 ...	173.134
<i>Compressed Gas Association, Inc.</i> , 4221 Walney Road, 5th Floor, Chantilly, Virginia 20151: CGA C–1.1, Personnel Training and Certification Guidelines for Cylinder Requalification By the Volumetric Expansion Method, 2004, First Edition.	180.209

TABLE 1 TO 49 CFR 171.7—MATERIALS NOT INCORPORATED BY REFERENCE—Continued

Source and name of material	49 CFR reference
<i>National Institutes of Health</i> Bethesda, MD 20892: NIH Guidelines for Research Involving Recombinant DNA Molecules (NIH Guidelines), January 2001, Appendix B.	173.134
<i>Pantone Incorporated</i> 590 Commerce Boulevard, Carlstadt, New Jersey 07072–3098: Pantone ®Formula guide coated/uncoated, Second Edition 2004	172.407, 172.519
<i>Society of Plastics Industries, Inc.</i> , Organic Peroxide Producers Safety Division, 1275 K Street NW., Suite 400, Washington, DC 20005: Self Accelerating Decomposition Temperature Test, 1972	173.21
<i>The Sulphur Institute</i> , 1020 19th St. NW., Suite 520, Washington, DC 20036: Molten Sulphur Rail Tank Car Guidance document, November 2010	172.102
<i>Truck Trailer Manufacturers Association</i> , 1020 Princess Street, Alexandria, Virginia 22314, telephone (703) 549–3010, http://www.ttmanet.org : TTMA RP No. 96–01, TTMA RP No. 96–01, Structural Integrity of DOT 406, DOT 407, and DOT 412 Cylindrical Cargo Tanks, January 2001 Edition.	178.345–3

[78 FR 1027, Jan. 7, 2013, as amended at 78 FR 15321, Mar. 11, 2013; 78 FR 65468, Oct. 31, 2013; 79 FR 15043, Mar. 18, 2014; 79 FR 40609, July 11, 2014]

EDITORIAL NOTE: At 79 FR 40609, July 11, 2014, §171.7 was amended, in part, by redesignating paragraphs (j) through (o) as (i) through (m) respectively; redesignating paragraphs (q) through (dd) as (n) through (bb) respectively; and revising newly designated paragraphs (q)(1) and (u)(9); however, these amendments could not be incorporated due to inaccurate amendatory instructions.

§ 171.8 Definitions and abbreviations.

In this subchapter,

Administrator means the Administrator, Pipeline and Hazardous Materials Safety Administration.

Aerosol means any non-refillable receptacle containing a gas compressed, liquefied or dissolved under pressure, the sole purpose of which is to expel a nonpoisonous (other than a Division 6.1 Packing Group III material) liquid, paste, or powder and fitted with a self-closing release device allowing the contents to be ejected by the gas.

Agricultural product means a hazardous material, other than a hazardous waste, whose end use directly supports the production of an agricultural commodity including, but not limited to a fertilizer, pesticide, soil amendment or fuel. An *agricultural product* is limited to a material in Class 3, 8 or 9, Division 2.1, 2.2, 5.1, or 6.1, or an ORM-D material.

Aircraft battery means a battery designed in accordance with a recognized aircraft battery design standard (e.g. FAA technical standard order) that is capable of meeting all aircraft airworthiness requirements and operating regulations.

Approval means a written authorization, including a competent authority approval, from the Associate Adminis-

trator or other designated Department official, to perform a function for which prior authorization by the Associate Administrator is required under subchapter C of this chapter (49 CFR parts 171 through 180.)

Approved means approval issued or recognized by the Department unless otherwise specifically indicated in this subchapter.

Asphyxiant gas means a gas which dilutes or replaces oxygen normally in the atmosphere.

Associate Administrator means the Associate Administrator for Hazardous Materials Safety, Pipeline and Hazardous Materials Safety Administration.

Atmospheric gases means air, nitrogen, oxygen, argon, krypton, neon and xenon.

Authorized Inspection Agency means: (1) A jurisdiction which has adopted and administers one or more sections of the ASME Boiler and Pressure Vessel Code as a legal requirement and has a representative serving as a member of the ASME Conference Committee; or (2) an insurance company which has been licensed or registered by the appropriate authority of a State of the United States or a Province of Canada to underwrite boiler and pressure vessel insurance in such State or Province.

§ 171.8

49 CFR Ch. I (10–1–14 Edition)

Authorized Inspector means an Inspector who is currently commissioned by the National Board of Boiler and Pressure Vessel Inspectors and employed as an Inspector by an Authorized Inspection Agency.

Bag means a flexible packaging made of paper, plastic film, textiles, woven material or other similar materials.

Bar means 1 BAR = 100 kPa (14.5 psi).

Barge means a non-selfpropelled vessel.

Biological product. See § 173.134 of this subchapter.

Biological substances, Category B. See § 173.134 of this subchapter.

Bottle means an inner packaging having a neck of relatively smaller cross section than the body and an opening capable of holding a closure for retention of the contents.

Bottom shell means that portion of a tank car tank surface, excluding the head ends of the tank car tank, that lies within two feet, measured circumferentially, of the bottom longitudinal center line of the tank car tank.

Box means a packaging with complete rectangular or polygonal faces, made of metal, wood, plywood, reconstituted wood, fiberboard, plastic, or other suitable material. Holes appropriate to the size and use of the packaging, for purposes such as ease of handling or opening, or to meet classification requirements, are permitted as long as they do not compromise the integrity of the packaging during transportation, and are not otherwise prohibited in this subchapter.

Break-bulk means packages of hazardous materials that are handled individually, palletized, or unitized for purposes of transportation as opposed to bulk and containerized freight.

Btu means British thermal unit.

Bulk packaging means a packaging, other than a vessel or a barge, including a transport vehicle or freight container, in which hazardous materials are loaded with no intermediate form of containment. A Large Packaging in which hazardous materials are loaded with an intermediate form of containment, such as one or more articles or inner packagings, is also a bulk packaging. Additionally, a bulk packaging has:

(1) A maximum capacity greater than 450 L (119 gallons) as a receptacle for a liquid;

(2) A maximum net mass greater than 400 kg (882 pounds) and a maximum capacity greater than 450 L (119 gallons) as a receptacle for a solid; or

(3) A water capacity greater than 454 kg (1000 pounds) as a receptacle for a gas as defined in § 173.115 of this subchapter.

Bundle of cylinders means assemblies of UN cylinders fastened together and interconnected by a manifold and transported as a unit. The total water capacity for the bundle may not exceed 3,000 L, except that a bundle intended for the transport of gases in Division 2.3 is limited to a water capacity of 1,000 L.

Bureau of Explosives means the Bureau of Explosives (B of E) of the Association of American Railroads.

C means Celsius or Centigrade.

Captain of the Port (COTP) means the officer of the Coast Guard, under the command of a District Commander, so designated by the Commandant for the purpose of giving immediate direction to Coast Guard law enforcement activities within an assigned area. As used in this subchapter, the term *Captain of the Port* includes an authorized representative of the Captain of the Port.

Carfloat means a vessel that operates on a short run on an irregular basis and serves one or more points in a port area as an extension of a rail line or highway over water, and does not operate in ocean, coastwise, or ferry service.

Cargo aircraft only means an aircraft that is used to transport cargo and is not engaged in carrying passengers. For purposes of this subchapter, the terms *cargo aircraft only*, *cargo-only aircraft* and *cargo aircraft* have the same meaning.

Cargo tank means a bulk packaging that:

(1) Is a tank intended primarily for the carriage of liquids or gases and includes appurtenances, reinforcements, fittings, and closures (for the definition of a tank, see 49 CFR 178.320, 178.337–1, or 178.338–1, as applicable);

(2) Is permanently attached to or forms a part of a motor vehicle, or is not permanently attached to a motor

vehicle but which, by reason of its size, construction or attachment to a motor vehicle is loaded or unloaded without being removed from the motor vehicle; and

(3) Is not fabricated under a specification for cylinders, intermediate bulk containers, multi-unit tank car tanks, portable tanks, or tank cars.

Cargo tank motor vehicle means a motor vehicle with one or more cargo tanks permanently attached to or forming an integral part of the motor vehicle.

Cargo vessel means: (1) Any vessel other than a passenger vessel; and

(2) Any ferry being operated under authority of a change of character certificate issued by a Coast Guard Officer-in-Charge, Marine Inspection.

Carrier means a person who transports passengers or property in commerce by rail car, aircraft, motor vehicle, or vessel.

CC means closed-cup.

Character of vessel means the type of service in which the vessel is engaged at the time of carriage of a hazardous material.

Class means hazard class. See *hazard class*.

Class 1. See §173.50 of this subchapter.

Class 2. See §173.115 of this subchapter.

Class 3. See §173.120 of this subchapter.

Class 4. See §173.124 of this subchapter.

Class 5. See §173.128 of this subchapter.

Class 6. See §173.132 of this subchapter.

Class 7. See §173.403 of this subchapter.

Class 8. See §173.136 of this subchapter.

Class 9. See §173.140 of this subchapter.

Closure means a device which closes an opening in a receptacle.

COFC means container-on-flat-car.

Combination packaging means a combination of packaging, for transport purposes, consisting of one or more inner packagings secured in a non-bulk outer packaging. It does not include a composite packaging.

Combustible liquid. See §173.120 of this subchapter.

Commerce means trade or transportation in the jurisdiction of the United States within a single state; between a place in a state and a place outside of the state; that affects trade or transportation between a place in a state and place outside of the state; or on a United States-registered aircraft.

Compatibility group letter means a designated alphabetical letter used to categorize different types of explosive substances and articles for purposes of stowage and segregation. See §173.52 of this subchapter.

Competent Authority means a national agency responsible under its national law for the control or regulation of a particular aspect of the transportation of hazardous materials (dangerous goods). The term *Appropriate Authority*, as used in the ICAO Technical Instructions (IBR, see §171.7), has the same meaning as *Competent Authority*. For purposes of this subchapter, the Associate Administrator is the Competent Authority for the United States.

Composite packaging means a packaging consisting of an outer packaging and an inner receptacle, so constructed that the inner receptacle and the outer packaging form an integral packaging. Once assembled it remains thereafter an integrated single unit; it is filled, stored, shipped and emptied as such.

Compressed gas. See §173.115 of this subchapter.

Consignee means the person or place shown on a shipping document, package marking, or other media as the location to which a carrier is directed to transport a hazardous material.

Consumer commodity means a material that is packaged and distributed in a form intended or suitable for sale through retail sales agencies or instrumentalities for consumption by individuals for purposes of personal care or household use. This term also includes drugs and medicines.

Container ship means a cargo vessel designed and constructed to transport, within specifically designed cells, portable tanks and freight containers which are lifted on and off with their contents intact.

Corrosive material. See §173.136 of this subchapter.

Crate means an outer packaging with incomplete surfaces.

Crewmember means a person assigned to perform duty in an aircraft during flight time.

Cryogenic liquid. See §173.115(g) of this subchapter.

Cultures and stocks. See §173.134 of this subchapter.

Cylinder means a pressure vessel designed for pressures higher than 40 psia and having a circular cross section. It does not include a portable tank, multi-unit tank car tank, cargo tank, or tank car.

Dangerous when wet material. See §173.124 of this subchapter.

Design Certifying Engineer means a person registered with the Department in accordance with subpart F of part 107 of this chapter who has the knowledge and ability to perform stress analysis of pressure vessels and otherwise determine whether a cargo tank design and construction meets the applicable DOT specification. A *Design Certifying Engineer* meets the knowledge and ability requirements of this section by meeting any one of the following requirements:

(1) Has an engineering degree and one year of work experience in cargo tank structural or mechanical design;

(2) Is currently registered as a professional engineer by appropriate authority of a state of the United States or a province of Canada; or

(3) Has at least three years' experience in performing the duties of a Design Certifying Engineer prior to September 1, 1991.

Designated facility means a hazardous waste treatment, storage, or disposal facility that has been designated on the manifest by the generator.

District Commander means the District Commander of the Coast Guard, or his authorized representative, who has jurisdiction in the particular geographical area.

Division means a subdivision of a hazard class.

DOD means the U.S. Department of Defense.

Domestic transportation means transportation between places within the United States other than through a foreign country.

DOT or *Department* means U.S. Department of Transportation.

Drum means a flat-ended or convex-ended cylindrical packaging made of metal, fiberboard, plastic, plywood, or other suitable materials. This definition also includes packagings of other shapes made of metal or plastic (e.g., round taper-necked packagings or pail-shaped packagings) but does not include cylinders, jerricans, wooden barrels or bulk packagings.

Electronic data interchange (EDI) means the computer-to-computer exchange of business data in standard formats. In EDI, information is organized according to a specific format (electronic transmission protocol) agreed upon by the sender and receiver of this information, and transmitted through a computer transaction that requires no human intervention or re-typing at either end of the transmission.

Elevated temperature material means a material which, when offered for transportation or transported in a bulk packaging:

(1) Is in a liquid phase and at a temperature at or above 100 °C (212 °F);

(2) Is in a liquid phase with a flash point at or above 38 °C (100 °F) that is intentionally heated and offered for transportation or transported at or above its flash point; or

(3) Is in a solid phase and at a temperature at or above 240 °C (464 °F).

Engine means a locomotive propelled by any form of energy and used by a railroad.

EPA means U.S. Environmental Protection Agency.

Etiologic agent. See §173.134 of this subchapter.

EX number means a number preceded by the prefix "EX", assigned by the Associate Administrator, to an item that has been evaluated under the provisions of §173.56 of this subchapter.

Explosive. See §173.50 of this subchapter.

F means degree Fahrenheit.

Farmer means a person engaged in the production or raising of crops, poultry, or livestock.

FC number means a number preceded by the prefix "FC", assigned by a Fireworks Certification Agency to a Division 1.4G Consumer firework device that has been certified under the provisions of §173.65 of this subchapter.

Federal hazardous material transportation law means 49 U.S.C. 5101 *et seq.*

Ferry vessel means a vessel which is limited in its use to the carriage of deck passengers or vehicles or both, operates on a short run on a frequent schedule between two points over the most direct water route, other than in ocean or coastwise service, and is offered as a public service of a type normally attributed to a bridge or tunnel.

Filling density has the following meanings:

(1) For compressed gases in cylinders, see §173.304a(a)(2) table note 1.

(2) For compressed gases in tank cars, see §173.314(c) table note 1.

(3) For compressed gases in cargo tanks and portable tanks, see §173.315(a) table note 1.

(4) For cryogenic liquids in cylinders, except hydrogen, see §173.316(c)(1).

(5) For hydrogen, cryogenic liquid in cylinders, see §173.316(c)(3) table note 1.

(6) For cryogenic liquids in cargo tanks, see §173.318(f)(1).

(7) For cryogenic liquids in tank cars, see §173.319(d)(1).

Flammable gas. See §173.115 of this subchapter.

Flammable liquid. See §173.120 of this subchapter.

Flammable solid. See §173.124 of this subchapter.

Flexible bulk container means a flexible container with a capacity not exceeding 15 cubic meters and includes liners and attached handling devices and service equipment.

Flash point. See §173.120 of this subchapter.

Freight container means a reusable container having a volume of 64 cubic feet or more, designed and constructed to permit being lifted with its contents intact and intended primarily for containment of packages (in unit form) during transportation.

Fuel cell means an electrochemical device that converts the energy of the chemical reaction between a fuel, such as hydrogen or hydrogen rich gases, alcohols, or hydrocarbons, and an oxidant, such as air or oxygen, to direct current (d.c.) power, heat, and other reaction products.

Fuel cell cartridge or fuel cartridge means an article that stores fuel for discharge into the fuel cell through a

valve(s) that controls the discharge of fuel into the fuel cell.

Fuel cell system means a fuel cell with an installed fuel cell cartridge together with wiring, valves, and other attachments that connect the fuel cell or cartridge to the device it powers. The fuel cell or cartridge may be so constructed that it forms an integral part of the device or may be removed and connected manually to the device.

Fuel tank means a tank other than a cargo tank, used to transport flammable or combustible liquid, or compressed gas for the purpose of supplying fuel for propulsion of the transport vehicle to which it is attached, or for the operation of other equipment on the transport vehicle.

Fumigated lading. See §§172.302(g) and 173.9.

Gas means a material which has a vapor pressure greater than 300 kPa (43.5 psia) at 50 °C (122 °F) or is completely gaseous at 20 °C (68 °F) at a standard pressure of 101.3 kPa (14.7 psia).

Gross weight or Gross mass means the weight of a packaging plus the weight of its contents.

Hazard class means the category of hazard assigned to a hazardous material under the definitional criteria of part 173 of this subchapter and the provisions of the §172.101 table. A material may meet the defining criteria for more than one hazard class but is assigned to only one hazard class.

Hazard zone means one of four levels of hazard (Hazard Zones A through D) assigned to gases, as specified in §173.116(a) of this subchapter, and one of two levels of hazards (Hazard Zones A and B) assigned to liquids that are poisonous by inhalation, as specified in §173.133(a) of this subchapter. A hazard zone is based on the LC50 value for acute inhalation toxicity of gases and vapors, as specified in §173.133(a).

Hazardous material means a substance or material that the Secretary of Transportation has determined is capable of posing an unreasonable risk to health, safety, and property when transported in commerce, and has designated as hazardous under section 5103 of Federal hazardous materials transportation law (49 U.S.C. 5103). The term

§ 171.8

49 CFR Ch. I (10–1–14 Edition)

includes hazardous substances, hazardous wastes, marine pollutants, elevated temperature materials, materials designated as hazardous in the Hazardous Materials Table (see 49 CFR 172.101), and materials that meet the defining criteria for hazard classes and divisions in part 173 of this subchapter.

Hazardous substance for the purposes of this subchapter, means a material, including its mixtures and solutions, that—

- (1) Is listed in the appendix A to §172.101 of this subchapter;
- (2) Is in a quantity, in one package, which equals or exceeds the reportable quantity (RQ) listed in the appendix A to §172.101 of this subchapter; and
- (3) When in a mixture or solution—

- (i) For radionuclides, conforms to paragraph 7 of the appendix A to §172.101.

- (ii) For other than radionuclides, is in a concentration by weight which equals or exceeds the concentration corresponding to the RQ of the material, as shown in the following table:

RQ pounds (kilograms)	Concentration by weight	
	Percent	PPM
5000 (2270)	10	100,000
1000 (454)	2	20,000
100 (45.4)	0.2	2,000
10 (4.54)	0.02	200
1 (0.454)	0.002	20

The term does not include petroleum, including crude oil or any fraction thereof which is not otherwise specifically listed or designated as a hazardous substance in appendix A to §172.101 of this subchapter, and the term does not include natural gas, natural gas liquids, liquefied natural gas, or synthetic gas usable for fuel (or mixtures of natural gas and such synthetic gas).

Hazardous waste, for the purposes of this chapter, means any material that is subject to the Hazardous Waste Manifest Requirements of the U.S. Environmental Protection Agency specified in 40 CFR part 262.

Hazmat means a hazardous material.

Hazmat employee means: (1) A person who is:

- (i) Employed on a full-time, part time, or temporary basis by a hazmat employer and who in the course of such

full time, part time or temporary employment directly affects hazardous materials transportation safety;

- (ii) Self-employed (including an owner-operator of a motor vehicle, vessel, or aircraft) transporting hazardous materials in commerce who in the course of such self-employment directly affects hazardous materials transportation safety;

- (iii) A railroad signalman; or
- (iv) A railroad maintenance-of-way employee.

(2) This term includes an individual, employed on a full time, part time, or temporary basis by a hazmat employer, or who is self-employed, who during the course of employment:

- (i) Loads, unloads, or handles hazardous materials;
- (ii) Designs, manufactures, fabricates, inspects, marks, maintains, reconditions, repairs, or tests a package, container or packaging component that is represented, marked, certified, or sold as qualified for use in transporting hazardous material in commerce.

- (iii) Prepares hazardous materials for transportation;

- (iv) Is responsible for safety of transporting hazardous materials;

- (v) Operates a vehicle used to transport hazardous materials.

Hazmat employer means:

(1) A person who employs or uses at least one hazmat employee on a full-time, part time, or temporary basis; and who:

- (i) Transports hazardous materials in commerce;
- (ii) Causes hazardous materials to be transported in commerce; or

- (iii) Designs, manufactures, fabricates, inspects, marks, maintains, reconditions, repairs or tests a package, container, or packaging component that is represented, marked, certified, or sold by that person as qualified for use in transporting hazardous materials in commerce;

(2) A person who is self-employed (including an owner-operator of a motor vehicle, vessel, or aircraft) transporting materials in commerce; and who:

- (i) Transports hazardous materials in commerce;

(ii) Causes hazardous materials to be transported in commerce; or

(iii) Designs, manufactures, fabricates, inspects, marks, maintains, reconditions, repairs or tests a package, container, or packaging component that is represented, marked, certified, or sold by that person as qualified for use in transporting hazardous materials in commerce; or

(3) A department, agency, or instrumentality of the United States Government, or an authority of a State, political subdivision of a State, or an Indian tribe; and who:

(i) Transports hazardous materials in commerce;

(ii) Causes hazardous materials to be transported in commerce; or

(iii) Designs, manufactures, fabricates, inspects, marks, maintains, reconditions, repairs or tests a package, container, or packaging component that is represented, marked, certified, or sold by that person as qualified for use in transporting hazardous materials in commerce.

Hermetically sealed means closed by fusion, gasketing, crimping, or equivalent means so that no gas or vapor can enter or escape.

Household waste means any solid waste (including garbage, trash, and sanitary waste from septic tanks) derived from households (including single and multiple residences, hotels and motels, bunkhouses, ranger stations, crew quarters, campgrounds, picnic grounds, and day-use recreation areas). This term is not applicable to consolidated shipments of household hazardous materials transported from collection centers. A collection center is a central location where household waste is collected.

HMR means the Hazardous Materials Regulations, parts 171 through 180 of this chapter.

IAEA means International Atomic Energy Agency.

IATA means International Air Transport Association.

ICAO means International Civil Aviation Organization.

IMO means International Maritime Organization.

Incorporated by reference or *IBR* means a publication or a portion of a publication that is made a part of the

regulations of this subchapter. See §171.7.

Infectious substance (etiologic agent). See §173.134 of this subchapter.

Inner packaging means a packaging for which an outer packaging is required for transport. It does not include the inner receptacle of a composite packaging.

Inner receptacle means a receptacle which requires an outer packaging in order to perform its containment function. The inner receptacle may be an inner packaging of a combination packaging or the inner receptacle of a composite packaging.

Intermediate bulk container or *IBC* means a rigid or flexible portable packaging, other than a cylinder or portable tank, which is designed for mechanical handling. Standards for IBCs manufactured in the United States are set forth in subparts N and O of part 178 of this subchapter.

Intermediate packaging means a packaging which encloses an inner packaging or article and is itself enclosed in an outer packaging.

Intermodal container means a freight container designed and constructed to permit it to be used interchangeably in two or more modes of transport.

Intermodal portable tank or *IM portable tank* means a specific class of portable tanks designed primarily for international intermodal use.

International transportation means transportation—

(1) Between any place in the United States and any place in a foreign country;

(2) Between places in the United States through a foreign country; or

(3) Between places in one or more foreign countries through the United States.

Irritating material. See §173.132(a)(2) of this subchapter.

Jerrican means a metal or plastic packaging of rectangular or polygonal cross-section.

Large packaging means a packaging that—

(1) Consists of an outer packaging that contains articles or inner packagings;

(2) Is designated for mechanical handling;

§ 171.8

(3) Exceeds 400 kg net mass or 450 liters (118.9 gallons) capacity;

(4) Has a volume of not more than 3 cubic meters (m³) (see § 178.801(i) of this subchapter); and

(5) Conforms to the requirements for the construction, testing and marking of Large Packagings as specified in subparts P and Q of part 178 of this subchapter.

Limited quantity, when specified as such in a section applicable to a particular material, means the maximum amount of a hazardous material for which there is a specific labeling or packaging exception.

Lighter means a mechanically operated flame-producing device employing an ignition device and containing a Class 3 or a Division 2.1 material. For design, capacity, and filling density requirements for lighters containing a Division 2.1 material, see § 173.308.

Lighter refill means a pressurized container that does not contain an ignition device but does contain a release device and is intended for use as a replacement cartridge in a lighter or to refill a lighter with a Division 2.1 flammable gas fuel. For capacity limits, see § 173.306(h) of this subchapter.

Liquid means a material, other than an elevated temperature material, with a melting point or initial melting point of 20 °C (68 °F) or lower at a standard pressure of 101.3 kPa (14.7 psia). A viscous material for which a specific melting point cannot be determined must be subjected to the procedures specified in ASTM D 4359 "Standard Test Method for Determining Whether a Material is Liquid or Solid" (IBR, see § 171.7).

Liquid phase means a material that meets the definition of liquid when evaluated at the higher of the temperature at which it is offered for transportation or at which it is transported, not at the 38 °C (100 °F) temperature specified in ASTM D 4359 (IBR, see § 171.7).

Lithium ion cell or battery means a rechargeable electrochemical cell or battery in which the positive and negative electrodes are both lithium compounds constructed with no metallic lithium in either electrode. A lithium ion polymer cell or battery that uses lithium ion chemistries, as described herein, is

49 CFR Ch. I (10–1–14 Edition)

regulated as a lithium ion cell or battery.

Lithium metal cell or battery means an electrochemical cell or battery utilizing lithium metal or lithium alloys as the anode. The lithium content of a lithium metal or lithium alloy cell or battery is measured when the cell or battery is in an undischarged state. The lithium content of a lithium metal or lithium alloy battery is the sum of the grams of lithium content contained in the component cells of the battery.

Loading incidental to movement means loading by carrier personnel or in the presence of carrier personnel of packaged or containerized hazardous material onto a transport vehicle, aircraft, or vessel for the purpose of transporting it, including the loading, blocking and bracing a hazardous materials package in a freight container or transport vehicle, and segregating a hazardous materials package in a freight container or transport vehicle from incompatible cargo. For a bulk packaging, *loading incidental to movement* means filling the packaging with a hazardous material for the purpose of transporting it. *Loading incidental to movement* includes transloading.

Magazine vessel means a vessel used for the receiving, storing, or dispensing of explosives.

Magnetic material. See § 173.21(d) of this subchapter.

Marine pollutant, means a material which is listed in appendix B to § 172.101 of this subchapter (also see § 171.4) and, when in a solution or mixture of one or more marine pollutants, is packaged in a concentration which equals or exceeds:

(1) Ten percent by weight of the solution or mixture for materials listed in the appendix; or

(2) One percent by weight of the solution or mixture for materials that are identified as severe marine pollutants in the appendix.

Marking means a descriptive name, identification number, instructions, cautions, weight, specification, or UN marks, or combinations thereof, required by this subchapter on outer packagings of hazardous materials.

Material of trade means a hazardous material, other than a hazardous

waste, that is carried on a motor vehicle—

(1) For the purpose of protecting the health and safety of the motor vehicle operator or passengers;

(2) For the purpose of supporting the operation or maintenance of a motor vehicle (including its auxiliary equipment); or

(3) By a private motor carrier (including vehicles operated by a rail carrier) in direct support of a principal business that is other than transportation by motor vehicle.

Material poisonous by inhalation or *Material toxic by inhalation* means:

(1) A gas meeting the defining criteria in §173.115(c) of this subchapter and assigned to Hazard Zone A, B, C, or D in accordance with §173.116(a) of this subchapter;

(2) A liquid (other than as a mist) meeting the defining criteria in §173.132(a)(1)(iii) of this subchapter and assigned to Hazard Zone A or B in accordance with §173.133(a) of this subchapter; or

(3) Any material identified as an inhalation hazard by a special provision in column 7 of the §172.101 table.

Maximum allowable working pressure or *MAWP*: For DOT specification cargo tanks used to transport liquid hazardous materials, see §178.320(a) of this subchapter.

Maximum capacity means the maximum inner volume of receptacles or packagings.

Maximum net mass means the allowable maximum net mass of contents in a single packaging, or as used in subpart M of part 178 of this subchapter, the maximum combined mass of inner packaging, and the contents thereof.

Mechanical displacement meter prover means a mechanical device used in the oilfield service industry consisting of a pipe assembly that is used to calibrate the accuracy and performance of meters that measure the quantities of a product being pumped or transferred at facilities such as drilling locations, refineries, tank farms, and loading racks.

Metered delivery service means a cargo tank unloading operation conducted at a metered flow rate of 378.5 L (100 gallons) per minute or less through an attached delivery hose with a nominal in-

side diameter of 3.175 cm (1¼ inches) or less.

Metal hydride storage system means a single complete hydrogen storage system that includes a receptacle, metal hydride, pressure relief device, shut-off valve, service equipment and internal components used for the transportation of hydrogen only.

Miscellaneous hazardous material. See §173.140 of this subchapter.

Mixture means a material composed of more than one chemical compound or element.

Mode means any of the following transportation methods; rail, highway, air, or water.

Motor vehicle includes a vehicle, machine, tractor, trailer, or semitrailer, or any combination thereof, propelled or drawn by mechanical power and used upon the highways in the transportation of passengers or property. It does not include a vehicle, locomotive, or car operated exclusively on a rail or rails, or a trolley bus operated by electric power derived from a fixed overhead wire, furnishing local passenger transportation similar to street-railway service.

Movement means the physical transfer of a hazardous material from one geographic location to another by rail car, aircraft, motor vehicle, or vessel.

Multiple-element gas container or *MEGC* means assemblies of UN cylinders, tubes, or bundles of cylinders interconnected by a manifold and assembled within a framework. The term includes all service equipment and structural equipment necessary for the transport of gases.

Name of contents means the proper shipping name as specified in §172.101 of this subchapter.

Navigable waters means, for the purposes of this subchapter, waters of the United States, including the territorial seas.

Non-bulk packaging means a packaging which has:

(1) A maximum capacity of 450 L (119 gallons) or less as a receptacle for a liquid;

(2) A maximum net mass of 400 kg (882 pounds) or less and a maximum capacity of 450 L (119 gallons) or less as a receptacle for a solid; or

§ 171.8

49 CFR Ch. I (10–1–14 Edition)

(3) A water capacity of 454 kg (1000 pounds) or less as a receptacle for a gas as defined in §173.115 of this subchapter.

Nonflammable gas. See §173.115 of this subchapter.

N.O.S. means not otherwise specified.

N.O.S. description means a shipping description from the §172.101 table which includes the abbreviation *n.o.s.*

NPT means an American Standard taper pipe thread conforming to the requirements of NBS Handbook H-28 (IBR, see §171.7).

NRC (non-reusable container) means a packaging (container) whose reuse is restricted in accordance with the provisions of §173.28 of this subchapter.

Occupied caboose means a rail car being used to transport non-passenger personnel.

Officer in Charge, Marine Inspection means a person from the civilian or military branch of the Coast Guard designated as such by the Commandant and who under the supervision and direction of the Coast Guard District Commander is in charge of a designated inspection zone for the performance of duties with respect to the enforcement and administration of title 52, Revised Statutes, acts amendatory thereof or supplemental thereto, rules and regulations thereunder, and the inspection required thereby.

Offshore supply vessel means a cargo vessel of less than 500 gross tons that regularly transports goods, supplies or equipment in support of exploration or production of offshore mineral or energy resources.

Open cryogenic receptacle means a transportable thermally insulated receptacle for refrigerated liquefied gases maintained at atmospheric pressure by continuous venting of the refrigerated gas.

Operator means a person who controls the use of an aircraft, vessel, or vehicle.

Organic peroxide. See §173.128 of this subchapter.

ORM means other regulated material. See §173.144 of this subchapter.

Outage or *ullage* means the amount by which a packaging falls short of being liquid full, usually expressed in percent by volume.

Outer packaging means the outermost enclosure of a composite or combination packaging together with any absorbent materials, cushioning and any other components necessary to contain and protect inner receptacles or inner packagings.

Overpack, except as provided in subpart K of part 178 of this subchapter, means an enclosure that is used by a single consignor to provide protection or convenience in handling of a package or to consolidate two or more packages. *Overpack* does not include a transport vehicle, freight container, or aircraft unit load device. Examples of overpacks are one or more packages:

(1) Placed or stacked onto a load board such as a pallet and secured by strapping, shrink wrapping, stretch wrapping, or other suitable means; or

(2) Placed in a protective outer packaging such as a box or crate.

Oxidizer. See §173.127 of this subchapter.

Oxidizing gas means a gas which may, generally by providing oxygen, cause or contribute to the combustion of other material more than air does.

Oxidizing gas means a gas that may, generally by providing oxygen, cause or contribute to the combustion of other material more than air does. Specifically, this means a pure gas or gas mixture with an oxidizing power greater than 23.5% as determined by a method specified in ISO 10156: or 10156-2: (IBR, see §171.7 of this subchapter) (see also §173.115(k)).

Oxygen generator (chemical) means a device containing chemicals that upon activation release oxygen as a product of chemical reaction.

Package or *Outside Package* means a packaging plus its contents. For radioactive materials, see §173.403 of this subchapter.

Packaging means a receptacle and any other components or materials necessary for the receptacle to perform its containment function in conformance with the minimum packing requirements of this subchapter. For radioactive materials packaging, see §173.403 of this subchapter.

Packing group means a grouping according to the degree of danger presented by hazardous materials. Packing Group I indicates great danger;

Packing Group II, medium danger; Packing Group III, minor danger. See §172.101(f) of this subchapter.

Passenger (With respect to vessels and for the purposes of part 176 only) means a person being carried on a vessel other than:

- (1) The owner or his representative;
- (2) The operator;
- (3) A bona fide member of the crew engaged in the business of the vessel who has contributed no consideration for his carriage and who is paid for his services; or
- (4) A guest who has not contributed any consideration directly or indirectly for his carriage.

Passenger-carrying aircraft means an aircraft that carries any person other than a crewmember, company employee, an authorized representative of the United States, or a person accompanying the shipment.

Passenger vessel means—

- (1) A vessel subject to any of the requirements of the International Convention for the Safety of Life at Sea, 1974, which carries more than 12 passengers;
- (2) A cargo vessel documented under the laws of the United States and not subject to that Convention, which carries more than 16 passengers;
- (3) A cargo vessel of any foreign nation that extends reciprocal privileges and is not subject to that Convention and which carries more than 16 passengers; and
- (4) A vessel engaged in a ferry operation and which carries passengers.

Person means an individual, corporation, company, association, firm, partnership, society, joint stock company; or a government, Indian Tribe, or authority of a government or Tribe, that offers a hazardous material for transportation in commerce, transports a hazardous material to support a commercial enterprise, or designs, manufactures, fabricates, inspects, marks, maintains, reconditions, repairs, or tests a package, container, or packaging component that is represented, marked, certified, or sold as qualified for use in transporting hazardous material in commerce. This term does not include the United States Postal Service or, for purposes of 49 U.S.C. 5123 and

5124, a Department, agency, or instrumentality of the government.

Person who offers or offeror means:

(1) Any person who does either or both of the following:

(i) Performs, or is responsible for performing, any pre-transportation function required under this subchapter for transportation of the hazardous material in commerce.

(ii) Tenders or makes the hazardous material available to a carrier for transportation in commerce.

(2) A carrier is not an offeror when it performs a function required by this subchapter as a condition of acceptance of a hazardous material for transportation in commerce (*e.g.*, reviewing shipping papers, examining packages to ensure that they are in conformance with this subchapter, or preparing shipping documentation for its own use) or when it transfers a hazardous material to another carrier for continued transportation in commerce without performing a pre-transportation function.

PHMSA means the Pipeline and Hazardous Materials Safety Administration, U.S. Department of Transportation, Washington, DC 20590.

Placarded car means a rail car which is placarded in accordance with the requirements of part 172 of this subchapter.

Poisonous gas. See §173.115 of this subchapter.

Poisonous materials. See §173.132 of this subchapter.

Portable tank means a bulk packaging (except a cylinder having a water capacity of 1000 pounds or less) designed primarily to be loaded onto, or on, or temporarily attached to a transport vehicle or ship and equipped with skids, mountings, or accessories to facilitate handling of the tank by mechanical means. It does not include a cargo tank, tank car, multi-unit tank car tank, or trailer carrying 3AX, 3AAX, or 3T cylinders.

Preferred route or Preferred highway is a highway for shipment of *highway route controlled quantities* of radioactive materials so designated by a State routing agency, and any Interstate

System highway for which an alternative highway has not been designated by such State agency as provided by §397.103 of this title.

Pre-transportation function means a function specified in the HMR that is required to assure the safe transportation of a hazardous material in commerce, including—

- (1) Determining the hazard class of a hazardous material.
- (2) Selecting a hazardous materials packaging.
- (3) Filling a hazardous materials packaging, including a bulk packaging.
- (4) Securing a closure on a filled or partially filled hazardous materials package or container or on a package or container containing a residue of a hazardous material.
- (5) Marking a package to indicate that it contains a hazardous material.
- (6) Labeling a package to indicate that it contains a hazardous material.
- (7) Preparing a shipping paper.
- (8) Providing and maintaining emergency response information.
- (9) Reviewing a shipping paper to verify compliance with the HMR or international equivalents.
- (10) For each person importing a hazardous material into the United States, providing the shipper with timely and complete information as to the HMR requirements that will apply to the transportation of the material within the United States.
- (11) Certifying that a hazardous material is in proper condition for transportation in conformance with the requirements of the HMR.
- (12) Loading, blocking, and bracing a hazardous materials package in a freight container or transport vehicle.
- (13) Segregating a hazardous materials package in a freight container or transport vehicle from incompatible cargo.
- (14) Selecting, providing, or affixing placards for a freight container or transport vehicle to indicate that it contains a hazardous material.

Primary hazard means the hazard class of a material as assigned in the §172.101 table.

Private track or *Private siding* means: (i) Track located outside of a carrier's right-of-way, yard, or terminals where

the carrier does not own the rails, ties, roadbed, or right-of-way, or

(ii) Track leased by a railroad to a lessee, where the lease provides for, and actual practice entails, exclusive use of that trackage by the lessee and/or a general system railroad for purpose of moving only cars shipped to or by the lessee, and where the lessor otherwise exercises no control over or responsibility for the trackage or the cars on the trackage.

Proper shipping name means the name of the hazardous material shown in Roman print (not italics) in §172.101 of this subchapter.

Psi means pounds per square inch.

Psia means pounds per square inch absolute.

Psig means pounds per square inch gauge.

Public vessel means a vessel owned by and being used in the public service of the United States. It does not include a vessel owned by the United States and engaged in a trade or commercial service or a vessel under contract or charter to the United States.

Pyrophoric liquid. See §173.124(b) of this subchapter.

Radioactive materials. See §173.403 of this subchapter for definitions relating to radioactive materials.

Rail car means a car designed to carry freight or non-passenger personnel by rail, and includes a box car, flat car, gondola car, hopper car, tank car, and occupied caboose.

Railroad means a person engaged in transportation by rail.

Receptacle means a containment vessel for receiving and holding materials, including any means of closing.

U.N. Recommendations means the U.N. Recommendations on the Transport of Dangerous Goods, Model Regulations (IBR, see §171.7 of this subchapter).

Reconditioned packaging. See §173.28 of this subchapter.

Registered Inspector means a person registered with the Department in accordance with subpart F of part 107 of this chapter who has the knowledge and ability to determine whether a cargo tank conforms to the applicable DOT specification. A *Registered Inspector* meets the knowledge and ability requirements of this section by meeting any one of the following requirements:

(1) Has an engineering degree and one year of work experience relating to the testing and inspection of cargo tanks;

(2) Has an associate degree in engineering and two years of work experience relating to the testing and inspection of cargo tanks;

(3) Has a high school diploma (or General Equivalency Diploma) and three years of work experience relating to the testing and inspection of cargo tanks; or

(4) Has at least three years' experience performing the duties of a Registered Inspector prior to September 1, 1991.

Regulated medical waste. See §173.134 of this subchapter.

Remanufactured packagings. See §173.28 of this subchapter.

Reportable quantity (RQ) for the purposes of this subchapter means the quantity specified in column 2 of the appendix to §172.101 for any material identified in column 1 of the appendix.

Research means investigation or experimentation aimed at the discovery of new theories or laws and the discovery and interpretation of facts or revision of accepted theories or laws in the light of new facts. Research does not include the application of existing technology to industrial endeavors.

Residue means the hazardous material remaining in a packaging, including a tank car, after its contents have been unloaded to the maximum extent practicable and before the packaging is either refilled or cleaned of hazardous material and purged to remove any hazardous vapors.

Reused packaging. See §173.28 of this subchapter.

SADT means self-accelerated decomposition temperature. See §173.21(f) of this subchapter.

Salvage packaging means a special packaging conforming to §173.3 of this subchapter into which damaged, defective, leaking, or non-conforming hazardous materials packages, or hazardous materials that have spilled or leaked, are placed for purposes of transport for recovery or disposal.

SCF (standard cubic foot) means one cubic foot of gas measured at 60 °F. and 14.7 psia.

Secretary means the Secretary of Transportation.

Self-defense spray means an aerosol or non-pressurized device that:

(1) Is intended to have an irritating or incapacitating effect on a person or animal; and

(2) Meets no hazard criteria other than for Class 9 (for example, a pepper spray; see §173.140(a) of this subchapter) and, for an aerosol, Division 2.1 or 2.2 (see §173.115 of this subchapter), except that it may contain not more than two percent by mass of a tear gas substance (e.g., chloroacetophenone (CN) or 0-chlorobenzylmalonitrile (CS); see §173.132(a)(2) of this subchapter.)

Settled pressure means the pressure exerted by the contents of a UN pressure receptacle in thermal and diffusive equilibrium.

Sharps. See §173.134 of this subchapter.

Shipping paper means a shipping order, bill of lading, manifest or other shipping document serving a similar purpose and prepared in accordance with subpart C of part 172 of this chapter.

Short circuit means a direct connection between positive and negative terminals of a cell or battery that provides an abnormally low resistance path for current flow.

Siftproof packaging means a packaging impermeable to dry contents, including fine solid material produced during transportation.

Single packaging means a non-bulk packaging other than a combination packaging.

Solid means a material which is not a gas or a liquid.

Solution means any homogeneous liquid mixture of two or more chemical compounds or elements that will not undergo any segregation under conditions normal to transportation.

Special permit means a document issued by the Associate Administrator, or other designated Department official, under the authority of 49 U.S.C. 5117 permitting a person to perform a function that is not otherwise permitted under subchapter A or C of this chapter, or other regulations issued under 49 U.S.C. 5101 *et seq.* (e.g., Federal Motor Carrier Safety routing requirements).

Specification packaging means a packaging conforming to one of the specifications or standards for packagings in part 178 or part 179 of this subchapter.

Spontaneously combustible material. See § 173.124(b) of this subchapter.

Stabilized means that the hazardous material is in a condition that precludes uncontrolled reaction. This may be achieved by methods such as adding an inhibiting chemical, degassing the hazardous material to remove dissolved oxygen and inerting the air space in the package, or maintaining the hazardous material under temperature control.

State means a State of the United States, the District of Columbia, the Commonwealth of Puerto Rico, the Commonwealth of the Northern Mariana Islands, the Virgin Islands, American Samoa, Guam, or any other territory or possession of the United States designated by the Secretary.

State-designated route means a preferred route selected in accordance with U.S. DOT “Guidelines for Selecting Preferred Highway Routes for Highway Route Controlled Quantities of Radioactive Materials” or an equivalent routing analysis which adequately considers overall risk to the public.

Storage incidental to movement means storage of a transport vehicle, freight container, or package containing a hazardous material by any person between the time that a carrier takes physical possession of the hazardous material for the purpose of transporting it in commerce until the package containing the hazardous material is physically delivered to the destination indicated on a shipping document, package marking, or other medium, or, in the case of a private motor carrier, between the time that a motor vehicle driver takes physical possession of the hazardous material for the purpose of transporting it in commerce until the driver relinquishes possession of the package at its destination and is no longer responsible for performing functions subject to the HMR with respect to that particular package.

(1) *Storage incidental to movement* includes—

(i) Storage at the destination shown on a shipping document, including storage at a transloading facility, provided the shipping documentation identifies the shipment as a through-shipment and identifies the final destination or destinations of the hazardous material; and

(ii) Rail cars containing hazardous materials that are stored on track that does not meet the definition of “private track or siding” in § 171.8, even if those cars have been delivered to the destination shown on the shipping document.

(2) Storage incidental to movement does not include storage of a hazardous material at its final destination as shown on a shipping document.

Stowage means the act of placing hazardous materials on board a vessel.

Strong outer packaging means the outermost enclosure that provides protection against the unintentional release of its contents. It is a packaging that is sturdy, durable, and constructed so that it will retain its contents under normal conditions of transportation. In addition, a strong outer packaging must meet the general packaging requirements of subpart B of part 173 of this subchapter but need not comply with the specification packaging requirements in part 178 of the subchapter. For transport by aircraft, a strong outer packaging is subject to § 173.27 of this subchapter. The terms “strong outside container” and “strong outside packaging” are synonymous with “strong outer packaging.”

Subsidiary hazard means a hazard of a material other than the primary hazard. (See *primary hazard*).

Table in § 172.101 or *§ 172.101 table* means the Hazardous Materials Table in § 172.101 of this subchapter.

Technical name means a recognized chemical name or microbiological name currently used in scientific and technical handbooks, journals, and texts. Generic descriptions are authorized for use as technical names provided they readily identify the general chemical group, or microbiological group. Examples of acceptable generic chemical descriptions are organic phosphate compounds, petroleum aliphatic hydrocarbons and tertiary amines. For proficiency testing only, generic

microbiological descriptions such as bacteria, mycobacteria, fungus, and viral samples may be used. Except for names which appear in subpart B of part 172 of this subchapter, trade names may not be used as technical names.

TOFC means trailer-on-flat-car.

Top shell means the tank car tank surface, excluding the head ends and bottom shell of the tank car tank.

Toxin. See §173.134 of this subchapter.

Trailership means a vessel, other than a carfloat, specifically equipped to carry motor transport vehicles and fitted with installed securing devices to tie down each vehicle. The term *trailership* includes *Roll-on/Roll-off (RO/RO)* vessels.

Train means one or more engines coupled with one or more rail cars, except during switching operations or where the operation is that of classifying and assembling rail cars within a railroad yard for the purpose of making or breaking up trains.

Train consist means a written record of the contents and location of each rail car in a train.

Trainship means a vessel other than a rail car ferry or carfloat, specifically equipped to transport railroad vehicles, and fitted with installed securing devices to tie down each vehicle.

Transloading means the transfer of a hazardous material by any person from one bulk packaging to another bulk packaging, from a bulk packaging to a non-bulk packaging, or from a non-bulk packaging to a bulk packaging for the purpose of continuing the movement of the hazardous material in commerce.

Transport vehicle means a cargo-carrying vehicle such as an automobile, van, tractor, truck, semitrailer, tank car or rail car used for the transportation of cargo by any mode. Each cargo-carrying body (trailer, rail car, etc.) is a separate transport vehicle.

Transportation or *transport* means the movement of property and loading, unloading, or storage incidental to that movement.

UFC means Uniform Freight Classification.

UN means United Nations.

UN cylinder means a transportable pressure receptacle with a water capac-

ity not exceeding 150 L that has been marked and certified as conforming to the applicable requirements in part 178 of this subchapter.

UN portable tank means an intermodal tank having a capacity of more than 450 liters (118.9 gallons). It includes a shell fitted with service equipment and structural equipment, including stabilizing members external to the shell and skids, mountings or accessories to facilitate mechanical handling. A UN portable tank must be capable of being filled and discharged without the removal of its structural equipment and must be capable of being lifted when full. Cargo tanks, rail tank car tanks, non-metallic tanks, non-specification tanks, bulk bins, and IBCs and packagings made to cylinder specifications are not UN portable tanks.

UN pressure receptacle means a UN cylinder or tube.

UN Recommendations means the UN Recommendations on the Transport of Dangerous Goods (IBR, see §171.7).

UN standard packaging means a packaging conforming to standards in the UN Recommendations (IBR, see §171.7).

UN tube means a seamless transportable pressure receptacle with a water capacity exceeding 150 L but not more than 3,000 L that has been marked and certified as conforming to the requirements in part 178 of this subchapter.

Undeclared hazardous material means a hazardous material that is: (1) Subject to any of the hazard communication requirements in subparts C (Shipping Papers), D (Marking), E (Labeling), and F (Placarding) of part 172 of this subchapter, or an alternative marking requirement in part 173 of this subchapter (such as §§173.4(a)(10) and 173.6(c)); and (2) offered for transportation in commerce without any visible indication to the person accepting the hazardous material for transportation that a hazardous material is present, on either an accompanying shipping document, or the outside of a transport vehicle, freight container, or package.

Unintentional release means the escape of a hazardous material from a package on an occasion not anticipated or planned. This includes releases resulting from collision, package failures, human error, criminal activity,

§ 171.9

negligence, improper packing, or unusual conditions such as the operation of pressure relief devices as a result of over-pressurization, overfill or fire exposure. It does not include releases, such as venting of packages, where allowed, and the operational discharge of contents from packages.

Unit load device means any type of freight container, aircraft container, aircraft pallet with a net, or aircraft pallet with a net over an igloo.

United States means a State of the United States, the District of Columbia, the Commonwealth of Puerto Rico, the Commonwealth of the Northern Mariana Islands, the Virgin Islands, American Samoa, Guam, or any other territory or possession of the United States designated by the Secretary.

Unloading incidental to movement means removing a packaged or containerized hazardous material from a transport vehicle, aircraft, or vessel, or for a bulk packaging, emptying a hazardous material from the bulk packaging after the hazardous material has been delivered to the consignee when performed by carrier personnel or in the presence of carrier personnel or, in the case of a private motor carrier, while the driver of the motor vehicle from which the hazardous material is being unloaded immediately after movement is completed is present during the unloading operation. (Emptying a hazardous material from a bulk packaging while the packaging is on board a vessel is subject to separate regulations as delegated by Department of Homeland Security Delegation No. 0170.1 at 2(103).) *Unloading incidental to movement* includes transloading.

Vessel includes every description of watercraft, used or capable of being used as a means of transportation on the water.

Viscous liquid means a liquid material which has a measured viscosity in excess of 2500 centistokes at 25 °C. (77 °F.) when determined in accordance with the procedures specified in ASTM Method D 445-72 "Kinematic Viscosity of Transparent and Opaque Liquids (and the Calculation of Dynamic Viscosity)" or ASTM Method D 1200-70 "Viscosity of Paints, Varnishes, and Lacquers by Ford Viscosity Cup."

49 CFR Ch. I (10-1-14 Edition)

Volatility refers to the relative rate of evaporation of materials to assume the vapor state.

Water reactive material. See § 173.124(c) of this subchapter.

Water resistant means having a degree of resistance to permeability by and damage caused by water in liquid form.

Watt-hour (Wh) means a unit of energy equivalent to one watt (1 W) of work acting for one hour (1 h) of time. The Watt-hour rating of a lithium ion cell or battery is determined by multiplying the rated capacity of a cell or battery in ampere-hours, by its nominal voltage. Therefore, Watt-hour (Wh) = ampere-hour (Ah) × volts (V).

Wooden barrel means a packaging made of natural wood, of round cross-section, having convex walls, consisting of staves and heads and fitted with hoops.

Working pressure for purposes of UN pressure receptacles, means the settled pressure of a compressed gas at a reference temperature of 15 °C (59 °F).

W.T. means watertight.

[Amdt. 171-32, 41 FR 15994, Apr. 15, 1976]

EDITORIAL NOTE: For FEDERAL REGISTER citations affecting § 171.8, see the List of CFR Sections Affected, which appears in the Finding Aids section of the printed volume and at www.fdsys.gov.

§ 171.9 Rules of construction.

(a) In this subchapter, unless the context requires otherwise:

(1) Words imparting the singular include the plural;

(2) Words imparting the plural include the singular; and

(3) Words imparting the masculine gender include the feminine;

(b) In this subchapter, the word: (1) "Shall" is used in an imperative sense;

(2) "Must" is used in an imperative sense;

(3) "Should" is used in a recommendatory sense;

(4) "May" is used in a permissive sense to state authority or permission to do the act described, and the words "no person may * * *" or "a person may not * * *" means that no person is required, authorized, or permitted to do the act described; and

(5) "Includes" is used as a word of inclusion not limitation.

[Amdt. 171-32, 41 FR 15996, Apr. 15, 1976, as amended by Amdt. 171-32A, 41 FR 40630, Sept. 20, 1976; Amdt. 171-121, 58 FR 51528, Oct. 1, 1993; 75 FR 60338, Sept. 30, 2010]

§ 171.10 Units of measure.

(a) *General.* To ensure compatibility with international transportation standards, most units of measure in this subchapter are expressed using the International System of Units ("SI" or metric). Where SI units appear, they are the regulatory standard. U.S. standard or customary units, which appear in parentheses following the SI

units, are for information only and are not intended to be the regulatory standard.

(b) Abbreviations for SI units of measure generally used throughout this subchapter are as shown in paragraph (c) of this section. Customary units shown throughout this subchapter are generally not abbreviated.

(c) *Conversion values.* (1) Conversion values are provided in the following table and are based on values provided in ASTM E 380, "Standard for Metric Practice".

(2) If an exact conversion is needed, the following conversion table should be used.

TABLE OF CONVERSION FACTORS FOR SI UNITS

Measurement	SI to U.S. standard	U.S. standard to SI
Activity	1 TBq=27 Ci	1 Ci=0.037 TBq
Length	1 cm=0.3937008 in	1 in=2.540000 cm
	1 m=3.280840 ft	1 ft=0.3048000 m
Thickness	1 mm=0.03937008 in	1 in=25.40000 mm
Mass (weight)	1 kg=2.204622 lb	1 lb=0.4535924 kg
	1 g=0.03527397 oz	1 oz=28.34952 g
Pressure	1 kPa=0.1450377 psi	1 psi=6.894757 kPa
	1 Bar=100 kPa=14.504 psi	1 psi=0.06895 Bar
	1 kPa=7.5 mm Hg	
Radiation level	1 Sv/hr=100 rem/hr	1 rem/hr=0.01 Sv/hr
Volume (liquid)	1 L=0.2641720 gal	1 gal=3.785412 L
	1 mL=0.03381402 oz	1 oz=29.57353 mL
	1 m ³ =35.31466 ft ³	1 ft ³ =0.02831685 m ³
Density	1 kg/m ³ =0.06242797 lb/ft ³	1 lb/ft ³ =16.01846 kg/m ³
Force	1 Newton = 0.2248 Pound-force	1 Pound-force=4.483 N

Abbreviation for units of measure are as follows:
 Unit of measure and abbreviation:
 (SI): millimeter, mm; centimeter, cm; meter, m; gram, g; kilogram, kg; kiloPascal, kPa; liter, L; milliliter, mL; cubic meter, m³; Terabecquerel, TBq; Gigabecquerel, GBq; millisievert, mSv; Newton, N;
 (U.S.): Inch, in; foot, ft; ounce, oz; pound, lb; psig, psi; gallon, gal; cubic feet, ft³; Curie, Ci; millicurie, mCi; millirem, mrem.

[Amdt. 171-111, 56 FR 66159, Dec. 20, 1991, as amended by Amdt. 171-136, 60 FR 49108, Sept. 21, 1995; Amdt. 171-135, 60 FR 50302, Sept. 28, 1995; 66 FR 33335, June 21, 2001; 66 FR 45378, Aug. 28, 2001; 68 FR 75740, Dec. 31, 2003]

§ 171.11 [Reserved]

§ 171.12 North American Shipments.

(a) *Requirements for the use of the Transport Canada TDG Regulations.* (1) A hazardous material transported from Canada to the United States, from the United States to Canada, or transiting the United States to Canada or a foreign destination may be offered for transportation or transported by motor carrier and rail in accordance with the Transport Canada TDG Regulations (IBR, see §171.7) as authorized in §171.22, provided the requirements in §§171.22 and 171.23, as applicable, and

this section are met. In addition, a cargo tank motor vehicle, portable tank or rail tank car authorized by the Transport Canada TDG Regulations may be used for transportation to, from, or within the United States provided the cargo tank motor vehicle, portable tank or rail tank car conforms to the applicable requirements of this section. Except as otherwise provided in this subpart and subpart C of this part, the requirements in parts 172, 173, and 178 of this subchapter do not apply for a material transported in accordance with the Transport Canada TDG Regulations.

(2) *General packaging requirements.* When the provisions of this subchapter require a DOT specification or UN standard packaging to be used for transporting a hazardous material, a packaging authorized by the Transport Canada TDG Regulations may be used, subject to the limitations of this part, and only if it is equivalent to the corresponding DOT specification or UN packaging (see §173.24(d)(2) of this subchapter) authorized by this subchapter.

(3) *Bulk packagings.* A portable tank, cargo tank motor vehicle or rail tank car equivalent to a corresponding DOT specification and conforming to and authorized by the Transport Canada TDG Regulations may be used provided—

(i) An equivalent type of packaging is authorized for the hazardous material according to the §172.101 table of this subchapter;

(ii) The portable tank, cargo tank motor vehicle or rail tank car conforms to the requirements of the applicable part 173 bulk packaging section specified in the §172.101 table for the material to be transported;

(iii) The portable tank, cargo tank motor vehicle or rail tank car conforms to the requirements of all assigned bulk packaging special provisions (B codes, and T and TP codes) in §172.102 of this subchapter; and

(iv) The bulk packaging conforms to all applicable requirements of §§173.31, 173.32, 173.33 and 173.35 of this subchapter, and parts 177 and 180 of this subchapter. The periodic retests and inspections required by §§173.31, 173.32 and 173.33 of this subchapter may be performed in accordance with part 180 of this subchapter or in accordance with the requirements of the TDG Regulations provided that the intervals prescribed in part 180 of this subchapter are met.

(v) Rail tank cars must conform to the requirements of Canadian General Standards Board standard 43.147 (IBR, see §171.7).

(4) *Cylinders.* When the provisions of this subchapter require that a DOT specification or a UN pressure receptacle must be used for a hazardous material, a packaging authorized by the Transport Canada TDG Regulations may be used only if it corresponds to

the DOT specification or UN standard authorized by this subchapter. Unless otherwise excepted in this subchapter, a cylinder (including a UN pressure receptacle) may not be transported unless—

(i) The packaging is a UN pressure receptacle marked with the letters “CAN” for Canada as a country of manufacture or a country of approval or is a cylinder that was manufactured, inspected and tested in accordance with a DOT specification or a UN standard prescribed in part 178 of this subchapter, except that cylinders not conforming to these requirements must meet the requirements in §171.23. Each cylinder must conform to the applicable requirements in part 173 of this subchapter for the hazardous material involved.

(ii) The packaging is a Canadian Transport Commission (CTC) specification cylinder manufactured, originally marked and approved in accordance with the CTC regulations and in full conformance with the Transport Canada TDG Regulations.

(A) The CTC specification corresponds with a DOT specification and the cylinder markings are the same as those specified in this subchapter except that they were originally marked with the letters “CTC” in place of “DOT”;

(B) The cylinder has been requalified under a program authorized by the Transport Canada TDG Regulations or requalified in accordance with the requirements in §180.205 within the prescribed requalification period provided for the corresponding DOT specification;

(C) When the regulations authorize a cylinder for a specific hazardous material with a specification marking prefix of “DOT”, a cylinder marked “CTC” which otherwise bears the same markings that would be required of the specified “DOT” cylinder may be used; and

(D) Transport of the cylinder and the material it contains is in all other respects in conformance with the requirements of this subchapter (e.g. valve protection, filling requirements, operational requirements, etc.).

(5) *Class 1 (explosive) materials.* When transporting Class 1 (explosive) material, rail and motor carriers must comply with 49 CFR 1572.9 and 1572.11 to the extent the requirements apply.

(6) *Lithium metal cells and batteries.* Lithium metal cells and batteries (UN3090) are forbidden for transport aboard passenger-carrying aircraft. The outside of each package that contains lithium cells or batteries meeting the conditions for exception in § 173.185(c) of this subchapter and transported in accordance with the Transport Canada TDG Regulations must be marked in accordance with § 173.185(c)(1)(iii) or (c)(1)(iv) as appropriate.

(b) *Shipments to or from Mexico.* Unless otherwise excepted, hazardous materials shipments from Mexico to the United States or from the United States to Mexico must conform to all applicable requirements of this subchapter. When a hazardous material that is a material poisonous by inhalation (see § 171.8) is transported by highway or rail from Mexico to the United States, or from the United States to Mexico, the following requirements apply:

(1) The shipping description must include the words “Toxic Inhalation Hazard” or “Poison-Inhalation Hazard” or “Inhalation Hazard”, as required in § 172.203(m) of this subchapter.

(2) The material must be packaged in accordance with requirements of this subchapter.

(3) The package must be marked in accordance with § 172.313 of this subchapter.

(4) Except as provided in paragraph (e)(5) of this section, the package must be labeled or placarded POISON GAS or POISON INHALATION HAZARD, as appropriate, in accordance with subparts E and F of this subchapter.

(5) A label or placard that conforms to the UN Recommendations (IBR, see § 171.7) specifications for a “Division 2.3” or “Division 6.1” label or placard may be substituted for the POISON GAS or POISON INHALATION HAZARD label or placard required by §§ 172.400(a) and 172.504(e) of this subchapter on a package transported in a closed transport vehicle or freight container. The transport vehicle or freight

container must be marked with identification numbers for the material, regardless of the total quantity contained in the transport vehicle or freight container, in the manner specified in § 172.313(c) of this subchapter and placarded as required by subpart F of this subchapter.

[Amdt. 171-111, 55 FR 52472, Dec. 21, 1990]

EDITORIAL NOTE: For FEDERAL REGISTER citations affecting § 171.12, see the List of CFR Sections Affected, which appears in the Finding Aids section of the printed volume and at www.fdsys.gov.

§ 171.12a [Reserved]

§ 171.14 [Reserved]

Subpart B—Incident Reporting, Notification, BOE Approvals and Authorization

§ 171.15 Immediate notice of certain hazardous materials incidents.

(a) *General.* As soon as practical but no later than 12 hours after the occurrence of any incident described in paragraph (b) of this section, each person in physical possession of the hazardous material must provide notice by telephone to the National Response Center (NRC) on 800-424-8802 (toll free) or 202-267-2675 (toll call) or online at <http://www.nrc.uscg.mil>. Each notice must include the following information:

- (1) Name of reporter;
- (2) Name and address of person represented by reporter;
- (3) Phone number where reporter can be contacted;
- (4) Date, time, and location of incident;
- (5) The extent of injury, if any;
- (6) Class or division, proper shipping name, and quantity of hazardous materials involved, if such information is available; and
- (7) Type of incident and nature of hazardous material involvement and whether a continuing danger to life exists at the scene.

(b) *Reportable incident.* A telephone report is required whenever any of the following occurs during the course of transportation in commerce (including loading, unloading, and temporary storage):

§ 171.16

(1) As a direct result of a hazardous material—

- (i) A person is killed;
 - (ii) A person receives an injury requiring admittance to a hospital;
 - (iii) The general public is evacuated for one hour or more;
 - (iv) A major transportation artery or facility is closed or shut down for one hour or more; or
 - (v) The operational flight pattern or routine of an aircraft is altered;
- (2) Fire, breakage, spillage, or suspected radioactive contamination occurs involving a radioactive material (see also §176.48 of this subchapter);
- (3) Fire, breakage, spillage, or suspected contamination occurs involving an infectious substance other than a regulated medical waste;
- (4) A release of a marine pollutant occurs in a quantity exceeding 450 L (119 gallons) for a liquid or 400 kg (882 pounds) for a solid;
- (5) A situation exists of such a nature (*e.g.*, a continuing danger to life exists at the scene of the incident) that, in the judgment of the person in possession of the hazardous material, it should be reported to the NRC even though it does not meet the criteria of paragraphs (b)(1), (2), (3) or (4) of this section; or
- (6) During transportation by aircraft, a fire, violent rupture, explosion or dangerous evolution of heat (*i.e.*, an amount of heat sufficient to be dangerous to packaging or personal safety to include charring of packaging, melting of packaging, scorching of packaging, or other evidence) occurs as a direct result of a battery or battery-powered device.

(c) *Written report.* Each person making a report under this section must also make the report required by §171.16 of this subpart.

NOTE TO §171.15: Under 40 CFR 302.6, EPA requires persons in charge of facilities (including transport vehicles, vessels, and aircraft) to report any release of a hazardous substance in a quantity equal to or greater than its reportable quantity, as soon as that person has knowledge of the release, to DOT's National Response Center at (toll free) 800-424-8802 or (toll) 202-267-2675.

[68 FR 67759, Dec. 3, 2003, as amended at 72 FR 55684, Oct. 1, 2007; 74 FR 2233, Jan. 14, 2009; 74 FR 53186, Oct. 16, 2009; 76 FR 43525, July 20, 2011]

49 CFR Ch. I (10–1–14 Edition)

§ 171.16 Detailed hazardous materials incident reports.

(a) *General.* Each person in physical possession of a hazardous material at the time that any of the following incidents occurs during transportation (including loading, unloading, and temporary storage) must submit a Hazardous Materials Incident Report on DOT Form F 5800.1 (01/2004) within 30 days of discovery of the incident:

- (1) Any of the circumstances set forth in §171.15(b);
- (2) An unintentional release of a hazardous material or the discharge of any quantity of hazardous waste;
- (3) A specification cargo tank with a capacity of 1,000 gallons or greater containing any hazardous material suffers structural damage to the lading retention system or damage that requires repair to a system intended to protect the lading retention system, even if there is no release of hazardous material;
- (4) An undeclared hazardous material is discovered; or
- (5) A fire, violent rupture, explosion or dangerous evolution of heat (*i.e.*, an amount of heat sufficient to be dangerous to packaging or personal safety to include charring of packaging, melting of packaging, scorching of packaging, or other evidence) occurs as a direct result of a battery or battery-powered device.

(b) *Providing and retaining copies of the report.* Each person reporting under this section must—

(1) Submit a written Hazardous Materials Incident Report to the Information Systems Manager, PHH-60, Pipeline and Hazardous Materials Safety Administration, Department of Transportation, East Building, 1200 New Jersey Ave., SE., Washington, DC 20590-0001, or an electronic Hazardous Material Incident Report to the Information System Manager, PHH-60, Pipeline and Hazardous Materials Safety Administration, Department of Transportation, Washington, DC 20590-0001 at <http://hazmat.dot.gov>;

(2) For an incident involving transportation by aircraft, submit a written or electronic copy of the Hazardous Materials Incident Report to the FAA Security Field Office nearest the location of the incident; and

(3) Retain a written or electronic copy of the Hazardous Materials Incident Report for a period of two years at the reporting person's principal place of business. If the written or electronic Hazardous Materials Incident Report is maintained at other than the reporting person's principal place of business, the report must be made available at the reporting person's principal place of business within 24 hours of a request for the report by an authorized representative or special agent of the Department of Transportation.

(c) *Updating the incident report.* A Hazardous Materials Incident Report must be updated within one year of the date of occurrence of the incident whenever:

(1) A death results from injury caused by a hazardous material;

(2) There was a misidentification of the hazardous material or package information on a prior incident report;

(3) Damage, loss or related cost that was not known when the initial incident report was filed becomes known; or

(4) Damage, loss, or related cost changes by \$25,000 or more, or 10% of the prior total estimate, whichever is greater.

(d) *Exceptions.* Unless a telephone report is required under the provisions of § 171.15 of this part, the requirements of paragraphs (a), (b), and (c) of this section do not apply to the following incidents:

(1) A release of a minimal amount of material from—

(i) A vent, for materials for which venting is authorized;

(ii) The routine operation of a seal, pump, compressor, or valve; or

(iii) Connection or disconnection of loading or unloading lines, provided that the release does not result in property damage.

(2) An unintentional release of a hazardous material when:

(i) The material is—

(A) A limited quantity material packaged under authorized exceptions in the § 172.101 Hazardous Materials Table of this subchapter excluding Class 7 (radioactive) material; or

(B) A Packing Group III material in Class or Division 3, 4, 5, 6.1, 8, or 9;

(ii) The material is released from a package having a capacity of less than 20 liters (5.2 gallons) for liquids or less than 30 kg (66 pounds) for solids;

(iii) The total amount of material released is less than 20 liters (5.2 gallons) for liquids or less than 30 kg (66 pounds) for solids; and

(iv) The material is not—

(A) Offered for transportation or transported by aircraft;

(B) A hazardous waste; or

(C) An undeclared hazardous material;

(3) An undeclared hazardous material discovered in an air passenger's checked or carry-on baggage during the airport screening process. (For discrepancy reporting by carriers, see § 175.31 of this subchapter.)

[68 FR 67759, Dec. 3, 2003; 69 FR 30119, May 26, 2004, as amended at 70 FR 56091, Sept. 23, 2005; 74 FR 2233, Jan. 14, 2009; 76 FR 56311, Sept. 13, 2011; 78 FR 1112, Jan. 7, 2013]

§§ 171.17–171.18 [Reserved]

§ 171.19 Approvals or authorizations issued by the Bureau of Explosives.

Effective December 31, 1998, approvals or authorizations issued by the Bureau of Explosives (BOE), other than those issued under part 179 of this subchapter, are no longer valid.

[63 FR 37459, July 10, 1998]

§ 171.20 Submission of Examination Reports.

(a) When it is required in this subchapter that the issuance of an approval by the Associate Administrator be based on an examination by the Bureau of Explosives (or any other test facility recognized by PHMSA), it is the responsibility of the applicant to submit the results of the examination to the Associate Administrator.

(b) Applications for approval submitted under paragraph (a) of this section, must be submitted to the Associate Administrator for Hazardous Materials Safety, Pipeline and Hazardous Materials Safety Administration, Washington, DC 20590-0001.

§ 171.21

49 CFR Ch. I (10–1–14 Edition)

(c) Any applicant for an approval aggrieved by an action taken by the Associate Administrator, under this subpart may file an appeal with the Administrator, PHMSA within 30 days of service of notification of a denial.

[Amdt. 171–54, 45 FR 32692, May 19, 1980, as amended by Amdt. 171–66, 47 FR 43064, Sept. 30, 1982; Amdt. 171–109, 55 FR 39978, Oct. 1, 1990; Amdt. 171–111, 56 FR 66162, Dec. 20, 1991; 66 FR 45378, Aug. 28, 2001]

§ 171.21 Assistance in investigations and special studies.

(a) A shipper, carrier, package owner, package manufacturer or certifier, repair facility, or person reporting an incident under the provisions of § 171.16 must:

(1) Make all records and information pertaining to the incident available to an authorized representative or special agent of the Department of Transportation upon request; and

(2) Give an authorized representative or special agent of the Department of Transportation reasonable assistance in the investigation of the incident.

(b) If an authorized representative or special agent of the Department of Transportation makes an inquiry of a person required to complete an incident report in connection with a study of incidents, the person shall:

(1) Respond to the inquiry within 30 days after its receipt or within such other time as the inquiry may specify; and

(2) Provide true and complete answers to any questions included in the inquiry.

[68 FR 67760, Dec. 3, 2003]

Subpart C—Authorization and Requirements for the Use of International Transport Standards and Regulations

SOURCE: 72 FR 25172, May 3, 2007, unless otherwise noted.

§ 171.22 Authorization and conditions for the use of international standards and regulations.

(a) *Authorized international standards and regulations.* This subpart authorizes, with certain conditions and limitations, the offering for transportation

and the transportation in commerce of hazardous materials in accordance with the International Civil Aviation Organization's Technical Instructions for the Safe Transport of Dangerous Goods by Air (ICAO Technical Instructions), the International Maritime Dangerous Goods Code (IMDG Code), Transport Canada's Transportation of Dangerous Goods Regulations (Transport Canada TDG Regulations), and the International Atomic Energy Agency Regulations for the Safe Transport of Radioactive Material (IAEA Regulations) (IBR, see § 171.7).

(b) *Limitations on the use of international standards and regulations.* A hazardous material that is offered for transportation or transported in accordance with the international standards and regulations authorized in paragraph (a) of this section—

(1) Is subject to the requirements of the applicable international standard or regulation and must be offered for transportation or transported in conformance with the applicable standard or regulation; and

(2) Must conform to all applicable requirements of this subpart.

(c) *Materials excepted from regulation under international standards and regulations.* A material designated as a hazardous material under this subchapter, but excepted from or not subject to the international transport standards and regulations authorized in paragraph (a) of this section (e.g., paragraph 1.16 of the Transport Canada TDG Regulations) excepts from regulation quantities of hazardous materials less than or equal to 500 kg gross transported by rail) must be transported in accordance with all applicable requirements of this subchapter.

(d) *Materials not regulated under this subchapter.* Materials not designated as hazardous materials under this subchapter but regulated by an international transport standard or regulation authorized in paragraph (a) of this section may be offered for transportation and transported in the United States in full compliance (i.e., packaged, marked, labeled, classed, described, stowed, segregated, secured) with the applicable international transport standard or regulation.

(e) *Forbidden materials.* No person may offer for transportation or transport a hazardous material that is a forbidden material or package as designated in—

(1) Section 173.21 of this subchapter;

(2) Column (3) of the §172.101 Table of this subchapter;

(3) Column (9A) of the §172.101 Table of this subchapter when offered for transportation or transported on passenger aircraft or passenger railcar; or

(4) Column (9B) of the §172.101 Table of this subchapter when offered for transportation or transported by cargo aircraft.

(f) *Complete information and certification.* (1) Except for shipments into the United States from Canada conforming to §171.12, each person importing a hazardous material into the United States must provide the forwarding agent at the place of entry into the United States timely and complete written information as to the requirements of this subchapter applicable to the particular shipment.

(2) The shipper, directly or through the forwarding agent at the place of entry, must provide the initial U.S. carrier with the shipper's certification required by §172.204 of this subchapter, unless the shipment is otherwise exempted from the certification requirement. Except for shipments for which the certification requirement does not apply, a carrier may not accept a hazardous material for transportation unless provided a shipper's certification.

(3) All shipping paper information and package markings required in accordance with this subchapter must be in English. The use of shipping papers and a package marked with both English and a language other than English, in order to dually comply with this subchapter and the regulations of a foreign entity, is permitted under this subchapter.

(4) Each person who provides for transportation or receives for transportation (see §§174.24, 175.30, 176.24 and 177.817 of this subchapter) a shipping paper must retain a copy of the shipping paper or an electronic image thereof that is accessible at or through its principal place of business in accordance with §172.201(e) of this part.

(g) *Additional requirements for the use of international standards and regulations.* All shipments offered for transportation or transported in the United States in accordance with this subpart must conform to the following requirements of this subchapter, as applicable:

(1) The emergency response information requirements in subpart G of part 172 of this subchapter;

(2) The training requirements in subpart H of part 172 of this subchapter, including function-specific training in the use of the international transport standards and regulations authorized in paragraph (a) of this section, as applicable;

(3) The security requirements in subpart I of part 172 of this subchapter;

(4) The incident reporting requirements in §§171.15 and 171.16 of this part for incidents occurring within the jurisdiction of the United States including on board vessels in the navigable waters of the United States and aboard aircraft of United States registry anywhere in air commerce;

(5) For export shipments, the general packaging requirements in §§173.24 and 173.24a of this subchapter;

(6) For export shipments, the requirements for the reuse, reconditioning, and remanufacture of packagings in §173.28 of this subchapter; and

(7) The registration requirements in subpart G of part 107 of this chapter.

[72 FR 25172, May 3, 2007, as amended at 72 FR 55091 Sept. 28, 2007; 74 FR 53186, Oct. 16, 2009; 76 FR 56311, Sept. 13, 2011]

§ 171.23 Requirements for specific materials and packagings transported under the ICAO Technical Instructions, IMDG Code, Transport Canada TDG Regulations, or the IAEA Regulations.

All shipments offered for transportation or transported in the United States under the ICAO Technical Instructions, IMDG Code, Transport Canada TDG Regulations, or the IAEA Regulations (IBR, see §171.7) must conform to the requirements of this section, as applicable.

(a) *Conditions and requirements for cylinders*—(1) Except as provided in this paragraph, a filled cylinder (pressure receptacle) manufactured to other than a DOT specification or a UN standard

§ 171.23

49 CFR Ch. I (10–1–14 Edition)

in accordance with part 178 of this subchapter, or a DOT exemption or special permit cylinder or a cylinder used as a fire extinguisher in conformance with §173.309(a) of this subchapter, may not be transported to, from, or within the United States.

(2) Cylinders (including UN pressure receptacles) transported to, from, or within the United States must conform to the applicable requirements of this subchapter. Unless otherwise excepted in this subchapter, a cylinder must not be transported unless—

(i) The cylinder is manufactured, inspected and tested in accordance with a DOT specification or a UN standard prescribed in part 178 of this subchapter, except that cylinders not conforming to these requirements must meet the requirements in paragraphs (a)(3), (a)(4) or (a)(5) of this section;

(ii) The cylinder is equipped with a pressure relief device in accordance with §173.301(f) of this subchapter and conforms to the applicable requirements in part 173 of this subchapter for the hazardous material involved;

(iii) The openings on an aluminum cylinder in oxygen service conform to the requirements of this paragraph, except when the cylinder is used for aircraft parts or used aboard an aircraft in accordance with the applicable airworthiness requirements and operating regulations. An aluminum DOT specification cylinder must have an opening configured with straight (parallel) threads. A UN pressure receptacle may have straight (parallel) or tapered threads provided the UN pressure receptacle is marked with the thread type, e.g. “17E, 25E, 18P, or 25P” and fitted with the properly marked valve; and

(iv) A UN pressure receptacle is marked with “USA” as a country of approval in conformance with §§178.69 and 178.70 of this subchapter.

(3) Importation of cylinders for discharge within a single port area: A cylinder manufactured to other than a DOT specification or UN standard in accordance with part 178 of this subchapter and certified as being in conformance with the transportation regulations of another country may be authorized, upon written request to and approval by the Associate Adminis-

trator, for transportation within a single port area, provided—

(i) The cylinder is transported in a closed freight container;

(ii) The cylinder is certified by the importer to provide a level of safety at least equivalent to that required by the regulations in this subchapter for a comparable DOT specification or UN cylinder; and

(iii) The cylinder is not refilled for export unless in compliance with paragraph (a)(4) of this section.

(4) Filling of cylinders for export or for use on board a vessel: A cylinder not manufactured, inspected, tested and marked in accordance with part 178 of this subchapter, or a cylinder manufactured to other than a UN standard, DOT specification, exemption or special permit, may be filled with a gas in the United States and offered for transportation and transported for export or alternatively, for use on board a vessel, if the following conditions are met:

(i) The cylinder has been requalified and marked with the month and year of requalification in accordance with subpart C of part 180 of this subchapter, or has been requalified as authorized by the Associate Administrator;

(ii) In addition to other requirements of this subchapter, the maximum filling density, service pressure, and pressure relief drive for each cylinder conform to the requirements of this part for the gas involved; and

(iii) The bill of lading or other shipping paper identifies the cylinder and includes the following certification: “This cylinder has (These cylinders have) been qualified, as required, and filled in accordance with the DOT requirements for export.”

(5) Cylinders not equipped with pressure relief devices: A DOT specification or a UN cylinder manufactured, inspected, tested and marked in accordance with part 178 of this subchapter and otherwise conforms to the requirements of part 173 for the gas involved, except that the cylinder is not equipped with a pressure relief device may be filled with a gas and offered for transportation and transported for export if the following conditions are met:

(i) Each DOT specification cylinder or UN pressure receptacle must be

plainly and durably marked “For Export Only”;

(ii) The shipping paper must carry the following certification: “This cylinder has (These cylinders have) been retested and refilled in accordance with the DOT requirements for export.”; and

(iii) The emergency response information provided with the shipment and available from the emergency response telephone contact person must indicate that the pressure receptacles are not fitted with pressure relief devices and provide appropriate guidance for exposure to fire.

(b) *Conditions and requirements specific to certain materials*—(1) *Aerosols*. Except for a limited quantity of a compressed gas in a container of not more than 4 fluid ounces capacity meeting the requirements in §173.306(a)(1) of this subchapter, the proper shipping name “Aerosol,” UN1950, may be used only for a non-refillable receptacle containing a gas compressed, liquefied, or dissolved under pressure the sole purpose of which is to expel a nonpoisonous (other than Division 6.1, Packing Group III material) liquid, paste, or powder and fitted with a self-closing release device (see §171.8). In addition, an aerosol must be in a metal packaging when the packaging exceeds 7.22 cubic inches.

(2) *Air bag inflator, air bag module and seat-belt pretensioner*. For each approved air bag inflator, air bag module and seat-belt pretensioner, the shipping paper description must conform to the requirements in §173.166(c) of this subchapter.

(i) The EX number or product code must be included in association with the basic shipping description. When a product code is used, it must be traceable to the specific EX number assigned to the inflator, module or seat-belt pretensioner by the Associate Administrator. The EX number or product code is not required to be marked on the outside package.

(ii) The proper shipping name “Articles, pyrotechnic for technical purposes, UN0431” must be used for all air bag inflators, air bag modules, and seat-belt pretensioners meeting the criteria for a Division 1.4G material.

(3) *Chemical oxygen generators*. Chemical oxygen generators must be approved, classed, described, packaged, and transported in accordance with the requirements of this subchapter.

(4) *Class 1 (explosive) materials*. Prior to being transported, Class 1 (explosive) materials must be approved by the Associate Administrator in accordance with §173.56 of this subchapter. Each package containing a Class 1 (explosive) material must conform to the marking requirements in §172.320 of this subchapter.

(5) *Hazardous substances*. A material meeting the definition of a hazardous substance as defined in §171.8, must conform to the shipping paper requirements in §172.203(c) of this subchapter and the marking requirements in §172.324 of this subchapter:

(i) The proper shipping name must identify the hazardous substance by name, or the name of the substance must be entered in parentheses in association with the basic description and marked on the package in association with the proper shipping name. If the hazardous substance meets the definition for a hazardous waste, the waste code (for example, D001), may be used to identify the hazardous substance;

(ii) The shipping paper and the package markings must identify at least two hazardous substances with the lowest reportable quantities (RQs) when the material contains two or more hazardous substances; and

(iii) The letters “RQ” must be entered on the shipping paper either before or after the basic description, and marked on the package in association with the proper shipping name for each hazardous substance listed.

(6) *Hazardous wastes*. A material meeting the definition of a hazardous waste (see §171.8) must conform to the following:

(i) The shipping paper and the package markings must include the word “Waste” immediately preceding the proper shipping name;

(ii) The shipping paper must be retained by the shipper and by each carrier for three years after the material is accepted by the initial carrier (see §172.205(e)(5)); and

(iii) A hazardous waste manifest must be completed in accordance with §172.205 of this subchapter.

(7) *Marine pollutants.* Except for marine pollutants (see §171.8) transported in accordance with the IMDG Code, marine pollutants transported in bulk packages must meet the shipping paper requirements in §172.203(l) of this subchapter and the package marking requirements in §172.322 of this subchapter.

(8) *Organic peroxides.* Organic peroxides not identified by technical name in the Organic Peroxide Table in §173.225(c) of this subchapter must be approved by the Associate Administrator in accordance with §173.128(d) of this subchapter.

(9) [Reserved]

(10) *Poisonous by inhalation materials.* A material poisonous by inhalation (see §171.8) must conform to the following requirements:

(i) The words “Poison-Inhalation Hazard” or “Toxic-Inhalation Hazard” and the words “Zone A,” “Zone B,” “Zone C,” or “Zone D” for gases, or “Zone A” or “Zone B” for liquids, as appropriate, must be entered on the shipping paper immediately following the basic shipping description. The word “Poison” or “Toxic” or the phrase “Poison-Inhalation Hazard” or “Toxic-Inhalation Hazard” need not be repeated if it otherwise appears in the shipping description;

(ii) The material must be packaged in accordance with the requirements of this subchapter;

(iii) The package must be marked in accordance with §172.313 of this subchapter; and

(iv) Except as provided in subparagraph (B) of this paragraph (b)(10)(iv) and for a package containing anhydrous ammonia prepared in accordance with the Transport Canada TDG Regulations, the package must be labeled or placarded with POISON INHALATION HAZARD or POISON GAS, as appropriate, in accordance with Subparts E and F of part 172 of this subchapter.

(A) For a package transported in accordance with the IMDG Code in a closed transport vehicle or freight container, a label or placard conforming to the IMDG Code specifications for a “Class 2.3” or “Class 6.1” label or

placard may be substituted for the POISON GAS or POISON INHALATION HAZARD label or placard, as appropriate. The transport vehicle or freight container must be marked with the identification numbers for the hazardous material, regardless of the total quantity contained in the transport vehicle or freight container, in the manner specified in §172.313(c) of this subchapter and placarded as required by subpart F of part 172 of this subchapter.

(B) For a package transported in accordance with the Transport Canada TDG Regulations in a closed transport vehicle or freight container, a label or placard conforming to the TDG Regulations specifications for a “Class 2.3” or “Class 6.1” label or placard may be substituted for the POISON GAS or POISON INHALATION HAZARD label or placard, as appropriate. The transport vehicle or freight container must be marked with the identification numbers for the hazardous material, regardless of the total quantity contained in the transport vehicle or freight container, in the manner specified in §172.313(c) of this subchapter and placarded as required by subpart F of part 172 of this subchapter. While in transportation in the United States, the transport vehicle or freight container may also be placarded in accordance with the appropriate Transport Canada TDG Regulations in addition to being placarded with the POISON GAS or POISON INHALATION HAZARD placards.

(11) *Class 7 (radioactive) materials.* (i) Highway route controlled quantities (see §173.403 of this subchapter) must be shipped in accordance with §§172.203(d)(4) and (d)(10); 172.507, and 173.22(c) of this subchapter;

(ii) For fissile materials and Type B, Type B(U), and Type B(M) packagings, the competent authority certification and any necessary revalidation must be obtained from the appropriate competent authorities as specified in §§173.471, 173.472, and 173.473 of this subchapter, and all requirements of the certificates and revalidations must be met;

(iii) Type A package contents are limited in accordance with §173.431 of this subchapter;

(iv) The country of origin for the shipment must have adopted the edition of TS-R-1 of the IAEA Regulations referenced in § 171.7;

(v) The shipment must conform to the requirements of § 173.448, when applicable;

(vi) The definition for “radioactive material” in § 173.403 of this subchapter must be applied to radioactive materials transported under the provisions of this subpart;

(vii) Except for limited quantities, the shipment must conform to the requirements of § 172.204(c)(4) of this subchapter; and

(viii) Excepted packages of radioactive material, instruments or articles, or articles containing natural uranium or thorium must conform to the requirements of § 173.421, § 173.424, or § 173.426 of this subchapter, as appropriate.

(12) *Self-reactive materials.* Self-reactive materials not identified by technical name in the Self-reactive Materials Table in § 173.224(b) of this subchapter must be approved by the Associate Administrator in accordance with § 173.124(a)(2)(iii) of this subchapter.

[72 FR 25172, May 3, 2007, as amended at 72 FR 55684, Oct. 1, 2007; 73 FR 57004, Oct. 1, 2008; 76 FR 3345, Jan. 19, 2011; 76 FR 56311, Sept. 13, 2011; 78 FR 60751, Oct. 2, 2013; 78 FR 65468, Oct. 31, 2013]

§ 171.24 Additional requirements for the use of the ICAO Technical Instructions.

(a) A hazardous material that is offered for transportation or transported within the United States by aircraft, and by motor vehicle or rail either before or after being transported by aircraft in accordance with the ICAO Technical Instructions (IBR, see § 171.7), as authorized in paragraph (a) of § 171.22, must conform to the requirements in § 171.22, as applicable, and this section.

(b) Any person who offers for transportation or transports a hazardous material in accordance with the ICAO Technical Instructions must comply with the following additional conditions and requirements:

(1) All applicable requirements in parts 171 and 175 of this subchapter

(also see 14 CFR 121.135, 121.401, 121.433a, 135.323, 135.327 and 135.333);

(2) The quantity limits prescribed in the ICAO Technical Instructions for transportation by passenger-carrying or cargo aircraft, as applicable;

(3) The conditions or requirements of a United States variation, when specified in the ICAO Technical Instructions.

(c) *Highway transportation.* For transportation by highway prior to or after transportation by aircraft, a shipment must conform to the applicable requirements of part 177 of this subchapter, and the motor vehicle must be placarded in accordance with subpart F of part 172.

(d) *Conditions and requirements specific to certain materials.* Hazardous materials offered for transportation or transported in accordance with the ICAO Technical Instructions must conform to the following specific conditions and requirements, as applicable:

(1) *Batteries*—(i) *Nonspillable wet electric storage batteries.* Nonspillable wet electric storage batteries are not subject to the requirements of this subchapter provided—

(A) The battery meets the conditions specified in Special Provision 67 of the ICAO Technical Instructions;

(B) The battery, its outer packaging, and any overpack are plainly and durably marked “NONSPILLABLE” or “NONSPILLABLE BATTERY”; and

(C) The batteries or battery assemblies are offered for transportation or transported in a manner that prevents short circuiting or forced discharge, including, but not limited to, protection of exposed terminals.

(ii) *Lithium metal cells and batteries.* Lithium metal cells and batteries (UN3090) are forbidden for transport aboard passenger-carrying aircraft. The outside of each package that contains lithium metal cells or lithium metal batteries (UN3090) transported in accordance with Packing Instruction 968, Section II of the ICAO Technical Instructions must be marked “PRIMARY LITHIUM BATTERIES—FORBIDDEN FOR TRANSPORT ABOARD PASSENGER AIRCRAFT” or “LITHIUM METAL BATTERIES—FORBIDDEN FOR TRANSPORT ABOARD PASSENGER AIRCRAFT.”

(iii) *Low production runs or prototypes lithium cells or batteries.* Production runs consisting of not more than 100 lithium cells or batteries per year, or prototype lithium cells or batteries (including cells or batteries packed with, or contained in, equipment or motor vehicles) not of a type proven to meet the requirements of section 38.3 of the UN Manual of Tests and Criteria (IBR, see §171.7 of this subchapter), must be approved by the Associate Administrator prior to transportation aboard aircraft.

(2) A package containing Oxygen, compressed, or any of the following oxidizing gases must be packaged as required by parts 173 and 178 of this subchapter: carbon dioxide and oxygen mixtures, compressed; compressed gas, oxidizing, n.o.s.; liquefied gas, oxidizing, n.o.s.; nitrogen trifluoride; and nitrous oxide.

[72 FR 25172, May 3, 2007, as amended at 72 FR 44847, Aug. 9, 2007; 72 FR 55097, Sept. 28, 2007; 79 FR 46034, Aug. 6, 2014]

§ 171.25 Additional requirements for the use of the IMDG Code.

(a) A hazardous material may be offered for transportation or transported to, from or within the United States by vessel, and by motor carrier and rail in accordance with the IMDG Code (IBR, see §171.7), as authorized in §171.22, provided all or part of the movement is by vessel. Such shipments must conform to the requirements in §171.22, as applicable, and this section.

(b) Any person who offers for transportation or transports a hazardous material in accordance with the IMDG Code must conform to the following additional conditions and requirements:

(1) Unless specified otherwise in this subchapter, a shipment must conform to the requirements in part 176 of this subchapter. For transportation by rail or highway prior to or subsequent to transportation by vessel, a shipment must conform to the applicable requirements of parts 174 and 177 respectively, of this subchapter, and the motor vehicle or rail car must be placarded in accordance with subpart F of part 172 of this subchapter. When a hazardous material regulated by this subchapter for transportation by highway is transported by motor vehicle on a

public highway or by rail under the provisions of subpart C of part 171, the segregation requirements of Part 7, Chapter 7.2 of the IMDG Code are authorized.

(2) For transportation by vessel, the stowage and segregation requirements in Part 7 of the IMDG Code may be substituted for the stowage and segregation requirements in part 176 of this subchapter.

(3) The outside of each package containing lithium metal cells or batteries (UN3090) transported in accordance with special provision 188 of the IMDG Code must be marked “PRIMARY LITHIUM BATTERIES—FORBIDDEN FOR TRANSPORT ABOARD PASSENGER AIRCRAFT” or “LITHIUM METAL BATTERIES—FORBIDDEN FOR TRANSPORT ABOARD PASSENGER AIRCRAFT.” This marking is not required on packages that contain 5 kg (11 pounds) net weight or less of lithium metal cells or batteries that are packed with, or contained in, equipment.

(4) Material consigned under UN3166 and UN3171 (*e.g.*, Engines, internal combustion, *etc.*, Vehicles, *etc.* and Battery-powered equipment) may be prepared in accordance with the IMDG Code or this subchapter.

(c) *Conditions and requirements for bulk packagings.* Except for IBCs and UN portable tanks used for the transportation of liquids or solids, bulk packagings must conform to the requirements of this subchapter. Additionally, the following requirements apply:

(1) UN portable tanks must conform to the requirements in Special Provisions TP37, TP38, TP44 and TP45 when applicable, and any applicable bulk special provisions assigned to the hazardous material in the Hazardous Materials Table in §172.101 of this subchapter;

(2) IMO Type 5 portable tanks must conform to DOT Specification 51 or UN portable tank requirements, unless specifically authorized in this subchapter or approved by the Associate Administrator;

(3) Except as specified in this subpart, for a material poisonous (toxic) by inhalation, the T Codes specified in Column 13 of the Dangerous Goods List

in the IMDG Code may be applied to the transportation of those materials in IM, IMO and DOT Specification 51 portable tanks, when these portable tanks are authorized in accordance with the requirements of this subchapter; and

(4) No person may offer an IM or UN portable tank containing liquid hazardous materials of Class 3, PG I or II, or PG III with a flash point less than 100 °F (38 °C); Division 5.1, PG I or II; or Division 6.1, PG I or II, for unloading while it remains on a transport vehicle with the motive power unit attached, unless it conforms to the requirements in §177.834(o) of this subchapter.

(d) *Use of IMDG Code in port areas.* (1) Except for Division 1.1, 1.2, and Class 7 materials, a hazardous material being imported into or exported from the United States or passing through the United States in the course of being shipped between locations outside the United States may be offered and accepted for transportation and transported by motor vehicle within a single port area, including contiguous harbors, when packaged, marked, classed, labeled, stowed and segregated in accordance with the IMDG Code, offered and accepted in accordance with the requirements of subparts C and F of part 172 of this subchapter pertaining to shipping papers and placarding, and otherwise conforms to the applicable requirements of part 176 of this subchapter.

(2) The requirement in §172.201(d) of this subchapter for an emergency telephone number does not apply to shipments made in accordance with the IMDG Code if the hazardous material is not offloaded from the vessel, or is offloaded between ocean vessels at a U.S. port facility without being transported by public highway.

[72 FR 25172, May 3, 2007, as amended at 72 FR 44847, Aug. 9, 2007; 73 FR 57004, Oct. 1, 2008; 74 FR 2233, Jan. 14, 2009; 76 FR 3345, Jan. 19, 2011; 79 FR 46034, Aug. 6, 2014]

§ 171.26 Additional requirements for the use of the IAEA Regulations.

A Class 7 (radioactive) material being imported into or exported from the United States or passing through the United States in the course of being shipped between places outside the

United States may be offered for transportation or transported in accordance with the IAEA Regulations (IBR, see §171.7) as authorized in paragraph (a) of §171.22, provided the requirements in §171.22, as applicable, are met.

PART 172—HAZARDOUS MATERIALS TABLE, SPECIAL PROVISIONS, HAZARDOUS MATERIALS COMMUNICATIONS, EMERGENCY RESPONSE INFORMATION, TRAINING REQUIREMENTS, AND SECURITY PLANS

Subpart A—General

- Sec.
172.1 Purpose and scope.
172.3 Applicability.

Subpart B—Table of Hazardous Materials and Special Provisions

- 172.101 Purpose and use of hazardous materials table.
172.102 Special provisions.

Subpart C—Shipping Papers

- 172.200 Applicability.
172.201 Preparation and retention of shipping papers.
172.202 Description of hazardous material on shipping papers.
172.203 Additional description requirements.
172.204 Shipper's certification.
172.205 Hazardous waste manifest.

Subpart D—Marking

- 172.300 Applicability.
172.301 General marking requirements for non-bulk packagings.
172.302 General marking requirements for bulk packagings.
172.303 Prohibited marking.
172.304 Marking requirements.
172.306 [Reserved]
172.308 Authorized abbreviations.
172.310 Class 7 (radioactive) materials.
172.312 Liquid hazardous materials in non-bulk packagings.
172.313 Poisonous hazardous materials.
172.315 Limited quantities.
172.316 Packagings containing materials classed as ORM-D.
172.317 KEEP AWAY FROM HEAT handling mark.
172.320 Explosive hazardous materials.
172.322 Marine pollutants.
172.323 Infectious substances.
172.324 Hazardous substances in non-bulk packagings.
172.325 Elevated temperature materials.

Pt. 172

49 CFR Ch. I (10–1–14 Edition)

- 172.326 Portable tanks.
- 172.327 Petroleum sour crude oil in bulk packaging.
- 172.328 Cargo tanks.
- 172.330 Tank cars and multi-unit tank car tanks.
- 172.331 Bulk packagings other than portable tanks, cargo tanks, tank cars and multi-unit tank car tanks.
- 172.332 Identification number markings.
- 172.334 Identification numbers; prohibited display.
- 172.336 Identification numbers; special provisions.
- 172.338 Replacement of identification numbers.

Subpart E—Labeling

- 172.400 General labeling requirements.
- 172.400a Exceptions from labeling.
- 172.401 Prohibited labeling.
- 172.402 Additional labeling requirements.
- 172.403 Class 7 (radioactive) material.
- 172.404 Labels for mixed and consolidated packaging.
- 172.405 Authorized label modifications.
- 172.406 Placement of labels.
- 172.407 Label specifications.
- 172.411 EXPLOSIVE 1.1, 1.2, 1.3, 1.4, 1.5 and 1.6 labels, and EXPLOSIVE Subsidiary label.
- 172.415 NON-FLAMMABLE GAS label.
- 172.416 POISON GAS label.
- 172.417 FLAMMABLE GAS label.
- 172.419 FLAMMABLE LIQUID label.
- 172.420 FLAMMABLE SOLID label.
- 172.422 SPONTANEOUSLY COMBUSTIBLE label.
- 172.423 DANGEROUS WHEN WET label.
- 172.426 OXIDIZER label.
- 172.427 ORGANIC PEROXIDE label.
- 172.429 POISON INHALATION HAZARD label.
- 172.430 POISON label.
- 172.431 [Reserved]
- 172.432 INFECTIOUS SUBSTANCE label.
- 172.436 RADIOACTIVE WHITE-I label.
- 172.438 RADIOACTIVE YELLOW-II label.
- 172.440 RADIOACTIVE YELLOW-III label.
- 172.441 FISSILE label.
- 172.442 CORROSIVE label.
- 172.444 [Reserved]
- 172.446 CLASS 9 label.
- 172.448 CARGO AIRCRAFT ONLY label.
- 172.450 EMPTY label.

Subpart F—Placarding

- 172.500 Applicability of placarding requirements.
- 172.502 Prohibited and permissive placarding.
- 172.503 Identification number display on placards.
- 172.504 General placarding requirements.
- 172.505 Placarding for subsidiary hazards.

- 172.506 Providing and affixing placards: Highway.
- 172.507 Special placarding provisions: Highway.
- 172.508 Placarding and affixing placarding: Rail.
- 172.510 Special placarding provisions: Rail.
- 172.512 Freight containers and aircraft unit load devices.
- 172.514 Bulk packagings.
- 172.516 Visibility and display of placards.
- 172.519 General specifications for placards.
- 172.521 DANGEROUS placard.
- 172.522 EXPLOSIVES 1.1, EXPLOSIVES 1.2 and EXPLOSIVES 1.3 placards.
- 172.523 EXPLOSIVES 1.4 placard.
- 172.524 EXPLOSIVES 1.5 placard.
- 172.525 EXPLOSIVES 1.6 placard.
- 172.526 [Reserved]
- 172.527 Background requirements for certain placards.
- 172.528 NON-FLAMMABLE GAS placard.
- 172.530 OXYGEN placard.
- 172.532 FLAMMABLE GAS placard.
- 172.536 [Reserved]
- 172.540 POISON GAS placard.
- 172.542 FLAMMABLE placard.
- 172.544 COMBUSTIBLE placard.
- 172.546 FLAMMABLE SOLID placard.
- 172.547 SPONTANEOUSLY COMBUSTIBLE placard.
- 172.548 DANGEROUS WHEN WET placard.
- 172.550 OXIDIZER placard.
- 172.552 ORGANIC PEROXIDE placard.
- 172.553 [Reserved]
- 172.554 POISON placard.
- 172.555 POISON INHALATION HAZARD placard.
- 172.556 RADIOACTIVE placard.
- 172.558 CORROSIVE placard.
- 172.560 CLASS 9 placard.

Subpart G—Emergency Response Information

- 172.600 Applicability and general requirements.
- 172.602 Emergency response information.
- 172.604 Emergency response telephone number.
- 172.606 Carrier information contact.

Subpart H—Training

- 172.700 Purpose and scope.
- 172.701 Federal-State relationship.
- 172.702 Applicability and responsibility for training and testing.
- 172.704 Training requirements.

Subpart I—Safety and Security Plans

- 172.800 Purpose and applicability.
- 172.802 Components of a security plan.
- 172.804 Relationship to other Federal requirements.
- 172.820 Additional planning requirements for transportation by rail.

172.822 Limitation on actions by states, local governments, and Indian tribes.

APPENDIX A TO PART 172—OFFICE OF HAZARDOUS MATERIALS TRANSPORTATION COLOR TOLERANCE CHARTS AND TABLES

APPENDIX B TO PART 172—TREFOIL SYMBOL

APPENDIX C TO PART 172—DIMENSIONAL SPECIFICATIONS FOR RECOMMENDED PLACARD HOLDER

APPENDIX D TO PART 172—RAIL RISK ANALYSIS FACTORS

AUTHORITY: 49 U.S.C. 5101–5128, 44701; 49 CFR 1.81, 1.96 and 1.97.

SOURCE: Amdt. 172–29, 41 FR 15996, Apr. 15, 1976, unless otherwise noted.

Subpart A—General

§ 172.1 Purpose and scope.

This part lists and classifies those materials which the Department has designated as hazardous materials for purposes of transportation and prescribes the requirements for shipping papers, package marking, labeling, and transport vehicle placarding applicable to the shipment and transportation of those hazardous materials.

[Amdt. 172–29, 41 FR 15997, Apr. 15, 1976, as amended by 66 FR 45379, Aug. 28, 2001]

§ 172.3 Applicability.

(a) This part applies to—

(1) Each person who offers a hazardous material for transportation, and

(2) Each carrier by air, highway, rail, or water who transports a hazardous material.

(b) When a person, other than one of those provided for in paragraph (a) of this section, performs a packaging labeling or marking function required by this part, that person shall perform the function in accordance with this part.

[Amdt. 172–29, 41 FR 15996, Apr. 15, 1976, as amended by Amdt. 172–32, 41 FR 38179, Sept. 9, 1976]

Subpart B—Table of Hazardous Materials and Special Provisions

§ 172.101 Purpose and use of hazardous materials table.

(a) The Hazardous Materials Table (Table) in this section designates the materials listed therein as hazardous materials for the purpose of transportation of those materials. For each listed material, the Table identifies the

hazard class or specifies that the material is forbidden in transportation, and gives the proper shipping name or directs the user to the preferred proper shipping name. In addition, the Table specifies or references requirements in this subchapter pertaining to labeling, packaging, quantity limits aboard aircraft and stowage of hazardous materials aboard vessels.

(b) *Column 1: Symbols.* Column 1 of the Table contains six symbols (“+”, “A”, “D”, “G”, “I” and “W”) as follows:

(1) The plus (+) sign fixes the proper shipping name, hazard class and packing group for that entry without regard to whether the material meets the definition of that class, packing group or any other hazard class definition. When the plus sign is assigned to a proper shipping name in Column (1) of the § 172.101 Table, it means that the material is known to pose a risk to humans. When a plus sign is assigned to mixtures or solutions containing a material where the hazard to humans is significantly different from that of the pure material or where no hazard to humans is posed, the material may be described using an alternative shipping name that represents the hazards posed by the material. An appropriate alternate proper shipping name and hazard class may be authorized by the Associate Administrator.

(2) The letter “A” denotes a material that is subject to the requirements of this subchapter only when offered or intended for transportation by aircraft, unless the material is a hazardous substance or a hazardous waste. A shipping description entry preceded by an “A” may be used to describe a material for other modes of transportation provided all applicable requirements for the entry are met.

(3) The letter “D” identifies proper shipping names which are appropriate for describing materials for domestic transportation but may be inappropriate for international transportation under the provisions of international regulations (e.g., IMO, ICAO). An alternate proper shipping name may be selected when either domestic or international transportation is involved.

(4) The letter “G” identifies proper shipping names for which one or more

technical names of the hazardous material must be entered in parentheses, in association with the basic description. (See §172.203(k).)

(5) The letter “I” identifies proper shipping names which are appropriate for describing materials in international transportation. An alternate proper shipping name may be selected when only domestic transportation is involved.

(6) The letter “W” denotes a material that is subject to the requirements of this subchapter only when offered or intended for transportation by vessel, unless the material is a hazardous substance or a hazardous waste. A shipping description entry preceded by a “W” may be used to describe a material for other modes of transportation provided all applicable requirements for the entry are met.

(c) *Column 2: Hazardous materials descriptions and proper shipping names.* Column 2 lists the hazardous materials descriptions and proper shipping names of materials designated as hazardous materials. Modification of a proper shipping name may otherwise be required or authorized by this section. Proper shipping names are limited to those shown in Roman type (not italics).

(1) Proper shipping names may be used in the singular or plural and in either capital or lower case letters. Words may be alternatively spelled in the same manner as they appear in the ICAO Technical Instructions or the IMDG Code. For example “aluminum” may be spelled “aluminium” and “sulfur” may be spelled “sulphur”. However, the word “inflammable” may not be used in place of the word “flammable”.

(2) Punctuation marks and words in italics are not part of the proper shipping name, but may be used in addition to the proper shipping name. The word “or” in italics indicates that there is a choice of terms in the sequence that may alternately be used as the proper shipping name or as part of the proper shipping name, as appropriate. For example, for the hazardous materials description “Carbon dioxide, solid or Dry ice” either “Carbon dioxide, solid” or “Dry ice” may be used as the proper shipping name; and for the hazardous

materials description “Articles, pressurized pneumatic or hydraulic,” either “Articles, pressurized pneumatic” or “Articles, pressurized hydraulic” may be used as the proper shipping name.

(3) The word “poison” or “poisonous” may be used interchangeably with the word “toxic” when only domestic transportation is involved. The abbreviation “n.o.i.” or “n.o.i.b.n.” may be used interchangeably with “n.o.s.”.

(4) Except for hazardous wastes, when qualifying words are used as part of the proper shipping name, their sequence in the package markings and shipping paper description is optional. However, the entry in the Table reflects the preferred sequence.

(5) When one entry references another entry by use of the word “see”, if both names are in Roman type, either name may be used as the proper shipping name (e.g., Ethyl alcohol, *see* Ethanol).

(6) When a proper shipping name includes a concentration range as part of the shipping description, the actual concentration, if it is within the range stated, may be used in place of the concentration range. For example, an aqueous solution of hydrogen peroxide containing 30 percent peroxide may be described as “Hydrogen peroxide, aqueous solution *with not less than 20 percent but not more than 40 percent hydrogen peroxide*” or “Hydrogen peroxide, aqueous solution *with 30 percent hydrogen peroxide*.” Also, the percent sign (%) may be used in place of the word “percent” when words in italics containing the word “percent” are used in addition to the proper shipping name.

(7) Use of the prefix “mono” is optional in any shipping name, when appropriate. Thus, Iodine monochloride may be used interchangeably with Iodine chloride. In “Glycerol alpha-monochlorohydrin” the term “mono” is considered a prefix to the term “chlorohydrin” and may be deleted.

(8) Use of the word “liquid” or “solid”. The word “liquid” or “solid” may be added to a proper shipping name when a hazardous material specifically listed by name may, due to differing physical states, be a liquid or solid. When the packaging specified in

Column 8 is inappropriate for the physical state of the material, the table provided in paragraph (i)(4) of this section should be used to determine the appropriate packaging section.

(9) *Hazardous wastes.* If the word “waste” is not included in the hazardous material description in Column 2 of the Table, the proper shipping name for a hazardous waste (as defined in §171.8 of this subchapter), shall include the word “Waste” preceding the proper shipping name of the material. For example: Waste acetone.

(10) *Mixtures and solutions.* (i) A mixture or solution meeting the definition of one or more hazard class that is not identified specifically by name, comprised of a single predominant hazardous material identified in the Table by technical name and one or more hazardous and/or non-hazardous material, must be described using the proper shipping name of the hazardous material and the qualifying word “mixture” or “solution”, as appropriate, unless—

(A) Except as provided in §172.101(i)(4) the packaging specified in Column 8 is inappropriate to the physical state of the material;

(B) The shipping description indicates that the proper shipping name applies only to the pure or technically pure hazardous material;

(C) The hazard class, packing group, or subsidiary hazard of the mixture or solution is different from that specified for the entry;

(D) There is a significant change in the measures to be taken in emergencies;

(E) The material is identified by special provision in Column 7 of the §172.101 Table as a material poisonous by inhalation; however, it no longer meets the definition of poisonous by inhalation or it falls within a different hazard zone than that specified in the special provision; or

(F) The material can be appropriately described by a shipping name that describes its intended application, such as “Coating solution”, “Extracts, flavoring” or “Compound, cleaning liquid.”

(ii) If one or more of the conditions in paragraphs (c)(10)(i)(A) through (F) of this section is satisfied then the

proper shipping name selection process in (c)(12)(ii) must be used.

(iii) A mixture or solution meeting the definition of one or more hazard class that is not identified in the Table specifically by name, comprised of two or more hazardous materials in the same hazard class, must be described using an appropriate shipping description (e.g., “Flammable liquid, n.o.s.”). The name that most appropriately describes the material shall be used; e.g., an alcohol not listed by its technical name in the Table shall be described as “Alcohol, n.o.s.” rather than “Flammable liquid, n.o.s.”. Some mixtures may be more appropriately described according to their application, such as “Coating solution” or “Extracts, flavoring liquid” rather than by an n.o.s. entry. Under the provisions of subparts C and D of this part, the technical names of at least two components most predominately contributing to the hazards of the mixture or solution may be required in association with the proper shipping name.

(11) Except for a material subject to or prohibited by §173.21, 173.54, 173.56(d), 173.56(e), 173.224(c) or 173.225(b) of this subchapter, a material that is considered to be a hazardous waste or a sample of a material for which the hazard class is uncertain and must be determined by testing may be assigned a tentative proper shipping name, hazard class, identification number and packing group, if applicable, based on the shipper’s tentative determination according to:

(i) Defining criteria in this subchapter;

(ii) The hazard precedence prescribed in §173.2a of this subchapter;

(iii) The shipper’s knowledge of the material;

(iv) In addition to paragraphs (c)(11)(i) through (iii) of this section, for a sample of a material other than a waste, the following must be met:

(A) Except when the word “Sample” already appears in the proper shipping name, the word “Sample” must appear as part of the proper shipping name or in association with the basic description on the shipping paper.

(B) When the proper shipping description for a sample is assigned a “G” in Column (1) of the §172.101 Table, and

§ 172.101

49 CFR Ch. I (10–1–14 Edition)

the primary constituent(s) for which the tentative classification is based are not known, the provisions requiring a technical name for the constituent(s) do not apply; and

(C) A sample must be transported in a combination packaging that conforms to the requirements of this subchapter that are applicable to the tentative packing group assigned, and may not exceed a net mass of 2.5 kg (5.5 pounds) per package.

NOTE TO PARAGRAPH (C)(11): For the transportation of samples of self-reactive materials, organic peroxides, explosives or lighters, see § 173.224(c)(3), § 173.225(c)(2), § 173.56(d) or § 173.308(b)(2) of this subchapter, respectively.

(12) Except when the proper shipping name in the Table is preceded by a plus (+)—

(i) If it is specifically determined that a material meets the definition of a hazard class, packing group or hazard zone, other than the class, packing group or hazard zone shown in association with the proper shipping name, or does not meet the defining criteria for a subsidiary hazard shown in Column 6 of the Table, the material shall be described by an appropriate proper shipping name listed in association with the correct hazard class, packing group, hazard zone, or subsidiary hazard for the material.

(ii) *Generic or n.o.s. descriptions.* If an appropriate technical name is not shown in the Table, selection of a proper shipping name shall be made from the generic or n.o.s. descriptions corresponding to the specific hazard class, packing group, hazard zone, or subsidiary hazard, if any, for the material. The name that most appropriately describes the material shall be used; e.g., an alcohol not listed by its technical name in the Table shall be described as “Alcohol, n.o.s.” rather than “Flammable liquid, n.o.s.”. Some mixtures may be more appropriately described according to their application, such as “Coating solution” or “Extracts, flavoring, liquid”, rather than by an n.o.s. entry, such as “Flammable liquid, n.o.s.” It should be noted, however, that an n.o.s. description as a proper shipping name may not provide sufficient information for shipping papers and package markings. Under the pro-

visions of subparts C and D of this part, the technical name of one or more constituents which makes the product a hazardous material may be required in association with the proper shipping name.

(iii) *Multiple hazard materials.* If a material meets the definition of more than one hazard class, and is not identified in the Table specifically by name (e.g., acetyl chloride), the hazard class of the material shall be determined by using the precedence specified in § 173.2a of this subchapter, and an appropriate shipping description (e.g., “Flammable liquid, corrosive n.o.s.”) shall be selected as described in paragraph (c)(12)(ii) of this section.

(iv) If it is specifically determined that a material is not a forbidden material and does not meet the definition of any hazard class, the material is not a hazardous material.

(13) *Self-reactive materials and organic peroxides.* A generic proper shipping name for a self-reactive material or an organic peroxide, as listed in Column 2 of the Table, must be selected based on the material’s technical name and concentration, in accordance with the provisions of § 173.224 or § 173.225 of this subchapter, respectively.

(14) A proper shipping name that describes all isomers of a material may be used to identify any isomer of that material if the isomer meets criteria for the same hazard class or division, subsidiary risk(s) and packing group, unless the isomer is specifically identified in the Table.

(15) Unless a hydrate is specifically listed in the Table, a proper shipping name for the equivalent anhydrous substance may be used, if the hydrate meets the same hazard class or division, subsidiary risk(s) and packing group.

(16) Unless it is already included in the proper shipping name in the § 172.101 Table, the qualifying words “liquid” or “solid” may be added in association with the proper shipping name when a hazardous material specifically listed by name in the § 172.101 Table may, due to the differing physical states of the various isomers of the material, be either a liquid or a solid (for example “Dinitrotoluenes, liquid” and “Dinitrotoluenes, solid”). Use of

the words “liquid” or “solid” is subject to the limitations specified for the use of the words “mixture” or “solution” in paragraph (c)(10) of this section. The qualifying word “molten” may be added in association with the proper shipping name when a hazardous material, which is a solid in accordance with the definition in §171.8 of this subchapter, is offered for transportation in the molten state (for example, “Alkylphenols, solid, n.o.s., molten”).

(d) *Column 3: Hazard class or Division.* Column 3 contains a designation of the hazard class or division corresponding to each proper shipping name, or the word “Forbidden”.

(1) A material for which the entry in this column is “Forbidden” may not be offered for transportation or transported. This prohibition does not apply if the material is diluted, stabilized or incorporated in a device and it is classed in accordance with the definitions of hazardous materials contained in part 173 of this subchapter.

(2) When a reevaluation of test data or new data indicates a need to modify the “Forbidden” designation or the hazard class or packing group specified for a material specifically identified in the Table, this data should be submitted to the Associate Administrator.

(3) A basic description of each hazard class and the section reference for class definitions appear in §173.2 of this subchapter.

(4) Each reference to a Class 3 material is modified to read “Combustible liquid” when that material is reclassified in accordance with §173.150(e) or (f) of this subchapter or has a flash point above 60 °C (140 °F) but below 93 °C (200 °F).

(e) *Column 4: Identification number.* Column 4 lists the identification number assigned to each proper shipping name. Those preceded by the letters “UN” are associated with proper shipping names considered appropriate for international transportation as well as domestic transportation. Those preceded by the letters “NA” are associated with proper shipping names not recognized for international transportation, except to and from Canada. Identification numbers in the “NA9000” series are associated with proper shipping names not appropriately covered

by international hazardous materials (dangerous goods) transportation standards, or not appropriately addressed by international transportation standards for emergency response information purposes, except for transportation between the United States and Canada. Those preceded by the letters “ID” are associated with proper shipping names recognized by the ICAO Technical Instructions (IBR, see §171.7 of this subchapter).

(f) *Column 5: Packing group.* Column 5 specifies one or more packing groups assigned to a material corresponding to the proper shipping name and hazard class for that material. Class 2, Class 7, Division 6.2 (other than regulated medical wastes), and ORM-D materials, do not have packing groups. Packing Groups I, II and III indicate the degree of danger presented by the material is either great, medium or minor, respectively. If more than one packing group is indicated for an entry, the packing group for the hazardous material is determined using the criteria for assignment of packing groups specified in subpart D of part 173. When a reevaluation of test data or new data indicates a need to modify the specified packing group(s), the data should be submitted to the Associate Administrator. Each reference in this column to a material which is a hazardous waste or a hazardous substance, and whose proper shipping name is preceded in Column 1 of the Table by the letter “A” or “W”, is modified to read “III” on those occasions when the material is offered for transportation or transported by a mode in which its transportation is not otherwise subject to requirements of this subchapter.

(g) *Column 6: Labels.* Column 6 specifies codes which represent the hazard warning labels required for a package filled with a material conforming to the associated hazard class and proper shipping name, unless the package is otherwise excepted from labeling by a provision in subpart E of this part, or part 173 of this subchapter. The first code is indicative of the primary hazard of the material. Additional label codes are indicative of subsidiary hazards. Provisions in §172.402 may require that a label other than that specified in Column 6 be affixed to the package

§ 172.101

49 CFR Ch. I (10–1–14 Edition)

in addition to that specified in Column 6. No label is required for a material classed as a combustible liquid or for a Class 3 material that is reclassified as a combustible liquid. For “Empty” label

requirements, see §173.428 of this subchapter. The codes contained in Column 6 are defined according to the following table:

LABEL SUBSTITUTION TABLE

Label code	Label name
1	Explosive
1.1 ¹	Explosive 1.1 ¹
1.2 ¹	Explosive 1.2 ¹
1.3 ¹	Explosive 1.3 ¹
1.4 ¹	Explosive 1.4 ¹
1.5 ¹	Explosive 1.5 ¹
1.6 ¹	Explosive 1.6 ¹
2.1	Flammable Gas
2.2	Non-Flammable Gas
2.3	Poison Gas
3	Flammable Liquid
4.1	Flammable Solid
4.2	Spontaneously Combustible
4.3	Dangerous When Wet
5.1	Oxidizer
5.2	Organic Peroxide
6.1 (inhalation hazard, Zone A or B).	Poison Inhalation Hazard
6.1 (other than inhalation hazard, Zone A or B) ² .	Poison
6.2	Infectious substance
7	Radioactive
8	Corrosive
9	Class 9

¹ Refers to the appropriate compatibility group letter.
² The packing group for a material is indicated in column 5 of the table.

(h) *Column 7: Special provisions.* Column 7 specifies codes for special provisions applicable to hazardous materials. When Column 7 refers to a special provision for a hazardous material, the meaning and requirements of that special provision are as set forth in §172.102 of this subpart.

(i) *Column 8: Packaging authorizations.* Columns 8A, 8B and 8C specify the applicable sections for exceptions, non-bulk packaging requirements and bulk packaging requirements, respectively, in part 173 of this subchapter. Columns 8A, 8B and 8C are completed in a manner which indicates that “§173.” precedes the designated numerical entry. For example, the entry “202” in Column 8B associated with the proper shipping name “Gasoline” indicates that for this material conformance to non-bulk packaging requirements prescribed in §173.202 of this subchapter is required. When packaging requirements are specified, they are in addition to the standard requirements for all packagings prescribed in §173.24 of this subchapter and any other applicable requirements in subparts A and B of part 173 of this subchapter.

(1) Exceptions. Column 8A contains exceptions from some of the requirements of this subchapter. The ref-

erenced exceptions are in addition to those specified in subpart A of part 173 and elsewhere in this subchapter. A “None” in this column means no packaging exceptions are authorized, except as may be provided by special provisions in Column 7.

(2) Non-bulk packaging. Column 8B references the section in part 173 of this subchapter which prescribes packaging requirements for non-bulk packagings. A “None” in this column means non-bulk packagings are not authorized, except as may be provided by special provisions in Column 7. Each reference in this column to a material which is a hazardous waste or a hazardous substance, and whose proper shipping name is preceded in Column 1 of the Table by the letter “A” or “W”, is modified to include “§173.203” or “§173.213”, as appropriate for liquids and solids, respectively, on those occasions when the material is offered for transportation or transported by a mode in which its transportation is not otherwise subject to the requirements of this subchapter.

(3) Bulk packaging. Column (8C) specifies the section in part 173 of this subchapter that prescribes packaging requirements for bulk packagings, subject to the limitations, requirements, and additional authorizations of Columns (7) and (8B). A “None” in Column (8C) means bulk packagings are not authorized, except as may be provided by special provisions in Column (7) and in packaging authorizations Column (8B). Additional authorizations and limitations for use of UN portable tanks are set forth in Column 7. For each reference in this column to a material that is a hazardous waste or a hazardous substance, and whose proper shipping name is preceded in Column 1 of the Table by the letter “A” or “W” and that is offered for transportation or transported by a mode in which its transportation is not otherwise subject to the requirements of this subchapter:

(4) For a hazardous material which is specifically named in the Table and whose packaging sections specify packagings not applicable to the form of the material (e.g., packaging specified is for solid material and the material is being offered for transportation in a liquid form) the following table should

§ 172.101

49 CFR Ch. I (10–1–14 Edition)

be used to determine the appropriate packaging section:

Packaging section reference for solid materials	Corresponding packaging section for liquid materials
§ 173.187	§ 173.181
§ 173.211	§ 173.201
§ 173.212	§ 173.202
§ 173.213	§ 173.203
§ 173.240	§ 173.241
§ 173.242	§ 173.243

(5) *Cylinders.* For cylinders, both non-bulk and bulk packaging authorizations are set forth in Column (8B). Notwithstanding a designation of “None” in Column (8C), a bulk cylinder may be used when specified through the section reference in Column (8B).

(j) *Column 9: Quantity limitations.* Columns 9A and 9B specify the maximum quantities that may be offered for transportation in one package by passenger-carrying aircraft or passenger-carrying rail car (Column 9A) or by cargo aircraft only (Column 9B), subject to the following:

(1) “Forbidden” means the material may not be offered for transportation or transported in the applicable mode of transport.

(2) The quantity limitation is “net” except where otherwise specified, such as for “Consumer commodity” which specifies “30 kg gross.”

(3) When articles or devices are specifically listed by name, the net quantity limitation applies to the entire article or device (less packaging and packaging materials) rather than only to its hazardous components.

(4) A package offered or intended for transportation by aircraft and which is filled with a material forbidden on passenger-carrying aircraft but permitted on cargo aircraft only, or which exceeds the maximum net quantity authorized on passenger-carrying aircraft, shall be labelled with the CARGO AIRCRAFT ONLY label specified in §172.448 of this part.

(5) The total net quantity of hazardous material for an outer non-bulk packaging that contains more than one hazardous material may not exceed the lowest permitted maximum net quantity per package as shown in Column 9A or 9B, as appropriate. If one material is a liquid and one is a solid, the maximum net quantity must be cal-

culated in kilograms. See §173.24a(c)(1)(iv).

(k) Column 10: Vessel stowage requirements. Column 10A [Vessel stowage] specifies the authorized stowage locations on board cargo and passenger vessels. Column 10B [Other provisions] specifies codes for stowage requirements for specific hazardous materials. Hazardous materials offered for transportation as limited quantities are allocated stowage category A and are not subject to the stowage codes assigned by column 10B. The meaning of each code in Column 10B is set forth in §176.84 of this subchapter. Section 176.63 of this subchapter sets forth the physical requirements for each of the authorized locations listed in Column 10A. (For bulk transportation by vessel, see 46 CFR parts 30 to 40, 70, 98, 148, 151, 153 and 154.) The authorized stowage locations specified in Column 10A are defined as follows:

(1) Stowage category “A” means the material may be stowed “on deck” or “under deck” on a cargo vessel or on a passenger vessel.

(2) Stowage category “B” means—
 (i) The material may be stowed “on deck” or “under deck” on a cargo vessel and on a passenger vessel carrying a number of passengers limited to not more than the larger of 25 passengers, or one passenger per each 3 m of overall vessel length; and

(ii) “On deck only” on passenger vessels in which the number of passengers specified in paragraph (k)(2)(i) of this section is exceeded.

(3) Stowage category “C” means the material must be stowed “on deck only” on a cargo vessel or on a passenger vessel.

(4) Stowage category “D” means the material must be stowed “on deck only” on a cargo vessel or on a passenger vessel carrying a number of passengers limited to not more than the larger of 25 passengers or one passenger per each 3 m of overall vessel length, but the material is prohibited on a passenger vessel in which the limiting number of passengers is exceeded.

(5) Stowage category “E” means the material may be stowed “on deck” or “under deck” on a cargo vessel or on a passenger vessel carrying a number of passengers limited to not more than

the larger of 25 passengers, or one passenger per each 3 m of overall vessel length, but is prohibited from carriage on a passenger vessel in which the limiting number of passengers is exceeded.

(6) Stowage category "01" means the material may be stowed "on deck" in closed cargo transport units or "under deck" on a cargo vessel (up to 12 passengers) or on a passenger vessel.

(7) Stowage category "02" means the material may be stowed "on deck" in closed cargo transport units or "under deck" on a cargo vessel (up to 12 passengers) or "on deck" in closed cargo transport units or "under deck" in closed cargo transport units on a passenger vessel.

(8) Stowage category "03" means the material may be stowed "on deck" in closed cargo transport units or "under deck" on a cargo vessel (up to 12 passengers) but the material is prohibited on a passenger vessel.

(9) Stowage category "04" means the material may be stowed "on deck" in closed cargo transport units or "under deck" in closed cargo transports on a cargo vessel (up to 12 passengers) but the material is prohibited on a passenger vessel.

(10) Stowage category "05" means the material may be stowed "on deck" in closed cargo transport units on a cargo

vessel (up to 12 passengers) but the material is prohibited on a passenger vessel.

(1) *Changes to the Table.* (1) Unless specifically stated otherwise in a rule document published in the FEDERAL REGISTER amending the Table—

(i) Such a change does not apply to the shipment of any package filled prior to the effective date of the amendment; and

(ii) Stocks of preprinted shipping papers and package markings may be continued in use, in the manner previously authorized, until depleted or for a one-year period, subsequent to the effective date of the amendment, whichever is less.

(2) Except as otherwise provided in this section, any alteration of a shipping description or associated entry which is listed in the §172.101 Table must receive prior written approval from the Associate Administrator.

(3) The proper shipping name of a hazardous material changed in the May 6, 1997 final rule, in effect on October 1, 1997, only by the addition or omission of the word "compressed," "inhibited," "liquefied" or "solution" may continue to be used to comply with package marking requirements, until January 1, 2003.

§ 172.101 HAZARDOUS MATERIALS TABLE

(1) Sym-bols	(2) Hazardous materials descriptions and proper shipping names	(3) Hazard class or Division	(4) Identi-fication Numbers	(5) PG	(6) Label Codes	(7) Special provisions (§ 172.102)	(8) Packaging (§ 173.***)			(9) Quantity limitations (see §§ 173.27 and 175.75)		(10) Vessel stowage	
							Excep-tions (8A)	Non-bulk (8B)	Bulk (8C)	Passenger aircraft/rail (9A)	Cargo air-craft only (9B)	Loca-tion (10A)	Other (10B)
A	Accelerane, see Nitrosodimethylamine	3	UN1088	II	3	IB2, T4, TP1	202	242	5 L	60 L	E		
	Accumulators, electric, see Batteries, wet etc												
	Accumulators, pressurized, pneumatic or hydraulic (containing non-flammable gas), see Articles pressurized, pneumatic or hydraulic (containing non-flammable gas)												
	Acetal												
	Acetaldehyde												
	Acetaldehyde ammonia												
	Acetaldehyde oxime												
	Acetic acid, glacial or Acetic acid solution, with more than 80 percent acid, by mass												
	Acetic acid solution, not less than 50 percent but not more than 80 percent acid, by mass												
	Acetic acid solution, with more than 10 percent and less than 50 percent acid, by mass												
	Acetic anhydride												
	Acetone												
	Acetone cyanohydrin, stabilized												
	Acetone oils												
	Acetonitrile												
Acetyl acetone peroxide with more than 9 percent by mass active oxygen	3	UN1091	II	3	2, B9, B14, B32, B76, B77, N34, T20, TP2, TP13, TP38, TP45	202	242	5 L	60 L	B	25, 40, 52, 53		
Acetyl benzoyl peroxide, solid, or with more than 40 percent in solution	3	UN1648	II	3	IB2, T4, TP1, TP8	202	242	5 L	60 L	B			
Acetyl bromide	8	UN1716	II	8	B2, IB2, T8, TP2	202	242	1 L	30 L	C	40		

	3	UN1717	II	3, 8	A3, A6, A7, IB1, N34, T8, TP2	150	202	243	1 L	5 L	B	40
Acetyl chloride	Forbiddn											
Acetyl cyclohexanesulfonyl peroxide, with more than 82 percent wetted with less than 12 percent water	Forbiddn											
Acetyl iodide	8	UN1898	II	8	B2, IB2, T7, TP2, TP13	154	202	242	1 L	30 L	C	40
Acetyl methyl carbimol	3	UN2821	III	3	B1, IB3, T2, TP1	150	203	242	60 L	220 L	A	
Acetyl peroxide, solid, or with more than 25 percent in solution	Forbiddn											
Acetylene, dissolved	2.1	UN1001		2.1	N86, N88	None	303	None	Forbiddn	15 kg	D	25, 40, 57
Acetylene (liquefied)	Forbiddn											
Acetylene silver nitrate	Forbiddn											
Acetylene, solvent free	Forbiddn											
Acetylene tetrabromide, see Tetrabromoethane												
Acid butyl phosphate, see Butyl acid phosphate												
Acid, sludge, see Sludge acid												
Acridine	6.1	UN2713	III	6.1	IB8, IP3, T1, TP33	153	213	240	100 kg	200 kg	A	
Acrolein dimer, stabilized	3	UN2607	III	3	B1, IB3, T2, TP1	150	203	242	60 L	220 L	A	40
Acrolein, stabilized	6.1	UN1092	I	6.1, 3	1, B9, B14, B30, B42, B77, T22, TP2, TP7, TP13, TP38, TP44	None	226	244	Forbiddn	Forbiddn	D	40
Acrylamide, solid	6.1	UN2074	III	6.1	IB8, IP3, T1, TP33	153	213	240	100 kg	200 kg	A	12
Acrylamide solution	6.1	UN3426	III	6.1	IB3, T4, TP1	153	203	241	60 L	220 L	A	12
Acrylic acid, stabilized	8	UN2218	II	8, 3	B2, IB2, T7, TP2	154	202	243	1 L	30 L	C	25, 40
Acrylonitrile, stabilized	3	UN1093	I	3, 6.1	B9, T14, TP2, TP13	None	201	243	Forbiddn	30 L	E	40
Actuating cartridge, explosive, see Cartridges, power device												
Adhesives, containing a flammable liquid	3	UN1133	I	3	T11, TP1, TP8, TP27	150	201	243	1 L	30 L	B	
Adiponitrile												
Aerosols, corrosive, Packing Group II or III, (each not exceeding 1 L capacity)	6.1	UN2205	III	3	149, B52, IB2, T4, TP1, TP8	150	173	242	5 L	60 L	B	
Aerosols, flammable, (each not exceeding 1 L capacity)	2.2	UN1950	2.2, 8	B1, B52, IB3, T2, TP1	150	173	242	60 L	220 L	A	
Aerosols, flammable, n.o.s. (engine starting fluid) (each not exceeding 1 L capacity)	2.1	UN1950	2.1	IB3, T3, TP1	153	203	241	75 kg	150 kg	A	25, 87, 126
Aerosols, non-flammable, (each not exceeding 1 L capacity)	2.1	UN1950	2.1	A34	306	None	None	75 kg	150 kg	A	25, 87, 126
Aerosols, flammable, (each not exceeding 1 L capacity)	2.1	UN1950	2.1	N82	306	None	None	Forbiddn	150 kg	A	25, 87, 126
Aerosols, flammable, n.o.s. (engine starting fluid) (each not exceeding 1 L capacity)	2.1	UN1950	2.1	N82	306	304	None	Forbiddn	150 kg	A	25, 87, 126
Aerosols, non-flammable, (each not exceeding 1 L capacity)	2.2	UN1950	2.2	306	None	None	75 kg	150 kg	A	25, 87, 126
Aerosols, poison, Packing Group III (each not exceeding 1 L capacity)	2.2	UN1950	2.2, 6.1	306	None	None	Forbiddn	Forbiddn	A	25, 87, 126

§ 172.101 HAZARDOUS MATERIALS TABLE—Continued

(1) Sym-bols	(2) Hazardous materials descriptions and proper shipping names	(3) Hazard class or Division	(4) Identi-fication Numbers	(5) PG	(6) Label Codes	(7) Special provisions (§ 172.102)	(8) Packaging (§ 173.***)			(9) Quantity limitations (see §§ 173.27 and 175.75)		(10) Vessel stowage	
							Excep-tions (8A)	Non-bulk (8B)	Bulk (8C)	Passenger aircraft/rail (9A)	Cargo air-craft only (9B)	Loca-tion (10A)	Other (10B)
I	Air bag inflators, or Air bag mod-ules, or Seat-belt pretensioners. Air bag inflators, or Air bag mod-ules, or Seat-belt pretensioners. Air, compressed Air, refrigerated liquid, (cryogenic liquid) Air, refrigerated liquid, (cryogenic liquid) non-pressurized Aircraft engines (including turbines), see Engines, internal combustion Aircraft evacuation slides, see Life saving appliances etc. Aircraft hydraulic power unit fuel tank (containing a mixture of an-hydrous hydrazine and monomethyl hydrazine) (M86 fuel) Aircraft survival kits, see Life saving appliances etc. Alcoholates solution, n.o.s., in alco-hol Alcoholic beverages Alcohols, n.o.s.	1.4G	UN0503	II	1.4G	161, A200	None	62	None	Forbidden	75 kg	02	25
		9	UN3268	III	9	160, A200	166	166	166	25 kg	100 kg	A	
		2.2	UN1002		2.2	78	306, 307	302	302	75 kg	150 kg	A	
		2.2	UN1003		2.2,	TP5, TP5, TP22	320	316	318,	Forbidden	Forbidden	D	51
		2.2	UN1003		2.2,	TP5, TP5, TP22	320	316	318,	Forbidden	Forbidden	D	51
		3	UN3165	I	3, 6.1, 8		None	172	None	Forbidden	42 L	E	
		3	UN3274	II	3, 8	IB2	150	202	243	1 L	5 L	B	
		3	UN3065	II	3	24, 149, B1, IB2, T4, TP1	150	202	242	5 L	60 L	A	
		3	UN1987	III	3	24, B1, IB3, N11, T2, TP1	150	203	242	60 L	220 L	A	
		3		I	3	172, T11, TP1, TP8, 4b	TP27	201	243	1 L	30 L	E	
G	Alcohols, flammable, toxic n.o.s. Aldehydes, n.o.s.	3	UN1986	I	3, 6.1	T14, TP2, TP13, TP27	None	201	243	Forbidden	30 L	E	40
		3	UN1989	II	3, 6.1	IB2, T11, TP2, TP27	150	202	243	1 L	60 L	B	40
		3		III	3, 6.1	B1, IB3, T7, TP1, TP28	150	203	242	60 L	220 L	A	
		3		I	3	T11, TP1, TP27	None	201	243	1 L	30 L	E	
		3		II	3	IB2, T7, TP1, TP8, TP28	150	202	242	5 L	60 L	B	
		3		III	3	172, B1, IB3, T4, TP1, TP28	4b, 150	203	242	60 L	220 L	A	
		3		III	3	172, B1, IB3, T4, TP1, TP29	4b, 150	203	242	60 L	220 L	A	
		3		I	3, 6.1	T14, TP2, TP13, TP27	None	201	243	Forbidden	30 L	E	40
		3		II	3, 6.1	IB2, T11, TP2, TP27	150	202	243	1 L	60 L	B	40
		3		III	3, 6.1	B1, IB3, T7, TP1, TP28	150	203	242	60 L	220 L	A	

G	Aldehydes, flammable, toxic, n.o.s.	3	UN1988	I	3, 6.1	B1, IB3, T4, TP1, TP29, TP14, TP2, TP13, TP27	150	203	242	60 L	220 L	A	40		
		6.1	UN2839	II	3, 6.1	IB2, T11, TP2, TP27	None	201	243	Forbiddén	30 L	E	40		
				III	3, 6.1	B1, IB3, T7, TP1, TP28	150	202	1 L	60 L	B	40			
		4.2	UN3206	II	6.1	IB2, T7, TP2	153	202	60 L	60 L	A	12			
				II	4.2, 8	64, A7, IB5, IP2, T3, TP33	None	212	15 kg	50 kg	B				
		G	Alkali metal alcoholates, self-heating, corrosive, n.o.s.	III		III	4.2, 8	64, A7, IB8, IP3, T1, TP33	None	213	242	25 kg	100 kg	B	
				4.3	UN1421	I	4.3	A2, A3, A7, B48, N34	None	201	244	Forbiddén	1 L	D	52
						I	4.3	A2, A3, A7, N34	None	201	244	Forbiddén	1 L	D	40, 52
				4.3	UN3401	I	4.3	IB4, IP1, N40, T9, TP7, TP33	None	211	242	Forbiddén	15 kg	D	52
						II	4.3	A6, A7, A8, A19, A20, IB7, IP2, T3, TP33	151	212	15 kg	50 kg	E	40, 52	
4.3	UN3482			I	4.3, 3	A2, A3, A7	None	201	244	Forbiddén	1 L	D	52		
				I	4.3	A2, A3, A7	None	201	244	Forbiddén	1 L	D	52		
G	Alkali metal dispersions, flammable or Alkaline earth metal dispersions, flammable Alkali metal dispersions earth metal dispersions Alkaline corrosive liquids, n.o.s., see Caustic alkali liquids, n.o.s. Alkaline earth metal alcoholates, n.o.s.			4.2	UN3205	II	4.2	65, A7, IB6, IP2, T3, TP33	None	212	241	15 kg	50 kg	B	
				4.3	UN1393	III	4.2	65, A7, IB8, IP3, T1, TP33	None	213	241	25 kg	100 kg	B	
						II	4.3	A19, IB7, IP2, T3, TP33	151	212	15 kg	50 kg	E	52	
		4.3	UN1392	I	4.3	A19, N34, N40	None	201	244	Forbiddén	1 L	E	40, 52		
				I	4.3	A19, N34, N40, T9, TP7, TP33	None	211	242	Forbiddén	15 kg	D	52		
		6.1	UN3140	I	6.1	A4, T14, TP2, TP27	None	201	243	1 L	30 L	A			
				II	6.1	IB2, T11, TP2, TP27	153	202	5 L	60 L	A				
		6.1	UN1544	III	6.1	IB3, T7, TP1, TP28	153	203	60 L	220 L	A				
				I	6.1	IB7, IP1, T6, TP33	None	211	5 kg	50 kg	A				
		8	UN2584	II	6.1	IB8, IP2, IP4, T3, TP33	153	212	25 kg	100 kg	A				
II	6.1			IB8, IP3, T1, TP33	153	213	100 kg	200 kg	A						
8	UN2586	III	8	B2, IB2, T8, TP2, TP13	154	202	1 L	30 L	B						
		III	8	IB3, T4, TP1	154	203	5 L	60 L	B						
8	UN2583	II	8	IB8, IP2, IP4, T3, TP33	154	212	15 kg	50 kg	A						

§ 172.101 HAZARDOUS MATERIALS TABLE—Continued

(1) Sym-bols	(2) Hazardous materials descriptions and proper shipping names	(3) Hazard class or Division	(4) Identi-fication Numbers	(5) PG	(6) Label Codes	(7) Special provisions (§ 172.102)	(8) Packaging (§ 173.***)			(9) Quantity limitations (see §§ 173.27 and 175.75)		(10) Vessel stowage		
							Excep-tions (8A)	Non-bulk (8B)	Bulk (8C)	Passenger aircraft/rail (9A)	Cargo air-craft only (9B)	Loca-tion (10A)	Other (10B)	
	Alkyl sulfonic acids, solid or Aryl sulfonic acids, solid with not more than 5 percent free sulfonic acid	8	UN2585	III	8	IB8, IP3, T1, TP33	154	213	240	25 kg	100 kg	A		
	Alkylphenols, liquid, n.o.s. (including C2-C12 homologues)	8	UN3145	I	8	A6, T14, TP2	None	201	243	0.5 L	2.5 L	B		
	Alkylphenols, solid, n.o.s. (including C2-C12 homologues)	8	UN2430	III	8	IB2, T11, TP2, TP27 IB3, T7, TP1, TP28 IB7, IP1, T6, TP33	154 154 None	202 203 241 242	242	1 L 5 L 1 kg	30 L 60 L 25 kg	B A B		
	Alkylsulfuric acids	8	UN2571	III	8	IB8, IP2, IP4, T3, TP33 IB8, IP3, T1, TP33 B2, IB2, T8, TP2, TP13, TP28	154 154 154	212 213 202	240 240 242	15 kg 25 kg 1 L	50 kg 100 kg 30 L	B A C		14
	Allethrin, see Pesticides, liquid, toxic, n.o.s.	3	UN2333	II	3, 6.1	IB2, T7, TP1, TP13	150	202	243	1 L	60 L	E	40	
	Allyl acetate	6.1	UN1098	I	6.1, 3	2, B9, B14, B32, B77, T20, TP2, TP13, TP38, TP45	None	227	244	Forbidden	Forbidden	D	40	
	Allyl bromide	3	UN1099	I	3, 6.1	T14, TP2, TP13	None	201	243	Forbidden	30 L	B	40	
	Allyl chloride	3	UN1100	I	3, 6.1	T14, TP2, TP13	None	201	243	Forbidden	30 L	E	40	
	Allyl chlorocarbonate, see Allyl chloroformate													
	Allyl chloroformate	6.1	UN1722	I	6.1, 3, 8	2, B9, B14, B32, N41, T20, TP2, TP13, TP38, TP45	None	227	244	Forbidden	Forbidden	D	40	
	Allyl ethyl ether	3	UN2335	II	3, 6.1	IB2, T7, TP1, TP13	150	202	243	1 L	60 L	E	40	
	Allyl formate	3	UN2336	I	3, 6.1	T14, TP2, TP13	None	201	243	Forbidden	30 L	E	40	
	Allyl glycidyl ether	3	UN2219	III	3	B1, IB3, T2, TP1	150	203	242	60 L	220 L	A	40	
	Allyl iodide	3	UN1723	II	3, 8	A3, A6, IB1, N34, T7, TP2, TP13	150	202	243	1 L	5 L	B	40	
	Allyl isothiocyanate, stabilized	6.1	UN1545	II	6.1, 3	A3, A7, IB2, T7, TP2	None	202	243	Forbidden	60 L	D	40	
	Allylamine	6.1	UN2334	I	6.1, 3	2, B9, B14, B32, T20, TP2, TP13, TP38, TP45	None	227	244	Forbidden	Forbidden	D	40	
	Allyltrichlorosilane, stabilized	8	UN1724	II	8, 3	A7, B2, B6, N34, T10, TP2, TP7, TP13	None	206	243	Forbidden	30 L	C	40	
	Aluminum borohydride or Aluminum borohydride in devices	4.2	UN2870	I	4.2, 4.3	B11, T21, TP7, TP33	None	181	244	Forbidden	Forbidden	D		

§ 172.101 HAZARDOUS MATERIALS TABLE—Continued

(1) Sym-bols	(2) Hazardous materials descriptions and proper shipping names	(3) Hazard class or Division	(4) Identi-fication Numbers	(5) PG	(6) Label Codes	(7) Special provisions (§ 172.102)	(8) Packaging (§ 173.***)			(9) Quantity limitations (see §§ 173.27 and 175.75)		(10) Vessel stowage	
							(8A) Excep-tions	(8B) Non-bulk	(8C) Bulk	(9A) Passenger aircraft/rail	(9B) Cargo air-craft only	Loca-tion	Other
G	Amines, liquid, corrosive, n.o.s., or Polyamines, liquid, corrosive, n.o.s.	8	UN2735	II I	8, 3 8	IB2, T11, TP2, TP27 A3, A6, B10, N34, T14, TP2, TP27	None None	202 201	243 243	1 L 0.5 L	30 L 2.5 L	A A	52 52
G	Amines, solid, corrosive, n.o.s., or Polyamines, solid, corrosive n.o.s.	8	UN3259	II III I	8 8 8	B2, IB2, T11, TP1, TP27 IB3, T7, TP1, TP28 IB7, IP1, T6, TP33	154 154 None	202 203 211	242 241 242	1 L 5 L 1 kg	30 L 60 L 25 kg	A A A	52 52 52
	2-Amino-4-chlorophenol	6.1	UN2673	III	8	IB8, IP2, IP4, T3, TP33	154	212	240	15 kg	50 kg	A	52
	2-Amino-5-diethylaminopentane	6.1	UN2946	III	6.1	IB8, IP2, IP4, T3, TP33	153	212	242	25 kg	100 kg	A	52
	2-Amino-4,6-Dinitrophenol, wetted with not less than 20 percent water by mass	4.1	UN3317	I	4.1	IB3, T4, TP1 23, A8, A19, A20, N41	153 None	203 211	241	60 L 1 kg	220 L 15 kg	A E	28, 36
+	2-(2-Aminoethoxy) ethanol N-Aminoethylpiperazine Aminophenols (o-; m-; p-) Aminopropyllethanolamine, see Amines, etc n-Aminopropylmorpholine, see Amines, etc Aminopyridines (o-; m-; p-)	8 8	UN3055 UN2815	III III	8 8	IB3, T4, TP1 IB3, T4, TP1	154 154	203 203	241 241	5 L 5 L	60 L 60 L	A A	12
I	Ammonia, anhydrous	2.3	UN1005	II	6.1	IB8, IP2, IP4, T3, TP33	153	212	242	25 kg	100 kg	B	12, 40, 52
D	Ammonia, anhydrous	2.2	UN1005	2.2	2.3, 8	4, N87, T50	None	304	314, 315	Forbidden	Forbidden	D	40, 52, 57
I	Ammonia solution, relative density less than 0.880 at 15 degrees C in water, with more than 50 percent ammonia	2.3	UN3318	2.3	2.3, 8	13, T50	None	304	314, 315	Forbidden	Forbidden	D	40, 52, 57
D	Ammonia solution, relative density less than 0.880 at 15 degrees C in water, with more than 50 percent ammonia	2.2	UN3318	2.2	2.2	13, T50	None	304	314, 315	Forbidden	Forbidden	D	40, 52, 57

Ammonia solutions, relative density less than 0.880 at 15 degrees C in water, with more than 35 percent ammonia but not more than 50 percent ammonia	2.2	UN2073		2.2	N87	306	304	314, 315	Forbidden	150 kg	E	40, 52, 57
Ammonia solutions, relative density between 0.880 and 0.957 at 15 degrees C in water, with more than 10 percent but not more than 35 percent ammonia	8	UN2672	III	8	336, IB3, IP8, T7, TP1	154	203	241	5L	60L	A	40, 52, 85
Ammonium arsenate	6.1	UN1546	II	6.1	IB8, IP2, IP4, T3, TP33	153	212	242	25 kg	100 kg	A	53
Ammonium azide	Forbidden											
Ammonium bifluoride, solid, see Ammonium hydrogen difluoride, solid												
Ammonium bifluoride solution, see Ammonium hydrogen difluoride, solution												
Ammonium bromate	Forbidden											
Ammonium chlorate	5.1	UN1439	II	5.1	IB8, IP2, IP4, T3, TP33	152	212	242	5 kg	25 kg	A	52
Ammonium dichromate	6.1	UN1843	II	6.1	IB8, IP2, IP4, T3, TP33	153	212	242	25 kg	100 kg	B	36, 65, 66, 77
Ammonium dinitro-o-cresolate, solid	6.1	UN3424	II	6.1	IB2, T7, TP2	153	202	243	5 L	60 L	B	36, 66, 78, 91
Ammonium dinitro-o-cresolate solution												
Ammonium fluoride	6.1	UN2505	III	6.1	IB2, T7, TP2	153	203	241	60 L	220 L	A	36, 66, 78, 91
Ammonium fluorsulfate	6.1	UN2854	III	6.1	IB8, IP3, T1, TP33	153	213	240	100 kg	200 kg	A	52
Ammonium fulminate	Forbidden											
Ammonium hydrogen sulfate	8	UN2506	II	8	IB8, IP3, T1, TP33	153	213	240	100 kg	200 kg	A	52
Ammonium hydrogendifluoride, solid	8	UN1727	II	8	IB8, IP2, IP4, T3, TP33	154	212	240	15 kg	50 kg	A	40
Ammonium hydrogendifluoride, solution	8	UN2817	II	8, 6.1	IB8, IP2, IP4, N34, T3, TP33	154	212	240	15 kg	50 kg	A	25, 40, 52
Ammonium hydrosulfide, solution, see Ammonium sulfide solution												
Ammonium hydroxide, see Ammonia solutions, etc												
Ammonium metavanadate	6.1	UN2859	II	6.1	IB2, N34, T8, TP2, TP13	154	202	243	1 L	30 L	B	40
Ammonium nitrate based fertilizer	5.1	UN2067	III	5.1	IB3, N3, T4, TP1, TP13	154	203	241	5 L	60 L	B	40, 95
Ammonium nitrate based fertilizer	9	UN2071	III	9	IB8, IP2, IP4, T3, TP33	155	213	240	25 kg	100 kg	A	44, 89, 100, 141
					52, 150, B120, IB8, IP3, T1, TP33	152	213	240	25 kg	100 kg	B	25, 59, 60, 66, 117
					132, IB8, IP3	155	213	240	200 kg	200 kg	A	

D

A W

§ 172.101 HAZARDOUS MATERIALS TABLE—Continued

(1) Sym-bols	(2) Hazardous materials descriptions and proper shipping names	(3) Hazard class or Division	(4) Identi-fication Numbers	(5) PG	Label Codes	(7) Special provisions (§ 172.102)	(8) Packaging (§ 173.***)			(9) Quantity limitations (see §§ 173.27 and 175.75)			(10) Vessel stowage	
							Excep-tions (8A)	Non-bulk (8B)	Bulk (8C)	Passenger aircraft/rail (9A)	Cargo air-craft only (9B)	Other Loca-tion (10A)	(10B)	
	Ammonium nitrate emulsion or Am-monium nitrate suspension or Ammonium nitrate gel, inter-mediate for blasting explosives	5.1	UN3375	II	5.1	147, 163	None	214	214	Forbidden	Forbidden	D	25, 59, 60, 66, 124	
D	Ammonium nitrate-fuel oil mixture containing only prilled ammonium nitrate and fuel oil	1.5D	NA0331	II	1.5D	None	62	None	Forbidden	Forbidden	03	25, 19E	
	Ammonium nitrate, liquid (hot con-centrated solution)	5.1	UN2426		5.1	B5, T7	None	None	243	Forbidden	Forbidden	D	59, 60	
	Ammonium nitrate, with more than 0.2 percent combustible sub-stances, including any organic substance calculated as carbon, to the exclusion of any other added substance	1.1D	UN0222	II	1.1D	None	62	None	Forbidden	Forbidden	04	25, 19E	
	Ammonium nitrate, with not more than 0.2% total combustible ma-terial, including any organic sub-stance, calculated as carbon to the exclusion of any other added substance	5.1	UN1942	III	5.1	A1, A29, B120, IB8, IP3, T1, TP33	152	213	240	25 kg	100 kg	A	25, 59, 60, 116	
	Ammonium nitrite	Forbidden												
	Ammonium perchlorate	1.1D	UN0402	II	1.1D	107	None	62	None	Forbidden	Forbidden	04	25, 19E	
	Ammonium perchlorate	5.1	UN1442	II	5.1	107, A9, IB6, IP2, T3, TP33	152	212	242	5 kg	25 kg	E	58, 69	
	Ammonium permanganate	Forbidden												
	Ammonium persulfate	5.1	UN1444	III	5.1	A1, A29, IB8, IP3, T1, TP33	152	213	240	25 kg	100 kg	A		
	Ammonium picrate, dry or wetted with less than 10 percent water, by mass	1.1D	UN0004	II	1.1D	None	62	None	Forbidden	Forbidden	04	25, 5E, 19E	
	Ammonium picrate, wetted with not less than 10 percent water, by mass	4.1	UN1310	I	4.1	23, A2, N41	None	211	None	0.5 kg	0.5 kg	D	28, 36	
	Ammonium polysulfide, solution	8	UN2818	II	8, 6.1	IB2, T7, TP2, TP13	154	202	243	1 L	30 L	B	12, 40, 52	

Pipeline and Haz. Matls. Safety Admin., DOT

§ 172.101

Ammonium polyvanadate	6.1	UN2861	III	8, 6.1	IB3, T4, TP1, TP13	154	203	241	5 L	60 L	B	12, 40, 52
Ammonium silicofluoride, see Ammonium fluorosilicate											A	44, 89, 100, 141
Ammonium sulfide solution	8	UN2683	II	8, 6.1, 3	IB1, T7, TP2, TP13	154	202	243	1 L	30 L	B	12, 22, 52, 100
Ammunition, blank, see Cartridges for weapons, blank												
Ammunition, illuminating with or without burster, expelling charge or propelling charge	1.2G	UN0171	II	1.2G			62	62	Forbidden	Forbidden	03	25
Ammunition, illuminating with or without burster, expelling charge or propelling charge	1.3G	UN0254	II	1.3G			62	62	Forbidden	Forbidden	03	25
Ammunition, illuminating with or without burster, expelling charge or propelling charge	1.4G	UN0297	II	1.4G			62	62	Forbidden	75 kg	02	25
Ammunition, incendiary liquid or gel, with burster, expelling charge or propelling charge	1.3J	UN0247	II	1.3J			62	None	Forbidden	Forbidden	05	25, 23E
Ammunition, incendiary (water-activated contrivances) with burster, expelling charge or propelling charge see Contrivances, water-activated, etc.												
Ammunition, incendiary, white phosphorus, with burster, expelling charge or propelling charge	1.2H	UN0243	II	1.2H			62	62	Forbidden	Forbidden	05	25, 14E, 15E, 17E
Ammunition, incendiary, white phosphorus, with burster, expelling charge or propelling charge	1.3H	UN0244	II	1.3H			62	62	Forbidden	Forbidden	05	25, 14E, 15E, 17E
Ammunition, incendiary with or without burster, expelling charge, or propelling charge	1.2G	UN0009	II	1.2G			62	62	Forbidden	Forbidden	03	25
Ammunition, incendiary with or without burster, expelling charge, or propelling charge	1.3G	UN0010	II	1.3G			62	62	Forbidden	Forbidden	03	25
Ammunition, incendiary with or without burster, expelling charge or propelling charge	1.4G	UN0300	II	1.4G			62	62	Forbidden	75 kg	02	25
Ammunition, practice	1.4G	UN0362	II	1.4G			62	62	Forbidden	75 kg	02	25
Ammunition, practice	1.3G	UN0488	II	1.3G			62	62	Forbidden	Forbidden	03	25
Ammunition, proof	1.4G	UN0363	II	1.4G			62	62	Forbidden	75 kg	02	25
Ammunition, rocket, see Warheads, rocket etc												

§ 172.101 HAZARDOUS MATERIALS TABLE—Continued

(1) Sym-bols	(2) Hazardous materials descriptions and proper shipping names	(3) Hazard class or Division	(4) Identi-fication Numbers	(5) PG	(6) Label Codes	(7) Special provisions (§ 172.102)	(8) Packaging (§ 173.***)			(9) Quantity limitations (see §§ 173.27 and 175.75)		(10) Vessel stowage	
							Excep-tions (8A)	Non-bulk (8B)	Bulk (8C)	Passenger aircraft/rail (9A)	Cargo air-craft only (9B)	Loca-tion (10A)	Other (10B)
(1)	<i>Ammunition, SA (small arms), see Cartridges for weapons, etc</i> <i>Ammunition, smoke (water-acti-vated contrivances), white phos-phorus, with burster, expelling charge or propelling charge, see Contrivances, water-activated, etc. (UN 0248)</i> <i>Ammunition, smoke (water-acti-vated contrivances), without white phosphorus or phosphides, with burster, expelling charge or pro-pelling charge, see Contrivances, water-activated, etc. (UN 0249)</i> <i>Ammunition smoke, white phos-phorus with burster, expelling charge, or propelling charge</i>	1.2H	UN0245	II	1.2H	62	62	62	Forbidden	Forbidden	05	25, 14E, 15E, 17E
	<i>Ammunition, smoke, white phos-phorus with burster, expelling charge, or propelling charge</i>	1.3H	UN0246	II	1.3H	62	62	62	Forbidden	Forbidden	05	25, 14E, 15E, 17E
	<i>Ammunition, smoke with or without burster, expelling charge or pro-pelling charge</i>	1.2G	UN0015	II	1.2G	62	62	62	Forbidden	Forbidden	03	25, 17E
	<i>Ammunition, smoke with or without burster, expelling charge or pro-pelling charge</i>	1.3G	UN0016	II	1.3G	62	62	62	Forbidden	Forbidden	03	25, 17E
	<i>Ammunition, smoke with or without burster, expelling charge or pro-pelling charge</i>	1.4G	UN0303	II	1.4G	62	62	62	Forbidden	75 kg	02	25, 14E, 15E, 17E
	<i>Ammunition, sporting, see Car-tridges for weapons, etc. (UN 0012; UN 0328; UN 0339)</i>												

UN number	Proper shipping name	Class	Division	Subdivision	Label	Quantity	Special provisions	Other	Exemption	Notes
6.1 UN2017	Ammunition, tear-producing, non-explosive, without burster or expelling charge, non-fuzed	II	6.1, 8					None	212	13, 40
1.2G UN0018	Ammunition, tear-producing with burster, expelling charge or propelling charge	II	1.2G, 8, 6.1					62	62	25, 17E
1.3G UN0019	Ammunition, tear-producing with burster, expelling charge or propelling charge	II	1.3G, 8, 6.1					62	62	25, 17E
1.4G UN0301	Ammunition, tear-producing with burster, expelling charge or propelling charge	II	1.4G, 8, 6.1					62	62	25, 14E, 15E, 17E
6.1 UN2016	Ammunition, toxic, non-explosive, without burster or expelling charge, non-fuzed	II	6.1					None	212	13, 40
1.2K UN0020	Ammunition, toxic (water-activated contrivances), with burster, expelling charge or propelling charge, see Contrivances, water-activated, etc	II	1.2K, 6.1					None	62	25, 14E, 15E, 17E
1.3K UN0021	Ammunition, toxic with burster, expelling charge or propelling charge	II	1.3K, 6.1					None	62	25, 14E, 15E, 17E
3 UN1104	Amyl acetates	III	3		B1, IB3, T2, TP1	150		242	203	220 L
8 UN2819	Amyl acid phosphate	III	8		IB3, T4, TP1	154		241	203	60 L
3 UN2620	Amyl butyrate	III	3		B1, IB3, T2, TP1	150		242	203	220 L
3 UN1107	Amyl chloride	II	3		IB2, T4, TP1	150		242	202	60 L
3 UN1109	Amyl formates	III	3		B1, IB3, T2, TP1	150		242	203	220 L
3 UN1111	Amyl mercaptan	II	3		A3, A6, IB2, T4, TP1	None		242	202	60 L
3 UN1110	n-Amyl methyl ketone	III	3		B1, IB3, T2, TP1	150		242	203	220 L
3 UN1112	Amyl nitrate	III	3		B1, IB3, T2, TP1	150		242	202	220 L
3 UN1113	Amyl nitrite	II	3, 8		IB2, T7, TP1	150		243	202	60 L
3 UN1106	Amylamines	III	3, 8		B1, IB3, T4, TP1	150		242	203	5 L
8 UN1728	Amyltrichlorosilane	II	8		A7, B2, B6, N34, T10, TP2, TP7, TP13	None		242	206	30 L
	Anhydrous ammonia, see Ammonia, anhydrous									
	Anhydrous hydrofluoric acid, see Hydrogen fluoride, anhydrous									
6.1 UN1547	Aniline	II	6.1		IB2, T7, TP2	153		243	202	60 L
6.1 UN1548	Aniline hydrochloride	III	6.1		IB8, IP3, T1, TP33	153		240	213	100 kg
	Aniline oil, see Aniline									
6.1 UN2431	Anisidines	III	6.1		IB3, T4, TP1	153		241	203	220 L

+

§ 172.101 HAZARDOUS MATERIALS TABLE—Continued

(1) Sym-bols	(2) Hazardous materials descriptions and proper shipping names	(3) Hazard class or Division	(4) Identi-fication Numbers	(5) PG	(6) Label Codes	(7) Special provisions (§ 172.102)	(8) Packaging (§ 173.***)			(9) Quantity limitations (see §§ 173.27 and 175.75)		(10) Vessel stowage		
							Excep-tions (8A)	Non-bulk (8B)	Bulk (8C)	Passenger aircraft/rail (9A)	Cargo air-craft only (9B)	Loca-tion (10A)	Other (10B)	
														(8A)
	Anisole	3	UN2222	III	3	B1, IB3, T2, TP1	150	203	242	60 L	220 L	A		
			UN1729	II	8		154	212	240	15 kg	50 kg	A		
G	<i>Anti-freeze, liquid, see Flammable liquids, n.o.s.</i> <i>Antimonous chloride, see Antimony trichloride</i>	6.1	UN3141	III	6.1	35, IB3, T7, TP1, TP28	153	203	241	60 L	220 L	A		
			UN1549	III	6.1		153	213	240	100 kg	200 kg	A		
G	Antimony compounds, inorganic, liquid, n.o.s. Antimony compounds, inorganic, solid, n.o.s. Antimony lactate Antimony pentachloride, liquid Antimony pentachloride, solutions Antimony pentafluoride	6.1	UN1550	III	6.1	IB8, IP3, T1, TP33	153	213	240	100 kg	200 kg	A		
			UN1730	II	8		None	202	242	1 L	30 L	C	40	
			UN1731	II	8		B2, IB2, T7, TP2	202	242	1 L	30 L	C	40	
			UN1731	III	8		IB3, T4, TP1	203	241	5 L	60 L	C	40	
			UN1732	II	8, 6.1		A3, A6, A7, A10, IB2, N3, N36, T7, TP2	202	243	Forbidden	30 L	30 L	D	44, 89, 100, 141
			UN1551	III	6.1		IB8, IP3, T1, TP33	213	240	100 kg	200 kg	200 kg	A	
	Antimony powder <i>Antimony sulfide and a chlorate, mixtures of</i> <i>Antimony sulfide, solid, see Antimony compounds, inorganic, n.o.s.</i>	6.1	UN2871	III	6.1	IB8, IP3, T1, TP33	153	213	240	100 kg	200 kg	A		
			Forbidden											
	Antimony trichloride, liquid Antimony trichloride, solid <i>Aqua ammonia, see Ammonia solution, etc</i>	8	UN1733	II	8	B2, IB2	154	202	242	1 L	30 L	C	40	
			UN1733	II	8		154	212	240	15 kg	50 kg	A	40	
	Argon, compressed Argon, refrigerated liquid (<i>cryogenic liquid</i>)	2.2	UN1006	2.2	2.2	T75, TP5	306, 307	302	314, 315	75 kg	150 kg	A		
			UN1951	2.2	2.2		320	316	318	50 kg	500 kg	D		
	Arsenic Arsenic acid, liquid Arsenic acid, solid Arsenic bromide	6.1	UN1558	II	6.1	IB8, IP2, IP4, T3, TP33	153	212	242	25 kg	100 kg	A		
			UN1553	I	6.1		None	201	243	1 L	30 L	B	46	
			UN1554	II	6.1		IB8, IP2, IP4, T3, TP33	212	242	100 kg	100 kg	A		
			UN1555	II	6.1		153	212	242	25 kg	25 kg	A	12, 40	

G	Arsenic chloride, see Arsenic tri-chloride	6.1	UN1556	I	6.1	T14, TP2, TP13, TP27	None	201	243	1 L	30 L	B	40, 137
	Arsenic compounds, liquid, n.o.s., inorganic, including arsenates, n.o.s.; arsenites, n.o.s.; arsenic sulfides, n.o.s.; and organic compounds of arsenic, n.o.s	6.1	UN1557	II	6.1	IB2, T11, TP2, TP13, TP27	153	202	243	5 L	60 L	B	40, 137
	Arsenic compounds, solid, n.o.s., inorganic, including arsenates, n.o.s.; arsenites, n.o.s.; arsenic sulfides, n.o.s.; and organic compounds of arsenic, n.o.s	6.1	UN1557	III	6.1	IB3, T7, TP2, TP28	153	203	241	60 L	220 L	B	40, 137
	Arsenic pentoxide	6.1	UN1559	II	6.1	IB8, IP2, IP4, T3, TP33	153	212	242	25 kg	100 kg	A	137
	Arsenic sulfide and a chlorate, mixtures of	Forbidden											
	Arsenic trichloride	6.1	UN1560	I	6.1	2, B9, B14, B32, T20, TP2, TP13, TP38, TP45	None	227	244	Forbidden	Forbidden	B	40
	Arsenic trioxide	6.1	UN1561	II	6.1	IB8, IP2, IP4, T3, TP33	153	212	242	25 kg	100 kg	A	
	Arsenic dust	6.1	UN1562	II	6.1	IB8, IP2, IP4, T3, TP33	153	212	242	25 kg	100 kg	A	
	Arsenical pesticides, liquid, flammable, toxic, flash point less than 23 degrees C	3	UN2760	I	3, 6.1	T14, TP2, TP13, TP27	None	201	243	Forbidden	30 L	B	40
	Arsenical pesticides, liquid, toxic	6.1	UN2994	II	3, 6.1	IB2, T11, TP2, TP13, TP27	150	202	243	1 L	60 L	B	40
G	Arsenical pesticides, liquid, toxic, flammable, flash point not less than 23 degrees C	6.1	UN2993	III	6.1	T14, TP2, TP13, TP27	153	203	241	60 L	220 L	A	40
	Arsenous acid, solid, see Arsenic trioxide												
	Arsenous acid, solid, see Arsenic trioxide												
	Arsenous and mercuric iodide solution, see Arsenic compounds, liquid, n.o.s.												
	Arsenous acid, solid, see Arsenic trioxide												
	Arsenous acid, solid, see Arsenic trioxide												
	Arsenous acid, solid, see Arsenic trioxide												
	Arsenous acid, solid, see Arsenic trioxide												
	Arsenous acid, solid, see Arsenic trioxide												
	Arsenous acid, solid, see Arsenic trioxide												

§ 172.101 HAZARDOUS MATERIALS TABLE—Continued

(1) Sym-bols	(2) Hazardous materials descriptions and proper shipping names	(3) Hazard class or Division	(4) Identi-fication Numbers	(5) PG	(6) Label Codes	(7) Special provisions (§ 172.102)	(8) Packaging (§ 173.***)			(9) Quantity limitations (see §§ 173.27 and 175.75)		(10) Vessel stowage	
							Excep-tions (8A)	Non-bulk (8B)	Bulk (8C)	Passenger aircraft/rail (9A)	Cargo air-craft only (9B)	Loca-tion (10A)	Other (10B)
	Arsine	2.3	UN2188		2.3, 2.1	1	None	192	245	Forbidden	Forbidden	D	40
	Articles, explosive, extremely insen-sitive or Articles, EEI	1.6N	UN0486	II	1.6N		None	62	None	Forbidden	Forbidden	07	
	Articles, explosive, extremely insen-sitive or Articles, EEI	1.6N											
G	Ammunition, toxic with burster, ex-pelling charge or propelling charge	1.2K	UN0020	II	1.2K, 6.1			62	None	Forbidden	Forbidden	05	25, 14E, 15E, 17E
G	Ammunition, toxic with burster, ex-pelling charge or propelling charge	1.3K	UN0021	II	1.3K, 6.1			62	None	Forbidden	Forbidden	05	25, 14E, 15E, 17E
G	Articles, explosive, n.o.s	1.4S	UN0349	II	1.4S	101	None	62	None	25 kg	100 kg	01	25
G	Articles, explosive, n.o.s	1.4B	UN0350	II	1.4B	101	None	62	None	Forbidden	Forbidden	05	25
G	Articles, explosive, n.o.s	1.4C	UN0351	II	1.4C	101	None	62	None	Forbidden	75 kg	02	25
G	Articles, explosive, n.o.s	1.4D	UN0352	II	1.4D	101	None	62	None	Forbidden	75 kg	02	25
G	Articles, explosive, n.o.s	1.4G	UN0353	II	1.4G	101	None	62	None	Forbidden	75 kg	02	25
G	Articles, explosive, n.o.s	1.1L	UN0354	II	1.1L	101	None	62	None	Forbidden	Forbidden	02	25, 14E, 15E
G	Articles, explosive, n.o.s	1.2L	UN0355	II	1.2L	101	None	62	None	Forbidden	Forbidden	05	15E, 25, 14E, 15E
G	Articles, explosive, n.o.s	1.3L	UN0356	II	1.3L	101	None	62	None	Forbidden	Forbidden	05	15E, 25, 14E, 15E
G	Articles, explosive, n.o.s	1.1C	UN0462	II	1.1C	101	None	62	None	Forbidden	Forbidden	04	25
G	Articles, explosive, n.o.s	1.1D	UN0463	II	1.1D	101	None	62	None	Forbidden	Forbidden	04	25
G	Articles, explosive, n.o.s	1.1E	UN0464	II	1.1E	101	None	62	None	Forbidden	Forbidden	04	25
G	Articles, explosive, n.o.s	1.1F	UN0465	II	1.1F	101	None	62	None	Forbidden	Forbidden	05	25
G	Articles, explosive, n.o.s	1.2C	UN0466	II	1.2C	101	None	62	None	Forbidden	Forbidden	04	25
G	Articles, explosive, n.o.s	1.2D	UN0467	II	1.2D	101	None	62	None	Forbidden	Forbidden	04	25
G	Articles, explosive, n.o.s	1.2E	UN0468	II	1.2E	101	None	62	None	Forbidden	Forbidden	04	25
G	Articles, explosive, n.o.s	1.2F	UN0469	II	1.2F	101	None	62	None	Forbidden	Forbidden	05	25
G	Articles, explosive, n.o.s	1.3C	UN0470	II	1.3C	101	None	62	None	Forbidden	Forbidden	04	25
G	Articles, explosive, n.o.s	1.4E	UN0471	II	1.4E	101	None	62	None	Forbidden	75 kg	03	25

Pipeline and Haz. Matls. Safety Admin., DOT

§ 172.101

G	Articles, explosive, n.o.s	1.4F	UN0472	II	1.4F	101	None	62	None	Forbidden No limit	05	25
	Articles, pressurized pneumatic, or hydraulic containing non-flammable gas	2.2	UN3164		2.2	306	306	302, 304	None	Forbidden No limit	A	
	Articles, pyrophoric	1.2L	UN0380	II	1.2L	None	62	None	Forbidden	05	25, 14E, 15E, 17E
	Articles, pyrotechnic for technical purposes	1.1G	UN0428	II	1.1G	None	62	None	Forbidden	03	25
	Articles, pyrotechnic for technical purposes	1.2G	UN0429	II	1.2G	None	62	None	Forbidden	03	25
	Articles, pyrotechnic for technical purposes	1.3G	UN0430	II	1.3G	None	62	None	Forbidden	03	25
	Articles, pyrotechnic for technical purposes	1.4G	UN0431	II	1.4G	None	62	None	Forbidden	02	25
	Articles, pyrotechnic for technical purposes	1.4S	UN0432	II	1.4S	None	62	None	75 kg 100 kg	01	25
D	Asbestos	9	NA2212	III	9	156, IB8, IP2, IP4	155	216	240	200 kg	A	34, 40
D	Ascaridole (organic peroxide)	Forbidden										
D	Asphalt, at or above its flash point	3	NA1999	III	3	IB3, T1, TP3	150	203	247	Forbidden	D	
	Asphalt, cut back, see Tars, liquid, etc											
	Automobile, motorcycle, tractor, other self-propelled vehicle, engine, or other mechanical apparatus, see Vehicles or Battery etc											
A,	Aviation regulated liquid, n.o.s	9	UN3334	9	A35, A189	155	204	450 L	450 L	A	
G												
A,	Aviation regulated solid, n.o.s	9	UN3335	9	A35	155	204	400 kg	400 kg	A	
G												
	Azaurolic acid (salt of) (dry)	Forbidden										
	Azido guanidine picrate (dry)	Forbidden										
	5-Azido-1-hydroxy tetrazole	Forbidden										
	Azido hydroxy tetrazole (mercury and silver salts)	Forbidden										
	3-Azido-1,2-Propylene glycol dinitrate	Forbidden										
	Azidothiocarbonic acid	Forbidden										
	Azidoethyl nitrate	Forbidden										
	1-Aziridinylphosphine oxide-(tris), see Tris-(1-aziridinyl) phosphine oxide, solution											
	Azodicarbonamide	4.1	UN3242	II	4.1	38, IB8, T3, TP33	151	223	240	Forbidden	D	2, 52, 53, 74
	Azotetrazole (dry)	Forbidden										
	Barium	4.3	UN1400	II	4.3	A19, IB7, IP2, T3, TP33	151	212	241	15 kg	E	52
	Barium alloys, pyrophoric	4.2	UN1854	I	4.2	T21, TP7, TP33	None	181	None	Forbidden	D	

§ 172.101 HAZARDOUS MATERIALS TABLE—Continued

(1) Sym-bols	(2) Hazardous materials descriptions and proper shipping names	(3) Hazard class or Division	(4) Identi-fication Numbers	(5) PG	(6) Label Codes	(7) Special provisions (§ 172.102)	(8) Packaging (§ 173.***)			(9) Quantity limitations (see §§ 173.27 and 175.75)		(10) Vessel stowage	
							Excep-tions (8A)	Non-bulk (8B)	Bulk (8C)	Passenger aircraft/rail (9A)	Cargo air-craft only (9B)	Loca-tion (10A)	Other (10B)
G	Barium azide, dry or wetted with less than 50 percent water, by mass	1.1A	UN0224	II	1.1A, 6.1	111, 117	None	62	Forbidden	Forbidden	05	25	
	Barium azide, wetted with not less than 50 percent water, by mass	4.1	UN1571	I	4.1,	162, A2	None	182	None	0.5 kg	D	28	
	Barium bromate	5.1	UN2719	II	5.1,	IB8, IP2, IP4, T3, TP33	152	212	242	5 kg	A	56, 58	
	Barium chlorate, solid	5.1	UN1445	II	5.1,	A9, IB6, IP2, N34, T3, TP33	152	212	242	5 kg	A	56, 58	
	Barium chlorate, solution	5.1	UN3405	II	5.1,	A9, IB2, N34, T4, TP1	152	202	243	1 L	A	56, 58, 133	
						A9, IB2, N34, T4, TP1	152	203	242	2.5 L	A	56, 58, 133	
	Barium compounds, n.o.s	6.1	UN1564	II	6.1	IB8, IP2, IP4, T3, TP33	153	212	242	25 kg	A		
						IB8, IP3, T1, TP33	153	213	240	100 kg	A		
						IB8, IP3, T1, TP33	153	213	240	100 kg	A		
						IB7, IP1, N74, N75, T6, TP33	None	211	242	5 kg	A	40, 52	
Barium cyanide	6.1	UN1565	I	6.1	A7, A9, IB8, IP2, IP4, N34, T3, TP33	152	212	None	5 kg	B	4, 52, 56, 58, 106		
Barium hypochlorite with more than 22 percent available chlorine	5.1	UN2741	II	5.1,	IB8, IP2, IP4, T3, TP33	152	212	242	5 kg	A			
Barium nitrate	5.1	UN1446	II	5.1,	IB8, IP3, T1, TP33	153	213	240	100 kg	A			
Barium oxide	6.1	UN1884	III	6.1	IB6, IP2, T3, TP33	152	212	242	5 kg	A	56, 58		
Barium perchlorate, solid	5.1	UN1447	II	5.1,	IB2, T4, TP1	152	202	243	1 L	A	56, 58, 133		
Barium perchlorate, solution	5.1	UN3406	II	5.1,	IB2, T4, TP1	152	203	242	2.5 L	A	56, 58, 133		
Barium permanganate	5.1	UN1448	II	5.1,	IB6, IP2, T3, TP33	152	212	242	5 kg	D	56, 58, 138		
Barium peroxide	5.1	UN1449	II	5.1,	A9, IB6, IP2, T3, TP33	152	212	242	5 kg	A	13, 52, 56, 75		
Barium selenate, see Selenates or Selenites													
Barium selenite, see Selenates or Selenites													

UN number	Proper shipping name	Class	Division	Subdivision	Quantity	Forbidden	Quantity	Class	Division	Subdivision
4.3	Batteries, containing sodium hydroxide solid, electric storage	II	4.3	8	237	None	189	213	None	52
9	Batteries, dry, sealed, n.o.s.	9		130					25
9	Batteries, dry, sealed, n.o.s. for nickel-metal hydride batteries transported by modes other than vessel	9		340					25
8	Batteries, wet, filled with acid, electric storage	III	8		A51	30 kg	159		A	146
8	Batteries, wet, filled with alkali, electric storage	III	8		A51	30 kg	159		A	52, 146
8	Batteries, wet, non-spillable, electric storage	III	8		159a	No limit	159		A	
8	Battery fluid, acid	II	8		A3, A7, B2, B15, IB2, N6, N34, T8, TP2	1 L	242		B	29
8	Battery fluid, alkali	II	8		B2, IB2, N6, T7, TP2, TP28	1 L	242		A	29
9	Battery lithium type, see Lithium batteries etc		9		134	No limit	None		A	
9	Battery-powered vehicle or Battery-powered equipment		9			No limit	None		A	
9	Battery, wet, filled with acid or alkali with vehicle or mechanical equipment containing an internal combustion engine, see Vehicle, etc. or Engines, internal combustion, etc	III	9							
9	Benzaldehyde	III	9		IB3, T2, TP1	100 L	241	203	A	40
3	Benzene	II	3		IB2, T4, TP1	5 L	242	202	B	
Forbidden	Benzene diazonium chloride (dry)									
Forbidden	Benzene diazonium nitrate (dry)									
8	Benzene phosphorus dichloride, see Phenyl phosphorus dichloride	III	8		IB3, T4, TP1	5 L	241	203	A	40
8	Benzene phosphorus trichloride, see Phenyl phosphorus trichloride	III	8							
8	Benzene sulfonyl chloride	III	8							
Forbidden	Benzene triozonide									
6.1	Benzene, see Benzene	II	6.1		IB8, IP2, IP4, T3, TP33	25 kg	242	212	A	
6.1	Benzoic acid	II	6.1							
6.1	Benzonitrile	II	6.1		IB2, T7, TP2	5 L	243	202	A	40, 52
6.1	Benzoquinone	II	6.1		IB8, IP2, IP4, T3, TP33	25 kg	242	212	A	
8	Benzotrifluoride	II	8		B2, IB2, T7, TP2	1 L	242	202	A	40
3	Benzotrifluoride	II	3		IB2, T4, TP1	5 L	242	202	B	40
Forbidden	Benzoyl azides (dry)									
Forbidden	Benzoyl azide									

W

+

§ 172.101 HAZARDOUS MATERIALS TABLE—Continued

(1) Sym-bols	(2) Hazardous materials descriptions and proper shipping names	(3) Hazard class or Division	(4) Identi-fication Numbers	(5) PG	(6) Label Codes	(7) Special provisions (§ 172.102)	(8) Packaging (§ 173.***)			(9) Quantity limitations (see §§ 173.27 and 175.75)		(10) Vessel stowage	
							Excep-tions (8A)	Non-bulk (8B)	Bulk (8C)	Passenger aircraft/rail (9A)	Cargo air-craft only (9B)	Loca-tion (10A)	Other (10B)
G	Benzoyl chloride	6.1	UN1736	II	8	B2, IB2, T8, TP2, TP13	154	202	242	1 L	30 L	C	40
	Benzyl bromide	6.1	UN1737	II	6.1, 8	A3, A7, IB2, N33, N34, T8, TP2, TP13	None	202	243	1 L	30 L	D	13, 40.
	Benzyl chloride	6.1	UN1738	II	6.1, 8	A3, A7, B70, IB2, N33, N42, T8, TP2, TP13	None	202	243	1 L	30 L	D	13, 40.
	Benzyl chloride <i>unstabilized</i>	6.1	UN1738	II	6.1, 8	A3, A7, B8, B11, IB2, N33, N34, N43, T8, TP2, TP13	153	202	243	1 L	30 L	D	13, 40
	Benzyl chloroformate	8	UN1739	I	8	A3, A6, B4, N41, T10, TP2, TP13	None	201	243	Forbidden	2.5 L	D	40
	Benzyl iodide	6.1	UN2653	II	6.1	IB2, T7, TP2	153	202	243	5 L	60 L	B	12, 40
	Benzyl dimethylamine	8	UN2619	II	8, 3	B2, IB2, T7, TP2	154	202	243	1 L	30 L	A	25, 40
	Benzylidene chloride	6.1	UN1886	II	6.1	IB2, T7, TP2	153	202	243	5 L	60 L	D	40
	Beryllium compounds, n.o.s	6.1	UN1566	III	6.1	IB8, IP2, IP4, T3, TP33	153	212	242	25 kg	100 kg	A	
	Beryllium nitrate	5.1	UN2464	II	5.1, 6.1	IB8, IP2, IP4, T3, TP33	152	212	242	100 kg	200 kg	A	
	Beryllium, powder	6.1	UN1567	II	6.1, 4.1	IB8, IP2, IP4, T3, TP33	153	212	242	15 kg	50 kg	A	
	Bicyclo [2,2,1] hepta-2,5-diene, sta-bilized or 2,5-Norbornadiene, sta-bilized	3	UN2251	II	3	IB2, T7, TP2	150	202	242	5 L	60 L	D	
	Biological substance, Category B	6.2	UN3373			A82	134	199	None	4 L or 4 kg	4 L or 4 kg	A	40
	<i>Biphenyl triazone</i>	Forbidden								Forbidden	30 L	E	
	Bipyridilium pesticides, liquid, flam-mable, toxic, <i>flash point less than 23 degrees C</i>	3	UN2782	I	3, 6.1	T14, TP2, TP13, TP27	None	201	243	Forbidden	30 L	E	
Bipyridilium pesticides, liquid, toxic	6.1	UN3016	I	6.1	IB2, T11, TP2, TP13, TP27	150	202	243	1 L	60 L	B	40	
Bipyridilium pesticides, liquid, toxic, flammable, <i>flash point not less than 23 degrees C</i>	6.1	UN3015	III	6.1, 3	T14, TP2, TP13, TP27	153	203	241	60 L	220 L	A	40	
			I	6.1, 3	T14, TP2, TP13, TP27	None	201	243	1 L	30 L	B	21, 40	
			II	6.1, 3	IB2, T11, TP2, TP13, TP27	153	202	243	5 L	60 L	B	21, 40	

Bipyridilium pesticides, solid, toxic	6.1	UN2781	III	6.1, 3	B1, IB3, T7, TP2, TP28	153	203	242	60 L	220 L	A	21, 40
<i>Bis</i> (Aminopropyl) piperazine, see Corrosive liquid, n.o.s.	6.1		I	6.1	IB7, IP1, T6, TP33	None	211	242	5 kg	50 kg	A	40
	6.1		II	6.1	IB8, IP2, IP4, T3, TP33	153	212	242	25 kg	100 kg	A	40
Bisulfate, aqueous solution	8	UN2837	II	8	A7, B2, IB2, N34, T7, TP2	154	202	242	1 L	30 L	A	
Bisulfites, aqueous solutions, n.o.s.	8	UN2693	III	8	A7, IB3, N34, T4, TP1	154	203	241	5 L	60 L	A	40, 52
	1.1D	UN0028	II	1.1D	IB3, T7, TP1, TP28	154	203	241	5 L	60 L	A	25
Black powder, compressed or Black powder, in pellets or Gunpowder, in pellets	1.1D	UN0027	II	1.1D	None	62	None	Forbidden	Forbidden	04	
Black powder or as a meal	4.1	NA0027	I	4.1	70	None	170	None	Forbidden	Forbidden	E	
Black powder for small arms												
Blasting agent, n.o.s., see Explosives, blasting etc												
Blasting cap assemblies, see Detonator assemblies, non-electric, for blasting												
Blasting caps, electric, see Detonators, electric for blasting												
Blasting caps, non-electric, see Detonators, non-electric, for blasting												
Bleaching powder, see Calcium hypochlorite mixtures, etc												
Blue asbestos (Crocidolite) or Brown asbestos (amosite, <i>mysorite</i>)	9	UN2212	II	9	156, IB8, IP2, IP4, T3, TP33	155	216	240	Forbidden	Forbidden	A	34, 40
Bombs, photo-flash	1.1F	UN0037	II	1.1F		62	None	Forbidden	Forbidden	05	25
Bombs, photo-flash	1.1D	UN0038	II	1.1D		62	62	Forbidden	Forbidden	04	25
Bombs, photo-flash	1.2G	UN0039	II	1.2G		62	62	Forbidden	Forbidden	03	25
Bombs, photo-flash	1.3G	UN0299	II	1.3G		62	62	Forbidden	Forbidden	03	25
Bombs, smoke, non-explosive, with corrosive liquid, without initiating device	8	UN2028	II	8	None	160	None	Forbidden	50 kg	E	40
Bombs, with bursting charge	1.1F	UN0033	II	1.1F		62	None	Forbidden	Forbidden	05	25
Bombs, with bursting charge	1.1D	UN0034	II	1.1D		62	62	Forbidden	Forbidden	04	25
Bombs, with bursting charge	1.2D	UN0035	II	1.2D		62	62	Forbidden	Forbidden	04	25
Bombs, with bursting charge	1.2F	UN0291	II	1.2F		62	None	Forbidden	Forbidden	05	25
Bombs, with flammable liquid, with bursting charge	1.1J	UN0399	II	1.1J		62	None	Forbidden	Forbidden	05	25, 23E
Bombs, with flammable liquid, with bursting charge	1.2J	UN0400	II	1.2J		62	None	Forbidden	Forbidden	05	25, 23E
Boosters with detonator	1.1B	UN0225	II	1.1B	None	62	None	Forbidden	Forbidden	05	25
Boosters with detonator	1.2B	UN0268	II	1.2B	None	62	None	Forbidden	Forbidden	05	25
Boosters, without detonator	1.1D	UN0042	II	1.1D	None	62	None	Forbidden	Forbidden	04	25
Boosters, without detonator	1.2D	UN0283	II	1.2D	None	62	None	Forbidden	Forbidden	04	25

D

I

§ 172.101 HAZARDOUS MATERIALS TABLE—Continued

(1) Sym-bols	(2) Hazardous materials descriptions and proper shipping names	(3) Hazard class or Division	(4) Identi-fication Numbers	(5) PG	(6) Label Codes	(7) Special provisions (§ 172.102)	(8) Packaging (§ 173.***)			(9) Quantity limitations (see §§ 173.27 and 175.75)		(10) Vessel stowage			
							Excep-tions (8A)	Non-bulk (8B)	Bulk (8C)	Passenger aircraft/rail (9A)	Cargo air-craft only (9B)	Loca-tion (10A)	Other (10B)		
+	<i>Borate and chlorate mixtures, see Chlorate and borate mixtures</i> Boromeol Boron tribromide Boron trichloride Boron trifluoride Boron trifluoride acetic acid com-plex, liquid Boron trifluoride acetic acid com-plex, solid Boron trifluoride diethyl etherate Boron trifluoride dihydrate Boron trifluoride dimethyl etherate Boron trifluoride propionic acid com-plex, liquid Boron trifluoride propionic acid com-plex, solid <i>Box toe gum, see Nitrocellulose etc</i> Bromates, inorganic, aqueous solu-tion, n.o.s.	4.1	UN1312	III	4.1	A1, IB8, IP3, T1, TP33	None	213	240	25 kg	100 kg	A	12		
		8	UN2692	I	8, 6.1	2, B9, B14, B32, N34, T20, TP2, TP13, TP38, TP45	None	227	244	Forbidden	Forbidden	C			
		2.3	UN1741		2.3, 8	3, B9, B14	None	304	314	Forbidden	Forbidden	D	25, 40		
		2.3	UN1008	2.3, 8	2, 238, B9, B14	None	302	314, 315	Forbidden	Forbidden	D	40		
		8	UN1742	II	8	B2, B6, IB2, T8, TP2	154	202	242	1 L	30 L	A			
		8	UN3419	II	8	B2, B6, IB8, IP2, IP4, T3, TP33	154	212	240	15 kg	50 kg	A			
		8	UN2604	I	8, 3	A3, A19, T10, TP2	None	201	243	0.5 L	2.5 L	D	40		
		8	UN2851	II	8	IB2, T7, TP2	154	212	240	15 kg	50 kg	B	12, 40, 21, 28, 40, 49, 100		
		4.3	UN2965	I	4.3, 8, 3	A19, T10, TP2, TP7, TP13	None	201	243	Forbidden	1 L	D			
		8	UN1743	II	8	B2, IB2, T8, TP2	154	202	242	1 L	30 L	A			
G	<i>Boron trifluoride propionic acid com-plex, liquid</i> Boron trifluoride propionic acid com-plex, solid <i>Box toe gum, see Nitrocellulose etc</i> Bromates, inorganic, aqueous solu-tion, n.o.s.	8	UN3420	II	8	B2, IB8, IP2, IP4, T3, TP33	154	212	240	15 kg	50 kg	A			
		5.1	UN3213	II	5.1	350, IB2, T4, TP1	152	202	242	1 L	5 L	B	56, 58, 133		
		III		III	5.1	350, IB2, T4, TP1	152	203	241	2.5 L	30 L	B	56, 58, 133		
		5.1	UN1450	II	5.1	350, IB8, IP2, IP4, T3, TP33	152	212	242	5 kg	25 kg	A	56, 58		
		8	UN1744	I	8, 6.1	1, B9, B85, N34, N43, T22, TP2, TP10, TP13	None	226	249	Forbidden	Forbidden	D	12, 40, 66, 74, 89, 90		
		+	<i>Bromine azide</i> Bromine chloride Bromine pentafluoride	Forbiddn	UN2901		2.3, 8, 5.1	2, B9, B14, N86	None	304	314, 315	Forbidden	Forbidden	D	40, 89, 90
				5.1	UN1745	I	5.1, 6.1, 8	1, B9, B14, B30, T22, TP2, TP13, TP38, TP44	None	228	244	Forbidden	Forbidden	D	25, 40, 66, 90

§ 172.101 HAZARDOUS MATERIALS TABLE—Continued

(1) Sym-bols	(2) Hazardous materials descriptions and proper shipping names	(3) Hazard class or Division	(4) Identi-fication Numbers	(5) PG	(6) Label Codes	(7) Special provisions (§ 172.102)	(8) Packaging (§ 173.***)			(9) Quantity limitations (see §§ 173.27 and 175.75)		(10) Vessel stowage	
							Excep-tions (8A)	Non-bulk (8B)	Bulk (8C)	Passenger aircraft/rail (9A)	Cargo air-craft only (9B)	Loca-tion (10A)	Other (10B)
	Butadienes, stabilized or Butadienes and Hydrocarbon mixture, stabilized containing more than 40% butadienes	2.1	UN1010		2.1	T50	306	304	314, 315	Forbidden	150 kg	B	40
	Butane see also Petroleum gases, liquefied	2.1	UN1011		2.1	19, T50	306	304	314, 315	Forbidden	150 kg	E	40
	Butane, butane mixtures and mix-tures having similar properties in cartridges each not exceeding 500 grams, see Receptacles, etc												
	Butanedione	3	UN2346	II	3	IB2, T4, TP1	150	202	242	5 L	60 L	B	
	1,2,4-Butanetriol trinitrate	Forbidden	UN1120	III	3	IB2, T4, TP1, TP29	150	202	242	5 L	60 L	B	
	Butanols	3	UN1123	III	3	B1, IB3, T2, TP1	150	203	242	60 L	220 L	A	
	tert-Butoxy carbonyl azide	Forbidden	UN1123	III	3	IB2, T4, TP1	150	202	242	5 L	60 L	B	
	Butyl acetates	3	UN1718	III	3	B1, IB3, T2, TP1	150	203	242	5 L	60 L	A	
	Butyl acid phosphate	8	UN1718	III	8	IB3, T4, TP1	154	203	241	5 L	60 L	A	
	Butyl acrylates, stabilized	3	UN2348	III	3	B1, IB3, T2, TP1	150	203	242	60 L	220 L	A	
	Butyl alcohols, see Butanols												
	Butyl benzenes	3	UN2709	III	3	B1, IB3, T2, TP1	150	203	242	60 L	220 L	A	
	n-Butyl bromide, see 1-Bromobutane												
	n-Butyl chloride, see Chlorobutanes												
	n-Butyl chloroformate	6.1	UN2743	I	6.1, 8, 3	2, B9, B14, B32, T20, TP2, TP13, TP38, TP45	None	227	244	Forbidden	Forbidden	A	12, 13, 21, 25, 40, 100
	Butyl ethers, see Dibutyl ethers												
	Butyl ethyl ether, see Ethyl butyl ether												
	n-Butyl formate	3	UN1128	II	3	IB2, T4, TP1	150	202	242	5 L	60 L	B	
	tert-Butyl hydroperoxide, with more than 90 percent with water	Forbidden											
	tert-Butyl hypochlorite	4.2	UN3255	I	4.2, 8	IB2, T7, TP2	None	211	243	Forbidden	Forbidden	D	
	N-n-Butyl imidazole	6.1	UN2690	II	6.1	1, B9, B14, B30, T20, TP2, TP13, TP38, TP44	153	202	243	5 L	60 L	A	
	tert-Butyl isocyanate	6.1	UN2484	I	6.1, 3		None	226	244	Forbidden	Forbidden	D	40

§ 172.101 HAZARDOUS MATERIALS TABLE—Continued

(1) Sym-bols	(2) Hazardous materials descriptions and proper shipping names	(3) Hazard class or Division	(4) Identi-fication Numbers	(5) PG	(6) Label Codes	(7) Special provisions (§ 172.102)	(8) Packaging (§ 173.***)			(9) Quantity limitations (see §§ 173.27 and 175.75)		(10) Vessel stowage	
							Excep-tions	Non-bulk	Bulk	Passenger aircraft/rail	Cargo air-craft only	Loca-tion	Other
(1)	(2)	(3)	(4)	(5)	(6)	(7)	(8A)	(8B)	(8C)	(9A)	(9B)	(10A)	(10B)
	<i>Calcium bisulfite solution, see Bisulfites, aqueous solutions, n.o.s.</i>												
	Calcium carbide	4.3	UN1402	I	4.3	A1, A8, B55, B59, IB4, IP1, N34, T9, TP7, TP33	None	211	242	Forbidden	15 kg	B	52
	Calcium chlorate	5.1	UN1452	II	4.3	A1, A8, B55, B59, IB7, IP2, N34, T3, TP33	151	212	241	15 kg	50 kg	B	52
	Calcium chlorate aqueous solution	5.1	UN2429	II	5.1	A9, IB8, IP2, IP4, N34, T3, TP33	152	212	242	5 kg	25 kg	A	56, 58
	Calcium chlorite	5.1	UN1453	III	5.1	A2, IB2, N41, T4, TP1	152	202	242	1 L	5 L	B	56, 58, 133
	Calcium cyanamide with more than 0.1 percent of calcium carbide	4.3	UN1403	III	5.1	A2, IB2, N41, T4, TP1	152	203	241	2.5 L	30 L	B	56, 66, 133
	Calcium cyanide	6.1	UN1575	I	6.1	A9, IB8, IP2, IP4, N34, T3, TP33	151	212	242	5 kg	25 kg	A	56, 58
	Calcium dithionite or Calcium hydrosulfite	4.2	UN1923	II	4.2	A1, A19, IB8, IP4, T1, IB7, IP1, N79, N80, T6, TP33	None	211	242	25 kg	100 kg	A	52
	Calcium hydrosulfite, see Calcium dithionite	4.3	UN1404	I	4.3	A19, A20, IB6, IP2, T3, TP33	None	211	242	15 kg	50 kg	A	40, 52
	Calcium hypochlorite, dry, corrosive or Calcium hypochlorite mixture, dry, corrosive with more than 39% available chlorine (8.8% available oxygen)	5.1	UN3485	II	5.1, 8	A19, N40	None	211	242	Forbidden	15 kg	E	13
	Calcium hypochlorite, dry or Calcium hypochlorite mixture, dry with more than 39% available chlorine (8.8% available oxygen)	5.1	UN1748	II	5.1	165, 166, A7, A9, IB8, IP2, IP4, IP13, N34, W9	152	212	None	5 kg	25 kg	D	4, 25, 52, 56, 58, 69, 142
				III	5.1	165, 166, A7, A9, IB8, IP2, IP4, IP13, N34, W9	152	213	240	25 kg	100 kg	D	4, 25, 52, 56, 58, 69, 142

§ 172.101 HAZARDOUS MATERIALS TABLE—Continued

(1) Sym-bols	(2) Hazardous materials descriptions and proper shipping names	(3) Hazard class or Division	(4) Identi-fication Numbers	(5) PG	(6) Label Codes	(7) Special provisions (§ 172.102)	(8) Packaging (§ 173.***)			(9) Quantity limitations (see §§ 173.27 and 175.75)		(10) Vessel stowage	
							Excep-tions (8A)	Non-bulk (8B)	Bulk (8C)	Passenger aircraft/rail (9A)	Cargo air-craft only (9B)	Loca-tion (10A)	Other (10B)
I	Capacitor, electric double layer (with an energy storage capacity greater than 0.3 Wh)	9	UN3499	9	361	176	176	176	No limit	No limit	A	
	Caproic acid	8	UN2829	III	8	IB3, T4, TP1	203	241	241	5 L	60 L	A	
	Caps, blasting, see Detonators, etc	3	UN2758	I	3, 6.1	T14, TP2, TP13, TP27	None	201	243	Forbidden	30 L	B	40
I	Carbamate pesticides, liquid, flammable, toxic, flash point less than 23 degrees C	II			3, 6.1	IB2, T11, TP2, TP13, TP27	150	202	243	1 L	60 L	B	40
	Carbamate pesticides, liquid, toxic	6.1	UN2892	I	6.1	T14, TP2, TP13, TP27	None	201	243	1 L	30 L	B	40
	Carbamate pesticides, liquid, toxic	6.1	UN2892	II	6.1	IB2, T11, TP2, TP13, TP27	153	202	243	5 L	60 L	B	40
I	Carbamate pesticides, liquid, toxic, flammable, flash point not less than 23 degrees C	6.1	UN2891	III	6.1	IB3, T7, TP2, TP28	153	203	241	60 L	220 L	A	40
		6.1	UN2891	I	6.1, 3	T14, TP2, TP13, TP27	None	201	243	1 L	30 L	B	40
		6.1	UN2891	II	6.1, 3	IB2, T11, TP2, TP13, TP27	153	202	243	5 L	60 L	B	40
I	Carbamate pesticides, solid, toxic	6.1	UN2757	III	6.1, 3	B1, IB3, T7, TP2, TP28	153	203	242	60 L	220 L	A	40
		6.1	UN2757	I	6.1	IB7, IP1, T6, TP33	None	211	242	5 kg	50 kg	A	40
		6.1	UN2757	II	6.1	IB8, IP4, T3, TP33	153	212	242	25 kg	100 kg	A	40
I	Carboic acid, see Phenol, solid or Phenol, molten				6.1	IB8, IP3, T1, TP33	153	213	240	100 kg	200 kg	A	40
	Carboic acid solutions, see Phenol solutions												
	Carbon, activated	4.2	UN1362	III	4.2	IB8, IP3, T1, TP33	None	213	241	0.5 kg	0.5 kg	A	12
I	Carbon, animal or vegetable origin	4.2	UN1361	II	4.2	IB6, T3, TP33	None	212	242	Forbidden	Forbidden	A	12
	Carbon bisulfide, see Carbon disulfide				4.2	IB8, IP3, T1, TP33	None	213	241	Forbidden	Forbidden	A	12
	Carbon dioxide	2.2	UN1013		2.2		306	302, 304	302	75 kg	150 kg	A	
A W	Carbon dioxide, refrigerated liquid	2.2	UN2187		2.2	T75, TP5	306	304	304	50 kg	500 kg	D	
	Carbon dioxide, solid or Dry Ice	9	UN1845		None		217	217	240	200 kg	200 kg	C	40

UN number	Proper shipping name	Class	Division	Subdivision	Special provisions	Transportation mode	Quantity	Label	Other	Reference
3 UN1131	Carbon disulfide	I	3, 6.1	B16, T14, TP2, TP7, TP13	None	201	243	Forbidden	Forbidden	D 40, 78, 115, 40
2.3 UN1016	Carbon monoxide, compressed	II	2.3, 2.1	4	None	302	314, 315	Forbidden	25 kg	D 40
2.3 NA9202	Carbon monoxide, refrigerated liquid (cryogenic liquid)	III	2.3, 2.1	4, T75, TP5	None	316	318	Forbidden	Forbidden	D
6.1 UN2516	Carbon tetrabromide	II	6.1	IB8, IP3, T1, TP33	153	213	240	100 kg	200 kg	A 25
6.1 UN1846	Carbon tetrachloride	II	6.1	IB2, N36, T7, TP2	153	202	243	5 L	60 L	A 40
2.3 UN2417	Carbonyl fluoride	II	2.3, 8	2	None	302	None	Forbidden	Forbidden	D 40
2.3 UN2204	Carbonyl sulfide	II	2.3, 2.1	3, B14	None	304	314, 315	Forbidden	Forbidden	D 40
	<i>Cartridge cases, empty primed, see primer</i>									
	<i>Cartridges, actuating, for aircraft ejector seat catapult, fire extinguisher, canopy removal or apparatus, see Cartridges, power device</i>									
	<i>Cartridges, explosive, see Charges, demolition</i>									
	<i>Cartridges, sporting, see Cartridges for weapons, inert projectile, or Cartridges, small arms</i>									
1.1G UN0049	Cartridges, flash	II	1.1G	None	62	None	Forbidden	Forbidden	03 25
1.3G UN0050	Cartridges, flash	II	1.3G	None	62	None	75 kg	75 kg	03 25
1.1C UN0326	Cartridges for weapons, blank	II	1.1C	None	62	None	Forbidden	Forbidden	04 25
1.2C UN0413	Cartridges for weapons, blank or Cartridges, small arms, blank	II	1.2C	None	62	None	Forbidden	Forbidden	04 25
1.3C UN0327	Cartridges for weapons, blank or Cartridges, small arms, blank	II	1.3C	None	62	None	Forbidden	Forbidden	04 25
1.4C UN0338	Cartridges for weapons, blank or Cartridges, small arms, blank	II	1.4C	None	62	None	75 kg	75 kg	02 25
1.4S UN0014	Cartridges for weapons, blank or Cartridges for tools, blank	II	None	63	62	None	25 kg	100 kg	01 25
1.2C UN0328	Cartridges for weapons, inert projectile	II	1.2C	None	62	62	Forbidden	Forbidden	04 25
1.4S UN0012	Cartridges for weapons, inert projectile or Cartridges, small arms	II	None	63	62	None	25 kg	100 kg	01 25
1.4C UN0339	Cartridges for weapons, inert projectile or Cartridges, small arms	II	1.4C	None	62	None	Forbidden	75 kg	02 25
1.3C UN0417	Cartridges for weapons, inert projectile or Cartridges, small arms	II	1.3C	None	62	None	Forbidden	Forbidden	04 25
1.1F UN0005	Cartridges for weapons, with bursting charge	II	1.1F	None	62	None	Forbidden	Forbidden	05 25
1.1E UN0006	Cartridges for weapons, with bursting charge	II	1.1E	None	62	62	Forbidden	Forbidden	04 25
1.2F UN0007	Cartridges for weapons, with bursting charge	II	1.2F	None	62	None	Forbidden	Forbidden	05 25

§ 172.101 HAZARDOUS MATERIALS TABLE—Continued

(1) Sym-bols	(2) Hazardous materials descriptions and proper shipping names	(3) Hazard class or Division	(4) Identi-fication Numbers	(5) PG	(6) Label Codes	(7) Special provisions (§ 172.102)	(8) Packaging (§ 173.***)			(9) Quantity limitations (see §§ 173.27 and 175.75)		(10) Vessel stowage		
							Excep-tions (8A)	Non-bulk (8B)	Bulk (8C)	Passenger aircraft/rail (9A)	Cargo air-craft only (9B)	Loca-tion (10A)	Other (10B)	
D	Cartridges for weapons, with burst-ing charge	1.2E	UN0321	II	1.2E	None	62	62	Forbidden	Forbidden	04	25	
	Cartridges for weapons, with burst-ing charge	1.4F	UN0348	II	1.4F	None	62	None	Forbidden	Forbidden	05	25	
	Cartridges for weapons, with burst-ing charge	1.4E	UN0412	II	1.4E	None	62	62	Forbidden	75 kg	03	25	
	Cartridges, oil well	1.3C	UN0277	II	1.3C	None	62	62	Forbidden	Forbidden	04	25	
	Cartridges, oil well	1.4C	UN0278	II	1.4C	None	62	62	Forbidden	75 kg	02	25	
	Cartridges, power device	1.3C	UN0275	II	1.3C	None	62	62	Forbidden	75 kg	04	25	
	Cartridges, power device	1.4C	UN0276	II	1.4C	110	None	62	62	Forbidden	75 kg	02	25	
	Cartridges, power device	1.4S	UN0323	II	1.4S	110, 347	63	62	62	25 kg	100 kg	01	25	
	Cartridges, power device (used to project fastening devices)	1.2C	UN0381	II	1.2C	None	62	62	Forbidden	Forbidden	04	25	
	Cartridges, safety, blank, see Car-tridges for weapons, blank (UN 0014)	ORIM-D			None	222	63	None	30 kg gross	Forbidden	A	25	
	Cartridges, safety, see Cartridges for weapons, inert projectile, or Car-tridges, small arms or Cartridges, power device (UN 0323)													
	Cartridges, signal	1.3G	UN0054	II	1.3G	None	62	None	None	75 kg	03	25	
	Cartridges, signal	1.4G	UN0312	II	1.4G	None	62	None	None	75 kg	02	25	
Cartridges, signal	1.4S	UN0405	II	1.4S	None	62	None	None	100 kg	01	25		
Cartridges, small arms	ORIM-D			None	222	63	None	None	30 kg gross	A	25		
D	Cartridges, starter, jet engine, see Cartridges, power device													
	Cases, cartridge, empty with primer	1.4S	UN0055	II	1.4S	50	63	62	None	25 kg	100 kg	01	25	
	Cases, cartridges, empty with primer	1.4C	UN0379	II	1.4C	50	None	62	None	Forbidden	75 kg	02	25	
	Cases, combustible, empty, without primer	1.4C	UN0446	II	1.4C	None	62	None	Forbidden	75 kg	02	25	
	Cases, combustible, empty, without primer	1.3C	UN0447	II	1.3C	None	62	None	Forbidden	Forbidden	04	25	
A W	Casinghead gasoline see Gasoline													
	Castor beans or Castor meal or Castor pomace or Castor flake	9	UN2969	II	None	IB8, IP2, IP4, T3, TP33	155	204	240	No limit	No limit	E	34, 40	

G	Description	8	UN1719	II	III	8	B2, IB2, T11, TP2, TP27, IB3, T7, TP1, TP28	154	202	242	1 L	30 L	A	29, 52
	Caustic alkali liquids, n.o.s.													
	Caustic potash, see Potassium hydroxide etc													
	Caustic soda, (etc.) see Sodium hydroxide etc													
	Cells, containing sodium	4.3	UN3292	II	4.3	189		189	189	189	No limit	A		
	Celluloid, in block, rods, rolls, sheets, tubes, etc., except scrap	4.1	UN2000	III	4.1	None		None	213	240	100 kg	A		
	Celluloid, scrap	4.2	UN2002	III	4.2	None	IB8, IP3	None	213	241	Forbidden	D		
	Cement, see Adhesives containing flammable liquid													
	Cerium, slabs, ingots, or rods	4.1	UN1333	II	4.1	None	IB8, IP2, IP4, N34	None	212	240	50 kg	A	74, 91	
	Cerium, turnings or gritty powder	4.3	UN3078	II	4.3	151	A1, IB7, IP2, T3, TP33	151	212	242	15 kg	E		52
	Cesium or Caesium	4.3	UN1407	I	4.3	None	A7, A19, IB4, IP1, N34, N40	None	211	242	15 kg	D		
	Cesium nitrate or Caesium nitrate	5.1	UN1451	III	5.1	152	A1, A29, IB8, IP3, T1, TP33	152	213	240	100 kg	A		
	Charcoal briquettes, shell, screenings, wood, etc.	4.2	NA1361	III	4.2	151	IB8, T1, TP33	151	213	240	100 kg	A	12	
	Charges, bursting, plastics bonded	1.1D	UN0457	II	1.1D	None		None	62	None	Forbidden	04	25	
	Charges, bursting, plastics bonded	1.2D	UN0458	II	1.2D	None		None	62	None	Forbidden	04	25	
	Charges, bursting, plastics bonded	1.4D	UN0459	II	1.4D	None		None	62	None	Forbidden	02	25	
	Charges, bursting, plastics bonded	1.4S	UN0460	II	1.4S	347		347	62	None	100 kg	01	25	
	Charges, demolition	1.1D	UN0048	II	1.1D	None		None	62	62	Forbidden	04	25	
	Charges, depth	1.1D	UN0056	II	1.1D	None		None	62	62	Forbidden	04	25	
	Charges, expelling, explosive, for fire extinguishers, see Cartridges, power device													
	Charges, explosive, commercial without detonator	1.1D	UN0442	II	1.1D	None		None	62	None	Forbidden	04	25	
	Charges, explosive, commercial without detonator	1.2D	UN0443	II	1.2D	None		None	62	None	Forbidden	04	25	
	Charges, explosive, commercial without detonator	1.4D	UN0444	II	1.4D	None		None	62	None	Forbidden	02	25	
	Charges, explosive, commercial without detonator	1.4S	UN0445	II	1.4S	347		347	62	None	100 kg	01	25	
	Charges, propelling	1.1C	UN0271	II	1.1C	None		None	62	None	Forbidden	04	25	
	Charges, propelling	1.3C	UN0272	II	1.3C	None		None	62	None	Forbidden	04	25	
	Charges, propelling	1.2C	UN0415	II	1.2C	None		None	62	None	Forbidden	04	25	
	Charges, propelling	1.4C	UN0491	II	1.4C	None		None	62	None	Forbidden	02	25	
	Charges, propelling, for cannon	1.3C	UN0242	II	1.3C	None		None	62	None	Forbidden	04	25	
	Charges, propelling, for cannon	1.1C	UN0279	II	1.1C	None		None	62	None	Forbidden	04	25	
	Charges, propelling, for cannon	1.2C	UN0414	II	1.2C	None		None	62	None	Forbidden	04	25	
	Charges, shaped, flexible, linear	1.4D	UN0237	II	1.4D	None		None	62	None	Forbidden	02	25	
	Charges, shaped, flexible, linear	1.1D	UN0288	II	1.1D	None		None	62	None	Forbidden	04	25	
	Charges, shaped, without detonator	1.1D	UN0059	II	1.1D	None		None	62	None	Forbidden	04	25	
	Charges, shaped, without detonator	1.2D	UN0439	II	1.2D	None		None	62	None	Forbidden	04	25	
	Charges, shaped, without detonator	1.4D	UN0440	II	1.4D	None		None	62	None	Forbidden	02	25	
	Charges, shaped, without detonator	1.4S	UN0441	II	1.4S	347		347	62	None	100 kg	01	25	

§ 172.101 HAZARDOUS MATERIALS TABLE—Continued

(1) Sym-bols	(2) Hazardous materials descriptions and proper shipping names	(3) Hazard class or Division	(4) Identi-fication Numbers	(5) PG	(6) Label Codes	(7) Special provisions (§ 172.102)	(8) Packaging (§ 173.***)			(9) Quantity limitations (see §§ 173.27 and 175.75)		(10) Vessel stowage	
							Excep-tions (8A)	Non-bulk (8B)	Bulk (8C)	Passenger aircraft/rail (9A)	Cargo air-craft only (9B)	Loca-tion (10A)	Other (10B)
D	Charges, supplementary explosive Chemical kit	1.1D 8	UN0060 NA1760	II	1.1D 8	None 154 161	62 161	None None	Forbidden 30 L	Forbidden 1 L	04 B	25 40
G	Chemical under pressure, corrosive, n.o.s.	2.2	UN3316 UN3503	2.2, 8	15 362, T50, TP40	None 313, 315	335	None 313, 315	Forbidden 100 kg	Forbidden 100 kg	A D	40 40
G	Chemical under pressure, flam- mable, n.o.s.	2.1	UN3505	2.1, 8	362, T50, TP40	None	335	313, 315	Forbidden 75 kg	Forbidden 75 kg	D	40
G	Chemical under pressure, flam- mable, n.o.s.	2.1	UN3501	2.1	362, T50, TP40	None	335	313, 315	Forbidden 75 kg	Forbidden 75 kg	D	40
G	Chemical under pressure, flam- mable, toxic, n.o.s.	2.1	UN3504	2.1, 6.1	362, T50, TP40	None	335	313, 315	Forbidden 75 kg	Forbidden 75 kg	D	40
G	Chemical under pressure, n.o.s.	2.2	UN3500	2.2	362, T50, TP40	None	335	313, 315	75 kg	150 kg	B	
G	Chemical under pressure, toxic, n.o.s.	2.2	UN3502	2.2, 6.1	362, T50, TP40	None	335	313, 315	Forbidden 100 kg	Forbidden 100 kg	D	40
	Chloral, anhydrous, stabilized	6.1	UN2075	II	6.1	IB2, T7, TP2	153	202	243	5 L	60 L	D	40
	Chlorate and borate mixtures	5.1	UN1458	II	5.1	A9, IB8, IP2, IP4, N34, T3, TP33	152	212	240	5 kg	25 kg	A	56, 58
	Chlorate and magnesium chloride mixture solid	5.1	UN1459	III	5.1	A9, IB8, IP3, N34, T1, TP33	152	213	240	25 kg	100 kg	A	56, 58
	Chlorate and magnesium chloride mixture solution	5.1	UN3407	II	5.1	A9, IB8, IP2, IP4, N34, T3, TP33	152	212	240	5 kg	25 kg	A	56, 58
	Chlorate of potash, see Potassium chlorate					A9, IB8, IP3, N34, T1, TP33	152	213	240	25 kg	100 kg	A	56, 58
G	Chlorate of soda, see Sodium chlor- ate	5.1	UN3210	II	5.1	A9, IB2, N34, T4, TP1	152	202	242	1 L	5 L	A	56, 58, 133
	Chlorates, inorganic, aqueous solu- tion, n.o.s.			III	5.1	A9, IB2, N34, T4, TP1	152	203	241	2.5 L	30 L	A	56, 58, 133
G	Chlorates, inorganic, n.o.s.	5.1	UN1461	II	5.1	351, IB2, T4, TP1	152	212	242	1 L	5 L	B	56, 58
				III	5.1	351, IB2, T4, TP1	152	203	241	2.5 L	30 L	B	56, 58, 133
				II	5.1	351, A9, IB6, IP2, N34, T3, TP33	152	212	242	5 kg	25 kg	A	56, 58

Chloric acid aqueous solution, with not more than 10 percent chloric acid	5.1	UN2626	II	5.1	IB2, T4, TP1	None	229	None	Forbidden	Forbidden	D	56, 58
Chloride of phosphorus, see Phosphorus trichloride												
Chloride of sulfur, see Sulfur chloride												
Chlorinated lime, see Calcium hypochlorite mixtures, etc												
Chlorine	2.3	UN1017		2.3, 5.1, 8	2, B9, B14, N86, T50, TP19	None	304	None	Forbidden	Forbidden	D	40, 51, 55, 62, 68, 89, 90
Chlorine azide	Forbidden											
Chlorine dioxide, hydrate, frozen	5.1	NA9191	II	5.1, 6.1		None	229	None	Forbidden	Forbidden	E	
Chlorine dioxide (not hydrate)	Forbidden											
Chlorine pentafluoride	2.3	UN2548		2.3, 5.1, 8	1, B7, B9, B14, N86	None	304	None	Forbidden	Forbidden	D	40, 89, 90
Chlorine trifluoride	2.3	UN1749		2.3, 5.1, 8	2, B7, B9, B14, N86	None	304	None	Forbidden	Forbidden	D	40, 89, 90
Chlorite solution	8	UN1908	II	8	A3, A6, A7, B2, IB2, N34, T7, TP2, TP24	154	202	242	1 L	30 L	B	26, 44, 89, 100, 141
Chlorites, inorganic, n.o.s												
1-Chloro-1,1-difluoroethane or Refrigerant gas R 142b	5.1	UN1462	II	5.1	A3, A6, A7, B2, IB3, N34, T4, TP2, TP24	154	203	241	5 L	60 L	B	26, 44, 89, 100, 141
3-Chloro-4-methylphenyl isocyanate, liquid	2.1	UN2517		2.1	352, A7, IB6, IP2, N34, T3, TP33	152	212	242	5 kg	25 kg	A	56, 58
3-Chloro-4-methylphenyl isocyanate, solid	6.1	UN2236	II	6.1	T50	306	304	314, 315	Forbidden	150 kg	B	40
1-Chloro-1,2,2,2-tetrafluoroethane or Refrigerant gas R 124	6.1	UN3428	II	6.1	IB2	153	202	243	5 L	60 L	B	40
4-Chloro-o-toluidine hydrochloride, solid	6.1	UN3428	II	6.1	IB8, IP2, IP4, T3, TP33	153	212	242	25 kg	100 kg	B	40
4-Chloro-o-toluidine hydrochloride, solution	2.2	UN1021		2.2	T50	306	304	314, 315	75 kg	150 kg	A	
1-Chloro-2,2,2-trifluoroethane or Refrigerant gas R 133a	6.1	UN1579	III	6.1	IB8, IP3, T1, TP33	153	213	240	100 kg	200 kg	A	
Chloroacetic acid, molten	6.1	UN3410	III	6.1	IB3, T4, TP1	153	203	241	60 L	220 L	A	
Chloroacetic acid, solid	2.2	UN1983		2.2	T50	306	304	314, 315	75 kg	150 kg	A	
	6.1	UN3250	II	6.1, 8	IB1, T7, TP3, TP28	None	202	243	Forbidden	Forbidden	C	40
	6.1	UN1751	II	6.1, 8	A3, A7, IB8, IP2, IP4, N34, T3, TP33	153	212	242	15 kg	50 kg	C	40

D

G

§ 172.101 HAZARDOUS MATERIALS TABLE—Continued

(1) Sym-bols	(2) Hazardous materials descriptions and proper shipping names	(3) Hazard class or Division	(4) Identi-fication Numbers	(5) PG	(6) Label Codes	(7) Special provisions (§ 172.102)	(8) Packaging (§ 173.***)			(9) Quantity limitations (see §§ 173.27 and 175.75)		(10) Vessel stowage	
							Excep-tions (8A)	Non-bulk (8B)	Bulk (8C)	Passenger aircraft/rail (9A)	Cargo air-craft only (9B)	Loca-tion (10A)	Other (10B)
(1)	Chloroacetic acid, solution Chloroacetone, stabilized	6.1 6.1	UN1750 UN1695	II I	6.1, 8 6.1, 3, 8	A7, IB2, N34, T7, TP2 2, B9, B14, B32, N12, N32, N34, T20, TP2, TP13, TP38, TP45	153 None	202 227	243 244	30 L Forbidden	C D	40 21, 40, 100	
+	<i>Chloroacetone (unstabilized)</i> Chloroacetonitrile	Forbidden 6.1	UN2668	I	6.1, 3	2, B9, B14, B32, IB9, T20, TP2, TP13, TP38, TP45	None	227	244	Forbidden	A	12, 40, 52	
	Chloroacetophenone, liquid, (CM)	6.1	UN3416	II	6.1	A3, IB2, N12, N32, N33, T7, TP2, TP13	None	202	243	Forbidden	D	12, 40	
	Chloroacetophenone, solid, (CM)	6.1	UN1697	II	6.1	A3, IB8, IP2, IP4, N12, N32, N33, N34, T3, TP2, TP13, TP33	None	212	None	Forbidden	D	12, 40	
	Chloroacetyl chloride	6.1	UN1752	I	6.1, 8	2, B3, B8, B9, B14, B32, B77, N34, N43, T20, TP2, TP13, TP38, TP45	None	227	244	Forbidden	D	40	
	Chloroanilines, liquid	6.1	UN2019	II	6.1	IB2, T7, TP2	153	202	243	5 L 60 L	A	52	
	Chloroanilines, solid	6.1	UN2018	II	6.1	IB8, IP2, IP4, T3, TP33	153	212	242	25 kg 100 kg	A		
	Chloroanisidines	6.1	UN2233	III	6.1	IB8, IP3, T1, TP33	153	213	240	100 kg 200 kg	A		
	Chlorobenzene	3	UN1134	III	3	B1, IB3, T2, TP1	150	203	242	60 L 220 L	A		
	Chlorobenzol, see Chlorobenzene												
	Chlorobenzotrifluorides	3	UN2234	III	3	B1, IB3, T2, TP1	150	203	242	60 L 220 L	A	40	
	Chlorobenzyl chlorides, liquid	6.1	UN2235	III	6.1	IB3, T4, TP1	153	203	241	60 L 220 L	A		
	Chlorobenzyl chlorides, solid	6.1	UN3427	III	6.1	IB8, IP3, T1, TP33	153	213	240	100 kg 200 kg	A		
	Chlorobutanes	3	UN1127	II	3	IB2, T4, TP1	150	202	242	5 L 60 L	B	12	
	Chlorocresols solution	6.1	UN2669	II	6.1	IB2, T7, TP2	153	202	243	5 L 60 L	A	12	
	Chlorocresols, solid	6.1	UN3437	III	6.1	IB3, T7, TP2	153	203	241	60 L 220 L	A	12	
	Chlorodifluorobromomethane or Re-frigerant gas R 12B1	2.2	UN1974	II	2.2	IB8, IP2, IP4, T3, TP33 T50	153 306	212 304	242 314, 314, 315	25 kg 75 kg 150 kg	A	12	
	Chlorodifluoromethane and chloropentafluoroethane mixture or Refrigerant gas R 502 with fixed boiling point, with approxi-mately 49 percent	2.2	UN1973	II	2.2	T50	306	304	314, 315	75 kg 150 kg	A		
	Chlorodifluoromethane or Refrig-erant gas R 22	2.2	UN1018	II	2.2	T50	306	304	314, 315	75 kg 150 kg	A		

+	Chlorodinitrobenzenes, liquid.	6.1 UN1577	II	6.1	IB2, T7, TP2	153	202	243	5 L	60 L	B	91
		6.1 UN3441	II	6.1		IB8, IP2, IP4, T3, TP33	153	212	242	25 kg	100 kg	A
+	Chlorodinitrobenzenes, solid	6.1 UN2232	I	6.1	2, B9, B14, B32, T20, TP2, TP13, TP38, TP45	None	227	244	Forbidden	Forbidden	D	40
		6.1 UN1888	III	6.1	IB3, N36, T7, TP2	153	203	241	60 L	220 L	A	40
G	Chloroformates, toxic, corrosive, flammable, n.o.s.	6.1 UN2742	II	6.1, 8, 3	5, IB1, T7, TP2	153	202	243	1 L	30 L	A	12, 13, 21, 25, 40, 100
		6.1 UN3277	II	6.1, 8	IB2, T8, TP2, TP13,	153	202	243	1 L	30 L	A	12, 13, 25, 40
G	Chloroformates, toxic, corrosive, n.o.s.	6.1 UN2745	II	6.1, 8	IB2, T7, TP2, TP13	153	202	243	1 L	30 L	A	12, 13, 21, 25, 40, 100
		6.1 UN2354	II	3, 6.1	IB2, T7, TP1, TP13	150	202	243	1 L	60 L	E	40
+	Chloromethyl ethyl ether	6.1 UN2237	III	6.1	IB8, IP3, T1, TP33	153	213	240	100 kg	200 kg	A	40
		6.1 UN3409	III	6.1	IB2, T7, TP2	153	202	243	5 L	60 L	A	40
+	Chloronitrobenzenes, liquid	6.1 UN1578	II	6.1	IB8, IP2, IP4, T3, TP33	153	212	242	25 kg	100 kg	A	40
		6.1 UN2433	III	6.1	IB3, T4, TP1	153	203	241	60 L	220 L	A	44, 89, 100, 141
+	Chloronitrobenzenes, solid	6.1 UN3457	III	6.1	IB8, IP3, T1, TP33	153	213	240	25 kg	200 kg	A	40
		2.2 UN1020	III	2.2	IB3, T4, TP1	150	304	314, 315	75 kg	150 kg	A	40
+	Chloropentafluoroethane or Refrigerant gas R 115	8 UN2904	III	8	IB3	154	203	241	5 L	60 L	A	40
		8 UN2905	III	8	IB8, IP3, T1, TP33	154	213	240	25 kg	100 kg	A	40
+	Chlorophenolates, liquid	6.1 UN2021	III	6.1	IB3, T4, TP1	153	203	241	60 L	220 L	A	40
		6.1 UN2020	III	6.1	IB8, IP3, T1, TP1, TP33	153	213	240	100 kg	200 kg	A	40
+	Chlorophenolates, solid	8 UN1753	II	8	A7, B2, B6, N34, T10, TP2, TP7	None	206	242	Forbidden	30 L	C	40
		6.1 UN1580	I	6.1	2, B7, B9, B14, B32, B46, T22, TP2, TP13, TP38, TP45	None	227	244	Forbidden	Forbidden	D	40
+	Chloropicrin	2.3 UN1581	III	2.3	2, B9, B14, N86, T50	None	193	314, 315	Forbidden	Forbidden	D	25, 40
		2.3 UN1582	III	2.3	2, N86, T50	None	193	245	Forbidden	Forbidden	D	25, 40
G	Chloropicrin and methyl bromide mixtures	6.1 UN1583	I	6.1	5	None	201	243	Forbidden	Forbidden	C	40
		6.1 NA9263	III	6.1	IB2, IB3	153	202	243	Forbidden	Forbidden	C	40
D	Chloropicrin mixture, flammable (pressure not exceeding 14.7 psia at 115 degrees F flash point below 100 degrees F) see Toxic liquids, flammable, etc	8 UN2507	III	8	2, B9, B14, B32, T20, TP4, TP13, TP38, TP45	None	227	244	Forbidden	Forbidden	B	40
		3 UN1991	I	3, 6.1	IB8, IP3, T1, TP33	154	213	240	25 kg	100 kg	A	40
D	Chloroplatinic acid, solid	8 UN2507	III	8	B57, T14, TP2, TP13	None	201	243	Forbidden	30 L	D	40
		3 UN1991	I	3, 6.1	B57, T14, TP2, TP13	None	201	243	Forbidden	30 L	D	40

§ 172.101 HAZARDOUS MATERIALS TABLE—Continued

(1) Sym-bols	(2) Hazardous materials descriptions and proper shipping names	(3) Hazard class or Division	(4) Identi-fication Numbers	(5) PG	(6) Label Codes	(7) Special provisions (§ 172.102)	(8) Packaging (§ 173.***)			(9) Quantity limitations (see §§ 173.27 and 175.75)			(10) Vessel stowage	
							Excep-tions (8A)	Non-bulk (8B)	Bulk (8C)	Passenger aircraft/rail (9A)	Cargo air-craft only (9B)	Loca-tion (10A)	Other (10B)	
G	<i>Chloroprene, uninhibited</i> 1-Chloropropane 2-Chloropropane 3-Chloropropanol-1 2-Chloropropene 2-Chloropropionic acid 2-Chloropyridine Chlorosilanes, corrosive, flammable, n.o.s. Chlorosilanes, corrosive, n.o.s. Chlorosilanes, flammable, corrosive, n.o.s. Chlorosilanes, toxic, corrosive, flammable, n.o.s. Chlorosilanes, toxic, corrosive, n.o.s. Chlorosilanes, water-reactive, flammable, corrosive, n.o.s.	Forbidden	UN1278	II	3	IB2, IP8, N34, T7, TP2	None	202	242	Forbidden	60 L	E		
			UN2356	I	3	N36, T11, TP2, TP13	150	201	243	Forbidden	30 L	E		
			UN2849	III	6.1	IB3, T4, TP1	153	203	241	60 L	220 L	A		
			UN2456	I	3	A3, N36, T11, TP2	150	201	243	1 L	30 L	E		
			UN2511	III	8	IB3, T4, TP2	154	203	241	5 L	60 L	A	8	
			UN2822	II	6.1	IB2, T7, TP2	153	202	243	5 L	60 L	A	40	
			UN2986	II	8, 3	T14, TP2, TP7, TP13, TP27	None	206	243	Forbidden	30 L	C	40	
			UN2987	II	8	B2, T14, TP2, TP7, TP13, TP27	None	206	242	Forbidden	30 L	C	40	
			UN2985	II	3, 8	T14, TP2, TP7, TP13, TP27	None	206	243	Forbidden	5 L	B	40	
			UN3362	II	6.1, 8, 3	T14, TP2, TP7, TP13, TP27	None	206	243	Forbidden	30 L	C	40, 125	
			UN3361	II	6.1, 8	T14, TP2, TP7, TP13, TP27	None	206	243	Forbidden	30 L	C	40	
			UN2988	I	4.3, 3, 8	A2, T14, TP2, TP7, TP13	None	201	244	None	Forbidden	1 L	D	21, 28, 40, 49, 100
			UN1754	I	8, 6.1	2, B9, B10, B14, B32, T20, TP2, TP38, TP45	I	8, 6.1	227	None	244	Forbidden	Forbidden	C
+	Chlorotoluenes Chlorotoluidines, liquid Chlorotoluidines, solid Chlorotrifluoromethane and trifluoromethane azeotropic mixture or Refrigerant gas R 503 with approximately 60 percent chlorotrifluoromethane Chlorotrifluoromethane or Refrigerant gas R 13 Chromic acid solution	3 6.1 6.1 2.2	UN2238	III	3	B1, IB3, T2, TP1	150	203	242	60 L	220 L	A		
			UN3429	III	6.1	IB3, T4, TP1	153	203	241	60 L	220 L	A		
			UN2239	III	6.1	IB8, IP3, T1, TP33	153	213	240	100 kg	200 kg	A		
			UN2599	III	2.2		306	304	314, 315	75 kg	150 kg	A		
			UN1022	II	2.2	B2, IB2, T8, TP2	306	304	314, 315	75 kg	150 kg	A	40, 44, 89, 100, 141	
UN1755	II	8		154	202	242	1 L	30 L	C					

	III	8	IB3, T4, TP1	154	203	241	5 L	60 L	C	40, 44, 89, 100, 141
<i>Chromic anhydride, see Chromium trioxide, anhydrous</i>										
<i>Chromic fluoride, solid</i>	II	8	IB8, IP2, IP4, T3, TP33	154	212	240	15 kg	50 kg	A	52
<i>Chromic fluoride, solution</i>	III	8	B2, IB2, T7, TP2	154	202	242	1 L	30 L	A	
<i>Chromium nitrate</i>	III	8	IB3, T4, TP1	154	203	241	5 L	60 L	A	
	III	5.1	A1, A29, IB8, IP3, T1, TP33	152	213	240	25 kg	100 kg	A	
<i>Chromium oxychloride</i>	I	8	A3, A6, A7, B10, N34, T10, TP2	None	201	243	0.5 L	2.5 L	C	40, 66, 74, 89, 90
<i>Chromium trioxide, anhydrous</i>	II	5.1, 6.1, 8	IB8, IP2, IP4, T3, TP33	None	212	242	5 kg	25 kg	A	66, 90
<i>Chromosulfuric acid</i>	I	8	A3, A6, A7, B4, B6, N34, T10, TP2, TP13	None	201	243	0.5L	2.5L	B	40, 66, 74, 89, 90
<i>Chromyl chloride, see Chromium oxychloride</i>										
<i>Cigar and cigarette lighters, charged with fuel, see Lighters or Lighter refills containing flammable gas.</i>										
<i>Coal briquettes, hot</i>										
<i>Coal gas, compressed</i>	Forbiddn	2.3		3	302	314, 315	Forbiddn	Forbiddn	D	40
<i>Coal tar distillates, flammable</i>	3	2.1	IB2, T4, TP1	150	202	242	5 L	60 L	B	
<i>Coal tar dye, corrosive, liquid, n.o.s., see Dyes, liquid or solid, n.o.s. or Dye intermediates, liquid or solid, corrosive, n.o.s.</i>	III	3	B1, IB3, T4, TP1, TP29	150	203	242	60 L	220 L	A	
<i>Coating solution (includes surface treatments or coatings used for industrial or other purposes such as vehicle undercoating, drum or barrel lining)</i>	3	3	T11, TP1, TP8, TP27	150	201	243	1 L	30 L	E	
<i>Cobalt naphthenates, powder</i>	II	3	149, IB2, T4, TP1, TP8	150	202	242	5 L	60 L	B	
<i>Cobalt resinates, precipitated</i>	III	3	B1, IB3, T2, TP1	150	203	242	60 L	220 L	A	
<i>Coke, hot</i>	III	4.1	A19, IB8, IP3, T1, TP33	151	213	240	25 kg	100 kg	A	
<i>Collodion, see Nitrocellulose etc</i>	III	4.1	A1, A19, IB6, T1, TP33	151	213	240	25 kg	100 kg	A	
<i>Combustible liquid, n.o.s.</i>	III	None	IB3, T1, T4, TP1	150	203	241	60 L	220 L	A	25
<i>Components, explosive train, n.o.s</i>	II	1.2B	101	None	62	None	Forbiddn	Forbiddn	05	25
<i>Components, explosive train, n.o.s</i>	II	1.4B	101	None	62	None	Forbiddn	75 kg	05	25
<i>Components, explosive train, n.o.s</i>	II	1.4S	101	None	62	None	25 kg	100 kg	01	25

D G
G
G
G

§ 172.101 HAZARDOUS MATERIALS TABLE—Continued

(1) Sym-bols	(2) Hazardous materials descriptions and proper shipping names	(3) Hazard class or Division	(4) Identi-fication Numbers	(5) PG	(6) Label Codes	(7) Special provisions (§ 172.102)	(8) Packaging (§ 173.***)			(9) Quantity limitations (see §§ 173.27 and 175.75)		(10) Vessel stowage	
							Excep-tions (8A)	Non-bulk (8B)	Bulk (8C)	Passenger aircraft/rail (9A)	Cargo air-craft only (9B)	Loca-tion (10A)	Other (10B)
G	Components, explosive train, n.o.s <i>Compositor B, see Hexollite, etc</i>	1.1B	UN0461	II	1.1B	101	None	62	None	Forbidden	Forbidden	05	25
D G	Compounds, cleaning liquid	8	NA1760	I	8	A7, B10, T14, TP2, TP27	None	201	243	0.5 L	2.5 L	B	40
D G	Compounds, cleaning liquid	3	NA1993	III	8	B2, IB2, N37, T11, TP2, TP27	154	202	242	1 L	30 L	B	40
D G	Compounds, cleaning liquid	3	NA1993	I	3	IB3, N37, T7, TP1, TP28	154	203	241	5 L	60 L	A	40
D G	Compounds, tree killing, liquid or Compounds, weed killing, liquid	8	NA1760	I	8	A7, B10, T14, TP2, TP27	None	201	243	0.5 L	2.5 L	B	40
D G	Compounds, tree killing, liquid or Compounds, weed killing, liquid	3	NA1993	I	3	B2, IB2, N37, T11, TP2, TP27	154	202	242	1 L	30 L	B	40
D G	Compounds, tree killing, liquid or Compounds, weed killing, liquid	3	NA1993	III	8	IB3, N37, T7, TP1, TP28	154	203	241	5 L	60 L	A	40
D G	Compounds, tree killing, liquid or Compounds, weed killing, liquid	6.1	NA2810	I	6.1	T14, TP2, TP13, TP27	None	201	243	1 L	30 L	B	40
G	Compressed gas, flammable, n.o.s.	2.1	UN1954	III	2.1	IB2, T7, TP1, TP8, TP28	153	202	242	5 L	60 L	B	40
G	Compressed gas, n.o.s.	2.2	UN1956	II	2.2	B1, B52, IB3, T4, TP1, TP29	150	203	242	60 L	220 L	A	40
G	Compressed gas, oxidizing, n.o.s.	2.2	UN3156	II	2.2, 5.1	T14, TP2, TP13, TP27	306, 307	302, 305	314, 315	75 kg	150 kg	A	40
G I	Compressed gas, toxic, corrosive, n.o.s. <i>Inhalation Hazard Zone A</i>	2.3	UN3304	III	2.3, 8	IB2, T11, TP2, TP27	A14	302	314, 315	75 kg	150 kg	D	40
G I	Compressed gas, toxic, corrosive, n.o.s. <i>Inhalation Hazard Zone B</i>	2.3	UN3304	III	2.3, 8	IB3, T7, TP1, TP28	1	192	245	Forbidden	Forbidden	D	40
G I	Compressed gas, toxic, corrosive, n.o.s. <i>Inhalation Hazard Zone C</i>	2.3	UN3304	III	2.3, 8	2, B9, B14	None	302, 305	314, 315	Forbidden	Forbidden	D	40
G I	Compressed gas, toxic, corrosive, n.o.s. <i>Inhalation Hazard Zone C</i>	2.3	UN3304	III	2.3, 8	3, B14	None	302, 305	314, 315	Forbidden	Forbidden	D	40

Pipeline and Haz. Matls. Safety Admin., DOT

§ 172.101

G I	Compressed gas, toxic, corrosive, n.o.s. <i>Inhalation Hazard Zone D</i>	2.3	UN3304	2.3, 8	4	None	302, 305	314, 315	Forbidden	Forbidden	D	40
G I	Compressed gas, toxic, flammable, corrosive, n.o.s. <i>Inhalation Hazard Zone A</i>	2.3	UN3305	2.3, 2.1, 8	1	None	192	245	Forbidden	Forbidden	D	17, 40
G I	Compressed gas, toxic, flammable, corrosive, n.o.s. <i>Inhalation Hazard Zone B</i>	2.3	UN3305	2.3, 2.1, 8	2, B9, B14	None	302, 305	314, 315	Forbidden	Forbidden	D	17, 40
G I	Compressed gas, toxic, flammable, corrosive, n.o.s. <i>Inhalation Hazard Zone C</i>	2.3	UN3305	2.3, 2.1, 8	3, B14	None	302, 305	314, 315	Forbidden	Forbidden	D	17, 40
G I	Compressed gas, toxic, flammable, corrosive, n.o.s. <i>Inhalation Hazard Zone D</i>	2.3	UN3305	2.3, 2.1, 8	4	None	302, 305	314, 315	Forbidden	Forbidden	D	17, 40
G	Compressed gas, toxic, flammable, n.o.s. <i>Inhalation Hazard Zone A</i>	2.3	UN1953	2.3, 2.1	1	None	192	245	Forbidden	Forbidden	D	40
G	Compressed gas, toxic, flammable, n.o.s. <i>Inhalation Hazard Zone B</i>	2.3	UN1953	2.3, 2.1	2, B9, B14	None	302, 305	314, 315	Forbidden	Forbidden	D	40
G	Compressed gas, toxic, flammable, n.o.s. <i>Inhalation Hazard Zone C</i>	2.3	UN1953	2.3, 2.1	3, B14	None	302, 305	314, 315	Forbidden	Forbidden	D	40
G	Compressed gas, toxic, flammable, n.o.s. <i>Inhalation Hazard Zone D</i>	2.3	UN1953	2.3, 2.1	4	None	302, 305	314, 315	Forbidden	Forbidden	D	40
G	Compressed gas, toxic, n.o.s. <i>Inhalation Hazard Zone A</i>	2.3	UN1955	2.3	1	None	192	245	Forbidden	Forbidden	D	40
G	Compressed gas, toxic, n.o.s. <i>Inhalation Hazard Zone B</i>	2.3	UN1955	2.3	2, B9, B14	None	302, 305	314, 315	Forbidden	Forbidden	D	40
G	Compressed gas, toxic, n.o.s. <i>Inhalation Hazard Zone C</i>	2.3	UN1955	2.3	3, B14	None	302, 305	314, 315	Forbidden	Forbidden	D	40
G	Compressed gas, toxic, n.o.s. <i>Inhalation Hazard Zone D</i>	2.3	UN1955	2.3	4	None	302, 305	314, 315	Forbidden	Forbidden	D	40
G I	Compressed gas, toxic, oxidizing, corrosive, n.o.s. <i>Inhalation Hazard Zone A</i>	2.3	UN3306	2.3, 5.1, 8	1	None	192	244	Forbidden	Forbidden	D	40, 89, 90
G I	Compressed gas, toxic, oxidizing, corrosive, n.o.s. <i>Inhalation Hazard Zone B</i>	2.3	UN3306	2.3, 5.1, 8	2, B9, B14	None	302, 305	314, 315	Forbidden	Forbidden	D	40, 89, 90
G I	Compressed gas, toxic, oxidizing, corrosive, n.o.s. <i>Inhalation Hazard Zone C</i>	2.3	UN3306	2.3, 5.1, 8	3, B14	None	302, 305	314, 315	Forbidden	Forbidden	D	40, 89, 90
G I	Compressed gas, toxic, oxidizing, corrosive, n.o.s. <i>Inhalation Hazard Zone D</i>	2.3	UN3306	2.3, 5.1, 8	4	None	302, 305	314, 315	Forbidden	Forbidden	D	40, 89, 90
G	Compressed gas, toxic, oxidizing, n.o.s. <i>Inhalation Hazard Zone A</i>	2.3	UN3303	2.3, 5.1	1	None	192	245	Forbidden	Forbidden	D	40
G	Compressed gas, toxic, oxidizing, n.o.s. <i>Inhalation Hazard Zone B</i>	2.3	UN3303	2.3, 5.1	2, B9, B14	None	302, 305	314, 315	Forbidden	Forbidden	D	40
G	Compressed gas, toxic, oxidizing, n.o.s. <i>Inhalation Hazard Zone C</i>	2.3	UN3303	2.3, 5.1	3, B14	None	302, 305	314, 315	Forbidden	Forbidden	D	40
G	Compressed gas, toxic, oxidizing, n.o.s. <i>Inhalation Hazard Zone D</i>	2.3	UN3303	2.3, 5.1	4	None	302, 305	314, 315	Forbidden	Forbidden	D	40

§ 172.101 HAZARDOUS MATERIALS TABLE—Continued

(1) Sym-bols	(2) Hazardous materials descriptions and proper shipping names	(3) Hazard class or Division	(4) Identi-fication Numbers	(5) PG	(6) Label Codes	(7) Special provisions (§ 172.102)	(8) Packaging (§ 173.***)			(9) Quantity limitations (see §§ 173.27 and 175.75)		(10) Vessel stowage	
							Excep-tions (8A)	Non-bulk (8B)	Bulk (8C)	Passenger aircraft/rail (9A)	Cargo air-craft only (9B)	Loca-tion (10A)	Other (10B)
D	Consumer commodity	ORM-D		None	222	156, 306	156, 306	None	30 kg gross	Forbidden	A	
	Consumer commodity	9	ID8000		9		167	167	None	30 kg gross	30 kg gross		
G	Contrivances, water-activated, with burster, expelling charge or propelling charge	1.2L	UN0248	II	1.2L	None	62	None	Forbidden	Forbidden	05	25, 14E, 15E, 17E
G	Contrivances, water-activated, with burster, expelling charge or propelling charge	1.3L	UN0249	II	1.3L	None	62	None	Forbidden	Forbidden	05	25, 14E, 15E, 17E
	Copper acetoarsenite	6.1	UN1585	II	6.1	IB8, IP2, IP4, T3, TP33	153	212	242	25 kg	100 kg	A	
	Copper acetylacide	Forbidden											
	Copper amine azide	6.1	UN1586	II	6.1	IB8, IP2, IP4, T3, TP33	153	212	242	25 kg	100 kg	A	
	Copper arsenite	6.1	UN2776	I	3, 6.1	T14, TP2, TP13, TP27	None	201	243	Forbidden	30 L	B	40
	Copper based pesticides, liquid, flammable, toxic, flash point less than 23 degrees C			II	3, 6.1	IB2, T11, TP2, TP13, TP27	150	202	243	1 L	60 L	B	40
	Copper based pesticides, liquid, toxic	6.1	UN3010	I	6.1	T14, TP2, TP13, TP27	None	201	243	1 L	30 L	B	40
	Copper based pesticides, liquid, toxic			II	6.1	IB2, T11, TP2, TP13, TP27	153	202	243	5 L	60 L	B	40
	Copper based pesticides, liquid, toxic, flammable, flash point not less than 23 degrees C			III	6.1, 3	IB3, T7, TP2, TP28	153	203	241	60 L	220 L	A	40
	Copper based pesticides, liquid, toxic	6.1	UN3009	I	6.1, 3	T14, TP2, TP13, TP27	None	201	243	1 L	30 L	B	40
	Copper based pesticides, solid, toxic	6.1	UN2775	II	6.1, 3	IB2, T11, TP2, TP13, TP27	153	202	243	5 L	60 L	B	40
	Copper chlorate	5.1	UN2721	II	5.1	A1, IB8, IP2, IP4, T3, TP33	152	212	242	100 kg	25 kg	A	56, 58

A W	Copper chloride	8	UN2802	III	8	IB8, IP3, T1, TP33	154	213	240	25 kg	100 kg	A	52	
	Copper cyanide	6.1	UN1587	II	6.1	IB8, IP2, IP4, T3, TP33	153	204	242	25 kg	100 kg	A		
	Copper selenate, see Selenates or Selenites													
	Copper selenite, see Selenates or Selenites													
	Copper tetramine nitrate	Forbidden												
	Copra	4.2	UN1363	III	4.2	IB8, IP3, IP7	None	213	241	Forbidden	Forbidden	Forbidden	A	13, 25, 119
	Cord, detonating, flexible	1.1D	UN0065	II	1.1D	102	63(a)	62	None	Forbidden	Forbidden	Forbidden	04	25
	Cord, detonating, flexible	1.4D	UN0289	II	1.4D	None	62	None	Forbidden	Forbidden	Forbidden	02	25
	Cord, detonating or Fuse detonating metal clad	1.2D	UN0102	II	1.2D	None	62	None	Forbidden	Forbidden	Forbidden	04	25
	Cord, detonating or Fuse, detonating metal clad	1.1D	UN0290	II	1.1D	None	62	None	Forbidden	Forbidden	Forbidden	04	25
Cord, detonating, mild effect or Fuse, detonating, mild effect metal clad	1.4D	UN0104	II	1.4D	None	62	None	Forbidden	75 kg	75 kg	02	25	
Cord, igniter	1.4G	UN0066	II	1.4G	None	62	None	Forbidden	75 kg	75 kg	02	25	
Cordeau detonant fuse, see Cord, detonating, etc; Cord, detonating, flexible														
Cordite, see Powder, smokeless														
Corrosive liquid, acidic, inorganic, n.o.s.	8	UN3264	I	8	A6, B10, T14, TP2, TP27	None	201	243	0.5 L	2.5 L	2.5 L	B	40	
Corrosive liquid, acidic, organic, n.o.s.	8	UN3265	II	8	B2, IB2, T11, TP2, TP27	154	202	242	1 L	30 L	30 L	B	40	
			III	8	IB3, T7, TP1, TP28	154	203	241	5 L	60 L	60 L	A	40	
			I	8	A6, B10, T14, TP2, TP27	None	201	243	0.5 L	2.5 L	2.5 L	B	40	
Corrosive liquid, basic, inorganic, n.o.s.	8	UN3266	I	8	B2, IB2, T11, TP2, TP27	154	202	242	1 L	30 L	30 L	B	40	
			II	8	IB3, T7, TP1, TP28	154	203	241	5 L	60 L	60 L	A	40, 52	
			I	8	A6, B10, T14, TP2, TP27	None	201	243	0.5 L	2.5 L	2.5 L	B	40, 52	
Corrosive liquid, basic, organic, n.o.s.	8	UN3267	II	8	B2, IB2, T11, TP2, TP27	154	202	242	1 L	30 L	30 L	B	40, 52	
			III	8	IB3, T7, TP1, TP28	154	203	241	5 L	60 L	60 L	A	40, 52	
			I	8, 4.2	A6, B10	None	201	243	0.5 L	2.5 L	2.5 L	D	40, 52	
Corrosive liquid, self-heating, n.o.s.	8	UN3301	II	8, 4.2	B2, IB1	154	202	242	1 L	30 L	30 L	D	40, 52	
Corrosive liquids, flammable, n.o.s.	8	UN2920	I	8, 3	A6, B10, T14, TP2, TP27	None	201	243	0.5 L	2.5 L	2.5 L	C	25, 40	
Corrosive liquids, n.o.s.	8	UN1760	II	8, 3	B2, IB2, T11, TP2, TP27	None	202	243	1 L	30 L	30 L	C	25, 40	
			I	8	A6, A7, B10, T14, TP2, TP27	None	201	243	0.5 L	2.5 L	2.5 L	B	40	
Corrosive liquids, oxidizing, n.o.s.	8	UN3093	III	8	B2, IB2, T11, TP2, TP27	154	202	242	1 L	30 L	30 L	B	40	
			I	8, 5.1	IB3, T7, TP1, TP28	154	203	241	5 L	60 L	60 L	A	40	
			II	8, 5.1	A6, A7, IB2	None	201	243	Forbidden	Forbidden	Forbidden	C	89	
			II	8, 5.1	A6, A7, IB2	None	202	243	1 L	30 L	30 L	C	89	

§ 172.101 HAZARDOUS MATERIALS TABLE—Continued

(1) Sym-bols	(2) Hazardous materials descriptions and proper shipping names	(3) Hazard class or Division	(4) Identi-fication Numbers	(5) PG	(6) Label Codes	(7) Special provisions (§ 172.102)	(8) Packaging (§ 173.***)			(9) Quantity limitations (see §§ 173.27 and 175.75)		(10) Vessel stowage	
							(8A) Excep-tions	(8B) Non-bulk	(8C) Bulk	(9A) Passenger aircraft/rail	(9B) Cargo air-craft only	(10A) Loca-tion	(10B) Other
G	Corrosive liquids, toxic, n.o.s.	8	UN2922	I	8, 6.1	A6, A7, B10, T14, TP2, TP13, TP27	None	201	243	0.5 L	2.5 L	B	40
G	Corrosive liquids, water-reactive, n.o.s.	8	UN3094	III	8, 6.1	B3, IB2, T7, TP2	154	202	243	1 L	30 L	B	40
							154	203	241	5 L	60 L	B	40
G	Corrosive solid, acidic, inorganic, n.o.s.	8	UN3260	I	8, 4.3	A6, A7	None	201	243	Forbidden	1 L	E	
							None	202	243	1 L	5 L	E	
G	Corrosive solid, acidic, organic, n.o.s.	8	UN3261	III	8	IB8, IP2, IP4, T3, TP33	None	211	242	1 kg	25 kg	B	
							154	212	240	15 kg	50 kg	B	
G	Corrosive solid, acidic, organic, n.o.s.	8	UN3261	III	8	IB8, IP3, T1, TP33	154	213	240	25 kg	100 kg	A	
							None	211	242	1 kg	25 kg	B	
G	Corrosive solid, basic, inorganic, n.o.s.	8	UN3262	I	8	IB7, IP1, T6, TP33	154	212	240	15 kg	50 kg	B	
							154	213	240	25 kg	100 kg	A	52
G	Corrosive solid, basic, organic, n.o.s.	8	UN3263	III	8	IB7, IP1, T6, TP33	None	211	242	1 kg	25 kg	B	
							154	212	240	15 kg	50 kg	B	
G	Corrosive solids, flammable, n.o.s.	8	UN2921	I	8, 4.1	IB6, T6, TP33	None	211	240	25 kg	100 kg	A	52
							None	211	242	1 kg	25 kg	B	12, 25
G	Corrosive solids, n.o.s.	8	UN1759	II	8	128, IB8, IP2, IP4, T3, TP33	None	211	242	1 kg	50 kg	B	12, 25
							154	212	240	15 kg	50 kg	A	
G	Corrosive solids, oxidizing, n.o.s.	8	UN3084	III	8, 5.1	128, IB8, IP3, T1, TP33	154	213	240	25 kg	100 kg	A	
							None	211	242	1 kg	25 kg	C	
G	Corrosive solids, self-heating, n.o.s.	8	UN3095	II	8, 4.2	IB6, IP2, T3, TP33	None	212	242	15 kg	50 kg	C	
							None	211	243	1 kg	25 kg	C	
G	Corrosive solids, toxic, n.o.s.	8	UN2923	I	8, 6.1	IB6, IP2, T3, TP33	None	212	242	15 kg	50 kg	C	
							None	211	242	1 kg	25 kg	B	40
G	Corrosive solids, water-reactive, n.o.s.	8	UN3096	III	8, 6.1	IB8, IP2, IP4, T3, TP33	154	212	240	15 kg	50 kg	B	40
							154	213	240	25 kg	100 kg	B	40, 95
G	Corrosive solids, water-reactive, n.o.s.	8	UN3096	I	8, 4.3	IB4, IP1, T6, TP33	None	211	243	1 kg	25 kg	D	
							None	211	243	1 kg	25 kg	D	

D W	Cotton	9	NA1365	II	8, 4.3	IB6, IP2, T3, TP33	None	212	242	15 kg	50 kg	D	54
A W	Cotton waste, oily	4.2	UN1364	III	9	137, IB8, IP2, IP4, W41	None	None	None	No limit	No limit	A	
A 1 W	Cotton, wet	4.2	UN1365	III	4.2	IB8, IP3, IP7	None	213	None	Forbiddn	Forbiddn	A	
	Coumarin derivative pesticides, liq-uid, flammable, toxic, flash point less than 23 degrees C	4.2	UN3024	I	3, 6.1	IB8, IP3, IP7	None	204	241	Forbiddn	Forbiddn	A	40
		3	UN3024	I	3, 6.1	T14, TP2, TP13, TP27	None	201	243	Forbiddn	30 L	B	
	Coumarin derivative pesticides, liq-uid, toxic	6.1	UN3026	I	3, 6.1	IB2, T11, TP2, TP13, TP27	150	202	243	1 L	60 L	B	40
		6.1	UN3026	I	6.1	T14, TP2, TP13, TP27	None	201	243	1 L	30 L	B	40
	Coumarin derivative pesticides, liq-uid, toxic, flammable, flash point not less than 23 degrees C	6.1	UN3025	I	6.1, 3	IB2, T11, TP2, TP27	153	202	243	5 L	60 L	B	40
		6.1	UN3025	I	6.1, 3	IB3, T7, TP1, TP28	153	203	241	60 L	220 L	A	40
		6.1	UN3025	I	6.1, 3	T14, TP2, TP13, TP27	None	201	243	1 L	30 L	B	40
	Coumarin derivative pesticides, solid, toxic	6.1	UN3027	I	6.1, 3	IB2, T11, TP2, TP13, TP27	153	202	243	5 L	60 L	B	40
		6.1	UN3027	I	6.1	B1, IB3, T7, TP1, TP28	153	203	242	60 L	220 L	A	40
		6.1	UN3027	I	6.1	IB7, IP1, T6, TP33	None	211	242	5 kg	50 kg	A	40
	Cresols, liquid	6.1	UN2076	II	6.1	IB8, IP2, IP4, T3, TP33	153	212	242	25 kg	100 kg	A	40
	Cresols, solid	6.1	UN3455	II	6.1, 8	IB8, IP3, T1, TP33	153	213	240	100 kg	200 kg	A	40
	Cresylic acid	6.1	UN2022	II	6.1, 8	IB2, IP2, IP4, T7, TP2	153	202	243	1 L	30 L	B	
	Crotonaldehyde or Crotonaldehyde, stabilized	6.1	UN1143	I	6.1, 3	IB8, IP2, IP4, T3, TP33	153	212	242	15 kg	50 kg	B	
		6.1	UN1143	I	6.1, 3	IB2, T7, TP2, TP13	153	202	243	1 L	30 L	B	40
		8	UN3472	III	8	2, 175, B9, B14, B32, B77, T20, TP2, TP13, TP38, TP45	None	227	244	Forbiddn	Forbiddn	D	
	Crotonic acid, liquid	8	UN2823	III	8	IB8, T1	154	203	241	5 L	60 L	A	12.
	Crotonic acid, solid	3	UN1144	I	3	IB8, IP3, T1, TP33	154	213	240	25 kg	100 kg	A	12.
	Cupriethylene	8	UN1761	III	8, 6.1	T11, TP2	150	201	243	1 L	30 L	E	
	Cutters, cable, explosive	1.4S	UN0070	II	1.4S	IB2, T7, TP2	154	202	243	1 L	30 L	A	95
	Cyanide or cyanide mixtures, dry, see Cyanides, inorganic, solid, n.o.s.	6.1	UN1935	I	6.1	IB3, T7, TP1, TP28	154	203	242	5 L	60 L	A	25
		6.1	UN1935	I	6.1	None	62	62	25 kg	100 kg	01	
		6.1	UN1935	I	6.1	T14, TP2, TP13, TP27	None	201	243	1 L	30 L	B	40, 52
		6.1	UN1935	II	6.1	IB2, T11, TP2, TP13, TP27	153	202	243	5 L	60 L	A	40, 52
		6.1	UN1588	III	6.1	IB3, T7, TP2, TP13, TP28	153	203	241	60 L	220 L	A	40, 52
		6.1	UN1588	I	6.1	IB7, IP1, N74, N75, T6, TP33	None	211	242	5 kg	50 kg	A	52
		6.1	UN1588	II	6.1	IB8, IP2, IP4, N74, N75, T3, TP33	153	212	242	25 kg	100 kg	A	52
		6.1	UN1588	III	6.1	IB8, IP3, N74, N75, T1, TP33	153	213	240	100 kg	200 kg	A	52

§ 172.101 HAZARDOUS MATERIALS TABLE—Continued

(1) Sym-bols	(2) Hazardous materials descriptions and proper shipping names	(3) Hazard class or Division	(4) Identi-fication Numbers	(5) PG	(6) Label Codes	(7) Special provisions (§ 172.102)	(8) Packaging (§ 173.***)			(9) Quantity limitations (see §§ 173.27 and 175.75)		(10) Vessel stowage	
							Excep-tions (8A)	Non-bulk (8B)	Bulk (8C)	Passenger aircraft/rail (9A)	Cargo air-craft only (9B)	Loca-tion (10A)	Other (10B)
	Cyanogen	2.3	UN1026		2.3, 2.1	2		304	245	Forbidden	Forbidden	D	40
	Cyanogen bromide	6.1	UN1889	I	6.1, 8	A6, A8, T6, TP33	211	242	242	1 kg	15 kg	D	40
	Cyanogen chloride, stabilized	2.3	UN1589		2.3, 8	1	192	245	245	Forbidden	Forbidden	D	40
	Cyanuric chloride	8	UN2670	II	8	IB8, IP2, IP4, T3, TP33	212	240	240	15 kg	50 kg	A	12, 40
	Cyanuric triazide	Forbidden											
	Cyclobutane	2.1	UN2601		2.1		306	314,	315	Forbidden	150 kg	B	40
	Cyclobutyl chloroformate	6.1	UN2744	II	6.1, 8, 3	IB1, T7, TP2, TP13	153	202	243	1 L	30 L	A	12, 13, 21, 25, 40, 100
	1,5,9-Cyclododecatriene	6.1	UN2518	III	6.1	IB3, T4, TP1	153	203	241	60 L	220 L	A	40
	Cycloheptane	3	UN2241	II	3	IB2, T4, TP1	150	202	242	5 L	60 L	B	40
	Cycloheptatriene	3	UN2603	II	3, 6.1	IB2, T7, TP1, TP13	150	202	243	1 L	60 L	E	40
	Cycloheptene	3	UN2242	II	3	B1, IB2, T4, TP1	150	202	242	5 L	60 L	B	40
	Cyclohexane	3	UN1145	II	3	IB2, T4, TP1	150	202	242	5 L	60 L	E	40
	Cyclohexanone	3	UN1915	III	3	B1, IB3, T2, TP1	150	203	242	60 L	220 L	A	40
	Cyclohexene	3	UN2256	II	3	IB2, T4, TP1	150	202	242	5 L	60 L	E	40
	Cyclohexenyltrichlorosilane	8	UN1762	II	8	A7, B2, N34, T10, TP2, TP7, TP13	None	206	242	Forbidden	30 L	C	40
	Cyclohexyl acetate	3	UN2243	III	3	B1, IB3, T2, TP1	150	203	242	60 L	220 L	A	40
	Cyclohexyl isocyanate	6.1	UN2488	I	6.1, 3	2, B9, B14, B32, B77, T20, TP2, TP13, TP38, TP45	None	227	244	Forbidden	Forbidden	D	40
	Cyclohexyl mercaptan	3	UN3054	III	3	B1, IB3, T2, TP1	150	203	242	60 L	220 L	A	40, 95
	Cyclohexylamine	8	UN2357	II	8, 3	IB2, T7, TP2	None	202	243	1 L	30 L	A	40
	Cyclohexyltrichlorosilane	8	UN1763	II	8	A7, B2, N34, T10, TP2, TP7, TP13	None	206	242	Forbidden	30 L	C	40
	Cyclonite and cyclotetramethylenetetramine mixtures, wetted or desensitized see RDX and HMX mixtures, wetted or desensitized etc												
	Cyclonite and HMX mixtures, wetted or desensitized see RDX and HMX mixtures, wetted or desensitized etc												

§ 172.101 HAZARDOUS MATERIALS TABLE—Continued

(1) Sym-bols	(2) Hazardous materials descriptions and proper shipping names	(3) Hazard class or Division	(4) Identi-fication Numbers	(5) PG	(6) Label Codes	(7) Special provisions (§ 172.102)	(8) Packaging (§ 173.***)			(9) Quantity limitations (see §§ 173.27 and 175.75)		(10) Vessel stowage		
							Excep-tions (8A)	Non-bulk (8B)	Bulk (8C)	Passenger aircraft/rail (9A)	Cargo air-craft only (9B)	Loca-tion (10A)	Other (10B)	
D	Cymenes Dangerous Goods in Machinery or Dangerous Goods in Apparatus Decaborane Decahydronaphthalene n-Decane Deflagrating metal salts of aromatic nitroderivatives, n.o.s Delay electric igniter, see Igniters Denatured alcohol	3	UN2046	III	3	B1, IB3, T2, TP1	150	203	242	60 L	220 L	A		
		9	UN3363			136, A105	None	222	None	None	See A105	See A105	A.	
		4.1	UN1868	II	4.1, 6.1	A19, A20, IB6, IP2, T3, TP33	None	212	None	None	Forbidden	50 kg	A	74
		3	UN1147	III	3	B1, IB3, T2, TP1	150	203	242	242	60 L	220 L	A	
		3	UN2247	III	3	B1, IB3, T2, TP1	150	203	242	242	60 L	220 L	A	
		1.3C	UN0132	II	1.3C	None	62	None	None	Forbidden	Forbidden	04	25, 5E
		3	NA1987	II	3	172, T8	150	202	242	242	5 L	60 L	B	
				III	3	172, B1, T7	150	203	242	242	60 L	220 L	A	
		3	UN3379	I	3	164	None	201	None	None	Forbidden	Forbidden	D	36
		4.1	UN3380	I	4.1	164	None	211	None	None	Forbidden	Forbidden	D	28, 36
							62	None	None	Forbidden	Forbidden	05	25
							62	63(f)	None	Forbidden	75 kg	05	25
		G	Detonator assemblies, non-electric for blasting Detonator assemblies, non-electric, for blasting Detonator assemblies, non-electric, for blasting Detonators, electric, for blasting Detonators, electric, for blasting Detonators, electric for blasting Detonators for ammunition Detonators for ammunition Detonators for ammunition Detonators for ammunition Detonators, non-electric, for blasting Detonators, non-electric, for blasting Detonators, non-electric, for blasting	1.1B	UN0360	II	1.1B	None	62	None	Forbidden	Forbidden	05
1.4B	UN0361			II	1.4B	103	63(f)	62	None	Forbidden	75 kg	05	25	
1.4S	UN0500			II	1.4S	347	63(f)	62	None	None	25 kg	100 kg	01	25
1.1B	UN0030			II	1.1B	63(f)	62	None	None	Forbidden	Forbidden	05	25
1.4B	UN0255			II	1.4B	103	63(f)	62	None	None	Forbidden	75 kg	05	25
1.4S	UN0456			II	1.4S	347	63(f)	62	None	None	25 kg	100 kg	01	25
1.1B	UN0073			II	1.1B	63(g)	62	None	None	Forbidden	Forbidden	05	25
1.2B	UN0364			II	1.2B	None	62	None	None	Forbidden	Forbidden	05	25
1.4B	UN0365			II	1.4B	103	None	62	None	None	Forbidden	Forbidden	05	25
1.4S	UN0366			II	1.4S	347	None	62	None	None	Forbidden	75 kg	05	25
1.1B	UN0029			II	1.1B	103	62	None	None	25 kg	100 kg	01	25
1.4B	UN0267			II	1.4B	63(f)	62	None	None	Forbidden	Forbidden	05	25
1.4S	UN0455			II	1.4S	347	63(f)	62	None	None	25 kg	100 kg	01	25

Deuterium, compressed	2.1	UN1857	2.1	N89	306	302	None	Forbidden	150 kg	E	40
Devices, small, hydrocarbon gas powered or hydrocarbon gas re-fills for small devices with release device	2.1	UN3150	2.1		306	304	None		15 kg	B	40
Di-n-amyliamine	3	UN2841	III	B1, IB3, T4, TP1	150	203	242	Forbidden	220 L	A	
Di-n-butyl peroxydicarbonate, with more than 52 percent in solution	3		III								
Di-n-butylamine	8	UN2248	II	IB2, T7, TP2	None	202	243	Forbidden	30 L	A	
2,2-Di-(tert-butylperoxy) butane, with more than 55 percent in solution	Forbidden										
Di-(tert-butylperoxy) phthalate, with more than 55 percent in solution	Forbidden										
2,2-Di-(4,4-di-tert-butylperoxycyclohexyl) propane, with more than 42 percent with inert solid	Forbidden										
Di-2,4-dichlorobenzoyl peroxide, with more than 75 percent with water	Forbidden										
1,2-Di-(dimethylamino)ethane	3	UN2372	II	IB2, T4, TP1	150	202	242	Forbidden	60 L	B	
Di-2-ethylhexyl phosphoric acid, see Diisooctyl acid phosphate											
Di-(1-hydroxytetrazole) (dry)	Forbidden										
Di-(1-naphthyl) peroxide	Forbidden										
a,a'-Di-(nitro) methyl ether	Forbidden										
Di-(beta-nitroxyethyl) ammonium nitrate	Forbidden										
Diacetone alcohol	3	UN1148	II	IB2, T4, TP1	150	202	242	Forbidden	60 L	B	
Diacetone alcohol peroxides, with more than 57 percent in solution	Forbidden		III	B1, IB3, T2, TP1	150	203	242		220 L	A	
with more than 9 percent hydrogen peroxide, less than 26 percent diacetone alcohol and less than 9 percent water; total active oxygen content more than 9 percent by mass											
Diacetyl, see Butanedione											
Diacetyl, peroxide, solid, or with more than 25 percent in solution	Forbidden										
Diallylamine	3	UN2359	II	IB2, T7, TP1	150	202	243	Forbidden	5 L	B	21, 40, 100
Diallyl ether	3	UN2360	II	IB2, N12, T7, TP1, TP13	150	202	243	Forbidden	60 L	E	40
4,4'-Diaminodiphenyl methane	6.1	UN2851	III	IB8, IP3, T1, TP33	153	213	240	Forbidden	200 kg	A	
p-Diazobenzene	Forbidden										
1,2-Diazidoethane	Forbidden										
1,1'-Diazaminonaphthalene	Forbidden										
Diazoaminotetrazole (dry)	Forbidden										

§ 172.101 HAZARDOUS MATERIALS TABLE—Continued

(1) Sym-bols	(2) Hazardous materials descriptions and proper shipping names	(3) Hazard class or Division	(4) Identi-fication Numbers	(5) PG	(6) Label Codes	(7) Special provisions (§ 172.102)	(8) Packaging (§ 173.***)			(9) Quantity limitations (see §§ 173.27 and 175.75)		(10) Vessel stowage		
							Excep-tions (8A)	Non-bulk (8B)	Bulk (8C)	Passenger aircraft/rail (9A)	Cargo air-craft only (9B)	Loca-tion (10A)	Other (10B)	
D	Diazodinitrophenol (dry)	Forbidden 1.1A	UN0074	II	1.1A	111, 117	None	62	None	Forbidden	Forbidden	05	25	
	Diazodinitrophenol, wetted with not less than 40 percent water or mixture of alcohol and water, by mass	Forbidden												
	Diazodiphenylmethane	Forbidden												
	Diazonium nitrates (dry)	Forbidden												
	Diazonium perchlorates (dry)	Forbidden												
	1,3-Diazopropane	Forbidden												
	Dibenzyl peroxycarbonate, with more than 87 percent with water	Forbidden												
	Dibenzylchlorosilane	8	UN2434	II	8		B2, T10, TP2, TP7, TP13	154	206	242	Forbidden	30 L	C	40
	Diborane	2.3	UN1911		2.3, 2.1		1, N89	None	302	None	Forbidden	Forbidden	D	40, 57
	Diborane mixtures	2.1	NA1911		2.1		5	None	302	245	Forbidden	Forbidden	D	40, 57
Dibromoacetylene	Forbidden													
1,2-Dibromobutan-3-one	6.1	UN2648	II	6.1		IB2	153	202	243	5 L	60 L	B	40	
Dibromochloropropane	6.1	UN2872	II	6.1		IB2, T7, TP2	153	202	243	5 L	60 L	A		
			III	6.1		IB3, T4, TP1	153	203	241	60 L	220 L	A		
			III	None		T11, TP2	155	203	241	100 L	220 L	A	25	
A	Dibromodifluoromethane, F12B2	9	UN1941	III	None									
	1,2-Dibromoethane, see Ethylene dibromide													
	Dibromomethane	6.1	UN2664	III	6.1	IB3, T4, TP1	153	203	241	60 L	220 L	A		
	Dibutyl ethers	3	UN1149	III	3	B1, IB3, T2, TP1	150	203	242	60 L	220 L	A		
	Dibutylaminoethanol	6.1	UN2873	III	6.1	IB3, T4, TP1	153	203	241	60 L	220 L	A		
	N,N'-Dichlorozodiacarbonamidine (salts of) (dry)	Forbidden												
D	1,1-Dichloro-1-nitroethane	6.1	UN2650	II	6.1	IB2, T7, TP2	153	202	243	5 L	60 L	A	12, 40, 74	
	3,5-Dichloro-2,4,6-trifluoropyridine	6.1	NA9264	I	6.1	2, B9, B14, B32, T20, TP4, TP13, TP38, TP45	None	227	244	Forbidden	Forbidden	A	40	
	Dichloroacetic acid	8	UN1764	II	8	A3, A6, A7, B2, IB2, N34, T8, TP2	154	202	242	1 L	30 L	A		
	1,3-Dichloroacetone	6.1	UN2649	II	6.1	IB8, IP2, IP4, T3, TP33	153	212	242	25 kg	100 kg	B	12, 40	
	Dichloroacetyl chloride	8	UN1765	II	8	A3, A6, A7, B2, B6, IB2, N34, T7, TP2	154	202	242	1 L	30 L	D		
	Dichloroacetylene	Forbidden												

+	Dichloroanilines, liquid	6.1	UN1590	II	6.1	IB8, IP2, IP4, T3, TP33	153	202	243	5 L	60 L	A	40
	Dichloroanilines, solid	6.1	UN3442	III	6.1	IB3, T4, TP1	153	212	242	25 kg	100 kg	A	40
+	o-Dichlorobenzene	6.1	UN1591	III	6.1	IB2, N33, N34, T7, TP2	153	203	241	60 L	220 L	A	
	2,2-Dichloroethyl ether	6.1, 3	UN1916	II	6.1, 3	IB2, N33, N34, T7, TP2	153	202	243	5 L	60 L	A	
	Dichlorodifluoromethane and difluoroethane azeotropic mixture or Refrigerant gas R 500 with approximately 74 percent dichlorodifluoromethane	2.2	UN2602	II	2.2	T50	306	304	314, 315	75 kg	150 kg	A	
	Dichlorodifluoromethane or Refriger-erant gas R 12	2.2	UN1028	II	2.2	T50	306	304	314, 315	75 kg	150 kg	A	
	Dichlorodimethyl ether, symmetrical	6.1	UN2249	I	6.1, 3	None	None	201	243	Forbidden	Forbidden	B	40
	1,1-Dichloroethane	3	UN2362	II	3	IB2, T4, TP1	150	202	242	5 L	60 L	B	40
	1,2-Dichloroethane, see Ethylene dichloride	Forbidden											
	Dichloroethyl sulfide	3	UN1150	II	3	IB2, T7, TP2	150	202	242	5 L	60 L	B	
	1,2-Dichloroethylene	3	UN1029	II	2.2	IB2, T7, TP2	306	304	314, 315	75 kg	150 kg	A	
	Dichlorofluoromethane or Refriger-erant gas R21	2.2	UN1029	II	2.2	T50	306	304	314, 315	75 kg	150 kg	A	
	Dichloroisocyanuric acid, dry or Dichloroisocyanuric acid salts	5.1	UN2465	II	5.1	28, IB8, IP2, IP4, T3, TP33	152	212	240	5 kg	25 kg	A	13
	Dichloroisopropyl ether	6.1	UN2490	II	6.1	IB2, T7, TP2	153	202	243	5 L	60 L	B	
	Dichloromethane	6.1	UN1593	III	6.1	IB3, IP8, N36, T7, TP2	153	203	241	60 L	220 L	A	
	Dichloroethanes	3	UN1152	III	3	B1, IB3, T2, TP1	150	203	242	60 L	220 L	A	
	Dichlorophenyl isocyanates	6.1	UN2250	II	6.1	IB8, IP2, IP4, T3, TP33	153	212	242	25 kg	100 kg	B	25, 40
	Dichlorophenyltrichlorosilane	8	UN1766	II	8	A7, B2, B6, N34, T10, TP2, TP7, TP13	None	206	242	Forbidden	30 L	C	40
	1,2-Dichloropropane	3	UN1279	II	3	IB2, N36, T4, TP1	150	202	242	5 L	60 L	B	
	1,3-Dichloropropanol-2	6.1	UN2750	II	6.1	IB2, T7, TP2	153	202	243	5 L	60 L	A	12, 40
	Dichloropropene and propylene di-chloride mixture, see 1,2-Dichloropropenes	3	UN2047	II	3	IB2, T4, TP1	150	202	242	5 L	60 L	B	
	Dichloropropenes	3	UN2189	III	3	B1, IB3, T2, TP1	150	203	242	60 L	220 L	A	
	Dichlorosilane	2.3	UN2189	III	2.3, 2.1, 8	2, B9, B14	None	304	314, 315	Forbidden	Forbidden	D	17, 40
	1,2-Dichloro-1,1,2,2-tetrafluoroethane or Refrigerant gas R 114	2.2	UN1958	II	2.2	T50	306	304	314, 315	75 kg	150 kg	A	
	Dichlorovinylchloroarsine	Forbidden											
	Dicycloheptadiene, see Bicyclo[2.2.1]hepta-2,5-diene, stabilized	8	UN2565	III	8	IB3, T4, TP1	154	203	241	5 L	60 L	A	
	Dicyclohexylamine	4.1	UN2687	III	4.1	IB8, IP3, T1, TP33	151	213	240	25 kg	100 kg	A	25
	Dicyclohexylammonium nitrite	3	UN2048	III	3	B1, IB3, T2, TP1	150	203	242	60 L	220 L	A	
	Dicyclopentadiene	5.1	UN1465	III	5.1	A1, IB8, IP3, T1, TP33	152	213	240	25 kg	100 kg	A	
D	Didymium nitrate	3	NA1993	III	None	144, B1, IB3, T4, TP1, TP29	150	203	242	60 L	220 L	A	
I	Diesel fuel	3	UN1202	III	3	144, B1, IB3, T2, TP1	150	203	242	60 L	220 L	A	

§ 172.101 HAZARDOUS MATERIALS TABLE—Continued

(1) Sym-bols	(2) Hazardous materials descriptions and proper shipping names	(3) Hazard class or Division	(4) Identi-fication Numbers	(5) PG	(6) Label Codes	(7) Special provisions (§ 172.102)	(8) Packaging (§ 173.***)			(9) Quantity limitations (see §§ 173.27 and 175.75)			(10) Vessel stowage	
							Excep-tions (8A)	Non-bulk (8B)	Bulk (8C)	Passenger aircraft/rail (9A)	Cargo air-craft only (9B)	Loca-tion (10A)	Other (10B)	
+	<i>Diethanol nitrosamine dinitrate (dry)</i>	Forbidden	UN2373	II	3	IB2, T4, TP1	150	202	242	5 L	60 L	E		
	<i>Diethoxyamine</i>	3	UN2374	II	3	IB2, T4, TP1	150	202	242	5 L	60 L	B		
	<i>3,3-Diethoxypropene</i>	3	UN2366	III	3	B1, B3, T2, TP1	150	203	242	60 L	220 L	A		
	<i>Diethyl carbonate</i>	3												
	<i>Diethyl cellosolve, see Ethylene glycol diethyl ether</i>	3	UN1155	I	3	T11, TP2	150	201	243	1 L	30 L	E	40	
	<i>Diethyl ether or Ethyl ether</i>	3	UN1156	II	3	IB2, T4, TP1	150	202	242	5 L	60 L	B		
	<i>Diethyl peroxycarbonate, with more than 27 percent in solution</i>	Forbidden												
	<i>Diethyl sulfate</i>	6.1	UN1594	II	6.1	IB2, T7, TP2	153	202	243	5 L	60 L	C		
	<i>Diethyl sulfide</i>	3	UN2375	II	3	IB2, T7, TP1, TP13	None	202	243	5 L	60 L	E		
	<i>Diethylamine</i>	3	UN1154	II	3, 8	A3, IB2, N34, T7, TP1	150	202	243	1 L	5 L	E	40	
	<i>2-Diethylaminoethanol</i>	8	UN2686	II	8, 3	B2, IB2, T7, TP2	None	202	243	1 L	30 L	A		
	<i>3-Diethylnitropropylamine.</i>	3	UN2684	III	3, 8	B1, B3, T4, TP1	150	203	242	5 L	60 L	A		
	<i>N, N-Diethylaniline</i>	6.1	UN2432	III	6.1	IB3, T4, TP1	153	203	241	60 L	220 L	A		
	<i>Diethylbenzene</i>	3	UN2049	III	3	B1, B3, T2, TP1	150	203	242	60 L	220 L	A		
	<i>Diethylchlorosilane</i>	8	UN1767	II	8, 3	A7, B6, N34, T10, TP2, TP7, TP13	None	206	243	Forbidden	30 L	C	40	
<i>Diethylene glycol dinitrate</i>	Forbidden													
<i>Diethyleneglycol dinitrate, desensitized with not less than 25 percent non-volatile water-insoluble phlegmatizer, by mass</i>	1.1D	UN0075	II	1.1D	None	62	None	Forbidden	Forbidden	04	25, 21E		
<i>Diethylenetriamine</i>	8	UN2079	II	8	B2, IB2, T7, TP2	154	202	242	1 L	30 L	A	40, 52		
<i>N,N-Diethylethylenediamine</i>	8	UN2685	II	8, 3	IB2, T7, TP2	None	202	243	1 L	30 L	A			
<i>Diethylglycid bromide</i>	Forbidden													
<i>Diethylthiophosphoryl chloride</i>	8	UN2751	II	8	B2, IB2, T7, TP2	None	212	240	15 kg	50 kg	D	12, 40		
<i>Difluorochloroethanes, see 1-Chloro-1,1-difluoroethanes</i>														
<i>1,1-Difluoroethane or Refrigerant gas R 152a</i>	2.1	UN1030	2.1	2.1	T50	306	304	314, 315	Forbidden	150 kg	B	40		
<i>1,1-Difluoroethylene or Refrigerant gas R 1132a</i>	2.1	UN1959	2.1	2.1	T50	306	304	None	Forbidden	150 kg	E	40		
<i>Difluoromethane or Refrigerant gas R 32</i>	2.1	UN3252	2.1	2.1	T50	306	302	314, 315	Forbidden	150 kg	D	40		
<i>Difluorophosphoric acid, anhydrous</i>	8	UN1768	II	8	A6, A7, B2, IB2, N5, N34, T8, TP2	None	202	242	1 L	30 L	A	40		

UN number	Proper shipping name	Quantity	Label	Special provisions	PG	202	242	5 L	60 L	B	Other
UN2376	2,3-Dihydroxyran 1,8-Dihydroxy-2,4,5,7- tetranitroanthraquinone (chrysaminic acid)	3	Forbidden	II	3	150	202	242	60 L	B	
UN1157	Dioacetylelene	3	Forbidden	III	3	150	203	242	220 L	A	
UN2361	Diisobutyl ketone	3	Forbidden	III	3, 8	150	203	242	5 L	A	
UN2050	Diisobutylamine	3	Forbidden	II	3	150	202	242	5 L	B	
UN1902	Diisobutylene, isomeric compounds	8	Forbidden	III	8	154	203	241	60 L	A	
UN1159	Diisocetyl acid phosphate	3	Forbidden	III	3	150	202	242	5 L	E	40
UN1158	Diisopropylamine	3	Forbidden	II	3, 8	150	202	243	5 L	B	
UN2521	Diisopropylbenzene hydroperoxide, with more than 72 percent in so- lution	6.1	Forbidden	I	6.1, 3	None	227	244	Forbidden	D	26, 27, 40
UN2252	Diketene, stabilized	3	Forbidden	II	3	150	202	242	60 L	B	
UN2377	1,2-Dimethoxyethane	3	Forbidden	II	3	150	202	242	5 L	B	
UN1161	1,1-Dimethoxyethane	3	Forbidden	II	3	150	202	242	5 L	B	
UN2381	Dimethyl carbonate	3	Forbidden	II	3	150	202	242	5 L	B	
UN2381	Dimethyl chlorothiophosphate, see Dimethyl thiophosphoryl chloride	3	Forbidden	II	3, 6.1	150	202	242	Forbidden	B	40
UN1033	2,5-Dimethyl-2,5-dihydroperoxy hexane, with more than 62 per- cent with water	2.1	Forbidden	II	2.1	306	304	314, 315	Forbidden	B	40
UN2266	Dimethyl disulfide	3	Forbidden	II	3, 8	150	202	243	150 kg	B	40
UN1595	Dimethyl ether	6.1	Forbidden	I	6.1, 8	None	227	244	Forbidden	D	40
UN1164	Dimethyl-N-propylamine	3	Forbidden	II	3	150	202	242	5 L	E	40
UN2267	Dimethyl sulfide	6.1	Forbidden	II	6.1, 8	153	202	243	30 L	B	25
UN1032	Dimethylamine, anhydrous	2.1	Forbidden	II	2.1	None	304	314, 315	150 kg	D	40
UN1160	Dimethylamine solution	3	Forbidden	II	3, 8	150	202	243	5 L	B	52
UN2378	2-Dimethylaminoacetone	3	Forbidden	II	3, 6.1	150	202	243	1 L	A	40, 52
UN2051	2-Dimethylaminoethanol	8	Forbidden	II	8, 3	154	202	243	30 L	A	
UN3302	2-Dimethylaminoethyl acrylate	6.1	Forbidden	II	6.1	153	202	243	5 L	D	25
UN2522	2-Dimethylaminoethyl methacrylate	6.1	Forbidden	II	6.1	153	202	243	5 L	B	40
UN2457	N,N-Dimethylaniline	3	Forbidden	II	3	150	202	242	60 L	A	
UN2379	1, 3-Dimethylbutane	3	Forbidden	II	3, 8	150	202	242	5 L	E	52
UN2262	3-Dimethylbutylamine	8	Forbidden	II	8	154	202	242	1 L	B	40
UN2263	Dimethylcarbamoyl chloride	3	Forbidden	II	3	150	202	242	30 L	A	40
UN2264	Dimethylcyclohexanes	3	Forbidden	II	3	154	202	242	5 L	B	40
UN1162	N,N-Dimethylcyclohexylamine	8	Forbidden	II	8, 3	154	202	243	30 L	A	40
UN2380	Dimethyldichlorosilane	3	Forbidden	II	3, 8	None	206	243	Forbidden	B	40
UN2380	Dimethyldiethoxysilane	3	Forbidden	II	3	150	202	242	5 L	B	

§ 172.101 HAZARDOUS MATERIALS TABLE—Continued

(1) Sym-bols	(2) Hazardous materials descriptions and proper shipping names	(3) Hazard class or Division	(4) Identi-fication Numbers	(5) PG	(6) Label Codes	(7) Special provisions (§ 172.102)	(8) Packaging (§ 173.***)			(9) Quantity limitations (see §§ 173.27 and 175.75)		(10) Vessel stowage	
							Excep-tions (8A)	Non-bulk (8B)	Bulk (8C)	Passenger aircraft/rail (9A)	Cargo air-craft only (9B)	Loca-tion (10A)	Other (10B)
	Dimethyldioxanes	3	UN2707	II	3	IB2, T4, TP1	150	202	242	5 L	60 L	B	
	N,N-Dimethylformamide	3	UN2265	III	3	B1, IB3, T2, TP1	150	203	242	60 L	220 L	A	
	Dimethylhexane dihydroperoxide (dry)	Forbidden		III	3	B1, IB3, T2, TP2	150	203	242	60 L	220 L	A	
	Dimethylhydrazine, symmetrical	6.1	UN2382	I	6.1, 3	2, B9, B14, B32, B77, T20, TP2, TP13, TP38, TP45	None	227	244	Forbidden	Forbidden	D	40, 52, 74
	Dimethylhydrazine, unsymmetrical	6.1	UN1163	I	6.1, 3, 8	2, B7, B9, B14, B32, T20, TP2, TP13, TP38, TP45	None	227	244	Forbidden	Forbidden	D	21, 38, 40, 52, 100, 40
	2,2-Dimethylpropane	2.1	UN2044		2.1	IB8, IP2, IP4, T3, TP33	306	304	314, 315	Forbidden	150 kg	E	
	Dinitro-o-cresol	6.1	UN1598	II	6.1	IB8, IP2, IP4, T3, TP33	153	212	242	25 kg	100 kg	A	
	1,3-Dinitro-5,5-dimethyl hydantoin	Forbidden											
	Dinitro-7,8-dimethylglycoluril (dry)	Forbidden											
	1,3-Dinitro-4,5-dinitrobenzene	Forbidden											
	1,4-Dinitro-1,1,4,4-tetramethylolbutanetetrahydrate (dry)	Forbidden											
	2,4-Dinitro-1,3,5-trimethylbenzene	6.1	UN1596	II	6.1	IB8, IP2, IP4, T3, TP33	153	212	242	25 kg	100 kg	A	91
	Dinitroanilines	6.1	UN1597	II	6.1	11, IB2, T7, TP2	153	202	243	5 L	60 L	A	91
	Dinitrobenzenes, liquid	6.1	UN1597	III	6.1	11, IB3, T7, TP2	153	203	241	60 L	220 L	A	91
	Dinitrobenzenes, solid	6.1	UN3443	II	6.1	IB8, IP2, IP4, T3, TP33	153	212	242	25 kg	100 kg	A	91
	Dinitrochlorobenzene, Chlorodinitrobenzene	see											
	1,2-Dinitroethane	Forbidden											
	1,1-Dinitroethane (dry)	Forbidden											
	Dinitrogen tetroxide	2.3	UN1067		2, 3, 5, 1, 8	1, B7, B14, B45, B46, B61, B66, B67, B77, T50, TP21	None	336	314	Forbidden	Forbidden	D	40, 89, 90
	Dinitroglucuril or Dingu	1,1D	UN0489	II	1,1D	None	62	None	Forbidden	Forbidden	04	25
	Dinitromethane	Forbidden											
	Dinitrophenol, dry or wetted with less than 15 percent water, by mass	1,1D	UN0076	II	1,1D, 6.1	None	62	None	Forbidden	Forbidden	04	25, 5E
	Dinitrophenol solutions	6.1	UN1599	II	6.1	IB2, T7, TP2	153	202	243	5 L	60 L	A	36

Dinitrophenol, wetted with not less than 15 percent water, by mass	4.1	UN1320	III	6.1, 4.1, 6.1	IB3, T4, TP1	203	241	60 L 1 kg	220 L 15 kg	A	36 28, 36
Dinitrophenolates alkali metals, dry or wetted with less than 15 percent water, by mass	1.3C	UN0077	I	1.3C, 6.1	23, A8, A19, A20, N41	211	None	None	E	E	
Dinitrophenolates, wetted with not less than 15 percent water, by mass	4.1	UN1321	I	4.1, 6.1	23, A8, A19, A20, N41	211	None	1 kg	15 kg	E	28, 36
Dinitropropylene glycol	Forbidden							Forbidden	Forbidden	04	25, 5E
Dinitroresorcinol, dry or wetted with less than 15 percent water, by mass	1.1D	UN0078	II	1.1D		62	None	None			
2,4-Dinitroresorcinol (heavy metal salts of)	Forbidden										
4,6-Dinitroresorcinol (heavy metal salts of) (dry)	Forbidden										
Dinitroresorcinol, wetted with not less than 15 percent water, by mass	4.1	UN1322	I	4.1	23, A8, A19, A20, N41	211	None	1 kg	15 kg	E	28, 36
3,5-Dinitrosalicylic acid (lead salt) (dry)	Forbidden										
Dinitrosobenzene	1.3C	UN0406	II	1.3C		62	None	Forbidden	Forbidden	04	25
2,2-Dinitrostilbene	Forbidden										
Dinitrotoluenes, liquid	6.1	UN2038	II	6.1	IB2, T7, TP2	202	243	5 L	60 L	A	
Dinitrotoluenes, molten	6.1	UN1600	II	6.1	T7, TP3	202	243	Forbidden	Forbidden	C	
Dinitrotoluenes, solid	6.1	UN3454	II	6.1	IB8, IP2, IP4, T3, TP33	212	242	25 kg	100 kg	A	
1,9-Dinitroxy-pentamethylene-2,4,6,8-tetramine (dry)	3	UN1165	II	3	IB2, T4, TP1	202	242	5 L	60 L	B	40
Dioxane	3	UN1166	II	3	IB2, T4, TP1	202	242	5 L	60 L	B	40
Dioxolane	3	UN2052	III	3	B1, IB3, T2, TP1	203	242	60 L	220 L	A	
Dipentene	6.1	UN1698	I	6.1	T6, TP33	201	None	Forbidden	Forbidden	D	40
Diphenylamine chloroarsine	6.1	UN1699	I	6.1	A8, B14, B32, N33, N34, T14, TP2, TP13, TP27	201	243	Forbidden	30 L	D	40
Diphenylchloroarsine, liquid	6.1	UN3450	I	6.1	IB7, IP1, T6, TP33	211	242	5 kg	50 kg	D	40
Diphenylchloroarsine, solid	8	UN1769	II	8	A7, B2, N34, T10, TP2, TP7, TP13	206	242	Forbidden	30 L	C	40
Diphenyldichlorosilane	1.1D	UN1770	II	8	IB8, IP2, IP4, T3, TP33	212	240	15 kg	50 kg	D	40
Diphenylmethyl bromide	8	UN0401	II	1.1D		62	None	Forbidden	Forbidden	04	25
Dipicryl sulfide, dry or wetted with less than 10 percent water, by mass	4.1	UN2852	I	4.1	162, A2, N41, N84	211	None	Forbidden	0.5 kg	D	28
Dipicryl sulfide, wetted with not less than 10 percent water, by mass											
Dipicylamine, see Hexanitrodiphenylamine											
Hexanitrodiphenylamine	Forbidden										
Dipropionyl peroxide, with more than 28 percent in solution	3	UN2384	II	3	IB2, T4, TP1	202	242	5 L	60 L	B	
Di-n-propyl ether	3	UN2710	III	3	B1, IB3, T2, TP1	203	242	60 L	220 L	A	
Dipropyl ketone											

§ 172.101 HAZARDOUS MATERIALS TABLE—Continued

(1) Sym-bols	(2) Hazardous materials descriptions and proper shipping names	(3) Hazard class or Division	(4) Identi-fication Numbers	(5) PG	(6) Label Codes	(7) Special provisions (§ 172.102)	(8) Packaging (§ 173.***)			(9) Quantity limitations (see §§ 173.27 and 175.75)		(10) Vessel stowage	
							Excep-tions (8A)	Non-bulk (8B)	Bulk (8C)	Passenger aircraft/rail (9A)	Cargo air-craft only (9B)	Loca-tion (10A)	Other (10B)
G	Dipropylamine Disinfectant, liquid, corrosive, n.o.s.	3 8	UN2383 UN1903	II I	3, 8	A6, A7, B10, T14, TP2, TP27	None	202	1 L	5 L	B	B	
								201	0.5 L	2.5 L			
G	Disinfectants, liquid, corrosive n.o.s.	8	UN1903	III	8	B2, IB2, T7, TP2	154	202	1 L	30 L	B	A	
								203	5 L	60 L			
G	Disinfectants, liquid, toxic, n.o.s.	6.1	UN3142	I	6.1	A4, T14, TP2, TP27	None	201	1 L	30 L	A	A	
								202	5 L	60 L			
G	Disinfectants, solid, toxic, n.o.s.	6.1	UN1601	III	6.1	IB3, T7, TP1, TP28	153	203	60 L	220 L	A	A	
								204	5 kg	50 kg			
G	Disodium trioxosilicate Dispersant gases, n.o.s. see Refrigerant gases, n.o.s. Divinyl ether, stabilized Dodecyltrichlorosilane	8	UN3253	III	8	IB8, IP3, T3, TP33	153	212	25 kg	100 kg	A	A	
								213	100 kg	200 kg			
G	Dry ice, see Carbon dioxide, solid Dyes, liquid, toxic, n.o.s. or Dye intermediates, liquid, toxic, corrosive, n.o.s.	3 8	UN1167 UN1771	I II	3 8	A7, B2, B6, N34, T10, TP2, TP7, TP13	None	201	1 L	30 L	E	40	
								206	Forbidden	30 L			
G	Dyes, liquid, toxic, n.o.s. or Dye intermediates, liquid, toxic, n.o.s.	8	UN2801	I	8	11, A6, B10, T14, TP2, TP27	None	201	0.5 L	2.5 L	A	A	
								202	1 L	30 L			
G	Dyes, liquid, toxic, n.o.s. or Dye intermediates, liquid, toxic, n.o.s.	6.1	UN1602	III	6.1	11, B2, IB2, T11, TP2, TP27	154	203	5 L	60 L	A	A	
								201	1 L	30 L			
G	Dyes, solid, corrosive, n.o.s. or Dye intermediates, solid, corrosive, n.o.s.	8	UN3147	II	6.1	IB7, IP1, T6, TP33	153	202	5 L	60 L	A	A	
								203	60 L	220 L			
G	Dyes, solid, toxic, n.o.s. or Dye intermediates, solid, toxic, n.o.s.	6.1	UN3143	I	6.1	IB8, IP2, IP4, T3, TP33	154	212	15 kg	50 kg	A	A	
								213	25 kg	100 kg			
G	Dyes, solid, toxic, n.o.s. or Dye intermediates, solid, toxic, n.o.s.	6.1	UN3143	I	6.1	A5, IB7, IP1, T6, TP33	None	211	5 kg	50 kg	A	A	
								242	25 kg	100 kg			
G	Dyes, solid, toxic, n.o.s. or Dye intermediates, solid, toxic, n.o.s.	6.1	UN3143	II	6.1	IB8, IP2, IP4, T3, TP33	153	212	25 kg	100 kg	A	A	
								213	100 kg	200 kg			

G	Dynamite, <i>see</i> Explosive, blasting, type A. Electrolyte (acid or alkali) for batteries, <i>see</i> Battery fluid, acid or Battery fluid, alkali Elevated temperature liquid, flammable, n.o.s., with flash point above 37.8 C, at or above its flash point	3	UN3256	III	3	IB1, T3, TP3, TP29	None	247	Forbidden	Forbidden	A	85
G	Elevated temperature liquid, n.o.s., at or above 100 C and below its flash point (including molten metals, molten salts, etc.)	9	UN3257	III	9	IB1, T3, TP3, TP29	None	247	Forbidden	Forbidden	A	85
G	Elevated temperature liquid, n.o.s., at or above 240 C, <i>see</i> § 173.247(h)(4)	9	UN3258	III	9		247 (h)(4)	247	Forbidden	Forbidden	A	85
G	Engines, internal combustion, or Engines, fuel cell, flammable gas powered	9	UN3166	9	135, A200	220	220	Forbidden	No limit	A	
G	Engines internal combustion, or Engines, fuel cell, flammable liquid powered	9	UN3166	9	135, A200	220	220	No limit	No limit	A	
G	Environmentally hazardous substance, liquid, n.o.s.	9	UN3082	III	9	8, 146, 173, 335, IB3, T4, TP1, TP29	155	241	No limit	No limit	A	
G	Environmentally hazardous substances, solid, n.o.s	9	UN3077	III	9	8, 146, 335, A112, B54, B120, IB8, IP3, N20, N91, T1, TP33	155	240	No Limit	No Limit	A	
+	Epibromohydrin	6.1	UN2558	I	6.1, 3	T14, TP2, TP13	None	243	Forbidden	Forbidden	D	40
	Epichlorohydrin	6.1	UN2023	II	6.1, 3	IB2, T7, TP2, TP13	153	243	5 L	60 L	A	40
	1,2-Epoxy-3-ethoxypropane	3	UN2752	III	3	B1, IB3, T2, TP1	150	242	60 L	220 L	A	
	Esters, n.o.s.	3	UN3272	II	3	IB2, T7, TP1, TP8, TP28	150	242	5 L	60 L	B	
D	Etching acid, liquid, n.o.s., <i>see</i> Hydrofluoric acid, etc	2.1	UN1035	II	3	B1, IB3, T4, TP1, TP29	150	242	60 L	220 L	A	
	Ethane	2.1	NA1961	II	3		306	302	Forbidden	150 kg	E	40
	Ethane-Propane mixture, refrigerated liquid	2.1	NA1961	II	3	T75, TP5	None	314, 315	Forbidden	Forbidden	D	40
	Ethane, refrigerated liquid	2.1	UN1961	II	3	T75, TP5	None	315	Forbidden	Forbidden	D	40
	Ethanol amine dinitrate	Forbidden										
	Ethanol and gasoline mixture or Ethanol and motor spirit mixture or Ethanol and petrol mixture, with more than 10% ethanol	3	UN3475	II	3	144, 177, IB2, T4, TP1	150	242	5 L	60 L	E	
Ethanol or Ethyl alcohol or Ethanol solutions or Ethyl alcohol solutions	3	UN1170	II	3	24, IB2, T4, TP1	4b, 150	242	242	5 L	60 L	A	
Ethanolamine or Ethanolamine solutions	8	UN2491	III	8	24, B1, IB3, T2, TP1, IB3, T4, TP1	4b, 150	242	242	60 L	220 L	A	52.
Ether, <i>see</i> Diethyl ether							241	241	5 L	60 L	A	

§ 172.101 HAZARDOUS MATERIALS TABLE—Continued

(1) Sym-bols	(2) Hazardous materials descriptions and proper shipping names	(3) Hazard class or Division	(4) Identi-fication Numbers	(5) PG	(6) Label Codes	(7) Special provisions (§ 172.102)	(8) Packaging (§ 173.***)			(9) Quantity limitations (see §§ 173.27 and 175.75)		(10) Vessel stowage	
							(8A) Excep-tions	(8B) Non-bulk	(8C) Bulk	(9A) Passenger aircraft/rail	(9B) Cargo air-craft only	(10A) Loca-tion	(10B) Other
	Ethers, n.o.s.	3	UN3271	II	3	IB2, T7, TP1, TP8, TP28	150	202	242	5 L	60 L	B	
	Ethyl acetate	3	UN1173	III	3	B1, IB3, T4, TP1, TP29	150	203	242	60 L	220 L	A	
	Ethyl acrylate, stabilized	3	UN1917	II	3	IB2, T4, TP1	150	202	242	5 L	60 L	B	40
	Ethyl alcohol, see Ethanol												
	Ethyl aldehyde, see Acetaldehyde												
	Ethyl amyl ketone	3	UN2271	III	3	B1, IB3, T2, TP1	150	203	242	60 L	220 L	A	
	N-Ethylbenzyltoluidines, solid	6.1	UN3460	III	6.1	IB8, IP3, T1, TP33	153	213	240	100 kg	200 kg	A	
	N-Ethyl-N-benzylaniline	6.1	UN2274	III	6.1	IB3, T4, TP1	153	203	241	60 L	220 L	A	
	Ethyl borate	3	UN1176	II	3	IB2, T4, TP1	150	202	242	5 L	60 L	B	
	Ethyl bromide	6.1	UN1891	II	6.1	IB2, IP8, T7, TP2, TP13	153	202	243	5 L	60 L	B	40, 85
	Ethyl bromoacetate	6.1	UN1603	II	6.1, 3	IB2, T7, TP2	None	202	242	Forbidden	Forbidden	D	40
	Ethyl butyl ether	3	UN1179	II	3	B1, IB2, T4, TP1	150	202	242	5 L	60 L	B	
	Ethyl butyrate	3	UN1180	III	3	B1, IB3, T2, TP1	150	203	242	60 L	220 L	A	
	Ethyl chloride	2.1	UN1037	II	2.1	B77, N86, T50	None	322	314,	Forbidden	150 kg	B	40
	Ethyl chloroacetate	6.1	UN1181	II	6.1, 3	IB2, T7, TP2	153	202	243	5 L	60 L	A	
	Ethyl chloroformate	6.1	UN1182	I	6.1, 3, 8	2, B9, B14, B32, N34, T20, TP2, TP13, TP38, TP45	None	227	244	Forbidden	Forbidden	D	21, 40, 100
	Ethyl 2-chloropropionate	3	UN2935	III	3	B1, IB3, T2, TP1	150	203	242	60 L	220 L	A	40
	Ethyl chloroethioformate	8	UN2826	II	8, 6.1, 3	2, B9, B14, B32, T20, TP2, TP38, TP45	None	227	244	Forbidden	Forbidden	A	
	Ethyl crotonate	3	UN1862	II	3	IB2, T4, TP2	150	202	242	5 L	60 L	B	
	Ethyl ether, see Diethyl ether												
	Ethyl fluoride or Refrigerant gas R161	2.1	UN2453	II	2.1		306	304	314,	Forbidden	150 kg	E	40
	Ethyl formate	3	UN1190	II	3	IB2, T4, TP1	150	202	242	5 L	60 L	E	
	Ethyl hydroperoxide	Forbidden											
	Ethyl isobutyrate	3	UN2385	II	3	IB2, T4, TP1	150	202	242	5 L	60 L	B	
	Ethyl isocyanate	6.1	UN2481	I	6.1, 3	1, B9, B14, B30, T20, TP2, TP13, TP38, TP44	None	226	244	Forbidden	Forbidden	D	40, 52
	Ethyl lactate	3	UN1192	III	3	B1, IB3, T2, TP1	150	203	242	60 L	220 L	A	
	Ethyl mercaptan	3	UN2363	I	3	A6, T11, TP2, TP13	None	201	243	Forbidden	30 L	E	95, 102
	Ethyl methacrylate, stabilized	3	UN2277	II	3	IB2, T4, TP1	150	202	242	5 L	60 L	B	
	Ethyl methyl ether	2.1	UN1039	II	2.1		None	201	314,	Forbidden	150 kg	B	40

UN number	Proper shipping name	Class	Division	Subdivision	Special provisions	Quantity	Label	Placard	Other
UN1193	Ethyl methyl ketone or Methyl ethyl ketone	3	II	3	IB2, T4, TP1	150	None	60 L	B
UN1194	Ethyl nitrite solutions	3	I	3, 6.1	None	201	None	Forbiddn	E
UN2524	Ethyl orthoformate	3	III	3	B1, IB3, T2, TP1	150	242	60 L	A
UN2525	Ethyl oxalate	6.1	III	6.1	IB3, T4, TP1	153	241	220 L	A
NA2927	Ethyl perchlorate	Forbiddn					244	Forbiddn	D
NA2927	Ethyl phosphonoethioic dichloride, anhydrous	6.1	I	6.1, 8	2, B9, B14, B32, T20, TP4, TP12, TP13, TP38, TP45	None	244	Forbiddn	D
NA2845	Ethyl phosphonous dichloride, anhydrous pyrophoric liquid	6.1	I	6.1, 4.2	2, B9, B14, B32, T20, TP4, TP12, TP13, TP38, TP45	None	244	Forbiddn	D
NA2927	Ethyl phosphorodichloridate	6.1	I	6.1, 8	2, B9, B14, B32, T20, TP4, TP12, TP13, TP38, TP45	None	244	Forbiddn	D
UN1195	Ethyl propionate	3	II	3	IB2, T4, TP1	150	242	5 L	B
UN2615	Ethyl propyl ether	3	II	3	IB2, T4, TP1	150	242	5 L	E
UN2452	Ethyl silicate, see Tetraethyl silicate	2.1		2.1	N88	None	314, 315	150 kg	B
UN2452	Ethylacetylene, stabilized	2.1		2.1	B77, N87, T50	None	314, 315	150 kg	D
UN1036	Ethylamine	2.1	II	3, 8	IB2, T7, TP1	150	243	1 L	B
UN2270	Ethylamine, aqueous solution with not less than 50 percent but not more than 70 percent ethylamine	3	II	3, 8	IB2, T7, TP1	150	243	5 L	B
UN2272	N-Ethylaniline	6.1	III	6.1	IB3, T4, TP1	153	241	60 L	A
UN2273	2-Ethylaniline	6.1	III	6.1	IB3, T4, TP1	153	241	220 L	A
UN1175	Ethylbenzene	3	II	3	IB2, T4, TP1	150	242	5 L	B
UN2753	N-Ethylbenzyloluidines liquid	6.1	III	6.1	IB3, T7, TP1	153	241	60 L	A
UN2275	2-Ethylbutanol	3	III	3	B1, IB3, T2, TP1	150	242	60 L	A
UN1177	2-Ethylbutyl acetate	3	III	3	B1, IB3, T2, TP1	150	242	60 L	A
UN1178	2-Ethylbutylaldehyde	3	III	3	B1, IB2, T4, TP1	150	242	60 L	A
UN1892	Ethylchloroarsine	6.1	I	6.1	2, B9, B14, B32, T20, TP2, TP13, TP38, TP45	None	244	Forbiddn	D
UN1183	Ethyldichlorosilane	4.3	I	4.3, 8, 3	A2, A3, A7, N34, T14, TP2, TP7, TP13	None	244	1 L	D
UN3138	Ethylene, acetylene and propylene in mixture, refrigerated liquid with at least 71.5 percent ethylene with not more than 22.5 percent acetylene and not more than 6 percent propylene	2.1		2.1	T75, TP5	None	314, 315	Forbiddn	D
UN1135	Ethylene chlorohydrin	6.1	I	6.1, 3	2, B9, B14, B32, T20, TP2, TP13, TP38, TP45	None	244	Forbiddn	D
UN1962	Ethylene diamine diperchlorate	2.1		2.1	2, B9, B14, B32, B77, T20, TP2, TP13, TP38, TP45	306	302	150 kg	E
UN1605	Ethylene dibromide	6.1	I	6.1	2, B9, B14, B32, B77, T20, TP2, TP13, TP38, TP45	None	244	Forbiddn	D

§ 172.101 HAZARDOUS MATERIALS TABLE—Continued

(1) Sym-bols	(2) Hazardous materials descriptions and proper shipping names	(3) Hazard class or Division	(4) Identi-fication Numbers	(5) PG	(6) Label Codes	(7) Special provisions (§ 172.102)	(8) Packaging (§ 173.***)			(9) Quantity limitations (see §§ 173.27 and 175.75)		(10) Vessel stowage	
							Excep-tions	Non-bulk	Bulk	Passenger aircraft/rail	Cargo air-craft only	Loca-tion	Other
(1)	(2)	(3)	(4)	(5)	(6)	(7)	(8A)	(8B)	(8C)	(9A)	(9B)	(10A)	(10B)
	<i>Ethylene dibromide and methyl bromide liquid mixtures, see Methyl bromide and ethylene dibromide, liquid mixtures</i>	3	UN1184	II	3, 6.1	IB2, N36, T7, TP1	150	202	243	1 L	60 L	B	40
	Ethylene dichloride	3	UN1153	III	3	IB2, T4, TP1	150	202	242	5 L	60 L	A	
	Ethylene glycol diethyl ether	Forbidden		III	3	B1, IB3, T2, TP1	150	203	242	60 L	220 L	A	
	<i>Ethylene glycol dinitrate</i>	3	UN1171	III	3	B1, IB3, T2, TP1	150	203	242	60 L	220 L	A	
	Ethylene glycol monoethyl ether	3	UN1172	III	3	B1, IB3, T2, TP1	150	203	242	60 L	220 L	A	
	Ethylene glycol monoethyl ether acetate	3	UN1188	III	3	B1, IB3, T2, TP1	150	203	242	60 L	220 L	A	
	Ethylene glycol monomethyl ether	3	UN1189	III	3	B1, IB3, T2, TP1	150	203	242	60 L	220 L	A	
	Ethylene oxide and carbon dioxide mixture with more than 87 percent ethylene oxide	2.3	UN3300		2.3, 2.1	4	None	304	314, 315	Forbidden	Forbidden	D	40
	Ethylene oxide and carbon dioxide mixtures with more than 9 percent but not more than 87 percent ethylene oxide	2.1	UN1041		2.1	T50	306	304	314, 315	Forbidden	25 kg	B	40
	Ethylene oxide and carbon dioxide mixtures with not more than 9 percent ethylene oxide	2.2	UN1952		2.2		306	304	314, 315	75 kg	150 kg	A	
	Ethylene oxide and chlorotetrafluoroethane mixture with not more than 8.8 percent ethylene oxide	2.2	UN3297		2.2	T50	306	304	314, 315	75 kg	150 kg	A	
	Ethylene oxide and dichlorodifluoromethane mixture, with not more than 12.5 percent ethylene oxide	2.2	UN3070		2.2	T50	306	304	314, 315	75 kg	150 kg	A	
	Ethylene oxide and pentafluoroethane mixture with not more than 7.9 percent ethylene oxide	2.2	UN3298		2.2	T50	306	304	314, 315	75 kg	150 kg	A	
	Ethylene oxide and propylene oxide mixtures, with not more than 30 percent ethylene oxide	3	UN2983	I	3, 6.1	5, A11, N4, N34, T14, TP2, TP7, TP13	None	201	243	Forbidden	30 L	E	40

	2.2	UN3299	2.2	2.2	T50	306	304	314, 315	75 kg	150 kg	A	
Ethylene oxide and tetrafluoroethane mixture with not more than 5.6 percent ethylene oxide			2.2									
Ethylene oxide or Ethylene oxide with nitrogen up to a total pressure of 1 MPa (10 bar) at 50 degrees C	2.3	UN1040	2.3, 2.1	4, 342, T50, TP20	None	323	323	323	Forbidden	Forbidden	D	40
Ethylene, refrigerated liquid (cryogenic liquid)	2.1	UN1038	2.1	T75, TP5	None	316	316	318, 319	Forbidden	Forbidden	D	40
Ethylenediamine	8	UN1604	8, 3	IB2, T7, TP2	154	202	202	243	1 L	30 L	A	40, 52
Ethyleneimine, stabilized	6.1	UN1185	6.1, 3	1, B9, B14, B30, B77, N25, N32, T22, TP2, TP13, TP36, TP44	None	226	226	244	Forbidden	Forbidden	D	40
Ethylhexaldehyde, see Octyl aldehydes etc												
2-Ethylhexyl chloroformate	6.1	UN2748	6.1, 8	IB2, T7, TP2, TP13	153	202	202	243	1 L	30 L	A	12, 13, 21, 25, 40, 100
2-Ethylhexylamine	3	UN2276	3, 8	B1, IB3, T4, TP1	150	203	203	242	5 L	60 L	A	40
Ethylphenylchlorosilane	8	UN2435	8	A7, B2, N34, T10, TP2, TP7, TP13	None	206	206	242	Forbidden	30 L	C	
1-Ethylpiperidine	3	UN2386	3, 8	IB2, T7, TP1	150	202	202	243	1 L	5 L	B	52
N-Ethyloluidines	6.1	UN2754	6.1	IB2, T7, TP2	153	202	202	243	5 L	60 L	A	
Ethyltrichlorosilane	3	UN1196	3, 8	A7, N34, T10, TP2, TP7, TP13	None	206	206	243	Forbidden	5 L	B	40
Etiologic agent, see Infectious substances, etc												
Explosive articles, see Articles, explosive, n.o.s. etc												
Explosive, blasting, type A	1.1D	UN0081	1.1D		None	62	62	None	Forbidden	Forbidden	04	25, 19E, 21E
Explosive, blasting, type B	1.1D	UN0082	1.1D		None	62	62	None	Forbidden	Forbidden	04	25, 19E
Explosive, blasting, type B or Agent blasting, Type B	1.5D	UN0331	1.5D	105, 106	None	62	62	None	Forbidden	Forbidden	03	25, 19E
Explosive, blasting, type C	1.1D	UN0083	1.1D	123	None	62	62	None	Forbidden	Forbidden	04	25, 22E
Explosive, blasting, type D	1.1D	UN0084	1.1D		None	62	62	None	Forbidden	Forbidden	04	25
Explosive, blasting, type E	1.1D	UN0241	1.1D		None	62	62	None	Forbidden	Forbidden	04	25, 19E
Explosive, blasting, type E or Agent blasting, Type E	1.5D	UN0332	1.5D	105, 106	None	62	62	None	Forbidden	Forbidden	03	25, 19E
Explosive, forbidden. See § 173.54												
Explosive substances, see Substances, explosive, n.o.s. etc												
Explosives, slurry, see Explosive, blasting, type E												

§ 172.101 HAZARDOUS MATERIALS TABLE—Continued

(1) Sym-bols	(2) Hazardous materials descriptions and proper shipping names	(3) Hazard class or Division	(4) Identi-fication Numbers	(5) PG	(6) Label Codes	(7) Special provisions (§ 172.102)	(8) Packaging (§ 173.***)			(9) Quantity limitations (see §§ 173.27 and 175.75)		(10) Vessel stowage	
							(8A) Excep-tions	(8B) Non-bulk	(8C) Bulk	(9A) Passenger aircraft/rail	(9B) Cargo air-craft only	(10A) Loca-tion	(10B) Other
	Explosives, water gels, see Explosive, blasting, type E												
	Extracts, aromatic, liquid	3	UN1169	II	3	149, IB2, T4, TP1, TP8	150	202	242	5 L	60 L	B	
	Extracts, flavoring, liquid	3	UN1197	III	3	B1, IB3, T2, TP1	150	203	242	60 L	220 L	A	
	Extracts, flavoring, liquid	3	UN1197	III	3	149, IB2, T4, TP1, TP8	150	202	242	5 L	60 L	B	
	Extracts, flavoring, liquid	3	UN1197	III	3	B1, IB3, T2, TP1	150	203	242	60 L	220 L	A	
	<i>Fabric with animal or vegetable oil, see Fibers or fabrics, etc</i>												
	Ferric arsenate	6.1	UN1606	II	6.1	IB8, IP2, IP4, T3, TP33	153	212	242	25 kg	100 kg	A	
	Ferric arsenite	6.1	UN1607	II	6.1	IB8, IP2, IP4, T3, TP33	153	212	242	25 kg	100 kg	A	
	Ferric chloride, anhydrous	8	UN1773	III	8	IB8, IP3, T1, TP33	154	213	240	25 kg	100 kg	A	
	Ferric chloride, solution	8	UN2582	III	8	B15, IB3, T4, TP1	154	213	241	5 L	60 L	A	
	Ferric nitrate	5.1	UN1466	III	5.1	A1, A29, IB8, IP3, T1, TP33	152	213	240	25 kg	100 kg	A	
	Ferrocenium	4.1	UN1323	II	4.1	59, A19, IB8, IP2, IP4, TP33	151	212	240	15 kg	50 kg	A	
	Ferrosilicon with 30 percent or more but less than 90 percent silicon	4.3	UN1408	III	4.3, 6.1	A1, A19, B6, IB8, IP4, IP7, T1, TP33	151	213	240	25 kg	100 kg	A	13, 40, 52, 53, 85, 103
D	Ferrous arsenate	6.1	UN1608	II	6.1	IB8, IP2, IP4, T3, TP33	153	212	242	25 kg	100 kg	A	
D	Ferrous chloride, solid	8	NA1759	II	8	IB8, IP2, IP4, T3, TP33	154	212	240	15 kg	50 kg	A	
	Ferrous chloride, solution	8	NA1760	II	8	B3, IB2, T11, TP2, TP27	154	202	242	1 L	30 L	B	40
	Ferrous metal borings or Ferrous metal shavings or Ferrous metal turnings or Ferrous metal cuttings in a form liable to self-heating	4.2	UN2793	III	4.2	A1, A19, IB8, IP3, IP7	None	213	241	25 kg	100 kg	A	
	Fertilizer ammoniating solution with free ammonia	2.2	UN1043		2.2	N87	306	304	314	Forbidden	150 kg	E	40
A I W	Fibers, animal or Fibers, vegetable burnt, wet or damp	4.2	UN1372	III	4.2		151	213	240	Forbidden	Forbidden	A	
IW	Fibers, vegetable, dry	4.1	UN3360	III	4.1	137	151	213	240	No Limit	No Limit	A	
A W	Fibers or Fabrics, animal or vegetable or Synthetic, n.o.s. with animal or vegetable oil	4.2	UN1373	III	4.2	137, IB8, IP3, T1, TP33	None	213	241	Forbidden	Forbidden	A	
	Fibers or Fabrics impregnated with weakly nitrated nitrocellulose, n.o.s.	4.1	UN1353	III	4.1	A1, IB8, IP3	None	213	240	25 kg	100 kg	D	

W	Films, nitrocellulose base, from which gelatine has been removed; film scrap, see Celluloid scrap	4.1	UN1324	III	4.1	None	183	None	25 kg	100 kg	D	28	
	Films, nitrocellulose base, gelatine coated (except scrap)	8	UN1774	II	8	N41	202	None	1 L	30 L	A		
	Fire extinguisher charges, corrosive liquid							None					
	Fire extinguisher charges, expelling, explosive, see Cartridges, power device							None					
	Fire extinguishers containing compressed or liquefied gas	2.2	UN1044		2.2	18, 110	309	None	75 kg	150 kg	A	52	
	Firelighters, solid with flammable liquid	4.1	UN2623	III	4.1	A1, A19	None	213	None	25 kg	100 kg	A	
	Fireworks	1.1G	UN0333	II	1.1G	108	None	62	Forbidden	Forbidden	Forbidden	03	25
	Fireworks	1.2G	UN0334	II	1.2G	108	None	62	Forbidden	Forbidden	Forbidden	03	25
	Fireworks	1.3G	UN0335	II	1.3G	108	None	62	Forbidden	Forbidden	Forbidden	03	25
	Fireworks	1.4G	UN0336	II	1.4G	108, 200	None	62	Forbidden	Forbidden	Forbidden	02	25
Fireworks	1.4S	UN0337	II	1.4S	108	None	62	Forbidden	25 kg	100 kg	01	25	
First aid kits	9	UN0316		9	15	161	161	None	10 kg	10 kg	A	25, 88,	
Fish meal, stabilized or Fish scrap, stabilized	9	UN2216	III	None	155, IB8, IP3, T1, TP33	155	218	None	No limit	No limit	B	122,	
Fish meal, unstabilized or Fish scrap, unstabilized	4.2	UN1374	II	4.2	155, A1, A19, IB8, IP2, IP4, T3, TP33	None	212	241	15 kg	50 kg	B	128,	
Flammable compressed gas, see Compressed or Liquefied gas, flammable, etc												18, 25,	
Flammable compressed gas (small receptacles not fitted with a dispersion device, not refillable), see Receptacles, etc												128	
Flammable gas in lighters, see Lighters or lighter refills, ciga- rettes, containing flammable gas													
Flammable liquid, toxic, corrosive, n.o.s.	3	UN3286	I	3, 6.1, 8	T14, TP2, TP13, TP27	None	201	243	Forbidden	2.5 L	E	21, 40,	
			II	3, 6.1, 8	IB2, T11, TP2, TP13, TP27	150	202	243	1 L	5 L	B	100	
			I	3, 8	T14, TP2	None	201	243	0.5 L	2.5 L	E	40	
			II	3, 8	IB2, T11, TP2, TP27	150	202	243	1 L	5 L	B	40	
			III	3, 8	B1, IB3, T7, TP1, TP28	150	203	242	5 L	60 L	A	40	
			I	3	T11, TP1, TP27	150	201	243	1 L	30 L	E		
			II	3	IB2, T7, TP1, TP8, TP28	150	202	242	5 L	60 L	B		
			III	3	B1, B52, IB3, T4, TP1, TP29	150	203	242	60 L	220 L	A		
			I	3, 6.1	T14, TP2, TP13, TP27	None	201	243	Forbidden	30 L	E	40	
			II	3, 6.1	IB2, T7, TP2, TP13	150	202	243	1 L	60 L	B	40	
			III	3, 6.1	B1, IB3, T7, TP1, TP28	150	203	242	60 L	220 L	A		

§ 172.101 HAZARDOUS MATERIALS TABLE—Continued

(1) Sym-bols	(2) Hazardous materials descriptions and proper shipping names	(3) Hazard class or Division	(4) Identi-fication Numbers	(5) PG	(6) Label Codes	(7) Special provisions (§ 172.102)	(8) Packaging (§ 173.***)			(9) Quantity limitations (see §§ 173.27 and 175.75)		(10) Vessel stowage	
							Excep-tions (8A)	Non-bulk (8B)	Bulk (8C)	Passenger aircraft/rail (9A)	Cargo air-craft only (9B)	Loca-tion (10A)	Other (10B)
G	Flammable solid, corrosive, inorganic, n.o.s.	4.1	UN3180	II	4.1, 8	A1, IB6, IP2, T3, TP33	151	212	242	15 kg	50 kg	D	40
G	Flammable solid, inorganic, n.o.s.	4.1	UN3178	III	4.1, 8	A1, IB6, T1, TP33	151	213	242	25 kg	100 kg	D	40
G	Flammable solid, organic, molten, n.o.s.	4.1	UN3176	III	4.1	A1, IB8, IP2, IP4, T3, TP33	151	212	240	15 kg	50 kg	B	40
G	Flammable solid, oxidizing, n.o.s.	4.1	UN3097	III	4.1, 5.1	A1, IB8, IP3, T1, TP33	151	213	240	25 kg	100 kg	B	40
G	Flammable solid, toxic, inorganic, n.o.s.	4.1	UN3179	III	4.1, 5.1	IB1, T1, TP3, TP26	151	213	240	Forbidden	Forbidden	C	40
G	Flammable solid, toxic, inorganic, n.o.s.	4.1	UN3179	III	4.1, 5.1	131, T1, TP33	None	214	214	Forbidden	Forbidden	D	40
G	Flammable solids, corrosive, organic, n.o.s.	4.1	UN2925	III	4.1, 6.1	A1, IB6, IP2, T3, TP33	151	212	242	15 kg	50 kg	B	40
G	Flammable solids, organic, n.o.s.	4.1	UN1325	III	4.1	A1, IB6, T1, TP33	151	213	242	25 kg	100 kg	B	40
G	Flammable solids, toxic, organic, n.o.s.	4.1	UN2926	III	4.1, 6.1	A1, IB6, IP2, T3, TP33	151	212	242	15 kg	50 kg	D	40
	Flares, aerial	1.3G	UN0093	II	1.3G	A1, IB6, T1, TP33	None	62	None	Forbidden	75 kg	03	25
	Flares, aerial	1.4G	UN0403	II	1.4G	A1, IB8, IP2, IP4, T3, TP33	None	62	None	Forbidden	75 kg	02	25
	Flares, aerial	1.4S	UN0404	II	1.4S	A1, IB8, IP3, T1, TP33	None	62	None	Forbidden	100 kg	01	25
	Flares, aerial	1.1G	UN0420	II	1.1G	A1, IB6, IP2, T3, TP33	None	62	None	Forbidden	Forbidden	03	25
	Flares, aerial	1.2G	UN0421	II	1.2G	A1, IB6, T1, TP33	None	62	None	Forbidden	Forbidden	03	25
	Flares, signal, see Cartridges, signal												
	Flares, surface	1.3G	UN0092	II	1.3G		None	62	None	Forbidden	75 kg	03	25
	Flares, surface	1.1G	UN0418	II	1.1G		None	62	None	Forbidden	Forbidden	03	25
	Flares, surface	1.2G	UN0419	II	1.2G		None	62	None	Forbidden	Forbidden	03	25

§ 172.101 HAZARDOUS MATERIALS TABLE—Continued

(1) Sym-bols	(2) Hazardous materials descriptions and proper shipping names	(3) Hazard class or Division	(4) Identi-fication Numbers	(5) PG	(6) Label Codes	(7) Special provisions (§ 172.102)	(8) Packaging (§ 173.***)			(9) Quantity limitations (see §§ 173.27 and 175.75)		(10) Vessel stowage		
							Excep-tions (8A)	Non-bulk (8B) (8C)	Bulk (8C)	Passenger aircraft/rail (9A)	Cargo air-craft only (9B)	Loca-tion (10A)	Other (10B)	
D	Fuel cell cartridges or Fuel cell cartridges contained in equipment or Fuel cell cartridges packed with equipment, containing <i>corrosive substances</i>	8	UN3477	8	328	230	230	230	5 kg	50 kg	A		
	Fuel cell cartridges or Fuel cell cartridges contained in equipment or Fuel cell cartridges packed with equipment, containing <i>flammable liquids</i>	3	UN3473	3	328	230	230	230	5 kg	50 kg	A		
	Fuel cell cartridges or Fuel cell cartridges contained in equipment or Fuel cell cartridges packed with equipment, containing <i>hydrogen in metal hydride</i>	2.1	UN3479	2.1	328	230	230	230	1 kg	15 kg	B		
	Fuel cell cartridges or Fuel cell cartridges contained in equipment or Fuel cell cartridges packed with equipment, containing <i>liquefied flammable gas</i>	2.1	UN3478	2.1	328	230	230	230	1 kg	15 kg	B		
	Fuel cell cartridges or Fuel cell cartridges contained in equipment or equipment, containing <i>water-reactive substances</i>	4.3	UN3476	4.3	328	230	230	230	5 kg	50 kg	A		
	Fuel oil (No. 1, 2, 4, 5, or 6)	3	NA1993	III	3	144, B1, IB3, T4, TP1, TP29	150	203	242	60 L	220 L	A		
	Fuel system components (including fuel control units (FCU), carburetors, fuel lines, fuel pumps) see Dangerous Goods in Machinery or Dangerous Goods in Machinery													
	Fulminate of mercury (dry)	Forbidden												
	Fulminate of mercury, wet, see Mercury fulminate, etc	Forbidden												
	Fulminating gold	Forbidden												

Fulminating mercury	UN1780	II	8	B2, IB2, T7, TP2	154	202	242	1 L	30 L	C	8, 40
Fulminating platinum											
Fulminating silver											
Fulminic acid											
Fumaryl chloride											
Fumigated lading, see §§ 172.302(g), 173.9 and 176.76(h)											
Fumigated transport vehicle or freight container see § 173.9											
Furadienhydres	6.1 UN1199	II	6.1, 3	IB2, T7, TP2	153	202	243	5 L	60 L	A	40
Furan	3 UN2389	I	3	T12, TP2, TP13	None	201	243	1 L	30 L	E	
Furfuryl alcohol	6.1 UN2874	III	6.1	IB3, T4, TP1	153	203	241	60 L	220 L	A	52, 74
Furfurylamine	3 UN2526	III	3, 8	B1, IB3, T4, TP1	150	203	242	5 L	60 L	A	40
Fuse, detonating, metal clad, see Cord, detonating, metal clad											
Fuse, detonating, mild effect, metal clad, see Cord, detonating, mild effect, metal clad											
Fuse, igniter tubular metal clad	1.4G UN0103	II	1.4G		None	62	None	Forbidden	75 kg	02	25
Fuse, non-detonating instantaneous or quickmatch	1.3G UN0101	II	1.3G		None	62	None	Forbidden	Forbidden	03	25
Fuse, safety	1.4S UN0105	II	1.4S		None	62	None	25 kg	100 kg	01	25
Fusee (railway or highway)	4.1 NA1325	II	4.1		None	184	None	15 kg	50 kg	B	
Fusel oil	3 UN1201	III	3	IB2, T4, TP1	150	202	242	5 L	60 L	B	
				B1, IB3, T2, TP1	150	203	242	60 L	220 L	A	
Fuses, tracer, see Tracers for ammunition											
Fuzes, combination, percussion and time, see Fuzes, detonating (UN0257, UN0367); Fuzes, igniting (UN0317, UN0368)											
Fuzes, detonating	1.1B UN0106	II	1.1B		None	62	None	Forbidden	Forbidden	05	25
Fuzes, detonating	1.2B UN0107	II	1.2B		None	62	None	Forbidden	Forbidden	05	25
Fuzes, detonating	1.4B UN0257	II	1.4B	116	None	62	None	75 kg	75 kg	05	25
Fuzes, detonating	1.4S UN0367	II	1.4S	116	None	62	None	25 kg	100 kg	01	25
Fuzes, detonating, with protective features	1.1D UN0408	II	1.1D		None	62	None	Forbidden	Forbidden	04	25
Fuzes, detonating, with protective features	1.2D UN0409	II	1.2D		None	62	None	Forbidden	Forbidden	04	25
Fuzes, detonating, with protective features	1.4D UN0410	II	1.4D	116	None	62	None	Forbidden	75 kg	02	25
Fuzes, igniting	1.3G UN0316	II	1.3G		None	62	None	Forbidden	Forbidden	03	25
Fuzes, igniting	1.4G UN0317	II	1.4G		None	62	None	Forbidden	75 kg	02	25
Fuzes, igniting	1.4S UN0368	II	1.4S		None	62	None	25 kg	100 kg	01	25
Galactosan trinitrate											
Gallium	8 UN2803	III	8	T1, TP33	None	162	240	20 kg	20 kg	B	25
Gas cartridges, (flammable) without a release device, non-refillable	2.1 UN2037		2.1		306	304	None	1 kg	15 kg	B	40
Gas identification set	2.3 NA9035		2.3	6	None	194	None	Forbidden	Forbidden	D	

D

D

§ 172.101 HAZARDOUS MATERIALS TABLE—Continued

(1) Sym-bols	(2) Hazardous materials descriptions and proper shipping names	(3) Hazard class or Division	(4) Identi-fication Numbers	(5) PG	(6) Label Codes	(7) Special provisions (§ 172.102)	(8) Packaging (§ 173.***)			(9) Quantity limitations (see §§ 173.27 and 175.75)		(10) Vessel stowage	
							Excep-tions (8A)	Non-bulk (8B)	Bulk (8C)	Passenger aircraft/rail (9A)	Cargo air-craft only (9B)	Loca-tion (10A)	Other (10B)
G	Gas oil Gas, refrigerated liquid, flammable, n.o.s. (cryogenic liquid)	3 2.1	UN1202	III	3 2.1	144, B1, IB3, T2, TP1 T75, TP5	150	203	242	60 L	220 L	A	40
			UN3312				316	318	Forbidden	Forbidden	D		
G	Gas, refrigerated liquid, n.o.s. (cryogenic liquid)	2.2	UN3158		2.2	T75, TP5	320	316	318	50 kg	500 kg	D	
G	Gas, refrigerated liquid, oxidizing, n.o.s. (cryogenic liquid) Gas sample, non-pressurized, flammable, n.o.s., not refrigerated liquid	2.2 2.1	UN3311		2.2, 5.1	T75, TP5, TP22	320	316	318	Forbidden	Forbidden	D	
			UN3167		2.1	306	302, 304	None	1 L	5 L	D		
	Gas sample, non-pressurized, toxic, flammable, n.o.s., not refrigerated liquid	2.3	UN3168		2.3, 2.1	6	306	302	None	Forbidden	1 L	D	
	Gas sample, non-pressurized, toxic, n.o.s., not refrigerated liquid	2.3	UN3169		2.3	6	306	302, 304	None	Forbidden	1 L	D	D
	Gasoline includes gasoline mixed with ethyl alcohol, with not more than 10% alcohol Gasoline, casinghead, see Gasoline Gelatine, blasting, see Explosive, blasting, type A Gelatine dynamites, see Explosive, blasting, type A Germane	3	UN1203	II	3	144, 177, B1, B33, IB2, T4	150	202	242	5 L	60 L	E	
	Glycerol-1,3-dinitrate Glycerol gluconate trinitrate Glycerol lactate trinitrate Glycerol alpha-monochlorohydrin Glyceryl trinitrate, see Nitroglycerin, etc	2.3 Forbidden Forbidden Forbidden	UN2192		2.3, 2.1	2	None	302	245	Forbidden	Forbidden	D	40
	Glycidaldehyde Grenades, hand or rifle, with bursting charge Grenades, hand or rifle, with bursting charge Grenades, hand or rifle, with bursting charge	3 1.1D 1.2D 1.1F	UN2622 UN0284 UN0285 UN0292	III II II II	6.1 3, 6.1 1.1D 1.2D 1.1F	IB3, T4, TP1 IB2, IP8, T7, TP1	153 150	203 202 62 62	241 243 None None	60 L 1 L Forbidden Forbidden	220 L 60 L Forbidden Forbidden	A A 04 04	40 25 25 25

UN number	Proper shipping name	Class	Division	Subdivision	Quantity	Special provisions	Other	Notes
UN0293	1.2F Grenades, hand or rifle, with bursting charge	II	1.2F	62	None	05
UN0110	1.4S Grenades, illuminating, see Ammunition, illuminating, etc	II	1.4S	62	None	01
UN0318	1.3G Grenades, practice, hand or rifle	II	1.3G	62	None	03
UN0372	1.2G Grenades, practice, hand or rifle	II	1.2G	62	None	03
UN0452	1.4G Grenades, practice, hand or rifle	II	1.4G	62	None	02
UN1467	5.1 Grenades, smoke, see Ammunition, smoke, etc	III	5.1	A1, IB8, IP3, T1, TP33	213	152	240	A
UN0113	1.1A Guanyl nitrosaminoguanilydene hydrazine (dry)	II	1.1A	111, 117	62	None	None	05
UN0114	1.1A Guanyl nitrosaminoguanilydene hydrazine, wetted with not less than 30 percent water, by mass	II	1.1A	111, 117	62	None	None	05
UN2545	4.2 Gunpowder, compressed or Gunpowder in pellets, see Black powder (UN 0028)	I	4.2	None	211	None	242	D
UN1326	4.1 Gunpowder, granular or as a meal, see Black powder (UN 0027)	II	4.1	A19, A20, IB6, IP2, N34, T3, TP33	212	None	241	D
UN1326	4.1 Gunpowder, granular or as a meal, see Black powder (UN 0027)	III	4.2	IB8, IP3, T1, TP33	213	None	241	D
UN1326	4.1 Gunpowder, granular or as a meal, see Black powder (UN 0027)	II	4.1	A6, A19, A20, IB6, IP2, N34, T3, TP33	212	None	241	E
NA3082	9 Hand signal device, see Signal devices, hand	III	9	IB3, T2, TP1	203	155	241	A
NA3077	9 Hazardous substances, liquid or solid, n.o.s., see Environmentally hazardous substances, etc	III	9	B54, IB8, IP2, T1, TP33	213	155	240	A
UN1202	3 Hazardous waste, liquid, n.o.s.	III	3	B1, IB3, T2, TP1	203	150	242	A
UN1046	2.2 Heating oil, light	2.2	302	306	302,	A
UN1046	2.2 Helium, compressed	2.2	302	314	302,	A

§ 172.101 HAZARDOUS MATERIALS TABLE—Continued

(1) Sym-bols	(2) Hazardous materials descriptions and proper shipping names	(3) Hazard class or Division	(4) Identi-fication Numbers	(5) PG	(6) Label Codes	(7) Special provisions (§ 172.102)	(8) Packaging (§ 173.***)			(9) Quantity limitations (see §§ 173.27 and 175.75)			(10) Vessel stowage	
							Excep-tions (8A)	Non-bulk (8B)	Bulk (8C)	Passenger aircraft/rail (9A)	Cargo air-craft only (9B)	Other (10B)	Loca-tion (10A)	
	Helium, refrigerated liquid (<i>cryogenic liquid</i>)	2.2	UN1963		2.2	T75, TP5	320	316	318	50 kg	500 kg	D		
	Heptafluoropropane or Refrigerant gas R 227	2.2	UN3296		2.2	T50	306	304	314, 315	75 kg	150 kg	A		
	n-Heptaldehyde	3	UN3056	III	3	B1, IB3, T2, TP1	150	203	242	60 L	220 L	A		
	Heptanes	3	UN1206	II	3	IB2, T4, TP1	150	202	242	5 L	60 L	B		
	n-Heptene	3	UN2278	II	3	IB2, T4, TP1	150	202	242	5 L	60 L	B		
	Hexachloroacetone	6.1	UN2661	III	6.1	IB3, T4, TP1	153	203	241	60 L	220 L	B	12, 40	
	Hexachlorobenzene	6.1	UN2729	III	6.1	B3, IB8, IP3, T1, TP33	153	203	241	60 L	220 L	A		
	Hexachlorobutadiene	6.1	UN2279	III	6.1	IB3, T4, TP1	153	203	241	60 L	220 L	A		
	Hexachlorocyclopentadiene	6.1	UN2646	I	6.1	2, B9, B14, B32, B77, T20, TP2, TP13, TP38, TP45	None	227	244	Forbidden	Forbidden	D	40	
	Hexachlorophene	6.1	UN2875	III	6.1	IB8, IP3, T1, TP33	153	213	240	100 kg	200 kg	A		
	Hexadecyltrichlorosilane	8	UN1781	II	8	A7, B2, B6, N34, T10, TP2, TP7, TP13	None	206	242	Forbidden	30 L	C	40	
	Hexadienes	3	UN2458	II	3	IB2, T4, TP1	None	202	242	5 L	60 L	B		
	Hexaethyl tetraphosphate and com-pressed gas mixtures	2.3	UN1612	II	2.3	3	None	334	None	Forbidden	Forbidden	D	40	
	Hexaethyl tetraphosphate, <i>liquid</i>	6.1	UN1611	II	6.1	IB2, N76, T7, TP2	153	202	243	5 L	60 L	E	40	
	Hexaethyl tetraphosphate, <i>solid</i>	6.1	UN1611	II	6.1	IB8, IP2, IP4, N76	153	212	242	25 kg	100 kg	E	40	
	Hexafluoroacetone	2.3	UN2420	II	2.3, 8	2, B9, B14	None	304	314, 315	Forbidden	Forbidden	D	40	
	Hexafluoroacetone hydrate, <i>liquid</i>	6.1	UN2552	II	6.1	IB2, T7, TP2	153	202	243	5 L	60 L	B	40	
	Hexafluoroacetone hydrate, <i>solid</i>	6.1	UN3436	II	6.1	IB8, IP2, IP4, T3, TP33	153	212	242	25 kg	100 kg	B	40	
	Hexafluoroethane, or Refrigerant gas R 116	2.2	UN2193	II	2.2		306	304	314, 315	75 kg	150 kg	A		
	Hexafluorophosphoric acid	8	UN1782	II	8	A6, A7, B2, IB2, N3, N34, T8, TP2	None	202	242	1 L	30 L	A		
	Hexafluoropropylene compressed or Refrigerant gas R 1216	2.2	UN1858		2.2	T50	306	304	314, 315	75 kg	150 kg	A		
	Hexaldehyde	3	UN1207	III	3	B1, IB3, T2, TP1	150	203	242	60 L	220 L	A		
	Hexamethylene diisocyanate	6.1	UN2281	II	6.1	IB2, T7, TP2, TP13	153	202	243	5 L	60 L	C	13, 40	
	Hexamethylene triperoxide diamine (<i>dry</i>)	Forbidden												
	Hexamethylenediamine, <i>solid</i>	8	UN2280	III	8	IB8, IP3, T1, TP33	154	213	240	25 kg	100 kg	A	12	
	Hexamethylenediamine solution	8	UN1783	III	8	IB2, T7, TP2	None	202	242	1 L	30 L	A		
						IB3, T4, TP1	154	203	241	5 L	60 L	A		

Hexamethylenimine	3	UN2493	II	3, 8	IB2, T7, TP1	150	202	243	1 L	5 L	B	40
Hexamethylenetetramine	4.1	UN1328	III	4.1	A1, IB8, IP3, T1, TP33	151	213	240	25 kg	100 kg	A	
Hexamethylol benzene hexanitrate	Forbidden											
Hexanes	3	UN1208	II	3	IB2, T4, TP1	150	202	242	5 L	60 L	E	
2,2,4,4',6,6'-Hexanitro-3,3'-dihydroxyazobenzene (dry)	Forbidden											
Hexanitroazoxy benzene	Forbidden											
N,N'-(hexanitrodiphenyl) ethylene dinitramine (dry)	Forbidden											
Hexanitrodiphenyl urea	Forbidden											
2,2',3',4',4',6'-Hexanitrodiphenylamine	1.1D	UN0079	II	1.1D		None	62	None	Forbidden	Forbidden	04	25
Hexanitrodiphenylamine or Dipicylamine or Hexyl	Forbidden											
2,3',4',4',6,6'-Hexanitrodiphenylether	Forbidden											
Hexanitroethane	Forbidden											
Hexanitrooxanilide	1.1D	UN0392	II	1.1D		None	62	None	Forbidden	Forbidden	04	25
Hexanitrosilbene												
Hexanoic acid, see Corrosive liquids, n.o.s.												
Hexanols	3	UN2282	III	3	B1, IB3, T2, TP1	150	203	242	60 L	220 L	A	74
1-Hexene	3	UN2370	II	3	IB2, T4, TP1	150	202	242	5 L	60 L	E	
Hexogen												
cycloctetramethylenetetranitramine and mixtures, wetted or desensitized see RDX and HMX mixtures, wetted or desensitized etc												
Hexogen and octogen mixtures, wetted or desensitized see RDX and HMX mixtures, wetted or desensitized etc												
Hexogen and octogen mixtures, wetted or desensitized see RDX and HMX mixtures, wetted or desensitized etc												
Hexogen and octogen mixtures, wetted or desensitized see RDX and HMX mixtures, wetted or desensitized etc												
Hexogen and octogen mixtures, wetted or desensitized see RDX and HMX mixtures, wetted or desensitized etc												
Hexogen, see Cyclooctimethylenetrinitramine, etc												
Hexonal	1.1D	UN0118	II	1.1D		None	62	None	Forbidden	Forbidden	04	25
Hexolite, or Hexolite dry or wetted with less than 15 percent water, by mass												
Hexyl, see Hexanitrodiphenylamine												
Hexyltrichlorosilane	8	UN1784	II	8	A7, B2, B6, N34, T10, TP2, TP7, TP13	None	206	242	Forbidden	30 L	C	40
High explosives, see individual explosives' entries												
HMX, see Cyclooctetramethylenetetranitramine, etc												
Hydrazine, anhydrous	8	UN2029	I	8, 3, 6.1	A3, A6, A7, A10, B7, B16, B53	None	201	243	Forbidden	2.5 L	D	40, 52, 125.

§ 172.101 HAZARDOUS MATERIALS TABLE—Continued

(1) Sym-bols	(2) Hazardous materials descriptions and proper shipping names	(3) Hazard class or Division	(4) Identi-fication Numbers	(5) PG	(6) Label Codes	(7) Special provisions (§ 172.102)	(8) Packaging (§ 173.***)			(9) Quantity limitations (see §§ 173.27 and 175.75)		(10) Vessel stowage	
							Excep-tions (8A)	Non-bulk (8B)	Bulk (8C)	Passenger aircraft/rail (9A)	Cargo air-craft only (9B)	Loca-tion (10A)	Other (10B)
	Hydrazine, aqueous solution, with not more than 37 percent hydrazine, by mass	6.1	UN3293	III	6.1	IB3, T4, TP1	153	203	241	60 L	220 L	A	52.
	Hydrazine aqueous solution, flammable with more than 37% hydrazine, by mass	8	UN3484	I	8, 3, 6.1	B16, B53, T10, TP2, TP13	None	201	243	Forbidden	2.5 L	D	40, 52, 125
	Hydrazine aqueous solution, with more than 37% hydrazine, by mass	8	UN2030	I	8, 6.1	B16, B53, T10, TP2, TP13	None	201	243	Forbidden	2.5 L	D	40, 52
	Hydrazine azide	Forbidden		II	8, 6.1	B16, B53, IB2, T7, TP2, TP13	None	202	243	Forbidden	30 L	D	40, 52
	Hydrazine chlorate	Forbidden		III	8, 6.1	B16, B53, IB3, T4, TP1	154	203	241	5 L	60 L	D	40, 52
	Hydrazine dicarbonic acid diazide	Forbidden											
	Hydrazine perchlorate	Forbidden											
	Hydrazine selenate	Forbidden											
	Hydroiodic acid, anhydrous, see Hydrogen iodide, anhydrous	8	UN1787	II	8	A3, A6, B2, IB2, N41, T7, TP2	154	202	242	1 L	30 L	C	8
	Hydroiodic acid			III	8	IB3, T4, TP1	154	203	241	5 L	60 L	C	
	Hydrobromic acid, anhydrous, see Hydrogen bromide, anhydrous	8	UN1788	II	8	B2, B15, IB2, N41, T7, TP2	154	202	242	Forbidden	Forbidden	C	8
	Hydrobromic acid, with more than 49 percent hydrobromic acid	8	UN1788	II	8	IB3, T4, TP1	154	203	241	Forbidden	Forbidden	C	
	Hydrobromic acid, with not more than 49 percent hydrobromic acid	8	UN1788	II	8	A3, A6, B2, B15, IB2, N41, T7, TP2	154	202	242	1 L	30 L	C	
	Hydrocarbon gas mixture, compressed, n.o.s.	2.1	UN1964	III	2.1	A3, IB3, T4, TP1	306	302	241	5 L	60 L	C	8
	Hydrocarbon gas mixture, liquefied, n.o.s.	2.1	UN1965	I	2.1	T50	306	304	314, 315	Forbidden	150 kg	E	40
	Hydrocarbons, liquid, n.o.s.	3	UN3295	I	3	144, T11, TP1, TP8, TP28	150	201	243	1 L	30 L	E	
				II	3	144, IB2, T7, TP1, TP8, TP28	150	202	242	5 L	60 L	B	

		III	3		150	203	242	60 L	220 L	A	
Hydrochloric acid, anhydrous, see Hydrogen chloride, anhydrous	8	UN1789	8	144, B1, IB3, T4, TP1, TP29	154	202	242	1 L	30 L	C	
Hydrochloric acid			8	A3, A6, B3, B15, IB2, N41, T8, TP2	154	203	241	5 L	60 L	C	8
Hydrocyanic acid, anhydrous, see Hydrogen cyanide etc	6.1	UN1613	6.1	A3, IB3, T4, TP1	None	195	244	Forbidden	Forbidden	D	40
Hydrocyanic acid, aqueous solutions or Hydrogen cyanide, aqueous solutions with not more than 20 percent hydrogen cyanide	6.1	NA1613	6.1	2, B61, B65, B77, B82, T20, TP2, TP13	None	195	243	Forbidden	5 L	D	40
Hydrocyanic acid, aqueous solutions with less than 5 percent hydrogen cyanide				IB1, T14, TP2, TP13, TP27							
Hydrocyanic acid, liquefied, see Hydrogen cyanide, etc	Forbidden										
Hydrocyanic acid (prussic), unstabilized	8	UN1786	8, 6.1	A6, A7, B15, B23, N5, N34, T10, TP2, TP13	None	201	243	Forbidden	2.5 L	D	40
Hydrofluoric acid and Sulfuric acid mixtures	8	UN1790	8, 6.1	A6, A7, B4, B15, B23, N5, N34, T10, TP2, TP13	None	201	243	0.5 L	2.5 L	D	12, 40
Hydrofluoric acid, anhydrous, see Hydrogen fluoride, anhydrous	8	UN1790	8, 6.1	A6, A7, B15, IB2, N5, N34, T8, TP2	154	202	243	1 L	30 L	D	12, 40
Hydrofluoric acid, with more than 60 percent strength											
Hydrofluoric acid, with not more than 60 percent strength	2.1	UN2034	2.1	N89	306	302	302, 314, 315	Forbidden	150 kg	E	40, 57
Hydrofluoroboric acid, see Fluoroboric acid	2.3	UN1048	2.3, 8	3, B14, N86, N89	None	304	314, 315	Forbidden	Forbidden	D	40
Hydrofluorosilicic acid, see Fluorosilicic acid	2.3	UN1050	2.3, 8	3, N86, N89	None	304	None	Forbidden	Forbidden	D	40
Hydrogen and Methane mixtures, compressed	2.3	UN2186	2.3, 8	3, B6	None	None	314, 315	Forbidden	Forbidden	B	40
Hydrogen bromide, anhydrous	2.1	UN1049	2.1	N89	306	302	302, 314	Forbidden	150 kg	E	40, 57
Hydrogen chloride, anhydrous	6.1	UN3294	6.1, 3	2, B9, B14, B32, T20, TP2, TP13, TP36, TP45	None	227	244	Forbidden	Forbidden	D	40
Hydrogen chloride, refrigerated liquid											
Hydrogen, compressed	6.1	UN1051	6.1, 3	1, B35, B61, B65, B77, B82	None	195	244	Forbidden	Forbidden	D	40
Hydrogen cyanide, solution in alcohol with not more than 45 percent hydrogen cyanide											
Hydrogen cyanide, stabilized with less than 3 percent water											

D

§ 172.101 HAZARDOUS MATERIALS TABLE—Continued

(1) Sym-bols	(2) Hazardous materials descriptions and proper shipping names	(3) Hazard class or Division	(4) Identi-fication Numbers	(5) PG	(6) Label Codes	(7) Special provisions (§ 172.102)	(8) Packaging (§ 173.***)			(9) Quantity limitations (see §§ 173.27 and 175.75)		(10) Vessel stowage	
							Excep-tions (8A)	Non-bulk (8B)	Bulk (8C)	Passenger aircraft/rail (9A)	Cargo air-craft only (9B)	Loca-tion (10A)	Other (10B)
	Hydrogen cyanide, stabilized, with less than 3 percent water and absorbed in a porous inert material	6.1	UN1614	I	6.1	5	None	195	None	Forbidden	Forbidden	D	25, 40
	Hydrogen fluoride, anhydrous	8	UN1052	I	8.6.1	3, B7, B46, B77, N86, T10, TP2	None	163	244	Forbidden	Forbidden	D	40
	Hydrogen in a metal hydride storage system or Hydrogen in a metal hydride storage system contained in equipment or Hydrogen in a metal hydride storage system packed with equipment	2.1	UN3468	2.1	167	None	311	None	Forbidden	100 kg	D	
	Hydrogen iodide, anhydrous	2.3	UN2197		2.3, 8	3, B14, N86, N89	None	304	314, 315	Forbidden	Forbidden	D	40
	Hydrogen iodide solution, see Hydrochloric acid											
	Hydrogendifluoride, solid, n.o.s	8	UN1740	III	8	IB8, IP3, N3, N34, T1, TP33	154	213	240	25 kg	100 kg	A	25, 40, 52
				II	8	IB8, IP2, IP4, N3, N34, T3, TP33	None	212	240	15 kg	50 kg	A	25, 40, 52
				III	8	IB8, IP3, N3, N34, T1, TP33	154	213	240	25 kg	100 kg	A	25, 40, 52
	Hydrogendifluoride solution, n.o.s	8	UN3471	II	8, 6.1	IB2, T7, TP2	154	202	242	1 L	30 L	A	25, 40, 52
				III	8, 6.1	IB3, T4, TP1	154	203	241	5 L	60 L	A	25, 40, 52
	Hydrogen peroxide and peroxy-acetic acid mixtures, stabilized with acids, water, and not more than 5 percent peroxyacetic acid	5.1	UN3149	II	5.1, 8	145, A2, A3, A6, B53, IB2, IP5, T7, TP2, TP6, TP24	None	202	243	1 L	5 L	D	25, 66, 75
	Hydrogen peroxide, aqueous solutions, with more than 40 percent but not more than 60 percent hydrogen peroxide (stabilized as necessary)	5.1	UN2014	II	5.1, 8	12, A60, B53, B80, B81, B85, IB2, IP5, T7, TP2, TP6, TP24, TP37	None	202	243	Forbidden	Forbidden	D	25, 66, 75

§ 172.101 HAZARDOUS MATERIALS TABLE—Continued

(1) Sym-bols	(2) Hazardous materials descriptions and proper shipping names	(3) Hazard class or Division	(4) Identi-fication Numbers	(5) PG	(6) Label Codes	(7) Special provisions (§ 172.102)	(8) Packaging (§ 173.***)			(9) Quantity limitations (see §§ 173.27 and 175.75)		(10) Vessel stowage	
							Excep-tions (8A)	Non-bulk (8B)	Bulk (8C)	Passenger aircraft/rail (9A)	Cargo air-craft only (9B)	Loca-tion (10A)	Other (10B)
G	Infectious substances, affecting humans <i>Inflam-mable, see Flammable Initiating explosives (dry)</i> <i>Inositol hexanitrate (dry)</i> Insecticide gases, n.o.s.	6.2 Forbidden Forbidden 2.2	UN 2814 UN1968		6.2	A82	134	196	None	50 mL or 50 g	4 L or 4 kg	B	40
G	Insecticide gases, flammable, n.o.s.	2.1	UN3354		2.1	T50	306	304	314, 315	75 kg	150 kg	A	40
G	Insecticide gases, toxic, flammable, n.o.s. <i>Inhalation hazard Zone A</i>	2.3	UN3355		2.3, 2.1	1	None	192	245	Forbidden	Forbidden	D	40
G	Insecticide gases, toxic, flammable, n.o.s. <i>Inhalation hazard Zone B</i>	2.3	UN3355		2.3, 2.1	2, B9, B14	None	302, 305	314, 315	Forbidden	Forbidden	D	40
G	Insecticide gases, toxic, flammable, n.o.s. <i>Inhalation hazard Zone C</i>	2.3	UN3355		2.3, 2.1	3, B14	None	302, 305	314, 315	Forbidden	Forbidden	D	40
G	Insecticide gases, toxic, flammable, n.o.s. <i>Inhalation hazard Zone D</i>	2.3	UN3355		2.3, 2.1	4	None	302, 305	314, 315	Forbidden	Forbidden	D	40
G	Insecticide gases, toxic, n.o.s. <i>Inulin trinitrate (dry)</i>	2.3	UN1967		2.3	3	None	193, 334	245	Forbidden	Forbidden	D	40
+	Iodine	8	UN3495	III	8, 6.1	IB8, IP3, T1, TP33	154	213	240	25 kg	100 kg	B	40, 55
	<i>Iodine azide (dry)</i> Iodine monochloride, liquid	Forbidden 8	UN3498	II	8	IB2, T7, TP2	154	202	242	1 L	30 L	D	40, 66, 74, 89, 90
	Iodine monochloride, solid	8	UN1792	II	8	B6, IB8, IP2, IP4, N41, T7, TP2	None	212	240	Forbidden	50 kg	D	40, 66, 74, 90
	Iodine pentafluoride	5.1	UN2495	I	5.1, 6.1, 8		None	205	243	Forbidden	Forbidden	D	25, 40, 52, 66, 90
	2-Iodobutane	3	UN2390	II	3	IB2, T4, TP1	150	202	242	5 L	60 L	B	
	Iodomethylpropanes	3	UN2391	II	3	IB2, T4, TP1	150	202	242	5 L	60 L	B	
	Iodopropanes	3	UN2392	III	3	B1, IB3, T2, TP1	150	203	242	60 L	220 L	A	
	<i>Iodoxy compounds (dry)</i> <i>Iridium nitratopentamine iridium nitrate</i> Iron chloride, <i>see</i> Ferric chloride	Forbidden Forbidden											

Iron oxide, spent, or Iron sponge, spent obtained from coal gas purification	4.2	UN1376	III	4.2	B18, IB8, IP3, T1, TP33	None	213	240	Forbidden	Forbidden	E	40
Iron pentacarbonyl	6.1	UN1994	I	6.1, 3	1, B9, B14, B30, B77, T22, TP2, TP13, TP36, TP44	None	226	244	Forbidden	Forbidden	D	40
Iron sesquichloride, see Ferric chloride												
Irritating material, see Tear gas substances, etc												
Isobutane see also Petroleum gases, liquefied	2.1	UN1969		2.1	19, T50	306	304	314, 315	Forbidden	150 kg	E	40
Isobutanol or Isobutyl alcohol	3	UN1212	III	3	B1, IB3, T2, TP1	150	203	242	60 L	220 L	A	
Isobutyl acetate	3	UN1213	II	3	IB2, T4, TP1	150	202	242	5 L	60 L	B	
Isobutyl acrylate, stabilized	3	UN2527	III	3	B1, IB3, T2, TP1	150	203	242	60 L	220 L	A	
Isobutyl alcohol, see Isobutanol												
Isobutyl aldehyde, see Isobutyraldehyde												
Isobutyraldehyde	3	UN2393	II	3	IB2, T4, TP1	150	202	242	5 L	60 L	B	
Isobutyl formate	3	UN2528	III	3	B1, IB3, T2, TP1	150	203	242	60 L	220 L	A	
Isobutyl isobutyrate	6.1	UN2486	I	6.1, 3	1, B9, B14, B30, T20, TP2, TP13, TP27	None	226	244	Forbidden	Forbidden	D	40
Isobutyl isocyanate												
Isobutyl methacrylate, stabilized	3	UN2283	III	3	B1, IB3, T2, TP1	150	203	242	60 L	220 L	A	
Isobutyl propionate	3	UN2394	III	3	B1, IB3, T2, TP1	150	203	242	60 L	220 L	B	
Isobutylamine	3	UN1214	II	3, 8	IB2, T7, TP1	150	202	243	1 L	5 L	B	40
Isobutyrene see also Petroleum gases, liquefied	2.1	UN1055		2.1	19, T50	306	304	314, 315	Forbidden	150 kg	E	40
Isobutyraldehyde or Isobutyl aldehyde	3	UN2045	II	3	IB2, T4, TP1	150	202	242	5 L	60 L	E	40
Isobutyric acid	3	UN2529	III	3, 8	B1, IB3, T4, TP1	150	203	242	5 L	60 L	A	
Isobutyronitrile	3	UN2284	II	3, 6.1	IB2, T7, TP2, TP13	150	202	243	1 L	60 L	E	40
Isobutyl chloride	3	UN2395	II	3, 8	IB1, T7, TP2	150	202	243	1 L	5 L	C	40
Isocyanates, flammable, toxic, n.o.s. or isocyanate solutions, flammable, toxic, n.o.s., flash point less than 23 degrees C	3	UN2478	II	3, 6.1	5, A3, A7, IB2, T11, TP2, TP13, TP27	150	202	243	1 L	60 L	D	40
Isocyanates, toxic, flammable, n.o.s. or isocyanate solutions, toxic, flammable, n.o.s., flash point not less than 23 degrees C but not more than 61 degrees C and boiling point less than 300 degrees C	6.1	UN3080	III	3, 6.1	5, A3, A7, IB3, T7, TP1, TP13, TP28	150	203	242	60 L	220 L	A	
Isocyanates, toxic, n.o.s. or isocyanate solutions, toxic, n.o.s., flash point more than 61 degrees C and boiling point less than 300 degrees C	6.1	UN2206	II	6.1	IB2, T11, TP2, TP13, TP27	153	202	243	5 L	60 L	B	25, 40

§ 172.101 HAZARDOUS MATERIALS TABLE—Continued

(1) Sym-bols	(2) Hazardous materials descriptions and proper shipping names	(3) Hazard class or Division	(4) Identi-fication Numbers	(5) PG	(6) Label Codes	(7) Special provisions (§ 172.102)	(8) Packaging (§ 173.***)			(9) Quantity limitations (see §§ 173.27 and 175.75)		(10) Vessel stowage	
							Excep-tions (8A)	Non-bulk (8B)	Bulk (8C)	Passenger aircraft/rail (9A)	Cargo air-craft only (9B)	Loca-tion (10A)	Other (10B)
	Isocyanatobenzotrifluorides	6.1	UN2285	III	6.1	IB3, T7, TP1, TP13, TP28	153	203	241	60 L	220 L	E	25, 40
	Isophenes	3	UN2287	II	6.1, 3	5, IB2, T7, TP2	153	202	243	5 L	60 L	D	25, 40
	Isohexenes	3	UN2288	II	3	IB2, T4, TP1	150	202	242	5 L	60 L	B	
	Isocetane, see Octanes					IB2, T11, TP1	150	202	242	5 L	60 L	E	
	Isocetenes	3	UN1216	II	3	IB2, T4, TP1	150	202	242	5 L	60 L	B	
	<i>Isopentane, see Pentane</i>												
	<i>Isopentanoic acid, see Corrosive liquids, n.o.s.</i>												
	Isopentenes	3	UN2371	I	3	T11, TP2	150	201	243	1 L	30 L	E	
	Isophorone diisocyanate	6.1	UN2390	III	6.1	IB3, T4, TP2	153	203	241	60 L	220 L	B	40
	Isophoronediamine	8	UN2289	III	8	IB3, T4, TP1	154	203	241	5 L	60 L	A	
	Isoprene, stabilized	3	UN1218	I	3	T11, TP2	150	201	243	1 L	30 L	E	
	Isopropanol or isopropyl alcohol	3	UN1219	II	3	IB2, T4, TP1	4b, 150	202	242	5 L	60 L	B	
	Isopropenyl acetate	3	UN2403	III	3	IB2, T4, TP1	150	202	242	5 L	60 L	B	
	Isopropenylbenzene	3	UN2303	III	3	B1, IB3, T2, TP1	150	203	242	60 L	220 L	A	
	Isopropyl acetate	3	UN1220	II	3	IB2, T4, TP1	150	202	242	5 L	60 L	B	
	Isopropyl acid phosphate	8	UN1793	III	8	IB2, T4, TP1	154	213	240	25 kg	100 kg	A	
	Isopropyl alcohol, <i>see</i> Isopropanol												
	Isopropyl butyrate	3	UN2405	III	3	B1, IB3, T2, TP1	150	203	242	60 L	220 L	A	
	Isopropyl chloroacetate	3	UN2947	III	3	B1, IB3, T2, TP1	150	203	242	60 L	220 L	A	
	Isopropyl chloroformate	6.1	UN2407	I	6.1, 3, 8	2, B9, B14, B32, B77, T20, TP2, TP13, TP36, TP44	None	227	244	Forbidden	Forbidden	B	40
	Isopropyl 2-chloropropionate	3	UN2934	III	3	B1, IB3, T2, TP1	150	203	242	60 L	220 L	A	
	Isopropyl isobutyrate	3	UN2406	II	3	IB2, T4, TP1	150	202	242	5 L	60 L	B	
	Isopropyl isocyanate	6.1	UN2483	I	6.1, 3	1, B9, B14, B30, T20, TP2, TP13, TP38, TP44	None	226	244	Forbidden	Forbidden	D	40
	<i>Isopropyl mercaptan, see Propanethiols</i>												
	Isopropyl nitrate	3	UN1222	II	3	IB9	150	202	None	5 L	60 L	D	
	<i>Isopropyl phosphoric acid, see Isopropyl acid phosphate</i>												
	Isopropyl propionate	3	UN2409	II	3	IB2, T4, TP1	150	202	242	5 L	60 L	B	
	Isopropylamine	3	UN1221	I	3, 8	T11, TP2	None	201	243	0.5 L	2.5 L	E	
	Isopropylbenzene	3	UN1918	III	3	B1, IB3, T2, TP1	150	203	242	60 L	220 L	A	

+

D	Isopropylcumyl hydroperoxide, with more than 72 percent in solution	Forbidden	UN2907	II	4.1	IB6, IP2, N85	None	212	None	15 kg	50 kg	E	28, 36
	Isosorbide dinitrate mixture with not less than 60 percent lactose, mannose, starch or calcium hydrogen phosphate	4.1	UN3251	III	4.1	66, 159, IB8	151	223	240	Forbidden	Forbidden	D	12, 25, 40, 84
	Isosorbide-5-mononitrate	Forbidden											
	Isothiocyanic acid												
	Jet fuel, see Fuel aviation, turbine engine												
	Jet perforating guns, charged oil well, with detonator	1.1D	NA0124	II	1.1D	55, 56	None	62	None	Forbidden	Forbidden	04	25
	Jet perforating guns, charged oil well, with detonator	1.4D	NA0494	II	1.4D	55, 56	None	62	None	Forbidden	Forbidden	02	25
	Jet perforating guns, charged oil well, without detonator	1.4D	UN0494	II	1.4D	55, 114	None	62	None	Forbidden	300 kg	02	25
	Jet perforating guns, charged oil well, without detonator	1.1D	UN0124	II	1.1D	55	None	62	None	Forbidden	Forbidden	04	25
	Jet perforators, see Charges, shaped, etc												
Jet tappers, without detonator, see Charges, shaped, etc													
Charges, shaped, etc													
Jet thrust igniters, for rocket motors or Jato, see Igniters													
Jet thrust unit (Jato), see Rocket motors													
G	Kerosene	3	UN1223	III	3	144, B1, IB3, T2, TP2	150	203	242	60 L	220 L	A	
	Ketones, liquid, n.o.s.	3	UN1224	I	3	T11, TP1, TP8, TP27	None	201	243	1 L	30 L	E	
								202	242	5 L	60 L	B	
								203	242	60 L	220 L	A	
								212	242	No limit	No limit	B	25, 88, 128
	Krill meal	4.2	UN3497	II	4.2	155, IB6, IP2, T3, TP33	None	212	242	No limit	No limit	A	
								213	75 kg	150 kg	500 kg	D	
	Krypton, compressed	2.2	UN1056	III	4.2	155, IB8, IP3, T1, TP33	None	213	None	None	None	A	
	Krypton, refrigerated liquid (cryogenic liquid)	2.2	UN1970	2.2	2.2	306, 307	320	None	None	50 kg	500 kg	D	
	Lacquer base or lacquer chips, nitrocellulose, dry, see Nitrocellulose, etc. (UN 2557)												
Lacquer base or lacquer chips, plastic, wet with alcohol or solvent, see Nitrocellulose (UN2059, UN2555, UN2556, UN2557) or Paint etc.(UN1263)													
Lead acetate	6.1	UN1616	III	6.1	IB8, IP3, T1, TP33	153	213	240	240	100 kg	200 kg	A	
Lead arsenates	6.1	UN1617	II	6.1	IB8, IP2, IP4, T3, TP33	153	212	242	242	25 kg	100 kg	A	
Lead arsenites	6.1	UN1618	II	6.1	IB8, IP2, IP4, T3, TP33	153	212	242	242	25 kg	100 kg	A	
Lead azide (dry)	Forbidden												

§ 172.101 HAZARDOUS MATERIALS TABLE—Continued

(1) Sym-bols	(2) Hazardous materials descriptions and proper shipping names	(3) Hazard class or Division	(4) Identi-fication Numbers	(5) PG	(6) Label Codes	(7) Special provisions (§ 172.102)	(8) Packaging (§ 173.***)			(9) Quantity limitations (see §§ 173.27 and 175.75)		(10) Vessel stowage	
							Excep-tions (8A)	Non-bulk (8B)	Bulk (8C)	Passenger aircraft/rail (9A)	Cargo air-craft only (9B)	Loca-tion (10A)	Other (10B)
G	Lead azide, wetted with not less than 20 percent water or mixture of alcohol and water, by mass	1.1A	UN0129	II	1.1A	111, 117	None	62	None	Forbidden	Forbidden	05	25
	Lead compounds, soluble, n.o.s	6.1	UN2291	III	6.1	138, IB8, IP3, T1, TP33	153	213	240	100 kg	200 kg	A	52
	Lead cyanide	6.1	UN1620	II	6.1	IB8, IP2, IP4, T3, TP33	153	212	242	25 kg	100 kg	A	
	Lead dioxide	5.1	UN1872	III	5.1	A1, IB8, IP3, T1, TP33	152	213	240	25 kg	100 kg	A	
	Lead dross, see Lead sulfate, with more than 3 percent free acid												
	Lead nitrate	5.1	UN1469	II	5.1, 6.1	IB8, IP2, IP4, T3, TP33	152	212	242	5 kg	25 kg	A	
	Lead nitroresorcinate (dry)	Forbidden											
	Lead perchlorate, solid	5.1	UN1470	II	5.1, 6.1	IB6, IP2, T3, TP33	152	212	242	5 kg	25 kg	A	56, 58
	Lead perchlorate, solution	5.1	UN3408	II	5.1, 6.1	IB2, T4, TP1	152	202	243	1 L	5 L	A	56, 58
				III	5.1, 6.1	IB2, T4, TP1	152	203	242	2.5 L	30 L	A	56, 58
Lead peroxide, see Lead dioxide	4.1	UN2989	II	4.1	1.1A	111, 117	None	62	None	Forbidden	Forbidden	05	25
Lead phosphite, dibasic	Forbidden												
Lead picrate (dry)	Forbidden												
Lead styphnate (dry)	1.1A	UN0130	II	1.1A	1.1A	111, 117	None	62	None	Forbidden	Forbidden	05	25
Lead styphnate, wetted or Lead trinitroresorcinate, wetted with not less than 20 percent water or mixture of alcohol and water, by mass	8	UN1794	II	8	8	IB8, IP2, IP4, T3, TP33	154	212	240	15 kg	50 kg	A	
Lead sulfate with more than 3 percent free acid													
Lead trinitroresorcinate, see Lead styphnate, etc	9	UN3072			None		None	219	None	No limit	No limit	A	
Life-saving appliances, not self-inflating containing dangerous goods as equipment													
Life-saving appliances, self-inflating	9	UN2990		None	338	None	219	None	No limit	No limit	A	40
Lighters containing flammable gas	2.1	UN1057			2.1	168	21,308	21,308	None	1 kg	15 kg	B	
Lighters, new or empty, purged of all residual fuel and vapors						168							

§ 172.101 HAZARDOUS MATERIALS TABLE—Continued

(1) Sym-bols	(2) Hazardous materials descriptions and proper shipping names	(3) Hazard class or Division	(4) Identi-fication Numbers	(5) PG	(6) Label Codes	(7) Special provisions (§ 172.102)	(8) Packaging (§ 173.***)			(9) Quantity limitations (see §§ 173.27 and 175.75)		(10) Vessel stowage	
							Excep-tions (8A)	Non-bulk (8B)	Bulk (8C)	Passenger aircraft/rail (9A)	Cargo air-craft only (9B)	Loca-tion (10A)	Other (10B)
G	Liquefied gas, toxic, n.o.s. <i>Inhalation Hazard Zone C</i>	2.3	UN3162		2.3	3, B14	None	304	314, 315	Forbidden	Forbidden	D	40
G	Liquefied gas, toxic, n.o.s. <i>Inhalation Hazard Zone D</i>	2.3	UN3162		2.3	4	None	304	314, 315	Forbidden	Forbidden	D	40
G I	Liquefied gas, toxic, oxidizing, corrosive, n.o.s. <i>Inhalation Hazard Zone A</i>	2.3	UN3310		2.3, 5.1, 8	1	None	192	245	Forbidden	Forbidden	D	40, 89, 90
G I	Liquefied gas, toxic, oxidizing, corrosive, n.o.s. <i>Inhalation Hazard Zone B</i>	2.3	UN3310		2.3, 5.1, 8	2, B9, B14	None	304	314, 315	Forbidden	Forbidden	D	40, 89, 90
G I	Liquefied gas, toxic, oxidizing, corrosive, n.o.s. <i>Inhalation Hazard Zone C</i>	2.3	UN3310		2.3, 5.1, 8	3, B14	None	304	314, 315	Forbidden	Forbidden	D	40, 89, 90
G I	Liquefied gas, toxic, oxidizing, corrosive, n.o.s. <i>Inhalation Hazard Zone D</i>	2.3	UN3310		2.3, 5.1, 8	4	None	304	314, 315	Forbidden	Forbidden	D	40, 89, 90
G	Liquefied gas, toxic, oxidizing, n.o.s. <i>Inhalation Hazard Zone A</i>	2.3	UN3307		2.3, 5.1	1	None	192	245	Forbidden	Forbidden	D	40
G	Liquefied gas, toxic, oxidizing, n.o.s. <i>Inhalation Hazard Zone B</i>	2.3	UN3307		2.3, 5.1	2, B9, B14	None	304	314, 315	Forbidden	Forbidden	D	40
G	Liquefied gas, toxic, oxidizing, n.o.s. <i>Inhalation Hazard Zone C</i>	2.3	UN3307		2.3, 5.1	3, B14	None	304	314, 315	Forbidden	Forbidden	D	40
G	Liquefied gas, toxic, oxidizing, n.o.s. <i>Inhalation Hazard Zone D</i>	2.3	UN3307		2.3, 5.1	4	None	304	314, 315	Forbidden	Forbidden	D	40
	Liquefied gases, <i>non-flammable charged with nitrogen, carbon dioxide or air</i>	2.2	UN1058		2.2		306	304	None	75 kg	150 kg	A	
	Liquefied hydrocarbon gas, see Hydrocarbon gas mixture, liquefied, n.o.s.												
	Liquefied natural gas, see Methane, etc. (UN 1972)												
	Liquefied petroleum gas, see Petroleum gases, liquefied												
	Lithium acetylide ethylenediamine complex, see Water reactive solid etc	4.3	UN1415	I	4.3	A7, A19, IB4, IP1, N45	None	211	244	Forbidden	15 kg	E	52

Lithium aluminum hydride	4.3	UN1410	I	4.3	A19	None	211	242	Forbidden	15 kg	E	52
Lithium aluminum hydride, ethereal	4.3	UN1411	I	4.3, 3	A2, A3, A11, N34	None	201	244	Forbidden	1 L	D	40
Lithium borohydride	4.3	UN1413	I	4.3	A19, N40	None	211	242	Forbidden	15 kg	E	52
Lithium ferrosilicon	4.3	UN2830	II	4.3	A19, IB7, IP2, T3, TP33	151	212	241	Forbidden	50 kg	E	40, 85, 103
Lithium hydride	4.3	UN1414	I	4.3	A19, N40	None	211	242	Forbidden	15 kg	E	52
Lithium hydride, fused solid	4.3	UN2805	II	4.3	A8, A19, A20, IB4, T3, TP33	151	212	241	Forbidden	50 kg	E	52
Lithium hydroxide	8	UN2680	II	8	IB8, IP2, IP4, T3, TP33	154	212	240	15 kg	A	A	52.
Lithium hydroxide, solution	8	UN2679	III	8	B2, IB2, T7, TP2	154	202	242	1 L	A	A	29, 52.
					IB3, T4, TP2	154	203	241	5 L	A	A	29, 52.
Lithium hypochlorite, dry or Lithium hypochlorite mixture	5.1	UN1471	II	5.1	A9, IB8, IP2, IP4, N34, T3, TP33	152	212	240	5 kg	A	A	4, 25, 52, 56, 58, 69, 106, 116
		III	5.1	IB8, IP3, N34, T1, TP33	152	213	240	25 kg	A	A	4, 25, 52, 56, 58, 69, 106, 116
<i>Lithium in cartridges, see Lithium</i>												
<i>Lithium ion batteries including lithium ion polymer batteries</i>	9	UN3480	II	9	A51, A54	185	185	185	5 kg	A	A	
<i>Lithium ion batteries contained in equipment including lithium ion polymer batteries</i>	9	UN3481	II	9	A54	185	185	185	5 kg	A	A	
<i>Lithium ion batteries packed with equipment including lithium ion polymer batteries</i>	9	UN3481	II	9	A54	185	185	185	5 kg	A	A	
<i>Lithium metal batteries including lithium alloy batteries</i>	9	UN3090	II	9	A54	185	185	185	Forbidden	35 kg	A	
<i>Lithium metal batteries contained in equipment including lithium alloy batteries</i>	9	UN3091	II	9	A54, A101	185	185	185	5 kg	A	A	
<i>Lithium metal batteries packed with equipment including lithium alloy batteries</i>	9	UN3091	II	9	A54	185	185	185	5 kg	A	A	
Lithium nitrate	5.1	UN2722	III	5.1	A1, IB8, IP3, T1, TP33	152	213	240	25 kg	A	A	
Lithium nitride	4.3	UN2806	I	4.3	A19, IB4, IP1, N40	None	211	242	Forbidden	100 kg	E	13, 52, 66, 75
Lithium peroxide	5.1	UN1472	II	5.1	A9, IB6, IP2, N34, T3, TP33	152	212	None	5 kg	A	A	
Lithium silicon	4.3	UN1417	II	4.3	A19, A20, IB7, IP2, T3, TP33	151	212	241	15 kg	A	A	85, 103
LNG, see Methane etc. (UN 1972) London purple LPG, see Petroleum gases, liquefied	6.1	UN1621	II	6.1	IB8, IP2, IP4, T3, TP33	153	212	242	25 kg	A	A	

§ 172.101 HAZARDOUS MATERIALS TABLE—Continued

(1) Sym-bols	(2) Hazardous materials descriptions and proper shipping names	(3) Hazard class or Division	(4) Identi-fication Numbers	(5) PG	(6) Label Codes	(7) Special provisions (§ 172.102)	(8) Packaging (§ 173.***)			(9) Quantity limitations (see §§ 173.27 and 175.75)		(10) Vessel stowage	
							Excep-tions (8A)	Non-bulk (8B)	Bulk (8C)	Passenger aircraft/rail (9A)	Cargo air-craft only (9B)	Loca-tion (10A)	Other (10B)
	Lye, see Sodium hydroxide, solu-tions Magnesium aluminum phosphide	4.3	UN1419	I	4.3, 6.1	A19, N34, N40	None	211	242	Forbidden	15 kg	E	40, 52, 85
+	Magnesium arsenate <i>Magnesium bisulfite solution, see Bisulfites, aqueous solutions, n.o.s.</i> Magnesium bromate	6.1	UN1622	II	6.1	IB8, IP2, IP4, T3, TP33	153	212	242	25 kg	100 kg	A	
	Magnesium chlorate	5.1	UN1473	II	5.1	A1, IB8, IP2, IP4, T3, TP33	152	212	242	5 kg	25 kg	A	56, 58
	Magnesium diamide	5.1	UN2723	II	5.1	IB8, IP2, IP4, T3, TP33	152	212	242	5 kg	25 kg	A	56, 58
	Magnesium diarsite	4.2	UN2004	II	4.2	A8, A19, A20, IB6, T3, TP33	None	212	241	15 kg	50 kg	C	
	<i>Magnesium dross, wet or hot</i> Magnesium fluorosilicate	Forbidden	UN2853	III	6.1	IB8, IP3, T1, TP33	153	213	240	100 kg	200 kg	A	52
	Magnesium granulates, coated, <i>particle size not less than 149 microns</i>	4.3	UN2950	III	4.3	A1, A19, IB8, IP4, T1, TP33	151	213	240	25 kg	100 kg	A	52
	Magnesium hydride Magnesium or Magnesium alloys with more than 50 percent magnesium in pellets, turnings or ribbons	4.3 4.1	UN2010 UN1869	I III	4.3 4.1	A19, N40 A1, IB8, IP3, T1, TP33	None 151	211 213	242 240	Forbidden 25 kg	15 kg 100 kg	E A	52 39, 52, 53, 74, 101
	Magnesium nitrate	5.1	UN1474	III	5.1	332, A1, B120, IB8, IP3, T1, TP33	152	213	240	25 kg	100 kg	A	
	Magnesium perchlorate	5.1	UN1475	II	5.1	IB6, IP2, T3, TP33	152	212	242	5 kg	25 kg	A	56, 58
	Magnesium peroxide	5.1	UN1476	II	5.1	IB6, IP2, T3, TP33	152	212	242	5 kg	25 kg	A	13, 52, 66, 75
	Magnesium phosphide	4.3	UN2011	I	4.3,	A19, N40	None	211	None	Forbidden	15 kg	E	40, 52, 85
	Magnesium, powder or Magnesium alloys, powder	4.3	UN1418	I	4.3, 4.2	A19, B56	None	211	244	Forbidden	15 kg	A	39, 52
	<i>Magnesium scrap, see Magnesium, etc. (UN 1869)</i>			II III	4.3, 4.2	A19, B56, IB5, IP2, T3, TP33 A19, B56, IB8, IP4, T1, TP33	None None	212 213	241 241	15 kg 25 kg	50 kg 100 kg	A A	39, 52 39, 52

Magnesium silicide	4.3	UN2624	II	4.3	A19, A20, IB7, IP2, T3, TP33	151	212	241	15 kg	50 kg	B	85, 103
Magnetized material, see § 173.21												
Maleic anhydride	8	UN2215	III	8	IB8, IP3, T1, TP33	154	213	240	25 kg	100 kg	A	
Maleic anhydride, molten	8	UN2215	III	8	IB8, IP3, T1, TP33	None	213	240	Forbidden	Forbidden	A	
Malononitrile	6.1	UN2647	II	6.1	IB8, IP2, IP4, T3, TP33	153	212	242	25 kg	100 kg	A	12
Manganese ethylenebis(dithiocarbamate) complex with zinc; see Maneb												
Maneb or Maneb preparations with not less than 60 percent maneb	4.2	UN2210	III	4.2, 4.3	57, A1, A19, IB6, T1, TP33	None	213	242	25 kg	100 kg	A	34
Maneb stabilized or Maneb preparations, stabilized against self-heating	4.3	UN2968	III	4.3	54, A1, A19, IB8, IP4, T1, TP33	151	213	242	25 kg	100 kg	B	34, 52
Manganese nitrate	5.1	UN2724	III	5.1	A1, IB8, IP3, T1, TP33	152	213	240	25 kg	100 kg	A	
Manganese resinates	4.1	UN1930	III	4.1	A1, IB6, T1, TP33	151	213	240	25 kg	100 kg	A	
Mannitol tetranitrate	Forbidden											
Mannitol hexanitrate (dry)	Forbidden											
Mannitol hexanitrate, wetted or Nitromannite, wetted with not less than 40 percent water, or mixture of alcohol and water, by mass	1.1D	UN0133	II	1.1D	121	None	62	None	Forbidden	Forbidden	04	25
Manne pollutants, liquid or solid, n.o.s., see Environmentally hazardous substances, liquid or solid, n.o.s.												
Matches, block, see Matches, 'strike anywhere'												
Matches, fusee	4.1	UN2254	III	4.1		186	186	None	Forbidden	Forbidden	A	
Matches, safety (book, card or strike on box)	4.1	UN1944	III	4.1		186	186	None	25 kg	100 kg	A	
Matches, strike anywhere	4.1	UN1331	III	4.1		186	186	None	Forbidden	Forbidden	B	
Matches, wax, Vesta	4.1	UN1945	III	4.1		186	186	None	25 kg	100 kg	B	
Matting acid, see Sulfuric acid												
Medicine, liquid, flammable, toxic, n.o.s.	3	UN3248	II	3, 6.1	IB2	150	202	243	1 L	60 L	B	40
Medicine, liquid, toxic, n.o.s.	6.1	UN1851	III	3, 6.1	IB3	150	203	242	60 L	220 L	A	
Medicine, solid, toxic, n.o.s.	6.1	UN3249	III	6.1		153	202	243	5 L	60 L	C	40
Memtetrahydrophthalic anhydride, see Corrosive liquids, n.o.s.												
Mercaptans, liquid, flammable, n.o.s. or Mercaptan mixture, liquid, flammable, n.o.s.	6.1	UN3249	III	6.1	T3, TP33	153	212	242	25 kg	100 kg	C	40
									100 kg	200 kg	C	40
	3	UN3336	I	3	T3, TP33	153	213	240	1 L	30 L	E	95
	II		II	3	T11, TP2	150	201	243	1 L	30 L	E	95
	III		III	3	IB2, T7, TP1, TP8, TP28	150	202	242	5 L	60 L	B	95
	III		III	3	B1, B52, IB3, T4, TP1, TP29	150	203	241	60 L	220 L	B	95

§ 172.101 HAZARDOUS MATERIALS TABLE—Continued

(1) Sym-bols	(2) Hazardous materials descriptions and proper shipping names	(3) Hazard class or Division	(4) Identi-fication Numbers	(5) PG	(6) Label Codes	(7) Special provisions (§ 172.102)	(8) Packaging (§ 173.***)			(9) Quantity limitations (see §§ 173.27 and 175.75)			(10) Vessel stowage												
							Excep-tions (8A)	Non-bulk (8B)	Bulk (8C)	Passenger aircraft/rail (9A)	Cargo air-craft only (9B)	Other (10B)	Loca-tion (10A)												
	Mercaptans, liquid, flammable, toxic, n.o.s. or Mercaptan mix-tures, liquid, flammable, toxic, n.o.s.	3	UN1228	II	3, 6.1	IB2, T11, TP2, TP27	None	202	243	Forbidden	60 L	B	40, 95												
														6.1	UN3071	II	6.1, 3	A6, B1, IB3, T7, TP1, TP28	150	203	242	5 L	220 L	A	40, 95
6.1	UN1623	II	6.1	IB8, IP2, IP4, T3, TP33	153	212	242	25 kg	100 kg	A	40, 121														
												6.1	UN1624	II	6.1	IB8, IP2, IP4, T3, TP33	153	212	242	25 kg	100 kg	A	40, 121		
6.1	UN1625	II	6.1	IB8, IP2, IP4, N73, T3, TP33	153	212	242	25 kg	100 kg	A	40, 121														
												6.1	UN1626	I	6.1	IB7, IP1, N74, N75, T6, TP33	None	211	242	5 kg	50 kg	A	40, 121		
A W	6.1	UN3012	I	6.1	IB2, T11, TP2, TP13, TP27	150	202	1 L	60 L	B	40														
												6.1	UN3012	I	6.1	T14, TP2, TP13, TP27	None	201	243	1 L	30 L	B	40		

§ 172.101 HAZARDOUS MATERIALS TABLE—Continued

(1) Sym-bols	(2) Hazardous materials descriptions and proper shipping names	(3) Hazard class or Division	(4) Identi-fication Numbers	(5) PG	(6) Label Codes	(7) Special provisions (§ 172.102)	(8) Packaging (§ 173.***)			(9) Quantity limitations (see §§ 173.27 and 175.75)		(10) Vessel stowage	
							Excep-tions	Non-bulk	Bulk	Passenger aircraft/rail	Cargo air-craft only	Loca-tion	Other
(1)	(2)	(3)	(4)	(5)	(6)	(7)	(8A)	(8B)	(8C)	(9A)	(9B)	(10A)	(10B)
G	Metal catalyst, dry	4.2	UN2881	II	6.1	IB8, IP2, IP4, T3, TP33	153	212	242	25 kg	100 kg	B	40
							153	213	240	100 kg	200 kg	B	40
G	Metal catalyst, wetted with a visible excess of liquid	4.2	UN1378	III	4.2	N34, T21, TP7, TP33	None	187	None	Forbidden	Forbidden	C	
							None	187	None	50 kg	50 kg	C	
							None	187	241	25 kg	100 kg	C	
							None	212	None	Forbidden	50 kg	C	
G	Metal hydrides, flammable, n.o.s.	4.1	UN3182	II	4.1	A1, IB4, T3, TP33	151	212	240	15 kg	50 kg	E	
							151	213	240	25 kg	100 kg	E	
							None	211	242	Forbidden	15 kg	D	52
G	Metal hydrides, water reactive, n.o.s.	4.3	UN1409	I	4.3	A19, N34, N40	None	211	242	Forbidden	15 kg	D	52
							151	212	242	15 kg	50 kg	D	
G	Metal powder, self-heating, n.o.s.	4.2	UN3189	II	4.2	IB6, IP2, T3, TP33	None	212	241	15 kg	50 kg	C	
							None	213	241	25 kg	100 kg	C	
							None	212	240	15 kg	50 kg	B	
							151	213	240	25 kg	100 kg	B	
G	Metal powders, flammable, n.o.s.	4.1	UN3089	III	4.1	IB8, IP2, IP4, T3, TP33	151	213	240	25 kg	100 kg	B	
							151	212	240	15 kg	50 kg	B	
G	Metal salts of methyl nitramine (dry) flammable, n.o.s.	4.1	UN3181	II	4.1	A1, IB8, IP2, IP4, T3, TP33	151	212	240	15 kg	50 kg	B	40
							151	213	240	25 kg	100 kg	B	40
G	Metaldehyde	4.1	UN1332	III	4.1	A1, IB8, IP3, T1, TP33	151	213	240	25 kg	100 kg	B	40
							151	213	240	25 kg	100 kg	A	40
G	Metallic substance, water-reactive, n.o.s.	4.3	UN3208	I	4.3	A7, IB4	None	211	242	Forbidden	15 kg	E	40
							None	212	242	15 kg	50 kg	E	40
G	Metallic substance, water-reactive, self-heating, n.o.s.	4.3	UN3209	I	4.3, 4.2	A7, IB7, IP2, T3, TP33	151	212	242	15 kg	50 kg	E	40
							None	213	241	25 kg	100 kg	E	40
G	Metallic substance, water-reactive, self-heating, n.o.s.	4.3	UN3209	I	4.3, 4.2	A7, IB8, IP4, T1, TP33	None	212	242	15 kg	50 kg	E	40
							None	213	242	25 kg	100 kg	E	40
+	Methacrylaldehyde, stabilized	3	UN2396	II	3, 6.1	45, IB2, T7, TP1, TP13	150	202	243	1 L	60 L	E	40
							154	202	242	1 L	30 L	C	40
+	Methacrylic acid, stabilized	8	UN2531	II	8	41, IB2, T7, TP1, TP18, TP30	None	227	244	Forbidden	Forbidden	D	12, 25, 40
							150	203	242	60 L	220 L	A	

§ 172.101 HAZARDOUS MATERIALS TABLE—Continued

(1) Sym-bols	(2) Hazardous materials descriptions and proper shipping names	(3) Hazard class or Division	(4) Identi-fication Numbers	(5) PG	(6) Label Codes	(7) Special provisions (§ 172.102)	(8) Packaging (§ 173.***)			(9) Quantity limitations (see §§ 173.27 and 175.75)		(10) Vessel stowage	
							Excep-tions (8A)	Non-bulk (8B)	Bulk (8C)	Passenger aircraft/rail (9A)	Cargo air-craft only (9B)	Loca-tion (10A)	Other (10B)
	<i>Methyl chloride and chloropicrin mixtures, see Chloropicrin and methyl chloride mixtures</i>	2.1	UN1912		2.1	N86, T50	306	304	314, 315	Forbidden	150 kg	D	40
	<i>Methyl chloride and methylene chloride mixtures</i>	6.1	UN2295	I	6.1, 3	T14, TP2, TP13	None	201	243	1 L	30 L	D	
	<i>Methyl chloroacetate</i>												
	<i>Methyl chlorocarbonate, see Methyl chloroformate</i>												
	<i>Methyl chloroform, see 1,1,1-Trichloroethane</i>												
	<i>Methyl chloroformate</i>	6.1	UN1238	I	6.1, 3, 8	1, B9, B14, B30, N34, T22, TP2, TP13, TP38, TP44	None	226	244	Forbidden	Forbidden	D	21, 40, 100
	<i>Methyl chloromethyl ether</i>	6.1	UN1239	I	6.1, 3	1, B9, B14, B30, T22, TP2, TP13, TP38, TP44	None	226	244	Forbidden	Forbidden	D	40
	<i>Methyl 2-chloropropionate</i>	3	UN2933	III	3	B1, B3, T2, TP1	150	203	242	60 L	220 L	A	
	<i>Methyl dichloroacetate</i>	6.1	UN2299	III	6.1	IB3, T4, TP1	153	203	241	60 L	220 L	A	
	<i>Methyl ethyl ether, see Ethyl methyl ether</i>												
	<i>Methyl ethyl ketone, see Ethyl methyl ketone</i>												
	<i>Methyl ethyl ketone, see Ethyl methyl ketone</i>												
	<i>Methyl ethyl ketone peroxide, in solution with more than 9 percent by mass active oxygen</i>	Forbidden											
	<i>2-Methyl-5-ethylpyridine</i>	6.1	UN2300	III	6.1	IB3, T4, TP1	153	203	241	60 L	220 L	A	40
	<i>Methyl fluoride, or Refrigerant gas R 41</i>	2.1	UN2454		2.1		306	304	314, 315	Forbidden	150 kg	E	
	<i>Methyl formate</i>	3	UN1243	I	3	T11, TP2	150	201	243	1 L	30 L	E	
	<i>2-Methyl-2-heptanethiol</i>	6.1	UN3023	I	6.1, 3	2, B9, B14, B32, T20, TP2, TP13, TP38, TP45	None	227	244	Forbidden	Forbidden	D	40, 102
	<i>Methyl iodide</i>	6.1	UN2644	I	6.1	2, B9, B14, B32, T20, TP2, TP13, TP38, TP45	None	227	244	Forbidden	Forbidden	D	12, 40
	<i>Methyl isobutyl carbinol</i>	3	UN2053	III	3	B1, B3, T2, TP1	150	203	242	60 L	220 L	A	
	<i>Methyl isobutyl ketone</i>	3	UN1245	II	3	IB2, T4, TP1	150	202	242	5 L	60 L	B	
	<i>Methyl isobutyl ketone peroxide, in solution with more than 9 percent by mass active oxygen</i>	Forbidden											

Methyl isocyanate	6.1	UN2480	I	6.1, 3	1, B9, B14, B30, T22, TP2, TP13, TP38, TP44, IB2, T4, TP1	None	226	244	Forbidden	Forbidden	D	40, 52
Methyl isopropenyl ketone, stabilized	3	UN1246	II	3		150	202	242	5 L	60 L	B	
Methyl isothiocyanate	6.1	UN2477	I	6.1, 3	2, B9, B14, B32, T20, TP2, TP13, TP38, TP45, IB2, T4, TP1	None	227	244	Forbidden	Forbidden	D	40
Methyl isovalerate	3	UN2400	II	3		150	202	242	5 L	60 L	B	
Methyl magnesium bromide, in ethyl ether	4.3	UN1928	I	4.3, 3		None	201	243	Forbidden	1 L	D	
Methyl mercaptan	2.3	UN1064		2.3, 2.1	3, B7, B9, B14, N89, T50	None	304	314, 315	Forbidden	Forbidden	D	40
<i>Methyl mercaptopropionaldehyde, see 4-Thiapentanal</i>		
Methyl methacrylate monomer, stabilized	3	UN1247	II	3	IB2, T4, TP1	150	202	242	5 L	60 L	B	40
Methyl nitramine (dry)	Forbidden											
Methyl nitrate	Forbidden											
Methyl nitrite	Forbidden											
Methyl <i>norbornene dicarboxylic anhydride</i> , see Corrosive liquids, n.o.s.												
Methyl orthosilicate	6.1	UN2606	I	6.1, 3	2, B9, B14, B32, T20, TP2, TP13, TP38, TP45	None	227	244	Forbidden	Forbidden	D	40
Methyl phosphonic dichloride	6.1	NA9206	I	6.1, 8	2, B9, B14, B32, N34, N43, T20, TP4, TP13, TP38, TP45	None	227	244	Forbidden	Forbidden	C	
<i>Methyl phosphonothioic dichloride, anhydrous</i> , see Corrosive liquid, n.o.s.												
Methyl phosphorous dichloride, pyrophoric liquid	6.1	NA2845	I	6.1, 4.2	2, B9, B14, B16, B32, T20, TP4, TP12, TP13, TP38, TP45	None	227	244	Forbidden	Forbidden	D	18
<i>Methyl picric acid (heavy metal salts of)</i>	Forbidden											
Methyl propionate	3	UN1248	II	3	IB2, T4, TP1	150	202	242	5 L	60 L	B	
Methyl propyl ether	3	UN2612	II	3	IB2, IP8, T7, TP2	150	202	242	5 L	60 L	E	40
Methyl propyl ketone	3	UN1249	II	3	IB2, T4, TP1	150	202	242	5 L	60 L	B	
<i>Methyl sulfate</i> , see Dimethyl sulfate												
<i>Methyl sulfide</i> , see Dimethyl sulfide												
Methyl trichloroacetate	6.1	UN2533	III	6.1	IB3, T4, TP1	153	203	241	60 L	220 L	A	
<i>Methyl trimethyl methane trinitrate</i>	Forbidden											
Methyl vinyl ketone, stabilized	6.1	UN1251	I	6.1, 3, 8	1, B9, B14, B30, T22, TP2, TP13, TP38, TP44, IB2, IP8, T7, TP2	None	226	244	Forbidden	Forbidden	B	40
Methylal	3	UN1234	II	3		None	202	242	5 L	60 L	E	
Methylamine, anhydrous	2.1	UN1061	II	2.1	N87, T50	306	304	314, 315	Forbidden	150 kg	B	40
Methylamine, aqueous solution	3	UN1235	II	3, 8	B1, IB2, T7, TP1	150	202	243	1 L	5 L	E	52, 195.
<i>Methylamine dinitramine and dry salts thereof</i>	Forbidden											

D

D

§ 172.101 HAZARDOUS MATERIALS TABLE—Continued

(1) Sym-bols	(2) Hazardous materials descriptions and proper shipping names	(3) Hazard class or Division	(4) Identi-fication Numbers	(5) PG	(6) Label Codes	(7) Special provisions (§ 172.102)	(8) Packaging (§ 173.***)			(9) Quantity limitations (see §§ 173.27 and 175.75)		(10) Vessel stowage	
							Excep-tions (8A)	Non-bulk (8B)	Bulk (8C)	Passenger aircraft/rail (9A)	Cargo air-craft only (9B)	Loca-tion (10A)	Other (10B)
D	Methylamine nitroform	Forbidden											
	Methylamine perchlorate (dry)	Forbidden	UN1233	III	3	B1, IB3, T2, TP1	150	203	242	60 L	220 L	A	
	Methylamyl acetate	3	UN2294	III	6.1	IB3, T4, TP1	153	203	241	60 L	220 L	A	
	N-Methylamine	6.1	UN2937	III	6.1	IB3, T4, TP1	153	203	241	60 L	220 L	A	
	alpha-Methylbenzyl alcohol, liquid	6.1	UN3438	III	6.1	IB8, IP3, T1, TP33	153	213	240	100 kg	200 kg	A	
	alpha-Methylbenzyl alcohol, solid	3	UN2397	II	3	IB2, T4, TP1	150	202	242	5 L	60 L	B	
	3-Methylbutan-2-one	3	UN2945	II	3, 8	IB2, T7, TP1	150	202	243	1 L	5 L	B	40
	N-Methylbutylamine	2.3	UN2534	II	2, 3, 2.1, 8	2, B9, B14, N34	None	226	314, 315	Forbidden	Forbidden	D	17, 40
	Methylchlorosilane	3	UN2296	II	3	B1, IB2, T4, TP1	150	202	242	5 L	60 L	B	
	Methylcyclohexane	3	UN2617	III	3	B1, IB3, T2, TP1	150	203	242	60 L	220 L	A	
	Methylcyclohexanols, flammable	3	UN2297	III	3	B1, IB3, T2, TP1	150	203	242	60 L	220 L	A	
	Methylcyclohexanone	3	UN2298	II	3	IB2, T4, TP1	150	202	242	5 L	60 L	B	
	Methylcyclopentane	6.1	NA1556	I	6.1	2, T20, TP4, TP13, TP38, TP45	None	192	None	Forbidden	Forbidden	D	40
	Methyldichloroarsine	4.3	UN1242	I	4, 3, 8, 3	A2, A3, A7, B6, B77, N84, T14, TP2, TP7, TP13	None	201	243	Forbidden	1 L	D	21, 28, 40, 49, 100
	Methyldichlorosilane												
Methylene chloride, see Dichloromethane													
Methylene glycol dinitrate	Forbidden												
2-Methylfuran	3	UN2301	II	3	IB2, T4, TP1	150	202	242	5 L	60 L	E		
a-Methylglucoside tetranitrate	Forbidden												
5-Methylhexan-2-one	3	UN2302	III	3	B1, IB3, T2, TP1	150	203	242	60 L	220 L	A		
Methylhydrazine	6.1	UN1244	I	6, 1, 3, 8	1, B7, B9, B14, B30, B77, N34, T22, TP2, TP13, TP38, TP44	None	226	244	Forbidden	Forbidden	D	21, 40, 49, 52 and 100	
4-Methylmorpholine	3	UN2535	II	3, 8	B6, IB2, T7, TP1	150	202	243	1 L	5 L	B	40	
or methylmorpholine													
Methylpentadienes	3	UN2461	II	3	IB2, T4, TP1	150	202	242	5 L	60 L	E		
2-Methylpentan-2-ol	3	UN2560	III	3	B1, IB3, T2, TP1	150	203	242	60 L	220 L	A		
Methylperianes, see Hexanes	8	UN2437	II	8	T10, TP2, TP7, TP13	None	206	242	Forbidden	30 L	C	40	
Methylphenyldichlorosilane	3	UN2399	II	3, 8	IB2, T7, TP1	150	202	243	1 L	5 L	B	52	
1-Methylpiperidine													

Pipeline and Haz. Matls. Safety Admin., DOT

§ 172.101

	Methyltetrahydrofuran	3	UN2536	II	3	IB2, T4, TP1	150	202	242	5 L	60 L	B	40
	Methyltrichlorosilane	3	UN1250	II	3, 8	A7, B6, B77, N34, T10, TP2, TP7, TP13	None	206	243	Forbidden	5 L	B	
	alpha-Methylwateraldehyde	3	UN2367	II	3	B1, IB2, T4, TP1	150	202	242	5 L	60 L	B	
	Mine rescue equipment containing carbon dioxide, see Carbon dioxide												
	Mines with bursting charge	1.1F	UN0136	II	1.1F			62	None	Forbidden	Forbidden	05	25
	Mines with bursting charge	1.1D	UN0137	II	1.1D			62	62	Forbidden	Forbidden	04	25
	Mines with bursting charge	1.2D	UN0138	II	1.2D			62	62	Forbidden	Forbidden	04	25
	Mixed acid, see Nitrating acid, mixtures etc	1.2F	UN0294	II	1.2F			62	None	Forbidden	Forbidden	05	25
	Mobility aids, see Battery powered equipment or Battery powered vehicle												
D	Model rocket motor	1.4C	NA0276	II	1.4C			62	None	Forbidden	75 kg	02	25
D	Model rocket motor	1.4S	NA0323	II	1.4S	51	None	62	None	25 kg	100 kg	01	25
	Molybdenum pentachloride	8	UN2508	III	8	IB8, IP3, T1, TP33	154	213	240	25 kg	100 kg	C	40
	Monochloroacetone (unstabilized)	Forbidden											
	Monochloroethylene, see Vinyl chloride, stabilized												
	Monothanolamine, see Ethanolamine, solutions												
	Monothylamine, see Ethylamine												
	Morpholine	8	UN2054	I	8, 3	A6, T10, TP2	None	201	243	0.5 L	2.5 L	A	
	Morpholine, aqueous mixture, see Corrosive liquids, n.o.s.												
	Motor fuel anti-knock compounds see Motor fuel anti-knock mixtures												
+	Motor fuel anti-knock mixture, flammable	6.1	UN3483	I	6.1, 3	14, T14, TP2, TP13	None	201	244	Forbidden	Forbidden	D	25, 40
+	Motor fuel anti-knock mixtures	6.1	UN1649	I	6.1	14, B9, B90, T14, TP2, TP13	None	201	244	Forbidden	30 L	D	25, 40
	Motor spirit, see Gasoline												
	Muratic acid, see Hydrochloric acid												
	Musk xylene, see 5-tert-Butyl-2,4,6-trinitro-m-xylene												
	Naphtha see Petroleum distillates n.o.s.												
	Naphthalene, crude or Naphthalene, refined	4.1	UN1334	III	4.1	A1, B120, IB8, IP3, T1, TP33	151	213	240	25 kg	100 kg	A	
	Naphthalene diozonide	Forbidden											
	beta-Naphthylamine, solid	6.1	UN1650	II	6.1	IB8, IP2, IP4, T3, TP33	153	212	242	25 kg	100 kg	A	
	beta-Naphthylamine solution	6.1	UN3411	III	6.1	IB2, T7, TP2	153	202	243	5 L	60 L	A	
		6.1		III	6.1	IB2, T7, TP2	153	203	241	60 L	220 L	A	
		6.1	UN2077	III	6.1	IB8, IP3, T1, TP33	153	213	240	100 kg	200 kg	A	
	alpha-Naphthylamine	4.1	UN2304	III	4.1	IB1, T1, TP3	151	213	241	Forbidden	Forbidden	C	
	Naphthalene, molten	Forbidden											
	Naphthylamineperchlorate												

§ 172.101 HAZARDOUS MATERIALS TABLE—Continued

(1) Sym-bols	(2) Hazardous materials descriptions and proper shipping names	(3) Hazard class or Division	(4) Identi-fication Numbers	(5) PG	(6) Label Codes	(7) Special provisions (§ 172.102)	(8) Packaging (§ 173.***)			(9) Quantity limitations (see §§ 173.27 and 175.75)		(10) Vessel stowage		
							Excep-tions (8A)	Non-bulk (8B)	Bulk (8C)	Passenger aircraft/rail (9A)	Cargo air-craft only (9B)	Loca-tion (10A)	Other (10B)	
G	Naphthylthiourea	6.1	UN1651	II	6.1	IB8, IP2, IP4, T3, TP33	153	212	242	25 kg	100 kg	A		
	Naphthylurea	6.1	UN1652	II	6.1	IB8, IP2, IP4, T3, TP33	153	212	242	25 kg	100 kg	A		
	Natural gases (with high methane content), see Methane, etc. (UN 1971, UN 1972)													
	Neohexane, see Hexanes													
	Neon, compressed	2.2	UN1065	2.2	306, 307	302	None	None	75 kg	150 kg	A	
	Neon, refrigerated liquid (cryogenic liquid)	2.2	UN1913		2.2	T75, TP5	320	316	None	None	50 kg	500 kg	D	
	New explosive or explosive device, see §§ 173.51 and 173.56													
	Nickel carbonyl	6.1	UN1259	I	6.1, 3	1	None	198	None	None	Forbidden	Forbidden	D	40, 78
	Nickel cyanide	6.1	UN1653	II	6.1	IB8, IP2, IP4, N74, N75, T3, TP33	153	212	242	25 kg	100 kg	A		52
	Nickel nitrate	5.1	UN2725	III	5.1	A1, IB8, IP3, T1, TP33	152	213	240	25 kg	100 kg	A		
Nickel nitrite	5.1	UN2726	III	5.1	A1, IB8, IP3, T1, TP33	152	213	240	25 kg	100 kg	A		56, 58	
Nickel picrate	Forbidden													
Nicotine	6.1	UN1654	II	6.1	IB2	153	202	243	243	5 L	60 L	A		
Nicotine compounds, liquid, n.o.s. or Nicotine preparations, liquid, n.o.s.	6.1	UN3144	I	6.1	A4	None	201	243	243	1 L	30 L	B	40	
G	Nicotine compounds, solid, n.o.s. or Nicotine preparations, solid, n.o.s.	6.1	UN1655	II	6.1	IB2, T11, TP2, TP27	153	202	243	5 L	60 L	B	40	
				III	6.1	IB3, T7, TP1, TP28	153	203	241	60 L	220 L	B	40	
				I	6.1	IB7, IP1, T6, TP33	None	211	242	5 kg	50 kg	B		
				II	6.1	IB8, IP2, IP4, T3, TP33	153	212	242	25 kg	100 kg	A		
				III	6.1	IB8, IP3, T1, TP33	153	213	240	100 kg	200 kg	A		
				I	6.1	IB7, IP1, T6, TP33	None	211	242	5 kg	50 kg	B		
				II	6.1	IB8, IP2, IP4, T3, TP33	153	212	242	25 kg	100 kg	A		
				III	6.1	IB8, IP3, T1, TP33	153	213	240	100 kg	200 kg	A		
				II	6.1	IB2, IP3, T1, TP33	153	212	242	25 kg	100 kg	A		
				II	6.1	IB2, T7, TP2	153	202	243	243	5 L	60 L	A	
Nicotine hydrochloride liquid or solution	6.1	UN1656	II	6.1	IB3	153	203	241	241	60 L	220 L	A		
Nicotine hydrochloride, solid	6.1	UN3444	II	6.1	IB8, IP2, IP4, T3, TP33	153	212	242	25 kg	100 kg	A			
Nicotine salicylate	6.1	UN1657	II	6.1	IB8, IP2, IP4, T3, TP33	153	212	242	25 kg	100 kg	A			
Nicotine sulfate solution	6.1	UN1658	II	6.1	IB2, T7, TP2	153	202	243	243	5 L	60 L	A		

Nicotine sulphate, solid	6.1	UN3445	III	6.1	IB3, T7, TP2	153	203	241	60 L	220 L	A	56, 58, 133
	6.1	UN1659	II	6.1	IB8, IP2, IP4, T3, TP33	153	212	242	25 kg	100 kg	A	56, 58, 133
Nicotine tartrate Nitrated paper (unstable)	6.1	UN1659	II	6.1	IB6, IP2, IP4, T3, TP33	153	212	242	25 kg	100 kg	A	56, 58, 133
	5.1	UN3218	II	5.1	58, IB2, T4, TP1	152	202	242	1 L	5 L	B	56, 58, 133
Nitrates, inorganic, aqueous solution, n.o.s.	5.1	UN1477	III	5.1	58, IB2, T4, TP1	152	203	241	2.5 L	30 L	B	56, 58, 133
	5.1	UN1826	II	5.1	IB8, IP2, IP4, T3, TP33	152	212	240	5 kg	25 kg	A	56, 58, 133
Nitrates, inorganic, n.o.s.	5.1	UN1826	III	5.1	IB8, IP3, T1, TP33	152	213	240	25 kg	100 kg	A	56, 58, 133
	8	UN1826	I	8, 5.1	A7, T10, TP2, TP13	None	158	243	Forbidden	2.5 L	D	40, 66
Nitrites of diazonium compounds	8	UN1826	II	8	A7, B2, IB2, T8, TP2	None	158	242	Forbidden	30 L	D	40
	8	UN1796	I	8, 5.1	A7, T10, TP2, TP13	None	158	243	Forbidden	2.5 L	D	40, 66
Nitration acid mixtures with more than 50 percent nitric acid	8	UN1796	II	8	A7, B2, IB2, T8, TP2, TP13	None	158	242	Forbidden	30 L	D	40
	8	UN2031	II	8, 5.1	A6, B2, B47, B53, IB2, IP15, T8, TP2	None	158	242	Forbidden	30 L	D	66, 74, 89, 90
Nitric acid other than red fuming, with at least 65 percent, but not more than 70 percent nitric acid	8	UN2031	II	8	A6, B2, B47, B53, IB2, IP15, T8, TP2	None	158	242	Forbidden	30 L	D	44, 66, 74, 89, 90
	8	UN2031	II	8	A6, B2, B47, B53, IB2, T8, TP2	None	158	242	1 L	30 L	D	44, 66, 74, 89, 90
Nitric acid other than red fuming, with more than 20 percent and less than 65 percent nitric acid	8	UN2032	I	8, 5.1, 6.1	2, B9, B32, T20, TP2, TP13, TP38, TP45	None	227	244	Forbidden	Forbidden	D	40, 66, 74, 89, 90
	8	UN2031	I	8, 5.1	A3, B47, B53, T10, TP2, TP12, TP13	None	158	243	Forbidden	2.5 L	D	44, 66, 89, 90, 110, 111
Nitric acid, red fuming	2.3	UN1660	III	2.3, 5.1, 8	1, B77	None	337	None	Forbidden	Forbidden	D	40, 89, 90
	2.3	UN1975	III	2.3, 5.1, 8	1, B77	None	337	None	Forbidden	Forbidden	D	40, 89, 90
Nitric oxide, compressed	2.3	UN1660	III	2.3, 5.1, 8	1, B77	None	337	None	Forbidden	Forbidden	D	40, 89, 90
	2.3	UN1975	III	2.3, 5.1, 8	1, B77	None	337	None	Forbidden	Forbidden	D	40, 89, 90
Nitric oxide and dinitrogen tetroxide mixtures or Nitric oxide and nitrogen dioxide mixtures	3	UN3273	I	3, 6.1	T14, TP2, TP13, TP27	None	201	243	Forbidden	30 L	E	40, 52
	3	UN3273	II	3, 6.1	IB2, T11, TP2, TP13, TP27	150	202	243	1 L	60 L	B	40, 52
Nitrites, flammable, toxic, n.o.s.	5.1	UN3219	II	5.1	IB1, T4, TP1	152	202	242	1 L	5 L	B	46, 56, 58, 133
	5.1	UN3219	III	5.1	IB2, T4, TP1	152	203	241	2.5 L	30 L	B	46, 56, 58, 133

+

G

G

§ 172.101 HAZARDOUS MATERIALS TABLE—Continued

(1) Sym-bols	(2) Hazardous materials descriptions and proper shipping names	(3) Hazard class or Division	(4) Identi-fication Numbers	(5) PG	(6) Label Codes	(7) Special provisions (§ 172.102)	(8) Packaging (§ 173.***)			(9) Quantity limitations (see §§ 173.27 and 175.75)		(10) Vessel stowage	
							Excep-tions (8A)	Non-bulk (8B)	Bulk (8C)	Passenger aircraft/rail (9A)	Cargo air-craft only (9B)	Loca-tion (10A)	Other (10B)
G	Nitrites, inorganic, n.o.s.	5.1	UN2627	II	5.1	33, IB8, IP2, IP4, T3, TP33	152	212	None	5 kg	25 kg	A	46, 56, 58, 13
G	Nitrites, liquid, toxic, n.o.s.	6.1	UN3276	I	6.1	5, T14, TP2, TP13, TP27	None	201	243	1 L	30 L	B	52
G	Nitrites, solid, toxic, n.o.s.	6.1	UN3439	III	6.1	IB2, T11, TP2, TP27	153	202	243	5 L	60 L	B	52
				III	6.1	IB3, T7, TP1, TP28	153	203	241	60 L	220 L	A	52
				I	6.1	IB7, IP1, T6, TP33	None	211	242	5 kg	50 kg	D	52
				II	6.1	IB8, IP2, IP4, T3, TP33	153	212	242	25 kg	100 kg	B	52
				I	6.1, 3	IB8, IP3, T1, TP33	153	213	240	100 kg	200 kg	A	52
G	Nitrites, toxic, flammable, n.o.s.	6.1	UN3275	I	6.1, 3	5, T14, TP2, TP13, TP27	None	201	243	1 L	30 L	B	40, 52
				II	6.1, 3	IB2, T11, TP2, TP13, TP27	153	202	243	5 L	60 L	B	40, 52
				II	6.1	IB2, T7, TP2	153	202	243	5 L	60 L	A	40
	3-Nitro-4-chlorobenzotrifluoride	6.1	UN2307	II	6.1	IB2, T7, TP2	153	202	243	5 L	60 L	A	40
	6-Nitro-4-diazotoluene-3-sulfonic acid (dry)	Forbidden											
	Nitro isobutane trinitrate	Forbidden											
	N-Nitro-N-methylglycolamide nitrate	Forbidden											
	2-Nitro-2-methylpropanol nitrate	Forbidden											
	Nitro urea	1.1D	UN0147	II	1.1D	None	62	None	Forbidden	Forbidden	04	25
+	N-Nitroaniline	Forbidden											
	Nitroanilines (o-, m-, p-)	6.1	UN1661	II	6.1	IB8, IP2, IP4, T3, TP33	153	212	242	25 kg	100 kg	A	
	Nitroanisole, liquid	6.1	UN2730	III	6.1	IB3, T4, TP1	153	203	241	60 L	220 L	A	
	Nitroanisoles, solid	6.1	UN3458	III	6.1	IB8, IP3, T1, TP33	153	213	240	100 kg	200 kg	A	
+	Nitrobenzene	6.1	UN1662	II	6.1	IB2, T7, TP2	153	202	243	5 L	60 L	A	40
	m-Nitrobenzene diazonium perchlorate	Forbidden											
	Nitrobenzenesulfonic acid	8	UN2305	II	8	B2, B4, IB8, IP2, IP4, T3, TP33	154	202	242	1 L	30 L	A	
	Nitrobenzotriazol	1.1D	UN0385	II	1.1D	None	62	None	Forbidden	Forbidden	04	25
	Nitrobenzotrifluorides, liquid	6.1	UN2306	II	6.1	IB2, T7, TP2	153	202	243	5 L	60 L	A	40
	Nitrobenzotrifluorides, solid	6.1	UN3431	III	6.1	IB8, IP2, IP4, T3, TP33	153	212	242	25 kg	100 kg	A	40
	Nitrobenzenes, liquid	6.1	UN2732	III	6.1	IB3, T4, TP1	153	203	241	60 L	220 L	A	
	Nitrobenzenes, solid	6.1	UN3459	III	6.1	IB8, IP3, T1, TP33	153	213	240	100 kg	200 kg	A	
	Nitrocellulose, dry or wetted with less than 25 percent water (or alcohol), by mass	1.1D	UN0340	II	1.1D	None	62	None	Forbidden	Forbidden	04	25, 27E

Nitrocellulose, with not more than 12.6 percent nitrogen, by dry mass mixture with or without plasticizer, with or without pigment	4.1	UN2557	II	4.1	44	151	212	240	1 kg	15 kg	D	28, 36
Nitrocellulose membrane filters, with not more than 12.6% nitrogen, by dry mass	4.1	UN3270	II	4.1	43, A1	151	212	240	1 kg	15 kg	D	
Nitrocellulose, plasticized with not less than 18 percent plasticizing substance, by mass	1.3C	UN0343	II	1.3C	None	62	None	Forbidden	Forbidden	04	25
Nitrocellulose, solution, flammable with not more than 12.6 percent nitrogen, by mass, and not more than 55 percent nitrocellulose	3	UN2059	I	3	198, T11, TP1, TP8, TP27	None	201	243	1 L	30 L	E	
Nitrocellulose, unmodified or plasticized with less than 18 percent plasticizing substance, by mass	1.1D	UN0341	II	3	198, IB2, T4, TP1, TP8	150	202	242	5 L	60 L	B	
Nitrocellulose, wetted with not less than 25 percent alcohol, by mass	1.3C	UN0342	II	1.3C	None	62	None	Forbidden	Forbidden	04	25
Nitrocellulose with alcohol with not less than 25 percent alcohol by mass, and with not more than 12.6 percent nitrogen, by dry mass	4.1	UN2556	II	4.1	151	212	None	1 kg	15 kg	D	28, 36
Nitrocellulose with water with not less than 25 percent water by mass	4.1	UN2555	II	4.1	151	212	None	15 kg	50 kg	E	28, 36
Nitrochlorobenzene, <i>see</i> Chloronitrobenzenes <i>etc</i>												
Nitrocresols, liquid	6.1	UN3434	III	6.1	IB3, T4, TP1	153	203	241	60 L	220 L	A	
Nitrocresols, solid	6.1	UN2446	III	6.1	IB8, IP3, T1, TP33	153	213	240	100 kg	200 kg	A	
Nitroethane	3	UN2842	III	3	B1, IB3, T2, TP1	150	203	242	60 L	220 L	A	
Nitroethyl nitrate	Forbidden											
Nitroethylene polymer	Forbidden											
Nitrogen, compressed	2.2	UN1066		2.2		306, 307	302	314, 315	75 kg	150 kg	A	
Nitrogen dioxide, <i>see</i> Dinitrogen tetroxide												
Nitrogen fertilizer solution, <i>see</i> Fertilizer ammoniating solution <i>etc</i>												
Nitrogen peroxide, <i>see</i> Dinitrogen tetroxide												
Nitrogen, refrigerated liquid cryogenic liquid	2.2	UN1977		2.2	345, 346, T75, TP5	320	316	318	50 kg	500 kg	D	
Nitrogen tetroxide and nitric oxide mixtures, <i>see</i> Nitric oxide and nitrogen tetroxide mixtures												

UN number	Proper shipping name	1.1D	II	1.1D	None	62	None	Forbiddn	Forbiddn	Forbiddn	04	25
UN0282	Nitroguanidine or Picrite, dry or wetted with less than 20 percent water, by mass	1.1D	II	1.1D	None	62	None	Forbiddn	Forbiddn	04	25	
UN1336	Nitroguanidine, wetted or Picrite, wetted with not less than 20 percent water, by mass	4.1	I	4.1	23, A8, A19, A20, N41	None	211	None	1 kg	15 kg	E	28, 36	
UN1798	1-Nitrohydantoin	Forbiddn	I	8	A3, B10, N41, T10, TP2, TP13	None	201	243	Forbiddn	2.5 L	D	40, 66, 74, 89, 90	
UN1261	Nitrohydrochloric acid	Forbiddn	II	3		150	202	None	Forbiddn	60 L	A		
UN2538	Nitromethane	4.1	III	4.1	A1, IB8, IP3, T1, TP33	151	213	240	25 kg	100 kg	A		
UN1663	Nitromuriatic acid, see Nitrohydrochloric acid	6.1	III	6.1	IB8, IP3, T1, TP33	153	213	240	100 kg	200 kg	A		
UN3376	Nitrosophthalene	4.1	I	4.1	162, A8, A19, A20, N41	None	211	None	Forbiddn	15 kg	E	28, 36	
UN2608	m-Nitrophenylidrazone, with not less than 30 percent water, by mass	3	III	3	B1, IB3, T2, TP1	150	203	242	60 L	220 L	A		
UN1369	Nitropropanes	4.2	II	4.2	A19, A20, IB6, IP2, N34, T3, TP33	None	212	241	15 kg	50 kg	D	34	
UN0146	p-Nitrosodimethylaniline	1.1D	II	1.1D	None	62	None	Forbiddn	Forbiddn	04	25	
UN1337	Nitrostarch, dry or wetted with less than 20 percent water, by mass	4.1	I	4.1	23, A8, A19, A20, N41	None	211	None	1 kg	15 kg	D	28, 36	
UN1069	Nitrostarch, wetted with not less than 20 percent water, by mass	Forbiddn		2.3, 8	3, B14	None	304	314, 315	Forbiddn	Forbiddn	D	40	
UN2308	Nitrosugars (dry)	8	II	8	A3, A6, A7, B2, IB2, N34, T8, TP2	154	202	242	1 L	30 L	D	40, 66, 74, 89, 90	
UN3456	Nitrosyl chloride	8	II	8	IB8, IP2, IP4, T3, TP33	154	212	240	15 kg	50 kg	D	40, 66, 74, 89, 90	
UN1664	Nitrosylsulfuric acid, liquid	6.1	II	6.1	IB2, T7, TP2	153	202	243	5 L	60 L	A		
UN3446	Nitrotoluenes, liquid	6.1	II	6.1	IB8, IP2, IP4, T3, TP33	153	212	242	25 kg	100 kg	A		
UN2660	Nitrotoluenes, solid	6.1	III	6.1	IB8, IP3, T1, TP33	153	213	240	100 kg	200 kg	A		
UN0490	Nitrotoluidines (mono)	1.1D	II	1.1D	None	62	None	Forbiddn	Forbiddn	04	25	
UN1070	Nitrotriazolone or NTO	2.2	II	2.2, 5.1	A14	306	304	314, 315	75 kg	150 kg	A	40	
UN2201	Nitrous oxide	2.2	II	2.2, 5.1	B6, T75, TP5, TP22	None	304	314, 315	Forbiddn	Forbiddn	D	40	
UN1665	Nitroxylene, refrigerated liquid	6.1	II	6.1	IB2, T7, TP2	153	202	243	5 L	60 L	A		
UN3447	Nitroxylene, liquid	6.1	II	6.1	IB8, IP2, IP4, T3, TP33	153	212	242	25 kg	100 kg	A		
UN1920	Nitroxylene, solid	3	III	3	B1, IB3, T2, TP1	150	203	242	60 L	220 L	A		
	Nitroxylol, see Nitroxylene												
	Nonanes												

+

§ 172.101 HAZARDOUS MATERIALS TABLE—Continued

(1) Sym-bols	(2) Hazardous materials descriptions and proper shipping names	(3) Hazard class or Division	(4) Identi-fication Numbers	(5) PG	(6) Label Codes	(7) Special provisions (§ 172.102)	(8) Packaging (§ 173.***)			(9) Quantity limitations (see §§ 173.27 and 175.75)		(10) Vessel stowage	
							Excep-tions (8A)	Non-bulk (8B)	Bulk (8C)	Passenger aircraft/rail (9A)	Cargo air-craft only (9B)	Loca-tion (10A)	Other (10B)
	<i>Non-flammable gas, n.o.s., see Compressed gas, etc. or Liquefied gas, etc</i> <i>Nonliquefied gases, see Compressed gases, etc</i> <i>Nonliquefied hydrocarbon gas, see Hydrocarbon gas mixture, compressed, n.o.s.</i> Nonyltrichlorosilane	8	UN1799	II	8	A7, B2, B6, N34, T10, TP2, TP7, TP13	None	206	242	Forbidden	30 L	C	40
	<i>Nordhausen acid, see Sulfuric acid, fuming etc</i> <i>2,5-Norbornadiene, stabilized, see Bicyclo [2.2.1] hepta-2,5-diene, stabilized</i> Octadecyltrichlorosilane	8	UN1800	II	8	A7, B2, B6, N34, T10, TP2, TP7, TP13	None	206	242	Forbidden	30 L	C	40
	Octadiene	3	UN2309	II	3	B1, IB2, T4, TP1	150	202	242	5 L	60 L	B	
	<i>1,7-Octadine-3,5-diyne-1,8-dimethoxy-9-octadecynoic acid</i> Octafluorobut-2-ene or Refrigerant gas R 1318	2.2	UN2422		2.2	T50	None	304	314, 315	75 kg	150 kg	A	
	Octafluorocyclobutane, or Refrigerant gas FC 318	2.2	UN1976		2.2	T50	None	304	314, 315	75 kg	150 kg	A	
	Octafluoropropaneor Refrigerant gas R 218	2.2	UN2424		2.2		None	304	314, 315	75 kg	150 kg	A	
	Octanes	3	UN1262	II	3	IB2, T4, TP1	150	202	242	5 L	60 L	B	
	Octogen, etc. see Cyclooctamethylene tetranitramine, etc.												
	Octolite or Octol, dry or wetted with less than 15 percent water, by mass	1.1D	UN0266	II	1.1D		None	62	None	Forbidden	Forbidden	04	25
	Octonal	1.1D	UN0496	1.1D		None	62	None	Forbidden	Forbidden	04	25
	Octyl aldehydes	3	UN1191	III	3	B1, IB3, T2, TP1	150	203	242	60 L	220 L	A	
	Octyltrichlorosilane	8	UN1801	II	8	A7, B2, B6, N34, T10, TP2, TP7, TP13	None	206	242	Forbidden	30 L	C	40

Oil gas, compressed	2.3	UN1071	2.3, 2.1	6	304	314, 315	Forbidden	25 kg	D	40
<i>Oleum</i> , see Sulfuric acid, fuming	Forbidden									
<i>Organic peroxide type A, liquid or solid</i>										
Organic peroxide type B, liquid	5.2	UN3101	5.2, 1	53	225	None	Forbidden	Forbidden	D	12, 40, 52, 53
Organic peroxide type B, liquid, temperature controlled	5.2	UN3111	5.2, 1	53	225	None	Forbidden	Forbidden	D	2, 40, 52, 53
Organic peroxide type B, solid	5.2	UN3102	5.2, 1	53	225	None	Forbidden	Forbidden	D	12, 40, 52, 53
Organic peroxide type B, solid, temperature controlled	5.2	UN3112	5.2, 1	53	225	None	Forbidden	Forbidden	D	2, 40, 52, 53
Organic peroxide type C, liquid	5.2	UN3103	5.2	152	225	None	5 L	10 L	D	12, 40, 52, 53
Organic peroxide type C, liquid, temperature controlled	5.2	UN3113	5.2	None	225	None	Forbidden	Forbidden	D	2, 40, 52, 53
Organic peroxide type C, solid	5.2	UN3104	5.2	152	225	None	5 kg	10 kg	D	12, 40, 52, 53
Organic peroxide type C, solid, temperature controlled	5.2	UN3114	5.2	None	225	None	Forbidden	Forbidden	D	2, 40, 52, 53
Organic peroxide type D, liquid	5.2	UN3105	5.2	152	225	None	5 L	10 L	D	12, 40, 52, 53
Organic peroxide type D, liquid, temperature controlled	5.2	UN3115	5.2	None	225	None	Forbidden	Forbidden	D	2, 40, 52, 53
Organic peroxide type D, solid	5.2	UN3106	5.2	152	225	None	5 kg	10 kg	D	12, 40, 52, 53
Organic peroxide type D, solid, temperature controlled	5.2	UN3116	5.2	None	225	None	Forbidden	Forbidden	D	2, 40, 52, 53
Organic peroxide type E, liquid	5.2	UN3107	5.2	152	225	None	10 L	25 L	D	12, 40, 52, 53
Organic peroxide type E, liquid, temperature controlled	5.2	UN3117	5.2	None	225	None	Forbidden	Forbidden	D	2, 40, 52, 53
Organic peroxide type E, solid	5.2	UN3108	5.2	152	225	None	10 kg	25 kg	D	12, 40, 52, 53
Organic peroxide type E, solid, temperature controlled	5.2	UN3118	5.2	None	225	None	Forbidden	Forbidden	D	2, 40, 52, 53
Organic peroxide type F, liquid	5.2	UN3109	5.2	IP5	225	225	10 L	25 L	D	12, 40, 52, 53
Organic peroxide type F, liquid, temperature controlled	5.2	UN3119	5.2	IP5	225	225	Forbidden	Forbidden	D	2, 40, 52, 53
Organic peroxide type F, solid	5.2	UN3110	5.2	TP33	225	225	10 kg	25 kg	D	12, 40, 52, 53
Organic peroxide type F, solid, temperature controlled	5.2	UN3120	5.2	TP33	225	225	Forbidden	Forbidden	D	2, 52, 53

§ 172.101 HAZARDOUS MATERIALS TABLE—Continued

(1) Sym-bols	(2) Hazardous materials descriptions and proper shipping names	(3) Hazard class or Division	(4) Identi-fication Numbers	(5) PG	(6) Label Codes	(7) Special provisions (§ 172.102)	(8) Packaging (§ 173.***)			(9) Quantity limitations (see §§ 173.27 and 175.75)		(10) Vessel stowage		
							Excep-tions (8A)	Non-bulk (8B)	Bulk (8C)	Passenger aircraft/rail (9A)	Cargo air-craft only (9B)	Loca-tion (10A)	Other (10B)	
D	Organic phosphate, mixed with compressed gas or Organic phosphate compound, mixed with compressed gas or Organic phosphorus compound, mixed with compressed gas Organic pigments, self-heating	2.3	NA1955		2.3	3	None	334	None	Forbidden	Forbidden	D	40	
G	Organoarsenic compound, liquid, n.o.s.	6.1	UN3313	II	4.2	IB8, IP2, IP4, T3, TP33 IB8, IP3, T1, TP33 5, T14, TP2, TP13, TP27	None	212	241	15 kg	50 kg	C		
			UN3280	III	4.2		None	213	241	25 kg	100 kg	30 L	60 L	C
G	Organoarsenic compound, solid, n.o.s.	6.1	UN3465	III	6.1	IB2, T11, TP2, TP27 IB3, T7, TP1, TP28 IB7, IP1, T6, TP33	None	201	242	1 L	5 kg	60 L	B	
				II	6.1		153	202	5 L	60 L	220 L	60 L	A	
G	Organochlorine pesticides liquid, flammable, toxic, flash point less than 23 degrees C	3	UN2762	I	3, 6.1	IB8, IP2, IP4, T3, TP33 IB8, IP3, T1, TP33 T14, TP2, TP13, TP27	None	212	242	25 kg	100 kg	B		
				III	6.1		153	213	100 kg	200 kg	30 L	60 L	A	
G	Organochlorine pesticides, liquid, toxic	6.1	UN2996	I	3, 6.1	IB2, T11, TP2, TP13, TP27 T14, TP2, TP13, TP27	None	201	243	Forbidden	Forbidden	B	40	
				II	6.1		150	202	1 L	60 L	30 L	60 L	B	40
G	Organochlorine pesticides, liquid, toxic, flammable, flash point not less than 23 degrees C	6.1	UN2995	I	6.1, 3	IB2, T11, TP2, TP13, TP27 IB3, T7, TP2, TP28 T14, TP2, TP13, TP27	None	201	243	1 L	60 L	B	40	
				III	6.1		153	203	60 L	220 L	220 L	A	40	
G	Organochlorine pesticides, solid, toxic	6.1	UN2761	I	6.1	IB2, T11, TP2, TP13, TP27 B1, IB3, T7, TP2, TP28 IB7, IP1, T6, TP33	None	201	243	1 L	5 kg	B	40	
				II	6.1, 3		153	202	5 L	60 L	60 L	B	40	
G	Organometallic compound, liquid, toxic, n.o.s.	6.1	UN3282	I	6.1	IB8, IP2, IP4, T3, TP33 IB8, IP3, T1, TP33 T14, TP2, TP13, TP27	None	201	242	25 kg	100 kg	A	40	
				III	6.1		153	213	100 kg	200 kg	30 L	60 L	A	40

G	Organometallic compound, solid, toxic, n.o.s	6.1	UN3467	II	6.1	IB2, T11, TP2, TP27 IB3, T7, TP1, TP28 IB7, IP1, T6, TP33	153 153 None	202 203 211	242 241 242	5 L 60 L 5 kg	B A B	
G	Organometallic substance, liquid, pyrophoric	4.2	UN3392	II	6.1	IB8, IP2, IP4, T3, TP33 IB8, IP3, T1, TP33	153 153	212 213	242 240	25 kg 100 kg	B A	78
G	Organometallic substance, liquid, pyrophoric, water-reactive	4.2	UN3394	I	4.2, 4.3	B11, T21, TP2, TP7, TP36 B11, T21, TP2, TP7, TP36	None None	181	244	Forbiddn	D	78
G	Organometallic substance, liquid, water-reactive	4.3	UN3398	I	4.3	T13, TP2, TP7, TP36	None	201	244	Forbiddn	E	40, 52
G	Organometallic substance, liquid, water-reactive, flammable	4.3	UN3399	III	4.3	IB1, T7, TP2, TP7, TP36 IB2, T7, TP2, TP7, TP36 T13, TP2, TP7, TP36	None None None	202 203 201	243 242 244	1 L 5 L 60 L 1 L	E E E D	40, 52 40, 52 40, 52 40, 52
G	Organometallic substance, solid, pyrophoric	4.2	UN3391	I	4.2	IB1, IP2, T7, TP2, TP7, TP36	None	202	243	1 L	D	40, 52
G	Organometallic substance, solid, pyrophoric, water-reactive	4.2	UN3393	III	4.3, 3	IB2, IP4, T7, TP2, TP7, TP36	None	203	242	5 L	E	40, 52
G	Organometallic substance, solid, self-heating	4.2	UN3400	I	4.2	T21, TP7, TP33, TP36	None	187	244	Forbiddn	D	
G	Organometallic substance, solid, water-reactive	4.3	UN3395	III	4.2, 4.3	B11, T21, TP7, TP33, TP36 IB6, T3, TP33, TP36 N40, T9, TP7, TP33, TP36	None None None	187 212 213 211	244 242 242	Forbiddn Forbiddn 15 kg 25 kg Forbiddn	D D C C E	52 40, 52
G	Organometallic substance, solid, water-reactive, flammable	4.3	UN3396	I	4.3, 4.1	IB4, T3, TP33, TP36 IB6, T1, TP33, TP36 N40, T9, TP7, TP33, TP36	151 151 None	212 213 211	242 241 242	15 kg 50 kg 100 kg 15 kg	E E E E	40, 52 40, 52 40, 52 40, 52
G	Organometallic substance, solid, water-reactive, self-heating	4.3	UN3397	III	4.3, 4.1	IB4, T3, TP33, TP36 IB6, T1, TP33, TP36 N40, T9, TP7, TP33, TP36	151 151 None	212 213 211	242 241 242	15 kg 25 kg Forbiddn	E E E	40, 52 40, 52 40, 52
	Organophosphorus compound, toxic, flammable, n.o.s.	6.1	UN3279	I	6.1, 3	5, T14, TP2, TP13, TP27 IB2, T11, TP2, TP13, TP27	None 153	201 202	243 243	1 L 5 L	B B	40 40
G	Organophosphorus compound, liquid, toxic, n.o.s	6.1	UN3278	I	6.1	5, T14, TP2, TP13, TP27 IB2, T11, TP2, TP27	None 153	201 202	243 243	1 L 5 L	B B	40 40

§ 172.101 HAZARDOUS MATERIALS TABLE—Continued

(1) Sym-bols	(2) Hazardous materials descriptions and proper shipping names	(3) Hazard class or Division	(4) Identi-fication Numbers	(5) PG	(6) Label Codes	(7) Special provisions (§ 172.102)	(8) Packaging (§ 173.***)			(9) Quantity limitations (see §§ 173.27 and 175.75)		(10) Vessel stowage	
							Excep-tions (8A)	Non-bulk (8B)	Bulk (8C)	Passenger aircraft/rail (9A)	Cargo air-craft only (9B)	Loca-tion (10A)	Other (10B)
G	Organophosphorus compound, solid, toxic, n.o.s.	6.1	UN3464	III	6.1	IB3, T7, TP1, TP28 IB7, IP1, T6, TP33	153	203	241	60 L	220 L	A	A
								211	242	5 kg	50 kg		
								None	242	25 kg	100 kg	B	B
	Organophosphorus pesticides, liq-uid, flammable, toxic, flash point less than 23 degrees C	3	UN2784	I	3, 6.1	IB8, IP2, IP4, T3, TP33 IB8, IP3, T1, TP33 T14, TP2, TP13, TP27	153	212	240	25 kg	100 kg		
								213	240	100 kg	200 kg	B	B
								None	201	Forbidden	30 L		
	Organophosphorus pesticides, liq-uid, toxic	6.1	UN3018	I	6.1	IB2, T11, TP2, TP13, TP27 N76, T14, TP2, TP13, TP27	None	202	243	1 L	60 L	B	B
								201	243	1 L	30 L		
								153	243	5 L	60 L	B	B
	Organophosphorus pesticides, liq-uid, toxic, flammable, flash point not less than 23 degrees C	6.1	UN3017	I	6.1, 3	IB3, N76, T7, TP2, TP28 N76, T14, TP2, TP13, TP27	153	203	241	60 L	220 L		
								201	243	1 L	30 L	B	B
								None	202	243	5 L		
Organophosphorus pesticides, solid, toxic	6.1	UN2783	I	6.1	IB2, N76, T11, TP2, TP13, TP27 B1, IB3, N76, T7, TP2, TP28 IB7, IP1, N77, T6, TP33	153	202	243	5 L	60 L	B	B	
							203	242	60 L	220 L			A
							None	211	242	5 kg	50 kg	A	
Organotin compounds, liquid, n.o.s.	6.1	UN2788	I	6.1	IB8, IP2, IP4, N77, T3, TP33 IB8, IP3, N77, T1, TP33 A3, N33, N34, T14, TP2, TP13, TP27	153	212	242	25 kg	100 kg	A		A
							213	240	100 kg	200 kg		A	
							None	201	243	1 L	30 L		B
Organotin compounds, solid, n.o.s.	6.1	UN3146	III	6.1	A3, IB2, N33, N34, T11, TP2, TP13, TP27 IB3, T7, TP2, TP28 A5, IB7, IP1, T6, TP33	153	202	243	5 L	60 L	A	A	
							203	241	60 L	220 L			A
							None	211	242	5 kg	50 kg	B	
Organotin pesticides, liquid, flammable, toxic, flash point less than 23 degrees C	3	UN2787	I	3, 6.1	IB8, IP2, IP4, T3, TP33 IB8, IP3, T1, TP33 T14, TP2, TP13, TP27	153	212	242	25 kg	100 kg	A		A
							213	240	100 kg	200 kg		A	
							None	201	243	Forbidden	30 L		B

Organotin pesticides, liquid, toxic, flammable, flash point not less than 23 degrees C	6.1	UN3020	I	6.1	IB2, T11, TP2, TP13, TP27	150	202	243	1 L	60 L	B	40																																																																								
													6.1	T14, TP2, TP13, TP27	None	201	243	1 L	30 L	B	40																																																															
																						6.1	IB2, T11, TP2, TP13, TP27	153	202	243	5 L	60 L	B	40																																																						
																															6.1	IB3, T7, TP2, TP28	153	203	241	60 L	220 L	A	40																																													
																																								6.1, 3	T14, TP2, TP13, TP27	None	201	243	1 L	30 L	B	40																																				
																																																	6.1, 3	IB2, T11, TP2, TP13, TP27	153	202	243	5 L	60 L	B	40																											
																																																										6.1, 3	B1, IB3, T7, TP2, TP28	153	203	242	60 L	220 L	A	40																		
																																																																			6.1	IB7, IP1, T6, TP33	None	211	242	5 kg	50 kg	A	40									
																																																																												6.1	IB8, IP2, IP4, T3, TP33	153	212	242	25 kg	100 kg	A	40
6.1	A8, IB7, IP1, N33, N34, T6, TP33	None	211	242	5 kg	50 kg	B	40																																																																												
									9	A189, IB3, T2, TP1	155	203	241	No limit	No limit	A																																																																				
																		9	B54, IB8, IP2, T1, TP33	155	213	240	No limit	No limit	A																																																											
																											5.1	62, A6	None	201	244	Forbidden	2.5 L	D	13, 56, 58, 106, 138																																																	
																																				5.1, 8	62, IB1	None	202	243	1 L	5 L	B	13, 34, 56, 58, 106, 138																																								
																																													5.1, 8	62, IB2	152	203	242	2.5 L	30 L	B	13, 34, 56, 58, 106, 138																															
																																																						5.1	62, 127, A2, A6	None	201	243	Forbidden	2.5 L	D	56, 58, 106, 138																						
																																																															5.1	62, 127, A2, IB2	152	202	242	1 L	5 L	B	56, 58, 106, 138													
																																																																								5.1	62, 127, A2, IB2	152	203	241	2.5 L	30 L	B	56, 58, 106, 138				
																																																																																	5.1, 6.1	62, A6	None	201

§ 172.101 HAZARDOUS MATERIALS TABLE—Continued

(1) Sym-bols	(2) Hazardous materials descriptions and proper shipping names	(3) Hazard class or Division	(4) Identi-fication Numbers	(5) PG	(6) Label Codes	(7) Special provisions (§ 172.102)	(8) Packaging (§ 173.***)			(9) Quantity limitations (see §§ 173.27 and 175.75)		(10) Vessel stowage	
							Excep-tions (8A)	Non-bulk (8B)	Bulk (8C)	Passenger aircraft/rail (9A)	Cargo air-craft only (9B)		Loca-tion (10A)
G	Oxidizing solid, corrosive, n.o.s.	5.1	UN3085	I	5.1, 8	62	None	211	242	1 kg	15 kg	D	13, 56, 58, 106, 138
G	Oxidizing solid, corrosive, n.o.s.	5.1	UN3137	I	5.1, 8	62, IB6, IP2, T3, TP33	None	212	242	5 kg	25 kg	B	13, 34, 56, 58, 106, 138
G	Oxidizing solid, n.o.s.	5.1	UN1479	I	5.1	62, IB5, IP1	None	211	242	1 kg	15 kg	D	56, 58, 106, 138
G	Oxidizing solid, self-heating, n.o.s.	5.1	UN3100	I	5.1, 4.2	62	None	214	214	Forbidden	Forbidden	Forbidden	56, 58, 106, 138
G	Oxidizing solid, self-heating, n.o.s.	5.1	UN3100	II	5.1, 4.2	62	None	214	214	Forbidden	Forbidden	Forbidden	56, 58, 106, 138

G	Oxidizing solid, toxic, n.o.s.	5.1	UN3087	I	5.1, 6.1	62	None	211	242	1 kg	15 kg	D	56, 58, 106, 138	
				II	5.1, 6.1	62, IB6, IP2, T3, TP33	152	212	242	5 kg	25 kg	B	56, 58, 95, 106, 138	
				III	5.1, 6.1	62, IB8, IP3, T1, TP33	152	213	240	25 kg	100 kg	B	56, 58, 95, 106, 138	
					5.1, 4.3	62	None	214	214	Forbidden	Forbidden			
					2.2, 5.1	110, A14	306	302	314, 315	75 kg	150 kg	A		
					2.3, 5.1, 8	1, N86	None	304	None	Forbidden	Forbidden	D	13, 40, 89, 90	
				II	5.1		None	168	None	Forbidden	25 kg	D	56, 58, 69, 106	
				III	9, 2.2, 5.1	61, T75, TP5, TP22	None, 320	213, 316	None, 318	Forbidden, Forbidden	Forbidden, Forbidden	A, D		
				I	3	T11, TP1, TP8, TP27	150	201	243	1 L	30 L	E		
+	Paint or Paint related material			II	3	149, B52, IB2, T4, TP1, TP8, TP28	150	173	242	5 L	60 L	B		
				III	3	B1, B52, IB3, T2, TP1, TP29	150	173	242	60 L	220 L	A		
				II	8	B2, IB2, T7, TP2, TP28	154	173	242	1 L	30 L	A	40	
				III	8	B52, IB3, T4, TP1, TP29	154	173	241	5 L	60 L	A	40	
				II	8, 3	IB2, T7, TP2, TP8, TP28	154	202	243	1 L	30 L	B	40	
				I	3, 8	T11, TP2, TP27	None	201	243	0.5 L	2.5 L	E	40	
				II	3, 8	IB2, T7, TP2, TP8, TP28	150	202	243	1 L	5 L	B	40	
				III	3, 8	IB3, T4, TP1, TP29	150	203	242	5 L	60 L	A	40	
				I	3	T11, TP1, TP8, TP27	150	201	243	1 L	30 L	E		
				3	UN1263									

§ 172.101 HAZARDOUS MATERIALS TABLE—Continued

(1) Sym-bols	(2) Hazardous materials descriptions and proper shipping names	(3) Hazard class or Division	(4) Identi-fication Numbers	(5) PG	(6) Label Codes	(7) Special provisions (§ 172.102)	(8) Packaging (§ 173.***)			(9) Quantity limitations (see §§ 173.27 and 175.75)		(10) Vessel stowage	
							Excep-tions (8A)	Non-bulk (8B)	Bulk (8C)	Passenger aircraft/rail (9A)	Cargo air-craft only (9B)	Loca-tion (10A)	Other (10B)
	Paint related material corrosive, flammable (including paint thinning or reducing compound)	8	UN3470	II	3	149, B52, IB2, T4, TP1, TP8, TP28	150	173	242	5 L	60 L	B	
	Paint related material, flammable, corrosive (including paint thinning or reducing compound)	3	UN3469	III	3	B1, B52, IB3, T2, TP1, TP29	150	173	242	60 L	220 L	A	
	Paint related material, flammable, corrosive (including paint thinning or reducing compound)	8	UN3470	II	8, 3	IB2, T7, TP2, TP8, TP28	154	202	243	1 L	30 L	B	40.
	Paint related material, flammable, corrosive (including paint thinning or reducing compound)	3	UN3469	I	3, 8	T11, TP2, TP27	None	201	243	0.5 L	2.5 L	E	40
	Paper, unsaturated oil treated in-completely dried (including car-bon paper)	4.2	UN1379	III	3, 8	IB2, T7, TP2, TP8, TP28	150	202	243	1 L	5 L	B	40.
	Paper, unsaturated oil treated in-completely dried (including car-bon paper)	4.1	UN2213	III	3, 8	IB3, T4, TP1, TP29	150	203	242	5 L	60 L	A	40.
	Paraformaldehyde	4.1	UN2213	III	4.1	IB8, IP3	None	213	240	25 kg	100 kg	A	
	Paraldehyde	3	UN1264	III	3	A1, B120, IB8, IP3, T1, TP33	151	213	240	25 kg	100 kg	A	
	Paranitroaniline, solid, see Nitroanilines etc	3	UN1264	III	3	B1, IB3, T2, TP1	150	203	242	60 L	220 L	A	
D	Parathion and compressed gas mixture	2.3	NA1967	2.3	2.3		None	334	245	Forbidden	Forbidden	E	40
	Paris green, solid, see Copper acetoarsenite												
	PCB, see Polychlorinated biphenyls												
	Pentaborane	4.2	UN1380	I	4.2, 6.1		None	205	245	Forbidden	Forbidden	D	
+	Pentachloroethane	6.1	UN1669	II	6.1	IB2, T7, TP2	153	202	243	5 L	60 L	A	40
	Pentachlorophenol	6.1	UN3155	II	6.1	IB8, IP2, IP4, T3, TP33	153	212	242	25 kg	100 kg	A	
	Pentaerythrite tetranitrate (dry)	Forbidden											
	Pentaerythrite tetranitrate mixture, desensitized, solid, n.o.s. or Pen-taerythritol tetranitrate mixture, desensitized, solid, n.o.s. or PETN mixture, desensitized, solid, n.o.s., with more than 10 percent but not more than 20 per-cent PETN, by mass	4.1	UN3344	II	4.1	118, N85	None	214	None	Forbidden	Forbidden	E	

§ 172.101 HAZARDOUS MATERIALS TABLE—Continued

(1) Sym-bols	(2) Hazardous materials descriptions and proper shipping names	(3) Hazard class or Division	(4) Identi-fication Numbers	(5) PG	(6) Label Codes	(7) Special provisions (§ 172.102)	(8) Packaging (§ 173.***)			(9) Quantity limitations (see §§ 173.27 and 175.75)		(10) Vessel stowage	
							Excep-tions (8A)	Non-bulk (8B)	Bulk (8C)	Passenger aircraft/rail (9A)	Cargo air-craft only (9B)	Loca-tion (10A)	Other (10B)
G	Perchloryl fluoride	2.3	UN3083		2.3, 5.1	2, B9, B14	None	302	314, 315	Forbidden	Forbidden	D	40
	<i>Percussion caps, see Primers, cap type</i>												
	<i>Perfluoro-2-butene, see Octafluorobut-2-ene</i>												
	Perfluoro(ethyl vinyl ether)	2.1	UN3154		2.1		306	302, 304, 305	314, 315	Forbidden	150 kg	E	40
	Perfluoro(methyl vinyl ether)	2.1	UN3153		2.1	T50	306	302, 304, 305	314, 315	Forbidden	150 kg	E	40
G	Perfumery products with flammable solvents	3	UN1266	II	3	149, IB2, T4, TP1, TP8	150	202	242	15 L	60 L	B	
	Permanganates, inorganic, aqueous solution, n.o.s.	5.1	UN3214	II	5.1	B1, IB3, T2, TP1 26, 353, IB2, T4, TP1	150	202	242	60 L 1 L	220 L 5 L	A D	56, 58, 133, 138
	Permanganates, inorganic, n.o.s.	5.1	UN1482	II	5.1	26, 353, A30, IB6, IP2, T3, TP33	152	212	242	5 kg	25 kg	D	56, 58, 138
G	Permeation devices for calibrating air quality monitoring equipment See § 173.175												
	Peroxides, inorganic, n.o.s.	5.1	UN1483	III	5.1	26, 353, A30, IB8, IP3, T1, TP33	152	213	240	25 kg	100 kg	D	56, 58, 13
	<i>Peroxyacetic acid, with more than 43 percent and with more than 6 percent hydrogen peroxide</i>	Forbidden											
G	Persulfates, inorganic, aqueous solution, n.o.s.	5.1	UN3216	III	5.1	A7, A20, IB6, IP2, N34, T3, TP33	None	212	242	5 kg	25 kg	A	13, 52, 66, 75
	Persulfates, inorganic, n.o.s.	5.1	UN3215	III	5.1	A7, A20, IB8, IP3, N34, T1, TP33	152	213	240	25 kg	100 kg	A	13, 52, 66, 75
	Pesticides, liquid, flammable, toxic, flash point less than 23 degrees C	3	UN3021	I	3, 6.1	IB2, T4, TP1, TP29 IB8, IP3, T1, TP33 B5, T14, TP2, TP13, TP27	None	201	243	240	25 kg Forbidden	100 kg 30 L	A B
				II	3, 6.1	IB2, T11, TP2, TP13, TP27	150	202	243	1 L	60 L	B	

G	Pesticides, liquid, toxic, flammable, n.o.s. <i>flash point not less than 23 degrees C</i>	6.1	UN2903	I	6.1, 3	T14, TP2, TP13, TP27	None	201	243	1 L	30 L	B	40		
		6.1	UN2902	II	6.1, 3	IB2, T11, TP2, TP13, TP27	153	202	243	5 L	60 L	B	40		
				III	6.1, 3	B1, IB3, T7, TP2	153	203	242	60 L	220 L	A	40		
				II	6.1	T14, TP2, TP13, TP27	None	201	243	1 L	30 L	B	40		
				II	6.1	IB2, T11, TP2, TP13, TP27	153	202	243	5 L	60 L	B	40		
		6.1	UN2588	III	6.1	IB3, T7, TP2, TP28	153	203	241	60 L	220 L	A	40		
				I	6.1	IB7, T6, TP33	None	211	242	5 kg	50 kg	A	40		
				II	6.1	IB8, IP2, IP4, T3, TP33	153	212	242	25 kg	100 kg	A	40		
		D	Pesticides, solid, toxic, n.o.s.	3	UN1267	I	6.1	IB8, IP3, T1, TP33	153	213	100 kg	200 kg	A	40	
						II	3	144, 357, T11, TP1, TP8	150	201	1 L	30 L	E		
II	3					144, 357, IB2, T4, TP1, TP8	150	202	5 L	60 L	B				
3	UN1268			III	3	144, 357, B1, IB3, T2, TP1	150	203	242	60 L	220 L	A			
				I	3	144, T11, TP1, TP8	150	201	243	1 L	30 L	E			
				II	3	144, IB2, T7, TP1, TP8, TP28	150	202	242	5 L	60 L	B			
2.1	UN1075			III	3	144, B1, IB3, T4, TP1, TP29	150	203	242	60 L	220 L	A			
				I	2.1	T50	306	304	314, 315	Forbidden	150 kg	E	40		
				I	3	144, T11, TP1	None	201	243	1 L	30 L	E			
				II	3	144, IB2, T7, TP1, TP8, TP28	150	202	242	5 L	60 L	B			
I	Petroleum gases, liquefied or liquefied petroleum gas	3	NA1270	III	3	144, B1, IB3, T4, TP1, TP29	150	203	242	60 L	220 L	A			
				I	3	144, T11, TP1	None	201	243	1 L	30 L	E			
				II	3	144, IB2, T7, TP1, TP8, TP28	150	202	242	5 L	60 L	B			
		3	UN3494	III	3	144, B1, IB3, T4, TP1, TP29	150	203	242	60 L	220 L	A			
				I	3, 6.1	343, T14, TP2, TP13	None	201	243	Forbidden	30 L	D	40		
				II	6.1	IB8, IP2, IP4, T3, TP33	153	212	242	25 kg	100 kg	B	40		
		+	Phenol, molten	6.1	UN2645	III	6.1	IB3, T4, TP1	153	203	241	60 L	220 L	A	
				6.1	UN2311	III	6.1	B14, T7, TP3	None	202	243	Forbidden	Forbidden	B	40
				6.1	UN2312	II	6.1	IB8, IP2, IP4, N78, T3, TP33	153	212	242	25 kg	100 kg	A	
				6.1	UN1671	II	6.1	IB2, T7, TP2	153	202	243	5 L	60 L	A	
+	Phenol solutions	6.1	UN2821	III	6.1	IB3, T4, TP1	153	203	241	60 L	220 L	A			
		8	UN1803	II	8	B2, IB2, N411, T7, TP2	154	202	242	1 L	30 L	C	14		
		3	UN3346	I	3, 6.1	T14, TP2, TP13, TP27	None	201	243	Forbidden	30 L	B	40		

§ 172.101 HAZARDOUS MATERIALS TABLE—Continued

(1) Sym-bols	(2) Hazardous materials descriptions and proper shipping names	(3) Hazard class or Division	(4) Identi-fication Numbers	(5) PG	(6) Label Codes	(7) Special provisions (§ 172.102)	(8) Packaging (§ 173.***)			(9) Quantity limitations (see §§ 173.27 and 175.75)		(10) Vessel stowage	
							Excep-tions (8A)	Non-bulk (8B)	Bulk (8C)	Passenger aircraft/rail (9A)	Cargo air-craft only (9B)	Loca-tion (10A)	Other (10B)
	Phenoxyacetic acid derivative pes-ticide, liquid, toxic	6.1	UN3348	I	6.1	IB2, T11, TP2, TP13, TP27 T14, TP2, TP13, TP27	None	201	243	1 L	60 L	B	40
	Phenoxyacetic acid derivative pes-ticide, liquid, toxic, flammable, flash point not less than 23 de-grees C	6.1	UN3347	I	6.1, 3	IB2, T11, TP2, TP27 IB3, T7, TP2, TP28 T14, TP2, TP13, TP27	None	201	243	1 L	30 L	B	40
	Phenoxyacetic acid derivative pes-ticide, solid, toxic	6.1	UN3345	III	6.1, 3	IB2, T11, TP2, TP13, TP27 IB3, T7, TP2, TP28 IB7, IP1, T6, TP33	None	211	242	5 kg	220 L	A	40
	Phenyl chloroformate	6.1	UN2746	II	6.1, 8	IB8, IP2, IP4, T3, TP33 IB8, IP3, T1, TP33 IB2, T7, TP2, TP13	153	212	242	25 kg	100 kg	A	40
	Phenyl isocyanate	6.1	UN2487	I	6.1, 3	2, B9, B14, B32, B77, N33, N34, T20, TP2, TP13, TP38, TP45	None	227	244	Forbidden	Forbidden	D	40
	Phenyl mercaptan	6.1	UN2337	I	6.1, 3	2, B9, B14, B32, B77, T20, TP2, TP13, TP38, TP45	None	227	244	Forbidden	Forbidden	D	40, 52
	Phenyl phosphorus dichloride	8	UN2798	II	8	B2, B15, IB2, T7, TP2	154	202	242	Forbidden	30 L	B	40
	Phenyl phosphorus trichloride	8	UN2799	II	8	B2, B15, IB2, T7, TP2	154	202	242	Forbidden	30 L	B	40
	Phenyl urea pesticides, liquid, toxic	6.1	UN3002	II	6.1	T14, TP2, TP27	None	201	243	1 L	30 L	B	40
	Phenylacetone, liquid	6.1	UN2470	III	6.1	T7, TP2	None	202	243	5 L	60 L	B	40
	Phenylacetyl chloride	8	UN2577	III	6.1	T4, TP1	153	203	241	60 L	220 L	A	40
	Phenylcarbamylamine chloride	6.1	UN1672	II	6.1	IB3, T4, TP1	153	203	241	60 L	220 L	A	52
	<i>m</i> -Phenylenediamine	Forbidden				B2, IB2, T7, TP2	154	202	242	1 L	30 L	C	40
	<i>o</i> -Phenylenediamine	Forbidden				2, B9, B14, B32, T20, TP2, TP13, TP38, TP45	None	227	244	Forbidden	Forbidden	D	40
+	<i>p</i> -Phenylenediamine	6.1	UN1673	III	6.1	IB8, IP3, T1, TP33	153	213	240	100 kg	200 kg	A	

Phenyhydrazine	6.1	UN2572	II	6.1	IB2, T7, TP2	153	202	242	5 L	60 L	A	40
Phenylmercuric acetate	6.1	UN1674	II	6.1	IB8, IP2, IP4, T3, TP33	153	212	242	25 kg	100 kg	A	
Phenylmercuric compounds, n.o.s.	6.1	UN2026	I	6.1	IB7, IP1, T6, TP33	None	211	242	5 kg	50 kg	A	
			III	6.1	IB8, IP2, IP4, T3, TP33	153	212	242	100 kg	100 kg	A	
Phenylmercuric hydroxide	6.1	UN1894	III	6.1	IB8, IP3, T1, TP33	153	213	240	100 kg	200 kg	A	
Phenylmercuric nitrate	6.1	UN1895	II	6.1	IB8, IP2, IP4, T3, TP33	153	212	242	25 kg	100 kg	A	
Phenyltrichlorosilane	8	UN1804	II	8	IB8, IP2, IP4, T3, TP33	153	212	242	25 kg	100 kg	A	
			II	8	A7, B6, N34, T10, TP2, TP7, TP13	None	206	242	Forbiddn	30 L	C	40
Phosgene	2.3	UN1076	2.3, 8	1, B7, B46, N86	None	192	314	Forbiddn	Forbiddn	D	40
9-Phospha-bicyclononanes	4.2	UN2940	II	4.2	A19, IB6, IP2, T3, TP33	None	212	241	15 kg	50 kg	A	
Cyclooctadiene phosphines												
Phosphine	2.3	UN2199		2.3,	1	None	192	245	Forbiddn	Forbiddn	D	40
				2.1								
Phosphoric acid solution	8	UN1805	III	8	A7, IB3, N34, T4, TP1	154	203	241	5 L	60 L	A	
Phosphoric acid, solid	8	UN3453	III	8	IB8, IP3, T1, TP33	154	213	240	25 kg	100 kg	A	
Phosphoric acid triethylamine, see Tris-(1-aziridinyl)phosphine oxide, solution												
Phosphoric anhydride, see Phosphorus pentoxide												
Phosphorus acid	8	UN2834	III	8	IB8, IP3, T1, TP33	154	213	240	25 kg	100 kg	A	25
Phosphorus, amorphous	4.1	UN1338	III	4.1	A1, A19, B1, B9, B26, IB8, IP3, T1, TP33	None	213	243	25 kg	100 kg	A	74
Phosphorus bromide, see Phosphorus tribromide												
Phosphorus chloride, see Phosphorus trichloride												
Phosphorus heptasulfide, free from yellow or white phosphorus	4.1	UN1339	II	4.1	A20, IB4, N34, T3, TP33	None	212	240	15 kg	50 kg	B	74
Phosphorus oxybromide	8	UN1939	II	8	B8, IB8, IP2, IP4, N41, N43, T3, TP33	None	212	240	Forbiddn	50 kg	C	12, 40
Phosphorus oxybromide, molten	8	UN2576	II	8	B2, B8, IB1, N41, N43, T7, TP3, TP13	None	202	242	Forbiddn	Forbiddn	C	40
Phosphorus oxychloride	6.1	UN1810	I	6.1, 8	2, B9, B14, B32, B77, N34, T20, TP2, TP13, TP38, TP45	None	227	244	Forbiddn	Forbiddn	D	40
Phosphorus pentabromide	8	UN2691	II	8	A7, IB8, IP2, IP4, N34, T3, TP33	154	212	240	Forbiddn	50 kg	B	12, 40, 53, 55
Phosphorus pentachloride	8	UN1806	II	8	A7, IB8, IP2, IP4, N34, T3, TP33	None	212	240	Forbiddn	50 kg	C	40, 44, 89, 100, 141
Phosphorus pentafluoride	2.3	UN2198		2.3, 8	2, B9, B14	None	302, 304	314, 315	Forbiddn	Forbiddn	D	40
Phosphorus pentasulfide, free from yellow or white phosphorus	4.3	UN1340	II	4.3,	A20, B59, IB4, T3, TP33	151	212	242	15 kg	50 kg	B	74
Phosphorus pentoxide	8	UN1807	II	8	A7, IB8, IP2, IP4, N34, T3, TP33	154	212	240	15 kg	50 kg	A	

+

§ 172.101 HAZARDOUS MATERIALS TABLE—Continued

(1) Sym-bols	(2) Hazardous materials descriptions and proper shipping names	(3) Hazard class or Division	(4) Identi-fication Numbers	(5) PG	(6) Label Codes	(7) Special provisions (§ 172.102)	(8) Packaging (§ 173.***)			(9) Quantity limitations (see §§ 173.27 and 175.75)		(10) Vessel stowage	
							Excep-tions (8A)	Non-bulk (8B)	Bulk (8C)	Passenger aircraft/rail (9A)	Cargo air-craft only (9B)	Loca-tion (10A)	Other (10B)
	Phosphorus sesquioxide, free from yellow or white phosphorus	4.1	UN1341	II	4.1	A20, IB4, N34, T3, TP33	None	212	240	15 kg	50 kg	B	74
	Phosphorus tribromide	8	UN1808	II	8	A3, A6, A7, B2, B25, IB2, N34, N43, T7, TP2	None	202	242	Forbidden	30 L	C	40
	Phosphorus trichloride	6.1	UN1809	I	6.1, 8	B7, B9, B14, B15, B32, B77, N34, T20, TP2, TP13, TP38, TP45	None	227	244	Forbidden	Forbidden	C	40
	Phosphorus trioxide	8	UN2578	III	8	IB8, IP3, T1, TP33	154	213	240	25 kg	100 kg	A	12
	Phosphorus trisulfide, free from yellow or white phosphorus	4.1	UN1343	II	4.1	A20, IB4, N34, T3, TP33	None	212	240	15 kg	50 kg	B	74
	Phosphorus, white, under water or Phosphorus white, in solution or Phosphorus, yellow dry or Phosphorus, yellow, under water or Phosphorus, yellow, in solution	4.2	UN1381	I	4.2, 6.1	B9, B26, N34, T9, TP3, TP31	None	188	243	Forbidden	Forbidden	E	
	Phosphorus, yellow, in solution	4.2	UN2447	I	4.2, 6.1	B9, B26, N34, T21, TP3, TP7, TP26	None	188	243	Forbidden	Forbidden	D	
	Phosphorus (white or red) and a chlorate, mixtures of	Forbidden											
	Phosphoryl chloride, see Phosphorus oxychloride												
	Phthalic anhydride with more than .05 percent maleic anhydride	8	UN2214	III	8	IB8, IP3, T1, TP33	154	213	240	25 kg	100 kg	A	
	Picolines	3	UN2313	III	3	B1, IB3, T4, TP1	150	203	242	60 L	220 L	A	40
	Picric acid, see Trinitrophenol, etc												
	Picrite, see Nitroguanidine, etc												
	Picryl chloride, see Trinitrochlorobenzene												
	Pine oil	3	UN1272	III	3	B1, IB3, T2, TP1	150	203	242	60 L	220 L	A	
	alpha-Pinene	3	UN2368	III	3	B1, IB3, T2, TP1	150	203	242	60 L	220 L	A	
	Piperazine	8	UN2579	III	8	IB8, IP3, T1, TP33	154	213	240	25 kg	100 kg	A	12, 52
	Piperidine	8	UN2401	I	8, 3	A10, T10, TP2	None	201	243	0.5 L	2.5 L	B	52
	Phthaloyl chloride, see Trimethylacetyl chloride												
	Plastic molding compound in dough, sheet or extruded rope form evolving flammable vapor	9	UN3314	III	9	32, IB8, IP3, IP7	155	221	221	100 kg	200 kg	E	21, 25, 87, 144

§ 172.101 HAZARDOUS MATERIALS TABLE—Continued

(1) Sym-bols	(2) Hazardous materials descriptions and proper shipping names	(3) Hazard class or Division	(4) Identi-fication Numbers	(5) PG	(6) Label Codes	(7) Special provisions (§ 172.102)	(8) Packaging (§ 173.***)			(9) Quantity limitations (see §§ 173.27 and 175.75)		(10) Vessel stowage	
							Excep-tions (8A)	Non-bulk (8B)	Bulk (8C)	Passenger aircraft/rail (9A)	Cargo air-craft only (9B)	Loca-tion (10A)	Other (10B)
	Potassium cyanide, solid	6.1	UN1680	I	6.1	B69, B77, IB7, IP1, N74, N75, T6, TP33	None	211	242	5 kg	50 kg	B	52
	Potassium cyanide solution	6.1	UN3413	I	6.1	B69, B77, N74, N75, T14, TP2, TP13	None	201	243	1 L	30 L	B	52
				II	6.1	B69, B77, IB2, N74, N75, T11, TP2, TP13, TP27	153	202	243	5 L	60 L	B	52
				III	6.1	B69, B77, IB3, N74, N75, T7, TP2, TP13, TP28	153	203	241	60 L	220 L	A	52
	<i>Potassium dichloro isocyanurate or Potassium triazine-trione see Dichloroisocyanuric acid, dry or Dichloroisocyanuric acid salts etc</i>												
	Potassium dithionite or Potassium hydrosulfite	4.2	UN1929	II	4.2	A8, A19, A20, IB6, IP2, T3, TP33	None	212	241	15 kg	50 kg	E	13
	Potassium fluoride, solid	6.1	UN1812	III	6.1	IB8, IP3, T1, TP33	153	213	240	100 kg	200 kg	A	52
	Potassium fluoride solution	6.1	UN3422	III	6.1	IB3, T4, TP1	153	203	241	60 L	220 L	A	52
	Potassium fluoroacetate	6.1	UN2628	I	6.1	IB7, IP1, T6, TP33	None	211	242	5 kg	50 kg	E	52
	Potassium fluorosilicate	6.1	UN2655	III	6.1	IB8, IP3, T1, TP33	153	213	240	100 kg	200 kg	A	52
	<i>Potassium hydrate, see Potassium hydroxide, solid Potassium hydrogen fluoride, see Potassium hydrogen difluoride Potassium hydrogen fluoride solution, see Corrosive liquid, n.o.s. Potassium hydrogen sulfate</i>												
	Potassium hydrogendifluoride solid	8	UN2509	II	8	A7, IB8, IP2, IP4, N34, T3, TP33	154	212	240	15 kg	50 kg	A	25, 40, 52
	Potassium hydrogendifluoride solution	8	UN1811	II	8, 6.1	IB8, IP2, IP4, N3, N34, T3, TP33	154	212	240	15 kg	50 kg	A	25, 40, 52
				II	8, 6.1	IB2, N3, N34, T7, TP2	154	202	243	1 L	30 L	A	25, 40, 52
	Potassium hydrosulfite, see Potassium dithionite			III	8, 6.1	IB3, N3, N34, T4, TP1	154	203	241	5 L	60 L	A	40, 52
	<i>Potassium hydroxide, liquid, see Potassium hydroxide solution</i>												

Potassium hydroxide, solid	8	UN1813	II	8	IB8, IP2, IP4, T3, TP33	154	212	240	15 kg	50 kg	A	52, 52, 52
Potassium hydroxide, solution	8	UN1814	III	8	B2, IB2, T7, TP2, IB3, T4, TP1	154	202	242	1 L	30 L	A	52, 52
Potassium hypochlorite, solution, see Hypochlorite solutions, etc												
Potassium, metal alloys, liquid	4.3	UN1420	I	4.3	A7, A19, A20, B27	None	201	244	Forbidden	1 L	E	40, 52
Potassium, metal alloys, solid	4.3	UN3403	I	4.3	A19, A20, B27, IB4, IP1, T9, TP7, TP33	None	211	244	Forbidden	15 kg	D	
Potassium metavanadate	6.1	UN2864	II	6.1	IB8, IP2, IP4, T3, TP33	153	212	242	25 kg	100 kg	A	
Potassium monoxide	8	UN2033	III	8	IB8, IP2, IP4, T3, TP33	154	212	240	15 kg	50 kg	A	28, 52
Potassium nitrate	5.1	UN1486	III	5.1	A1, A29, B120, IB8, IP3, T1, TP33, W1	152	213	240	25 kg	100 kg	A	
Potassium nitrate and sodium nitrite mixtures	5.1	UN1487	II	5.1	B78, IB8, IP2, IP4, T3, TP33	152	212	240	5 kg	25 kg	A	56, 58
Potassium nitrite	5.1	UN1488	II	5.1	IB8, IP2, IP4, T3, TP33	152	212	242	5 kg	25 kg	A	56, 58
Potassium perchlorate	5.1	UN1489	II	5.1	IB6, IP2, T3, TP33	152	212	242	5 kg	25 kg	A	56, 58
Potassium permanganate	5.1	UN1490	II	5.1	IB8, IP2, IP4, T3, TP33	152	212	240	5 kg	25 kg	D	56, 58, 138
Potassium peroxide	5.1	UN1491	I	5.1	A20, IB6, IP1, N34	None	211	None	Forbidden	15 kg	B	13, 52, 66, 75
Potassium persulfate	5.1	UN1492	III	5.1	A1, A29, IB8, IP3, T1, TP33	152	213	240	25 kg	100 kg	A	58, 145
Potassium phosphide	4.3	UN2012	I	4.3, 6.1	A19, N40	None	211	None	Forbidden	15 kg	E	40, 52, 85
Potassium selenate, see Selenates or Selenites												
Potassium selenite, see Selenates or Selenites												
Potassium sodium alloys, liquid	4.3	UN1422	I	4.3	A7, A19, B27, N34, N40, T9, TP3, TP7, TP31	None	201	244	Forbidden	1 L	E	40, 52
Potassium sodium alloys, solid	4.3	UN3404	I	4.3	A19, B27, N34, N40, T9, TP7, TP33	None	211	244	Forbidden	15 kg	D	52
Potassium sulfide, anhydrous or Potassium sulfide with less than 30 percent water of crystallization	4.2	UN1382	II	4.2	A19, A20, B16, IB6, IP2, N34, T3, TP33	None	212	241	15 kg	50 kg	A	52
Potassium sulfide, hydrated with not less than 30 percent water of crystallization	8	UN1847	II	8	IB8, IP2, IP4, T3, TP33	154	212	240	15 kg	50 kg	A	52
Potassium superoxide	5.1	UN2466	I	5.1	A20, IB6, IP1	None	211	None	Forbidden	15 kg	B	13, 52, 66, 75
Powder cake, wetted or Powder paste, wetted with not less than 17 percent alcohol by mass	1.1C	UN0433	II	1.1C	None	62	None	Forbidden	Forbidden	4	25
Powder cake, wetted or Powder paste, wetted with not less than 25 percent water, by mass	1.3C	UN0159	II	1.3C	None	62	None	Forbidden	Forbidden	4	25
Powder paste, see Powder cake, etc												
Powder, smokeless	1.1C	UN0160	II	1.1C	None	62	None	Forbidden	Forbidden	4	25, 26E

§ 172.101 HAZARDOUS MATERIALS TABLE—Continued

(1) Sym-bols	(2) Hazardous materials descriptions and proper shipping names	(3) Hazard class or Division	(4) Identi-fication Numbers	(5) PG	(6) Label Codes	(7) Special provisions (§ 172.102)	(8) Packaging (§ 173.***)			(9) Quantity limitations (see §§ 173.27 and 175.75)		(10) Vessel stowage	
							Excep-tions (8A)	Non-bulk (8B)	Bulk (8C)	Passenger aircraft/rail (9A)	Cargo air-craft only (9B)	Loca-tion (10A)	Other (10B)
	Powder, smokeless	1.3C	UN0161	II	1.3C		None	62	None	Forbidden	Forbidden	4	25, 26E
	Powder, smokeless	1.4C	UN0509	II	1.4C	16	171	62	None	Forbidden	75 kg	02	25
	Primers, cap type	1.4S	UN0044	II	None		None	62	None	25 kg	100 kg	01	25
	Primers, cap type	1.1B	UN0377	II	1.1B		None	62	None	Forbidden	Forbidden	05	25
	Primers, cap type	1.4B	UN0378	II	1.4B		None	62	None	Forbidden	75 kg	05	25
	Primers, small arms, see Primers, cap type												
	Primers, tubular	1.3G	UN0319	II	1.3G		None	62	None	Forbidden	Forbidden	03	25
	Primers, tubular	1.4G	UN0320	II	1.4G		None	62	None	75 kg	75 kg	02	25
	Primers, tubular	1.4S	UN0376	II	None		None	62	None	25 kg	100 kg	01	25
	Printing ink, flammable or Printing ink related material (including printing ink thinning or reducing compound), flammable	3	UN1210	I	3	T11, TP1, TP8	150	173	243	1 L	30 L	E	
	Projectiles, illuminating, see Ammunition, illuminating, etc												
	Projectiles, inert with tracer	1.4S	UN0345	II	1.4S			62	62	25 kg	100 kg	01	25
	Projectiles, inert with tracer	1.3G	UN0424	II	1.3G			62	62	Forbidden	Forbidden	03	25
	Projectiles, inert, with tracer	1.4G	UN0425	II	1.4G			62	62	Forbidden	75 kg	02	25
	Projectiles, with burster or expelling charge	1.2D	UN0346	II	1.2D			62	62	Forbidden	Forbidden	04	25
	Projectiles, with burster or expelling charge	1.4D	UN0347	II	1.4D			62	62	Forbidden	75 kg	02	25
	Projectiles, with burster or expelling charge	1.2F	UN0426	II	1.2F			62	None	Forbidden	Forbidden	05	25
	Projectiles, with burster or expelling charge	1.4F	UN0427	II	1.4F			62	None	Forbidden	Forbidden	05	25
	Projectiles, with burster or expelling charge	1.2G	UN0434	II	1.2G			62	62	Forbidden	Forbidden	03	25
	Projectiles, with burster or expelling charge	1.4G	UN0435	II	1.4G			62	62	Forbidden	75 kg	02	25
	Projectiles, with bursting charge	1.1F	UN0167	II	1.1F			62	None	Forbidden	Forbidden	05	25
	Projectiles, with bursting charge	1.1D	UN0168	II	1.1D			62	62	Forbidden	Forbidden	04	25
	Projectiles, with bursting charge	1.2D	UN0169	II	1.2D			62	62	Forbidden	Forbidden	04	25

Pipeline and Haz. Matls. Safety Admin., DOT

§ 172.101

Projectiles, with bursting charge	1.2F	UN0324	II	1.2F	None	62	None	Forbiddn	05	25
Projectiles, with bursting charge	1.4D	UN0344	II	1.4D	None	62	62	75 kg	02	25
Propadiene, stabilized	2.1	UN2200	II	2.1	None	304	314, 315	150 kg	B	40
Propadiene mixed with methyl acetylene, see Methyl acetylene and propadiene mixtures, stabilized	2.1	UN1978	II	2.1	19, T50	306	304	314, 315	150 kg	E	40
Propane see also Petroleum gases, liquefied	3	UN2402	II	3	A6, IB2, T4, TP1, TP13	150	202	242	60 L	E	95, 102
Propanethiols	3	UN1274	II	3	B1, IB2, T4, TP1	150	202	242	60 L	B	
n-Propanol or Propyl alcohol, normal	1.3C	UN0495	III	3	B1, IB3, T2, TP1	150	203	242	220 L	A	25
Propellant, liquid	1.1C	UN0497	II	1.3C	37	None	62	None	Forbiddn	04	25
Propellant, liquid	1.1C	UN0498	II	1.1C	37	None	62	None	Forbiddn	04	25
Propellant, solid	1.1C	UN0498	II	1.1C	None	62	None	Forbiddn	04	25, 26E
Propellant, solid	1.3C	UN0499	II	1.3C	None	62	None	Forbiddn	04	25, 26E
Propellant, solid	1.4C	UN0501	II	1.4C	None	62	None	Forbiddn	02	25, 24E
Propionaldehyde	3	UN1275	II	3	IB2, T7, TP1	150	202	242	60 L	E	
Propionic acid with not less than 90% acid by mass	8	UN3463	II	8, 3	IB2, T7, TP2	154	202	243	30 L	A	
Propionic acid with not less than 10% and less than 90% acid by mass	8	UN1848	III	8	IB3, T4, TP1	154	203	241	60 L	A	
Propionic anhydride	8	UN2496	III	8	IB3, T4, TP1	154	203	241	60 L	A	
Propionitrile	3	UN2404	II	3, 6.1	IB2, T7, TP1, TP13	None	202	243	60 L	E	40
Propionyl chloride	3	UN1815	II	3, 8	IB1, T7, TP1	150	202	243	5 L	B	40
n-Propyl acetate	3	UN1276	II	3	IB2, T4, TP1	150	202	242	60 L	B	
Propyl alcohol, see Propanol											
n-Propyl benzene	3	UN2364	III	3	B1, IB3, T2, TP1	150	203	242	220 L	A	21, 40, 100
n-Propyl chloroformate	6.1	UN2740	I	6.1, 3, 8	2, B9, B14, B32, B77, N34, T20, TP2, TP13, TP38, TP44	None	227	244	Forbiddn	B	
Propyl chloride see 1-Chloropropane											
Propyl formates	3	UN1281	II	3	IB2, T4, TP1	150	202	242	60 L	B	40
n-Propyl isocyanate	6.1	UN2482	I	6.1, 3	1, B9, B14, B30, T20, TP2, TP13, TP38, TP44	None	226	244	Forbiddn	D	
Propyl mercaptan, see Propanethiols											
n-Propyl nitrate	3	UN1865	II	3	IB9	150	202	None	5 L	D	44, 89, 90, 100
Propylamine see also Petroleum gases, liquefied	3	UN1277	II	3, 8	A7, IB2, N34, T7, TP1	150	202	243	1 L	E	40
Propylene see also Petroleum gases, liquefied	2.1	UN1077	II	2.1	19, T50	306	304	314, 315	150 kg	E	40
Propylene chlorohydrin	6.1	UN2611	II	6.1, 3	IB2, T7, TP2, TP13	153	202	243	60 L	A	12, 25, 40

§ 172.101 HAZARDOUS MATERIALS TABLE—Continued

(1) Sym-bols	(2) Hazardous materials descriptions and proper shipping names	(3) Hazard class or Division	(4) Identi-fication Numbers	(5) PG	(6) Label Codes	(7) Special provisions (§ 172.102)	(8) Packaging (§ 173.***)			(9) Quantity limitations (see §§ 173.27 and 175.75)		(10) Vessel stowage	
							Excep-tions (8A)	Non-bulk (8B)	Bulk (8C)	Passenger aircraft/rail (9A)	Cargo air-craft only (9B)	Loca-tion (10A)	Other (10B)
	Propylene oxide	3	UN1280	I	3	A3, N34, T11, TP2, TP7	None	201	243	1 L	30 L	E	40
			UN2850	III	3		150	242	60 L	220 L	A	40	
			UN2258	II	8, 3		None	202	243	1 L	30 L	A	40
	1,2-Propylenediamine	8	UN1921	I	3, 6.1	A3, N34, T14, TP2, TP13	None	201	243	1 L	30 L	B	40
							None	206	243	Forbidden	30 L	C	40
	Propylchlorosilane	8	UN1816	II	8, 3	A7, B2, B6, N34, T10, TP2, TP7, TP13	None	201	243	Forbidden	30 L	B	40
							None	201	243	Forbidden	30 L	B	40
	Prussic acid, see Hydrogen cyanide	3	UN3350	I	3, 6.1	T14, TP2, TP13, TP27	None	201	243	Forbidden	30 L	B	40
							None	202	243	1 L	60 L	B	40
	Pyrethroid pesticide, liquid toxic	6.1	UN3352	II	3, 6.1	IB2, T11, TP2, TP13, TP27	150	202	243	1 L	60 L	B	40
							None	201	243	1 L	30 L	B	40
	Pyrethroid pesticide, liquid toxic	6.1	UN3351	III	6.1	IB2, T11, TP2, TP27	153	202	243	5L	60L	B	40
							None	203	241	60L	220L	A	40
	Pyrethroid pesticide, liquid, toxic, flammable, flash point not less than 23 degrees C	6.1	UN3351	I	6.1, 3	T14, TP2, TP13, TP27	None	201	243	1 L	30 L	B	40
							None	202	243	5 L	60 L	B	40
	Pyrethroid pesticide, solid, toxic	6.1	UN3349	III	6.1, 3	IB3, T7, TP2, TP28	153	203	241	60 L	220 L	B	40
							None	211	242	5 kg	50 kg	A	40
	Pyridine	3	UN1282	III	6.1	IB7, IP1, T6, TP33	None	212	242	25 kg	100 kg	A	40
							None	213	240	100 kg	200 kg	A	40
	Pyridine perchlorate	Forbidden	UN1282	II	3	IB8, IP3, T1, TP33	None	202	242	5 L	60 L	B	21, 100
							None	181	244	Forbidden	Forbidden	D	78
	Pyrophoric liquid, inorganic, n.o.s	4.2	UN3194	I	4.2	B11, T22, TP2, TP7	None	181	244	Forbidden	Forbidden	D	78
							None	181	244	Forbidden	Forbidden	D	78
	Pyrophoric liquids, organic, n.o.s	4.2	UN2845	I	4.2	B11, T21, TP7, TP33	None	187	242	Forbidden	Forbidden	D	78
							None	187	242	Forbidden	Forbidden	D	78
	Pyrophoric metals, n.o.s., or Pyrophoric alloys, n.o.s.	4.2	UN1383	I	4.2	T21, TP7, TP33	None	187	242	Forbidden	Forbidden	D	78
							None	187	242	Forbidden	Forbidden	D	78
	Pyrophoric solid, inorganic, n.o.s.	4.2	UN3200	I	4.2	B2, IB2, T8, TP2	None	187	242	Forbidden	Forbidden	D	78
							None	187	242	Forbidden	Forbidden	D	78
	Pyrophoric solids, organic, n.o.s.	4.2	UN2846	I	4.2	None	None	187	242	Forbidden	Forbidden	D	78
							None	187	242	Forbidden	Forbidden	D	78
	Pyrosulphur chloride	8	UN1817	II	8	None	154	202	242	1 L	30 L	C	40
							None	202	242	1 L	30 L	C	40
	Nitrocellulose	3	UN1922	II	3, 8	IB2, T7, TP1	150	202	243	1 L	5 L	B	40, 52
							None	202	243	1 L	5 L	B	40, 52

Forbidden	UN2656	III	6.1	IB3, T4, TP1	153	203	241	60 L	220 L	A	12
<i>Quebrachitol pentanitrate</i>											
<i>Quicklime, see Calcium oxide</i>											
<i>Quinoline</i>											
<i>R 12, see Dichlorodifluoromethane</i>	6.1	UN2656	6.1	IB3, T4, TP1	153	203	241	60 L	220 L	A	12
<i>R 12B1, see Chlorodifluoromomomethane</i>											
<i>R 13, see Chlorotrifluoromethane</i>											
<i>R 13B1, see Bromotrifluoromethane</i>											
<i>R 14, see Tetrafluoromethane</i>											
<i>R 21, see Dichlorodifluoromethane</i>											
<i>R 22, see Chlorodifluoromethane</i>											
<i>R 114, see Dichlorotetrafluoroethane</i>											
<i>R 115, see Chloropentafluoroethane</i>											
<i>R 116, see Hexafluoroethane</i>											
<i>R 124, see Chlorotetrafluoroethane</i>											
<i>R 133a, see Chlorotrifluoroethane</i>											
<i>R 152a, see Difluoroethane</i>											
<i>R 500, see Dichlorodifluoromethane and difluoroethane, etc</i>											
<i>R 502, see Chlorodifluoromethane and chloropentafluoroethane mixture, etc</i>											
<i>R 503, see Chlorotrifluoromethane and trifluoromethane, etc</i>											
Radioactive material, excepted package-articles manufactured from natural uranium or depleted uranium or natural thorium	7	UN2909	None		422, 426	422, 426	422, 426			A	
Radioactive material, excepted package-empty packaging	7	UN2908	Empty		422, 428	422, 428	422, 428			A	
Radioactive material, excepted package-instruments or articles	7	UN2911	None		422, 424	422, 424	422, 424			A	
Radioactive material, excepted package-limited quantity of material	7	UN2910	None		424, 421, 422	421, 422	421, 422			A	
Radioactive material, low specific activity (LSA-I) non fissile or fissile-excepted	7	UN2912	7	A56, T5, TP4, W7	421, 422, 428	427	427			A	95, 129
Radioactive material, low specific activity (LSA-II) non fissile or fissile-excepted	7	UN3321	7	A56, T5, TP4, W7	421, 422, 428	427	427			A	95, 129
Radioactive material, low specific activity (LSA-III) non fissile or fissile-excepted	7	UN3322	7	A56, T5, TP4, W7	421, 422, 428	427	427			A	95, 129
Radioactive material, surface contaminated objects (SCO-I or SCO-II) non fissile or fissile-excepted	7	UN2913	7	A56	421, 422, 428	427	427			A	95

§ 172.101 HAZARDOUS MATERIALS TABLE—Continued

(1) Sym-bols	(2) Hazardous materials descriptions and proper shipping names	(3) Hazard class or Division	(4) Identi-fication Numbers	(5) PG	(6) Label Codes	(7) Special provisions (§ 172.102)	(8) Packaging (§ 173.***)			(9) Quantity limitations (see §§ 173.27 and 175.75)		(10) Vessel stowage	
							Excep-tions (8A)	Non-bulk (8B)	Bulk (8C)	Passenger aircraft/rail (9A)	Cargo air-craft only (9B)	Loca-tion (10A)	Other (10B)
	Radioactive material, transported under special arrangement, <i>non fissile or fissile excepted</i>	7	UN2919		7	A56, 139						A	95, 105
	Radioactive material, transported under special arrangement, fissile	7	UN3331		7	A56, 139						A	95, 105
	Radioactive material, Type A package, fissile <i>non-special form</i>	7	UN3327		7	A56, W7, W8	453	417		417		A	95, 105, 131
	Radioactive material, Type A package <i>non-special form, non fissile or fissile-excepted</i>	7	UN2915		7	A56, W7, W8	None	415, 418, 419		415, 418, 419		A	95, 130
	Radioactive material, Type A package, special form <i>non fissile or fissile-excepted</i>	7	UN3332		7	A56, W7, W8		415, 476		415, 476		A	95
	Radioactive material, Type A package, special form, fissile	7	UN3333		7	A56, W7, W8	453	417, 476		417, 476		A	95, 105
	Radioactive material, Type B(M) package, fissile	7	UN3329		7	A56	453	417		417		A	95, 105
	Radioactive material, Type B(M) package <i>non fissile or fissile-excepted</i>	7	UN2917		7	A56		416		416		A	95, 105
	Radioactive material, Type B(U) package, fissile	7	UN3328		7	A56	453	417		417		A	95, 105
	Radioactive material, Type B(U) package <i>non fissile or fissile-excepted</i>	7	UN2916		7	A56		416		416		A	95, 105
	Radioactive material, uranium hexafluoride <i>non fissile or fissile-excepted</i>	7	UN2978		7, 8		423	420, 427		420, 427		A	95, 132
	Radioactive material, uranium hexafluoride, fissile	7	UN2977		7, 8		453	417, 420		417, 420		A	95, 132
A W	Regs. oily <i>Railway torpedo, see Signals, railway track, explosive</i> <i>RC 318, see Octafluorocyclobutane</i>	4.2	UN1856	III	4.2		151	213		240		A	

RDX and cyclohexamethylenetetramine, wetted or desensitized see RDX and HMX mixtures, wetted or desensitized	1.1D	UN0391	II	1.1D	None	62	None	Forbidden	Forbidden	04	25
RDX and HMX mixtures, wetted with not less than 15 percent water by mass or RDX and HMX mixtures, desensitized with not less than 10 percent phlegmatizer by mass												
RDX and Octogen mixtures, wetted or desensitized see RDX and HMX mixtures, wetted or desensitized etc												
RDX, see Cyclotrimethylene trinitramine, etc												
Receptacles, small, containing gas or gas cartridges (flammable) without release device, not refillable and not exceeding 1 L capacity	2.1	UN2037		2.1		306	304	None	1 kg	15 kg	B	40
Receptacles, small, containing gas or gas cartridges (non-flammable) without release device, not refillable and not exceeding 1 L capacity	2.2	UN2037		2.2		306	304	None	1 kg	15 kg	B	40
Receptacles, small, containing gas or gas cartridges (oxidizing) without release device, not refillable and not exceeding 1 L capacity	2.2, 5.1	UN2037		2.2, 5.1	A14	306	304	None	1 kg	15 kg	B	40
Red phosphorus, see Phosphorus, amorphous												
Refrigerant gas R 404A	2.2	UN3337		2.2	T50	306	304	314, 315	75 kg	150 kg	A	
Refrigerant gas R 407A	2.2	UN3338		2.2	T50	306	304	314, 315	75 kg	150 kg	A	
Refrigerant gas R 407B	2.2	UN3339		2.2	T50	306	304	314, 315	75 kg	150 kg	A	
Refrigerant gas R 407C	2.2	UN3340		2.2	T50	306	304	314, 315	75 kg	150 kg	A	
Refrigerant gases, n.o.s.	2.2	UN1078		2.2	T50	306	304	314, 315	75 kg	150 kg	A	
Refrigerant gases, n.o.s. or Dispersant gases, n.o.s.	2.1	NA1954		2.1	T50	306	304	314, 315	Forbidden	150 kg	D	40
Refrigerating machines, containing flammable, non-toxic, liquefied gas	2.1	UN3358		2.1		306, 307	306	306	Forbidden	Forbidden	D	40

§ 172.101 HAZARDOUS MATERIALS TABLE—Continued

(1) Sym-bols	(2) Hazardous materials descriptions and proper shipping names	(3) Hazard class or Division	(4) Identi-fication Numbers	(5) PG	(6) Label Codes	(7) Special provisions (§ 172.102)	(8) Packaging (§ 173.***)			(9) Quantity limitations (see §§ 173.27 and 175.75)		(10) Vessel stowage	
							Excep-tions	Non-bulk	Bulk	Passenger aircraft/rail	Cargo air-craft only	Loca-tion	Other
	Refrigerating machines, containing non-flammable, non-toxic gases, or ammonia solutions (UN2672)	2.2	UN2857		2.2	A53	306, 307	306	306, 307	450 kg	450 kg	A	
	Regulated medical waste, n.o.s., or Clinical waste, unspecified, n.o.s., or (BIO) Medical waste, n.o.s., or Biomedical waste, n.o.s. or Medical waste, n.o.s.	6.2	UN3291	II	6.2	41, A13, 337	134	197	197	No limit	No limit	B	40
	Release devices, explosive Resin solution, flammable	1.4S 3	UN0173 UN1866	II I	1.4S 3 B52, T11, TP1, TP8, TP28	None 150	62 201	62 243	25 kg 1 L	100 kg 30 L	01 E	25
	Resorcinol Rifle grenade, see Grenades, hand or rifle, etc Rifle powder, see Powder, smoke-less (UN 0160)	6.1	UN2876	III III	3 6.1	149, B52, IB2, T4, TP1, TP8 B1, B52, IB3, T2, TP1, IB8, IP3, T1, TP33	150 150 153	173 173 213	242 242 240	5 L 60 L 100 kg	60 L 220 L 200 kg	B A A	
	Rivets, explosive Road asphalt or tar liquid, see Tars, liquid, etc	1.4S	UN0174	II	1.4S	None	62	62	25 kg	100 kg	01	25
	Rocket motors	1.3C	UN0186	II	1.3C	109	None	62	62	Forbidden	220 kg	04	25
	Rocket motors	1.1C	UN0280	II	1.1C	109	None	62	62	Forbidden	Forbidden	04	25
	Rocket motors	1.2C	UN0281	II	1.2C	109	None	62	62	Forbidden	Forbidden	04	25
	Rocket motors, liquid fueled	1.2J	UN0395	II	1.2J	109	None	62	None	Forbidden	Forbidden	05	25, 23E
	Rocket motors, liquid fueled	1.3J	UN0396	II	1.3J	109	None	62	None	Forbidden	Forbidden	05	25, 23E
	Rocket motors with hypergolic liquids with or without an expelling charge	1.3L	UN0250	II	1.3L	109	None	62	None	Forbidden	Forbidden	05	25, 14E, 15E
	Rocket motors with hypergolic liquids with or without an expelling charge	1.2L	UN0322	II	1.2L	109	None	62	None	Forbidden	Forbidden	05	25, 14E, 15E
	Rockets, line-throwing	1.2G	UN0238	II	1.2G	None	62	None	Forbidden	Forbidden	03	25
	Rockets, line-throwing	1.3G	UN0240	II	1.3G	None	62	None	Forbidden	75 kg	03	25

§ 172.101 HAZARDOUS MATERIALS TABLE—Continued

(1) Sym-bols	(2) Hazardous materials descriptions and proper shipping names	(3) Hazard class or Division	(4) Identi-fication Numbers	(5) PG	(6) Label Codes	(7) Special provisions (§ 172.102)	(8) Packaging (§ 173.***)			(9) Quantity limitations (see §§ 173.27 and 175.75)		(10) Vessel stowage	
							Excep-tions	Non-bulk	Bulk	Passenger aircraft/rail	Cargo air-craft only	Loca-tion	Other
(1)	(2)	(3)	(4)	(5)	(6)	(7)	(8A)	(8B)	(8C)	(9A)	(9B)	(10A)	(10B)
G	Selenium compound, solid, n.o.s.	6.1	UN3283	I	6.1	IB7, IP1, T6, TP33	None	211	242	5 kg	50 kg	B	
				II	6.1	IB8, IP2, IP4, T3, TP33	153	212	242	25 kg	100 kg	B	
				III	6.1	IB8, IP3, T1, TP33	153	213	240	100 kg	200 kg	A	
	Selenium disulfide	6.1	UN2657	II	6.1	IB8, IP2, IP4, T3, TP33	153	212	242	25 kg	100 kg	A	
	Selenium hexafluoride	2.3	UN2194		2.3, 8	1	None	302	None	Forbidden	Forbidden	D	40
	Selenium nitride	Forbidden											
	Selenium oxychloride	8	UN2879	I	8, 6.1	A3, A6, A7, N34, T10, TP2, TP13	None	201	243	0.5 L	2.5 L	E	40
	<i>Self-defense spray, aerosol, see Aerosols, etc</i>												
+ A D	<i>Self-defense spray, non-pressurized</i>	9	NA3334	III	9	A37	155	203	None	No limit	No limit	A	
G	Self-heating liquid, corrosive, inorganic, n.o.s.	4.2	UN3188	II	4.2, 8	IB2	None	202	243	1 L	5 L	C	
G	Self-heating liquid, corrosive, organic, n.o.s.	4.2	UN3185	III	4.2, 8	IB2	None	203	241	5 L	60 L	C	
				II	4.2, 8	IB2	None	202	243	1 L	5 L	C	
G	Self-heating liquid, inorganic, n.o.s.	4.2	UN3186	III	4.2, 8	IB2	None	203	241	5 L	60 L	C	
				II	4.2	IB2	None	202	242	1 L	5 L	C	
				III	4.2	IB2	None	203	241	5 L	60 L	C	
G	Self-heating liquid, organic, n.o.s.	4.2	UN3183	III	4.2	IB2	None	202	242	1 L	5 L	C	
				II	4.2	IB2	None	203	241	5 L	60 L	C	
G	Self-heating liquid, toxic, inorganic, n.o.s.	4.2	UN3187	II	4.2, 6.1	IB2	None	202	243	1 L	5 L	C	
				III	4.2, 6.1	IB2	None	203	241	5 L	60 L	C	
G	Self-heating liquid, toxic, organic, n.o.s.	4.2	UN3184	II	4.2, 6.1	IB2	None	202	243	1 L	5 L	C	
				III	4.2, 6.1	IB2	None	203	241	5 L	60 L	C	
G	Self-heating solid, corrosive, inorganic, n.o.s.	4.2	UN3192	II	4.2, 8	IB5, IP2, T3, TP33	None	212	242	15 kg	50 kg	C	
				III	4.2, 8	IB8, IP3, T1, TP33	None	213	242	25 kg	100 kg	C	
G	Self-heating solid, corrosive, organic, n.o.s.	4.2	UN3126	III	4.2, 8	IB5, IP2, T3, TP33	None	212	242	15 kg	50 kg	C	
				II	4.2, 8	IB8, IP3, T1, TP33	None	213	242	25 kg	100 kg	C	
G	Self-heating solid, inorganic, n.o.s.	4.2	UN3190	II	4.2	IB6, IP2, T3, TP33	None	212	241	25 kg	100 kg	C	
				III	4.2	IB8, IP3, T1, TP33	None	213	241	25 kg	100 kg	C	
				II	4.2	IB6, IP2, T3, TP33	None	212	241	15kg	50kg	C	

Class	Description	UN Number	Quantity	Label	Code	Section	Provisions	Notes	Other
G	Self-heating solid, oxidizing, n.o.s.	4.2 UN3127	III	4.2	None	IB8, IP3, T1, TP33, B116	241	15kg Forbidden	C
G	Self-heating solid, toxic, inorganic, n.o.s.	4.2 UN3191	II	4.2, 5.1, 6.1	None	IB5, IP2, T3, TP33	214	15kg Forbidden	C
G	Self-heating solid, toxic, organic, n.o.s.	4.2 UN3128	III	4.2, 6.1	None	IB8, IP3, T1, TP33	242	25kg Forbidden	C
G	Self-propelled vehicle, see Engines or Batteries etc				None				
G	Self-reactive liquid type B, temperature controlled	4.1 UN3221	II	4.1	151	53	None	(2) Forbidden	D
G	Self-reactive liquid type C, temperature controlled	4.1 UN3223	II	4.1	None	53	None	(2) Forbidden	D
G	Self-reactive liquid type D, temperature controlled	4.1 UN3225	II	4.1	151		None	5 L Forbidden	D
G	Self-reactive liquid type E, temperature controlled	4.1 UN3227	II	4.1	151		None	10 L Forbidden	D
G	Self-reactive liquid type F, temperature controlled	4.1 UN3237	II	4.1	None		None	10 L Forbidden	D
G	Self-reactive solid type B, temperature controlled	4.1 UN3222	II	4.1	151	53	None	(1) Forbidden	D
G	Self-reactive solid type C, temperature controlled	4.1 UN3224	II	4.1	None	53	None	5 kg Forbidden	D
G	Self-reactive solid type D, temperature controlled	4.1 UN3226	II	4.1	151		None	10 kg Forbidden	D
G	Self-reactive solid type E, temperature controlled	4.1 UN3228	II	4.1	None		None	10 kg Forbidden	D
G	Self-reactive solid type F, temperature controlled	4.1 UN3230	II	4.1	151		None	10 kg Forbidden	D
G	Shale oil	3 UN1288	I	3	None	T11, TP1, TP8, TP27	243	1 L 30 L	B
G	Shaped charges, see Charges, shaped, etc		II	3	None	IB2, T4, TP1, TP8	242	5 L 60 L	B
G	Signal devices, hand	1.4G UN0191	II	1.4G	None	B1, IB3, T2, TP1	242	60 L 220 L	A
			II	62	None		None	75 kg Forbidden	02

§ 172.101 HAZARDOUS MATERIALS TABLE—Continued

(1) Sym-bols	(2) Hazardous materials descriptions and proper shipping names	(3) Hazard class or Division	(4) Identi-fication Numbers	(5) PG	(6) Label Codes	(7) Special provisions (§ 172.102)	(8) Packaging (§ 173.***)			(9) Quantity limitations (see §§ 173.27 and 175.75)		(10) Vessel stowage	
							Excep-tions	Non-bulk	Bulk	Passenger aircraft/rail	Cargo air-craft only	Loca-tion	Other
(1)	(2)	(3)	(4)	(5)	(6)	(7)	(8A)	(8B)	(8C)	(9A)	(9B)	(10A)	(10B)
	Signal devices, hand	1.4S	UN0373	II	1.4S		None	62	None	25 kg	100 kg	01	25
	Signals, distress, <i>ship</i>	1.1G	UN0194	II	1.1G		None	62	None	Forbidden	Forbidden	03	25
	Signals, distress, <i>ship</i>	1.3G	UN0195	II	1.3G		None	62	None	75 kg	75 kg	03	25
	Signals, distress, <i>ship</i>	1.4G	UN0505	1.4G		None	62	None	Forbidden	75 kg	02	25
	Signals, distress, <i>ship</i>	1.4S	UN0506	1.4S		None	62	None	25 kg	100 kg	01	25
	Signals, highway, see Signal de-vices, hand												
	Signals, railway track, explosive	1.1G	UN0192	II	1.1G		None	62	None	Forbidden	Forbidden	03	25
	Signals, railway track, explosive	1.4S	UN0193	II	1.4S		None	62	None	25 kg	100 kg	01	25
	Signals, railway track, explosive	1.3G	UN0492	1.3G		None	62	None	Forbidden	Forbidden	03	25
	Signals, railway track, explosive	1.4G	UN0493	1.4G		None	62	None	Forbidden	75 kg	02	25
	Signals, <i>ship</i> distress, water-acti-vated, see Contrivances, water-activated, etc												
	Signals, smoke	1.1G	UN0196	II	1.1G		None	62	None	Forbidden	Forbidden	03	25
	Signals, smoke	1.4G	UN0197	II	1.4G		None	62	None	75 kg	75 kg	02	25
	Signals, smoke	1.2G	UN0313	II	1.2G		None	62	None	Forbidden	Forbidden	03	25
	Signals, smoke	1.3G	UN0487	II	1.3G		None	62	None	Forbidden	Forbidden	03	25
	Signals, smoke	1.4S	UN0507	1.4S		None	62	None	25 kg	100 kg	01	25
	Silane	2.1	UN2203	2.1		None	302	None	Forbidden	Forbidden	E	25
	Silicofluoric acid, see Fluorosilicic acid												40, 57, 104
	Silicon chloride, see Silicon tetra-chloride												
	Silicon powder, amorphous	4.1	UN1346	III	4.1	A1, IB8, IP3, T1, TP33	None	213	240	25 kg	100 kg	A	74
	Silicon tetrachloride	8	UN1818	II	8	A3, A6, B2, B6, T10, TP2, TP7, TP13	None	202	242	Forbidden	30 L	C	40
	Silicon tetrafluoride	2.3	UN1859	2.3, 8		None	302	None	Forbidden	Forbidden	D	40
	Silver acetylide (dry)	Forbidden	UN1683	II	6.1	IB8, IP2, IP4, T3, TP33	153	212	242	25 kg	100 kg	A	
	Silver arsenite	6.1	UN1684	II	6.1	IB8, IP2, IP4, T3, TP33	153	212	242	25 kg	100 kg	A	40, 52
	Silver azide (dry)	Forbidden											
	Silver chlorite (dry)	6.1	UN1684	II	6.1	IB8, IP2, IP4, T3, TP33	153	212	242	25 kg	100 kg	A	
	Silver cyanide	Forbidden											
	Silver fulminate (dry)	5.1	UN1493	II	5.1	IB8, IP2, IP4, T3, TP33	152	212	242	5 kg	25 kg	A	
	Silver nitrate	Forbidden											
	Silver oxalate (dry)	Forbidden											
	Silver picrate (dry)	Forbidden											

§ 172.101 HAZARDOUS MATERIALS TABLE—Continued

(1) Sym-bols	(2) Hazardous materials descriptions and proper shipping names	(3) Hazard class or Division	(4) Identi-fication Numbers	(5) PG	(6) Label Codes	(7) Special provisions (§ 172.102)	(8) Packaging (§ 173.***)			(9) Quantity limitations (see §§ 173.27 and 175.75)		(10) Vessel stowage	
							Excep-tions (8A)	Non-bulk (8B)	Bulk (8C)	Passenger aircraft/rail (9A)	Cargo air-craft only (9B)	Loca-tion (10A)	Other (10B)
	Sodium chlorate mixed with dinitro-toluene, see Explosive blasting, Type C												
	Sodium chlorite	5.1	UN1496	II	5.1	A9, IB8, IP2, IP4, N34, T3, TP33	None	212	242	5 kg	25 kg	A	56, 58
	Sodium chloroacetate	6.1	UN2659	III	6.1	IB8, IP3, T1, TP33	153	213	240	100 kg	200 kg	A	52
	Sodium cuprocyanide, solid	6.1	UN2316	I	6.1	IB7, IP1, T6, TP33	None	211	242	5 kg	50 kg	A	52
	Sodium cuprocyanide, solution	6.1	UN2317	I	6.1	T14, TP2, TP13	None	201	243	1 L	30 L	B	40, 52
	Sodium cyanide, solid	6.1	UN1689	I	6.1	B69, B77, IB7, N74, N75, T6, TP33	None	211	242	5 kg	50 kg	B	52
	Sodium cyanide solution	6.1	UN3414	I	6.1	B69, B77, N74, N75, T14, TP2, TP13	None	201	243	1 L	30 L	B	52
				II	6.1	B69, B77, IB2, N74, N75, T11, TP2, TP13,	153	202	243	5 L	60 L	B	52
				III	6.1	B69, B77, IB3, N74, N75, T7, TP2, TP13, TP28	153	203	241	60 L	220 L	A	52
	Sodium dichloroisocyanurate or So-dium dichloro-s-triazinetriene, see Dichloroisocyanuric acid etc	1.3C	UN0234	II	1.3C	None	62	None	Forbidden	Forbidden	04	25, 5E
	Sodium dinitro-o-cresolate, dry or wetted with less than 15 percent water, by mass	4.1	UN3369	I	4.1	162, A8, A19, N41, N84	None	211	None	0.5 kg	0.5 kg	E	36
	Sodium dinitro-o-cresolate, wetted with not less than 10% water, by mass	4.1	UN1348	I	4.1, 6.1	23, A8, A19, A20, N41	None	211	None	1 kg	15 kg	E	28, 36
	Sodium dinitro-o-cresolate, wetted with not less than 15 percent water, by mass	4.2	UN1384	II	4.2	A19, A20, IB6, IP2, T3, TP33	None	212	241	15 kg	50 kg	E	13
	Sodium dithionite or Sodium hydro-sulfite	6.1	UN1690	III	6.1	IB8, IP3, T1, TP33	153	213	240	100 kg	200 kg	A	52
	Sodium fluoride, solid	6.1	UN3415	III	6.1	IB3, T4, TP1	153	203	241	60 L	220 L	A	52
	Sodium fluoride solution	6.1	UN2629	I	6.1	IB7, IP1, T6, TP33	None	211	242	5 kg	50 kg	E	52
	Sodium fluorooacetate	6.1	UN2674	III	6.1	IB8, IP3, T1, TP33	153	213	240	100 kg	200 kg	A	52
	Sodium hydrate, see Sodium hy-droxide, solid												

Sodium hydride	4.3	UN1427	I	4.3	IB8, IP2, IP4, N3, N34, TP33	None	211	242	Forbidden	15 kg	E	52
Sodium hydrogendifluoride	8	UN2439	II	8	A19, N40	None	212	240	15 kg	50 kg	A	12, 25, 40, 52, 52.
Sodium hydrosulfide, with less than 25 percent water of crystallization	4.2	UN2318	II	4.2	A7, A19, A20, IB6, IP2, TP3, TP33	None	212	241	15 kg	50 kg	A	52.
Sodium hydrosulfide with not less than 25 percent water of crystallization	8	UN2949	II	8	A7, IB8, IP2, IP4, T7, TP2	154	212	240	15 kg	50 kg	A	52
Sodium hydrosulfite, see Sodium dithionite												
Sodium hydroxide, solid	8	UN1823	II	8	IB8, IP2, IP4, T3, TP33	154	212	240	15 kg	50 kg	A	52.
Sodium hydroxide solution	8	UN1824	III	8	B2, IB2, N34, T7, TP2	154	202	242	1 L	30 L	A	52.
Sodium hypochlorite, solution, see Hypochlorite solutions etc												
Sodium metal, liquid alloy, see Alkali metal alloys, liquid, n.o.s.												
Sodium methylate	4.2	UN1431	II	4.2, 8	A7, A19, IB5, IP2, T3, TP33	None	212	242	15 kg	50 kg	B	
Sodium methylate solutions in alcohol	3	UN1289	II	3, 8	IB2, T7, TP1, TP8	150	202	243	1 L	5 L	B	
Sodium monoxide	8	UN1825	III	3, 8	B1, IB3, T4, TP1	150	203	242	5 L	60 L	A	
Sodium nitrate	5.1	UN1498	III	5.1	IB8, IP2, IP4, T3, TP33	154	212	240	15 kg	50 kg	A	52.
Sodium nitrate and potassium nitrate mixtures	5.1	UN1499	III	5.1	A1, A29, B120, IB8, IP3, T1, TP33, W1	152	213	240	25 kg	100 kg	A	
Sodium nitrite	5.1	UN1500	III	5.1, 6.1	A1, A29, IB8, IP3, T1, TP33	152	213	240	25 kg	100 kg	A	56, 58
Sodium pentachlorophenate	6.1	UN2567	II	6.1	IB8, IP2, IP4, T3, TP33	153	212	242	25 kg	100 kg	A	
Sodium perborate monohydrate	5.1	UN3377	III	5.1	B120, IB8, IP3, T1, TP33	152	213	240	25 kg	100 kg	A	13, 25, 75
Sodium perchlorate	5.1	UN1502	II	5.1	IB6, IP2, T3, TP33	152	212	242	5 kg	25 kg	A	56, 58
Sodium permanganate	5.1	UN1503	II	5.1	IB6, IP2, T3, TP33	152	212	242	5 kg	25 kg	D	56, 58, 138
Sodium peroxide	5.1	UN1504	I	5.1	A20, IB5, IP1, N34	None	211	None	Forbidden	15 kg	B	13, 52, 66, 75
Sodium peroxoborate, anhydrous	5.1	UN3247	II	5.1	IB8, IP2, IP4, T3, TP33	152	212	240	5 kg	25 kg	A	13, 25
Sodium persulfate	5.1	UN1505	III	5.1	A1, IB8, IP3, T1, TP33	152	213	240	25 kg	100 kg	A	58, 145
Sodium phosphide	4.3	UN1432	I	4.3, 6.1	A19, N40	None	211	None	Forbidden	15 kg	E	40, 52, 85
Sodium picramate, dry or wetted with less than 20 percent water, by mass	1.3C	UN0235	II	1.3C	None	62	None	Forbidden	Forbidden	04	25, 5E
Sodium picramate, wetted with not less than 20 percent water, by mass	4.1	UN1349	I	4.1	23, A8, A19, N41	None	211	None	Forbidden	15 kg	E	28, 36
Sodium picryl peroxide												
Sodium potassium alloys, see Potassium sodium alloys	Forbidden											

§ 172.101 HAZARDOUS MATERIALS TABLE—Continued

(1) Sym-bols	(2) Hazardous materials descriptions and proper shipping names	(3) Hazard class or Division	(4) Identi-fication Numbers	(5) PG	(6) Label Codes	(7) Special provisions (§ 172.102)	(8) Packaging (§ 173.***)			(9) Quantity limitations (see §§ 173.27 and 175.75)		(10) Vessel stowage	
							Excep-tions (8A)	Non-bulk (8B)	Bulk (8C)	Passenger aircraft/rail (9A)	Cargo air-craft only (9B)	Loca-tion (10A)	Other (10B)
	Sodium selenate, see Selenates or Selenites												
	Sodium sulfide, anhydrous or Sodium sulfide with less than 30 percent water of crystallization	4.2	UN1385	II	4.2	A19, A20, IB6, IP2, N34, T3, TP33	None	212	241	15 kg	50 kg	A	52
	Sodium sulfide, hydrated with not less than 30 percent water	8	UN1849	II	8	IB8, IP2, IP4, T3, TP33	154	212	240	15 kg	50 kg	A	52.
	Sodium superoxide	5.1	UN2547	I	5.1	A20, IB6, IP1, N34	None	211	None	Forbidden	15 kg	E	13, 52, 66, 75
	Sodium tetrafluoroborate	Forbidden											
G	Solids containing corrosive liquid, n.o.s.	8	UN3244	II	8	49, IB5, T3, TP33	154	212	240	15 kg	50 kg	B	40
G	Solids containing flammable liquid, n.o.s.	4.1	UN3175	II	4.1	47, IB6, IP2, T3, TP33	151	212	240	15 kg	50 kg	B	
G	Solids containing toxic liquid, n.o.s.	6.1	UN3243	II	6.1	48, IB2, T2, TP33	153	212	240	25 kg	100 kg	B	40
	Sounding devices, explosive	1.2F	UN0204	II	1.2F	None	62	62	Forbidden	Forbidden	05	25
	Sounding devices, explosive	1.1F	UN0296	II	1.1F	None	62	62	Forbidden	Forbidden	05	25
	Sounding devices, explosive	1.1D	UN0374	II	1.1D	None	62	62	Forbidden	Forbidden	04	25
	Spirits of salt, see Hydrochloric acid	1.2D	UN0375	II	1.2D	None	62	62	Forbidden	Forbidden	04	25
	Squibs, see Igniters, etc												
	Stannic chloride, anhydrous	8	UN1827	II	8	B2, IB2, T7, TP2	154	202	242	1 L	30 L	C	
	Stannic chloride pentahydrate	8	UN2440	III	8	IB8, IP3, T1, TP33	154	213	240	25 kg	100 kg	A	
	Stannic phosphide	4.3	UN1433	I	4.3, 6.1	A19, N40	None	211	242	Forbidden	15 kg	E	40, 52, 85
	Steel swarf, see Ferrous metal borings, etc												
	Stribine	2.3	UN2676		2.3, 2.1	1	None	304	None	Forbidden	Forbidden	D	40
	Storage batteries, wet, see Batteries, wet, etc												
	Strontium arsenite	6.1	UN1691	II	6.1	IB8, IP2, IP4, T3, TP33	153	212	242	25 kg	100 kg	A	56, 58
	Strontium chlorate	5.1	UN1506	II	5.1	A1, A9, IB8, IP2, IP4, N34, T3, TP33	152	212	242	5 kg	25 kg	A	
	Strontium nitrate	5.1	UN1507	III	5.1	A1, A29, IB8, IP3, T1, TP33	152	213	240	25 kg	100 kg	A	
	Strontium perchlorate	5.1	UN1508	II	5.1	IB6, IP2, T3, TP33	152	212	242	5 kg	25 kg	A	56, 58

Pipeline and Haz. Matls. Safety Admin., DOT

§ 172.101

	Strontium peroxide	5.1	UN1509	II	5.1	IB6, IP2, T3, TP33	152	212	242	5 kg	25 kg	A	13, 52, 66, 75, 40, 52, 85, 40
	Strontium phosphide	4.3	UN2013	I	4.3, 6.1	A19, N40	None	211	None	Forbidden	15 kg	E	
	Strychnine or Strychnine salts Styphnic acid, <i>see</i> Trinitroresorcinol, <i>etc</i>	6.1	UN1692	I	6.1	IB7, IP1, T6, TP33	None	211	242	5 kg	50 kg	A	
G	Styrene monomer, stabilized Substances, explosive, n.o.s	3 1.1L	UN2055 UN0357	III II	3 1.1L	B1, IB3, T2, TP1 101	150 None	203 62	242 None	60 L Forbidden	220 L Forbidden	A 05	25, 14E, 15E, 25, 14E, 15E, 25, 14E, 15E
G	Substances, explosive, n.o.s	1.2L	UN0358	II	1.2L	101	None	62	None	Forbidden	Forbidden	05	
G	Substances, explosive, n.o.s	1.3L	UN0359	II	1.3L	101	None	62	None	Forbidden	Forbidden	05	
G	Substances, explosive, n.o.s	1.1A	UN0473	II	1.1A	101, 111	None	62	None	Forbidden	Forbidden	05	25
G	Substances, explosive, n.o.s	1.1C	UN0474	II	1.1C	101	None	62	None	Forbidden	Forbidden	04	25
G	Substances, explosive, n.o.s	1.1D	UN0475	II	1.1D	101	None	62	None	Forbidden	Forbidden	04	25
G	Substances, explosive, n.o.s	1.1G	UN0476	II	1.1G	101	None	62	None	Forbidden	Forbidden	03	25
G	Substances, explosive, n.o.s	1.3C	UN0477	II	1.3C	101	None	62	None	Forbidden	Forbidden	04	25
G	Substances, explosive, n.o.s	1.3G	UN0478	II	1.3G	101	None	62	None	Forbidden	Forbidden	03	25
G	Substances, explosive, n.o.s	1.4C	UN0479	II	1.4C	101	None	62	None	Forbidden	75 kg	02	25
G	Substances, explosive, n.o.s	1.4D	UN0480	II	1.4D	101	None	62	None	Forbidden	75 kg	02	25
G	Substances, explosive, n.o.s	1.4S	UN0481	II	1.4S	101	None	62	None	25 kg	75 kg	01	25
G	Substances, explosive, n.o.s	1.4G	UN0485	II	1.4G	101	None	62	None	Forbidden	75 kg	02	25
G	Substances, explosive, very insensitive, n.o.s. or Substances, EVI, n.o.s	1.5D	UN0482	II	1.5D	101	None	62	None	Forbidden	Forbidden	03	25
G	Substances, explosive, very insensitive, n.o.s. or Substances, EVI, n.o.s	1.5D	UN0482	II	1.5D	101	None	62	None	Forbidden	Forbidden	3	25
	Substituted nitrophenol pesticides, liquid, flammable, toxic, flash point less than 23 degrees C	3	UN2780	I	3, 6.1	T14, TP2, TP13, TP27	None	201	243	Forbidden	30 L	B	40
	Substituted nitrophenol pesticides, liquid, toxic	6.1	UN3014	I	6.1	IB2, T11, TP2, TP13, TP27	150	202	243	1 L	60 L	B	40
	Substituted nitrophenol pesticides, liquid, toxic, flammable, flash point not less than 23 degrees C	6.1	UN3013	III	6.1, 3	T14, TP2, TP13, TP27	None	201	243	1 L	30 L	B	40
	Substituted nitrophenol pesticides, liquid, toxic, flammable, flash point not less than 23 degrees C	6.1	UN3013	I	6.1, 3	IB2, T11, TP2, TP13, TP27	153	202	243	5 L	60 L	B	40
	Substituted nitrophenol pesticides, liquid, toxic, flammable, flash point not less than 23 degrees C	6.1	UN3013	III	6.1, 3	B1, IB3, T7, TP2, TP28	153	203	242	60 L	220 L	A	40

§ 172.101 HAZARDOUS MATERIALS TABLE—Continued

(1) Sym-bols	(2) Hazardous materials descriptions and proper shipping names	(3) Hazard class or Division	(4) Identi-fication Numbers	(5) PG	(6) Label Codes	(7) Special provisions (§ 172.102)	(8) Packaging (§ 173.***)			(9) Quantity limitations (see §§ 173.27 and 175.75)		(10) Vessel stowage				
							Excep-tions (8A)	Non-bulk (8B)	Bulk (8C)	Passenger aircraft/rail (9A)	Cargo air-craft only (9B)	Loca-tion (10A)	Other (10B)			
D I +	Substituted nitrophenol pesticides, solid, toxic Sucrose octanitrate (dry) Sulfamic acid Sulfur Sulfur Sulfur and chlorate, loose mixtures of Sulfur chlorides Sulfur dichloride, see Sulfur chlorides Sulfur dioxide Sulfur dioxide solution, see Sulfurous acid Sulfur hexafluoride Sulfur, molten Sulfur, molten Sulfur tetrafluoride Sulfur trioxide, stabilized Sulfuretted hydrogen, see Hydrogen sulfide Sulfuric acid, fuming with less than 30 percent free sulfur trioxide Sulfuric acid, fuming with 30 percent or more free sulfur trioxide	6.1	UN2779	I	6.1	IB7, IP1, T6, TP33	None	211	242	5 kg	50 kg	A	40			
		Forbidden	II		II	6.1	IB8, IP2, IP4, T3, TP33	153	212	242	25 kg	100 kg	A	40		
			III		III	6.1	IB8, IP3, T1, TP33	153	213	240	100 kg	200 kg	A	40		
		Forbidden	III	UN2967	III	8	8	IB8, IP3, T1, TP33	154	213	240	25 kg	100 kg	A	25, 74	
			III	9	NA1350	III	9	30, B120, IB8, IP2	None	None	240	No Limit	No Limit	A	25, 74	
			III	4.1	UN1350	III	4.1	30, B120, IB8, IP3, T1, TP33	None	None	240	25 kg	100 kg	A	25, 74	
				Forbidden												
				8	UN1828	I	8	5, A3, A7, A10, B10, B77, N34, T20, TP2	None	201	243	Forbidden	2.5 L	Forbidden	C	40
				2.3	UN1079		2.3, 8	3, B14, T50, TP19	None	304	314, 315	Forbidden	Forbidden	Forbidden	D	40
				2.2	UN1080		2.2		306	304	314, 315	75 kg	150 kg	Forbidden	A	61
9	NA2448			III	9	30, B13, IB3, R1, T1, TP3	None	213	247	Forbidden	Forbidden	Forbidden	C	74		
4.1	UN2448			III	4.1	30, B13, IB1, R1, T1, TP3	None	213	247	Forbidden	Forbidden	Forbidden	C	74		
2.3	UN2418				2.3, 8	2, B9, B14, B32, B49, B77, N34, T20, TP4, TP13, TP25, TP26, TP38, TP45	None	302	245	Forbidden	Forbidden	Forbidden	D	40, 52		
8	UN1829			I	8, 6.1		None	227	244	Forbidden	Forbidden	Forbidden	A	40		
8	UN1831			I	8	A3, A7, N34, T20, TP2, TP13	None	201	243	Forbidden	2.5 L	Forbidden	C	14, 40		
8	UN1831			I	8, 6.1	2, B9, B14, B32, B77, B84, N34, T20, TP2, TP12, TP13	None	227	244	Forbidden	Forbidden	Forbidden	C			

Sulfuric acid, spent	8	UN1832	II	8	A3, A7, B2, B83, B84, IB2, N34, T8, TP2	None	202	242	Forbiddn	30 L	C	14
Sulfuric acid with more than 51 percent acid	8	UN1830	II	8	A3, A7, B3, B83, B84, IB2, N34, T8, TP2	154	202	242	1 L	30 L	C	14
Sulfuric acid with not more than 51% acid	8	UN2796	II	8	A3, A7, B2, B15, IB2, N6, N34, T8, TP2	154	202	242	1 L	30 L	B	
Sulfuric and hydrofluoric acid mixtures, see Hydrofluoric and sulfuric acid mixtures												
Sulfuric anhydride, see Sulfur trioxide, stabilized												
Sulfurous acid	8	UN1833	II	8	B3, IB2, T7, TP2	154	202	242	1 L	30 L	B	40
Sulfuryl chloride	6.1	UN1834	I	6.1, 8	1, B6, B9, B10, B14, B30, B77, N34, T22, TP2, TP13, TP38, TP44	None	226	244	Forbiddn	Forbiddn	D	40
Sulfuryl fluoride	2.3	UN2191		2.3		None	304	314, 315	Forbiddn	Forbiddn	D	40
Tars, liquid including road oils and cutback bitumens	3	UN1999	II	3	149, B13, IB2, T3, TP3, TP29	150	202	242	5 L	60 L	B	
Tear gas candles	6.1	UN1700	II	6.1, 4.1	B1, B13, IB3, T1, TP3	None	203	242	60 L	220 L	A	40
Tear gas cartridges, see Ammunition, tear-producing, etc												
Tear gas devices with more than 2 percent tear gas substances, by mass	6.1	NA1693	I	6.1		None	340	None	Forbiddn	Forbiddn	D	40
Tear gas devices, with not more than 2 percent tear gas substances, by mass, see Aerosols, etc												
Tear gas grenades, see Tear gas candles												
Tear gas substances, liquid, n.o.s.	6.1	UN1693	I	6.1		None	201	None	Forbiddn	Forbiddn	D	40
Tear gas substance, solid, n.o.s.	6.1	UN3448	II	6.1	IB2	None	202	None	Forbiddn	5 L	D	40
Tellurium compound, n.o.s	6.1	UN3284	II	6.1	T6, TP33	None	211	242	Forbiddn	Forbiddn	D	40
Tellurium hexafluoride	6.1	UN3284	I	6.1	IB8, IP2, IP4, T3, TP33	None	212	242	Forbiddn	25 kg	D	40
Terpene hydrocarbons, n.o.s.	6.1	UN3284	I	6.1	IB7, IP1, T6, TP33	None	211	242	5 kg	50 kg	B	
Terpinolene	6.1	UN3284	II	6.1	IB8, IP2, IP4, T3, TP33	153	212	242	25 kg	100 kg	B	
Tetraazido benzene quinone	2.3	UN2195	III	6.1	IB8, IP3, T1, TP33	153	213	240	100 kg	200 kg	A	40
Tetrabromoethane	3	UN2319	III	2.3, 8	B1, IB3, T4, TP1, TP29	None	302	None	Forbiddn	Forbiddn	D	
1,1,2,2-tetrachloroethane	6.1	UN1702	III	3	B1, IB3, T2, TP1	150	203	242	60 L	220 L	A	
Tetrachloroethylene	6.1	UN1897	III	3		150	203	242	60 L	220 L	A	
Tetraethyl dithiopyrophosphate	6.1	UN1704	III	6.1	IB3, T4, TP1	153	212	242	25 kg	100 kg	D	40
Tetraethyl silicate	3	UN1292	III	3	B1, IB3, T2, TP1	150	203	242	60 L	220 L	A	

+

D

G

G

G

§ 172.101 HAZARDOUS MATERIALS TABLE—Continued

(1) Sym-bols	(2) Hazardous materials descriptions and proper shipping names	(3) Hazard class or Division	(4) Identi-fication Numbers	(5) PG	(6) Label Codes	(7) Special provisions (§ 172.102)	(8) Packaging (§ 173.***)			(9) Quantity limitations (see §§ 173.27 and 175.75)		(10) Vessel stowage	
							Excep-tions	Non-bulk	Bulk	Passenger aircraft/rail	Cargo air-craft only	Loca-tion	Other
(1)	(2)	(3)	(4)	(5)	(6)	(7)	(8A)	(8B)	(8C)	(9A)	(9B)	(10A)	(10B)
	<i>Tetraethylammonium perchlorate (dry)</i>	Forbidden											
	Tetraethylenepentamine	8	UN2320		8			203	241	5 L	60 L	A	52.
	1,1,1,2-Tetrafluoroethane or Refrigerant gas R 134a	2.2	UN3159		2.2	IB3, T4, TP1 T50	306	304	314, 315	75 kg	150 kg	A	
	Tetrafluoroethylene, stabilized	2.1	UN1081		2.1		306	304	None	Forbidden	150 kg	E	40
	Tetrafluoromethane or Refrigerant gas R 14	2.2	UN1982		2.2		None	302	None	75 kg	150 kg	A	
	1,2,3,6-Tetrahydrobenzaldehyde	3	UN2498		3	B1, IB3, T2, TP1	150	203	242	60 L	220 L	A	
	Tetrahydrofuran	3	UN2056		3	IB2, T4, TP1	None	202	242	5 L	60 L	B	
	Tetrahydrofurfurylamine	3	UN2943		3	B1, IB3, T2, TP1	150	203	242	60 L	220 L	A	
	Tetrahydrophthalic anhydrides with more than 0.05 percent of maleic anhydride	8	UN2698		8	IB8, IP3, T1, TP33	154	213	240	25 kg	100 kg	A	
	1,2,3,6-Tetrahydropyridine	3	UN2410		3	IB2, T4, TP1	150	202	242	5 L	60 L	B	
	Tetrahydrothiophene	3	UN2412		3	IB2, T4, TP1	150	202	242	5 L	60 L	B	
	Tetramethylammonium hydroxide, solid	8	UN3423		8	B2, IB8, IP2, IP4, T3, TP33	154	213	240	15 kg	50 kg	A	52
	Tetramethylammonium hydroxide solution	8	UN1835		8	B2, IB2, T7, TP2	154	202	242	1 L	30 L	A	52
	<i>Tetramethylene diperoxide dicarbamide</i>	Forbidden			8	B2, IB3, T7, TP2	154	203	241	5 L	60 L	A	52
	Tetramethylsilane	3	UN2749		3	A7, T14, TP2	None	201	243	Forbidden	30 L	D	
	<i>Tetranitro diglycerin</i>	Forbidden											
	Tetranitroaniline	1.1D	UN0207		1.1D		None	62	None	Forbidden	Forbidden	04	25
	Tetranitromethane	6.1	UN1510		6.1, 5.1	2, B32, T20, TP2, TP13, TP38, TP44	None	227	None	Forbidden	Forbidden	D	40, 6
+	2,3,4,6-Tetranitrophenol	Forbidden											
	2,3,4,6-Tetranitrophenyl methyl nitramine	Forbidden											
	2,3,4,6-Tetranitrophenylnitramine	Forbidden											
	Tetranitrosarcinol (dry)	Forbidden											
	2,3,5,6-Tetranitroso-1,4-dinitrobenzene	Forbidden											
	2,3,5,6-Tetranitroso nitrobenzene (dry)	Forbidden											
	Tetrapropylthiothianate	3	UN2413		3	B1, IB3, T4, TP1	150	203	242	60 L	220 L	A	

Chemical Name	UN Number	Class	1.4C 1.1D	1.4C 1.1D	None	62 62	None	None	Forbiddn Forbiddn	75 kg Forbiddn	02 04	25 25, 5E
Tetrazene, <i>see</i> Guanyl nitrosaminoquanyltetrazene												
Tetrazine (dry)	UN0407	Forbiddn	1.4C	1.4C	None	213	151		Forbiddn	25 kg	A	56, 58
Tetrazol-1-acetic acid	UN0504	Forbiddn	1.1D	1.1D	None	212	152		Forbiddn	25 kg	A	
1H-tetrazole												
Tetrazolyl azide (dry)												
Tetryl, <i>see</i> Trinitrophenylmethylnitramine												
Textile waste, wet	UN1857	4.2	4.2	4.2	151	213	151		Forbiddn	25 kg	A	56, 58
Thallium chlorate	UN2573	5.1	5.1	5.1	152	212	152		Forbiddn	25 kg	A	
Thallium compounds, n.o.s	UN1707	6.1	6.1	6.1	153	212	153		25 kg	100 kg	A	
Thallium nitrate	UN2727	6.1	6.1	6.1	153	212	153		5 kg	25 kg	A	
4-Thiapentanal	UN2785	6.1	6.1	6.1	153	203	153		60 L	220 L	D	25, 49
Thioacetic acid	UN2436	3	3	3	150	202	150		5 L	60 L	B	40
Thiocarbamate pesticide, liquid, flammable, toxic, flash point less than 23 degrees C	UN2772	3	3, 6.1	3, 6.1	None	201	None		Forbiddn	30 L	B	
Thiocarbamate pesticide, liquid, toxic, flammable, flash point not less than 23 degrees C	UN3005	6.1	3, 6.1 6.1, 3	3, 6.1 6.1, 3	150	202	150		1 L	60 L	B	40
Thiocarbamate pesticide, liquid, toxic	UN3006	6.1	6.1, 3 6.1	6.1, 3 6.1	153	203	153		1 L	30 L	B	40
Thiocarbamate pesticides, solid, toxic	UN2771	6.1	6.1 6.1	6.1 6.1	153	202	153		5 L	60 L	B	40
Thiocarbonylchloride, <i>see</i> Thiophosgene												
Thioglycol	UN2966	6.1	6.1	6.1	153	202	153		5 L	60 L	A	40
Thioglycolic acid	UN1940	8	8	8	154	202	154		1 L	30 L	A	40
Thiolactic acid	UN2936	6.1	6.1	6.1	153	202	153		5 L	60 L	A	40
Thionyl chloride	UN1836	8	8	8	None	201	None		Forbiddn	Forbiddn	C	40
Thiophene	UN2414	3	3	3	150	202	150		5 L	60 L	B	40
Thiophosgene	UN2474	6.1	6.1	6.1	None	227	None		Forbiddn	Forbiddn	D	40, 52
Thiophosphoryl chloride	UN1837	8	8	8	None	202	None		Forbiddn	30 L	C	40
Thiourea dioxide	UN3341	4.2	4.2	4.2	None	212	None		15 kg	50 kg	D	

§ 172.101 HAZARDOUS MATERIALS TABLE—Continued

(1) Sym-bols	(2) Hazardous materials descriptions and proper shipping names	(3) Hazard class or Division	(4) Identi-fication Numbers	(5) PG	(6) Label Codes	(7) Special provisions (§ 172.102)	(8) Packaging (§ 173.***)			(9) Quantity limitations (see §§ 173.27 and 175.75)		(10) Vessel stowage	
							Excep-tions (8A)	Non-bulk (8B)	Bulk (8C)	Passenger aircraft/rail (9A)	Cargo air-craft only (9B)	Loca-tion (10A)	Other (10B)
	<i>Tin chloride, fuming, see Stannic chloride, anhydrous</i> <i>Tin perchloride or Tin tetrachloride, see Stannic chloride, anhydrous</i> Tinctures, medicinal <i>Tinning flux, see Zinc chloride</i> Tires and tire assemblies, see Air, compressed or Nitrogen, com-pressed												
	Titanium disulphide	4.2	UN3174	III	4.2	IB8, IP3, T1, TP33	None	213	241	25 kg	100 kg	D	
	Titanium hydride	4.1	UN1871	II	4.1	IB2, T4, TP1, TP8 B1, IB3, T2, TP1	None	202 203	242 242	5 L 60 L	60 L 220 L	B A	
	Titanium powder, dry	4.2	UN2546	I II	4.2 4.2	IB8, IP3, T1, TP33 A19, A20, IB4, N34, T3, TP33	None None	213 212	241 241	25 kg 15 kg	100 kg 50 kg	A E	
	Titanium powder, wetted with not less than 25 percent water (a visible excess of water must be present) (a) mechanically pro-duced, particle size less than 53 microns; (b) chemically produced, particle size less than 840 mi-crons	4.1	UN1352	III II	4.2 4.1	A19, A20, IB6, IP2, N5, N34, T3, TP33 IB8, IP3, T1, TP33 A19, A20, IB6, IP2, N34, T3, TP33	None None	211 212	242 241	Forbidden 15 kg	Forbidden 50 kg	D D	
	Titanium sponge granules or Tita-nium sponge powders	4.1	UN2878	III	4.1	A1, IB8, IP3, T1, TP33	None	213	240	25 kg	100 kg	D	74
+	Titanium tetrachloride	6.1	UN1838	I	6.1, 8	2, B7, B9, B14, B32, B77, T20, TP2, TP13, TP38, TP45	None	227	244	Forbidden	Forbidden	D	40
	Titanium trichloride mixtures	8	UN2869	II	8	A7, IB8, IP2, IP4, N34, T3, TP33	154	212	240	15 kg	50 kg	A	40
	Titanium trichloride, pyrophoric or Titanium trichloride mixtures, pyrophoric	4.2	UN2441	I	4.2, 8	A7, IB8, IP3, N34, T1, TP33 N34	None	181	244	Forbidden	Forbidden	D	40

§ 172.101 HAZARDOUS MATERIALS TABLE—Continued

(1) Sym-bols	(2) Hazardous materials descriptions and proper shipping names	(3) Hazard class or Division	(4) Identi-fication Numbers	(5) PG	(6) Label Codes	(7) Special provisions (§ 172.102)	(8) Packaging (§ 173.***)			(9) Quantity limitations (see §§ 173.27 and 175.75)		(10) Vessel stowage	
							Excep-tions (8A)	Non-bulk (8B)	Bulk (8C)	Passenger aircraft/rail (9A)	Cargo air-craft only (9B)	Loca-tion (10A)	Other (10B)
G	Toxic by inhalation liquid, flammable, n.o.s. with an LC50 lower than or equal to 1000 ml/m ³ and saturated vapor concentration greater than or equal to 10 LC50	6.1	UN3384	I	6.1, 3	2, B9, B14, B32, T20, TP2, TP13, TP27, TP38, TP45	None	227	244	Forbidden	Forbidden	D	40
G	Toxic by inhalation liquid, water-re-active, n.o.s. with an LC50 lower than or equal to 200 ml/m ³ and saturated vapor concentration greater than or equal to 500 LC50	6.1	UN3385	I	6.1, 4.3	1, B9, B14, B30, T22, TP2, TP13, TP38, TP44	None	226	244	Forbidden	Forbidden	D	40
G	Toxic by inhalation liquid, water-re-active, n.o.s. with an LC50 lower than or equal to 1000 ml/m ³ and saturated vapor concentration greater than or equal to 10 LC50	6.1	UN3386	I	6.1, 4.3	2, B9, B14, B32, T20, TP2, TP13, TP38, TP44	None	227	244	Forbidden	Forbidden	D	40
G	Toxic by inhalation liquid, water-re-active, flammable, n.o.s. with an LC50 lower than or equal to 200 ml/m ³ and saturated vapor concentration greater than or equal to 500 LC50	6.1	UN3490	I	6.1, 4.3, 3	1, B9, B14, B30, T22, TP2, TP13, TP27, TP38, TP44	None	226	244	Forbidden	Forbidden	D	21, 28, 40, 49
G	Toxic by inhalation liquid, water-re-active, flammable, n.o.s. with an LC50 lower than or equal to 1000 ml/m ³ and saturated vapor concentration greater than or equal to 10 LC50	6.1	UN3491	I	6.1, 4.3, 3	2, B9, B14, B32, T20, TP2, TP13, TP27, TP38, TP45	None	227	244	Forbidden	Forbidden	D	21, 28, 40, 49
G	Toxic by inhalation liquid, oxidizing, n.o.s. with an LC50 lower than or equal to 200 ml/m ³ and saturated vapor concentration greater than or equal to 500 LC50	6.1	UN3387	I	6.1, 5.1	1, B9, B14, B30, T22, TP2, TP13, TP38, TP44	None	226	244	Forbidden	Forbidden	D	40

G	Toxic by inhalation liquid, oxidizing, n.o.s. with an LC50 lower than or equal to 1000 ml/m ³ and saturated vapor concentration greater than or equal to 10 LC50	6.1	UN3388	I	6.1, 5.1	2, B9, B14, B32, T20, TP2, TP13, TP38, TP44	None	227	244	Forbidden	Forbidden	D	40
G	Toxic by inhalation liquid, corrosive, n.o.s. with an LC50 lower than or equal to 200 ml/m ³ and saturated vapor concentration greater than or equal to 500 LC50	6.1	UN3389	I	6.1, 8	1, B9, B14, B30, T22, TP2, TP13, TP27, TP38, TP44	None	226	244	Forbidden	Forbidden	D	40
G	Toxic by inhalation liquid, corrosive, n.o.s. with an LC50 lower than or equal to 1000 ml/m ³ and saturated vapor concentration greater than or equal to 10 LC50	6.1	UN3390	I	6.1, 8	2, B9, B14, B32, T20, TP2, TP13, TP27, TP38, TP45	None	227	244	Forbidden	Forbidden	D	40
G	Toxic liquid, corrosive, inorganic, n.o.s.	6.1	UN3289	I	6.1, 8	T14, TP2, TP13, TP27	None	201	243	0.5 L	2.5 L	A	40
G	Toxic liquid, inorganic, n.o.s.	6.1	UN3287	II	6.1, 8	IB2, T11, TP2, TP27	153	202	243	1 L	30 L	A	40
G	Toxic liquids, corrosive, organic, n.o.s.	6.1	UN2927	III	6.1, 8	T14, TP2, TP13, TP27	None	201	243	1 L	30 L	A	40
G	Toxic liquids, corrosive, organic, n.o.s.	6.1	UN2927	III	6.1, 8	IB2, T11, TP2, TP27	153	202	243	5 L	60 L	A	40
G	Toxic liquids, corrosive, organic, n.o.s.	6.1	UN2927	III	6.1, 8	IB3, T7, TP1, TP28	153	203	241	60 L	220 L	A	40
G	Toxic liquids, flammable, organic, n.o.s.	6.1	UN2929	I	6.1, 3	IB2, T11, TP2, TP27	153	202	243	1 L	30 L	B	40
G	Toxic liquids, flammable, organic, n.o.s.	6.1	UN2929	I	6.1, 3	T14, TP2, TP13, TP27	None	201	243	1 L	30 L	B	40
G	Toxic liquids, organic, n.o.s.	6.1	UN2810	I	6.1	IB2, T11, TP2, TP13, TP27	153	202	243	5 L	60 L	B	40
G	Toxic liquids, organic, n.o.s.	6.1	UN2810	II	6.1	T14, TP2, TP13, TP27	None	201	243	1 L	30 L	B	40
G	Toxic liquids, oxidizing, n.o.s.	6.1	UN3122	III	6.1	IB2, T11, TP2, TP13, TP27	153	202	243	5 L	60 L	B	40
G	Toxic liquids, oxidizing, n.o.s.	6.1	UN3122	I	6.1, 5.1	IB3, T7, TP1, TP28	153	203	241	60 L	220 L	A	40
G	Toxic liquids, water-reactive, n.o.s.	6.1	UN3123	I	6.1, 4.3	A4	None	201	243	Forbidden	2.5 L	C	40
G	Toxic solid, corrosive, inorganic, n.o.s.	6.1	UN3290	II	6.1, 4.3	IB2	153	202	243	1 L	5 L	C	40
G	Toxic solid, corrosive, inorganic, n.o.s.	6.1	UN3290	I	6.1, 8	A4	None	201	243	Forbidden	1 L	E	40
G	Toxic solid, inorganic, n.o.s.	6.1	UN3288	II	6.1, 8	IB2	None	202	243	1 L	5 L	E	40
G	Toxic solid, inorganic, n.o.s.	6.1	UN3288	II	6.1, 8	IB7, T6, TP33	None	211	242	1 kg	25 kg	A	40
G	Toxic solids, corrosive, organic, n.o.s.	6.1	UN2928	I	6.1, 8	IB6, IP2, T3, TP33	153	212	242	15 kg	50 kg	A	40
G	Toxic solids, corrosive, organic, n.o.s.	6.1	UN2928	II	6.1, 8	IB7, T6, TP33	153	211	242	5 kg	50 kg	A	40
G	Toxic solids, corrosive, organic, n.o.s.	6.1	UN2928	III	6.1	IB8, IP2, T3, TP33	153	212	242	25 kg	100 kg	A	40
G	Toxic solids, corrosive, organic, n.o.s.	6.1	UN2928	III	6.1	IB8, IP3, T1, TP33	153	213	240	100 kg	200 kg	A	40
G	Toxic solids, corrosive, organic, n.o.s.	6.1	UN2928	I	6.1, 8	IB7, T6, TP33	None	211	242	1 kg	25 kg	B	40
G	Toxic solids, corrosive, organic, n.o.s.	6.1	UN2928	II	6.1, 8	IB6, IP2, T3, TP33	153	212	242	15 kg	50 kg	B	40

§ 172.101 HAZARDOUS MATERIALS TABLE—Continued

(1) Sym-bols	(2) Hazardous materials descriptions and proper shipping names	(3) Hazard class or Division	(4) Identi-fication Numbers	(5) PG	(6) Label Codes	(7) Special provisions (§ 172.102)	(8) Packaging (§ 173.***)			(9) Quantity limitations (see §§ 173.27 and 175.75)		(10) Vessel stowage	
							Excep-tions (8A)	Non-bulk (8B)	Bulk (8C)	Passenger aircraft/rail (9A)	Cargo air-craft only (9B)	Loca-tion (10A)	Other (10B)
G	Toxic solids, flammable, organic, n.o.s.	6.1	UN2930	I	6.1, 4.1	IB6, T6, TP33	None	211	242	1 kg	15 kg	B	
				II	6.1, 4.1	IB8, IP2, IP4, T3, TP33	153	212	242	15 kg	50 kg	B	
G	Toxic solids, organic, n.o.s.	6.1	UN2811	I	6.1	IB7, T6, TP33	None	211	242	5 kg	50 kg	B	
				II	6.1	IB8, IP2, IP4, T3, TP33	153	212	242	25 kg	100 kg	B	
				III	6.1	IB8, IP3, T1, TP33	153	213	240	100 kg	200 kg	A	
G	Toxic solids, oxidizing, n.o.s.	6.1	UN3086	I	6.1, 5.1	T6, TP33	None	211	242	1 kg	15 kg	C	
				II	6.1, 5.1	IB6, IP2, T3, TP33	153	212	242	15 kg	50 kg	C	
G	Toxic solids, self-heating, n.o.s.	6.1	UN3124	I	6.1, 4.2	A5, T6, TP33	None	211	242	5 kg	15 kg	D	40
				II	6.1, 4.2	IB6, IP2, T3, TP33	None	212	242	15 kg	50 kg	D	40
G	Toxic solids, water-reactive, n.o.s.	6.1	UN3125	I	6.1, 4.3	A5, T6, TP33	None	211	242	5 kg	15 kg	D	40
				II	6.1, 4.3	IB6, IP2, T3, TP33	153	212	242	15 kg	50 kg	D	40
G	Toxins, extracted from living sources, liquid, n.o.s.	6.1	UN3172	I	6.1	141	None	201	243	1 L	30 L	B	40
				II	6.1	141, IB2	None	202	243	5 L	60 L	B	40
				III	6.1	141, IB3	153	203	241	60 L	220 L	B	40
G	Toxins, extracted from living sources, solid, n.o.s.	6.1	UN3462	I	6.1	141, IB7, IP1, T6, TP33	None	211	243	5 kg	50 kg	B	
				II	6.1	141, IB8, IP2, IP4, T3 TP33	None	212	243	25 kg	100 kg	B	
D	Toy Caps	1.4S	NA0337	III	6.1	141, IB8, IP3, T1 TP33	153	213	241	100 kg	200 kg	A	25
	Tracers for ammunition	1.3G	UN0212	II	1.4S	None	62	None	25 kg	100 kg	01	25
	Tracers for ammunition	1.4G	UN0306	II	1.3G	None	62	None	Forbidden	Forbidden	03	25
	Tractors, see Vehicle, etc			II	1.4G	None	62	None	Forbidden	Forbidden	02	25
	Tri-(b-nitroxyethyl) ammonium ni-trate	Forbidden											
	Triallyl borate	6.1	UN2609	III	6.1	IB3	153	203	241	60 L	220 L	A	13
	Triallylamine	3	UN2610	III	3, 8	B1, IB3, T4, TP1	None	203	242	5 L	60 L	A	40

UN number	Proper shipping name	Class	Division	Subdivision	Special provisions	Quantity	Label	Other	Quantity	Label	Other
3 UN2764	Triazine pesticides, liquid, flammable, toxic, flash point less than 23 degrees C	I	3, 6.1		T14, TP2, TP13, TP27	None	201	243	30 L	B	40
6.1 UN2998	Triazine pesticides, liquid, toxic	II	3, 6.1		IB2, T11, TP2, TP13, TP27	150	202	243	60 L	B	40
6.1 UN2997	Triazine pesticides, liquid, toxic, flammable, flash point not less than 23 degrees C	I	6.1, 3		T14, TP2, TP13, TP27	None	201	243	30 L	B	40
6.1 UN2763	Triazine pesticides, solid, toxic	III	6.1, 3		IB3, T7, TP2, TP28	153	203	241	220 L	A	40
6.1 UN2542	Tributylamine	I	6.1, 3		T14, TP2, TP13, TP27	None	201	243	30 L	B	40
4.2 UN3254	Tributylphosphane	I	4.2		T21, TP7, TP33	None	211	242	Forbiddn	D	136
8 UN1839	Trichloro-s-triazinetriene, dry, with more than 39 percent available chlorine, see Trichloroisocyanuric acid, dry	II	8		A7, IB8, IP2, IP4, N34, T3, TP33	154	212	240	15 kg	A	40
8 UN2564	Trichloroacetic acid, solution	II	8		A3, A6, A7, B2, IB2, N34, T7, TP2	154	202	242	30 L	B	40
8 UN2442	Trichloroacetyl chloride	III	8		A3, A6, A7, IB3, N34, T4, TP1	154	203	241	60 L	B	8
6.1 UN2321	Trichlorobenzenes, liquid	III	6.1		2, B9, B14, B32, N34, T20, TP2, TP38, TP45	None	227	244	Forbiddn	D	40
6.1 UN2322	Trichlorobutene	III	6.1		IB3, T4, TP1	153	203	241	220 L	A	25, 40
6.1 UN2831	1,1,1-Trichloroethane	III	6.1		IB2, T7, TP2	153	202	243	60 L	A	40
6.1 UN1710	Trichloroethylene	III	6.1		IB3, N36, T4, TP1	153	203	241	220 L	A	40
5.1 UN2468	Trichloroisocyanuric acid, dry	II	5.1		IB3, N36, T4, TP1	153	203	241	220 L	A	40
4.3 UN1295	Trichloromethyl perchlorate	I	4.3, 3, 8		IB8, IP2, IP4, T3, TP33	152	212	240	25 kg	A	13
6.1 UN2574	Tricresyl phosphate with more than 3 percent ortho isomer	II	6.1		N34, T14, TP2, TP7, TP13	None	201	244	Forbiddn	D	21, 28, 40, 49, 100
3 UN2323	Triethyl phosphite	III	3		A3, IB2, N33, N34, T7, TP2	153	202	243	60 L	A	40
3 UN1296	Triethylamine	III	3, 8		B1, IB3, T2, TP1	150	202	242	220 L	A	40
8 UN2259	Triethylenetetramine	II	8		B2, IB2, T7, TP2	154	202	242	30 L	B	40, 52
8 UN2699	Trifluoroacetic acid	I	8		A3, A6, A7, B4, N3, N34, N36, T10, TP2	None	201	243	0.5 L	B	12, 40
2.3 UN3057	Trifluoroacetyl chloride	I	2.3, 8		2, B7, B9, B14, T50, TP21	None	304	314, 315	Forbiddn	D	40

+

§ 172.101 HAZARDOUS MATERIALS TABLE—Continued

(1) Sym-bols	(2) Hazardous materials descriptions and proper shipping names	(3) Hazard class or Division	(4) Identi-fication Numbers	(5) PG	(6) Label Codes	(7) Special provisions (§ 172.102)	(8) Packaging (§ 173.***)			(9) Quantity limitations (see §§ 173.27 and 175.75)		(10) Vessel stowage	
							Excep-tions (8A)	Non-bulk (8B)	Bulk (8C)	Passenger aircraft/rail (9A)	Cargo air-craft only (9B)	Loca-tion (10A)	Other (10B)
D	Trifluorochloroethylene, stabilized	2.3	UN1082		2.3, 2.1	3, B14, T50	None	304	314, 315	Forbidden	Forbidden	D	40
	Trifluoromethane or Refrigerant gas R 23	2.2	UN1984		2.2		306	304	314, 315	75 kg	150 kg	A	
	Trifluoromethane, refrigerated liquid	2.2	UN3136		2.2	T75, TP5	306	None	314, 315	50 kg	500 kg	D	
	1,1,1-Trifluoroethane or Refrigerant gas, R 143a	2.1	UN2035		2.1	T50	306	304	314, 315	Forbidden	150 kg	B	40
	2-Trifluoromethylaniline	6.1	UN2942	III	6.1	IB3	153	203	241	60 L	220 L	A	
	3-Trifluoromethylaniline	6.1	UN2948	II	6.1	IB2, T7, TP2	153	202	243	5 L	60 L	A	40
	Trifluoromethane trinitrate	Forbidden											
	Trisobutylene	3	UN2324	III	3	B1, IB3, T4, TP1	150	203	242	60 L	220 L	A	
	Triisopropyl borate	3	UN2616	III	3	IB2, T4, TP1	150	202	242	5 L	60 L	A	
				III	3	B1, IB3, T2, TP1	150	203	242	60 L	220 L	A	
				I	6.1, 3	2, B9, B14, B32, T20, TP4, TP13, TP38, TP45	None	227	244	Forbidden	Forbidden	E	40
	Trimethoxysilane	6.1	NA9269		6.1, 3	2, B3, B9, B14, B32, N34, T20, TP2, TP13, TP38, TP45		202	242	5 L	60 L	B	
	Trimethyl borate	3	UN2416	II	3	IB2, T7, TP1	150	202	242	60 L	220 L	A	
	Trimethyl phosphite	3	UN2329	III	3	B1, IB3, T2, TP1	150	203	242	60 L	220 L	A	
	1,3,5-Trimethyl-2,4,6-trinitrobenzene	Forbidden											
Trimethylacetyl chloride	6.1	UN2438	I	6.1, 8, 3	2, B3, B9, B14, B32, N34, T20, TP2, TP13, TP38, TP45		227	244	Forbidden	Forbidden	D	25, 40	
Trimethylamine, anhydrous	2.1	UN1083		2.1	N87, T50	306	304	314, 315	Forbidden	150 kg	B	40	
Trimethylamine, aqueous solutions with not more than 50 percent trimethylamine by mass	3	UN1297	I	3, 8	T11, TP1	None	201	243	0.5 L	2.5 L	D	40, 135	
1,3,5-Trimethylbenzene	3	UN2325	III	3, 8	B1, IB2, T7, TP1	150	202	243	1 L	5 L	B	40, 41	
Trimethylchlorosilane	3	UN1298	III	3, 8	B1, IB3, T2, TP1	150	203	242	5 L	60 L	A	40, 41	
			II	3, 8	A3, A7, B77, N34, T10, TP2, TP7, TP13	None	206	243	Forbidden	5 L	E	40	
Trimethylcyclohexylamine	8	UN2326	III	8	IB3, T4, TP1	154	203	241	5 L	60 L	A		
Trimethylene glycol dipchlorate	Forbidden												
Trimethylhexamethylene diisocyanate	6.1	UN2328	III	6.1	IB3, T4, TP2, TP13	153	203	241	60 L	220 L	B		
Trimethylhexamethylenediamines	8	UN2327	III	8	IB3, T4, TP1	154	203	241	5 L	60 L	A		
Trimethylol nitromethane trinitrate	Forbidden												

Tritro-m-cresol	1.1D	UN0216	II	1.1D	None	62	None	Forbiddn	Forbiddn	04	25, 5E
2,4,6-Trinitro-1,3-diazobenzene	Forbiddn											
2,4,6-Trinitro-1,3,5-triazido benzene (dry)	Forbiddn											
Tritroacetic acid	Forbiddn											
Tritroacetoneitrile	Forbiddn											
Tritroamine cobalt	Forbiddn											
Tritroaniline or Picramide	1.1D	UN0153	II	1.1D	None	62	None	Forbiddn	Forbiddn	04	25
Tritroanisole	1.1D	UN0213	II	1.1D	None	62	None	Forbiddn	Forbiddn	04	25
Tritrobenzene, wetted, with not less than 10% water, by mass	4.1	UN3367	I	4.1	162, A8, A19, N41, N84	None	211	None	0.5 kg	0.5 kg	E	36
Tritrobenzene, dry or wetted with less than 30 percent water, by mass	1.1D	UN0214	II	1.1D	None	62	None	Forbiddn	Forbiddn	04	25
Tritrobenzene, dry or wetted with less than 30 percent water, by mass	1.1D	UN0214	II	1.1D	None	62	None	Forbiddn	Forbiddn	4	25
Tritrobenzenesulfonic acid	1.1D	UN0386	II	1.1D	None	62	None	Forbiddn	Forbiddn	04	25, 5E
Tritrobenzoic acid, dry or wetted with less than 30 percent water, by mass	1.1D	UN0215	II	1.1D	None	62	None	Forbiddn	Forbiddn	04	25
Tritrobenzoic acid, wetted with not less than 30 percent water, by mass	4.1	UN3368	I	4.1	162, A8, A19, N41, N84	None	211	None	0.5 kg	0.5 kg	E	36
Tritrochlorobenzene or Picryl chloride, wetted, with not less than 10% water by mass	4.1	UN1355	I	4.1	23, A2, A8, A19, N41	None	211	None	0.5 kg	0.5 kg	E	28
Tritroethanol	1.1D	UN0155	II	1.1D	None	62	None	Forbiddn	Forbiddn	04	25
Tritroethylnitrate	4.1	UN3365	I	4.1	162, A8, A19, N41, N84	None	211	None	0.5 kg	0.5 kg	E	36
Tritrofluorenone	Forbiddn											
Tritroformane	Forbiddn											
1,3,5-Trinitronaphthalene	Forbiddn											
Tritrophenetole	1.1D	UN0217	II	1.1D	None	62	None	Forbiddn	Forbiddn	04	25
Tritrophenol (picric acid), wetted, with not less than 10 percent water by mass	1.1D	UN0218	II	1.1D	None	62	None	Forbiddn	Forbiddn	04	25
Tritrophenol or Picric acid, dry or wetted with less than 30 percent water, by mass	4.1	UN3364	I	4.1	162, A8, A19, N41, N84	None	211	None	0.5 kg	0.5 kg	E	36
Tritrophenol, wetted with not less than 30 percent water, by mass	1.1D	UN0154	II	1.1D	None	62	None	Forbiddn	Forbiddn	04	25, 5E
2,4,6-Trinitrophenyl guanidine (dry)	4.1	UN1344	I	4.1	23, A8, A19, N41	None	211	None	1 kg	15 kg	E	28, 36
2,4,6-Trinitrophenyl nitramine	Forbiddn											
2,4,6-Trinitrophenyl trimethylol methyl nitramine trinitrate (dry)	Forbiddn											

§ 172.101 HAZARDOUS MATERIALS TABLE—Continued

(1) Sym-bols	(2) Hazardous materials descriptions and proper shipping names	(3) Hazard class or Division	(4) Identi-fication Numbers	(5) PG	Label Codes	(7) Special provisions (§ 172.102)	(8) Packaging (§ 173.***)			(9) Quantity limitations (see §§ 173.27 and 175.75)		(10) Vessel stowage	
							Excep-tions (8A)	Non-bulk (8B)	Bulk (8C)	Passenger aircraft/rail (9A)	Cargo air-craft only (9B)	Loca-tion (10A)	Other (10B)
	Tritrophenylmethylnitramine or Tetryl	1.1D	UN0208	II	1.1D	None (8A)	62 (8B)	None (8C)	Forbidden (9A)	Forbidden (9B)	04 (10A)	25 (10B)
	Tritroresorcinol or Styphnic acid, dry or wetted with less than 20 percent water, or mixture of alcohol and water, by mass	1.1D	UN0219	II	1.1D	None (8A)	62 (8B)	None (8C)	Forbidden (9A)	Forbidden (9B)	04 (10A)	25, 5E (10B)
	Tritroresorcinol, wetted or Styphnic acid, wetted with not less than 20 percent water, or mixture of alcohol and water by mass	1.1D	UN0394	II	1.1D	None (8A)	62 (8B)	None (8C)	Forbidden (9A)	Forbidden (9B)	04 (10A)	25, 5E (10B)
	2,4,6-Tritroso-3-methyl nitraminoisole	Forbidden											
	Tritrotriamine cobalt nitrate	Forbidden											
	Tritrotoluene and Tritrobenzene mixtures or TNT and trinitrobenzene mixtures or TNT and hexanitrostilbene mixtures or Tritrotoluene and hexanitrostilbene mixtures	1.1D	UN0388	II	1.1D	None (8A)	62 (8B)	None (8C)	Forbidden (9A)	Forbidden (9B)	04 (10A)	25 (10B)
	Tritrotoluene, mixtures containing Tritrobenzene and Hexanitrostilbene or TNT mixtures containing trinitrobenzene and hexanitrostilbene	1.1D	UN0209	II	1.1D	None (8A)	62 (8B)	None (8C)	Forbidden (9A)	Forbidden (9B)	04 (10A)	25 (10B)
	Tritrotoluene or TNT, dry or wetted with less than 30 percent water, by mass	4.1	UN3366	I	4.1	162, A8, A19, N41, N84	None (8A)	211 (8B)	None (8C)	0.5 kg (9A)	0.5 kg (9B)	E (10A)	36 (10B)
	Tritrotoluene (TNT), wetted, with not less than 10 percent water by mass	4.1	UN1356	I	4.1	23, A2, A8, A19, N41	None (8A)	211 (8B)	None (8C)	0.5 kg (9A)	0.5 kg (9B)	E (10A)	28, 36 (10B)
	Tritropropylamine	3	UN2260	III	3, 8	B1, IB3, T4, TP1	150 (8A)	203 (8B)	242 (8C)	5 L (9A)	60 L (9B)	A (10A)	40 (10B)
	Tripolyamine	3	UN2057	III	3	IB2, T4, TP1	150 (8A)	202 (8B)	242 (8C)	5 L (9A)	60 L (9B)	B (10A)	
	Tripolyene	3	UN2057	III	3	B1, IB3, T2, TP1	150 (8A)	203 (8B)	242 (8C)	60 L (9A)	220 L (9B)	A (10A)	

Proper shipping name	UN number	Class(es)	Subclass(es)	Label(s)	Quantity	Special provisions	Additional labels	Other
Tris-(1-aziridinyl)phosphine oxide, solution	6.1 UN2501	II	6.1	IB2, T7, TP2	153	202	243	5 L
Tris, bis-bifluoroamino diethoxy propane (TYOPA)	Forbiddén	III	6.1	IB3, T4, TP1	153	203	241	60 L
Tritonal	1.1D UN0390	II	1.1D	None	62	None	Forbiddén
Tungsten hexafluoride	2.3 UN2196	III	2.3, 8	None	338	None	Forbiddén
Turpentine	3 UN1299	III	3	B1, IB3, T2, TP1	150	201	242	220 L
Turpentine substitute	3 UN1300	III	3	T11, TP1, TP8, TP27	None	203	243	30 L
Undecane	3 UN2330	III	3	IB2, T4, TP1	150	202	242	60 L
Urea hydrogen peroxide	5.1 UN1511	III	5.1, 8	B1, IB3, T2, TP1	150	203	242	220 L
Urea nitrate, dry or wetted with less than 20 percent water, by mass	1.1D UN0220	II	1.1D	A1, A7, A29, IB8, IP3, T1, TP33	152	213	240	100 kg
Urea nitrate, wetted, with not less than 10 percent water by mass	4.1 UN3370	I	4.1	162, A8, A19, N41, N84	None	211	None	0.5 kg
Urea nitrate, wetted with not less than 20 percent water, by mass	4.1 UN1357	I	4.1	23, 39, A8, A19, N41	None	211	None	1 kg
Urea peroxide, see Urea hydrogen peroxide								
Valeraldehyde	3 UN2058	II	3	IB2, T4, TP1	150	202	242	5 L
Valeric acid, see Corrosive liquids, n.o.s.								
Valeryl chloride	8 UN2502	II	8, 3	A3, A6, A7, B2, IB2, N34, T7, TP2	154	202	243	1 L
Vanadium compound, n.o.s.	6.1 UN3285	I	6.1	IB7, IP1, T6, TP33	None	211	242	5 kg
Vanadium oxytrichloride	8 UN2443	III	6.1	IB8, IP2, IP4, T3, TP33	153	212	242	25 kg
Vanadium pentoxide, non-fused form	6.1 UN2862	III	6.1	IB8, IP3, T1, TP33	153	213	242	100 kg
Vanadium tetrachloride	8 UN2444	I	8	A3, A6, A7, B4, N34, T10, TP2	None	201	243	Forbiddén
Vanadium trichloride	8 UN2475	III	8	IB8, IP3, T1, TP33	154	213	240	25 kg
Vanadyl sulfate	6.1 UN2931	II	6.1	IB8, IP2, IP4, T3, TP33	153	212	242	100 kg
Vehicle, flammable gas powered, or powered	9 UN3166	9	135, A200	220	220	220	No limit
Vehicle, flammable liquid powered or Vehicle, fuel cell, flammable liquid powered	9 UN3166	9	135, A200	220	220	220	No limit
Very signal cartridge, see Cartridges, signal								
Vinyl acetate, stabilized	3 UN1301	II	3	IB2, T4, TP1	150	202	242	5 L
Vinyl bromide, stabilized	2.1 UN1085	II	2.1	N86, T50	306	304	314, 315	Forbiddén
Vinyl butyrate, stabilized	3 UN2838	II	3	IB2, T4, TP1	150	202	242	5 L

G

§ 172.101 HAZARDOUS MATERIALS TABLE—Continued

(1) Sym-bols	(2) Hazardous materials descriptions and proper shipping names	(3) Hazard class or Division	(4) Identi-fication Numbers	(5) PG	(6) Label Codes	(7) Special provisions (§ 172.102)	(8) Packaging (§ 173.***)			(9) Quantity limitations (see §§ 173.27 and 175.75)		(10) Vessel stowage	
							Excep-tions (8A)	Non-bulk (8B)	Bulk (8C)	Passenger aircraft/rail (9A)	Cargo air-craft only (9B)	Loca-tion (10A)	Other (10B)
	Vinyl chloride, stabilized	2.1	UN1086		2.1	21, B44, N86, T50	306	304	314, 315	Forbidden	150 kg	B	40
	Vinyl chloroacetate	6.1	UN2589	II	6.1, 3	IB2, T7, TP2	153	202	243	5 L	60 L	A	
	Vinyl ethyl ether, stabilized	3	UN1302	I	3	A3, T11, TP2	None	201	243	1 L	30 L	D	
	Vinyl fluoride, stabilized	2.1	UN1860		2.1	N86	306	304	314, 315	Forbidden	150 kg	E	40
	Vinyl isobutyl ether, stabilized	3	UN1304	II	3	IB2, T4, TP1	150	202	242	5 L	60 L	B	
	Vinyl methyl ether, stabilized	2.1	UN1087		2.1	B44, T50	306	304	314, 315	Forbidden	150 kg	B	40
	<i>Vinyl nitrate polymer</i>	Forbidden											
	Vinylidene chloride, stabilized	3	UN1303	I	3	T12, TP2, TP7	150	201	243	1 L	30 L	E	40
	Vinylpyridines, stabilized	6.1	UN3073	II	6.1, 3, 8	IB1, T7, TP2, TP13	153	202	243	1 L	30 L	B	21, 40, 52
	Vinyltoluenes, stabilized	3	UN2618	III	3	B1, IB3, T2, TP1	150	203	242	60 L	220 L	A	
	Vinyltrichlorosilane	3	UN1305	II	3, 8	A3, A7, B6, N34, T10, TP2, TP7, TP13	None	206	243	Forbidden	5 L	B	40
	Warheads, rocket with burster or expelling charge	1.4D	UN0370	II	1.4D		None	62	62	Forbidden	75 kg	02	25
	Warheads, rocket with burster or expelling charge	1.4F	UN0371	II	1.4F		None	62	62	Forbidden	Forbidden	05	25
	Warheads, rocket with bursting charge	1.1D	UN0286	II	1.1D		None	62	62	Forbidden	Forbidden	04	25
	Warheads, rocket with bursting charge	1.2D	UN0287	II	1.2D		None	62	62	Forbidden	Forbidden	04	25
	Warheads, rocket with bursting charge	1.1F	UN0369	II	1.1F		None	62	62	Forbidden	Forbidden	05	25
	Warheads, torpedo with bursting charge	1.1D	UN0221	II	1.1D		None	62	62	Forbidden	Forbidden	04	25
G	Water-reactive liquid, corrosive, n.o.s.	4.3	UN3129	I	4.3, 8	T14, TP2, TP7, TP13	None	201	243	Forbidden	1 L	D	
				III	4.3, 8	IB1, T11, TP2, TP7	None	202	243	1 L	5 L	E	85
				III	4.3, 8	IB2, T7, TP2, TP7	None	203	242	5 L	60 L	E	
G	Water-reactive liquid, n.o.s.	4.3	UN3148	I	4.3	T13, TP2, TP7, TP41	None	201	244	Forbidden	1 L	E	40
				II	4.3	IB1, T7, TP2, TP7	None	202	243	1 L	5 L	E	40
				III	4.3	IB2, T7, TP2, TP7	None	203	242	5 L	60 L	E	40
G	Water-reactive liquid, toxic, n.o.s.	4.3	UN3130	I	4.3, 6.1	A4	None	201	243	Forbidden	1 L	D	

G	Water-reactive solid, corrosive, n.o.s.	4.3	UN3131	II	4.3, 6.1	IB1	None	202	243	1 L	5 L	E	85													
													85													
G	Water-reactive solid, flammable, n.o.s.	4.3	UN3132	I	4.3, 8	IB4, IP1, N40, T9, TP7, TP33	None	211	242	Forbidden	15 kg	D	85													
													85													
													G	Water-reactive solid, n.o.s.	4.3	UN2813	I	4.3	IB4, N40, T9, TP7, TP33	None	211	242	Forbidden	15 kg	E	40
																										40
													G	Water-reactive, solid, oxidizing, n.o.s.	4.3	UN3133	II	4.3, 5.1	IB7, IP2, T3, TP33	None	212	242	15 kg	E	40	40
																										40
													G	Water-reactive solid, self-heating, n.o.s.	4.3	UN3135	I	4.3, 4.2	N40	None	211	242	Forbidden	15 kg	E	40
																										40
													G	Water-reactive solid, toxic, n.o.s.	4.3	UN3134	III	4.3	IB8, IP4, T1, TP33	None	213	241	25 kg	100 kg	E	85
																										85
I	Wheel chair, electric, see Battery powered vehicle or Battery powered equipment	9	UN2590	III	9	156, IB8, IP2, IP3, T1, TP33	155	216	240	200 kg	200 kg	A														34, 40
																										34, 40
A I W	White acid, see Hydrofluoric acid	3	UN1306	III	3	149, IB2, T4, TP1, TP8	150	202	242	5 L	60 L	B														40
																										40
A I W	White asbestos (chrysotile, actinolite, anthophyllite, tremolite)	4.2	UN1387	III	4.2	B1, IB3, T2, TP1	151	213	240	Forbidden	220 L	A														40
																										40
A I W	Wood preservatives, liquid	4.2	UN3342	II	4.2	IB6, IP2, T3, TP33	None	212	241	15 kg	50 kg	D														40
																										40
A I W	Wool waste, wet	2.2	UN2036	III	2.2	IB8, IP3, T1, TP33	None	302	None	25 kg	100 kg	D	40													
													40													
A I W	Xanthates	2.2	UN2591	II	2.2	T75, TP5	307	None	None	50 kg	500 kg	D	40													
													40													
A I W	Xenon, refrigerated liquid (cryogenic liquids)	3	UN1307	III	3	IB2, T4, TP1	150	202	242	5 L	60 L	B	40													
													40													
A I W	Xylenes	3	UN1307	III	3	B1, IB3, T2, TP1	150	203	242	60 L	220 L	A	40													
													40													

§ 172.101 HAZARDOUS MATERIALS TABLE—Continued

(1) Sym-bols	(2) Hazardous materials descriptions and proper shipping names	(3) Hazard class or Division	(4) Identi-fication Numbers	(5) PG	(6) Label Codes	(7) Special provisions (§ 172.102)	(8) Packaging (§ 173.***)			(9) Quantity limitations (see §§ 173.27 and 175.75)			(10) Vessel stowage																																																																																											
							Excep-tions	Non-bulk	Bulk	Passenger aircraft/rail	Cargo air-craft only	Loca-tion	Other																																																																																											
														(8A)	(8B)	(8C)	(9A)	(9B)	(10A)	(10B)																																																																																				
(1)	Xylenols, solid Xylenols, liquid Xylenes, liquid Xylenes, solid Xylyl bromide, liquid Xylyl bromide, solid	6.1 6.1 6.1 6.1 6.1 6.1	UN2261 UN3430 UN1711 UN3452 UN1701 UN3417	II II II II II II	6.1 6.1 6.1 6.1 6.1 6.1	IB8, IP2, IP4, T3, TP33 IB2, T7, TP2 IB2, T7, TP2 IB8, IP2, IP4, T3, TP33 A3, A6, A7, IB2, N33, T7, TP2, TP13 A3, A6, A7, IB8, IP2, IP4, N33, T3, TP33	153 153 153 153 None None	212 202 202 212 340 340	242 243 243 242 None None	25 kg 5 L 5 L 25 kg Forbidden 25 kg	100 kg 60 L 60 L 100 kg 60 L 100 kg	A A A A D B	40 40																																																																																											
														p-Xylyl diazide Zinc ammonium nitrite Zinc arsenate or Zinc arsenite or Zinc arsenate and zinc arsenite mixtures Zinc ashes	5.1 6.1 4.3	UN1512 UN1712 UN1435	II II III	5.1 6.1 4.3	IB8, IP4, T3, TP33 IB8, IP2, IP4, T3, TP33 A1, A19, IB8, IP4, T1, TP33	None 153 151	212 212 213	242 242 241	5 kg 25 kg 25 kg	25 kg 100 kg 100 kg	E A A	56, 58 56, 58																																																																														
																											Zinc bisulfite solution, see Bisulfites, aqueous solutions, n.o.s. Zinc bromate	5.1 5.1	UN2469 UN1513	III II	5.1 5.1	A1, A29, IB8, IP3, T1, TP33 A9, IB8, IP2, IP4, N34, TP33	152 152	213 212	240 242	25 kg 5 kg	100 kg 25 kg	A A	56, 58 56, 58																																																																	
																																								Zinc chlorate	8 8 6.1 9 6.1	UN2331 UN1840 UN1713 UN1931 UN2855	III III I III III	8 8 6.1 None 6.1	IB8, IP3, T1, TP33 IB3, T4, TP1 IB7, IP1, T6, TP33 IB8, IP3, T1, TP33 IB8, IP3, T1, TP33	None 154 None 155 153	213 203 211 204 213	240 241 242 240 240	25 kg 60 L 5 L 100 kg 200 kg	100 kg 60 L 50 kg 200 kg 200 kg	A A A A A	52 49 52																																																				
																																																					Zinc hydrosulfite, see Zinc dithionite chloride, solution Zinc nitrate Zinc permanganate	5.1 5.1	UN1514 UN1515	II II	5.1 5.1	IB8, IP2, IP4, T3, TP33 IB6, IP2, T3, TP33	152 152	212 212	240 242	5 kg 5 kg	25 kg 25 kg	A D	56, 58, 138 138 66, 75 40, 52, 85																																							
																																																																		Zinc peroxide	5.1	UN1516	II	5.1	IB6, IP2, T3, TP33	152	212	242	5 kg	25 kg	A	56, 58, 138 138 66, 75 40, 52, 85																										
																																																																															Zinc phosphide	4.3	UN1714	I	4.3, 6.1	A19, N40	None	211	None	Forbidden	15 kg	E	56, 58, 138 138 66, 75 40, 52, 85													
																																																																																												Zinc powder or Zinc dust	4.3	UN1436	I	4.3, 4.2	A19, IB4, IP1, N40	None	211	242	Forbidden	15 kg	A	56, 58, 138 138 66, 75 40, 52, 85

Zinc resinolate	4.1	UN2714	III	4.1	A1, IB6, T1, TP33	151	213	240	25 kg	100 kg	A	52, 53
Zinc selenate, see Selenates or Selenites			III	4.2	IB8, IP4, T1, TP33	None	213	242	25 kg	100 kg	A	52, 53
Zinc selenite, see Selenates or Selenites			III	4.1	A1, IB6, T1, TP33	151	213	240	25 kg	100 kg	A	
Zinc silicofluoride, see Zinc fluorosilicate												
Zirconium, dry, coiled wire, finished metal sheets, strip (thinner than 254 microns but not thinner than 18 microns)	4.1	UN2858	III	4.1	A1	151	213	240	25 kg	100 kg	A	
Zirconium, dry, finished sheets, strip or coiled wire	4.2	UN2009	III	4.2	A1, A19	None	213	240	25 kg	100 kg	D	
Zirconium hydride	4.1	UN1437	II	4.1	A19, A20, IB4, N34, T3, TP33	None	212	240	15 kg	50 kg	E	
Zirconium nitrate	5.1	UN2728	III	5.1	A1, A29, IB8, IP3, T1, TP33	152	213	240	25 kg	100 kg	A	
Zirconium picramate, dry or wetted with less than 20 percent water, by mass	1.3C	UN0236	II	1.3C	None	62	None	Forbidden	Forbidden	O4	25, 5E
Zirconium picramate, wetted with not less than 20 percent water, by mass	4.1	UN1517	I	4.1	23, N41	None	211	None	1 kg	15 kg	D	28, 36
Zirconium powder, dry	4.2	UN2008	I	4.2	T21, TP7, TP33	None	211	242	Forbidden	Forbidden	D	
			II	4.2	A19, A20, IB6, IP2, N5, N34, T3, TP33	None	212	241	15 kg	50 kg	D	
			III	4.2	IB8, IP3, T1, TP33	None	213	241	25 kg	100 kg	D	
			II	4.1	A19, A20, IB6, IP2, N34, T3, TP33	None	212	241	15 kg	50 kg	E	74
Zirconium powder, wetted with not less than 25 percent water (a visible excess of water must be present) (a) mechanically produced, particle size less than 53 microns; (b) chemically produced, particle size less than 840 microns	4.2	UN1932	III	4.2	IB8, IP3, N34, T1, TP33	None	213	240	Forbidden	Forbidden	D	
Zirconium scrap	3	UN1308	I	3	IB2	None	201	243	Forbidden	Forbidden	B	
Zirconium suspended in a liquid			II	3	B1, IB2	None	202	242	5 L	60 L	B	
			III	3	IB8, IP3, T1, TP33	150	203	242	60 L	220 L	B	
Zirconium tetrachloride	8	UN2503	III	8	IB8, IP3, T1, TP33	154	213	240	25 kg	100 kg	A

§ 172.101

49 CFR Ch. I (10–1–14 Edition)

APPENDIX A TO § 172.101—LIST OF HAZARDOUS SUBSTANCES AND REPORTABLE QUANTITIES

1. This appendix lists materials and their corresponding reportable quantities (RQ's) that are listed or designated as "hazardous substances" under section 101(14) of the Comprehensive Environmental Response, Compensation, and Liability Act, 42 U.S.C. 9601(14) (CERCLA; 42 U.S.C. 9601 *et seq.*). This listing fulfills the requirement of CERCLA, 42 U.S.C. 9656(a), that all "hazardous substances," as defined in 42 U.S.C. 9601(14), be listed and regulated as hazardous materials under 49 U.S.C. 5101–5127. That definition includes substances listed under sections 311(b)(2)(A) and 307(a) of the Federal Water Pollution Control Act, 33 U.S.C. 1321(b)(2)(A) and 1317(a), section 3001 of the Solid Waste Disposal Act, 42 U.S.C. 6921, and section 112 of the Clean Air Act, 42 U.S.C. 7412. In addition, this list contains materials that the Administrator of the Environmental Protection Agency has determined to be hazardous substances in accordance with section 102 of CERCLA, 42 U.S.C. 9602. It should be noted that 42 U.S.C. 9656(b) provides that common and contract carriers may be held liable under laws other than CERCLA for the release of a hazardous substance as defined in that Act, during transportation that commenced before the effective date of the listing and regulating of that substance as a hazardous material under 49 U.S.C. 5101–5127.

2. This appendix is divided into two TABLES which are entitled "TABLE 1—HAZARDOUS SUBSTANCES OTHER THAN RADIONUCLIDES" and "TABLE 2—RADIONUCLIDES." A material listed in this appendix is regulated as a hazardous material and a hazardous substance under this subchapter if it meets the definition of a hazardous substance in § 171.8 of this subchapter.

3. The procedure for selecting a proper shipping name for a hazardous substance is set forth in § 172.101(c).

4. Column 1 of TABLE 1, entitled "*Hazardous substance*", contains the names of those elements and compounds that are hazardous substances. Following the listing of elements and compounds is a listing of waste streams. These waste streams appear on the list in numerical sequence and are referenced by the appropriate "D", "F", or "K" numbers. Column 2 of TABLE 1, entitled "*Reportable quantity (RQ)*", contains the report-

able quantity (RQ), in pounds and kilograms, for each hazardous substance listed in Column 1 of TABLE 1.

5. A series of notes is used throughout TABLE 1 and TABLE 2 to provide additional information concerning certain hazardous substances. These notes are explained at the end of each TABLE.

6. TABLE 2 lists radionuclides that are hazardous substances and their corresponding RQ's. The RQ's in table 2 for radionuclides are expressed in units of curies and terabecquerels, whereas those in table 1 are expressed in units of pounds and kilograms. If a material is listed in both table 1 and table 2, the lower RQ shall apply. Radionuclides are listed in alphabetical order. The RQ's for radionuclides are given in the radiological unit of measure of curie, abbreviated "Ci", followed, in parentheses, by an equivalent unit measured in terabecquerels, abbreviated "TBq".

7. For mixtures of radionuclides, the following requirements shall be used in determining if a package contains an RQ of a hazardous substance: (i) if the identity and quantity (in curies or terabecquerels) of each radionuclide in a mixture or solution is known, the ratio between the quantity per package (in curies or terabecquerels) and the RQ for the radionuclide must be determined for each radionuclide. A package contains an RQ of a hazardous substance when the sum of the ratios for the radionuclides in the mixture or solution is equal to or greater than one; (ii) if the identity of each radionuclide in a mixture or solution is known but the quantity per package (in curies or terabecquerels) of one or more of the radionuclides is unknown, an RQ of a hazardous substance is present in a package when the total quantity (in curies or terabecquerels) of the mixture or solution is equal to or greater than the lowest RQ of any individual radionuclide in the mixture or solution; and (iii) if the identity of one or more radionuclides in a mixture or solution is unknown (or if the identity of a radionuclide by itself is unknown), an RQ of a hazardous substance is present when the total quantity (in curies or terabecquerels) in a package is equal to or greater than either one curie or the lowest RQ of any known individual radionuclide in the mixture or solution, whichever is lower.

TABLE 1 TO APPENDIX A—HAZARDOUS SUBSTANCES OTHER THAN RADIONUCLIDES

Hazardous substance	Reportable quantity (RQ) pounds (kilograms)
A2213	5000 (2270)
Acenaphthene	100 (45.4)
Acenaphthylene	5000 (2270)
Acetaldehyde	1000 (454)
Acetaldehyde, chloro-	1000 (454)

TABLE 1 TO APPENDIX A—HAZARDOUS SUBSTANCES OTHER THAN RADIONUCLIDES—Continued

Hazardous substance	Reportable quantity (RQ) pounds (kilograms)
Acetaldehyde, trichloro-	5000 (2270)
Acetamide	100 (45.4)
Acetamide, N-(aminothioxomethyl)-	1000 (454)
Acetamide, N-(4-ethoxyphenyl)-	100 (45.4)
Acetamide, N-9H-fluoren-2-yl-	1 (0.454)
Acetamide, 2-fluoro-	100 (45.4)
Acetic acid	5000 (2270)
Acetic acid, (2,4-dichlorophenoxy)-, salts & esters	100 (45.4)
Acetic acid, ethyl ester	5000 (2270)
Acetic acid, fluoro-, sodium salt	10 (4.54)
Acetic acid, lead(2+) salt	10 (4.54)
Acetic acid, thallium(1+) salt	100 (45.4)
Acetic acid, (2,4,5-trichlorophenoxy)-	1000 (454)
Acetic anhydride	5000 (2270)
Acetone	5000 (2270)
Acetone cyanohydrin	10 (4.54)
Acetonitrile	5000 (2270)
Acetophenone	5000 (2270)
2-Acetylaminofluorene	1 (0.454)
Acetyl bromide	5000 (2270)
Acetyl chloride	5000 (2270)
1-Acetyl-2-thiourea	1000 (454)
Acrolein	1 (0.454)
Acrylamide	5000 (2270)
Acrylic acid	5000 (2270)
Acrylonitrile	100 (45.4)
Adipic acid	5000 (2270)
Aldicarb	1 (0.454)
Aldicarb sulfone	100 (45.4)
Aldrin	1 (0.454)
Allyl alcohol	100 (45.4)
Allyl chloride	1000 (454)
Aluminum phosphide	100 (45.4)
Aluminum sulfate	5000 (2270)
4-Aminobiphenyl	1 (0.454)
5-(Aminomethyl)-3-isoxazolol	1000 (454)
4-Aminopyridine	1000 (454)
Amitrole	10 (4.54)
Ammonia	100 (45.4)
Ammonium acetate	5000 (2270)
Ammonium benzoate	5000 (2270)
Ammonium bicarbonate	5000 (2270)
Ammonium bichromate	10 (4.54)
Ammonium bifluoride	100 (45.4)
Ammonium bisulfite	5000 (2270)
Ammonium carbamate	5000 (2270)
Ammonium carbonate	5000 (2270)
Ammonium chloride	5000 (2270)
Ammonium chromate	10 (4.54)
Ammonium citrate, dibasic	5000 (2270)
Ammonium dichromate ®	10 (4.54)
Ammonium fluoborate	5000 (2270)
Ammonium fluoride	100 (45.4)
Ammonium hydroxide	1000 (454)
Ammonium oxalate	5000 (2270)
Ammonium picrate	10 (4.54)
Ammonium silicofluoride	1000 (454)
Ammonium sulfamate	5000 (2270)
Ammonium sulfide	100 (45.4)
Ammonium sulfite	5000 (2270)
Ammonium tartrate	5000 (2270)
Ammonium thiocyanate	5000 (2270)
Ammonium vanadate	1000 (454)
Amyl acetate	5000 (2270)
iso-Amyl acetate.	
sec-Amyl acetate.	
tert-Amyl acetate.	
Aniline	5000 (2270)
o-Anisidine	100 (45.4)
Anthracene	5000 (2270)

TABLE 1 TO APPENDIX A—HAZARDOUS SUBSTANCES OTHER THAN RADIONUCLIDES—Continued

Hazardous substance	Reportable quantity (RQ) pounds (kilograms)
Antimony <i>⊄</i>	5000 (2270)
Antimony pentachloride	1000 (454)
Antimony potassium tartrate	100 (45.4)
Antimony tribromide	1000 (454)
Antimony trichloride	1000 (454)
Antimony trifluoride	1000 (454)
Antimony trioxide	1000 (454)
Argentate(1-), bis(cyano-C)-, potassium	1 (0.454)
Aroclor 1016	1 (0.454)
Aroclor 1221	1 (0.454)
Aroclor 1232	1 (0.454)
Aroclor 1242	1 (0.454)
Aroclor 1248	1 (0.454)
Aroclor 1254	1 (0.454)
Aroclor 1260	1 (0.454)
Aroclors	1 (0.454)
Arsenic <i>⊄</i>	1 (0.454)
Arsenic acid H ₃ AsO ₄	1 (0.454)
Arsenic disulfide	1 (0.454)
Arsenic oxide As ₂ O ₃	1 (0.454)
Arsenic oxide As ₂ O ₅	1 (0.454)
Arsenic pentoxide	1 (0.454)
Arsenic trichloride	1 (0.454)
Arsenic trioxide	1 (0.454)
Arsenic trisulfide	1 (0.454)
Arsine, diethyl-	1 (0.454)
Arsinic acid, dimethyl-	1 (0.454)
Arsonous dichloride, phenyl-	1 (0.454)
Asbestos <i>⊄⊄</i>	1 (0.454)
Auramine	100 (45.4)
Azaserine	1 (0.454)
Aziridine	1 (0.454)
Aziridine, 2-methyl-	1 (0.454)
Azirino[2,3':3,4]pyrrolo[1,2-a]indole-4,7-dione, 6-amino-8-[[[(aminocarbonyl)oxy]methyl]-1,1a,2,8,8a,8b-hexahydro-8a-methoxy-5-methyl-, [1aS-(1aalpha,8beta,8aalpha, 8balpha)]-	10 (4.54)
Barban	10 (4.54)
Barium cyanide	10 (4.54)
Bendiocarb	100 (45.4)
Bendiocarb phenol	1000 (454)
Benomyl	10 (4.54)
Benz[<i>j</i>]aceanthrylene, 1,2-dihydro-3-methyl-	10 (4.54)
Benz[<i>c</i>]acridine	100 (45.4)
Benzal chloride	5000 (2270)
Benzamide, 3,5-dichloro-N-(1,1-dimethyl-2-propynyl)-	5000 (2270)
Benz[<i>a</i>]anthracene	10 (4.54)
1,2-Benzanthracene	10 (4.54)
Benz[<i>a</i>]anthracene, 7,12-dimethyl-	1 (0.454)
Benzenamine	5000 (2270)
Benzenamine, 4,4'-carbonimidoylbis (N,N dimethyl-	100 (45.4)
Benzenamine, 4-chloro-	1000 (454)
Benzenamine, 4-chloro-2-methyl-, hydrochloride	100 (45.4)
Benzenamine, N,N-dimethyl-4-(phenylazo)-	10 (4.54)
Benzenamine, 2-methyl-	100 (45.4)
Benzenamine, 4-methyl-	100 (45.4)
Benzenamine, 4,4'-methylenebis[2-chloro-	10 (4.54)
Benzenamine, 2-methyl-, hydrochloride	100 (45.4)
Benzenamine, 2-methyl-5-nitro-	100 (45.4)
Benzenamine, 4-nitro-	5000 (2270)
Benzene	10 (4.54)
Benzenoacetic acid, 4-chloro- α -(4-chlorophenyl)- α -hydroxy-, ethyl ester	10 (4.54)
Benzene, 1-bromo-4-phenoxy-	100 (45.4)
Benzenobutanoic acid, 4-[bis(2-chloroethyl)amino]-	10 (4.54)
Benzene, chloro-	100 (45.4)
Benzene, (chloromethyl)-	100 (45.4)
Benzenediamine, ar-methyl-	10 (4.54)
1,2-Benzenedicarboxylic acid, bis(2-ethylhexyl) ester	100 (45.4)
1,2-Benzenedicarboxylic acid, dibutyl ester	10 (4.54)
1,2-Benzenedicarboxylic acid, diethyl ester	1000 (454)
1,2-Benzenedicarboxylic acid, dimethyl ester	5000 (2270)
1,2-Benzenedicarboxylic acid, dioctyl ester	5000 (2270)

TABLE 1 TO APPENDIX A—HAZARDOUS SUBSTANCES OTHER THAN RADIONUCLIDES—Continued

Hazardous substance	Reportable quantity (RQ) pounds (kilograms)
Benzene, 1,2-dichloro-	100 (45.4)
Benzene, 1,3-dichloro-	100 (45.4)
Benzene, 1,4-dichloro-	100 (45.4)
Benzene, 1,1'-(2,2-dichloroethylidene) bis[4-chloro-	1 (0.454)
Benzene, (dichloromethyl)-	5000 (2270)
Benzene, 1,3-diisocyanatomethyl-	100 (45.4)
Benzene, dimethyl-	100 (45.4)
1,3-Benzenediol	5000 (2270)
1,2-Benzenediol,4-[1-hydroxy-2-(methylamino) ethyl]-	1000 (454)
Benzeneethanamine, alpha,alpha-dimethyl-	5000 (2270)
Benzene, hexachloro-	10 (4.54)
Benzene, hexahydro-	1000 (454)
Benzene, methyl-	1000 (454)
Benzene, 1-methyl-2,4-dinitro-	10 (4.54)
Benzene, 2-methyl-1,3-dinitro-	100 (45.4)
Benzene, (1-methylethyl)-	5000 (2270)
Benzene, nitro-	1000 (454)
Benzene, pentachloro-	10 (4.54)
Benzene, pentachloronitro-	100 (45.4)
Benzenesulfonic acid chloride	100 (45.4)
Benzenesulfonyl chloride	100 (45.4)
Benzene,1,2,4,5-tetrachloro-	5000 (2270)
Benzenethiol	100 (45.4)
Benzene,1,1'-(2,2,2-trichloroethylidene) bis[4-chloro-	1 (0.454)
Benzene,1,1'-(2,2,2-trichloroethylidene) bis[4-methoxy-	1 (0.454)
Benzene, (trichloromethyl)-	10 (4.54)
Benzene, 1,3,5-trinitro-	10 (4.54)
Benzidine	1 (0.454)
Benzo[a]anthracene	10 (4.54)
1,3-Benzodioxole, 5-(1-propenyl)-1	100 (45.4)
1,3-Benzodioxole, 5-(2-propenyl)-	100 (45.4)
1,3-Benzodioxole, 5-propyl-	10 (4.54)
1,3-Benzodioxol-4-ol, 2,2-dimethyl-	1000 (454)
1,3-Benzodioxol-4-ol, 2,2-dimethyl-, methyl carbamate	100 (45.4)
Benzo[b]fluoranthene	1 (0.454)
Benzo[k]fluoranthene	5000 (2270)
7-Benzofuranol, 2,3-dihydro-2,2-dimethyl-	10 (4.54)
7-Benzofuranol, 2,3-dihydro-2,2-dimethyl-, methylcarbamate	10 (4.54)
Benzoic acid	5000 (2270)
Benzoic acid, 2-hydroxy-, compd. with (3aS-cis)-1,2,3,3a,8,8a-hexahydro-1,3a,8-trimethylpyrrolo [2,3-b]indol-5-yl methylcarbamate ester (1:1)	100 (45.4)
Benzonitrile	5000 (2270)
Benzo[rs]pentaphene	10 (4.54)
Benzo[ghi]perylene	5000 (2270)
2H-1-Benzopyran-2-one, 4-hydroxy-3-(3-oxo-1-phenylbutyl)-, & salts	100 (45.4)
Benzo[a]pyrene	1 (0.454)
3,4-Benzopyrene	1 (0.454)
p-Benzoquinone	10 (4.54)
Benzotrichloride	10 (4.54)
Benzoyl chloride	1000 (454)
Benzyl chloride	100 (45.4)
Beryllium ϵ	10 (4.54)
Beryllium chloride	1 (0.454)
Beryllium fluoride	1 (0.454)
Beryllium nitrate	1 (0.454)
Beryllium powder ϵ	10 (4.54)
alpha-BHC	10 (4.54)
beta-BHC	1 (0.454)
delta-BHC	1 (0.454)
gamma-BHC	1 (0.454)
2,2'-Bioxirane	10 (4.54)
Biphenyl	100 (45.4)
[1,1'-Biphenyl]-4,4'-diamine	1 (0.454)
[1,1'-Biphenyl]-4,4'-diamine,3,3'-dichloro-	1 (0.454)
[1,1'-Biphenyl]-4,4'-diamine,3,3'-dimethoxy-	100 (45.4)
[1,1'-Biphenyl]-4,4'-diamine,3,3'-dimethyl-	10 (4.54)
Bis(2-chloroethoxy) methane	1000 (454)
Bis(2-chloroethyl) ether	10 (4.54)
Bis(chloromethyl) ether	10 (4.54)
Bis(2-ethylhexyl) phthalate	100 (45.4)

TABLE 1 TO APPENDIX A—HAZARDOUS SUBSTANCES OTHER THAN RADIONUCLIDES—Continued

Hazardous substance	Reportable quantity (RQ) pounds (kilograms)
Bromoacetone	1000 (454)
Bromoform	100 (45.4)
Bromomethane	1000 (454)
4-Bromophenyl phenyl ether	100 (45.4)
Brucine	100 (45.4)
1,3-Butadiene	10 (4.54)
1,3-Butadiene, 1,1,2,3,4,4-hexachloro-	1 (0.454)
1-Butanamine, N-butyl-N-nitroso-	10 (4.54)
1-Butanol	5000 (2270)
2-Butanone	5000 (2270)
2-Butanone, 3,3-dimethyl-1(methylthio)-, O [(methylamino) carbonyl] oxime	100 (45.4)
2-Butanone peroxide	10 (4.54)
2-Butenal	100 (45.4)
2-Butene, 1,4-dichloro-	1 (0.454)
2-Butenoic acid, 2-methyl-, 7-[[2,3-dihydroxy-2-(1-methoxyethyl)-3-methyl-1-oxobutoxy] methyl]-2,3,5,7a-tetrahydro-1H-pyrrrolizin-1-yl ester, [1S-[1alpha(Z), 7(2S*,3R*),7aalpha]-	10 (4.54)
Butyl acetate	5000 (2270)
iso-Butyl acetate.	
sec-Butyl acetate.	
tert-Butyl acetate.	
n-Butyl alcohol	5000 (2270)
Butylamine	1000 (454)
iso-Butylamine.	
sec-Butylamine.	
tert-Butylamine.	
Butyl benzyl phthalate	100 (45.4)
n-Butyl phthalate	10 (4.54)
Butyric acid	5000 (2270)
iso-Butyric acid.	
Cacodylic acid	1 (0.454)
Cadmium	10 (4.54)
Cadmium acetate	10 (4.54)
Cadmium bromide	10 (4.54)
Cadmium chloride	10 (4.54)
Calcium arsenate	1 (0.454)
Calcium arsenite	1 (0.454)
Calcium carbide	10 (4.54)
Calcium chromate	10 (4.54)
Calcium cyanamide	1000 (454)
Calcium cyanide Ca(CN) ₂	10 (4.54)
Calcium dodecylbenzenesulfonate	1000 (454)
Calcium hypochlorite	10 (4.54)
Captan	10 (4.54)
Carbamic acid, 1H-benzimidazol-2-yl, methyl ester	10 (4.54)
Carbamic acid, [1-[(butylamino)carbonyl]-1H-benzimidazol-2-yl]-, methyl ester	10 (4.54)
Carbamic acid, (3-chlorophenyl)-, 4-chloro-2-butynyl ester	10 (4.54)
Carbamic acid, [(dibutylamino)-thio]methyl-, 2,3-dihydro-2,2-dimethyl-7-benzofuranyl ester	1000 (454)
Carbamic acid, dimethyl-, 1-[(dimethyl-amino)carbonyl]-5-methyl-1H-pyrazol-3-yl ester	1 (0.454)
Carbamic acid, dimethyl-, 3-methyl-1-(1-methylethyl)-1H-pyrazol-5-yl ester	100 (45.4)
Carbamic acid, ethyl ester	100 (45.4)
Carbamic acid, methyl-, 3-methylphenyl ester	1000 (454)
Carbamic acid, methylnitroso-, ethyl ester	1 (0.454)
Carbamic acid, [1,2-phenylenebis(iminocarbonothioyl)] bis-, dimethyl ester	10 (4.54)
Carbamic acid, phenyl-, 1-methylethyl ester	1000 (454)
Carbamic chloride, dimethyl-	1 (0.454)
Carbamodithioic acid, 1,2-ethanediylbis-, salts & esters	5000 (2270)
Carbamothioic acid, bis(1-methylethyl)-, S-(2,3-dichloro-2-propenyl) ester	100 (45.4)
Carbamothioic acid, bis(1-methylethyl)-, S-(2,3,3-trichloro-2-propenyl) ester	100 (45.4)
Carbamothioic acid, dipropyl-, S-(phenylmethyl) ester	5000 (2270)
Carbaryl	100 (45.4)
Carbendazim	10 (4.54)
Carbofuran	10 (4.54)
Carbofuran phenol	10 (4.54)
Carbon disulfide	100 (45.4)
Carbonic acid, dithallium(1+) salt	100 (45.4)
Carbonic dichloride	10 (4.54)
Carbonic difluoride	1000 (454)
Carbonochloridic acid, methyl ester	1000 (454)
Carbon oxyfluoride	1000 (454)
Carbon tetrachloride	10 (4.54)

TABLE 1 TO APPENDIX A—HAZARDOUS SUBSTANCES OTHER THAN RADIONUCLIDES—Continued

Hazardous substance	Reportable quantity (RQ) pounds (kilograms)
Carbonyl sulfide	100 (45.4)
Carbosulfan	1000 (454)
Catechol	100 (45.4)
Chloral	5000 (2270)
Chloramben	100 (45.4)
Chlorambucil	10 (4.54)
Chlordane	1 (0.454)
Chlordane, alpha & gamma isomers	1 (0.454)
CHLORDANE (TECHNICAL MIXTURE AND METABOLITES)	1 (0.454)
Chlorinated camphene	1 (0.454)
Chlorine	10 (4.54)
Chlornaphazine	100 (45.4)
Chloroacetaldehyde	1000 (454)
Chloroacetic acid	100 (45.4)
2-Chloroacetophenone	100 (45.4)
p-Chloroaniline	1000 (454)
Chlorobenzene	100 (45.4)
Chlorobenzilate	10 (4.54)
p-Chloro-m-cresol	5000 (2270)
Chlorodibromomethane	100 (45.4)
1-Chloro-2,3-epoxypropane	100 (45.4)
Chloroethane	100 (45.4)
2-Chloroethyl vinyl ether	1000 (454)
Chloroform	10 (4.54)
Chloromethane	100 (45.4)
Chloromethyl methyl ether	10 (4.54)
beta-Chloronaphthalene	5000 (2270)
2-Chloronaphthalene	5000 (2270)
2-Chlorophenol	100 (45.4)
o-Chlorophenol	100 (45.4)
4-Chlorophenyl phenyl ether	5000 (2270)
1-(o-Chlorophenyl)thiourea	100 (45.4)
Chloroprene	100 (45.4)
3-Chloropropionitrile	1000 (454)
Chlorosulfonic acid	1000 (454)
4-Chloro-o-toluidine, hydrochloride	100 (45.4)
Chlorpyrifos	1 (0.454)
Chromic acetate	1000 (454)
Chromic acid	10 (4.54)
Chromic acid H ₂ CrO ₄ , calcium salt	10 (4.54)
Chromic sulfate	1000 (454)
Chromium ϵ	5000 (2270)
Chromous chloride	1000 (454)
Chrysene	100 (45.4)
Cobaltous bromide	1000 (454)
Cobaltous formate	1000 (454)
Cobaltous sulfamate	1000 (454)
Coke Oven Emissions	1 (0.454)
Copper ϵ	5000 (2270)
Copper chloride ϵ	10 (4.54)
Copper cyanide Cu(CN)	10 (4.54)
Coumaphos	10 (4.54)
Creosote	1 (0.454)
Cresol (cresylic acid)	100 (45.4)
m-Cresol	100 (45.4)
o-Cresol	100 (45.4)
p-Cresol	100 (45.4)
Cresols (isomers and mixture)	100 (45.4)
Cresylic acid (isomers and mixture)	100 (45.4)
Crotonaldehyde	100 (45.4)
Cumene	5000 (2270)
m-Cumenyl methylcarbamate	10 (4.54)
Cupric acetate	100 (45.4)
Cupric acetoarsenite	1 (0.454)
Cupric chloride	10 (4.54)
Cupric nitrate	100 (45.4)
Cupric oxalate	100 (45.4)
Cupric sulfate	10 (4.54)
Cupric sulfate, ammoniated	100 (45.4)
Cupric tartrate	100 (45.4)

TABLE 1 TO APPENDIX A—HAZARDOUS SUBSTANCES OTHER THAN RADIONUCLIDES—Continued

Hazardous substance	Reportable quantity (RQ) pounds (kilograms)
Cyanides (soluble salts and complexes) not otherwise specified	10 (4.54)
Cyanogen	100 (45.4)
Cyanogen bromide (CN)Br	1000 (454)
Cyanogen chloride (CN)Cl	10 (4.54)
2,5-Cyclohexadiene-1,4-dione	10 (4.54)
Cyclohexane	1000 (454)
Cyclohexane, 1,2,3,4,5,6-hexachloro-, (1 α , 2 α , 3 β -, 4 α , 5 α , 6 β)	1 (0.454)
Cyclohexanone	5000 (2270)
2-Cyclohexyl-4,6-dinitrophenol	100 (45.4)
1,3-Cyclopentadiene, 1,2,3,4,5-hexachloro-	10 (4.54)
Cyclophosphamide	10 (4.54)
2,4-D Acid	100 (45.4)
2,4-D Ester	100 (45.4)
2,4-D, salts and esters	100 (45.4)
Daunomycin	10 (4.54)
DDD	1 (0.454)
4,4'-DDD	1 (0.454)
DDE (72-55-9) #	1 (0.454)
DDE (3547-04-4) #	5000 (2270)
4,4'-DDE	1 (0.454)
DDT	1 (0.454)
4,4'-DDT	1 (0.454)
DEHP	100 (45.4)
Diallate	100 (45.4)
Diazinon	1 (0.454)
Diazomethane	100 (45.4)
Dibenz[a,h]anthracene	1 (0.454)
1,2,5,6-Dibenzanthracene	1 (0.454)
Dibenzo[a,h]anthracene	1 (0.454)
Dibenzofuran	100 (45.4)
Dibenzo[a,i]pyrene	10 (4.54)
1,2-Dibromo-3-chloropropane	1 (0.454)
Dibromoethane	1 (0.454)
Dibutyl phthalate	10 (4.54)
Di-n-butyl phthalate	10 (4.54)
Dicamba	1000 (454)
Dichlobenil	100 (45.4)
Dichlone	1 (0.454)
Dichlorobenzene	100 (45.4)
1,2-Dichlorobenzene	100 (45.4)
1,3-Dichlorobenzene	100 (45.4)
1,4-Dichlorobenzene	100 (45.4)
m-Dichlorobenzene	100 (45.4)
o-Dichlorobenzene	100 (45.4)
p-Dichlorobenzene	100 (45.4)
3,3'-Dichlorobenzidine	1 (0.454)
Dichlorobromomethane	5000 (2270)
1,4-Dichloro-2-butene	1 (0.454)
Dichlorodifluoromethane	5000 (2270)
1,1-Dichloroethane	1000 (454)
1,2-Dichloroethane	100 (45.4)
1,1-Dichloroethylene	100 (45.4)
1,2-Dichloroethylene	1000 (454)
Dichloroethyl ether	10 (4.54)
Dichloroisopropyl ether	1000 (454)
Dichloromethane	1000 (454)
Dichloromethoxyethane	1000 (454)
Dichloromethyl ether	10 (4.54)
2,4-Dichlorophenol	100 (45.4)
2,6-Dichlorophenol	100 (45.4)
Dichlorophenylarsine	1 (0.454)
Dichloropropane	1000 (454)
1,1-Dichloropropane	
1,3-Dichloropropane	
1,2-Dichloropropane	1000 (454)
Dichloropropane-Dichloropropene (mixture)	100 (45.4)
Dichloropropene	100 (45.4)
2,3-Dichloropropene	
1,3-Dichloropropene	100 (45.4)
2,2-Dichloropropionic acid	5000 (2270)

TABLE 1 TO APPENDIX A—HAZARDOUS SUBSTANCES OTHER THAN RADIONUCLIDES—Continued

Hazardous substance	Reportable quantity (RQ) pounds (kilograms)
Dichlorvos	10 (4.54)
Dicofol	10 (4.54)
Dieldrin	1 (0.454)
1,2:3,4-Diepoxybutane	10 (4.54)
Diethanolamine	100 (45.4)
Diethylamine	100 (45.4)
N,N-Diethylaniline	1000 (454)
Diethylarsine	1 (0.454)
Diethylene glycol, dicarbamate	5000 (2270)
1,4-Diethyleneoxide	100 (45.4)
Diethylhexyl phthalate	100 (45.4)
N,N'-Diethylhydrazine	10 (4.54)
O,O-Diethyl S-methyl dithiophosphate	5000 (2270)
Diethyl-p-nitrophenyl phosphate	100 (45.4)
Diethyl phthalate	1000 (454)
O,O-Diethyl O-pyrazinyl phosphorothioate	100 (45.4)
Diethylstilbestrol	1 (0.454)
Diethyl sulfate	10 (4.54)
Dihydrosafrole	10 (4.54)
Diisopropylfluorophosphate (DFP)	100 (45.4)
1,4:5,8-Dimethanonaphthalene, 1,2,3,4,10,10-hexachloro-1,4,4a,5,8,8a-hexahydro-, (1alpha, 4alpha, 4beta, 5alpha, 8alpha, 8beta)-	1 (0.454)
1,4:5,8-Dimethanonaphthalene, 1,2,3,4,10,10-hexachloro-1,4,4a,5,8,8a-hexahydro-, (1alpha, 4alpha, 4beta, 5beta, 8beta, 8beta)-1 (0.454)	1 (0.454)
2,7:3,6-Dimethanonaphth[2,3-b]oxirene,3,4,5,6,9,9-hexachloro-1a,2,2a,3,6,6a,7,7a-octahydro-, (1aalpha, 2beta, 2aalpha, 3beta, 6beta, 6aalpha, 7beta, 7aalpha)-	1 (0.454)
2,7:3,6-Dimethanonaphth[2, 3-b]oxirene,3,4,5,6,9,9-hexachloro-1a,2,2a,3,6,6a,7,7a-octahydro-, (1aalpha, 2beta, 2abeta, 3alpha, 6alpha, 6abeta, 7beta, 7aalpha)-, & metabolites	1 (0.454)
Dimethoate	10 (4.54)
3,3'-Dimethoxybenzidine	100 (45.4)
Dimethylamine	1000 (454)
Dimethyl aminoazobenzene	10 (4.54)
p-Dimethylaminoazobenzene	10 (4.54)
N,N-Dimethylaniline	100 (45.4)
7,12-Dimethylbenz[a]anthracene	1 (0.454)
3,3'-Dimethylbenzidine	10 (4.54)
alpha, alpha-Dimethylbenzylhydroperoxide	10 (4.54)
Dimethylcarbomoyl chloride	1 (0.454)
Dimethylformamide	100 (45.4)
1,1-Dimethylhydrazine	10 (4.54)
1,2-Dimethylhydrazine	1 (0.454)
Dimethylhydrazine, unsymmetrical®	10 (4.54)
alpha, alpha-Dimethylphenethylamine	5000 (2270)
2,4-Dimethylphenol	100 (45.4)
Dimethyl phthalate	5000 (2270)
Dimethyl sulfate	100 (45.4)
Dimetilan	1 (0.454)
Dinitrobenzene (mixed)	100 (45.4)
m-Dinitrobenzene.	
o-Dinitrobenzene.	
p-Dinitrobenzene.	
4,6-Dinitro-o-cresol, and salts	10 (4.54)
Dinitrogen tetroxide®	10 (4.54)
Dinitrophenol	10 (4.54)
2,5-Dinitrophenol.	
2,6-Dinitrophenol.	
2,4-Dinitrophenol	10 (4.54)
Dinitrotoluene	10 (4.54)
3,4-Dinitrotoluene.	
2,4-Dinitrotoluene	10 (4.54)
2,6-Dinitrotoluene	100 (45.4)
Dinoseb	1000 (454)
Di-n-octyl phthalate	5000 (2270)
1,4-Dioxane	100 (45.4)
1,2-Diphenylhydrazine	10 (4.54)
Diphosphoramidate, octamethyl-	100 (45.4)
Diphosphoric acid, tetraethyl ester	10 (4.54)
Dipropylamine	5000 (2270)
Di-n-propylnitrosamine	10 (4.54)
Diquat	1000 (454)

TABLE 1 TO APPENDIX A—HAZARDOUS SUBSTANCES OTHER THAN RADIONUCLIDES—Continued

Hazardous substance	Reportable quantity (RQ) pounds (kilograms)
Disulfoton	1 (0.454)
Dithiobiuret	100 (45.4)
1,3-Dithiolane-2-carboxaldehyde, 2,4-dimethyl-, O-[(methylamino)-carbonyl]oxime	100 (45.4)
Diuron	100 (45.4)
Dodecylbenzenesulfonic acid	1000 (454)
Endosulfan	1 (0.454)
alpha-Endosulfan	1 (0.454)
beta-Endosulfan	1 (0.454)
Endosulfan sulfate	1 (0.454)
Endothall	1000 (454)
Endrin	1 (0.454)
Endrin aldehyde	1 (0.454)
Endrin, & metabolites	1 (0.454)
Epichlorohydrin	100 (45.4)
Epinephrine	1000 (454)
1,2-Epoxybutane	100 (45.4)
Ethanal	1000 (454)
Ethanamine, N,N-diethyl-	5000 (2270)
Ethanamine, N-ethyl-N-nitroso-	1 (0.454)
1,2-Ethanediamine, N,N-dimethyl-N'-2-pyridinyl-N'-(2-thienylmethyl)-	5000 (2270)
Ethane, 1,2-dibromo-	1 (0.454)
Ethane, 1,1-dichloro-	1000 (454)
Ethane, 1,2-dichloro-	100 (45.4)
Ethanedinitrile	100 (45.4)
Ethane, hexachloro-	100 (45.4)
Ethane, 1,1'-[methylenebis(oxy)]bis[2-chloro-	1000 (454)
Ethane, 1,1'-oxybis-	100 (45.4)
Ethane, 1,1'-oxybis[2-chloro-	10 (4.54)
Ethane, pentachloro-	10 (4.54)
Ethane, 1,1,1,2-tetrachloro-	100 (45.4)
Ethane, 1,1,2,2-tetrachloro-	100 (45.4)
Ethanethioamide	10 (4.54)
Ethane, 1,1,1-trichloro-	1000 (454)
Ethane, 1,1,2-trichloro-	100 (45.4)
Ethanimidothioic acid, 2-(dimethylamino)-N-hydroxy-2-oxo-, methyl ester	5000 (2270)
Ethanimidothioic acid, 2-(dimethylamino)-N-[[[(methylamino) carbonyl]oxy]-2-oxo-, methyl ester	100 (45.4)
Ethanimidothioic acid, N-[[[(methylamino) carbonyl]oxy]-, methyl ester	100 (45.4)
Ethanimidothioic acid, N,N'[[thiobis[(methylimino)carbonyloxy]] bis-, dimethyl ester	100 (45.4)
Ethanol, 2-ethoxy-	1000 (454)
Ethanol, 2,2'-(nitrosoimino)bis-	1 (0.454)
Ethanol, 2,2'-oxybis-, dicarbamate	5000 (2270)
Ethanone, 1-phenyl-	5000 (2270)
Ethene, chloro-	1 (0.454)
Ethene, (2-chloroethoxy)-	1000 (454)
Ethene, 1,1-dichloro-	100 (45.4)
Ethene, 1,2-dichloro-(E)	1000 (454)
Ethene, tetrachloro-	100 (45.4)
Ethene, trichloro-	100 (45.4)
Ethion	10 (4.54)
Ethyl acetate	5000 (2270)
Ethyl acrylate	1000 (454)
Ethylbenzene	1000 (454)
Ethyl carbamate	100 (45.4)
Ethyl chloride	100 (45.4)
Ethyl cyanide	10 (4.54)
Ethylenedisithiocarbamic acid, salts & esters	5000 (2270)
Ethylenediamine	5000 (2270)
Ethylenediamine-tetraacetic acid (EDTA)	5000 (2270)
Ethylene dibromide	1 (0.454)
Ethylene dichloride	100 (45.4)
Ethylene glycol	5000 (2270)
Ethylene glycol monoethyl ether	1000 (454)
Ethylene oxide	10 (4.54)
Ethylenethiourea	10 (4.54)
Ethylenimine	1 (0.454)
Ethyl ether	100 (45.4)
Ethylidene dichloride	1000 (454)
Ethyl methacrylate	1000 (454)
Ethyl methanesulfonate	1 (0.454)
Ethyl methyl ketone®	5000 (2270)

TABLE 1 TO APPENDIX A—HAZARDOUS SUBSTANCES OTHER THAN RADIONUCLIDES—Continued

Hazardous substance	Reportable quantity (RQ) pounds (kilograms)
Famphur	1000 (454)
Ferric ammonium citrate	1000 (454)
Ferric ammonium oxalate	1000 (454)
Ferric chloride	1000 (454)
Ferric fluoride	100 (45.4)
Ferric nitrate	1000 (454)
Ferric sulfate	1000 (454)
Ferrous ammonium sulfate	1000 (454)
Ferrous chloride	100 (45.4)
Ferrous sulfate	1000 (454)
Fluoranthene	100 (45.4)
Fluorene	5000 (2270)
Fluorine	10 (4.54)
Fluoroacetamide	100 (45.4)
Fluoroacetic acid, sodium salt	10 (4.54)
Formaldehyde	100 (45.4)
Formetanate hydrochloride	100 (45.4)
Formic acid	5000 (2270)
Formparanate	100 (45.4)
Fulminic acid, mercury(2+)salt	10 (4.54)
Fumaric acid	5000 (2270)
Furan	100 (45.4)
2-Furancarboxyaldehyde	5000 (2270)
2,5-Furandione	5000 (2270)
Furan, tetrahydro-	1000 (454)
Furfural	5000 (2270)
Furfuran	100 (45.4)
Glucopyranose, 2-deoxy-2-(3-methyl-3-nitrosoureido)-, D-	1 (0.454)
D-Glucose, 2-deoxy-2-[[[(methylnitrosoamino)-carbonyl]amino]-	1 (0.454)
Glycidylaldehyde	10 (4.54)
Guanidine, N-methyl-N'-nitro-N-nitroso-	10 (4.54)
Guthion	1 (0.454)
Heptachlor	1 (0.454)
Heptachlor epoxide	1 (0.454)
Hexachlorobenzene	10 (4.54)
Hexachlorobutadiene	1 (0.454)
Hexachlorocyclopentadiene	10 (4.54)
Hexachloroethane	100 (45.4)
Hexachlorophene	100 (45.4)
Hexachloropropene	1000 (454)
Hexaethyl tetraphosphate	100 (45.4)
Hexamethylene-1,6-diisocyanate	100 (45.4)
Hexamethylphosphoramide	1 (0.454)
Hexane	5000 (2270)
Hexone	5000 (2270)
Hydrazine	1 (0.454)
Hydrazinecarbothioamide	100 (45.4)
Hydrazine, 1,2-diethyl-	10 (4.54)
Hydrazine, 1,1-dimethyl-	10 (4.54)
Hydrazine, 1,2-dimethyl-	1 (0.454)
Hydrazine, 1,2-diphenyl-	10 (4.54)
Hydrazine, methyl-	10 (4.54)
Hydrochloric acid	5000 (2270)
Hydrocyanic acid	10 (4.54)
Hydrofluoric acid	100 (45.4)
Hydrogen chloride	5000 (2270)
Hydrogen cyanide	10 (4.54)
Hydrogen fluoride	100 (45.4)
Hydrogen phosphide	100 (45.4)
Hydrogen sulfide H2S	100 (45.4)
Hydroperoxide, 1-methyl-1-phenylethyl-	10 (4.54)
Hydroquinone	100 (45.4)
2-Imidazolidinethione	10 (4.54)
Indeno(1,2,3-cd)pyrene	100 (45.4)
Iodomethane	100 (45.4)
1,3-Isobenzofurandione	5000 (2270)
Isobutyl alcohol	5000 (2270)
Isodrin	1 (0.454)
Isolan	100 (45.4)
Isophorone	5000 (2270)

TABLE 1 TO APPENDIX A—HAZARDOUS SUBSTANCES OTHER THAN RADIONUCLIDES—Continued

Hazardous substance	Reportable quantity (RQ) pounds (kilograms)
Isoprene	100 (45.4)
Isopropanolamine dodecylbenzenesulfonate	1000 (454)
3-Isopropylphenyl N-methylcarbamate	10 (4.54)
Isosafrole	100 (45.4)
3(2H)-Isoxazolone, 5-(aminomethyl)-	1000 (454)
Kepon	1 (0.454)
Lasiocarpine	10 (4.54)
Lead	10 (4.54)
Lead acetate	10 (4.54)
Lead arsenate	1 (0.454)
Lead, bis(acetato-O)tetrahydroxytri-	10 (4.54)
Lead chloride	10 (4.54)
Lead fluoborate	10 (4.54)
Lead fluoride	10 (4.54)
Lead iodide	10 (4.54)
Lead nitrate	10 (4.54)
Lead phosphate	10 (4.54)
Lead stearate	10 (4.54)
Lead subacetate	10 (4.54)
Lead sulfate	10 (4.54)
Lead sulfide	10 (4.54)
Lead thiocyanate	10 (4.54)
Lindane	1 (0.454)
Lindane (all isomers)	1 (0.454)
Lithium chromate	10 (4.54)
Malathion	100 (45.4)
Maleic acid	5000 (2270)
Maleic anhydride	5000 (2270)
Maleic hydrazide	5000 (2270)
Malononitrile	1000 (454)
Manganese, bis(dimethylcarbamodithioato-S,S')	10 (4.54)
Manganese dimethylthiocarbamate	10 (4.54)
MDI	5000 (2270)
MEK	5000 (2270)
Melphalan	1 (0.454)
Mercaptodimethur	10 (4.54)
Mercuric cyanide	1 (0.454)
Mercuric nitrate	10 (4.54)
Mercuric sulfate	10 (4.54)
Mercuric thiocyanate	10 (4.54)
Mercurous nitrate	10 (4.54)
Mercury	1 (0.454)
Mercury, (acetato-O)phenyl-	100 (45.4)
Mercury fulminate	10 (4.54)
Methacrylonitrile	1000 (454)
Methanamine, N-methyl-	1000 (454)
Methanamine, N-methyl-N-nitroso-	10 (4.54)
Methane, bromo-	1000 (454)
Methane, chloro-	100 (45.4)
Methane, chloromethoxy-	10 (4.54)
Methane, dibromo-	1000 (454)
Methane, dichloro-	1000 (454)
Methane, dichlorodifluoro-	5000 (2270)
Methane, iodo-	100 (45.4)
Methane, isocyanato-	10 (4.54)
Methane, oxybis(chloro-	10 (4.54)
Methanesulfonyl chloride, trichloro-	100 (45.4)
Methanesulfonic acid, ethyl ester	1 (0.454)
Methane, tetrachloro-	10 (4.54)
Methane, tetranitro-	10 (4.54)
Methanethiol	100 (45.4)
Methane, tribromo-	100 (45.4)
Methane, trichloro-	10 (4.54)
Methane, trichlorofluoro-	5000 (2270)
Methanimidamide, N,N-dimethyl-N'-[3-[(methylamino) carbonyl] oxy] phenyl]-, monohydrochloride	100 (45.4)
Methanimidamide, N,N-dimethyl-N'-[2-methyl-4-[(methylamino) carbonyl] oxy]phenyl]-	100 (45.4)
6,9-Methano-2,4,3-benzodioxathiepin,6,7,8,9,10,10-hexachloro-1,5,5a,6,9,9a-hexahydro-, 3-oxide	1 (0.454)
4,7-Methano-1H-indene, 1,4,5,6,7,8,8-heptachloro-3a,4,7,7a-tetrahydro-	1 (0.454)
4,7-Methano-1H-indene, 1,2,4,5,6,7,8,8-octachloro-2,3,3a,4,7,7a-hexahydro-	1 (0.454)

TABLE 1 TO APPENDIX A—HAZARDOUS SUBSTANCES OTHER THAN RADIONUCLIDES—Continued

Hazardous substance	Reportable quantity (RQ) pounds (kilograms)
Methanol	5000 (2270)
Methapyriene	5000 (2270)
1,3,4-Metheno-2H-cyclobuta[cd]pentalen-2-one, 1,1a,3,3a,4,5,5,5a,5b,6-decachlorooctahydro-	1 (0.454)
Methiocarb	10 (4.54)
Methomyl	100 (45.4)
Methoxychlor	1 (0.454)
Methyl alcohol	5000 (2270)
Methylamine ®	100 (45.4)
2-Methyl aziridine	1 (0.454)
Methyl bromide	1000 (454)
1-Methylbutadiene	100 (45.4)
Methyl chloride	100 (45.4)
Methyl chlorocarbonate	1000 (454)
Methyl chloroform	1000 (454)
Methyl chloroformate ®	1000 (454)
Methyl chloromethyl ether ®	10 (4.54)
3-Methylcholanthrene	10 (4.54)
4,4'-Methylenebis(2-chloroaniline)	10 (4.54)
Methylene bromide	1000 (454)
Methylene chloride	1000 (454)
4,4'-Methylenedianiline	10 (4.54)
Methylene diphenyl diisocyanate	5000 (2270)
Methyl ethyl ketone	5000 (2270)
Methyl ethyl ketone peroxide	10 (4.54)
Methyl hydrazine	10 (4.54)
Methyl iodide	100 (45.4)
Methyl isobutyl ketone	5000 (2270)
Methyl isocyanate	10 (4.54)
2-Methylacetonitrile	10 (4.54)
Methyl mercaptan	100 (45.4)
Methyl methacrylate	1000 (454)
Methyl parathion	100 (45.4)
4-Methyl-2-pentanone	5000 (2270)
Methyl tert-butyl ether	1000 (454)
Methylthiouracil	10 (4.54)
Metolcarb	1000 (454)
Mevinphos	10 (4.54)
Mexacarbate	1000 (454)
Mitomycin C	10 (4.54)
MNNG	10 (4.54)
Monoethylamine	100 (45.4)
Monomethylamine	100 (45.4)
Naled	10 (4.54)
5,12-Naphthacenedione, 8-acetyl-10-[(3-amino-2,3,6-trideoxy-alpha-L-lyxo-hexopyranosyl)oxy]-7,8,9,10-tetrahydro-6,8,11-trihydroxy-1-methoxy-, (8S-cis)-	10 (4.54)
1-Naphthalenamine	100 (45.4)
2-Naphthalenamine	10 (4.54)
Naphthalenamine, N,N'-bis(2-chloroethyl)-	100 (45.4)
Naphthalene	100 (45.4)
Naphthalene, 2-chloro-	5000 (2270)
1,4-Naphthalenedione	5000 (2270)
2,7-Naphthalenedisulfonic acid, 3,3'-[(3,3'-dimethyl-(1,1'-biphenyl)-4,4'-diyl)-bis(azo)]bis(5-amino-4-hydroxy)-tetrasodium salt	10 (4.54)
1-Naphthalenol, methylcarbamate	100 (45.4)
Naphthenic acid	100 (45.4)
1,4-Naphthoquinone	5000 (2270)
alpha-Naphthylamine	100 (45.4)
beta-Naphthylamine	10 (4.54)
alpha-Naphthylthiourea	100 (45.4)
Nickel ¢	100 (45.4)
Nickel ammonium sulfate	100 (45.4)
Nickel carbonyl Ni(CO)4, (T-4)-	10 (4.54)
Nickel chloride	100 (45.4)
Nickel cyanide Ni(CN)2	10 (4.54)
Nickel hydroxide	10 (4.54)
Nickel nitrate	100 (45.4)
Nickel sulfate	100 (45.4)
Nicotine, & salts	100 (45.4)
Nitric acid	1000 (454)
Nitric acid, thallium (1+) salt	100 (45.4)

TABLE 1 TO APPENDIX A—HAZARDOUS SUBSTANCES OTHER THAN RADIONUCLIDES—Continued

Hazardous substance	Reportable quantity (RQ) pounds (kilograms)
Nitric oxide	10 (4.54)
p-Nitroaniline	5000 (2270)
Nitrobenzene	1000 (454)
4-Nitrobiphenyl	10 (4.54)
Nitrogen dioxide	10 (4.54)
Nitrogen oxide NO	10 (4.54)
Nitrogen oxide NO ₂	10 (4.54)
Nitroglycerine	10 (4.54)
Nitrophenol (mixed)	100 (45.4)
m-Nitrophenol.	
o-Nitrophenol	100 (45.4)
p-Nitrophenol	100 (45.4)
2-Nitrophenol	100 (45.4)
4-Nitrophenol	100 (45.4)
2-Nitropropane	10 (4.54)
N-Nitrosodi-n-butylamine	10 (4.54)
N-Nitrosodiethanolamine	1 (0.454)
N-Nitrosodiethylamine	1 (0.454)
N-Nitrosodimethylamine	10 (4.54)
N-Nitrosodiphenylamine	100 (45.4)
N-Nitroso-N-ethylurea	1 (0.454)
N-Nitroso-N-methylurea	1 (0.454)
N-Nitroso-N-methylurethane	1 (0.454)
N-Nitrosomethylvinylamine	10 (4.54)
N-Nitrosomorpholine	1 (0.454)
N-Nitrosopiperidine	10 (4.54)
N-Nitrosopyrrolidine	1 (0.454)
Nitrotoluene	1000 (454)
m-Nitrotoluene.	
o-Nitrotoluene.	
p-Nitrotoluene.	
5-Nitro-o-toluidine	100 (45.4)
Octamethylpyrophosphoramidate	100 (45.4)
Osmium oxide OsO ₄ , (T-4)	1000 (454)
Osmium tetroxide	1000 (454)
7-Oxabicyclo[2.2.1]heptane-2,3-dicarboxylic acid	1000 (454)
Oxamyl	100 (45.4)
1,2-Oxathiolane, 2,2-dioxide	10 (4.54)
2H-1,3,2-Oxazaphosphorin-2-amine, N,N-bis(2-chloroethyl) tetrahydro-, 2-oxide	10 (4.54)
Oxirane	10 (4.54)
Oxiranecarboxyaldehyde	10 (4.54)
Oxirane, (chloromethyl)-	100 (45.4)
Paraformaldehyde	1000 (454)
Paraldehyde	1000 (454)
Parathion	10 (4.54)
PCBs	1 (0.454)
PCNB	100 (45.4)
Pentachlorobenzene	10 (4.54)
Pentachloroethane	10 (4.54)
Pentachloronitrobenzene	100 (45.4)
Pentachlorophenol	10 (4.54)
1,3-Pentadiene	100 (45.4)
Perchloroethylene	100 (45.4)
Perchloromethyl mercaptan®	100 (45.4)
Phenacetin	100 (45.4)
Phenanthrene	5000 (2270)
Phenol	1000 (454)
Phenol, 2-chloro-	100 (45.4)
Phenol, 4-chloro-3-methyl-	5000 (2270)
Phenol, 2-cyclohexyl-4,6-dinitro-	100 (45.4)
Phenol, 2,4-dichloro-	100 (45.4)
Phenol, 2,6-dichloro-	100 (45.4)
Phenol, 4,4'-(1,2-diethyl-1,2-ethenediyl)bis-, (E)	1 (0.454)
Phenol, 2,4-dimethyl-	100 (45.4)
Phenol, 4-(dimethylamino)-3,5-dimethyl-, methylcarbamate (ester)	1000 (454)
Phenol, (3,5-dimethyl-4-(methylthio)-, methylcarbamate	10 (4.54)
Phenol, 2,4-dinitro-	10 (4.54)
Phenol, methyl-	100 (45.4)
Phenol, 2-methyl-4,6-dinitro-, & salts	10 (4.54)
Phenol, 2,2'-methylenebis[3,4,6-trichloro-	100 (45.4)

TABLE 1 TO APPENDIX A—HAZARDOUS SUBSTANCES OTHER THAN RADIONUCLIDES—Continued

Hazardous substance	Reportable quantity (RQ) pounds (kilograms)
Phenol, 2-(1-methylethoxy)-, methylcarbamate	100 (45.4)
Phenol, 3-(1-methylethyl)-, methyl carbamate	10 (4.54)
Phenol, 3-methyl-5-(1-methylethyl)-, methyl carbamate	1000 (454)
Phenol, 2-(1-methylpropyl)-4,6-dinitro-	1000 (454)
Phenol, 4-nitro-	100 (45.4)
Phenol, pentachloro-	10 (4.54)
Phenol, 2,3,4,6-tetrachloro-	10 (4.54)
Phenol, 2,4,5-trichloro-	10 (4.54)
Phenol, 2,4,6-trichloro-	10 (4.54)
Phenol, 2,4,6-trinitro-, ammonium salt	10 (4.54)
L-Phenylalanine, 4-[bis(2-chloroethyl)amino]-	1 (0.454)
p-Phenylenediamine	5000 (2270)
Phenyl mercaptan [®]	100 (45.4)
Phenylmercury acetate	100 (45.4)
Phenylthiourea	100 (45.4)
Phorate	10 (4.54)
Phosgene	10 (4.54)
Phosphine	100 (45.4)
Phosphoric acid	5000 (2270)
Phosphoric acid, diethyl 4-nitrophenyl ester	100 (45.4)
Phosphoric acid, lead(2+) salt (2:3)	10 (4.54)
Phosphorodithioic acid, O,O-diethyl S-[2-(ethylthio)ethyl] ester	1 (0.454)
Phosphorodithioic acid, O,O-diethyl S-[(ethylthio)methyl] ester	10 (4.54)
Phosphorodithioic acid, O,O-diethyl S-methyl ester	5000 (2270)
Phosphorodithioic acid, O,O-dimethyl S-[2-(methylamino)-2-oxoethyl] ester	10 (4.54)
Phosphorofluoric acid, bis(1-methylethyl) ester	100 (45.4)
Phosphorothioic acid, O,O-diethyl O-(4-nitrophenyl) ester	10 (4.54)
Phosphorothioic acid, O,O-diethyl O-pyrazinyl ester	100 (45.4)
Phosphorothioic acid, O-[4-[(dimethylamino) sulfonyl]phenyl] O,O-dimethyl ester	1000 (454)
Phosphorothioic acid, O,O-dimethyl O-(4-nitrophenyl) ester	100 (45.4)
Phosphorus	1 (0.454)
Phosphorus oxychloride	1000 (454)
Phosphorus pentasulfide	100 (45.4)
Phosphorus sulfide	100 (45.4)
Phosphorus trichloride	1000 (454)
Phthalic anhydride	5000 (2270)
Physostigmine	100 (45.4)
Physostigmine salicylate	100 (45.4)
2-Picoline	5000 (2270)
Piperidine, 1-nitroso-	10 (4.54)
Plumbane, tetraethyl-	10 (4.54)
POLYCHLORINATED BIPHENYLS	1 (0.454)
Potassium arsenate	1 (0.454)
Potassium arsenite	1 (0.454)
Potassium bichromate	10 (4.54)
Potassium chromate	10 (4.54)
Potassium cyanide K(CN)	10 (4.54)
Potassium hydroxide	1000 (454)
Potassium permanganate	100 (45.4)
Potassium silver cyanide	1 (0.454)
Promecarb	1000 (454)
Pronamide	5000 (2270)
Propanal, 2-methyl-2-(methyl-sulfonyl)-, O-[(methylamino)carbonyl] oxime	100 (45.4)
Propanal, 2-methyl-2-(methylthio)-, O-[(methylamino)carbonyl] oxime	1 (0.454)
1-Propanamine	5000 (2270)
1-Propanamine, N-propyl-	5000 (2270)
1-Propanamine, N-nitroso-N-propyl-	10 (4.54)
Propane, 1,2-dibromo-3-chloro-	1 (0.454)
Propane, 1,2-dichloro-	1000 (454)
Propanedinitrile	1000 (454)
Propanenitrile	10 (4.54)
Propanenitrile, 3-chloro-	1000 (454)
Propanenitrile, 2-hydroxy-2-methyl-	10 (4.54)
Propane, 2-nitro-	10 (4.54)
Propane, 2,2'-oxybis[2-chloro-	1000 (454)
1,3-Propane sultone	10 (4.54)
1,2,3-Propanetriol, trinitrate	10 (4.54)
Propanoic acid, 2-(2,4,5-trichlorophenoxy)-	100 (45.4)
1-Propanol, 2,3-dibromo-, phosphate (3:1)	10 (4.54)
1-Propanol, 2-methyl-	5000 (2270)

TABLE 1 TO APPENDIX A—HAZARDOUS SUBSTANCES OTHER THAN RADIONUCLIDES—Continued

Hazardous substance	Reportable quantity (RQ) pounds (kilograms)
2-Propanone	5000 (2270)
2-Propanone, 1-bromo-	1000 (454)
Propargite	10 (4.54)
Propargyl alcohol	1000 (454)
2-Propenal	1 (0.454)
2-Propenamide	5000 (2270)
1-Propene, 1,3-dichloro-	100 (45.4)
1-Propene, 1,1,2,3,3,3-hexachloro-	1000 (454)
2-Propenenitrile	100 (45.4)
2-Propenenitrile, 2-methyl-	1000 (454)
2-Propenoic acid	5000 (2270)
2-Propenoic acid, ethyl ester	1000 (454)
2-Propenoic acid, 2-methyl-, ethyl ester	1000 (454)
2-Propenoic acid, 2-methyl-, methyl ester	1000 (454)
2-Propen-1-ol	100 (45.4)
Propham	1000 (454)
beta-Propiolactone	10 (4.54)
Propionaldehyde	1000 (454)
Propionic acid	5000 (2270)
Propionic anhydride	5000 (2270)
Propoxur (Baygon)	100 (45.4)
n-Propylamine	5000 (2270)
Propylene dichloride	1000 (454)
Propylene oxide	100 (45.4)
1,2-Propylenimine	1 (0.454)
2-Propyn-1-ol	1000 (454)
Prosulfocarb	5000 (2270)
Pyrene	5000 (2270)
Pyrethrins	1 (0.454)
3,6-Pyridazinedione, 1,2-dihydro-	5000 (2270)
4-Pyridinamine	1000 (454)
Pyridine	1000 (454)
Pyridine, 2-methyl-	5000 (2270)
Pyridine, 3-(1-methyl-2-pyrrolidinyl)-, (S)-, & salts	100 (45.4)
2,4-(1H,3H)-Pyrimidinedione, 5-[bis(2-chloroethyl)amino]-	10 (4.54)
4(1H)-Pyrimidinone, 2,3-dihydro-6-methyl-2-thioxo-	10 (4.54)
Pyrrolidine, 1-nitroso-	1 (0.454)
Pyrrolo[2,3-b] indol-5-ol, 1,2,3,3a,8,8a-hexahydro-1,3a,8-trimethyl-, methylcarbamate (ester), (3aS-cis)-	100 (45.4)
Quinoline	5000 (2270)
Quinone	10 (4.54)
Quintobenzene	100 (45.4)
RADIONUCLIDES	See Table 2
Reserpine	5000 (2270)
Resorcinol	5000 (2270)
Safrole	100 (45.4)
Selenious acid	10 (4.54)
Selenious acid, dithallium (1+) salt	1000 (454)
Selenium e	100 (45.4)
Selenium dioxide	10 (4.54)
Selenium oxide	10 (4.54)
Selenium sulfide SeS2	10 (4.54)
Selenourea	1000 (454)
L-Serine, diazoacetate (ester)	1 (0.454)
Silver e	1000 (454)
Silver cyanide Ag(CN)	1 (0.454)
Silver nitrate	1 (0.454)
Silvex (2,4,5-TP)	100 (45.4)
Sodium	10 (4.54)
Sodium arsenate	1 (0.454)
Sodium arsenite	1 (0.454)
Sodium azide	1000 (454)
Sodium bichromate	10 (4.54)
Sodium bifluoride	100 (45.4)
Sodium bisulfite	5000 (2270)
Sodium chromate	10 (4.54)
Sodium cyanide Na(CN)	10 (4.54)
Sodium dodecylbenzenesulfonate	1000 (454)
Sodium fluoride	1000 (454)
Sodium hydrosulfide	5000 (2270)
Sodium hydroxide	1000 (454)

TABLE 1 TO APPENDIX A—HAZARDOUS SUBSTANCES OTHER THAN RADIONUCLIDES—Continued

Hazardous substance	Reportable quantity (RQ) pounds (kilograms)
Sodium hypochlorite	100 (45.4)
Sodium methylate	1000 (454)
Sodium nitrite	100 (45.4)
Sodium phosphate, dibasic	5000 (2270)
Sodium phosphate, tribasic	5000 (2270)
Sodium selenite	100 (45.4)
Streptozotocin	1 (0.454)
Strontium chromate	10 (4.54)
Strychnidin-10-one, & salts	10 (4.54)
Strychnidin-10-one, 2,3-dimethoxy-	100 (45.4)
Strychnine, & salts	10 (4.54)
Styrene	1000 (454)
Styrene oxide	100 (45.4)
Sulfur chlorides®	1000 (454)
Sulfuric acid	1000 (454)
Sulfuric acid, dimethyl ester	100 (45.4)
Sulfuric acid, dithallium (1+) salt	100 (45.4)
Sulfur monochloride	1000 (454)
Sulfur phosphide	100 (45.4)
2,4,5-T	1000 (454)
2,4,5-T acid	1000 (454)
2,4,5-T amines	5000 (2270)
2,4,5-T esters	1000 (454)
2,4,5-T salts	1000 (454)
TCDD	1 (0.454)
TDE	1 (0.454)
1,2,4,5-Tetrachlorobenzene	5000 (2270)
2,3,7,8-Tetrachlorodibenzo-p-dioxin	1 (0.454)
1,1,1,2-Tetrachloroethane	100 (45.4)
1,1,2,2-Tetrachloroethane	100 (45.4)
Tetrachloroethylene	100 (45.4)
2,3,4,6-Tetrachlorophenol	10 (4.54)
Tetraethyl pyrophosphate	10 (4.54)
Tetraethyl lead	10 (4.54)
Tetraethyldithiopyrophosphate	100 (45.4)
Tetrahydrofuran	1000 (454)
Tetranitromethane	10 (4.54)
Tetraphosphoric acid, hexaethyl ester	100 (45.4)
Thallic oxide	100 (45.4)
Thallium e	1000 (454)
Thallium (I) acetate	100 (45.4)
Thallium (I) carbonate	100 (45.4)
Thallium chloride TlCl	100 (45.4)
Thallium (I) nitrate	100 (45.4)
Thallium oxide Tl ₂ O ₃	100 (45.4)
Thallium (I) selenite	1000 (454)
Thallium (I) sulfate	100 (45.4)
Thioacetamide	10 (4.54)
Thiodicarb	100 (45.4)
Thiodiphosphoric acid, tetraethyl ester	100 (45.4)
Thiofanox	100 (45.4)
Thioimidodicarbonic diamide [(H ₂ N)C(S)] ₂ NH	100 (45.4)
Thiomethanol	100 (45.4)
Thioperoxydicarbonic diamide [(H ₂ N)C(S)] ₂ S ₂ , tetramethyl-	10 (4.54)
Thiophanate-methyl	10 (4.54)
Thiophenol	100 (45.4)
Thiosemicarbazide	100 (45.4)
Thiourea	10 (4.54)
Thiourea, (2-chlorophenyl)-	100 (45.4)
Thiourea, 1-naphthalenyl-	100 (45.4)
Thiourea, phenyl-	100 (45.4)
Thiram	10 (4.54)
Tirpate	100 (45.4)
Titanium tetrachloride	1000 (454)
Toluene	1000 (454)
Toluenediamine	10 (4.54)
2,4-Toluene diamine	10 (4.54)
Toluene diisocyanate	100 (45.4)
2,4-Toluene diisocyanate	100 (45.4)
o-Toluidine	100 (45.4)

TABLE 1 TO APPENDIX A—HAZARDOUS SUBSTANCES OTHER THAN RADIONUCLIDES—Continued

Hazardous substance	Reportable quantity (RQ) pounds (kilograms)
p-Toluidine	100 (45.4)
o-Toluidine hydrochloride	100 (45.4)
Toxaphene	1 (0.454)
2,4,5-TP acid	100 (45.4)
2,4,5-TP esters	100 (45.4)
Triallate	100 (45.4)
1H-1,2,4-Triazol-3-amine	10 (4.54)
Trichlorfon	100 (45.4)
1,2,4-Trichlorobenzene	100 (45.4)
1,1,1-Trichloroethane	1000 (454)
1,1,2-Trichloroethane	100 (45.4)
Trichloroethylene	100 (45.4)
Trichloromethanesulfonyl chloride	100 (45.4)
Trichloromonofluoromethane	5000 (2270)
Trichlorophenol	10 (4.54)
2,3,4-Trichlorophenol	
2,3,5-Trichlorophenol	
2,3,6-Trichlorophenol	
3,4,5-Trichlorophenol	
2,4,5-Trichlorophenol	10 (4.54)
2,4,6-Trichlorophenol	10 (4.54)
Triethanolamine dodecylbenzenesulfonate	1000 (454)
Triethylamine	5000 (2270)
Trifluralin	10 (4.54)
Trimethylamine	100 (45.4)
2,2,4-Trimethylpentane	1000 (454)
1,3,5-Trinitrobenzene	10 (4.54)
1,3,5-Trioxane, 2,4,6-trimethyl-	1000 (454)
Tris(2,3-dibromopropyl) phosphate	10 (4.54)
Trypan blue	10 (4.54)
D002 Unlisted Hazardous Wastes Characteristic of Corrosivity	100 (45.4)
D001 Unlisted Hazardous Wastes Characteristic of Ignitability	100 (45.4)
D003 Unlisted Hazardous Wastes Characteristic of Reactivity	100 (45.4)
D004–D043 Unlisted Hazardous Wastes Characteristic of Toxicity:	
Arsenic (D004)	1 (0.454)
Barium (D005)	1000 (454)
Benzene (D018)	10 (4.54)
Cadmium (D006)	10 (4.54)
Carbon tetrachloride (D019)	10 (4.54)
Chlordane (D020)	1 (0.454)
Chlorobenzene (D021)	100 (45.4)
Chloroform (D022)	10 (4.54)
Chromium (D007)	10 (4.54)
o-Cresol (D023)	100 (45.4)
m-Cresol (D024)	100 (45.4)
p-Cresol (D025)	100 (45.4)
Cresol (D026)	100 (45.4)
2,4-D (D016)	100 (45.4)
1,4-Dichlorobenzene (D027)	100 (45.4)
1,2-Dichloroethane (D028)	100 (45.4)
1,1-Dichloroethylene (D029)	100 (45.4)
2,4-Dinitrotoluene (D030)	10 (4.54)
Endrin (D012)	1 (0.454)
Heptachlor (and epoxide) (D031)	1 (0.454)
Hexachlorobenzene (D032)	10 (4.54)
Hexachlorobutadiene (D033)	1 (0.454)
Hexachloroethane (D034)	100 (45.4)
Lead (D008)	10 (4.54)
Lindane (D013)	1 (0.454)
Mercury (D009)	1 (0.454)
Methoxychlor (D014)	1 (0.454)
Methyl ethyl ketone (D035)	5000 (2270)
Nitrobenzene (D036)	1000 (454)
Pentachlorophenol (D037)	10 (4.54)
Pyridine (D038)	1000 (454)
Selenium (D010)	10 (4.54)
Silver (D011)	1 (0.454)
Tetrachloroethylene (D039)	100 (45.4)
Toxaphene (D015)	1 (0.454)
Trichloroethylene (D040)	100 (45.4)

TABLE 1 TO APPENDIX A—HAZARDOUS SUBSTANCES OTHER THAN RADIONUCLIDES—Continued

Hazardous substance	Reportable quantity (RQ) pounds (kilograms)
2,4,5-Trichlorophenol (D041)	10 (4.54)
2,4,6-Trichlorophenol (D042)	10 (4.54)
2,4,5-TP (D017)	100 (45.4)
Vinyl chloride (D043)	1 (0.454)
Uracil mustard	10 (4.54)
Uranyl acetate	100 (45.4)
Uranyl nitrate	100 (45.4)
Urea, N-ethyl-N-nitroso-	1 (0.454)
Urea, N-methyl-N-nitroso-	1 (0.454)
Urethane	100 (45.4)
Vanadic acid, ammonium salt	1000 (454)
Vanadium oxide V ₂ O ₅	1000 (454)
Vanadium pentoxide	1000 (454)
Vanadyl sulfate	1000 (454)
Vinyl acetate	5000 (2270)
Vinyl acetate monomer	5000 (2270)
Vinylamine, N-methyl-N-nitroso-	10 (4.54)
Vinyl bromide	100 (45.4)
Vinyl chloride	1 (0.454)
Vinylidene chloride	100 (45.4)
Warfarin, & salts	100 (45.4)
Xylene	100 (45.4)
m-Xylene	1000 (454)
o-Xylene	1000 (454)
p-Xylene	100 (45.4)
Xylene (mixed)	100 (45.4)
Xylenes (isomers and mixture)	100 (45.4)
Xylenol	1000 (454)
Yohimban-16-carboxylic acid, 11,17-dimethoxy-18-[(3,4,5-trimethoxybenzoyl) oxy]-, methyl ester (3beta,16beta,17alpha,18beta, 20alpha)	5000 (2270)
Zinc ϵ	1000 (454)
Zinc acetate	1000 (454)
Zinc ammonium chloride	1000 (454)
Zinc, bis(dimethylcarbamodithioato-S,S')-	10 (4.54)
Zinc borate	1000 (454)
Zinc bromide	1000 (454)
Zinc carbonate	1000 (454)
Zinc chloride	1000 (454)
Zinc cyanide Zn(CN) ₂	10 (4.54)
Zinc fluoride	1000 (454)
Zinc formate	1000 (454)
Zinc hydrosulfite	1000 (454)
Zinc nitrate	1000 (454)
Zinc phenolsulfonate	5000 (2270)
Zinc phosphide Zn ₃ P ₂	100 (45.4)
Zinc silicofluoride	5000 (2270)
Zinc sulfate	1000 (454)
Ziram	10 (4.54)
Zirconium nitrate	5000 (2270)
Zirconium potassium fluoride	1000 (454)
Zirconium sulfate	5000 (2270)
Zirconium tetrachloride	5000 (2270)
F001	10 (4.54)
(a) Tetrachloroethylene	100 (45.4)
(b) Trichloroethylene	100 (45.4)
(c) Methylene chloride	1000 (454)
(d) 1,1,1-Trichloroethane	1000 (454)
(e) Carbon tetrachloride	10 (4.54)
(f) Chlorinated fluorocarbons	5000 (2270)
F002	10 (4.54)
(a) Tetrachloroethylene	100 (45.4)
(b) Methylene chloride	1000 (454)
(c) Trichloroethylene	100 (45.4)
(d) 1,1,1-Trichloroethane	1000 (454)
(e) Chlorobenzene	100 (45.4)
(f) 1,1,2-Trichloro-1,2,2-trifluoroethane	5000 (2270)
(g) o-Dichlorobenzene	100 (45.4)
(h) Trichlorofluoromethane	5000 (2270)
(i) 1,1,2-Trichloroethane	100 (45.4)
F003	100 (45.4)

TABLE 1 TO APPENDIX A—HAZARDOUS SUBSTANCES OTHER THAN RADIONUCLIDES—Continued

Hazardous substance	Reportable quantity (RQ) pounds (kilograms)
(a) Xylene	1000 (454)
(b) Acetone	5000 (2270)
(c) Ethyl acetate	5000 (2270)
(d) Ethylbenzene	1000 (454)
(e) Ethyl ether	100 (45.4)
(f) Methyl isobutyl ketone	5000 (2270)
(g) n-Butyl alcohol	5000 (2270)
(h) Cyclohexanone	5000 (2270)
(i) Methanol	5000 (2270)
F004	100 (45.4)
(a) Cresols/Cresylic acid	100 (45.4)
(b) Nitrobenzene	1000 (454)
F005	100 (45.4)
(a) Toluene	1000 (454)
(b) Methyl ethyl ketone	5000 (2270)
(c) Carbon disulfide	100 (45.4)
(d) Isobutanol	5000 (2270)
(e) Pyridine	1000 (454)
F006	10 (4.54)
F007	10 (4.54)
F008	10 (4.54)
F009	10 (4.54)
F010	10 (4.54)
F011	10 (4.54)
F012	10 (4.54)
F019	10 (4.54)
F020	1 (0.454)
F021	1 (0.454)
F022	1 (0.454)
F023	1 (0.454)
F024	1 (0.454)
F025	1 (0.454)
F026	1 (0.454)
F027	1 (0.454)
F028	1 (0.454)
F032	1 (0.454)
F034	1 (0.454)
F035	1 (0.454)
F037	1 (0.454)
F038	1 (0.454)
F039	1 (0.454)
K001	1 (0.454)
K002	10 (4.54)
K003	10 (4.54)
K004	10 (4.54)
K005	10 (4.54)
K006	10 (4.54)
K007	10 (4.54)
K008	10 (4.54)
K009	10 (4.54)
K010	10 (4.54)
K011	10 (4.54)
K013	10 (4.54)
K014	5000 (2270)
K015	10 (4.54)
K016	1 (0.454)
K017	10 (4.54)
K018	1 (0.454)
K019	1 (0.454)
K020	1 (0.454)
K021	10 (4.54)
K022	1 (0.454)
K023	5000 (2270)
K024	5000 (2270)
K025	10 (4.54)
K026	1000 (454)
K027	10 (4.54)
K028	1 (0.454)
K029	1 (0.454)
K030	1 (0.454)

TABLE 1 TO APPENDIX A—HAZARDOUS SUBSTANCES OTHER THAN RADIONUCLIDES—Continued

Hazardous substance	Reportable quantity (RQ) pounds (kilograms)
K031	1 (0.454)
K032	10 (4.54)
K033	10 (4.54)
K034	10 (4.54)
K035	1 (0.454)
K036	1 (0.454)
K037	1 (0.454)
K038	10 (4.54)
K039	10 (4.54)
K040	10 (4.54)
K041	1 (0.454)
K042	10 (4.54)
K043	10 (4.54)
K044	10 (4.54)
K045	10 (4.54)
K046	10 (4.54)
K047	10 (4.54)
K048	10 (4.54)
K049	10 (4.54)
K050	10 (4.54)
K051	10 (4.54)
K052	10 (4.54)
K060	1 (0.454)
K061	10 (4.54)
K062	10 (4.54)
K064	10 (4.54)
K065	10 (4.54)
K066	10 (4.54)
K069	10 (4.54)
K071	1 (0.454)
K073	10 (4.54)
K083	100 (45.4)
K084	1 (0.454)
K085	10 (4.54)
K086	10 (4.54)
K087	100 (45.4)
K088	10 (4.54)
K090	10 (4.54)
K091	10 (4.54)
K093	5000 (2270)
K094	5000 (2270)
K095	100 (45.4)
K096	100 (45.4)
K097	1 (0.454)
K098	1 (0.454)
K099	10 (4.54)
K100	10 (4.54)
K101	1 (0.454)
K102	1 (0.454)
K103	100 (45.4)
K104	10 (4.54)
K105	10 (4.54)
K106	1 (0.454)
K107	10 (4.54)
K108	10 (4.54)
K109	10 (4.54)
K110	10 (4.54)
K111	10 (4.54)
K112	10 (4.54)
K113	10 (4.54)
K114	10 (4.54)
K115	10 (4.54)
K116	10 (4.54)
K117	1 (0.454)
K118	1 (0.454)
K123	10 (4.54)
K124	10 (4.54)
K125	10 (4.54)
K126	10 (4.54)
K131	100 (45.4)

TABLE 1 TO APPENDIX A—HAZARDOUS SUBSTANCES OTHER THAN RADIONUCLIDES—Continued

Hazardous substance	Reportable quantity (RQ) pounds (kilograms)
K132	1000 (454)
K136	1 (0.454)
K141	1 (0.454)
K142	1 (0.454)
K143	1 (0.454)
K144	1 (0.454)
K145	1 (0.454)
K147	1 (0.454)
K148	1 (0.454)
K149	10 (4.54)
K150	10 (4.54)
K151	10 (4.54)
K156	10 (4.54)
K157	10 (4.54)
K158	10 (4.54)
K159	10 (4.54)
K161	1 (0.454)
K169	10 (4.54)
K170	1 (0.454)
K171	1 (0.454)
K172	1 (0.454)
K174	1 (0.454)
K175	1 (0.454)
K176	1 (0.454)
K177	5000 (2270)
K178	1000 (454)
K181	1 (0.454)

ε The RQ for these hazardous substances is limited to those pieces of the metal having a diameter smaller than 100 micrometers (0.004 inches).

ζ The RQ for asbestos is limited to friable forms only.

Ⓢ Indicates that the name was added by PHMSA because (1) the name is a synonym for a specific hazardous substance and (2) the name appears in the Hazardous Materials Table as a proper shipping name.

* To provide consistency with EPA regulations, two entries with different CAS numbers are provided. Refer to the EPA Table 302.4—List of Hazardous Substances and Reportable Quantities for an explanation of the two entries.

LIST OF HAZARDOUS SUBSTANCES AND REPORTABLE QUANTITIES

TABLE 2 TO APPENDIX A—RADIONUCLIDES

(1)—Radionuclide	(2)—Atomic Number	(3)—Reportable Quantity (RQ) Ci (TBq)
Actinium-224	89	100 (3.7)
Actinium-225	89	1 (.037)
Actinium-226	89	10 (.37)
Actinium-227	89	0.001 (.00037)
Actinium-228	89	10 (.37)
Aluminum-26	13	10 (.37)
Americium-237	95	1000 (37)
Americium-238	95	100 (3.7)
Americium-239	95	100 (3.7)
Americium-240	95	10 (.37)
Americium-241	95	0.01 (.00037)
Americium-242	95	100 (3.7)
Americium-242m	95	0.01 (.00037)
Americium-243	95	0.01 (.00037)
Americium-244	95	10 (.37)
Americium-244m	95	1000 (37)
Americium-245	95	1000 (37)
Americium-246	95	1000 (37)
Americium-246m	95	1000 (37)
Antimony-115	51	1000 (37)
Antimony-116	51	1000 (3.7)
Antimony-116m	51	100 (3.7)
Antimony-117	51	1000 (37)

TABLE 2 TO APPENDIX A—RADIONUCLIDES—Continued

(1)—Radionuclide	(2)—Atomic Number	(3)—Reportable Quantity (RQ) Ci (TBq)
Antimony-118m	51	10 (.37)
Antimony-119	51	1000 (37)
Antimony-120 (16 min)	51	1000 (37)
Antimony-120 (5.76 day)	51	10 (.37)
Antimony-122	51	10 (.37)
Antimony-124	51	10 (.37)
Antimony-124m	51	1000 (37)
Antimony-125	51	10 (.37)
Antimony-126	51	10 (.37)
Antimony-126m	51	1000 (37)
Antimony-127	51	10 (.37)
Antimony-128 (10.4 min)	51	1000 (37)
Antimony-128 (9.01 hr)	51	10 (.37)
Antimony-129	51	100 (3.7)
Antimony-130	51	100 (3.7)
Antimony-131	51	1000 (37)
Argon-39	18	1000 (37)
Argon-41	18	10 (.37)
Arsenic-69	33	1000 (37)
Arsenic-70	33	100 (3.7)
Arsenic-71	33	100 (3.7)
Arsenic-72	33	10 (.37)
Arsenic-73	33	100 (3.7)
Arsenic-74	33	10 (.37)
Arsenic-76	33	100 (3.7)

TABLE 2 TO APPENDIX A—RADIONUCLIDES—
Continued

(1)—Radionuclide	(2)—Atomic Number	(3)—Reportable Quantity (RQ) Ci (TBq)
Arsenic-77	33	1000 (37)
Arsenic-78	33	100 (3.7)
Astatine-207	85	100 (3.7)
Astatine-211	85	100 (3.7)
Barium-126	56	1000 (37)
Barium-128	56	10 (.37)
Barium-131	56	10 (.37)
Barium-131m	56	1000 (37)
Barium-133	56	10 (.37)
Barium-133m	56	100 (3.7)
Barium-135m	56	1000 (37)
Barium-139	56	1000 (37)
Barium-140	56	10 (.37)
Barium-141	56	1000 (37)
Barium-142	56	1000 (37)
Berkelium-245	97	100 (3.7)
Berkelium-246	97	10 (.37)
Berkelium-247	97	0.01 (.00037)
Berkelium-249	97	1 (.037)
Berkelium-250	97	100 (3.7)
Beryllium-10	4	1 (.037)
Beryllium-7	4	100 (3.7)
Bismuth-200	83	100 (3.7)
Bismuth-201	83	100 (3.7)
Bismuth-202	83	1000 (37)
Bismuth-203	83	10 (.37)
Bismuth-205	83	10 (.37)
Bismuth-206	83	10 (.37)
Bismuth-207	83	10 (.37)
Bismuth-210	83	10 (.37)
Bismuth-210m	83	0.1 (.0037)
Bismuth-212	83	100 (3.7)
Bismuth-213	83	100 (3.7)
Bismuth-214	83	100 (3.7)
Bromine-74	35	100 (3.7)
Bromine-74m	35	100 (3.7)
Bromine-75	35	100 (3.7)
Bromine-76	35	10 (.37)
Bromine-77	35	100 (3.7)
Bromine-80	35	1000 (37)
Bromine-80m	35	1000 (37)
Bromine-82	35	10 (.37)
Bromine-83	35	1000 (37)
Bromine-84	35	100 (3.7)
Cadmium-104	48	1000 (37)
Cadmium-107	48	1000 (37)
Cadmium-109	48	1 (.037)
Cadmium-113	48	0.1 (.0037)
Cadmium-113m	48	0.1 (.0037)
Cadmium-115	48	100 (3.7)
Cadmium-115m	48	10 (.37)
Cadmium-117	48	100 (3.7)
Cadmium-117m	48	10 (.37)
Calcium-41	20	10 (.37)
Calcium-45	20	10 (.37)
Calcium-47	20	10 (.37)
Californium-244	98	1000 (37)
Californium-246	98	10 (.37)
Californium-248	98	0.1 (.0037)
Californium-249	98	0.01 (.00037)
Californium-250	98	0.01 (.00037)
Californium-251	98	0.01 (.00037)
Californium-252	98	0.1 (.0037)
Californium-253	98	10 (.37)
Californium-254	98	0.1 (.0037)
Carbon-11	6	1000 (37)
Carbon-14	6	10 (.37)
Cerium-134	58	10 (.37)

TABLE 2 TO APPENDIX A—RADIONUCLIDES—
Continued

(1)—Radionuclide	(2)—Atomic Number	(3)—Reportable Quantity (RQ) Ci (TBq)
Cerium-135	58	10 (.37)
Cerium-137	58	1000 (37)
Cerium-137m	58	100 (3.7)
Cerium-139	58	100 (3.7)
Cerium-141	58	10 (.37)
Cerium-143	58	100 (3.7)
Cerium-144	58	1 (.037)
Cesium-125	55	1000 (37)
Cesium-127	55	100 (3.7)
Cesium-129	55	100 (3.7)
Cesium-130	55	1000 (37)
Cesium-131	55	1000 (37)
Cesium-132	55	10 (.37)
Cesium-134	55	1 (.037)
Cesium-134m	55	1000 (37)
Cesium-135	55	10 (.37)
Cesium-135m	55	100 (3.7)
Cesium-136	55	10 (.37)
Cesium-137	55	1 (.037)
Cesium-138	55	100 (3.7)
Chlorine-36	17	10 (.37)
Chlorine-38	17	100 (3.7)
Chlorine-39	17	100 (3.7)
Chromium-48	24	100 (3.7)
Chromium-49	24	1000 (37)
Chromium-51	24	1000 (37)
Cobalt-55	27	10 (.37)
Cobalt-56	27	10 (.37)
Cobalt-57	27	100 (3.7)
Cobalt-58	27	10 (.37)
Cobalt-58m	27	1000 (37)
Cobalt-60	27	10 (.37)
Cobalt-60m	27	1000 (37)
Cobalt-61	27	1000 (37)
Cobalt-62m	27	1000 (37)
Copper-60	29	100 (3.7)
Copper-61	29	100 (3.7)
Copper-64	29	1000 (37)
Copper-67	29	100 (3.7)
Curium-238	96	1000 (37)
Curium-240	96	1 (.037)
Curium-241	96	10 (.37)
Curium-242	96	1 (.037)
Curium-243	96	0.01 (.00037)
Curium-244	96	0.01 (.00037)
Curium-245	96	0.01 (.00037)
Curium-246	96	0.01 (.00037)
Curium-247	96	0.01 (.00037)
Curium-248	96	0.001 (.000037)
Curium-249	96	1000 (37)
Dysprosium-155	66	100 (3.7)
Dysprosium-157	66	100 (3.7)
Dysprosium-159	66	100 (3.7)
Dysprosium-165	66	1000 (37)
Dysprosium-166	66	10 (.37)
Einsteinium-250	99	10 (.37)
Einsteinium-251	99	1000 (37)
Einsteinium-253	99	10 (.37)
Einsteinium-254	99	0.1 (.0037)
Einsteinium-254m	99	1 (.037)
Erbium-161	68	100 (3.7)
Erbium-165	68	1000 (37)
Erbium-169	68	100 (3.7)
Erbium-171	68	100 (3.7)
Erbium-172	68	10 (.37)
Europium-145	63	10 (.37)
Europium-146	63	10 (.37)
Europium-147	63	10 (.37)

§ 172.101

49 CFR Ch. I (10–1–14 Edition)

TABLE 2 TO APPENDIX A—RADIONUCLIDES—
Continued

(1)—Radionuclide	(2)— Atomic Num- ber	(3)—Reportable Quantity (RQ) Ci (TBq)
Europium-148	63	10 (.37)
Europium-149	63	100 (3.7)
Europium-150 (12.6 hr)	63	1000 (37)
Europium-150 (34.2 yr)	63	10 (.37)
Europium-152	63	10 (.37)
Europium-152m	63	100 (3.7)
Europium-154	63	10 (.37)
Europium-155	63	10 (.37)
Europium-156	63	10 (.37)
Europium-157	63	10 (.37)
Europium-158	63	1000 (37)
Fermium-252	100	10 (.37)
Fermium-253	100	10 (.37)
Fermium-254	100	100 (3.7)
Fermium-255	100	100 (3.7)
Fermium-257	100	1 (.037)
Fluorine-18	9	1000 (37)
Francium-222	87	100 (3.7)
Francium-223	87	100 (3.7)
Gadolinium-145	64	100 (3.7)
Gadolinium-146	64	10 (.37)
Gadolinium-147	64	10 (.37)
Gadolinium-148	64	0.001 (.000037)
Gadolinium-149	64	100 (3.7)
Gadolinium-151	64	100 (3.7)
Gadolinium-152	64	0.001 (.000037)
Gadolinium-153	64	10 (.37)
Gadolinium-159	64	1000 (37)
Gallium-65	31	1000 (37)
Gallium-66	31	10 (.37)
Gallium-67	31	100 (3.7)
Gallium-68	31	1000 (37)
Gallium-70	31	1000 (37)
Gallium-72	31	10 (.37)
Gallium-73	31	100 (3.7)
Germanium-66	32	100 (3.7)
Germanium-67	32	1000 (37)
Germanium-68	32	10 (.37)
Germanium-69	32	10 (.37)
Germanium-71	32	1000 (37)
Germanium-75	32	1000 (37)
Germanium-77	32	10 (.37)
Germanium-78	32	1000 (37)
Gold-193	79	100 (3.7)
Gold-194	79	10 (.37)
Gold-195	79	100 (3.7)
Gold-198	79	100 (3.7)
Gold-198m	79	10 (.37)
Gold-199	79	100 (3.7)
Gold-200	79	1000 (37)
Gold-200m	79	10 (.37)
Gold-201	79	1000 (37)
Hafnium-170	72	100 (3.7)
Hafnium-172	72	1 (.037)
Hafnium-173	72	100 (3.7)
Hafnium-175	72	100 (3.7)
Hafnium-177m	72	1000 (37)
Hafnium-178m	72	0.1 (.0037)
Hafnium-179m	72	100 (3.7)
Hafnium-180m	72	100 (3.7)
Hafnium-181	72	10 (.37)
Hafnium-182	72	0.1 (.0037)
Hafnium-182m	72	100 (3.7)
Hafnium-183	72	100 (3.7)
Hafnium-184	72	100 (3.7)
Holmium-155	67	1000 (37)
Holmium-157	67	1000 (37)
Holmium-159	67	1000 (37)

TABLE 2 TO APPENDIX A—RADIONUCLIDES—
Continued

(1)—Radionuclide	(2)— Atomic Num- ber	(3)—Reportable Quantity (RQ) Ci (TBq)
Holmium-161	67	1000 (37)
Holmium-162	67	1000 (37)
Holmium-162m	67	1000 (37)
Holmium-164	67	1000 (37)
Holmium-164m	67	1000 (37)
Holmium-166	67	100 (3.7)
Holmium-166m	67	1 (.037)
Holmium-167	67	100 (3.7)
Hydrogen-3	1	100 (3.7)
Indium-109	49	100 (3.7)
Indium-110 (4.9 hr)	49	10 (.37)
Indium-110 (69.1 min)	49	100 (3.7)
Indium-111	49	100 (3.7)
Indium-112	49	1000 (37)
Indium-113m	49	1000 (37)
Indium-114m	49	10 (.37)
Indium-115	49	0.1 (.0037)
Indium-115m	49	100 (3.7)
Indium-116m	49	100 (3.7)
Indium-117	49	1000 (37)
Indium-117m	49	100 (3.7)
Indium-119m	49	1000 (37)
Iodine-120	53	10 (.37)
Iodine-120m	53	100 (3.7)
Iodine-121	53	100 (3.7)
Iodine-123	53	10 (.37)
Iodine-124	53	0.1 (.0037)
Iodine-125	53	0.01 (.00037)
Iodine-126	53	0.01 (.00037)
Iodine-128	53	1000 (37)
Iodine-129	53	0.001 (.000037)
Iodine-130	53	1 (.037)
Iodine-131	53	0.01 (.00037)
Iodine-132	53	10 (.37)
Iodine-132m	53	10 (.37)
Iodine-133	53	0.1 (.0037)
Iodine-134	53	100 (3.7)
Iodine-135	53	10 (.37)
Iridium-182	77	1000 (37)
Iridium-184	77	100 (3.7)
Iridium-185	77	100 (3.7)
Iridium-186	77	10 (.37)
Iridium-187	77	100 (3.7)
Iridium-188	77	10 (.37)
Iridium-189	77	100 (3.7)
Iridium-190	77	10 (.37)
Iridium-190m	77	1000 (37)
Iridium-192	77	10 (.37)
Iridium-192m	77	100 (3.7)
Iridium-194	77	100 (3.7)
Iridium-194m	77	10 (.37)
Iridium-195	77	1000 (37)
Iridium-195m	77	100 (3.7)
Iron-52	26	100 (3.7)
Iron-55	26	100 (3.7)
Iron-59	26	10 (.37)
Iron-60	26	0.1 (.0037)
Krypton-74	36	10 (.37)
Krypton-76	36	10 (.37)
Krypton-77	36	10 (.37)
Krypton-79	36	100 (3.7)
Krypton-81	36	1000 (37)
Krypton-83m	36	1000 (37)
Krypton-85	36	1000 (37)
Krypton-85m	36	100 (3.7)
Krypton-87	36	10 (.37)
Krypton-88	36	10 (.37)
Lanthanum-131	57	1000 (37)

TABLE 2 TO APPENDIX A—RADIONUCLIDES—
Continued

(1)—Radionuclide	(2)—Atomic Number	(3)—Reportable Quantity (RQ) Ci (TBq)
Lanthanum-132	57	100 (3.7)
Lanthanum-135	57	1000 (37)
Lanthanum-137	57	10 (.37)
Lanthanum-138	57	1 (.037)
Lanthanum-140	57	10 (.37)
Lanthanum-141	57	1000 (37)
Lanthanum-142	57	100 (3.7)
Lanthanum-143	57	1000 (37)
Lead-195m	82	1000 (37)
Lead-198	82	100 (3.7)
Lead-199	82	100 (3.7)
Lead-200	82	100 (3.7)
Lead-201	82	100 (3.7)
Lead-202	82	1 (.037)
Lead-202m	82	10 (.37)
Lead-203	82	100 (3.7)
Lead-205	82	100 (3.7)
Lead-209	82	1000 (37)
Lead-210	82	0.01 (.00037)
Lead-211	82	100 (3.7)
Lead-212	82	10 (.37)
Lead-214	82	100 (3.7)
Lutetium-169	71	10 (.37)
Lutetium-170	71	10 (.37)
Lutetium-171	71	10 (.37)
Lutetium-172	71	10 (.37)
Lutetium-173	71	100 (3.7)
Lutetium-174	71	10 (.37)
Lutetium-174m	71	10 (.37)
Lutetium-176	71	1 (.037)
Lutetium-176m	71	1000 (37)
Lutetium-177	71	100 (3.7)
Lutetium-177m	71	10 (.37)
Lutetium-178	71	1000 (37)
Lutetium-178m	71	1000 (37)
Lutetium-179	71	1000 (37)
Magnesium-28	12	10 (.37)
Manganese-51	25	1000 (37)
Manganese-52	25	10 (.37)
Manganese-52m	25	1000 (37)
Manganese-53	25	1000 (37)
Manganese-54	25	10 (.37)
Manganese-56	25	100 (3.7)
Mendelevium-257	101	100 (3.7)
Mendelevium-258	101	1 (.037)
Mercury-193	80	100 (3.7)
Mercury-193m	80	10 (.37)
Mercury-194	80	0.1 (.0037)
Mercury-195	80	100 (3.7)
Mercury-195m	80	100 (3.7)
Mercury-197	80	1000 (37)
Mercury-197m	80	1000 (37)
Mercury-199m	80	1000 (37)
Mercury-203	80	10 (.37)
Molybdenum-101	42	1000 (37)
Molybdenum-90	42	100 (3.7)
Molybdenum-93	42	100 (3.7)
Molybdenum-93m	42	10 (.37)
Molybdenum-99	42	100 (3.7)
Neodymium-136	60	1000 (37)
Neodymium-138	60	1000 (37)
Neodymium-139	60	1000 (37)
Neodymium-139m	60	100 (3.7)
Neodymium-141	60	1000 (37)
Neodymium-147	60	10 (.37)
Neodymium-149	60	100 (3.7)
Neodymium-151	60	1000 (37)
Neptunium-232	93	1000 (37)

TABLE 2 TO APPENDIX A—RADIONUCLIDES—
Continued

(1)—Radionuclide	(2)—Atomic Number	(3)—Reportable Quantity (RQ) Ci (TBq)
Neptunium-233	93	1000 (37)
Neptunium-234	93	10 (.37)
Neptunium-235	93	1000 (37)
Neptunium-236 (1.2 E 5 yr)	93	0.1 (.0037)
Neptunium-236 (22.5 hr)	93	100 (3.7)
Neptunium-237	93	0.01 (.00037)
Neptunium-238	93	10 (.37)
Neptunium-239	93	100 (3.7)
Neptunium-240	93	100 (3.7)
Nickel-56	28	10 (.37)
Nickel-57	28	10 (.37)
Nickel-59	28	100 (3.7)
Nickel-63	28	100 (3.7)
Nickel-65	28	100 (3.7)
Nickel-66	28	10 (.37)
Niobium-88	41	100 (3.7)
Niobium-89 (122 min)	41	100 (3.7)
Niobium-89 (66 min)	41	100 (3.7)
Niobium-90	41	10 (.37)
Niobium-93m	41	100 (3.7)
Niobium-94	41	10 (.37)
Niobium-95	41	10 (.37)
Niobium-95m	41	100 (3.7)
Niobium-96	41	10 (.37)
Niobium-97	41	100 (3.7)
Niobium-98	41	1000 (37)
Osmium-180	76	1000 (37)
Osmium-181	76	100 (3.7)
Osmium-182	76	100 (3.7)
Osmium-185	76	10 (.37)
Osmium-189m	76	1000 (37)
Osmium-191	76	100 (3.7)
Osmium-191m	76	1000 (37)
Osmium-193	76	100 (3.7)
Osmium-194	76	1 (.037)
Palladium-100	46	100 (3.7)
Palladium-101	46	100 (3.7)
Palladium-103	46	100 (3.7)
Palladium-107	46	100 (3.7)
Palladium-109	46	1000 (37)
Phosphorus-32	15	0.1 (.0037)
Phosphorus-33	15	1 (.037)
Platinum-186	78	100 (3.7)
Platinum-188	78	100 (3.7)
Platinum-189	78	100 (3.7)
Platinum-191	78	100 (3.7)
Platinum-193	78	1000 (37)
Platinum-193m	78	100 (3.7)
Platinum-195m	78	100 (3.7)
Platinum-197	78	1000 (37)
Platinum-197m	78	1000 (37)
Platinum-199	78	1000 (37)
Platinum-200	78	100 (3.7)
Plutonium-234	94	1000 (37)
Plutonium-235	94	1000 (37)
Plutonium-236	94	0.1 (.0037)
Plutonium-237	94	1000 (37)
Plutonium-238	94	0.01 (.00037)
Plutonium-239	94	0.01 (.00037)
Plutonium-240	94	0.01 (.00037)
Plutonium-241	94	1 (.037)
Plutonium-242	94	0.01 (.00037)
Plutonium-243	94	1000 (37)
Plutonium-244	94	0.01 (.00037)
Plutonium-245	94	100 (3.7)
Polonium-203	84	100 (3.7)
Polonium-205	84	100 (3.7)
Polonium-207	84	10 (.37)

§ 172.101

49 CFR Ch. I (10-1-14 Edition)

TABLE 2 TO APPENDIX A—RADIONUCLIDES—
Continued

(1)—Radionuclide	(2)— Atomic Num- ber	(3)—Reportable Quantity (RQ) Ci (TBq)
Polonium-210	84	0.01 (.00037)
Potassium-40	19	1 (.037)
Potassium-42	19	100 (3.7)
Potassium-43	19	10 (.37)
Potassium-44	19	100 (3.7)
Potassium-45	19	1000 (37)
Praseodymium-136	59	1000 (37)
Praseodymium-137	59	1000 (37)
Praseodymium-138m	59	100 (3.7)
Praseodymium-139	59	1000 (37)
Praseodymium-142	59	100 (3.7)
Praseodymium-142m	59	1000 (37)
Praseodymium-143	59	10 (.37)
Praseodymium-144	59	1000 (37)
Praseodymium-145	59	1000 (37)
Praseodymium-147	59	1000 (37)
Promethium-141	61	1000 (37)
Promethium-143	61	100 (3.7)
Promethium-144	61	10 (.37)
Promethium-145	61	100 (3.7)
Promethium-146	61	10 (.37)
Promethium-147	61	10 (.37)
Promethium-148	61	10 (.37)
Promethium-148m	61	10 (.37)
Promethium-149	61	100 (3.7)
Promethium-150	61	100 (3.7)
Promethium-151	61	100 (3.7)
Protactinium-227	91	100 (3.7)
Protactinium-228	91	10 (.37)
Protactinium-230	91	10 (.37)
Protactinium-231	91	0.01 (.00037)
Protactinium-232	91	10 (.37)
Protactinium-233	91	100 (3.7)
Protactinium-234	91	10 (.37)
RADIONUCLIDES \$†		1 (.037)
Radium-223	88	1 (.037)
Radium-224	88	10 (.37)
Radium-225	88	1 (.037)
Radium-226 **	88	0.1 (.0037)
Radium-227	88	1000 (37)
Radium-228	88	0.1 (.0037)
Radon-220	86	0.1 (.0037)
Radon-222	86	0.1 (.0037)
Rhenium-177	75	1000 (37)
Rhenium-178	75	1000 (37)
Rhenium-181	75	100 (3.7)
Rhenium-182 (12.7 hr)	75	10 (.37)
Rhenium-182 (64.0 hr)	75	10 (.37)
Rhenium-184	75	10 (.37)
Rhenium-184m	75	10 (.37)
Rhenium-186	75	100 (3.7)
Rhenium-186m	75	10 (.37)
Rhenium-187	75	1000 (37)
Rhenium-188	75	1000 (37)
Rhenium-188m	75	1000 (37)
Rhenium-189	75	1000 (37)
Rhodium-100	45	10 (.37)
Rhodium-101	45	10 (.37)
Rhodium-101m	45	100 (3.7)
Rhodium-102	45	10 (.37)
Rhodium-102m	45	10 (.37)
Rhodium-103m	45	1000 (37)
Rhodium-105	45	100 (3.7)
Rhodium-106m	45	10 (.37)
Rhodium-107	45	1000 (37)
Rhodium-99	45	10 (.37)
Rhodium-99m	45	100 (3.7)
Rubidium-79	37	1000 (37)

TABLE 2 TO APPENDIX A—RADIONUCLIDES—
Continued

(1)—Radionuclide	(2)— Atomic Num- ber	(3)—Reportable Quantity (RQ) Ci (TBq)
Rubidium-81	37	100 (3.7)
Rubidium-81m	37	1000 (37)
Rubidium-82m	37	10 (.37)
Rubidium-83	37	10 (.37)
Rubidium-84	37	10 (.37)
Rubidium-86	37	10 (.37)
Rubidium-87	37	10 (.37)
Rubidium-88	37	1000 (37)
Rubidium-89	37	1000 (37)
Ruthenium-103	44	10 (.37)
Ruthenium-105	44	100 (3.7)
Ruthenium-106	44	1 (.037)
Ruthenium-94	44	1000 (37)
Ruthenium-97	44	100 (3.7)
Samarium-141	62	1000 (37)
Samarium-141m	62	1000 (37)
Samarium-142	62	1000 (37)
Samarium-145	62	100 (3.7)
Samarium-146	62	0.01 (.00037)
Samarium-147	62	0.01 (.00037)
Samarium-151	62	10 (.37)
Samarium-153	62	100 (3.7)
Samarium-155	62	1000 (37)
Samarium-156	62	100 (3.7)
Scandium-43	21	1000 (37)
Scandium-44	21	100 (3.7)
Scandium-44m	21	10 (.37)
Scandium-46	21	10 (.37)
Scandium-47	21	100 (3.7)
Scandium-48	21	10 (.37)
Scandium-49	21	1000 (37)
Selenium-70	34	1000 (37)
Selenium-73	34	10 (.37)
Selenium-73m	34	100 (3.7)
Selenium-75	34	10 (.37)
Selenium-79	34	10 (.37)
Selenium-81	34	1000 (37)
Selenium-81m	34	1000 (37)
Selenium-83	34	1000 (37)
Silicon-31	14	1000 (37)
Silicon-32	14	1 (.037)
Silver-102	47	100 (3.7)
Silver-103	47	1000 (37)
Silver-104	47	1000 (37)
Silver-104m	47	1000 (37)
Silver-105	47	10 (.37)
Silver-106	47	1000 (37)
Silver-106m	47	10 (.37)
Silver-108m	47	10 (.37)
Silver-110m	47	10 (.37)
Silver-111	47	10 (.37)
Silver-112	47	100 (3.7)
Silver-115	47	1000 (37)
Sodium-22	11	10 (.37)
Sodium-24	11	10 (.37)
Strontium-80	38	100 (3.7)
Strontium-81	38	1000 (37)
Strontium-83	38	100 (3.7)
Strontium-85	38	10 (.37)
Strontium-85m	38	1000 (37)
Strontium-87m	38	100 (3.7)
Strontium-89	38	10 (.37)
Strontium-90	38	0.1 (.0037)
Strontium-91	38	10 (.37)
Strontium-92	38	100 (3.7)
Sulfur-35	16	1 (.037)
Tantalum-172	73	100 (3.7)
Tantalum-173	73	100 (3.7)

TABLE 2 TO APPENDIX A—RADIONUCLIDES—
Continued

(1)—Radionuclide	(2)—Atomic Number	(3)—Reportable Quantity (RQ) Ci (TBq)
Tantalum-174	73	100 (3.7)
Tantalum-175	73	100 (3.7)
Tantalum-176	73	10 (.37)
Tantalum-177	73	1000 (37)
Tantalum-178	73	1000 (37)
Tantalum-179	73	1000 (37)
Tantalum-180	73	100 (3.7)
Tantalum-180m	73	1000 (37)
Tantalum-182	73	10 (.37)
Tantalum-182m	73	1000 (37)
Tantalum-183	73	100 (3.7)
Tantalum-184	73	10 (.37)
Tantalum-185	73	1000 (37)
Tantalum-186	73	1000 (37)
Technetium-101	43	1000 (37)
Technetium-104	43	1000 (37)
Technetium-93	43	100 (3.7)
Technetium-93m	43	1000 (37)
Technetium-94	43	10 (.37)
Technetium-94m	43	100 (3.7)
Technetium-96	43	10 (.37)
Technetium-96m	43	1000 (37)
Technetium-97	43	100 (3.7)
Technetium-97m	43	100 (3.7)
Technetium-98	43	10 (.37)
Technetium-99	43	10 (.37)
Technetium-99m	43	100 (3.7)
Tellurium-116	52	1000 (37)
Tellurium-121	52	10 (.37)
Tellurium-121m	52	10 (.37)
Tellurium-123	52	10 (.37)
Tellurium-123m	52	10 (.37)
Tellurium-125m	52	10 (.37)
Tellurium-127	52	1000 (37)
Tellurium-127m	52	10 (.37)
Tellurium-129	52	1000 (37)
Tellurium-129m	52	10 (.37)
Tellurium-131	52	1000 (37)
Tellurium-131m	52	10 (.37)
Tellurium-132	52	10 (.37)
Tellurium-133	52	1000 (37)
Tellurium-133m	52	1000 (37)
Tellurium-134	52	1000 (37)
Terbium-147	65	100 (3.7)
Terbium-149	65	100 (3.7)
Terbium-150	65	100 (3.7)
Terbium-151	65	10 (.37)
Terbium-153	65	100 (3.7)
Terbium-154	65	10 (.37)
Terbium-155	65	100 (3.7)
Terbium-156	65	10 (.37)
Terbium-156m (24.4 hr)	65	1000 (37)
Terbium-156m (5.0 hr)	65	1000 (37)
Terbium-157	65	100 (3.7)
Terbium-158	65	10 (.37)
Terbium-160	65	10 (.37)
Terbium-161	65	100 (3.7)
Thallium-194	81	1000 (37)
Thallium-194m	81	100 (3.7)
Thallium-195	81	100 (3.7)
Thallium-197	81	100 (3.7)
Thallium-198	81	10 (.37)
Thallium-198m	81	100 (3.7)
Thallium-199	81	100 (3.7)
Thallium-200	81	10 (.37)
Thallium-201	81	1000 (37)
Thallium-202	81	10 (.37)
Thallium-204	81	10 (.37)

TABLE 2 TO APPENDIX A—RADIONUCLIDES—
Continued

(1)—Radionuclide	(2)—Atomic Number	(3)—Reportable Quantity (RQ) Ci (TBq)
Thorium (Irradiated)	90	***
Thorium (Natural)	90	**
Thorium-226	90	100 (3.7)
Thorium-227	90	1 (.037)
Thorium-228	90	0.01 (.00037)
Thorium-229	90	0.001 (.000037)
Thorium-230	90	0.01 (.00037)
Thorium-231	90	100 (3.7)
Thorium-232 **	90	0.001 (.000037)
Thorium-234	90	100 (3.7)
Thulium-162	69	1000 (37)
Thulium-166	69	10 (.37)
Thulium-167	69	100 (3.7)
Thulium-170	69	10 (.37)
Thulium-171	69	100 (3.7)
Thulium-172	69	100 (3.7)
Thulium-173	69	100 (3.7)
Thulium-175	69	1000 (37)
Tin-110	50	100 (3.7)
Tin-111	50	1000 (37)
Tin-113	50	10 (.37)
Tin-117m	50	100 (3.7)
Tin-119m	50	10 (.37)
Tin-121	50	1000 (37)
Tin-121m	50	10 (.37)
Tin-123	50	10 (.37)
Tin-123m	50	1000 (37)
Tin-125	50	10 (.37)
Tin-126	50	1 (.037)
Tin-127	50	100 (3.7)
Tin-128	50	1000 (37)
Titanium-44	22	1 (.037)
Titanium-45	22	1000 (37)
Tungsten-176	74	1000 (37)
Tungsten-177	74	100 (3.7)
Tungsten-178	74	100 (3.7)
Tungsten-179	74	1000 (37)
Tungsten-181	74	100 (3.7)
Tungsten-185	74	10 (.37)
Tungsten-187	74	100 (3.7)
Tungsten-188	74	10 (.37)
Uranium (Depleted)	92	***
Uranium (Irradiated)	92	***
Uranium (Natural)	92	**
Uranium Enriched 20% or greater	92	***
Uranium Enriched less than 20%	92	***
Uranium-230	92	1 (.037)
Uranium-231	92	1000 (37)
Uranium-232	92	0.01 (.00037)
Uranium-233	92	0.1 (.0037)
Uranium-234 **	92	0.1 (.0037)
Uranium-235 **	92	0.1 (.0037)
Uranium-236	92	0.1 (.0037)
Uranium-237	92	100 (3.7)
Uranium-238 **	92	0.1 (.0037)
Uranium-239	92	1000 (37)
Uranium-240	92	1000 (37)
Vanadium-47	23	1000 (37)
Vanadium-48	23	10 (.37)
Vanadium-49	23	1000 (37)
Xenon-120	54	100 (3.7)
Xenon-121	54	10 (.37)
Xenon-122	54	100 (3.7)
Xenon-123	54	10 (.37)
Xenon-125	54	100 (3.7)
Xenon-127	54	100 (3.7)

TABLE 2 TO APPENDIX A—RADIONUCLIDES—
Continued

(1)—Radionuclide	(2)—Atomic Number	(3)—Reportable Quantity (RQ) Ci (TBq)
Xenon-129m	54	1000 (37)
Xenon-131m	54	1000 (37)
Xenon-133	54	1000 (37)
Xenon-133m	54	1000 (37)
Xenon-135	54	100 (3.7)
Xenon-135m	54	10 (3.7)
Xenon-138	54	10 (3.7)
Ytterbium-162	70	1000 (37)
Ytterbium-166	70	10 (3.7)
Ytterbium-167	70	1000 (37)
Ytterbium-169	70	10 (3.7)
Ytterbium-175	70	100 (3.7)
Ytterbium-177	70	1000 (37)
Ytterbium-178	70	1000 (37)
Yttrium-86	39	10 (3.7)
Yttrium-86m	39	1000 (37)
Yttrium-87	39	10 (3.7)
Yttrium-88	39	10 (3.7)
Yttrium-90	39	10 (3.7)
Yttrium-90m	39	100 (3.7)
Yttrium-91	39	10 (3.7)
Yttrium-91m	39	1000 (37)
Yttrium-92	39	100 (3.7)
Yttrium-93	39	100 (3.7)
Yttrium-94	39	1000 (37)
Yttrium-95	39	1000 (37)
Zinc-62	30	100 (3.7)
Zinc-63	30	1000 (37)
Zinc-65	30	10 (3.7)
Zinc-69	30	1000 (37)
Zinc-69m	30	100 (3.7)
Zinc-71m	30	100 (3.7)
Zinc-72	30	100 (3.7)
Zirconium-86	40	100 (3.7)
Zirconium-88	40	10 (3.7)
Zirconium-89	40	100 (3.7)
Zirconium-93	40	1 (.037)
Zirconium-95	40	10 (3.7)
Zirconium-97	40	10 (3.7)

§ The RQs for all radionuclides apply to chemical compounds containing the radionuclides and elemental forms regardless of the diameter of pieces of solid material.

† The RQ of one curie applies to all radionuclides not otherwise listed. Whenever the RQs in TABLE 1—HAZARDOUS SUBSTANCES OTHER THAN RADIONUCLIDES and this table conflict, the lowest RQ shall apply. For example, uranyl acetate and uranyl nitrate have RQs shown in TABLE 1 of 100 pounds, equivalent to about one-tenth the RQ level for uranium-238 in this table.

** The method to determine the RQs for mixtures or solutions of radionuclides can be found in paragraph 7 of the note preceding TABLE 1 of this appendix. RQs for the following four common radionuclide mixtures are provided: radium-226 in secular equilibrium with its daughters (0.053 curie); natural uranium (0.1 curie); natural uranium in secular equilibrium with its daughters (0.052 curie); and natural thorium in secular equilibrium with its daughters (0.011 curie).

*** Indicates that the name was added by PHMSA because it appears in the list of radionuclides in 49 CFR 173.435. The reportable quantity (RQ), if not specifically listed elsewhere in this appendix, shall be determined in accordance with the procedures in paragraph 7 of this appendix.

APPENDIX B TO § 172.101—LIST OF MARINE POLLUTANTS

1. See §171.4 of this subchapter for applicability to marine pollutants. This appendix lists potential marine pollutants as defined in §171.8 of this subchapter.

2. Marine pollutants listed in this appendix are not necessarily listed by name in the §172.101 Table. If a marine pollutant not listed by name or by synonym in the §172.101 Table meets the definition of any hazard Class 1 through 8, then you must determine the class and division of the material in accordance with §173.2a of this subchapter. You must also select the most appropriate hazardous material description and proper shipping name. If a marine pollutant not listed by name or by synonym in the §172.101 Table does not meet the definition of any Class 1 through 8, then you must offer it for transportation under the most appropriate of the following two Class 9 entries: “Environmentally hazardous substances, liquid, n.o.s.” UN3082, or “Environmentally hazardous substances, solid, n.o.s.” UN3077.

3. This appendix contains two columns. The first column, entitled “S.M.P.” (for severe marine pollutants), identifies whether a material is a severe marine pollutant. If the letters “PP” appear in this column for a material, the material is a severe marine pollutant, otherwise it is not. The second column, entitled “Marine Pollutant”, lists the marine pollutants.

4. If a material is not listed in this appendix and meets the criteria for a marine pollutant as provided in Chapter 2.9 of the IMDG Code, (incorporated by reference; see §171.7 of this subchapter), the material may be transported as a marine pollutant in accordance with the applicable requirements of this subchapter.

5. If a material or a solution meeting the definition of a marine pollutant in §171.8 of this subchapter does not meet the criteria for a marine pollutant as provided in section 2.9.3.3 and 2.9.3.4 of the IMDG Code, (incorporated by reference; see §171.7 of this subchapter), it may be excepted from the requirements of this subchapter as a marine pollutant if that exception is approved by the Associate Administrator.

LIST OF MARINE POLLUTANTS

S.M.P. (1)	Marine pollutant (2)
	Acetone cyanohydrin, stabilized
	Acetylene tetrabromide
	Acetylene tetrachloride
	Acraldehyde, inhibited
	Acrolein, inhibited
	Acrolein, stabilized
	Acrylic aldehyde, inhibited
	Alcohol C-12 - C-16 poly(1-6) ethoxylate
	Alcohol C-6 - C-17 (secondary)poly(3-6) ethoxylate
	Aldicarb
PP	Aldrin
	Alkyl (c12-c14) dimethylamine
	Alkyl (c7-c9) nitrates
	Alkybenzenesulphonates, branched and straight chain (excluding C11–C13 straight chain or branched chain homologues)
	Allyl bromide
	ortho-Aminoanisole

LIST OF MARINE POLLUTANTS—Continued		LIST OF MARINE POLLUTANTS—Continued	
S.M.P. (1)	Marine pollutant (2)	S.M.P. (1)	Marine pollutant (2)
	Aminocarb		Chloropicrin
	Ammonium dinitro-o-cresolate		alpha-Chloropropylene
	n-Amylbenzene		Chlorotoluenes (meta-;para-)
PP	Azinphos-ethyl	PP	Chlorpyrifos
PP	Azinphos-methyl	PP	Chlorthiophos
	Barium cyanide		Cocculus
	Bendiocarb		Coconitrite
	Benomyl		Copper acetoarsenite
	Benquinox		Copper arsenite
	Benzyl chlorocarbonate	PP	Copper chloride
	Benzyl chloroformate	PP	Copper chloride solution
PP	Binapacryl	PP	Copper cyanide
	<i>N,N-Bis</i> (2-hydroxyethyl) oleamide (LOA)	PP	Copper metal powder
PP	Brodifacoum	PP	Copper sulphate, anhydrous, hydrates
	Bromine cyanide		Coumachlor
	Bromoacetone	PP	Coumaphos
	Bromoallylene	PP	Cresyl diphenyl phosphate
	Bromobenzene		Crotonaldehyde, stabilized
	ortho-Bromobenzyl cyanide		Crotonic aldehyde, stabilized
	Bromocycane		Croxyphos
	Bromoform		Cupric arsenite
PP	Bromophos-ethyl	PP	Cupric chloride
	3-Bromopropene	PP	Cupric cyanide
	Bromoxynil	PP	Cupric sulfate
	Butanedione		Cupriethylenediamine solution
	2-Butenal, stabilized		Cuprous chloride
	Butyl benzyl phthalate	PP	Cyanide mixtures
	<i>N-tert-butyl-N-cyclopropyl-6-methylthio-1,3,5-triazine-2,4-diamine</i>		Cyanide solutions
	2,4-Di- <i>tert-butyl</i> phenol		Cyanides, inorganic, n.o.s.
PP	2, 6-Di- <i>tert-Butyl</i> phenol		Cyanogen bromide
	para-tertiary-butyltoluene		Cyanogen chloride, inhibited
PP	Cadmium compounds		Cyanogen chloride, stabilized
	Cadmium sulphide	PP	Cyanophos
	Calcium arsenate	PP	1,5,9-Cyclododecatriene
	Calcium arsenate and calcium arsenite, mixtures, solid	PP	Cyhexatin
	Calcium cyanide	PP	Cymenes (o-;m-;p-)
PP	Camphchlor	PP	Cypermethrin
	Carbaryl		Decyl acrylate
	Carbendazim	PP	DDT
	Carbofuran		Decyloxyltetrahydrothiophene dioxide
	Carbon tetrabromide		DEF
	Carbon tetrachloride		Desmedipham
PP	Carbophenothion	PP	Di-allate
	Cartap hydrochloride		Di-n-Butyl phthalate
PP	Chlordane	PP	Dialifos
	Chlorfenvinphos		4,4'-Diaminodiphenylmethane
PP	Chlorinated paraffins (C-10 - C-13)	PP	Diazinon
PP	Chlorinated paraffins (C14–C17), with more than 1% shorter chain length		1,3-Dibromobenzene
	Chlorine		Dichlofenthion
	Chlorine cyanide, inhibited		Dichloroanilines
	Chlormephos		1,3-Dichlorobenzene
	Chloroacetone, stabilized		1,4-Dichlorobenzene
	1-Chloro-2,3-Epoxypropane		Dichlorobenzene (meta-; para-)
	2-Chloro-6-nitrotoluene		2,2-Dichlorodiethyl ether
	4-Chloro-2-nitrotoluene		Dichlorodimethyl ether, symmetrical
	Chloro-ortho-nitrotoluene		Di-(2-chloroethyl) ether
	2-Chloro-5-trifluoromethylnitrobenzene	PP	1,1-Dichloroethylene, inhibited
	para-Chlorobenzyl chloride, liquid or solid	PP	1,6-Dichlorohexane
	Chlorodinitrobenzenes, liquid or solid		Dichlorophenyltrichlorosilane
	1-Chloroheptane	PP	Dichlorvos
	1-Chlorohexane		Diclofop-methyl
	Chloronitroanilines		Dicrotophos
	Chloronitrotoluenes, liquid	PP	Dieldrin
	Chloronitrotoluenes, solid	PP	Diisopropylbenzenes
	1-Chlorooctane		Diisopropylphthalenes, mixed isomers
PP	Chlorophenolates, liquid		Dimethoate
PP	Chlorophenolates, solid		N,N-Dimethyldodecylamine
	Chlorophenyltrichlorosilane		Dimethylhydrazine, symmetrical
			Dimethylhydrazine, unsymmetrical
			Dinitro-o-cresol, solid
			Dinitro-o-cresol, solution

§ 172.101

49 CFR Ch. I (10–1–14 Edition)

LIST OF MARINE POLLUTANTS—Continued

S.M.P. (1)	Marine pollutant (2)
	Dinitrochlorobenzenes, liquid or solid
	Dinitrophenol, <i>dry or wetted with less than 15 per cent water, by mass</i>
	Dinitrophenol solutions
	Dinitrophenol, <i>wetted with not less than 15 per cent water, by mass</i>
	Dinitrophenolates <i>alkali metals, dry or wetted with less than 15 per cent water, by mass</i>
	Dinitrophenolates, <i>wetted with not less than 15 per cent water, by mass</i>
	Dinobuton
	Dinoseb
	Dinoseb acetate
	Dioxacarb
	Dioxathion
	Dipentene
	Diphacinone
	Diphenyl
PP	Diphenylamine chloroarsine
PP	Diphenylchloroarsine, solid or liquid
	Disulfoton
	1,4-Di-tert-butylbenzene
	DNOC
	DNOC (pesticide)
	Dodecyl diphenyl oxide disulphonate
PP	Dodecyl hydroxypropyl sulfide
	1-Dodecylamine
PP	Dodecylphenol
	Drazoxolon
PP	Edifenphos
PP	Endosulfan
PP	Endrin
	Epibromohydrin
	Epichlorohydrin
PP	EPN
PP	Esfenvalerate
PP	Ethion
	Ethoprophos
	Ethyl fluid
	Ethyl mercaptan
	2-Ethylhexyl nitrate
	2-Ethyl-3-propylacrolein
	Ethyl tetraphosphate
	Ethylchloroarsine
	Ethylene dibromide and methyl bromide mixtures, liquid
	2-Ethylhexaldehyde
PP	Fenamiphos
PP	Fenbutatin oxide
PP	Fenchlorazole-ethyl
PP	Fenitrothion
PP	Fenoxapro-ethyl
PP	Fenoxaprop-P-ethyl
PP	Fenpropathrin
	Fensulfothion
PP	Fenthion
PP	Fentin acetate
PP	Fentin hydroxide
	Ferric arsenate
	Ferric arsenite
	Ferrous arsenate
PP	Fonofos
	Formetanate
PP	Furathiocarb (ISO)
PP	gamma-BHC
	Gasoline, leaded
PP	Heptachlor
	Heptenophos
	n-Heptaldehyde
	n-Heptylbenzene
	normal-Heptyl chloride

LIST OF MARINE POLLUTANTS—Continued

S.M.P. (1)	Marine pollutant (2)
PP	Hexachlorobutadiene
PP	1,3-Hexachlorobutadiene
	Hexaethyl tetraphosphate <i>liquid</i>
	Hexaethyl tetraphosphate, <i>solid</i>
	normal-Hexyl chloride
	n-Hexylbenzene
	Hydrocyanic acid, anhydrous, stabilized, containing less than 3% water
	Hydrocyanic acid, anhydrous, stabilized, containing less than 3% water and absorbed in a porous inert material
	Hydrocyanic acid, aqueous solutions <i>not more than 20% hydrocyanic acid</i>
	Hydrogen cyanide solution in alcohol, <i>with not more than 45% hydrogen cyanide</i>
	Hydrogen cyanide, stabilized <i>with less than 3% water</i>
	Hydrogen cyanide, stabilized <i>with less than 3% water and absorbed in a porous inert material</i>
	Hydroxydimethylbenzenes, liquid or solid
	Ioxynil
	Isobenzan
	Isobutyl butyrate
	Isobutylbenzene
	Isodecyl acrylate
	Isodecyl diphenyl phosphate
	Isufenphos
	Isooctyl nitrate
	Isoproc carb
	Isotetramethylbenzene
PP	Isoxathion
	Lead acetate
	Lead arsenates
	Lead arsenites
	Lead compounds, soluble, n.o.s.
	Lead cyanide
	Lead nitrate
	Lead perchlorate, solid or solution
	Lead tetraethyl
	Lead tetramethyl
PP	Lindane
	Linuron
	London Purple
	Magnesium arsenate
	Malathion
	Mancozeb (ISO)
	Maneb
	Maneb preparations <i>with not less than 60% maneb</i>
	Maneb preparation, stabilized against self-heating
	Maneb stabilized or Maneb preparations, stabilized <i>against self-heating</i>
	Manganese ethylene-1,2-bis dithiocarbamate
	Manganese ethylene-1,2-bis-dithiocarbamate, stabilized against self-heating
	Mecarbam
	Mephosfolan
	Mercaptodimethur
PP	Mercuric acetate
PP	Mercuric ammonium chloride
PP	Mercuric arsenate
PP	Mercuric benzoate
PP	Mercuric bisulphate
PP	Mercuric bromide
PP	Mercuric chloride
PP	Mercuric cyanide
PP	Mercuric gluconate
PP	Mercuric iodide
PP	Mercuric nitrate
PP	Mercuric oleate
PP	Mercuric oxide
PP	Mercuric oxycyanide, desensitized

LIST OF MARINE POLLUTANTS—Continued		LIST OF MARINE POLLUTANTS—Continued	
S.M.P. (1)	Marine pollutant (2)	S.M.P. (1)	Marine pollutant (2)
PP	Mercuric potassium cyanide	PP	Organotin compounds, solid, n.o.s.
PP	Mercuric Sulphate	PP	Organotin pesticides, liquid, flammable, toxic, n.o.s., <i>flash point less than 23deg C</i>
PP	Mercuric thiocyanate	PP	Organotin pesticides, liquid, toxic, flammable, n.o.s.
PP	Mercuriol	PP	Organotin pesticides, liquid, toxic, n.o.s.
PP	Mercurous acetate	PP	Organotin pesticides, solid, toxic, n.o.s.
PP	Mercurous bisulphate	PP	Orthoarsenic acid
PP	Mercurous bromide	PP	Osmium tetroxide
PP	Mercurous chloride		Oxamyl
PP	Mercurous nitrate		Oxydisulfoton
PP	Mercurous salicylate		Paraoxon
PP	Mercurous sulphate	PP	Parathion
PP	Mercury acetates	PP	Parathion-methyl
PP	Mercury ammonium chloride	PP	PCBs.
PP	Mercury based pesticide, liquid, flammable, toxic		Pentachloroethane
PP	Mercury based pesticides, liquid, toxic, flammable	PP	Pentachlorophenol
PP	Mercury based pesticides, liquid, toxic		Pentalin
PP	Mercury based pesticides, solid, toxic		n-Pentylbenzene
PP	Mercury benzoate		Perchloroethylene
PP	Mercury bichloride		Perchloromethylmercaptan
PP	Mercury bisulphates		Petrol, leaded
PP	Mercury bromides	PP	Phenarsazine chloride
PP	Mercury compounds, liquid, n.o.s.		d-Phenothrin
PP	Mercury compounds, solid, n.o.s.	PP	Phenthoate
PP	Mercury cyanide		1-Phenylbutane
PP	Mercury gluconate		2-Phenylbutane
PP	Mercury (I) (mercurous) compounds (pesticides)		Phenylcyclohexane
PP	Mercury (II) (mercuric) compounds (pesticides)	PP	Phenylmercuric acetate
	Mercury iodide	PP	Phenylmercuric compounds, n.o.s.
PP	Mercury nucleate	PP	Phenylmercuric hydroxide
PP	Mercury oleate	PP	Phenylmercuric nitrate
PP	Mercury oxide	PP	Phorate
PP	Mercury oxycyanide, desensitized	PP	Phosalone
PP	Mercury potassium cyanide		Phosmet
PP	Mercury potassium iodide	PP	Phosphamidon
PP	Mercury salicylate	PP	Phosphorus, white, molten
PP	Mercury sulfates	PP	Phosphorus, white <i>or yellow dry or under water or in</i> <i>solution</i>
PP	Mercury thiocyanate	PP	Phosphorus white, or yellow, molten
	Metam-sodium	PP	Phosphorus, yellow, molten
	Methamidophos		Pindone (and salts of)
	Methanethiol	PP	Pirimicarb
	Methidathion		Pirimiphos-ethyl
	Methomyl	PP	Polychlorinated biphenyls
	ortho-Methoxyaniline	PP	Polyhalogenated biphenyls, liquid <i>or Terphenyls liq-</i> <i>uid</i>
	Methyl bromide and ethylene dibromide mixtures, liq- <i>uid</i>	PP	Polyhalogenated biphenyls, solid <i>or Terphenyls,</i> <i>solid</i>
	Methyl mercaptan		Potassium cuprocyanide
	3-Methylacroleine, stabilized		Potassium cyanide, solid
	Methylchlorobenzenes		Potassium cyanide, solution
	Methylnitrophenols	PP	Potassium cyanocuprate (I)
	3-Methylpyradine	PP	Potassium cyanomercurate
	Methyltrithion	PP	Potassium mercuric iodide
	Methylvinylbenzenes, inhibited		Promecarb
PP	Mevinphos		Propachlor
	Mexacarbate		Propaphos
	Mirex		Propenal, inhibited
	Monocrotophos		Propoxur
	Motor fuel anti-knock mixtures		Prothoate
	Motor fuel anti-knock mixtures or compounds		Prussic acid, anhydrous, stabilized
	Nabam		Prussic acid, anhydrous, stabilized, absorbed in a <i>porous inert material</i>
	Naled	PP	Pyrazophos
PP	Nickel carbonyl		Quinalphos
PP	Nickel cyanide	PP	Quizalofop
PP	Nickel tetracarbonyl	PP	Quizalofop-p-ethyl
	3-Nitro-4-chlorobenzotrifluoride		Rotenone
	Nitrobenzene		Salithion
	Nitrobenzotrifluorides, liquid or solid	PP	Salafuofen
	Nonylphenol	PP	Silver arsenite
	<i>normal</i> -Octaldehyde		
	Oleylamine		
PP	Organotin compounds, liquid, n.o.s.		
PP	Organotin compounds (pesticides)		

§ 172.102

49 CFR Ch. I (10–1–14 Edition)

LIST OF MARINE POLLUTANTS—Continued

S.M.P. (1)	Marine pollutant (2)
	Silver cyanide
	Silver orthoarsenite
PP	Sodium copper cyanide, solid
PP	Sodium copper cyanide solution
PP	Sodium cuprocyanide, solid
PP	Sodium cuprocyanide, solution
	Sodium cyanide, solid
	Sodium cyanide, solution
	Sodium dinitro-o-cresolate, <i>dry or wetted with less than 15 per cent water, by mass</i>
	Sodium dinitro-ortho-cresolate, <i>wetted with not less than 15 per cent water, by mass</i>
PP	Sodium pentachlorophenate
	Strychnine or Strychnine salts
PP	Sulfotep
	Sulprophos
	Tallow nitrile
	Temephos
	TEPP
PP	Terbufos
	Tetrabromoethane
	Tetrabromomethane
	1,1,2,2-Tetrachloroethane
	Tetrachloroethylene
	Tetrachloromethane
	Tetraethyl dithiopyrophosphate
PP	Tetraethyl lead, liquid
	Tetramethrin
	Tetramethyllead
	Thallium chlorate
	Thallium compounds, n.o.s.
	Thallium compounds (pesticides)
	Thallium nitrate
	Thallium sulfate
	Thallos chlorate
	Thiocarbonyl tetrachloride
	Triaryl phosphates, isopropylated
PP	Triaryl phosphates, n.o.s.
	Triazophos
	Tribromomethane
PP	Tributyltin compounds
	Trichlorfon
PP	1,2,3-Trichlorobenzene
	Trichlorobenzenes, liquid
	Trichlorobutene
	Trichlorobutylene
	Trichloromethane sulphuryl chloride
	Trichloromethyl sulphochloride
	Trichloronat
	Tricresyl phosphate (less than 1% ortho-isomer)
PP	Tricresyl phosphate, not less than 1% ortho-isomer but not more than 3% orthoisomer
PP	Tricresyl phosphate with more than 3 per cent ortho isomer
	Triethylbenzene
	Triisopropylated phenyl phosphates
	Trimethylene dichloride
PP	Triphenylphosphate
	Triphenyl phosphate/tert-butylated triphenyl phosphates mixtures containing 5% to 10% triphenyl phosphates
PP	Triphenyl phosphate/tert-butylated triphenyl phosphates mixtures containing 10% to 48% triphenyl phosphates
PP	Triphenyltin compounds
	Tritolyl phosphate (less than 1% ortho-isomer)
PP	Tritolyl phosphate (not less than 1% ortho-isomer)
	Trixylenyl phosphate
	Vinylidene chloride, stabilized
PP	Warfarin (and salts of)
	White phosphorus, dry

LIST OF MARINE POLLUTANTS—Continued

S.M.P. (1)	Marine pollutant (2)
PP	White phosphorus, wet
	White spirit, low (15-20%) aromatic
PP	Yellow phosphorus, dry
PP	Yellow phosphorus, wet
	Zinc bromide
	Zinc cyanide

[Amdt. 172–173, 55 FR 52474, Dec. 21, 1990]

EDITORIAL NOTE: For FEDERAL REGISTER citations affecting § 172.101, see the List of CFR Sections Affected, which appears in the Finding Aids section of the printed volume and at www.fdsys.gov.

§ 172.102 Special provisions.

(a) *General.* When column 7 of the § 172.101 table refers to a special provision for a hazardous material, the meaning and requirements of that provision are as set forth in this section. When a special provision specifies packaging or packaging requirements—

(1) The special provision is in addition to the standard requirements for all packagings prescribed in § 173.24 of this subchapter and any other applicable packaging requirements in subparts A and B of part 173 of this subchapter; and

(2) To the extent a special provision imposes limitations or additional requirements on the packaging provisions set forth in column 8 of the § 172.101 table, packagings must conform to the requirements of the special provision.

(b) *Description of codes for special provisions.* Special provisions contain packaging provisions, prohibitions, exceptions from requirements for particular quantities or forms of materials and requirements or prohibitions applicable to specific modes of transportation, as follows:

(1) A code consisting only of numbers (for example, “11”) is multi-modal in application and may apply to bulk and non-bulk packagings.

(2) A code containing the letter “A” refers to a special provision which applies only to transportation by aircraft.

(3) A code containing the letter “B” refers to a special provision that applies only to bulk packaging requirements. Unless otherwise provided in this subchapter, these special provisions do not apply to UN, IM Specification portable tanks or IBCs.

(4) A code containing the letters “IB” or “IP” refers to a special provision that applies only to transportation in IBCs.

(5) A code containing the letter “N” refers to a special provision which applies only to non-bulk packaging requirements.

(6) A code containing the letter “R” refers to a special provision which applies only to transportation by rail.

(7) A code containing the letter “T” refers to a special provision which applies only to transportation in UN or IM Specification portable tanks.

(8) A code containing the letters “TP” refers to a portable tank special provision for UN or IM Specification portable tanks that is in addition to those provided by the portable tank instructions or the requirements in part 178 of this subchapter.

(9) A code containing the letter “W” refers to a special provision that applies only to transportation by water.

(c) *Tables of special provisions.* The following tables list, and set forth the requirements of, the special provisions referred to in column 7 of the §172.101 table.

(1) *Numeric provisions.* These provisions are multi-modal and apply to bulk and non-bulk packagings:

Code/Special Provisions

- 1 This material is poisonous by inhalation (see §171.8 of this subchapter) in Hazard Zone A (see §173.116(a) or §173.133(a) of this subchapter), and must be described as an inhalation hazard under the provisions of this subchapter.
- 2 This material is poisonous by inhalation (see §171.8 of this subchapter) in Hazard Zone B (see §173.116(a) or §173.133(a) of this subchapter), and must be described as an inhalation hazard under the provisions of this subchapter.
- 3 This material is poisonous by inhalation (see §171.8 of this subchapter) in Hazard Zone C (see §173.116(a) of this subchapter), and must be described as an inhalation hazard under the provisions of this subchapter.
- 4 This material is poisonous by inhalation (see §171.8 of this subchapter) in Hazard

Zone D (see §173.116(a) of this subchapter), and must be described as an inhalation hazard under the provisions of this subchapter.

- 5 If this material meets the definition for a material poisonous by inhalation (see §171.8 of this subchapter), a shipping name must be selected which identifies the inhalation hazard, in Division 2.3 or Division 6.1, as appropriate.
- 6 This material is poisonous-by-inhalation and must be described as an inhalation hazard under the provisions of this subchapter.
- 8 A hazardous substance that is not a hazardous waste may be shipped under the shipping description “Other regulated substances, liquid or solid, n.o.s.”, as appropriate. In addition, for solid materials, special provision B54 applies.
- 9 Packaging for certain PCBs for disposal and storage is prescribed by EPA in 40 CFR 761.60 and 761.65.
- 11 The hazardous material must be packaged as either a liquid or a solid, as appropriate, depending on its physical form at 55 °C (131 °F) at atmospheric pressure.
- 12 In concentrations greater than 40 percent, this material has strong oxidizing properties and is capable of starting fires in contact with combustible materials. If appropriate, a package containing this material must conform to the additional labeling requirements of §172.402 of this subchapter.
- 13 The words “Inhalation Hazard” shall be entered on each shipping paper in association with the shipping description, shall be marked on each non-bulk package in association with the proper shipping name and identification number, and shall be marked on two opposing sides of each bulk package. Size of marking on bulk package must conform to §172.302(b) of this subchapter. The requirements of §§172.203(m) and 172.505 of this subchapter do not apply.
- 14 Motor fuel antiknock mixtures are:
 - a. Mixtures of one or more organic lead mixtures (such as tetraethyl lead, triethylmethyl lead, diethylmethyl lead, ethyltrimethyl lead, and tetramethyl lead) with one or more halogen compounds (such as ethylene dibromide and ethylene dichloride), hydrocarbon solvents or other equally efficient stabilizers; or
 - b. tetraethyl lead.
- 15 This entry applies to “Chemical kits” and “First aid kits” containing one or more compatible items of hazardous materials in boxes, cases, etc. that, for example, are used for medical, analytical, diagnostic, testing, or repair purposes. Kits that are carried on board transport vehicles for first aid or operating purposes are not subject to the requirements of this subchapter.

§ 172.102**49 CFR Ch. I (10–1–14 Edition)**

- 16 This description applies to smokeless powder and other solid propellants that are used as powder for small arms and have been classed as Division 1.3C, 1.4C and Division 4.1 in accordance with §173.56 of this subchapter.
- 19 For domestic transportation only, the identification number “UN1075” may be used in place of the identification number specified in column (4) of the §172.101 table. The identification number used must be consistent on package markings, shipping papers and emergency response information.
- 21 This material must be stabilized by appropriate means (e.g., addition of chemical inhibitor, purging to remove oxygen) to prevent dangerous polymerization (see §173.21(f) of this subchapter).
- 22 If the hazardous material is in dispersion in organic liquid, the organic liquid must have a flash point above 50 °C (122 °F).
- 23 This material may be transported under the provisions of Division 4.1 only if it is so packed that the percentage of diluent will not fall below that stated in the shipping description at any time during transport. Quantities of not more than 500 g per package with not less than 10 percent water by mass may also be classed in Division 4.1, provided a negative test result is obtained when tested in accordance with test series 6(c) of the UN Manual of Tests and Criteria (IBR, see §171.7 of this subchapter).
- 24 Alcoholic beverages containing more than 70 percent alcohol by volume must be transported as materials in Packing Group II. Alcoholic beverages containing more than 24 percent but not more than 70 percent alcohol by volume must be transported as materials in Packing Group III.
- 26 This entry does not include ammonium permanganate, the transport of which is prohibited except when approved by the Associate Administrator.
- 28 The dihydrated sodium salt of dichloroisocyanuric acid is not subject to the requirements of this subchapter.
- 30 Sulfur is not subject to the requirements of this subchapter if transported in a non-bulk packaging or if formed to a specific shape (for example, prills, granules, pellets, pastilles, or flakes). A bulk packaging containing sulfur is not subject to the placarding requirements of subpart F of this part, if it is marked with the appropriate identification number as required by subpart D of this part. Molten sulfur must be marked as required by §172.325 of this subchapter.
- 31 Materials which have undergone sufficient heat treatment to render them non-hazardous are not subject to the requirements of this subchapter.
- 32 Polymeric beads and molding compounds may be made from polystyrene, poly(methyl methacrylate) or other polymeric material.
- 33 Ammonium nitrites and mixtures of an inorganic nitrite with an ammonium salt are prohibited.
- 34 The commercial grade of calcium nitrate fertilizer, when consisting mainly of a double salt (calcium nitrate and ammonium nitrate) containing not more than 10 percent ammonium nitrate and at least 12 percent water of crystallization, is not subject to the requirements of this subchapter.
- 35 Antimony sulphides and oxides which do not contain more than 0.5 percent of arsenic calculated on the total mass do not meet the definition of Division 6.1.
- 37 Unless it can be demonstrated by testing that the sensitivity of the substance in its frozen state is no greater than in its liquid state, the substance must remain liquid during normal transport conditions. It must not freeze at temperatures above –15 °C (5 °F).
- 38 If this material shows a violent effect in laboratory tests involving heating under confinement, the labeling requirements of Special Provision 53 apply, and the material must be packaged in accordance with packing method OP6 in §173.225 of this subchapter. If the SADT of the technically pure substance is higher than 75 °C, the technically pure substance and formulations derived from it are not self-reactive materials and, if not meeting any other hazard class, are not subject to the requirements of this subchapter.
- 39 This substance may be carried under provisions other than those of Class 1 only if it is so packed that the percentage of water will not fall below that stated at any time during transport. When phlegmatized with water and inorganic inert material, the content of urea nitrate must not exceed 75 percent by mass and the mixture should not be capable of being detonated by test 1(a)(i) or test 1(a)(ii) in the UN Manual of Tests and Criteria (IBR, see §171.7 of this subchapter).
- 40 Polyester resin kits consist of two components: A base material (Class 3, Packing Group II or III) and an activator (organic peroxide), each separately packed in an inner packaging. The organic peroxide must be type D, E, or F, not requiring temperature control. The components may be placed in the same outer packaging provided they will not interact dangerously in the event of leakage. The Packing Group assigned will be II or III, according to the classification criteria for Class 3, applied to the base material. Additionally, unless otherwise excepted in this subchapter, polyester resin kits must be packaged in specification combination packagings based on the performance level of the base material contained within the kit.

- 41 This material at the Packing Group II hazard criteria level may be transported in Large Packagings.
- 43 The membrane filters, including paper separators and coating or backing materials, that are present in transport, must not be able to propagate a detonation as tested by one of the tests described in the UN Manual of Tests and Criteria, Part I, Test series 1(a) (IBR, see §171.7 of this subchapter). On the basis of the results of suitable burning rate tests, and taking into account the standard tests in the UN Manual of Tests and Criteria, Part III, subsection 33.2.1 (IBR, see §171.7 of this subchapter), nitrocellulose membrane filters in the form in which they are to be transported that do not meet the criteria for a Division 4.1 material are not subject to the requirements of this subchapter. Packagings must be so constructed that explosion is not possible by reason of increased internal pressure. Nitrocellulose membrane filters covered by this entry, each with a mass not exceeding 0.5 g, are not subject to the requirements of this subchapter when contained individually in an article or a sealed packet.
- 44 The formulation must be prepared so that it remains homogenous and does not separate during transport. Formulations with low nitrocellulose contents and neither showing dangerous properties when tested for their ability to detonate, deflagrate or explode when heated under defined confinement by the appropriate test methods and criteria in the UN Manual of Tests and Criteria (IBR, see §171.7 of this subchapter), nor classed as a Division 4.1 (flammable solid) when tested in accordance with the procedures specified in §173.124 of this subchapter (chips, if necessary, crushed and sieved to a particle size of less than 1.25 mm), are not subject to the requirements of this subchapter.
- 45 Temperature should be maintained between 18 °C (64.4 °F) and 40 °C (104 °F). Tanks containing solidified methacrylic acid must not be reheated during transport.
- 46 This material must be packed in accordance with packing method OP6 (see §173.225 of this subchapter). During transport, it must be protected from direct sunshine and stored (or kept) in a cool and well-ventilated place, away from all sources of heat.
- 47 Mixtures of solids that are not subject to this subchapter and flammable liquids may be transported under this entry without first applying the classification criteria of Division 4.1, provided there is no free liquid visible at the time the material is loaded or at the time the packaging or transport unit is closed. Except when the liquids are fully absorbed in solid material contained in sealed bags, for single packagings, each packaging must correspond to a design type that has passed a leakproofness test at the Packing Group II level. Small inner packagings consisting of sealed packets and articles containing less than 10 mL of a Class 3 liquid in Packing Group II or III absorbed onto a solid material are not subject to this subchapter provided there is no free liquid in the packet or article.
- 48 Mixtures of solids that are not subject to this subchapter and toxic liquids may be transported under this entry without first applying the classification criteria of Division 6.1, provided there is no free liquid visible at the time the material is loaded or at the time the packaging or transport unit is closed. For single packagings, each packaging must correspond to a design type that has passed a leakproofness test at the Packing Group II level. This entry may not be used for solids containing a Packing Group I liquid.
- 49 Mixtures of solids that are not subject to this subchapter and corrosive liquids may be transported under this entry without first applying the classification criteria of Class 8, provided there is no free liquid visible at the time the material is loaded or at the time the packaging or transport unit is closed. For single packagings, each packaging must correspond to a design type that has passed a leakproofness test at the Packing Group II level.
- 50 Cases, cartridge, empty with primer which are made of metallic or plastic casings and meeting the classification criteria of Division 1.4 are not regulated for domestic transportation.
- 51 This description applies to items previously described as “Toy propellant devices, Class C” and includes reloadable kits. Model rocket motors containing 30 grams or less propellant are classed as Division 1.4S and items containing more than 30 grams of propellant but not more than 62.5 grams of propellant are classed as Division 1.4C.
- 52 This entry may only be used for substances that do not exhibit explosive properties of Class 1 (explosive) when tested in accordance with Test Series 1 and 2 of Class 1 (explosive) in the UN Manual of Tests and Criteria, Part I (incorporated by reference; see §171.7 of this subchapter).
- 53 Packages of these materials must bear the subsidiary risk label, “EXPLOSIVE”, and the subsidiary hazard class/division must be entered in parentheses immediately following the primary hazard class in the shipping description, unless otherwise provided in this subchapter or through an approval issued by the Associate Administrator, or the competent authority of the country of origin. A copy of the approval shall accompany the shipping papers.

- 54 Maneb or maneb preparations not meeting the definition of Division 4.3 or any other hazard class are not subject to the requirements of this subchapter when transported by motor vehicle, rail car, or aircraft.
- 55 This device must be approved in accordance with §173.56 of this subchapter by the Associate Administrator.
- 56 A means to interrupt and prevent detonation of the detonator from initiating the detonating cord must be installed between each electric detonator and the detonating cord ends of the jet perforating guns before the charged jet perforating guns are offered for transportation.
- 57 Maneb or Maneb preparations stabilized against self-heating need not be classified in Division 4.2 when it can be demonstrated by testing that a volume of 1 m³ of substance does not self-ignite and that the temperature at the center of the sample does not exceed 200 °C, when the sample is maintained at a temperature of not less than 75 °C ±2 °C for a period of 24 hours, in accordance with procedures set forth for testing self-heating materials in the UN Manual of Tests and Criteria (IBR, see §171.7 of this subchapter).
- 58 Aqueous solutions of Division 5.1 inorganic solid nitrate substances are considered as not meeting the criteria of Division 5.1 if the concentration of the substances in solution at the minimum temperature encountered in transport is not greater than 80% of the saturation limit.
- 59 Ferrocerium, stabilized against corrosion, with a minimum iron content of 10 percent is not subject to the requirements of this subchapter.
- 61 A chemical oxygen generator is spent if its means of ignition and all or a part of its chemical contents have been expended.
- 62 Oxygen generators (see §171.8 of this subchapter) are not authorized for transportation under this entry.
- 64 The group of alkali metals includes lithium, sodium, potassium, rubidium, and caesium.
- 65 The group of alkaline earth metals includes magnesium, calcium, strontium, and barium.
- 66 Formulations of these substances containing not less than 30 percent non-volatile, non-flammable phlegmatizer are not subject to this subchapter.
- 70 Black powder that has been classed in accordance with the requirements of §173.56 of this subchapter may be reclassified and offered for domestic transportation as a Division 4.1 material if it is offered for transportation and transported in accordance with the limitations and packaging requirements of §173.170 of this subchapter.
- 74 During transport, this material must be protected from direct sunshine and stored or kept in a cool and well-ventilated place, away from all sources of heat.
- 78 This entry may not be used to describe compressed air which contains more than 23.5 percent oxygen. Compressed air containing greater than 23.5 percent oxygen must be shipped using the description “Compressed gas, oxidizing, n.o.s., UN3156.”
- 79 This entry may not be used for mixtures that meet the definition for oxidizing gas.
- 81 Polychlorinated biphenyl items, as defined in 40 CFR 761.3, for which specification packagings are impractical, may be packaged in non-specification packagings meeting the general packaging requirements of subparts A and B of part 173 of this subchapter. Alternatively, the item itself may be used as a packaging if it meets the general packaging requirements of subparts A and B of part 173 of this subchapter.
- 101 The name of the particular substance or article must be specified.
- 102 The ends of the detonating cord must be tied fast so that the explosive cannot escape. The articles may be transported as in Division 1.4 Compatibility Group D (1.4D) if all of the conditions specified in §173.63(a) of this subchapter are met.
- 103 Detonators which will not mass detonate and undergo only limited propagation in the shipping package may be assigned to 1.4B classification code. Mass detonate means that more than 90 percent of the devices tested in a package explode practically simultaneously. Limited propagation means that if one detonator near the center of a shipping package is exploded, the aggregate weight of explosives, excluding ignition and delay charges, in this and all additional detonators in the outside packaging that explode may not exceed 25 grams.
- 105 The word “Agents” may be used instead of “Explosives” when approved by the Associate Administrator.
- 106 The recognized name of the particular explosive may be specified in addition to the type.
- 107 The classification of the substance is expected to vary especially with the particle size and packaging but the border lines have not been experimentally determined; appropriate classifications should be verified following the test procedures in §§173.57 and 173.58 of this subchapter.
- 108 Fireworks must be so constructed and packaged that loose pyrotechnic composition will not be present in packages during transportation.
- 109 Rocket motors must be nonpropulsive in transportation unless approved in accordance with §173.56 of this subchapter. A rocket motor to be considered “nonpropulsive” must be capable of unrestrained

- burning and must not appreciably move in any direction when ignited by any means.
- 110 Fire extinguishers transported under UN1044 and oxygen cylinders transported for emergency use under UN1072 may include installed actuating cartridges (cartridges, power device of Division 1.4C or 1.4S), without changing the classification of Division 2.2, provided the aggregate quantity of deflagrating (propellant) explosives does not exceed 3.2 grams per cylinder. Oxygen cylinders with installed actuating cartridges as prepared for transportation must have an effective means of preventing inadvertent activation.
- 111 Explosive substances of Division 1.1 Compatibility Group A (1.1A) are forbidden for transportation if dry or not desensitized, unless incorporated in a device.
- 113 The sample must be given a tentative approval by an agency or laboratory in accordance with §173.56 of this subchapter.
- 114 Jet perforating guns, charged, oil well, without detonator may be reclassified to Division 1.4 Compatibility Group D (1.4D) if the following conditions are met:
- The total weight of the explosive contents of the shaped charges assembled in the guns does not exceed 90.5 kg (200 pounds) per vehicle; and
 - The guns are packaged in accordance with Packing Method US 1 as specified in §173.62 of this subchapter.
- 115 Boosters with detonator, detonator assemblies and boosters with detonators in which the total explosive charge per unit does not exceed 25 g, and which will not mass detonate and undergo only limited propagation in the shipping package may be assigned to 1.4B classification code. Mass detonate means more than 90 percent of the devices tested in a package explode practically simultaneously. Limited propagation means that if one booster near the center of the package is exploded, the aggregate weight of explosives, excluding ignition and delay charges, in this and all additional boosters in the outside packaging that explode may not exceed 25 g.
- 116 Fuzes, detonating may be classed in Division 1.4 if the fuzes do not contain more than 25 g of explosive per fuze and are made and packaged so that they will not cause functioning of other fuzes, explosives or other explosive devices if one of the fuzes detonates in a shipping packaging or in adjacent packages.
- 117 If shipment of the explosive substance is to take place at a time that freezing weather is anticipated, the water contained in the explosive substance must be mixed with denatured alcohol so that freezing will not occur.
- 118 This substance may not be transported under the provisions of Division 4.1 unless specifically authorized by the Associate Administrator (see UN0143 or UN0150 as appropriate).
- 119 This substance, when in quantities of not more than 11.5 kg (25.3 pounds), with not less than 10 percent water, by mass, also may be classed as Division 4.1, provided a negative test result is obtained when tested in accordance with test series 6(c) of the UN Manual of Tests and Criteria (IBR, see §171.7 of this subchapter).
- 120 The phlegmatized substance must be significantly less sensitive than dry PETN.
- 121 This substance, when containing less alcohol, water or phlegmatizer than specified, may not be transported unless approved by the Associate Administrator.
- 123 Any explosives, blasting, type C containing chlorates must be segregated from explosives containing ammonium nitrate or other ammonium salts.
- 125 Lactose or glucose or similar materials may be used as a phlegmatizer provided that the substance contains not less than 90%, by mass, of phlegmatizer. These mixtures may be classified in Division 4.1 when tested in accordance with test series 6(c) of the UN Manual of Tests and Criteria (IBR, see §171.7 of this subchapter) and approved by the Associate Administrator. Testing must be conducted on at least three packages as prepared for transport. Mixtures containing at least 98%, by mass, of phlegmatizer are not subject to the requirements of this subchapter. Packages containing mixtures with not less than 90% by mass, of phlegmatizer need not bear a POISON subsidiary risk label.
- 127 Mixtures containing oxidizing and organic materials transported under this entry may not meet the definition and criteria of a Class 1 material. (See §173.50 of this subchapter.)
- 128 Regardless of the provisions of §172.101(c)(12), aluminum smelting by-products and aluminum remelting by-products described under this entry, meeting the definition of Class 8, Packing Group II and III may be classed as a Division 4.3 material and transported under this entry. The presence of a Class 8 hazard must be communicated as required by this part for subsidiary hazards.
- 129 These materials may not be classified and transported unless authorized by the Associate Administrator on the basis of results from Series 2 Test and a Series 6(c) Test from the UN Manual of Tests and Criteria (IBR, see §171.7 of this subchapter) on packages as prepared for transport. The packing group assignment and packaging must be approved by the Associate Administrator for Hazardous Materials Safety on the basis of the criteria in §173.21 of this subchapter and the package type used for the Series 6(c) test.

130 “Batteries, dry, sealed, n.o.s.,” commonly referred to as dry batteries, are hermetically sealed and generally utilize metals (other than lead) and/or carbon as electrodes. These batteries are typically used for portable power applications. The rechargeable (and some non-rechargeable) types have gelled alkaline electrolytes (rather than acidic) making it difficult for them to generate hydrogen or oxygen when overcharged and therefore, differentiating them from non-spillable batteries. Dry batteries specifically covered by another entry in the §172.101 Table must be transported in accordance with the requirements applicable to that entry. For example, nickel-metal hydride batteries transported by vessel in certain quantities are covered by another entry (*see* Batteries, nickel-metal hydride, UN3496). Dry batteries not specifically covered by another entry in the §172.101 Table are covered by this entry (*i.e.*, Batteries, dry, sealed, n.o.s.) and are not subject to requirements of this subchapter except for the following:

- (a) *Incident reporting.* For transportation by aircraft, a telephone report in accordance with §171.15(a) is required if a fire, violent rupture, explosion or dangerous evolution of heat (*i.e.*, an amount of heat sufficient to be dangerous to packaging or personal safety to include charring of packaging, melting of packaging, scorching of packaging, or other evidence) occurs as a direct result of a dry battery. For all modes of transportation, a written report submitted, retained, and updated in accordance with §171.16 is required if a fire, violent rupture, explosion or dangerous evolution of heat occurs as a direct result of a dry battery or battery-powered device.
- (b) *Preparation for transport.* Batteries and battery-powered device(s) containing batteries must be prepared and packaged for transport in a manner to prevent:
- (1) A dangerous evolution of heat;
 - (2) Short circuits, including but not limited to the following methods:
 - (i) Packaging each battery or each battery-powered device when practicable, in fully enclosed inner packagings made of non-conductive material;
 - (ii) Separating or packaging batteries in a manner to prevent contact with other batteries, devices or conductive materials (*e.g.*, metal) in the packagings; or
 - (iii) Ensuring exposed terminals or connectors are protected with non-conductive caps, non-conductive tape, or by other appropriate means; and
 - (3) Damage to terminals. If not impact resistant, the outer packaging should not be used as the sole means of protecting the battery terminals from damage or short circuiting. Batteries must be securely cushioned and packed to prevent

shifting which could loosen terminal caps or reorient the terminals to produce short circuits. Batteries contained in devices must be securely installed. Terminal protection methods include but are not limited to the following:

- (i) Securely attaching covers of sufficient strength to protect the terminals;
 - (ii) Packaging the battery in a rigid plastic packaging; or
 - (iii) Constructing the battery with terminals that are recessed or otherwise protected so that the terminals will not be subjected to damage if the package is dropped.
- (c) *Additional air transport requirements.* For a battery whose voltage (electrical potential) exceeds 9 volts—
- (1) When contained in a device, the device must be packaged in a manner that prevents unintentional activation or must have an independent means of preventing unintentional activation (*e.g.*, packaging restricts access to activation switch, switch caps or locks, recessed switches, trigger locks, temperature sensitive circuit breakers, *etc.*); and
 - (2) An indication of compliance with this special provision must be provided by marking each package with the words “not restricted” or by including the words “not restricted” on a transport document such as an air waybill accompanying the shipment.
- (d) *Used or spent battery exception.* Used or spent dry batteries of both non-rechargeable and rechargeable designs, with a marked rating up to 9-volt that are combined in the same package and transported by highway or rail for recycling, reconditioning, or disposal are not subject to this special provision or any other requirement of the HMR. Note that batteries utilizing different chemistries (*i.e.*, those battery chemistries specifically covered by another entry in the §172.101 Table) as well as dry batteries with a marked rating greater than 9-volt may not be combined with used or spent batteries in the same package. Note also that this exception does not apply to batteries that have been reconditioned for reuse.
- 131 This material may not be offered for transportation unless approved by the Associate Administrator.
- 132 This entry may only be used for uniform, ammonium nitrate based fertilizer mixtures, containing nitrogen, phosphate or potash, meeting the following criteria: (1) Contains not more than 70% ammonium nitrate and not more than 0.4% total combustible, organic material calculated as carbon or (2) Contains not more than 45% ammonium nitrate and unrestricted combustible material.

134 This entry only applies to vehicles powered by wet batteries, sodium batteries, lithium metal batteries or lithium ion batteries and equipment powered by wet batteries or sodium batteries that are transported with these batteries installed. For the purpose of this special provision, vehicles are self-propelled apparatus designed to carry one or more persons or goods. Examples of such vehicles are electrically-powered cars, motorcycles, scooters, three- and four-wheeled vehicles or motorcycles, battery-assisted bicycles, lawn tractors, boats, aircraft, wheelchairs and other mobility aids. Examples of equipment are lawnmowers, cleaning machines or model boats and model aircraft. Equipment powered by lithium metal batteries or lithium ion batteries must be consigned under the entries "Lithium metal batteries contained in equipment" or "Lithium metal batteries packed with equipment" or "Lithium ion batteries contained in equipment" or "Lithium ion batteries packed with equipment" as appropriate. Self-propelled vehicles or equipment that also contain an internal combustion engine must be consigned under the entries "Engine, internal combustion, flammable gas powered" or "Engine, internal combustion, flammable liquid powered" or "Vehicle, flammable gas powered" or "Vehicle, flammable liquid powered," as appropriate. These entries include hybrid electric vehicles powered by both an internal combustion engine and batteries. Additionally, self-propelled vehicles or equipment that contain a fuel cell engine must be consigned under the entries "Engine, fuel cell, flammable gas powered" or "Engine, fuel cell, flammable liquid powered" or "Vehicle, fuel cell, flammable gas powered" or "Vehicle, fuel cell, flammable liquid powered," as appropriate. These entries include hybrid electric vehicles powered by a fuel cell engine, an internal combustion engine, and batteries.

135 Internal combustion engines installed in a vehicle must be consigned under the entries "Vehicle, flammable gas powered" or "Vehicle, flammable liquid powered," as appropriate. These entries include hybrid electric vehicles powered by both an internal combustion engine and wet, sodium or lithium batteries installed. If a fuel cell engine is installed in a vehicle, the vehicle must be consigned using the entries "Vehicle, fuel cell, flammable gas powered" or "Vehicle, fuel cell, flammable liquid powered," as appropriate. These entries include hybrid electric vehicles powered by a fuel cell, an internal combustion engine, and wet, sodium or lithium batteries installed.

136 This entry only applies to machinery and apparatus containing hazardous materials as an integral element of the machinery

or apparatus. It may not be used to describe machinery or apparatus for which a proper shipping name exists in the §172.101 Table. Except when approved by the Associate Administrator, machinery or apparatus may only contain hazardous materials for which exceptions are referenced in Column (8) of the §172.101 Table and are provided in part 173, subpart D, of this subchapter. Hazardous materials shipped under this entry are excepted from the labeling requirements of this subchapter unless offered for transportation or transported by aircraft and are not subject to the placarding requirements of part 172, subpart F, of this subchapter. Orientation markings as described in §172.312 (a)(2) are required when liquid hazardous materials may escape due to incorrect orientation. The machinery or apparatus, if unpackaged, or the packaging in which it is contained shall be marked "Dangerous goods in machinery" or "Dangerous goods in apparatus", as appropriate, with the identification number UN3363. For transportation by aircraft, machinery or apparatus may not contain any material forbidden for transportation by passenger or cargo aircraft. The Associate Administrator may except from the requirements of this subchapter, equipment, machinery and apparatus provided:

- a. It is shown that it does not pose a significant risk in transportation;
- b. The quantities of hazardous materials do not exceed those specified in §173.4a of this subchapter; and
- c. The equipment, machinery or apparatus conforms with §173.222 of this subchapter.

137 Cotton, dry; flax, dry; sisal, dry; and tampico fiber, dry are not subject to the requirements of this subchapter when they are baled in accordance with ISO 8115, "Cotton Bales—Dimensions and Density" (IBR, see §171.7 of this subchapter) to a density of not less than 360 kg/m³ (22.1 lb/ft³) for cotton, 400 kg/m³ (24.97 lb/ft³) for flax, 620 kg/m³ (38.71 lb/ft³) for sisal and 360 kg/m³ (22.1 lb/ft³) for tampico fiber and transported in a freight container or closed transport vehicle.

138 This entry applies to lead compounds which, when mixed in a ratio of 1:1,000 with 0.07 M (Molar concentration) hydrochloric acid and stirred for one hour at a temperature of 23 °C ±2 °C, exhibit a solubility of more than 5%. Lead compounds which, when mixed in a ratio of 1:1,000 with 0.07 M (Molar concentration) hydrochloric acid and stirred for one hour at a temperature of 23 °C ±2 °C, exhibit a solubility of 5% or less are not subject to the requirements of this subchapter unless they meet criteria as another hazard class or division. Lead compounds that have a solubility of 5% or

less in accordance with this special provision are not subject to the requirements of this subchapter that pertain to Marine Pollutants.

- 139 Use of the “special arrangement” proper shipping names for international shipments must be made under an IAEA Certificate of Competent Authority issued by the Associate Administrator in accordance with the requirements in §173.471, §173.472, or §173.473 of this subchapter. Use of these proper shipping names for domestic shipments may be made only under a DOT special permit, as defined in, and in accordance with the requirements of subpart B of part 107 of this subchapter.
- 140 This material is regulated only when it meets the defining criteria for a hazardous substance or a marine pollutant. In addition, the column 5 reference is modified to read “III” on those occasions when this material is offered for transportation or transported by highway or rail.
- 141 A toxin obtained from a plant, animal, or bacterial source containing an infectious substance, or a toxin contained in an infectious substance, must be classed as Division 6.2, described as an infectious substance, and assigned to UN 2814 or UN 2900, as appropriate.
- 142 These hazardous materials may not be classified and transported unless authorized by the Associate Administrator. The Associate Administrator will base the authorization on results from Series 2 tests and a Series 6(c) test from the UN Manual of Tests and Criteria (IBR, see §171.7 of this subchapter) on packages as prepared for transport in accordance with the requirements of this subchapter.
- 144 If transported as a residue in an underground storage tank (UST), as defined in 40 CFR 280.12, that has been cleaned and purged or rendered inert according to the American Petroleum Institute (API) Standard 1604 (IBR, see §171.7 of this subchapter), then the tank and this material are not subject to any other requirements of this subchapter. However, sediments remaining in the tank that meet the definition for a hazardous material are subject to the applicable regulations of this subchapter.
- 145 This entry applies to formulations that neither detonate in the cavitated state nor deflagrate in laboratory testing, show no effect when heated under confinement, exhibit no explosive power, and are thermally stable (self-accelerating decomposition temperature (SADT) at 60 °C (140 °F) or higher for a 50 kg (110.2 lbs.) package). Formulations not meeting these criteria must be transported under the provisions applicable to the appropriate entry in the Organic Peroxide Table in §173.225 of this subchapter.

- 146 This description may be used for a material that poses a hazard to the environment but does not meet the definition for a hazardous waste or a hazardous substance, as defined in §171.8 of this subchapter, or any hazard class, as defined in part 173 of this subchapter, if it is designated as environmentally hazardous by another Competent Authority. This provision may be used for both domestic and international shipments.
- 147 This entry applies to non-sensitized emulsions, suspensions, and gels consisting primarily of a mixture of ammonium nitrate and fuel, intended to produce a Type E blasting explosive only after further processing prior to use. The mixture for emulsions typically has the following composition: 60–85% ammonium nitrate; 5–30% water; 2–8% fuel; 0.5–4% emulsifier or thickening agent; 0–10% soluble flame suppressants; and trace additives. Other inorganic nitrate salts may replace part of the ammonium nitrate. The mixture for suspensions and gels typically has the following composition: 60–85% ammonium nitrate; 0–5% sodium or potassium perchlorate; 0–17% hexamine nitrate or monomethylamine nitrate; 5–30% water; 2–15% fuel; 0.5–4% thickening agent; 0–10% soluble flame suppressants; and trace additives. Other inorganic nitrate salts may replace part of the ammonium nitrate. These substances must satisfactorily pass Test Series 8 of the UN Manual of Tests and Criteria, Part I, Section 18 (IBR, see §171.7 of this subchapter), and may not be classified and transported unless approved by the Associate Administrator.
- 149 When transported as a limited quantity or a consumer commodity, the maximum net capacity specified in §173.150(b)(2) of this subchapter for inner packagings may be increased to 5 L (1.3 gallons).
- 150 This description may be used only for uniform mixtures of fertilizers containing ammonium nitrate as the main ingredient within the following composition limits:
- Not less than 90% ammonium nitrate with not more than 0.2% total combustible, organic material calculated as carbon, and with added matter, if any, that is inorganic and inert when in contact with ammonium nitrate; or
 - Less than 90% but more than 70% ammonium nitrate with other inorganic materials, or more than 80% but less than 90% ammonium nitrate mixed with calcium carbonate and/or dolomite and/or mineral calcium sulphate, and not more than 0.4% total combustible, organic material calculated as carbon; or
 - Ammonium nitrate-based fertilizers containing mixtures of ammonium nitrate and ammonium sulphate with more than

- 45% but less than 70% ammonium nitrate, and not more than 0.4% total combustible, organic material calculated as carbon such that the sum of the percentage of compositions of ammonium nitrate and ammonium sulphate exceeds 70%.
- 151 If this material meets the definition of a flammable liquid in §173.120 of this subchapter, a FLAMMABLE LIQUID label is also required and the basic description on the shipping paper must indicate the Class 3 subsidiary hazard.
- 155 Fish meal, fish scrap and krill meal may not be transported if the temperature at the time of loading either exceeds 35 °C (95 °F), or exceeds 5 °C (41 °F) above the ambient temperature, whichever is higher.
- 156 Asbestos that is immersed or fixed in a natural or artificial binder material, such as cement, plastic, asphalt, resins or mineral ore, or contained in manufactured products is not subject to the requirements of this subchapter.
- 159 This material must be protected from direct sunshine and kept in a cool, well-ventilated place away from sources of heat.
- 160 This entry applies to articles that are used as life-saving vehicle air bag inflators, air bag modules or seat-belt pretensioners containing Class 1 (explosive) materials or materials of other hazard classes. Air bag inflators and modules must be tested in accordance with Test series 6(c) of Part I of the UN Manual of Tests and Criteria (incorporated by reference; see §171.7 of this subchapter), with no explosion of the device, no fragmentation of device casing or pressure vessel, and no projection hazard or thermal effect that would significantly hinder fire-fighting or other emergency response efforts in the immediate vicinity. If the air bag inflator unit satisfactorily passes the series 6(c) test, it is not necessary to repeat the test on the air bag module.
- 161 For domestic transport, air bag inflators, air bag modules or seat-belt pretensioners that meet the criteria for a Division 1.4G explosive must be transported using the description, "Articles, pyrotechnic for technical purposes," UN0431. See §173.166(d)(1) of this subchapter for an exception regarding air bag inflators, air bag modules, or seat-belt pretensioners that are installed in a motor vehicle, aircraft, boat or other transport conveyance or its completed components, such as steering columns or door panels.
- 162 This material may be transported under the provisions of Division 4.1 only if it is packed so that at no time during transport will the percentage of diluent fall below the percentage that is stated in the shipping description.
- 163 Substances must satisfactorily pass Test Series 8 of the UN Manual of Tests and Criteria, Part I, Section 18 (IBR, see §171.7 of this subchapter).
- 164 Substances must not be transported under this entry unless approved by the Associate Administrator on the basis of the results of appropriate tests according to Part I of the UN Manual of Tests and Criteria (IBR, see §171.7 of this subchapter). The material must be packaged so that the percentage of diluent does not fall below that stated in the approval at any time during transportation.
- 165 These substances are susceptible to exothermic decomposition at elevated temperatures. Decomposition can be initiated by heat, moisture or by impurities (e.g., powdered metals (iron, manganese, cobalt, magnesium)). During the course of transportation, these substances must be shaded from direct sunlight and all sources of heat and be placed in adequately ventilated areas.
- 166 When transported in non-friable tablet form, calcium hypochlorite, dry, may be transported as a Packing Group III material.
- 167 These storage systems must always be considered as containing hydrogen. A metal hydride storage system installed in or intended to be installed in a vehicle or equipment or in vehicle or equipment components must be approved for transport by the Associate Administrator. A copy of the approval must accompany each shipment.
- 168 For lighters containing a Division 2.1 gas (see §171.8 of this subchapter), representative samples of each new lighter design must be examined and successfully tested as specified in §173.308(b)(3). For criteria in determining what is a new lighter design, see §173.308(b)(1). For transportation of new lighter design samples for examination and testing, see §173.308(b)(2). The examination and testing of each lighter design must be performed by a person authorized by the Associate Administrator under the provisions of subpart E of part 107 of this chapter, as specified in §173.308(a)(4). For continued use of approvals dated prior to January 1, 2012, see §173.308(b)(5).
- For non-pressurized lighters containing a Class 3 (flammable liquid) material, its design, description, and packaging must be approved by the Associate Administrator prior to being offered for transportation or transported in commerce. In addition, a lighter design intended to contain a non-pressurized Class 3 material is excepted from the examination and testing criteria specified in §173.308(b)(3). An unused lighter or a lighter that is cleaned of residue and purged of vapors is not subject to the requirements of this subchapter.
- 169 This entry applies to lighter refills (see §171.8 of this subchapter) that contain a

- Division 2.1 (flammable) gas but do not contain an ignition device. Lighter refills offered for transportation under this entry may not exceed 4 fluid ounces capacity (7.22 cubic inches) or contain more than 65 grams of fuel. A lighter refill exceeding 4 fluid ounces capacity (7.22 cubic inches) or containing more than 65 grams of fuel must be classed as a Division 2.1 material, described with the proper shipping name appropriate for the material, and packaged in the packaging specified in part 173 of this subchapter for the flammable gas contained therein. In addition, a container exceeding 4 fluid ounces volumetric capacity (7.22 cubic inches) or containing more than 65 grams of fuel may not be connected or manifolded to a lighter or similar device and must also be described and packaged according to the fuel contained therein. For transportation by passenger-carrying aircraft, the net mass of lighter refills may not exceed 1 kg per package, and, for cargo-only aircraft, the net mass of lighter refills may not exceed 15 kg per package. See §173.306(h) of this subchapter.
- 170 Air must be eliminated from the vapor space by nitrogen or other means.
- 171 This entry may only be used when the material is transported in non-friable tablet form or for granular or powered mixtures that have been shown to meet the PG III criteria in §173.127.
- 172 This entry includes alcohol mixtures containing up to 5% petroleum products.
- 173 For adhesives, printing inks, printing ink-related materials, paints, paint-related materials, and resin solutions which are assigned to UN3082, and do not meet the definition of another hazard class, metal or plastic packaging for substances of packing groups II and III in quantities of 5 L (1.3 gallons) or less per packaging are not required to meet the UN performance package testing when transported:
- a. Except for transportation by aircraft, in palletized loads, a pallet box or unit load device (*e.g.* individual packaging placed or stacked and secured by strapping, shrink or stretch-wrapping or other suitable means to a pallet). For vessel transport, the palletized loads, pallet boxes or unit load devices must be firmly packed and secured in closed cargo transport units; or
 - b. Except for transportation by aircraft, as an inner packaging of a combination packaging with a maximum net mass of 40 kg (88 pounds). For transportation by aircraft, as an inner packaging of a combination packaging with a maximum gross mass of 30 kg when packaged as a limited quantity in accordance with §173.27(f).
- 175 This substance must be stabilized when in concentrations of not more than 99%.
- 176 This entry must be used for formaldehyde solutions containing methanol as a stabilizer. Formaldehyde solutions not containing methanol and not meeting the Class 3 flammable liquid criteria must be described using a different proper shipping name.
- 177 Gasoline, or, ethanol and gasoline mixtures, for use in internal combustion engines (*e.g.*, in automobiles, stationary engines and other engines) must be assigned to Packing Group II regardless of variations in volatility.
- 198 Nitrocellulose solutions containing not more than 20% nitrocellulose may be transported as paint, perfumery products, or printing ink, as applicable, provided the nitrocellulose contains no more 12.6% nitrogen (by dry mass). See UN1210, UN1263, UN1266, UN3066, UN3469, and UN3470.
- 200 Division 1.4G consumer fireworks may be certified for transportation by a DOT-approved Fireworks Certification Agency in accordance with the provisions of §173.65 of this subchapter.
- 222 Shipments offered for transportation by aircraft may not be reclassified as ORM-D.
- 237 "Batteries, dry, containing potassium hydroxide solid, *electric storage*" must be prepared and packaged in accordance with the requirements of §173.159(a) and (c). For transportation by aircraft, the provisions of §173.159(b)(2) apply. This entry may only be used for the transport of non-activated batteries that contain dry potassium hydroxide and that are intended to be activated prior to use by the addition of an appropriate amount of water to the individual cells.
- 238 Neutron radiation detectors:
- a. Neutron radiation detectors containing non-pressurized boron trifluoride gas in excess of 1 gram and radiation detection systems containing such neutron radiation detectors as components may be transported by highway, rail, vessel, or cargo aircraft in accordance with the following:
 - (1) The pressure in each neutron radiation detector must not exceed 105 kPa absolute at 20 °C;
 - (2) The amount of gas must not exceed 12.8 grams per detector and the amount per outer packaging or per radiation detection system must not exceed 51.2 grams;
 - (3) Each neutron radiation detector must be of welded metal construction with brazed metal to ceramic feed through assemblies. They must have a minimum burst pressure of 1800 kPa; and
 - (4) Each neutron radiation detector must be packed in a sealed intermediate plastic liner with sufficient absorbent material to absorb the entire gas contents. Neutron radiation detectors must be packed in strong outer packagings that are capable of withstanding a 1.8 meter

- (6-foot) drop without leakage. Radiation detection systems containing neutron radiation detectors must also include absorbent material sufficient to absorb the entire gas contents of the neutron radiation detectors. Absorbent material must be surrounded by a liner or liners, as appropriate. They must be packed in strong outer packagings unless neutron radiation detectors are afforded equivalent protection by the radiation detection system.
- b. Except for transportation by aircraft, neutron radiation detectors and radiation detection systems containing such detectors transported in accordance with paragraph (a) of this special provision are not subject to the labeling and placarding requirements of part 172 of this subchapter.
- c. When transported by highway, rail, vessel, or as cargo on an aircraft, neutron radiation detectors containing not more than 1 gram of boron trifluoride, including those with solder glass joints, and radiation detection systems containing such detectors, where the neutron radiation detectors meet and are packed in accordance with the requirements of paragraph (a) of this special provision, are not subject to any other requirements of this subchapter.
- 328 When lithium metal or lithium ion batteries are contained in the fuel cell system, the item must be described under this entry and the appropriate entries for "Lithium metal batteries contained in equipment" or "Lithium ion batteries contained in equipment".
- 332 Magnesium nitrate hexahydrate is not subject to the requirements of this subchapter.
- 335 Mixtures of solids that are not subject to this subchapter and environmentally hazardous liquids or solids may be classified as "Environmentally hazardous substances, solid, n.o.s.," UN3077 and may be transported under this entry, provided there is no free liquid visible at the time the material is loaded or at the time the packaging or transport unit is closed. Each transport unit must be leakproof when used as bulk packaging.
- 336 The use of UN1H1 drums, UN3H1 jerricans, and UN6HA1 composite packagings which meet the requirements of part 178 of the HMR at the Packing Group I or II performance level. These packagings are not required to: (1.) meet the venting requirements in §173.24(g) or (2.) be marked with the hydrostatic pressure test marking specified in §173.24a(b)(4). Shipment of packages under this special provision must be made by private or contract motor carrier. Transportation of these packages also requires the door of each van trailer to be marked with "Warning trailer may contain chemical vapor. Do not enter until vapors have dissipated." The driver of the transport vehicle and the consignee(s) must be trained not to enter the transport vehicle until the ammonia vapors have dissipated, and the emergency response information on the shipping paper must indicate that the vehicle contains ammonia vapors. This training must be documented in training records required by §172.704(d). Transport vehicles must be vented to prevent accumulation of vapors at a poisonous or flammable concentration.
- 337 Authorizes the use of regulated waste containers manufactured prior to October 1, 2006 to be marked with the alternative shipping name of Regulated medical waste, UN3291 and arrows that deviate as prescribed in §172.312(a)(2) in that they may be black or white.
- 338 Life Saving appliances, self-inflating transported between an U.S. Coast Guard approved inflatable life raft servicing facility and a vessel are only subject to the following requirements:
- Prior to repacking into the life-saving appliance, an installed inflation cylinder must successfully meet and pass all inspection and test criteria and standards of the raft manufacturer and the vessel Flag State requirements for cylinders installed as part of life-saving appliances, self-inflating (UN2990) used on marine vessels. Additionally, each cylinder must be visually inspected in accordance with CGA pamphlet, CGA C-6 (incorporated by reference, see §171.7). A current copy of CGA pamphlet, CGA C-6 must be available at the facility servicing the life-saving appliance.
 - An installed inflation cylinder that requires recharging must be filled in accordance with §173.301(1).
 - Every installed inflation cylinder, as associated equipment of the life-saving appliance, must be packed within the protective packaging of the life raft and the life raft itself must otherwise be in compliance with §173.219.
 - The serial number for each cylinder must be recorded as part of the life-saving appliance service record by the U.S. Coast Guard-approved servicing facility.
- 340 This entry applies only to the vessel transportation of nickel-metal hydride batteries as cargo. Nickel-metal hydride button cells or nickel-metal hydride cells or batteries packed with or contained in battery-powered devices transported by vessel are not subject to the requirements of this special provision. See "Batteries, dry, sealed, n.o.s." in the §172.101 Hazardous Materials Table (HMT) of this part for transportation requirements for nickel-metal hydride batteries transported by other modes and for nickel-metal hydride button cells or nickel-metal hydride cells

or batteries packed with or contained in battery-powered devices transported by vessel. Nickel-metal hydride batteries subject to this special provision are subject only to the following requirements: (1) The batteries must be prepared and packaged for transport in a manner to prevent a dangerous evolution of heat, short circuits, and damage to terminals; and are subject to the incident reporting in accordance with §171.16 of this subchapter if a fire, violent rupture, explosion or dangerous evolution of heat (*i.e.*, an amount of heat sufficient to be dangerous to packaging or personal safety to include charring of packaging, melting of packaging, scorching of packaging, or other evidence) occurs as a direct result of a nickel metal hydride battery; and (2) when loaded in a cargo transport unit in a total quantity of 100 kg gross mass or more, the shipping paper requirements of Subpart C of this part, the manifest requirements of §176.30 of this subchapter, and the vessel stowage requirements assigned to this entry in Column (10) of the §172.101 Hazardous Materials Table.

342 Glass inner packagings (such as ampoules or capsules) intended only for use in sterilization devices, when containing less than 30 mL of ethylene oxide per inner packaging with not more than 300 mL per outer packaging, may be transported in accordance with §173.4a of this subchapter, irrespective of the restriction of §173.4a(b) provided that:

a. After filling, each glass inner packaging must be determined to be leak-tight by placing the glass inner packaging in a hot water bath at a temperature and for a period of time sufficient to ensure that an internal pressure equal to the vapor pressure of ethylene oxide at 55 °C is achieved. Any glass inner packaging showing evidence of leakage, distortion or other defect under this test must not be transported under the terms of this special provision;

b. In addition to the packaging required in §173.4a, each glass inner packaging must be placed in a sealed plastic bag compatible with ethylene oxide and capable of containing the contents in the event of breakage or leakage of the glass inner packaging; and

c. Each glass inner packaging is protected by a means of preventing puncture of the plastic bag (*e.g.*, sleeves or cushioning) in the event of damage to the packaging (*e.g.*, by crushing).

343 A bulk packaging that emits hydrogen sulfide in sufficient concentration that vapors evolved from the crude oil can present an inhalation hazard must be marked as specified in §172.327 of this part.

345 “Nitrogen, refrigerated liquid (*cryogenic liquid*), UN1977” transported in open cryo-

genic receptacles with a maximum capacity of 1 L are not subject to the requirements of this subchapter. The receptacles must be constructed with glass double walls having the space between the walls vacuum insulated and each receptacle must be transported in an outer packaging with sufficient cushioning and absorbent materials to protect the receptacle from damage.

346 “Nitrogen, refrigerated liquid (*cryogenic liquid*), UN1977” transported in accordance with the requirements for open cryogenic receptacles in §173.320 and this special provision are not subject to any other requirements of this subchapter. The receptacle must contain no hazardous materials other than the liquid nitrogen which must be fully absorbed in a porous material in the receptacle.

347 Effective July 1, 2011, for transportation by aircraft, this entry may only be used if the results of Test series 6(d) of Part I of the UN Manual of Tests and Criteria (IBR, *see* §171.7 of this subchapter) have demonstrated that any hazardous effects from accidental functioning are confined to within the package. Effective January 1, 2012, for transportation by vessel, this entry may only be used if the results of Test Series 6(d) of Part I of the UN Manual of Tests and Criteria (IBR, *see* §171.7 of this subchapter) have demonstrated that any hazardous effects from accidental functioning are confined to within the package. Effective January 1, 2014, for transportation domestically by highway or rail, this entry may only be used if the results of Test Series 6(d) of Part I of the UN Manual of Tests and Criteria (IBR, *see* §171.7 of this subchapter) have demonstrated that any hazardous effects from accidental functioning are confined to within the package. Testing must be performed or witnessed by a person who is approved by the Associate Administrator (*see* §173.56(b) of this subchapter). All successfully conducted tests or reassignment to another compatibility group require the issuance of a new or revised approval by the Associate Administrator prior to transportation on or after the dates specified for each authorized mode of transport in this special provision.

349 Mixtures of hypochlorite with an ammonium salt are forbidden for transport. A hypochlorite solution, UN1791, is a Class 8 corrosive material.

350 Ammonium bromate, ammonium bromate aqueous solutions, and mixtures of a bromate with an ammonium salt are forbidden for transport.

351 Ammonium chlorate, ammonium chlorate aqueous solutions, and mixtures of a chlorate with an ammonium salt are forbidden for transport.

- 352 Ammonium chlorite, ammonium chlorite aqueous solutions, and mixtures of a chlorite with an ammonium salt are forbidden for transport.
- 353 Ammonium permanganate, ammonium permanganate aqueous solutions, and mixtures of a permanganate with an ammonium salt are forbidden for transport.
- 357 A bulk packaging that emits hydrogen sulfide in sufficient concentration that vapors evolved from the crude oil can present an inhalation hazard must be marked as specified in §172.327 of this part.
- 360 Vehicles only powered by lithium batteries must be assigned the identification number UN3171.
- 361 Capacitors with an energy storage capacity of 0.3 Wh or less are not subject to the requirements of this subchapter. Energy storage capacity means the energy held by a capacitor, as calculated using the nominal voltage and capacitance. This entry does not apply to capacitors that by design maintain a terminal voltage (e.g., asymmetrical capacitors.)
- 362 This entry applies to liquids, pastes or powders, pressurized with a propellant that meets the definition of a gas in §173.115. A chemical under pressure packaged in an aerosol dispenser must be transported under UN1950. The chemical under pressure must be classed based on the hazard characteristics of the components in the propellant; the liquid; or the solid. The following provisions also apply:
- (a) If one of the components, which can be a pure substance or a mixture, is classed as flammable, the chemical under pressure must be classed as flammable in Division 2.1. Flammable components are flammable liquids and liquid mixtures, flammable solids and solid mixtures or flammable gases and gas mixtures meeting the following criteria:
 - (i) A flammable liquid is a liquid having a flashpoint of not more than 93 °C (200 °F);
 - (ii) A flammable solid is a solid that meets the criteria in §173.124 of this subchapter; or
 - (iii) A flammable gas is a gas that meets the criteria in §173.115 of this subchapter.
 - (b) Gases of Division 2.3 and gases with a subsidiary risk of 5.1 must not be used as a propellant in a chemical under pressure.
 - (c) Where the liquid or solid components are classed as Division 6.1, packing groups II or III, or Class 8, packing groups II or III, the chemical under pressure must be assigned a subsidiary risk of Division 6.1 or Class 8 and the appropriate identification number must be assigned. Components classed as Division 6.1, packing group I, or Class 8, packing group I, must not be offered for transportation and transported under this description.
 - (d) A chemical under pressure with components meeting the properties of : Class 1 (explosives); Class 3 (liquid desensitized explosives); Division 4.1 (self-reactive substances and solid desensitized explosives); Division 4.2 (substances liable to spontaneous combustion); Division 4.3 (substances which, in contact with water, emit flammable gases or toxic gases); Division 5.1 (oxidizing substances); Division 5.2 (organic peroxides); Division 6.2 (Infectious substances); or, Class 7 (Radioactive material), must not be offered for transportation under this description.
 - (e) A description to which Special provision 170 or TP7 is assigned in Column 7 of the §172.101 Hazardous Materials Table, and therefore requires air to be eliminated from the package vapor space by nitrogen or other means, must not be offered for transportation under this description.
- 365 For manufactured instruments and articles containing mercury, see UN3506.
- (2) “A” codes. These provisions apply only to transportation by aircraft:
- Code/Special Provisions*
- A1 Single packagings are not permitted on passenger aircraft.
 - A2 Single packagings are not permitted on aircraft.
 - A3 For combination packagings, if glass inner packagings (including ampoules) are used, they must be packed with absorbent material in tightly closed metal receptacles before packing in outer packagings.
 - A4 Liquids having an inhalation toxicity of Packing Group I are not permitted on aircraft.
 - A5 Solids having an inhalation toxicity of Packing Group I are not permitted on passenger aircraft and may not exceed a maximum net quantity per package of 15 kg (33 pounds) on cargo aircraft.
 - A6 For combination packagings, if plastic inner packagings are used, they must be packed in tightly closed metal receptacles before packing in outer packagings.
 - A7 Steel packagings must be corrosion-resistant or have protection against corrosion.
 - A8 For combination packagings, if glass inner packagings (including ampoules) are used, they must be packed with cushioning material in tightly closed metal receptacles before packing in outer packagings.
 - A9 For combination packagings, if plastic bags are used, they must be packed in tightly closed metal receptacles before packing in outer packagings.
 - A10 When aluminum or aluminum alloy construction materials are used, they must be resistant to corrosion.

§ 172.102

49 CFR Ch. I (10–1–14 Edition)

- A11 For combination packagings, when metal inner packagings are permitted, only specification cylinders constructed of metals which are compatible with the hazardous material may be used.
- A13 Bulk packagings are not authorized for transportation by aircraft.
- A14 This material is not authorized to be transported as a limited quantity or consumer commodity in accordance with §173.306 of this subchapter when transported aboard an aircraft.
- A19 Combination packagings consisting of outer fiber drums or plywood drums, with inner plastic packagings, are not authorized for transportation by aircraft.
- A20 Plastic bags as inner receptacles of combination packagings are not authorized for transportation by aircraft.
- A29 Combination packagings consisting of outer expanded plastic boxes with inner plastic bags are not authorized for transportation by aircraft.
- A30 Ammonium permanganate is not authorized for transportation on aircraft.
- A34 Aerosols containing a corrosive liquid in Packing Group II charged with a gas are not permitted for transportation by aircraft.
- A35 This includes any material which is not covered by any of the other classes but which has an anesthetic, narcotic, noxious or other similar properties such that, in the event of spillage or leakage on an aircraft, extreme annoyance or discomfort could be caused to crew members so as to prevent the correct performance of assigned duties.
- A37 This entry applies only to a material meeting the definition in §171.8 of this subchapter for self-defense spray.
- A51 Irrespective of the quantity limitations specified in Column (9A) of the §172.101 Table or §175.75(c), the following aircraft batteries may be transported on passenger aircraft as cargo:
- a. Wet cell batteries, UN 2794 or UN 2795, up to a limit of 100kg net mass per package;
 - b. Lithium ion batteries, UN 3480, packages containing a single aircraft battery with a net mass not exceeding 35kg; and
 - c. Transport in accordance with this special provision must be noted on the shipping paper.
- A53 Refrigerating machines and refrigerating machine components are not subject to the requirements of this subchapter when containing less than 12 kg (26.4 pounds) of a non-flammable gas or when containing 12 L (3 gallons) or less of ammonia solution (UN2672) (see §173.307 of this subchapter).
- A54 Irrespective of the quantity limits in Column 9B of the §172.101 table, a lithium battery, including a lithium battery packed with, or contained in, equipment

- that otherwise meets the applicable requirements of §173.185, may have a mass exceeding 35 kg if approved by the Associate Administrator prior to shipment.
- A56 Radioactive material with a subsidiary hazard of Division 4.2, Packing Group I, must be transported in Type B packages when offered for transportation by aircraft. Radioactive material with a subsidiary hazard of Division 2.1 is forbidden from transport on passenger aircraft.
- A60 Sterilization devices, when containing less than 30 mL per inner packaging with not more than 150 mL per outer packaging, may be transported in accordance with the provisions in §173.4a, irrespective of §173.4a(b), provided such packagings were first subjected to comparative fire testing. Comparative fire testing between a package as prepared for transport (including the substance to be transported) and an identical package filled with water must show that the maximum temperature measured inside the packages during testing does not differ by more than 200 °C (392 °F). Packagings may include a vent to permit the slow escape of gas (i.e. not more than 0.1 mL/hour per 30 mL inner packaging at 20 °C (68 °F) produced from gradual decomposition.
- A82 The quantity limits in columns (9A) and (9B) do not apply to human or animal body parts, whole organs or whole bodies known to contain or suspected of containing an infectious substance.
- A101 In addition to the applicable requirements of §173.185, the quantity of lithium metal in the batteries contained in any piece of equipment must not exceed 12 g per cell and 500 g per battery.
- A105 The total net quantity of dangerous goods contained in one package, excluding magnetic material, must not exceed the following:
- a. 1 kg (2.2 pounds) in the case of solids;
 - b. 0.5 L (0.1 gallons) in the case of liquids;
 - c. 0.5 kg (1.1 pounds) in the case of Division 2.2 gases; or
 - d. any combination thereof.
- A112 Notwithstanding the quantity limits shown in Column (9A) and (9B) for this entry, the following IBCs are authorized for transportation aboard passenger and cargo-only aircraft. Each IBC may not exceed a maximum net quantity of 1,000 kg:
- a. Metal: 11A, 11B, 11N, 21A, 21B and 21N
 - b. Rigid plastics: 11H1, 11H2, 21H1 and 21H2
 - c. Composite with plastic inner receptacle: 11HZ1, 11HZ2, 21HZ1 and 21HZ2
 - d. Fiberboard: 11G
 - e. Wooden: 11C, 11D and 11F (with inner liners)
 - f. Flexible: 13H2, 13H3, 13H4, 13H5, 13L2, 13L3, 13L4, 13M1 and 13M2 (flexible IBCs must be sift-proof and water resistant or must be fitted with a sift-proof and water resistant liner).

A189 Except where the defining criteria of another class or division are met, concentrations of formaldehyde solution:

- a. With less than 25 percent but not less than 10 percent formaldehyde, must be described as UN3334, Aviation regulated liquid, n.o.s.; and
- b. With less than 10 percent formaldehyde, are not subject to this subchapter.

A191 Notwithstanding the Division 6.1 subsidiary risk for this description, the toxic subsidiary risk label and the requirement to indicate the subsidiary risk on the shipping paper are not required for manufactured articles containing less than 5 kg (11 pounds) of mercury.

A200 These articles must be transported as cargo and may not be carried aboard an aircraft by passengers or crewmembers in carry-on baggage, checked baggage, or on their person unless specifically authorized in §175.10.

(3) “B” codes. These provisions apply only to bulk packagings. Except as otherwise provided in this subchapter, these special provisions do not apply to UN portable tanks or IBCs:

Code/Special Provisions

B1 If the material has a flash point at or above 38 °C (100 °F) and below 93 °C (200 °F), then the bulk packaging requirements of §173.241 of this subchapter are applicable. If the material has a flash point of less than 38 °C (100 °F), then the bulk packaging requirements of §173.242 of this subchapter are applicable.

B2 MC 300, MC 301, MC 302, MC 303, MC 305, and MC 306 and DOT 406 cargo tanks are not authorized.

B3 MC 300, MC 301, MC 302, MC 303, MC 305, and MC 306 and DOT 406 cargo tanks and DOT 57 portable tanks are not authorized.

B4 MC 300, MC 301, MC 302, MC 303, MC 305, and MC 306 and DOT 406 cargo tanks are not authorized.

B5 Only ammonium nitrate solutions with 35 percent or less water that will remain completely in solution under all conditions of transport at a maximum lading temperature of 116 °C (240 °F) are authorized for transport in the following bulk packagings: MC 307, MC 312, DOT 407 and DOT 412 cargo tanks with at least 172 kPa (25 psig) design pressure. The packaging shall be designed for a working temperature of at least 121 °C (250 °F). Only Specifications MC 304, MC 307 or DOT 407 cargo tank motor vehicles are authorized for transportation by vessel.

B6 Packagings shall be made of steel.

B7 Safety relief devices are not authorized on multi-unit tank car tanks. Openings for safety relief devices on multi-unit tank car tanks shall be plugged or blank flanged.

B8 Packagings shall be made of nickel, stainless steel, or steel with nickel, stainless steel, lead or other suitable corrosion resistant metallic lining.

B9 Bottom outlets are not authorized.

B10 MC 300, MC 301, MC 302, MC 303, MC 305, and MC 306 and DOT 406 cargo tanks, and DOT 57 portable tanks are not authorized.

B11 Tank car tanks must have a test pressure of at least 2,068.5 kPa (300 psig). Cargo and portable tanks must have a design pressure of at least 1,207 kPa (175 psig).

B13 A nonspecification cargo tank motor vehicle authorized in §173.247 of this subchapter must be at least equivalent in design and in construction to a DOT 406 cargo tank or MC 306 cargo tank (if constructed before August 31, 1995), except as follows:

- a. Packagings equivalent to MC 306 cargo tanks are excepted from the certification, venting, and emergency flow requirements of the MC 306 specification.

- b. Packagings equivalent to DOT 406 cargo tanks are excepted from §§178.345-7(d)(5), circumferential reinforcements; 178.345-10, pressure relief; 178.345-11, outlets; 178.345-14, marking, and 178.345-15, certification.

- c. Packagings are excepted from the design stress limits at elevated temperatures, as described in Section VIII of the ASME Code (IBR, see §171.7 of this subchapter). However, the design stress limits may not exceed 25 percent of the stress for 0 temper at the maximum design temperature of the cargo tank, as specified in the Aluminum Association’s “Aluminum Standards and Data” (IBR, see §171.7 of this subchapter).

B14 Each bulk packaging, except a tank car or a multi-unit-tank car tank, must be insulated with an insulating material so that the overall thermal conductance at 15.5 °C (60 °F) is no more than 1.5333 kilojoules per hour per square meter per degree Celsius (0.075 Btu per hour per square foot per degree Fahrenheit) temperature differential. Insulating materials must not promote corrosion to steel when wet.

B15 Packagings must be protected with non-metallic linings impervious to the lading or have a suitable corrosion allowance.

B16 The lading must be completely covered with nitrogen, inert gas or other inert materials.

B18 Open steel hoppers or bins are authorized.

B23 Tanks must be made of steel that is rubber lined or unlined. Unlined tanks must be passivated before being placed in service. If unlined tanks are washed out with water, they must be repassivated prior to return to service. Lading in unlined tanks must be inhibited so that the corrosive effect on steel is not greater than

§ 172.102

49 CFR Ch. I (10–1–14 Edition)

that of hydrofluoric acid of 65 percent concentration.

B25 Packagings must be made from monel or nickel or monel-lined or nickel-lined steel.

B26 Tanks must be insulated. Insulation must be at least 100 mm (3.9 inches) except that the insulation thickness may be reduced to 51 mm (2 inches) over the exterior heater coils. Interior heating coils are not authorized. The packaging may not be loaded with a material outside of the packaging's design temperature range. In addition, the material also must be covered with an inert gas or the container must be filled with water to the tank's capacity. After unloading, the residual material also must be covered with an inert gas or the container must be filled with water to the tank's capacity.

B27 Tanks must have a service pressure of 1,034 kPa (150 psig). Tank car tanks must have a test pressure rating of 1,379 kPa (200 psig). Lading must be blanketed at all times with a dry inert gas at a pressure not to exceed 103 kPa (15 psig).

B28 Packagings must be made of stainless steel.

B30 MC 312, MC 330, MC 331 and DOT 412 cargo tanks and DOT 51 portable tanks must be made of stainless steel, except that steel other than stainless steel may be used in accordance with the provisions of §173.24b(b) of this subchapter. Thickness of stainless steel for tank shell and heads for cargo tanks and portable tanks must be the greater of 7.62 mm (0.300 inch) or the thickness required for a tank with a design pressure at least equal to 1.5 times the vapor pressure of the lading at 46 °C (115 °F). In addition, MC 312 and DOT 412 cargo tank motor vehicles must:

- a. Be ASME Code (U) stamped for 100% radiography of all pressure-retaining welds;
- b. Have accident damage protection which conforms with §178.345-8 of this subchapter;
- c. Have a MAWP or design pressure of at least 87 psig; and
- d. Have a bolted manway cover.

B32 MC 312, MC 330, MC 331, DOT 412 cargo tanks and DOT 51 portable tanks must be made of stainless steel, except that steel other than stainless steel may be used in accordance with the provisions of §173.24b(b) of this subchapter. Thickness of stainless steel for tank shell and heads for cargo tanks and portable tanks must be the greater of 6.35 mm (0.250 inch) or the thickness required for a tank with a design pressure at least equal to 1.3 times the vapor pressure of the lading at 46 °C (115 °F). In addition, MC 312 and DOT 412 cargo tank motor vehicles must:

- a. Be ASME Code (U) stamped for 100% radiography of all pressure-retaining welds;

b. Have accident damage protection which conforms with §178.345-8 of this subchapter;

c. Have a MAWP or design pressure of at least 87 psig; and

d. Have a bolted manway cover.

B33 MC 300, MC 301, MC 302, MC 303, MC 305, MC 306, and DOT 406 cargo tanks equipped with a 1 psig normal vent used to transport gasoline must conform to Table I of this Special Provision. Based on the volatility class determined by using ASTM D 439 and the Reid vapor pressure (RVP) of the particular gasoline, the maximum lading pressure and maximum ambient temperature permitted during the loading of gasoline may not exceed that listed in Table I.

TABLE I—MAXIMUM AMBIENT TEMPERATURE—GASOLINE

ASTM D439 volatility class	Maximum lading and ambient temperature (see note 1)
A (RVP<=9.0 psia)	131 °F
B (RVP<=10.0 psia)	124 °F
C (RVP<=11.5 psia)	116 °F
D (RVP<=13.5 psia)	107 °F
E (RVP<=15.0 psia)	100 °F

NOTE 1: Based on maximum lading pressure of 1 psig at top of cargo tank.

B35 Tank cars containing hydrogen cyanide may be alternatively marked "Hydrocyanic acid, liquefied" if otherwise conforming to marking requirements in subpart D of this part. Tank cars marked "HYDROCYANIC ACID" prior to October 1, 1991 do not need to be remarked.

B42 Tank cars constructed before March 16, 2009, must have a test pressure of 34.47 Bar (500 psig) or greater and conform to Class 105J. Each tank car must have a reclosing pressure relief device having a start-to-discharge pressure of 10.34 Bar (150 psig). The tank car specification may be marked to indicate a test pressure of 13.79 Bar (200 psig).

B44 All parts of valves and safety relief devices in contact with lading must be of a material which will not cause formation of acetylides.

B45 Each tank must have a reclosing combination pressure relief device equipped with stainless steel or platinum rupture discs approved by the AAR Tank Car Committee.

B46 The detachable protective housing for the loading and unloading valves of multi-unit tank car tanks must withstand tank test pressure and must be approved by the Associate Administrator.

- B47 Each tank may have a reclosing pressure relief device having a start-to-discharge pressure setting of 310 kPa (45 psig).
- B48 Portable tanks in sodium metal service may be visually inspected at least once every 5 years instead of being retested hydrostatically. Date of the visual inspection must be stenciled on the tank near the other required markings.
- B49 Tanks equipped with interior heater coils are not authorized. Single unit tank car tanks must have a reclosing pressure relief device having a start-to-discharge pressure set at no more than 1551 kPa (225 psig).
- B52 Notwithstanding the provisions of §173.24b of this subchapter, non-reclosing pressure relief devices are authorized on DOT 57 portable tanks.
- B53 Packagings must be made of either aluminum or steel.
- B54 Open-top, sift-proof rail cars are also authorized.
- B55 Water-tight, sift-proof, closed-top, metal-covered hopper cars, equipped with a venting arrangement (including flame arrestors) approved by the Associate Administrator are also authorized.
- B56 Water-tight, sift-proof, closed-top, metal-covered hopper cars are also authorized if the particle size of the hazardous material is not less than 149 microns.
- B57 Class 115A tank car tanks used to transport chloroprene must be equipped with a non-reclosing pressure relief device of a diameter not less than 305 mm (12 inches) with a maximum rupture disc pressure of 310 kPa (45 psig).
- B59 Water-tight, sift-proof, closed-top, metal-covered hopper cars are also authorized provided that the lading is covered with a nitrogen blanket.
- B61 Written procedures covering details of tank car appurtenances, dome fittings, safety devices, and marking, loading, handling, inspection, and testing practices must be approved by the Associate Administrator before any single unit tank car tank is offered for transportation.
- B65 Tank cars constructed before March 16, 2009, must have a test pressure of 34.47 Bar (500 psig) or greater and conform to Class 105A. Each tank car must have a reclosing pressure relief device having a start-to-discharge pressure of 15.51 Bar (225 psig). The tank car specification may be marked to indicate a test pressure of 20.68 Bar (300 psig).
- B66 Each tank must be equipped with gas tight valve protection caps. Outage must be sufficient to prevent tanks from becoming liquid full at 55 °C (130 °F). Specification 110A500W tanks must be stainless steel.
- B67 All valves and fittings must be protected by a securely attached cover made of metal not subject to deterioration by the lading, and all valve openings, except safety valve, must be fitted with screw plugs or caps to prevent leakage in the event of valve failure.
- B68 Sodium must be in a molten condition when loaded and allowed to solidify before shipment. Outage must be at least 5 percent at 98 °C (208 °F). Bulk packagings must have exterior heating coils fusion welded to the tank shell which have been properly stress relieved. The only tank car tanks authorized are Class DOT 105 tank cars having a test pressure of 2,069 kPa (300 psig) or greater.
- B69 Dry sodium cyanide or potassium cyanide may be shipped in the following sift-proof and weather-resistant packagings: metal covered hopper cars, covered motor vehicles, portable tanks, or non-specification bins.
- B70 If DOT 103ANW tank car tank is used: All cast metal in contact with the lading must have 96.7 percent nickel content; and the lading must be anhydrous and free from any impurities.
- B76 Tank cars constructed before March 16, 2009, must have a test pressure of 20.68 Bar (300 psig) or greater and conform to Class 105S, 112J, 114J or 120S. Each tank car must have a reclosing pressure relief device having a start-to-discharge pressure of 10.34 Bar (150 psig). The tank car specification may be marked to indicate a test pressure of 13.79 Bar (200 psig).
- B77 Other packaging are authorized when approved by the Associate Administrator.
- B78 Tank cars must have a test pressure of 4.14 Bar (60 psig) or greater and conform to Class 103, 104, 105, 109, 111, 112, 114 or 120. Heater pipes must be of welded construction designed for a test pressure of 500 psig. A 25 mm (1 inch) woven lining of asbestos or other approved material must be placed between the bolster slabbing and the bottom of the tank. If a tank car tank is equipped with a non-reclosing pressure relief device, the rupture disc must be perforated with a 3.2 mm (0.13 inch) diameter hole. If a tank car tank is equipped with a reclosing pressure relief valve, the tank must also be equipped with a vacuum relief valve.
- B80 Each cargo tank must have a minimum design pressure of 276 kPa (40 psig).
- B81 Venting and pressure relief devices for tank car tanks and cargo tanks must be approved by the Associate Administrator.
- B82 Cargo tanks and portable tanks are not authorized.
- B83 Bottom outlets are prohibited on tank car tanks transporting sulfuric acid in concentrations over 65.25 percent.
- B84 Packagings must be protected with non-metallic linings impervious to the lading or have a suitable corrosion allowance for sulfuric acid or spent sulfuric acid in concentration up to 65.25 percent.

- B85 Cargo tanks must be marked with the name of the lading in accordance with the requirements of §172.302(b).
- B90 Steel tanks conforming or equivalent to ASME specifications which contain solid or semisolid residual motor fuel anti-knock mixture (including rust, scale, or other contaminants) may be shipped by rail freight or highway. The tank must have been designed and constructed to be capable of withstanding full vacuum. All openings must be closed with gasketed blank flanges or vapor tight threaded closures.
- B115 Rail cars, highway trailers, roll-on/roll-off bins, or other non-specification bulk packagings are authorized. Packagings must be sift-proof, prevent liquid water from reaching the hazardous material, and be provided with sufficient venting to preclude dangerous accumulation of flammable, corrosive, or toxic gaseous emissions such as methane, hydrogen, and ammonia. The material must be loaded dry.
- B116 The use of non specification, sift-proof dump or hopper type vehicles, and sift-proof roll-on/roll-off bulk bins, which must be covered by a tarpaulin, metal cover, or equivalent means is authorized for the transportation of spent bleaching earth by motor vehicle. The material is also be subject to operational controls which include not exceeding a temperature of 55C (130F) at the time it is offered or during transportation, not exceeding a transportation time of 24 hours, and drivers transporting spent bleaching earth must be trained in the properties and hazards of the spent bleaching earth. This training must be documented in training records required by §172.704(d).

B120 The use of flexible bulk containers conforming to the requirements in subpart R and subpart S of part 178 of this subchapter is permitted.

(4) *IB Codes and IP Codes.* These provisions apply only to transportation in IBCs and Large Packagings. Table 1 authorizes IBCs for specific proper shipping names through the use of IB Codes assigned in the §172.101 table of this subchapter. Table 2 defines IP Codes on the use of IBCs that are assigned to specific commodities in the §172.101 Table of this subchapter. Table 3 authorizes Large Packagings for specific proper shipping names through the use of IB Codes assigned in the §172.101 table of this subchapter. Large Packagings are authorized for the Packing Group III entries of specific proper shipping names when either Special Provision IB3 or IB8 is assigned to that entry in the §172.101 Table. When no IB code is assigned in the §172.101 Table for a specific proper shipping name, or in §173.225(e) Organic Peroxide Table for Type F organic peroxides, use of an IBC or Large Packaging for the material may be authorized when approved by the Associate Administrator. The letter “Z” shown in the marking code for composite IBCs must be replaced with a capital code letter designation found in §178.702(a)(2) of this subchapter to specify the material used for the other packaging. Tables 1, 2, and 3 follow:

TABLE 1—IB CODES (IBC CODES)

IBC code	Authorized IBCs
IB1	<i>Authorized IBCs:</i> Metal (31A, 31B and 31N). <i>Additional Requirement:</i> Only liquids with a vapor pressure less than or equal to 110 kPa at 50 °C (1.1 bar at 122 °F), or 130 kPa at 55 °C (1.3 bar at 131 °F) are authorized.
IB2	<i>Authorized IBCs:</i> Metal (31A, 31B and 31N); Rigid plastics (31H1 and 31H2); Composite (31HZ1). <i>Additional Requirement:</i> Only liquids with a vapor pressure less than or equal to 110 kPa at 50 °C (1.1 bar at 122 °F), or 130 kPa at 55 °C (1.3 bar at 131 °F) are authorized.
IB3	<i>Authorized IBCs:</i> Metal (31A, 31B and 31N); Rigid plastics (31H1 and 31H2); Composite (31HZ1 and 31HA2, 31HB2, 31HN2, 31HD2 and 31HH2). <i>Additional Requirement:</i> Only liquids with a vapor pressure less than or equal to 110 kPa at 50 °C (1.1 bar at 122 °F), or 130 kPa at 55 °C (1.3 bar at 131 °F) are authorized, except for UN2672 (also see Special provision IP8 in Table 2 for UN2672).
IB4	<i>Authorized IBCs:</i> Metal (11A, 11B, 11N, 21A, 21B and 21N).
IB5	<i>Authorized IBCs:</i> Metal (11A, 11B, 11N, 21A, 21B and 21N); Rigid plastics (11H1, 11H2, 21H1, and 21H2); Composite (11HZ1 and 21HZ1).
IB6	<i>Authorized IBCs:</i> Metal (11A, 11B, 11N, 21A, 21B and 21N); Rigid plastics (11H1, 11H2, 21H1, and 21H2); Composite (11HZ1, 11HZ2, 21HZ1, and 21HZ2). <i>Additional Requirement:</i> Composite IBCs 11HZ2 and 21HZ2 may not be used when the hazardous materials being transported may become liquid during transport.
IB7	<i>Authorized IBCs:</i> Metal (11A, 11B, 11N, 21A, 21B and 21N); Rigid plastics (11H1, 11H2, 21H1, and 21H2); Composite (11HZ1, 11HZ2, 21HZ1, and 21HZ2); Wooden (11C, 11D and 11F). <i>Additional Requirement:</i> Liners of wooden IBCs must be sift-proof.

TABLE 1—IB CODES (IBC CODES)—Continued

IBC code	Authorized IBCs
IB8	<i>Authorized IBCs:</i> Metal (11A, 11B, 11N, 21A, 21B and 21N); Rigid plastics (11H1, 11H2, 21H1, and 21H2); Composite (11HZ1, 11HZ2, 21HZ1, and 21HZ2); Fiberboard (11G); Wooden (11C, 11D and 11F); Flexible (13H1, 13H2, 13H3, 13H4, 13H5, 13L1, 13L2, 13L3, 13L4, 13M1 or 13M2).
IB9	IBCs are only authorized if approved by the Associate Administrator.

TABLE 2—IP CODES

IP Code	h
IP1	IBCs must be packed in closed freight containers or a closed transport vehicle.
IP2	When IBCs other than metal or rigid plastics IBCs are used, they must be offered for transportation in a closed freight container or a closed transport vehicle.
IP3	Flexible IBCs must be sift-proof and water-resistant or must be fitted with a sift-proof and water-resistant liner.
IP4	Flexible, fiberboard or wooden IBCs must be sift-proof and water-resistant or be fitted with a sift-proof and water-resistant liner.
IP5	IBCs must have a device to allow venting. The inlet to the venting device must be located in the vapor space of the IBC under maximum filling conditions.
IP6	Non-specification bulk bins are authorized.
IP7	For UN identification numbers 1327, 1363, 1364, 1365, 1386, 1841, 2211, 2217, 2793 and 3314, IBCs are not required to meet the IBC performance tests specified in part 178, subpart N of this subchapter.
IP8	Ammonia solutions may be transported in rigid or composite plastic IBCs (31H1, 31H2 and 31HZ1) that have successfully passed, without leakage or permanent deformation, the hydrostatic test specified in § 178.814 of this subchapter at a test pressure that is not less than 1.5 times the vapor pressure of the contents at 55 °C (131 °F).
IP13	Transportation by vessel in IBCs is prohibited.
IP14	Air must be eliminated from the vapor space by nitrogen or other means.
IP15	For UN2031 with more than 55% nitric acid, rigid plastic IBCs and composite IBCs with a rigid plastic inner receptacle are authorized for two years from the date of IBC manufacture.
IP20	Dry sodium cyanide or potassium cyanide is also permitted in siftproof, water-resistant, fiberboard IBCs when transported in closed freight containers or transport vehicles.

TABLE 3—IB CODES

[Large packaging authorizations]

IB3	Authorized Large Packagings (LIQUIDS) (PG III materials only) ²
Inner packagings: Glass 10 liter. Plastics 30 liter. Metal 40 liter.	Large outer packagings: steel (50A). aluminum (50B). metal other than steel or aluminum (50N). rigid plastics (50H). natural wood (50C). plywood (50D). reconstituted wood (50F). rigid fiberboard (50G).
IB8	Authorized Large Packagings (SOLIDS) (PG III materials only) ²
Inner packagings: Glass 10 kg	Large outer packagings: steel (50A). aluminum (50B). metal other than steel or aluminum (50N). flexible plastics (51H). ¹ rigid plastics (50H). natural wood (50C). plywood (50D). reconstituted wood (50F). rigid fiberboard (50G).

¹ Flexible plastic (51H) Large Packagings are only authorized for use with flexible inner packagings.

² Except when authorized under Special Provision 41.

§ 172.102

49 CFR Ch. I (10–1–14 Edition)

(5) “N” codes. These provisions apply only to non-bulk packagings:

Code/Special Provisions

N3 Glass inner packagings are permitted in combination or composite packagings only if the hazardous material is free from hydrofluoric acid.

N4 For combination or composite packagings, glass inner packagings, other than ampoules, are not permitted.

N5 Glass materials of construction are not authorized for any part of a packaging which is normally in contact with the hazardous material.

N6 Battery fluid packaged with electric storage batteries, wet or dry, must conform to the packaging provisions of §173.159 (g) or (h) of this subchapter.

N7 The hazard class or division number of the material must be marked on the package in accordance with §172.302 of this subchapter. However, the hazard label corresponding to the hazard class or division may be substituted for the marking.

N8 Nitroglycerin solution in alcohol may be transported under this entry only when the solution is packed in metal cans of not more than 1 L capacity each, overpacked in a wooden box containing not more than 5 L. Metal cans must be completely surrounded with absorbent cushioning material. Wooden boxes must be completely lined with a suitable material impervious to water and nitroglycerin.

N11 This material is excepted for the specification packaging requirements of this subchapter if the material is packaged in strong, tight non-bulk packaging meeting the requirements of subparts A and B of part 173 of this subchapter.

N12 Plastic packagings are not authorized.

N20 A 5M1 multi-wall paper bag is authorized if transported in a closed transport vehicle.

N25 Steel single packagings are not authorized.

N32 Aluminum materials of construction are not authorized for single packagings.

N33 Aluminum drums are not authorized.

N34 Aluminum construction materials are not authorized for any part of a packaging which is normally in contact with the hazardous material.

N36 Aluminum or aluminum alloy construction materials are permitted only for halogenated hydrocarbons that will not react with aluminum.

N37 This material may be shipped in an integrally-lined fiber drum (1G) which meets the general packaging requirements of subpart B of part 173 of this subchapter, the requirements of part 178 of this subchapter at the packing group assigned for the material and to any other special provisions of column 7 of the §172.101 table.

N40 This material is not authorized in the following packagings:

a. A combination packaging consisting of a 4G fiberboard box with inner receptacles of glass or earthenware;

b. A single packaging of a 4C2 sift-proof, natural wood box; or

c. A composite packaging 6PG2 (glass, porcelain or stoneware receptacles within a fiberboard box).

N41 Metal construction materials are not authorized for any part of a packaging which is normally in contact with the hazardous material.

N42 1A1 drums made of carbon steel with thickness of body and heads of not less than 1.3 mm (0.050 inch) and with a corrosion-resistant phenolic lining are authorized for stabilized benzyl chloride if tested and certified to the Packing Group I performance level at a specific gravity of not less than 1.8.

N43 Metal drums are permitted as single packagings only if constructed of nickel or monel.

N45 Copper cartridges are authorized as inner packagings if the hazardous material is not in dispersion.

N65 Outage must be sufficient to prevent cylinders or spheres from becoming liquid full at 55 °C (130 °F). The vacant space (outage) may be charged with a nonflammable nonliquefied compressed gas if the pressure in the cylinder or sphere at 55 °C (130 °F) does not exceed 125 percent of the marked service pressure.

N73 Packagings consisting of outer wooden or fiberboard boxes with inner glass, metal or other strong containers; metal or fiber drums; kegs or barrels; or strong metal cans are authorized and need not conform to the requirements of part 178 of this subchapter.

N74 Packages consisting of tightly closed inner containers of glass, earthenware, metal or polyethylene, capacity not over 0.5 kg (1.1 pounds) securely cushioned and packed in outer wooden barrels or wooden or fiberboard boxes, not over 15 kg (33 pounds) net weight, are authorized and need not conform to the requirements of part 178 of this subchapter.

N75 Packages consisting of tightly closed inner packagings of glass, earthenware or metal, securely cushioned and packed in outer wooden barrels or wooden or fiberboard boxes, capacity not over 2.5 kg (5.5 pounds) net weight, are authorized and need not conform to the requirements of part 178 of this subchapter.

N76 For materials of not more than 25 percent active ingredient by weight, packages consisting of inner metal packagings not greater than 250 mL (8 ounces) capacity each, packed in strong outer packagings

together with sufficient absorbent material to completely absorb the liquid contents are authorized and need not conform to the requirements of part 178 of this subchapter.

- N77 For materials of not more than two percent active ingredients by weight, packagings need not conform to the requirements of part 178 of this subchapter, if liquid contents are absorbed in an inert material.
- N78 Packages consisting of inner glass, earthenware, or polyethylene or other non-fragile plastic bottles or jars not over 0.5 kg (1.1 pounds) capacity each, or metal cans not over five pounds capacity each, packed in outer wooden boxes, barrels or kegs, or fiberboard boxes are authorized and need not conform to the requirements of part 178 of this subchapter. Net weight of contents in fiberboard boxes may not exceed 29 kg (64 pounds). Net weight of contents in wooden boxes, barrels or kegs may not exceed 45 kg (99 pounds).
- N79 Packages consisting of tightly closed metal inner packagings not over 0.5 kg (1.1 pounds) capacity each, packed in outer wooden or fiberboard boxes, or wooden barrels, are authorized and need not conform to the requirements of part 178 of this subchapter. Net weight of contents may not exceed 15 kg (33 pounds).
- N80 Packages consisting of one inner metal can, not over 2.5 kg (5.5 pounds) capacity, packed in an outer wooden or fiberboard box, or a wooden barrel, are authorized and need not conform to the requirements of part 178 of this subchapter.
- N82 See §173.115 of this subchapter for classification criteria for flammable aerosols.
- N83 This material may not be transported in quantities of more than 11.5 kg (25.4 lbs) per package.
- N84 The maximum quantity per package is 500 g (1.1 lbs.).
- N85 Packagings certified at the Packing Group I performance level may not be used.
- N86 UN pressure receptacles made of aluminum alloy are not authorized.
- N87 The use of copper valves on UN pressure receptacles is prohibited.
- N88 Any metal part of a UN pressure receptacle in contact with the contents may not contain more than 65% copper, with a tolerance of 1%.
- N89 When steel UN pressure receptacles are used, only those bearing the "H" mark are authorized.
- N90 Metal packagings are not authorized.
- N91 The use of a non specification sift-proof, non-bulk, metal can with or without lid, or a non specification sift-proof, non-bulk fiber drum, with or without lid is authorized when transporting coal tar pitch compounds by motor vehicle or rail freight. The fiber drum must to be fab-

ricated with a three ply wall, as a minimum. The coal tar pitch compound must be in a solid mass during transportation.

(6) "R" codes. These provisions apply only to transportation by rail.

R1 A person who offers for transportation tank cars containing sulfur, molten or residue of sulfur, molten may reference the Sulfur Institute's, "Molten Sulphur Rail Tank Car Guidance document" (see §171.7 of this subchapter) to identify tank cars that may pose a risk in transportation due to the accumulation of formed, solid sulfur on the outside of the tank.

(7) "T" codes. (i) These provisions apply to the transportation of hazardous materials in UN portable tanks. Portable tank instructions specify the requirements applicable to a portable tank when used for the transportation of a specific hazardous material. These requirements must be met in addition to the design and construction specifications in part 178 of this subchapter. Portable tank instructions T1 through T22 specify the applicable minimum test pressure, the minimum shell thickness (in reference steel), bottom opening requirements and pressure relief requirements. Liquefied compressed gases are assigned to portable tank instruction T50. Refrigerated liquefied gases that are authorized to be transported in portable tanks are specified in tank instruction T75.

(ii) The following table specifies the portable tank requirements applicable to "T" Codes T1 through T22. Column 1 specifies the "T" Code. Column 2 specifies the minimum test pressure, in bar (1 bar = 14.5 psig), at which the periodic hydrostatic testing required by §180.605 of this subchapter must be conducted. Column 3 specifies the section reference for minimum shell thickness or, alternatively, the minimum shell thickness value. Column 4 specifies the applicability of §178.275(g)(3) of this subchapter for the pressure relief devices. When the word "Normal" is indicated, §178.275(g)(3) of this subchapter does not apply. Column 5 references applicable requirements for bottom openings in part 178 of this subchapter. "Prohibited" means bottom openings

§ 172.102

49 CFR Ch. I (10–1–14 Edition)

are prohibited, and “Prohibited for liquids” means bottom openings are authorized for solid material only. The table follows:

TABLE OF PORTABLE TANK T CODES T1–T22

[Portable tank codes T1–T22 apply to liquid and solid hazardous materials of Classes 3 through 9 which are transported in portable tanks.]

Portable tank instruction (1)	Minimum test pressure (bar) (2)	Minimum shell thickness (in mm-reference steel) (See § 178.274(d)) (3)	Pressure-relief requirements (See § 178.275(g)) (4)	Bottom opening requirements (See § 178.275(d)) (5)
T1	1.5	§ 178.274(d)(2)	Normal	§ 178.275(d)(2)
T2	1.5	§ 178.274(d)(2)	Normal	§ 178.275(d)(3)
T3	2.65	§ 178.274(d)(2)	Normal	§ 178.275(d)(2)
T4	2.65	§ 178.274(d)(2)	Normal	§ 178.275(d)(3)
T5	2.65	§ 178.274(d)(2)	§ 178.275(g)(3)	Prohibited
T6	4	§ 178.274(d)(2)	Normal	§ 178.275(d)(2)
T7	4	§ 178.274(d)(2)	Normal	§ 178.275(d)(3)
T8	4	§ 178.274(d)(2)	Normal	Prohibited
T9	4	6 mm	Normal	Prohibited for liquids.
T10	4	6 mm	§ 178.275(g)(3)	Prohibited
T11	6	§ 178.274(d)(2)	Normal	§ 178.275(d)(3)
T12	6	§ 178.274(d)(2)	§ 178.275(g)(3)	§ 178.275(d)(3)
T13	6	6 mm	Normal	Prohibited
T14	6	6 mm	§ 178.275(g)(3)	Prohibited
T15	10	§ 178.274(d)(2)	Normal	§ 178.275(d)(3)
T16	10	§ 178.274(d)(2)	§ 178.275(g)(3)	§ 178.275(d)(3)
T17	10	6 mm	Normal	§ 178.275(d)(3)
T18	10	6 mm	§ 178.275(g)(3)	§ 178.275(d)(3)
T19	10	6 mm	§ 178.275(g)(3)	Prohibited
T20	10	8 mm	§ 178.275(g)(3)	Prohibited
T21	10	10 mm	Normal	Prohibited for liquids.
T22	10	10 mm	§ 178.275(g)(3)	§ 178.275(d)(2). Prohibited

(iii) T50 When portable tank instruction T50 is indicated in Column (7) of the §172.101 Hazardous Materials Table, the applicable liquefied compressed gas and chemical under pressure descriptions are authorized to be transported in portable tanks in accordance with the requirements of §173.313 of this subchapter.

(iv) T75. When portable tank instruction T75 is referenced in Column (7) of the §172.101 Table, the applicable refrigerated liquefied gases are authorized to be transported in portable tanks in accordance with the requirements of §178.277 of this subchapter.

(v) UN and IM portable tank codes/special provisions. When a specific portable tank instruction is specified by a “T” Code in Column (7) of the §172.101 Table for a specific hazardous material, a specification portable tank conforming to an alternative tank instruction may be used if:

(A) The alternative portable tank has a higher or equivalent test pressure (for example, 4 bar when 2.65 bar is specified);

(B) The alternative portable tank has greater or equivalent wall thickness (for example, 10 mm when 6 mm is specified);

(C) The alternative portable tank has a pressure relief device as specified in the “T” Code. If a frangible disc is required in series with the reclosing pressure relief device for the specified portable tank, the alternative portable tank must be fitted with a frangible disc in series with the reclosing pressure relief device; and

(D) With regard to bottom openings—

(1) When two effective means are specified, the alternative portable tank is fitted with bottom openings having two or three effective means of closure or no bottom openings; or

(2) When three effective means are specified, the portable tank has no bottom openings or three effective means of closure; or

(3) When no bottom openings are authorized, the alternative portable tank must not have bottom openings.

(vi) Except when an organic peroxide is authorized under §173.225(g), if a hazardous material is not assigned a portable tank "T" Code, the hazardous material may not be transported in a portable tank unless approved by the Associate Administrator.

(8) "TP" codes. (i) These provisions apply to the transportation of hazardous materials in IM and UN Specification portable tanks. Portable tank special provisions are assigned to certain hazardous materials to specify requirements that are in addition to those provided by the portable tank instructions or the requirements in part 178 of this subchapter. Portable tank special provisions are designated with the abbreviation TP (tank provision) and are assigned to specific hazardous materials in Column (7) of the §172.101 Table.

(ii) The following is a list of the portable tank special provisions:

Code/Special Provisions

TP1 The maximum degree of filling must not exceed the degree of filling determined by the following:

$$\left(\text{Degree of filling} = \frac{97}{1 + \alpha(t_r - t_f)} \right).$$

Where:

t_r is the maximum mean bulk temperature during transport, and t_f is the temperature in degrees celsius of the liquid during filling.

TP2 a. The maximum degree of filling must not exceed the degree of filling determined by the following:

$$\left(\text{Degree of filling} = \frac{95}{1 + \alpha(t_r - t_f)} \right).$$

Where:

t_r is the maximum mean bulk temperature during transport,

t_f is the temperature in degrees celsius of the liquid during filling, and

α is the mean coefficient of cubical expansion of the liquid between the mean temperature of the liquid during filling (t_r) and the maximum mean bulk temperature during transportation (t_r) both in degrees celsius.

b. For liquids transported under ambient conditions α may be calculated using the formula:

$$\alpha = \frac{d_{15} - d_{50}}{35 d_{50}}$$

Where:

d_{15} and d_{50} are the densities (in units of mass per unit volume) of the liquid at 15 °C (59 °F) and 50 °C (122 °F), respectively.

TP3 The maximum degree of filling (in %) for solids transported above their melting points and for elevated temperature liquids shall be determined by the following:

$$\left(\text{Degree of filling} = 95 \frac{d_r}{d_f} \right).$$

Where: d_r and d_f are the mean densities of the liquid at the mean temperature of the liquid during filling and the maximum mean bulk temperature during transport respectively.

TP4 The maximum degree of filling for portable tanks must not exceed 90%.

TP5 For a portable tank used for the transport of flammable refrigerated liquefied gases or refrigerated liquefied oxygen, the maximum rate at which the portable tank may be filled must not exceed the liquid flow capacity of the primary pressure relief system rated at a pressure not exceeding 120 percent of the portable tank's design pressure. For portable tanks used for the transport of refrigerated liquefied helium and refrigerated liquefied atmospheric gas (except oxygen), the maximum rate at which the tank is filled must not exceed the liquid flow capacity of the pressure relief device rated at 130 percent of the portable tank's design pressure. Except for a portable tank containing refrigerated liquefied helium, a portable tank shall have an outage of at least two percent below the inlet of the pressure relief device or pressure control valve, under conditions of incipient opening, with the portable tank in a level attitude. No outage is required for helium.

TP6 The tank must be equipped with a pressure release device which prevent a tank from bursting under fire engulfment conditions (the conditions prescribed in CGA pamphlet S-1.2 (see §171.7 of this subchapter) or alternative conditions approved by the Associate Administrator may be used to consider the fire engulfment condition), taking into account the properties of the hazardous material to be transported.

TP7 The vapor space must be purged of air by nitrogen or other means.

TP8 A portable tank having a minimum test pressure of 1.5 bar (150 kPa) may be used when the flash point of the hazardous material transported is greater than 0 °C (32 °F).

TP9 A hazardous material assigned to special provision TP9 in Column (7) of the §172.101 Table may only be transported in a

portable tank if approved by the Associate Administrator.

TP10 The portable tank must be fitted with a lead lining at least 5 mm (0.2 inches) thick. The lead lining must be tested annually to ensure that it is intact and functional. Another suitable lining material may be used if approved by the Associate Administrator.

TP12 This material is considered highly corrosive to steel.

TP13 Self-contained breathing apparatus must be provided when this hazardous material is transported by sea.

TP16 The portable tank must be protected against over and under pressurization which may be experienced during transportation. The means of protection must be approved by the approval agency designated to approve the portable tank in accordance with the procedures in part 107, subpart E, of this subchapter. The pressure relief device must be preceded by a frangible disk in accordance with the requirements in §178.275(g)(3) of this subchapter to prevent crystallization of the product in the pressure relief device.

TP17 Only inorganic non-combustible materials may be used for thermal insulation of the tank.

TP18 The temperature of this material must be maintained between 18 °C (64.4 °F) and 40 °C (104 °F) while in transportation. Portable tanks containing solidified methacrylic acid must not be reheated during transportation.

TP19 The calculated wall thickness must be increased by 3 mm at the time of construction. Wall thickness must be verified ultrasonically at intervals midway between periodic hydraulic tests (every 2.5 years). The portable tank must not be used if the wall thickness is less than that prescribed by the applicable T code in Column (7) of the Table for this material.

TP20 This hazardous material must only be transported in insulated tanks under a nitrogen blanket.

TP21 The wall thickness must not be less than 8 mm. Portable tanks must be hydraulically tested and internally inspected at intervals not exceeding 2.5 years.

TP22 Lubricants for portable tank fittings (for example, gaskets, shut-off valves, flanges) must be oxygen compatible.

TP24 The portable tank may be fitted with a device to prevent the build up of excess pressure due to the slow decomposition of the hazardous material being transported. The device must be in the vapor space when the tank is filled under maximum filling conditions. This device must also prevent an unacceptable amount of leakage of liquid in the case of overturning.

TP25 Sulphur trioxide 99.95% pure and above may be transported in tanks without an inhibitor provided that it is maintained

at a temperature equal to or above 32.5 °C (90.5 °F).

TP26 The heating device must be exterior to the shell. For UN 3176, this requirement only applies when the hazardous material reacts dangerously with water.

TP27 A portable tank having a minimum test pressure of 4 bar (400 kPa) may be used provided the calculated test pressure is 4 bar or less based on the MAWP of the hazardous material, as defined in §178.275 of this subchapter, where the test pressure is 1.5 times the MAWP.

TP28 A portable tank having a minimum test pressure of 2.65 bar (265 kPa) may be used provided the calculated test pressure is 2.65 bar or less based on the MAWP of the hazardous material, as defined in §178.275 of this subchapter, where the test pressure is 1.5 times the MAWP.

TP29 A portable tank having a minimum test pressure of 1.5 bar (150.0 kPa) may be used provided the calculated test pressure is 1.5 bar or less based on the MAWP of the hazardous materials, as defined in §178.275 of this subchapter, where the test pressure is 1.5 times the MAWP.

TP30 This hazardous material may only be transported in insulated tanks.

TP31 This hazardous material may only be transported in tanks in the solid state.

TP32 Portable tanks may be used subject to the following conditions:

a. Each portable tank constructed of metal must be fitted with a pressure-relief device consisting of a reclosing spring loaded type, a frangible disc or a fusible element. The set to discharge for the spring loaded pressure relief device and the burst pressure for the frangible disc, as applicable, must not be greater than 2.65 bar for portable tanks with minimum test pressures greater than 4 bar;

b. The suitability for transport in tanks must be demonstrated using test 8(d) in Test Series 8 (see UN Manual of Tests and Criteria, Part 1, Sub-section 18.7) (IBR, see §171.7 of this subchapter) or an alternative means approved by the Associate Administrator.

TP33 The portable tank instruction assigned for this substance applies for granular and powdered solids and for solids which are filled and discharged at temperatures above their melting point which are cooled and transported as a solid mass. Solid substances transported or offered for transport above their melting point are authorized for transportation in portable tanks conforming to the provisions of portable tank instruction T4 for solid substances of packing group III or T7 for solid substances of packing group II, unless a tank with more stringent requirements for minimum shell thickness, maximum allowable working pressure, pressure-relief devices or bottom outlets are assigned in which case the more stringent tank instruction and special provisions shall

apply. Filling limits must be in accordance with portable tank special provision TP3. Solids meeting the definition of an elevated temperature material must be transported in accordance with the applicable requirements of this subchapter.

TP36 For material assigned this portable tank special provision, portable tanks used to transport such material may be equipped with fusible elements in the vapor space of the portable tank.

TP37 IM portable tanks are only authorized for the shipment of hydrogen peroxide solutions in water containing 72% or less hydrogen peroxide by weight. Pressure relief devices shall be designed to prevent the entry of foreign matter, the leakage of liquid and the development of any dangerous excess pressure. In addition, the portable tank must be designed so that internal surfaces may be effectively cleaned and passivated. Each tank must be equipped with pressure relief devices conforming to the following requirements:

Concentration of hydrogen peroxide solution	Total ¹
52% or less	11
Over 52%, but not greater than 60%	22
Over 60%, but not greater than 72%	32

¹Total venting capacity in standard cubic feet hour (S.C.F.H.) per pound of hydrogen peroxide solution.

TP38 Each portable tank must be insulated with an insulating material so that the overall thermal conductance at 15.5 °C (60 °F) is no more than 1.5333 kilojoules per hour per square meter per degree Celsius (0.075 Btu per hour per square foot per degree Fahrenheit) temperature differential. Insulating materials may not promote corrosion to steel when wet.

TP39 The portable tank instruction T4 prescribed may continue to be applied until December 31, 2018.

TP40 The portable tank must not be transported when connected with spray application equipment.

TP41 The portable tank instruction T9 may continue to be applied until December 31, 2018.

TP44 Each portable tank must be made of stainless steel, except that steel other than stainless steel may be used in accordance with the provisions of §173.24b(b) of this subchapter. Thickness of stainless steel for tank shell and heads must be the greater of 7.62 mm (0.300 inch) or the thickness required for a portable tank with a design pressure at least equal to 1.5 times the vapor pressure of the hazardous material at 46 °C (115 °F).

TP45 Each portable tank must be made of stainless steel, except that steel other than stainless steel may be used in accordance with the provisions of 173.24b(b) of this subchapter. Thickness of stainless steel for portable tank shells and heads must be the greater of 6.35 mm (0.250 inch) or the thickness re-

quired for a portable tank with a design pressure at least equal to 1.3 times the vapor pressure of the hazardous material at 46 °C (115 °F).

TP46 Portable tanks in sodium metal service are not required to be hydrostatically retested.

(9) “W” codes. These provisions apply only to transportation by water:

Code/Special Provisions

W1 This substance in a non friable prill or granule form is not subject to the requirements of this subchapter when tested in accordance with the UN Manual of Test and Criteria (IBR, see §171.7 of this subchapter) and is found to not meet the definition or criteria for inclusion in Division 5.1.

W7 Vessel stowage category for uranyl nitrate hexahydrate solution is “D” as defined in §172.101(k)(4).

W8 Vessel stowage category for pyrophoric thorium metal or pyrophoric uranium metal is “D” as defined in §172.101(k)(4).

W9 When offered for transportation by water, the following Specification packagings are not authorized unless approved by the Associate Administrator: woven plastic bags, plastic film bags, textile bags, paper bags, IBCs and bulk packagings.

W10 When offered for transportation by vessel, the use of Large Packagings (see §171.8 of this subchapter) is prohibited.

W41 When offered for transportation by water, this material must be packaged in bales and be securely and tightly bound with rope, wire or similar means.

[Amdt. 172–123, 55 FR 52582, Dec. 21, 1990]

EDITORIAL NOTE: For FEDERAL REGISTER citations affecting §172.102, see the List of CFR Sections Affected, which appears in the Finding Aids section of the printed volume and at www.fdsys.gov.

Subpart C—Shipping Papers

§ 172.200 Applicability.

(a) *Description of hazardous materials required.* Except as otherwise provided in this subpart, each person who offers a hazardous material for transportation shall describe the hazardous material on the shipping paper in the manner required by this subpart.

(b) This subpart does not apply to any material, other than a hazardous substance, hazardous waste or marine pollutant, that is—

(1) Identified by the letter “A” in column 1 of the §172.101 table, except

§ 172.201

49 CFR Ch. I (10–1–14 Edition)

when the material is offered or intended for transportation by air; or

(2) Identified by the letter “W” in column 1 of the §172.101 table, except when the material is offered or intended for transportation by water; or

(3) A limited quantity package unless the material is offered for transportation by aircraft or vessel and, until December 31, 2020, a package of ORM–D material authorized by this subchapter on October 1, 2010, when offered for transportation by highway, rail or vessel.

(4) Category B infectious substances prepared in accordance with §173.199.

[Amdt. 172–29A, 41 FR 40677, Sept. 20, 1976, as amended by Amdt. 172–58, 45 FR 34697, May 22, 1980; Amdt. 172–74, 47 FR 43065, Sept. 30, 1982; Amdt. 172–112, 53 FR 17160, May 13, 1988; Amdt. 172–127, 57 FR 52938, Nov. 5, 1992; 71 FR 32258, June 2, 2006; 76 FR 3365, Jan. 19, 2011; 78 FR 1112, Jan. 7, 2013]

§ 172.201 Preparation and retention of shipping papers.

(a) *Contents.* When a description of hazardous material is required to be included on a shipping paper, that description must conform to the following requirements:

(1) When a hazardous material and a material not subject to the requirements of this subchapter are described on the same shipping paper, the hazardous material description entries required by §172.202 and those additional entries that may be required by §172.203:

(i) Must be entered first, or

(ii) Must be entered in a color that clearly contrasts with any description on the shipping paper of a material not subject to the requirements of this subchapter, except that a description on a reproduction of a shipping paper may be highlighted, rather than printed, in a contrasting color (the provisions of this paragraph apply only to the basic description required by §172.202(a)(1), (2), (3), and (4)), or

(iii) Must be identified by the entry of an “X” placed before the basic shipping description required by §172.202 in a column captioned “HM.” (The “X” may be replaced by “RQ,” if appropriate.)

(2) The required shipping description on a shipping paper and all copies of

the shipping paper used for transportation purposes must be legible and printed (manually or mechanically) in English.

(3) Unless it is specifically authorized or required in this subchapter, the required shipping description may not contain any code or abbreviation.

(4) A shipping paper may contain additional information concerning the material provided the information is not inconsistent with the required description. Unless otherwise permitted or required by this subpart, additional information must be placed after the basic description required by §172.202(a).

(5) *Electronic shipping papers.* For transportation by rail, a rail carrier may accept shipping paper information either telephonically (i.e., voice communications and facsimiles) or electronically (EDI) from an offeror of a hazardous materials shipment in accordance with the provisions in paragraphs (a)(5)(i)–(a)(5)(iv) of this section. See §171.8 for the EDI definition.

(i) When the information applicable to the consignment is provided under this requirement the information must be available to the offeror and carrier at all times during transport, and the carrier must have and maintain a printed copy of this information until delivery of the hazardous materials on the shipping paper is complete. When a paper document is produced, the data must be presented as required by this subpart.

(ii) The offeror must forward the shipping paper (record) for a loaded movement to the carrier prior to shipment unless the carrier prepares the shipping paper on behalf of the offeror. The offeror is only relieved of the duty to forward the shipping paper once the offeror has received a copy of the shipping paper from the carrier;

(iii) A carrier that generates a residue shipping paper using information from the previous loaded movement of a hazardous materials packaging must ensure the description of the hazardous material that accompanies the shipment complies with the offeror’s request; and

(iv) *Verification.* The carrier and the offeror must have a procedure by which the offeror can verify accuracy of the

transmitted hazard communication information that will accompany the shipment.

(b) [Reserved]

(c) *Continuation page.* A shipping paper may consist of more than one page, if each page is consecutively numbered and the first page bears a notation specifying the total number of pages included in the shipping paper. For example, "Page 1 of 4 pages."

(d) *Emergency response telephone number.* Except as provided in §172.604(c), a shipping paper must contain an emergency response telephone number and, if utilizing an emergency response information telephone number service provider, identify the person (by name or contract number) who has a contractual agreement with the service provider, as prescribed in subpart G of this part.

(e) *Retention and Recordkeeping.* Each person who provides a shipping paper must retain a copy of the shipping paper required by §172.200(a), or an electronic image thereof, that is accessible at or through its principal place of business and must make the shipping paper available, upon request, to an authorized official of a Federal, State, or local government agency at reasonable times and locations. For a hazardous waste, the shipping paper copy must be retained for three years after the material is accepted by the initial carrier. For all other hazardous materials, the shipping paper must be retained for two years after the material is accepted by the initial carrier. Each shipping paper copy must include the date of acceptance by the initial carrier, except that, for rail, vessel, or air shipments, the date on the shipment waybill, airbill, or bill of lading may be used in place of the date of acceptance by the initial carrier. A motor carrier (as defined in §390.5 of subchapter B of chapter III of subtitle B) using a shipping paper without change for multiple shipments of one or more hazardous materials having the same shipping name and identification number may retain a single copy of the shipping paper, instead of a copy for each shipment made, if the carrier also retains a record of each shipment made, to include shipping name, identi-

fication number, quantity transported, and date of shipment.

[Amdt. 172-29A, 41 FR 40677, Sept. 20, 1976]

EDITORIAL NOTE: For FEDERAL REGISTER citations affecting §172.201, see the List of CFR Sections Affected, which appears in the Finding Aids section of the printed volume and at www.fdsys.gov.

§ 172.202 Description of hazardous material on shipping papers.

(a) The shipping description of a hazardous material on the shipping paper must include:

(1) The identification number prescribed for the material as shown in Column (4) of the §172.101 table;

(2) The proper shipping name prescribed for the material in Column (2) of the §172.101 table;

(3) The hazard class or division number prescribed for the material, as shown in Column (3) of the §172.101 table. The subsidiary hazard class or division number is not required to be entered when a corresponding subsidiary hazard label is not required. Except for combustible liquids, the subsidiary hazard class(es) or subsidiary division number(s) must be entered in parentheses immediately following the primary hazard class or division number. In addition—

(i) The words "Class" or "Division" may be included preceding the primary and subsidiary hazard class or division numbers.

(ii) The hazard class need not be included for the entry "Combustible liquid, n.o.s."

(iii) For domestic shipments, primary and subsidiary hazard class or division names may be entered following the numerical hazard class or division, or following the basic description.

(4) The packing group in Roman numerals, as designated for the hazardous material in Column (5) of the §172.101 table. Class 1 (explosives) materials; self-reactive substances; batteries other than those containing lithium, lithium ions, or sodium; Division 5.2 materials; and entries that are not assigned a packing group (e.g., Class 7) are excepted from this requirement. The packing group may be preceded by the letters "PG" (for example, "PG II"); and

(5) Except for transportation by aircraft, the total quantity of hazardous materials covered by the description must be indicated (by mass or volume, or by activity for Class 7 materials) and must include an indication of the applicable unit of measurement, for example, “200 kg” (440 pounds) or “50 L” (13 gallons). The following provisions also apply:

(i) For Class 1 materials, the quantity must be the net explosive mass. For an explosive that is an article, such as Cartridges, small arms, the net explosive mass may be expressed in terms of the net mass of either the article or the explosive materials contained in the article.

(ii) For hazardous materials in salvage packaging, an estimate of the total quantity is acceptable.

(iii) The following are excepted from the requirements of paragraph (a)(5) of this section:

(A) Bulk packages, provided some indication of the total quantity is shown, for example, “1 cargo tank” or “2 IBCs.”

(B) Cylinders, provided some indication of the total quantity is shown, for example, “10 cylinders.”

(C) Packages containing only residue.

(6) For transportation by aircraft, the total net mass per package, must be shown unless a gross mass is indicated in Columns (9A) or (9B) of the §172.101 table in which case the total gross mass per package must be shown; or, for Class 7 materials, the quantity of radioactive material must be shown by activity. The following provisions also apply:

(i) For empty uncleaned packaging, only the number and type of packaging must be shown;

(ii) For chemical kits and first aid kits, the total net mass of hazardous materials must be shown. Where the kits contain only liquids, or solids and liquids, the net mass of liquids within the kits is to be calculated on a 1 to 1 basis, i.e., 1 L (0.3 gallons) equals 1 kg (2.2 pounds);

(iii) For dangerous goods in machinery or apparatus, the individual total quantities or an estimate of the individual total quantities of dangerous goods in solid, liquid or gaseous state, contained in the article must be shown;

(iv) For dangerous goods transported in a salvage packaging, an estimate of the quantity of dangerous goods per package must be shown;

(v) For cylinders, total quantity may be indicated by the number of cylinders, for example, “10 cylinders;”

(vi) For items where “No Limit” is shown in Column (9A) or (9B) of the §172.101 table, the quantity shown must be the net mass or volume of the material. For articles (*e.g.*, UN2800 and UN3166) the quantity must be the gross mass, followed by the letter “G”; and

(vii) For hazardous materials in limited quantities, the total net quantity per package must be shown unless a gross mass is indicated in Column 4 of §173.27 Table 3, in which case the total gross mass per package must be shown. Where different hazardous materials in limited quantities are packed together in the same outer packaging, when a gross mass is indicated Column 4 of §173.27 Table 3, the net quantity of each hazardous material must be shown in addition to the gross mass of the completed package.

(7) The number and type of packages must be indicated. The type of packages must be indicated by description of the package (for example, “12 drums”). Indication of the packaging specification number (“1H1”) may be included in the description of the package (for example, “12 1H1 drums” or “12 drums (UN 1A1)”). Abbreviations may be used for indicating packaging types (for example, “cyl.” for “cylinder”) provided the abbreviations are commonly accepted and recognizable.

(b) Except as provided in this subpart, the basic description specified in paragraphs (a)(1), (2), (3), and (4) of this section must be shown in sequence with no additional information interspersed. For example, “UN2744, Cyclobutyl chloroformate, 6.1, (8, 3), PG II.” The shipping description sequences in effect on December 31, 2006, may be used until January 1, 2013. Shipping descriptions for hazardous materials offered or intended for transportation by rail that contain all the information required in this subpart and that are formatted and ordered in accordance with recognized electronic data interchange standards and, to the

extent possible, in the order and manner required by this subpart are deemed to comply with this paragraph.

(c) The total quantity of the material covered by one description must appear before or after, or both before and after, the description required and authorized by this subpart. The type of packaging and destination marks may be entered in any appropriate manner before or after the basic description. Abbreviations may be used to express units of measurement and types of packagings.

(d) Technical and chemical group names may be entered in parentheses between the proper shipping name and hazard class or following the basic description. An appropriate modifier, such as “contains” or “containing,” and/or the percentage of the technical constituent may also be used. For example: “Flammable liquids, n.o.s. (contains Xylene and Benzene), 3, UN 1993, II”.

(e) Except for those materials in the UN Recommendations, the ICAO Technical Instructions, or the IMDG Code (IBR, see §171.7 of this subchapter), a material that is not a hazardous material according to this subchapter may not be offered for transportation or transported when its description on a shipping paper includes a hazard class or an identification number specified in the §172.101 Table.

[Amdt. 172-101, 45 FR 74665, Nov. 10, 1980]

EDITORIAL NOTE: For FEDERAL REGISTER citations affecting §172.202, see the List of CFR Sections Affected, which appears in the Finding Aids section of the printed volume and at www.fdsys.gov.

§ 172.203 Additional description requirements.

(a) *Special permits.* Except as provided in §173.23 of this subchapter, each shipping paper issued in connection with a shipment made under a special permit must bear the notation “DOT-SP” followed by the special permit number assigned and located so that the notation is clearly associated with the description to which the special permit applies. Each shipping paper issued in connection with a shipment made under an exemption or special permit issued prior to October 1, 2007, may bear the notation “DOT-E” followed by

the number assigned and so located that the notation is clearly associated with the description to which it applies.

(b) *Limited quantities.* When a shipping paper is required by this subchapter, the description for a material offered for transportation as “limited quantity,” as authorized by this subchapter, must include the words “Limited Quantity” or “Ltd Qty” following the basic description.

(c) *Hazardous substances.* (1) Except for Class 7 (radioactive) materials described in accordance with paragraph (d) of this section, if the proper shipping name for a material that is a hazardous substance does not identify the hazardous substance by name, the name of the hazardous substance must be entered in parentheses in association with the basic description. If the material contains two or more hazardous substances, at least two hazardous substances, including the two with the lowest reportable quantities (RQs), must be identified. For a hazardous waste, the waste code (e.g., D001), if appropriate, may be used to identify the hazardous substance.

(2) The letters “RQ” must be entered on the shipping paper either before or after the basic description required by §172.202 for each hazardous substance (see definition in §171.8 of this subchapter). For example: “RQ, UN 1098, Allyl alcohol, 6.1, I, Toxic-inhalation hazard, Zone B”; or “UN 3077, Environmentally hazardous substances, solid, n.o.s., 9, III, RQ (Adipic acid)”.

(d) *Radioactive material.* The description for a shipment of a Class 7 (radioactive) material must include the following additional entries as appropriate:

(1) The name of each radionuclide in the Class 7 (radioactive) material that is listed in §173.435 of this subchapter. For mixtures of radionuclides, the radionuclides required to be shown must be determined in accordance with §173.433(g) of this subchapter. Abbreviations, e.g., “⁹⁹Mo,” are authorized.

(2) A description of the physical and chemical form of the material:

(i) For special form materials, the words “special form” unless the words “special form” already appear in the proper shipping name; or

(ii) If the material is not in special form, a description of the physical and chemical form of the material (generic chemical descriptions are permitted).

(3) The maximum activity of the radioactive contents contained in each package during transport in terms of the appropriate SI units (*e.g.*, Becquerels (Bq), Terabecquerels (TBq)). The activity may also be stated in appropriate customary units (*e.g.*, Curies (Ci), milliCuries (mCi), microCuries (uCi)) in parentheses following the SI units. Abbreviations are authorized. Except for plutonium-239 and plutonium-241, the weight in grams or kilograms of fissile radionuclides (or the mass of each fissile nuclide for mixtures when appropriate) may be inserted instead of activity units. For plutonium-239 and plutonium-241, the weight in grams of fissile radionuclides (or the mass of each fissile nuclide for mixtures when appropriate) may be inserted in addition to the activity units.

(4) The category of label applied to each package in the shipment. For example: “RADIOACTIVE WHITE-I,” or “WHITE-I.”

(5) The transport index assigned to each package in the shipment bearing RADIOACTIVE YELLOW-II or RADIOACTIVE YELLOW-III labels.

(6) For a package containing fissile Class 7 (radioactive) material:

(i) The words “Fissile Excepted” if the package is excepted pursuant to §173.453 of this subchapter; or otherwise

(ii) The criticality safety index for that package.

(7) For a package approved by the U.S. Department of Energy (DOE) or U.S. Nuclear Regulatory Commission (NRC), a notation of the package identification marking as prescribed in the applicable DOE or NRC approval (see §173.471 of the subchapter).

(8) For an export shipment or a shipment in a foreign made package, a notation of the package identification marking as prescribed in the applicable International Atomic Energy Agency (IAEA) Certificate of Competent Authority which has been issued for the package (see §173.473 of the subchapter).

(9) For a shipment required by this subchapter to be consigned as exclusive use:

(i) An indication that the shipment is consigned as exclusive use; or

(ii) If all the descriptions on the shipping paper are consigned as exclusive use, then the statement “Exclusive Use Shipment” may be entered only once on the shipping paper in a clearly visible location.

(10) For the shipment of a package containing a highway route controlled quantity of Class 7 (radioactive) materials (see §173.403 of this subchapter) the words “Highway route controlled quantity” or “HRCQ” must be entered in association with the basic description.

(e) *Empty packagings.* (1) The description on the shipping paper for a packaging containing the residue of a hazardous material may include the words “RESIDUE: Last Contained * * *” immediately before or after the basic shipping description on the shipping paper.

(2) The description on the shipping paper for a tank car containing the residue of a hazardous material must include the phrase, “RESIDUE: LAST CONTAINED * * *” immediately before or after the basic shipping description or immediately preceding the proper shipping name of the material on the shipping paper.

(f) *Transportation by air.* A statement indicating that the shipment is within the limitations prescribed for either passenger and cargo aircraft or cargo aircraft only must be entered on the shipping paper.

(g) *Transportation by rail.* (1) A shipping paper prepared by a rail carrier for a rail car, freight container, transport vehicle or portable tank that contains hazardous materials must include the reporting mark and number when displayed on the rail car, freight container, transport vehicle or portable tank.

(2) The shipping paper for each DOT-113 tank car containing a Division 2.1 material or its residue must contain an appropriate notation, such as “DOT 113”, and the statement “Do not hump or cut off car while in motion.”

(3) When shipments of elevated temperature materials are transported

under the exception permitted in §173.247(h)(3) of this subchapter, the shipping paper must contain an appropriate notation, such as “Maximum operating speed 15 mph.”.

(h) *Transportation by highway.* Following the basic description for a hazardous material in a Specification MC 330 or MC 331 cargo tank, there must be entered for—

(1) *Anhydrous ammonia.* (i) The words “0.2 PERCENT WATER” to indicate the suitability for shipping anhydrous ammonia in a cargo tank made of quenched and tempered steel as authorized by §173.315(a), Note 14 of this subchapter, or

(ii) The words “NOT FOR Q and T TANKS” when the anhydrous ammonia does not contain 0.2 percent or more water by weight.

(2) *Liquefied petroleum gas.* (i) The word “NONCORROSIVE” or “NONCOR” to indicate the suitability for shipping “Noncorrosive” liquefied petroleum gas in a cargo tank made of quenched and tempered steel as authorized by §173.315(a), Note 15 of this subchapter, or

(ii) The words “NOT FOR Q and T TANKS” for grades of liquefied petroleum gas other than “Noncorrosive”.

(i) *Transportation by water.* Each shipment by water must have the following additional shipping paper entries:

(1) The name of the shipper.

(2) Minimum flashpoint if 60 °C (140 °F) or below (in °C closed cup (c.c.)) in association with the basic description. For lab packs packaged in conformance with §173.12(b) of this subchapter, an indication that the lowest flashpoint of all hazardous materials contained in the lab pack is below 23 °C or that the flash point is not less than 23 °C but not more than 60 °C must be identified on the shipping paper in lieu of the minimum flashpoint.

(3) For a hazardous material consigned under an “n.o.s.” entry not included in the segregation groups listed in section 3.1.4 of the IMDG Code (IBR see §171.7 of this subchapter) but belonging, in the opinion of the consignor, to one of these groups, the appropriate segregation group must be shown in association with the basic description (for example, IMDG Code segregation group—1 Acids). When no seg-

regation group is applicable, there is no requirement to indicate that condition.

(j) [Reserved]

(k) *Technical names for “n.o.s.” and other generic descriptions.* Unless otherwise excepted, if a material is described on a shipping paper by one of the proper shipping names identified by the letter “G” in column (1) of the §172.101 Table, the technical name of the hazardous material must be entered in parentheses in association with the basic description. For example “UN 1760, Corrosive liquid, n.o.s., (Octanoyl chloride), 8, II”, or “UN 1760, Corrosive liquid, n.o.s., 8, II (contains Octanoyl chloride)”. The word “contains” may be used in association with the technical name, if appropriate. For organic peroxides which may qualify for more than one generic listing depending on concentration, the technical name must include the actual concentration being shipped or the concentration range for the appropriate generic listing. For example, “UN 3102, Organic peroxide type B, solid, 5.2, (dibenzoyl peroxide, 52–100%)” or “UN 3108, Organic peroxide type E, solid, 5.2, (dibenzoyl peroxide, paste, <52%)”. Shipping descriptions for toxic materials that meet the criteria of Division 6.1, PG I or II (as specified in §173.132(a) of this subchapter) or Division 2.3 (as specified in §173.115(c) of this subchapter) and are identified by the letter “G” in column (1) of the §172.101 Table, must have the technical name of the toxic constituent entered in parentheses in association with the basic description. A material classed as Division 6.2 and assigned identification number UN 2814 or UN 2900 that is suspected to contain an unknown Category A infectious substance must have the words “suspected Category A infectious substance” entered in parentheses in place of the technical name as part of the proper shipping description. For additional technical name options, see the definition for “Technical name” in §171.8. A technical name should not be marked on the outer package of a Division 6.2 material (see §172.301(b)).

(1) If a hazardous material is a mixture or solution of two or more hazardous materials, the technical names

§ 172.203

49 CFR Ch. I (10–1–14 Edition)

of at least two components most predominately contributing to the hazards of the mixture or solution must be entered on the shipping paper as required by paragraph (k) of this section. For example, “UN 2924, Flammable liquid, corrosive, n.o.s., 3, II (contains Methanol, Potassium hydroxide)”.

(2) The provisions of this paragraph do not apply—

(i) To a material that is a hazardous waste and described using the proper shipping name “Hazardous waste, liquid *or* solid, n.o.s.”, classed as a miscellaneous Class 9, provided the EPA hazardous waste number is included on the shipping paper in association with the basic description, or provided the material is described in accordance with the provisions of § 172.203(c) of this part.

(ii) To a material for which the hazard class is to be determined by testing under the criteria in § 172.101(c)(11).

(iii) If the n.o.s. description for the material (other than a mixture of hazardous materials of different classes meeting the definitions of more than one hazard class) contains the name of the chemical element or group which is primarily responsible for the material being included in the hazard class indicated.

(iv) If the n.o.s. description for the material (which is a mixture of hazardous materials of different classes meeting the definition of more than one hazard class) contains the name of the chemical element or group responsible for the material meeting the definition of one of these classes. In such cases, only the technical name of the component that is not appropriately identified in the n.o.s. description shall be entered in parentheses.

(1) *Marine pollutants.* (1) If the proper shipping name for a material which is a marine pollutant does not identify by name the component which makes the material a marine pollutant, the name of that component must appear in parentheses in association with the basic description. Where two or more components which make a material a marine pollutant are present, the names of at least two of the components most predominately contributing to the marine pollutant designation must appear in

parentheses in association with the basic description.

(2) The words “Marine Pollutant” shall be entered in association with the basic description for a material which is a marine pollutant.

(3) Except for transportation by vessel, marine pollutants subject to the provisions of 49 CFR 130.11 are excepted from the requirements of paragraph (1) of this section if a phrase indicating the material is an oil is placed in association with the basic description.

(4) Except when all or part of transportation is by vessel, marine pollutants in non-bulk packagings are not subject to the requirements of paragraphs (1)(1) and (1)(2) of this section (see § 171.4 of this subchapter).

(m) *Poisonous Materials.* Notwithstanding the hazard class to which a material is assigned, for materials that are poisonous by inhalation (see § 171.8 of this subchapter), the words “Poison-Inhalation Hazard” or “Toxic-Inhalation Hazard” and the words “Zone A”, “Zone B”, “Zone C”, or “Zone D” for gases or “Zone A” or “Zone B” for liquids, as appropriate, shall be entered on the shipping paper immediately following the shipping description. The word “Poison” or “Toxic” need not be repeated if it otherwise appears in the shipping description.

(n) *Elevated temperature materials.* If a liquid material in a package meets the definition of an elevated temperature material in § 171.8 of this subchapter, and the fact that it is an elevated temperature material is not disclosed in the proper shipping name (for example, when the words “Molten” or “Elevated temperature” are part of the proper shipping name), the word “HOT” must immediately precede the proper shipping name of the material on the shipping paper.

(o) *Organic peroxides and self-reactive materials.* The description on a shipping paper for a Division 4.1 (self-reactive) material or a Division 5.2 (organic peroxide) material must include the following additional information, as appropriate:

(1) If notification or competent authority approval is required, the shipping paper must contain a statement of approval of the classification and conditions of transport.

(2) For Division 4.1 (self-reactive) and Division 5.2 (organic peroxide) materials that require temperature control during transport, the control and emergency temperature must be included on the shipping paper.

(3) The word "SAMPLE" must be included in association with the basic description when a sample of a Division 4.1 (self-reactive) material (see §173.224(c)(3) of this subchapter) or Division 5.2 (organic peroxide) material (see §173.225(b)(2) of this subchapter) is offered for transportation.

(p) *Liquefied petroleum gas (LPG)*. The word "non-odorized" or "not-odorized" must be included in association with the proper shipping description on a shipping paper when non-odorized liquefied petroleum gas is offered for transportation.

[Amdt. 172-29A, 41 FR 40677, Sept. 20, 1976]

EDITORIAL NOTE: For FEDERAL REGISTER citations affecting §172.203, see the List of CFR Sections Affected, which appears in the Finding Aids section of the printed volume and at www.fdsys.gov.

§ 172.204 Shipper's certification.

(a) *General*. Except as provided in paragraphs (b) and (c) of this section, each person who offers a hazardous material for transportation shall certify that the material is offered for transportation in accordance with this subchapter by printing (manually or mechanically) on the shipping paper containing the required shipping description the certification contained in paragraph (a)(1) of this section or the certification (declaration) containing the language contained in paragraph (a)(2) of this section. For transportation by rail only, the certification may be received verbally or with an electronic signature in conformance with paragraphs (a)(3)(i) and (a)(3)(ii) of this section.

(1) "This is to certify that the above-named materials are properly classified, described, packaged, marked and labeled, and are in proper condition for transportation according to the applicable regulations of the Department of Transportation."

NOTE: In line one of the certification the words "herein-named" may be substituted for the words "above-named".

(2) "I hereby declare that the contents of this consignment are fully and accurately described above by the proper shipping name, and are classified, packaged, marked and labeled/placarded, and are in all respects in proper condition for transport according to applicable international and national governmental regulations."

(3) *Rail only certifications*. For transportation by rail, the shipping paper certification may also be accomplished by one of the following methods:

(i) *Verbal Certification*. When received telephonically, by the carrier reading the complete shipping description that will accompany the shipment back to the offeror and receiving verbal acknowledgment that the description is as required. This verbal acknowledgment must be recorded, either on the shipping document or in a separate record, e.g., the waybill, in accordance with §174.24, and must include the date and name of the person who provided this information; or

(ii) *Electronic Signature Certification*. When transmitted electronically, by completing the field designated for the shipper's signature, the shipper is also certifying its compliance with the certification specified in §172.204(a)." The name of the principal partner, officer, or employee of the offeror or their agent must be substituted for the asterisks;

(b) *Exceptions*. (1) Except for a hazardous waste, no certification is required for a hazardous material offered for transportation by motor vehicle and transported:

(i) In a cargo tank supplied by the carrier, or

(ii) By the shipper as a private carrier except for a hazardous material that is to be reshipped or transferred from one carrier to another.

(2) No certification is required for the return of an empty tank car which previously contained a hazardous material and which has not been cleaned or purged.

(c) *Transportation by air*—(1) *General*. Certification containing the following language may be used in place of the certification required by paragraph (a) of this section:

§ 172.205

49 CFR Ch. I (10–1–14 Edition)

I hereby certify that the contents of this consignment are fully and accurately described above by proper shipping name and are classified, packaged, marked and labeled, and in proper condition for carriage by air according to applicable national governmental regulations.

NOTE TO PARAGRAPH (c)(1): In the certification, the word “packed” may be used instead of the word “packaged” until October 1, 2010.

(2) *Certificate in duplicate.* Each person who offers a hazardous material to an aircraft operator for transportation by air shall provide two copies of the certification required in this section. (See §175.30 of this subchapter.)

(3) *Additional certification requirements.* Effective October 1, 2006, each person who offers a hazardous material for transportation by air must add to the certification required in this section the following statement:

“I declare that all of the applicable air transport requirements have been met.”

(i) Each person who offers any package or overpack of hazardous materials for transport by air must ensure that:

(A) The articles or substances are not prohibited for transport by air (see the §172.101 Table);

(B) The articles or substances are properly classed, marked and labeled and otherwise in a condition for transport as required by this subchapter;

(C) The articles or substances are packaged in accordance with all the applicable air transport requirements, including appropriate types of packaging that conform to the packing requirements and the “A” Special Provisions in §172.102; inner packaging and maximum quantity per package limits; the compatibility requirements (see, for example, §173.24 of this subchapter); and requirements for closure for both inner and outer packagings, absorbent materials, and pressure differential in §173.27 of this subchapter. Other requirements may also apply. For example, single packagings may be prohibited, inner packaging may need to be packed in intermediate packagings, and certain materials may be required to be transported in packagings meeting a more stringent performance level.

(ii) [Reserved]

(4) *Radioactive material.* Each person who offers any radioactive material for transportation aboard a passenger-carrying aircraft shall sign (mechanically or manually) a printed certificate stating that the shipment contains radioactive material intended for use in, or incident to, research, or medical diagnosis or treatment.

(d) *Signature.* The certifications required by paragraph (a) or (c) of this section:

(1) Must be legibly signed by a principal, officer, partner, or employee of the shipper or his agent; and

(2) May be legibly signed manually, by typewriter, or by other mechanical means.

(3) For transportation by rail, when transmitted by telephone or electronically, the signature must be in one of the following forms: The name of the principal person, partner, officer, or employee of the offeror or his agent in a computer field defined for that purpose.

[Amdt. 172–29A, 41 FR 40677, Sept. 20, 1976]

EDITORIAL NOTE: For FEDERAL REGISTER citations affecting §172.204, see the List of CFR Sections Affected, which appears in the Finding Aids section of the printed volume and at www.fdsys.gov.

§ 172.205 Hazardous waste manifest.

(a) No person may offer, transport, transfer, or deliver a hazardous waste (waste) unless an EPA Form 8700–22 and 8700–22A (when necessary) hazardous waste manifest (manifest) is prepared in accordance with 40 CFR 262.20 and is signed, carried, and given as required of that person by this section.

(b) The shipper (generator) shall prepare the manifest in accordance with 40 CFR part 262.

(c) The original copy of the manifest must be dated by, and bear the handwritten signature of, the person representing:

(1) The shipper (generator) of the waste at the time it is offered for transportation, and

(2) The initial carrier accepting the waste for transportation.

(d) A copy of the manifest must be dated by, and bear the handwritten signature of the person representing:

(1) Each subsequent carrier accepting the waste for transportation, at the time of acceptance, and

(2) The designated facility receiving the waste, upon receipt.

(e) A copy of the manifest bearing all required dates and signatures must be:

(1) Given to a person representing each carrier accepting the waste for transportation,

(2) Carried during transportation in the same manner as required by this subchapter for shipping papers,

(3) Given to a person representing the designated facility receiving the waste,

(4) Returned to the shipper (generator) by the carrier that transported the waste from the United States to a foreign destination with a notation of the date of departure from the United States, and

(5) Retained by the shipper (generator) and by the initial and each subsequent carrier for three years from the date the waste was accepted by the initial carrier. Each retained copy must bear all required signatures and dates up to and including those entered by the next person who received the waste.

(f) *Transportation by rail.* Notwithstanding the requirements of paragraphs (d) and (e) of this section, the following requirements apply:

(1) When accepting hazardous waste from a non-rail transporter, the initial rail transporter must:

(i) Sign and date the manifest acknowledging acceptance of the hazardous waste;

(ii) Return a signed copy of the manifest to the non-rail transporter;

(iii) Forward at least three copies of the manifest to:

(A) The next non-rail transporter, if any;

(B) The designated facility, if the shipment is delivered to that facility by rail; or

(C) The last rail transporter designated to handle the waste in the United States; and

(iv) Retain one copy of the manifest and rail shipping paper in accordance with 40 CFR 263.22.

(2) Rail transporters must ensure that a shipping paper containing all the information required on the manifest (excluding the EPA identification

numbers, generator certification and signatures) and, for exports, an EPA Acknowledgment of Consent accompanies the hazardous waste at all times. Intermediate rail transporters are not required to sign either the manifest or shipping paper.

(3) When delivering hazardous waste to the designated facility, a rail transporter must:

(i) Obtain the date of delivery and handwritten signature of the owner or operator of the designated facility on the manifest or the shipping paper (if the manifest has not been received by the facility); and

(ii) Retain a copy of the manifest or signed shipping paper in accordance with 40 CFR 263.22.

(4) When delivering hazardous waste to a non-rail transporter, a rail transporter must:

(i) Obtain the date of delivery and the handwritten signature of the next non-rail transporter on the manifest; and

(ii) Retain a copy of the manifest in accordance with 40 CFR 263.22.

(5) Before accepting hazardous waste from a rail transporter, a non-rail transporter must sign and date the manifest and provide a copy to the rail transporter.

(g) The person delivering a hazardous waste to an initial rail carrier shall send a copy of the manifest, dated and signed by a representative of the rail carrier, to the person representing the designated facility.

(h) A hazardous waste manifest required by 40 CFR part 262, containing all of the information required by this subpart, may be used as the shipping paper required by this subpart.

(i) The shipping description for a hazardous waste must be modified as required by § 172.101(c)(9).

[Amdt. 172-58, 45 FR 34698, May 22, 1980, as amended by Amdt. 172-90, 49 FR 10510, Mar. 20, 1984; 49 FR 11184, Mar. 26, 1984; Amdt. 172-248, 61 FR 28675, June 5, 1996; 70 FR 34075, June 13, 2005]

Subpart D—Marking

§ 172.300 Applicability.

(a) Each person who offers a hazardous material for transportation

§ 172.301

49 CFR Ch. I (10–1–14 Edition)

shall mark each package, freight container, and transport vehicle containing the hazardous material in the manner required by this subpart.

(b) When assigned the function by this subpart, each carrier that transports a hazardous material shall mark each package, freight container, and transport vehicle containing the hazardous material in the manner required by this subpart.

(c) Unless otherwise provided in a specific rule, stocks of preprinted packagings marked in accordance with this subpart prior to the effective date of a final rule may be continued in use, in the manner previously authorized, until depleted or for a one-year period subsequent to the compliance date of the marking amendment, whichever is less.

[Amdt. 172–101, 45 FR 74666, Nov. 10, 1980, as amended at 76 FR 3365, Jan. 19, 2011]

§ 172.301 General marking requirements for non-bulk packagings.

(a) *Proper shipping name and identification number.* (1) Except as otherwise provided by this subchapter, each person who offers a hazardous material for transportation in a non-bulk packaging must mark the package with the proper shipping name and identification number (preceded by “UN”, “NA” or “ID,” as appropriate) for the material as shown in the §172.101 Hazardous Materials Table. The identification number marking preceded by “UN”, “NA”, or “ID” as appropriate must be marked in characters at least 12 mm (0.47 inches) high. Packages with a maximum capacity of 30 liters (8 gallons) or less, 30 kg (66 pounds) maximum net mass, or cylinders with a water capacity of 60 liters (16 gallons) or less must be marked with characters at least 6 mm (0.24 inches) high. Packages with a maximum capacity of 5 liters (1.32 gallons) or 5 kg (11 pounds) or less must be marked in a size appropriate for the size of the package.

(i) *Transitional exception.* For domestic transportation, until January 1, 2017, the identification number markings are not subject to the minimum size requirements specified in this paragraph (a)(1).

(ii) Exception for permanently marked packagings. For domestic

transportation, a packaging manufactured prior to January 1, 2017 and permanently marked (e.g., by embossing or through a heat stamp process) with the appropriate identification number marking may continue in service until the end of its useful life regardless of whether the identification number markings meet the minimum size requirements specified in this paragraph (a)(1).

(2) The proper shipping name for a hazardous waste (as defined in §171.8 of this subchapter) is not required to include the word “waste” if the package bears the EPA marking prescribed by 40 CFR 262.32.

(3) *Large quantities of a single hazardous material in non-bulk packages.* A transport vehicle or freight container containing only a single hazardous material in non-bulk packages must be marked, on each side and each end as specified in the §172.332 or §172.336, with the identification number specified for the hazardous material in the §172.101 Table, subject to the following provisions and limitations:

(i) Each package is marked with the same proper shipping name and identification number;

(ii) The aggregate gross weight of the hazardous material is 4,000 kg (8,820 pounds) or more;

(iii) All of the hazardous material is loaded at one loading facility;

(iv) The transport vehicle or freight container contains no other material, hazardous or otherwise; and

(v) The identification number marking requirement of this paragraph (a)(3) does not apply to Class 1, Class 7, or to non-bulk packagings for which identification numbers are not required.

(b) *Technical names.* In addition to the marking required by paragraph (a) of this section, each non-bulk packaging containing a hazardous material subject to the provisions of §172.203(k) of this part, except for a Division 6.2 material, must be marked with the technical name in parentheses in association with the proper shipping name in accordance with the requirements and exceptions specified for display of technical descriptions on shipping papers in §172.203(k) of this part. A technical name should not be marked on the

outer package of a Division 6.2 material.

(c) *Special permit packagings.* Except as provided in §173.23 of this subchapter, the outside of each package authorized by a special permit must be plainly and durably marked “DOT-SP” followed by the special permit number assigned. Packages authorized by an exemption issued prior to October 1, 2007, may be plainly and durably marked “DOT-E” in lieu of “DOT-SP” followed by the number assigned as specified in the most recent version of that exemption.

(d) *Consignee’s or consignor’s name and address.* Each person who offers for transportation a hazardous material in a non-bulk package shall mark that package with the name and address of the consignor or consignee except when the package is—

(1) Transported by highway only and will not be transferred from one motor carrier to another; or

(2) Part of a carload lot, truckload lot or freight container load, and the entire contents of the rail car, truck or freight container are shipped from one consignor to one consignee.

(e) *Previously marked packagings.* A package which has been previously marked as required for the material it contains and on which the marking remains legible, need not be remarked. (For empty packagings, see §173.29 of this subchapter.)

(f) *NON-ODORIZED marking on cylinders containing LPG.* No person may offer for transportation or transport a specification cylinder, except a Specification 2P or 2Q container or a Specification 39 cylinder, that contains an unodorized Liquefied petroleum gas (LPG) unless it is legibly marked NON-ODORIZED or NOT ODORIZED in letters not less than 6.3 mm (0.25 inches) in height near the marked proper shipping name required by paragraph (a) of this section.

[Amdt. 172-123, 55 FR 52590, Dec. 21, 1990, as amended by Amdt. 172-151, 62 FR 1227, Jan. 8, 1997; 62 FR 39404, July 22, 1997; 63 FR 16075, Apr. 1, 1998; 66 FR 45182, Aug. 28, 2001; 68 FR 45030, July 31, 2003; 69 FR 64471, Nov. 4, 2004; 70 FR 73164, Dec. 9, 2005; 71 FR 32258, June 2, 2006; 76 FR 3365, Jan. 19, 2011; 76 FR 56314, Sept. 13, 2011; 78 FR 1072, Jan. 7, 2013; 78 FR 65478, Oct. 31, 2013]

§ 172.302 General marking requirements for bulk packagings.

(a) *Identification numbers.* Except as otherwise provided in this subpart, no person may offer for transportation or transport a hazardous material in a bulk packaging unless the packaging is marked as required by §172.332 with the identification number specified for the material in the §172.101 table—

(1) On each side and each end, if the packaging has a capacity of 3,785 L (1,000 gallons) or more;

(2) On two opposing sides, if the packaging has a capacity of less than 3,785 L (1,000 gallons); or

(3) For cylinders permanently installed on a tube trailer motor vehicle, on each side and each end of the motor vehicle.

(b) *Size of markings.* Except as otherwise provided, markings required by this subpart on bulk packagings must—

(1) Have a width of at least 6.0 mm (0.24 inch) and a height of at least 100 mm (3.9 inches) for rail cars;

(2) Have a width of at least 4.0 mm (0.16 inch) and a height of at least 25 mm (one inch) for portable tanks with capacities of less than 3,785 L (1,000 gallons) and IBCs; and

(3) Have a width of at least 6.0 mm (0.24 inch) and a height of at least 50 mm (2.0 inches) for cargo tanks and other bulk packagings.

(c) *Special permit packagings.* Except as provided in §173.23 of this subchapter, the outside of each package used under the terms of a special permit must be plainly and durably marked “DOT-SP” followed by the special permit number assigned. Packages authorized by an exemption issued prior to October 1, 2007 may be plainly and durably marked “DOT-E” in lieu of “DOT-SP” followed by the number assigned as specified in the most recent version of that exemption.

(d) Each bulk packaging marked with a proper shipping name, common name or identification number as required by this subpart must remain marked when it is emptied unless it is—

(1) Sufficiently cleaned of residue and purged of vapors to remove any potential hazard; or

(2) Refilled, with a material requiring different markings or no markings, to

§ 172.303

such an extent that any residue remaining in the packaging is no longer hazardous.

(e) Additional requirements for marking portable tanks, cargo tanks, tank cars, multi-unit tank car tanks, and other bulk packagings are prescribed in §§ 172.326, 172.328, 172.330, and 172.331, respectively, of this subpart.

(f) A bulk packaging marked prior to October 1, 1991, in conformance to the regulations of this subchapter in effect on September 30, 1991, need not be remarked if the key words of the proper shipping name are identical to those currently specified in the § 172.101 table. For example, a tank car marked "NITRIC OXIDE" need not be remarked "NITRIC OXIDE, COMPRESSED".

(g) A rail car, freight container, truck body or trailer in which the lading has been fumigated with any hazardous material, or is undergoing fumigation, must be marked as specified in § 173.9 of this subchapter.

[Amdt. 172-123, 55 FR 52591, Dec. 21, 1990, as amended at 56 FR 66254, Dec. 20, 1991; Amdt. 172-150, 61 FR 50624, Sept. 26, 1996; Amdt. 172-151, 62 FR 1228, Jan. 8, 1997; 62 FR 39398, July 22, 1997; 66 FR 45379, Aug. 28, 2001; 70 FR 73164, Dec. 9, 2005; 72 FR 55692, Oct. 1, 2007]

§ 172.303 Prohibited marking.

(a) No person may offer for transportation or transport a package which is marked with the proper shipping name, the identification number of a hazardous material or any other markings indicating that the material is hazardous (e.g., RQ, INHALATION HAZARD) unless the package contains the identified hazardous material or its residue.

(b) This section does not apply to—

(1) Transportation of a package in a transport vehicle or freight container if the package is not visible during transportation and is loaded by the shipper and unloaded by the shipper or consignee.

(2) Markings on a package which are securely covered in transportation.

(3) The marking of a shipping name on a package when the name describes

49 CFR Ch. I (10-1-14 Edition)

a material not regulated under this subchapter.

[Amdt. 172-123, 55 FR 52591, Dec. 21, 1990, as amended at 56 FR 66254, Dec. 20, 1991; 72 FR 55692, Oct. 1, 2007]

§ 172.304 Marking requirements.

(a) The marking required in this subpart—

(1) Must be durable, in English and printed on or affixed to the surface of a package or on a label, tag, or sign.

(2) Must be displayed on a background of sharply contrasting color;

(3) Must be unobscured by labels or attachments; and

(4) Must be located away from any other marking (such as advertising) that could substantially reduce its effectiveness.

(b) [Reserved]

[Amdt. 172-29, 41 FR 15996, Apr. 15, 1976, as amended by Amdt. 172-29B, 41 FR 57067, Dec. 30, 1976]

§ 172.306 [Reserved]

§ 172.308 Authorized abbreviations.

(a) Abbreviations may not be used in a proper shipping name marking except as authorized in this section.

(b) The abbreviation "ORM" may be used in place of the words "Other Regulated Material."

(c) Abbreviations which appear as authorized descriptions in column 2 of the § 172.101 table (e.g., "TNT" and "PCB") are authorized.

[Amdt. 172-123, 55 FR 52591, Dec. 21, 1990, as amended by Amdt. 172-145, 60 FR 49110, Sept. 21, 1995]

§ 172.310 Class 7 (radioactive) materials.

In addition to any other markings required by this subpart, each package containing Class 7 (radioactive) materials must be marked as follows:

(a) Each package with a gross mass greater than 50 kg (110 lb) must have its gross mass including the unit of measurement (which may be abbreviated) marked on the outside of the package.

(b) Each industrial, Type A, Type B(U), or Type B(M) package must be legibly and durably marked on the outside of the packaging, in letters at least 12 mm (0.47 in) high, with the

words “TYPE IP-1,” “TYPE IP-2,” “TYPE IP-3,” “TYPE A,” “TYPE B(U)” or “TYPE B(M),” as appropriate. A package which does not conform to Type IP-1, Type IP-2, Type IP-3, Type A, Type B(U) or Type B(M) requirements may not be so marked.

(c) Each package which conforms to an IP-1, IP-2, IP-3 or a Type A package design must be legibly and durably marked on the outside of the packaging with the international vehicle registration code of the country of origin of the design. The international vehicle registration code for packages designed by a United States company or agency is the symbol “USA.”

(d) Each package which conforms to a Type B(U) or Type B(M) package design must have the outside of the outermost receptacle, which is resistant to the effects of fire and water, plainly marked by embossing, stamping or other means resistant to the effects of fire and water with a radiation symbol that conforms to the requirements of appendix B of this part.

(e) Each Type B(U), Type B(M) or fissile material package destined for export shipment must also be marked “USA” in conjunction with the specification marking, or other package certificate identification. (See §§173.471, 173.472, and 173.473 of this subchapter.)

[Docket No. RSPA-99-6283 (HM-230), 69 FR 3668, Jan. 26, 2004, as amended at 79 FR 40609, July 11, 2014]

§ 172.312 Liquid hazardous materials in non-bulk packagings.

(a) Except as provided in this section, each non-bulk combination package having inner packagings containing liquid hazardous materials, single packaging fitted with vents, or open cryogenic receptacle intended for the transport of refrigerated liquefied gases must be:

- (1) Packed with closures upward, and
- (2) Legibly marked with package orientation markings that are similar to the illustration shown in this paragraph, on two opposite vertical sides of the package with the arrows pointing in the correct upright direction. The arrows must be either black or red on white or other suitable contrasting background and commensurate with the size of the package. Depicting a

rectangular border around the arrows is optional.

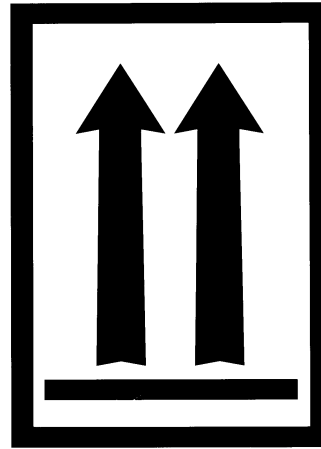

Package orientation

(b) Arrows for purposes other than indicating proper package orientation may not be displayed on a package containing a liquid hazardous material.

(c) The requirements of paragraph (a) of this section do not apply to—

- (1) A non-bulk package with inner packagings which are cylinders.
- (2) Except when offered or intended for transportation by aircraft, packages containing flammable liquids in inner packagings of 1 L or less prepared in accordance with §173.150 (b) or (c) of this subchapter.
- (3) When offered or intended for transportation by aircraft, packages containing liquid hazardous materials in inner packagings of 120 mL (4 fluid oz.) or less when packed with sufficient absorption material between the inner and outer packagings to completely absorb the liquid contents.
- (4) Liquids contained in manufactured articles (e.g., alcohol or mercury in thermometers) which are leak-tight in all orientations.
- (5) A non-bulk package with hermetically sealed inner packagings not exceeding 500 mL each.
- (6) Packages containing liquid infectious substances in primary receptacles not exceeding 50 mL (1.7 oz.).

§ 172.313

(7) Class 7 radioactive material in Type A, IP-2, IP-3, Type B(U), or Type B(M) packages.

[Amdt. 172-123, 55 FR 52591, Dec. 21, 1990, as amended at 56 FR 66254, Dec. 20, 1991; 57 FR 45458, Oct. 1, 1992; 64 FR 51918, Sept. 27, 1999; 66 FR 45379, Aug. 28, 2001; 68 FR 45030, July 31, 2003; 71 FR 54395, Sept. 14, 2006; 71FR 78627, Dec. 29, 2006; 76 FR 3365, Jan. 19, 2011; 78 FR 1073, Jan. 7, 2013]

§ 172.313 Poisonous hazardous materials.

In addition to any other markings required by this subpart:

(a) A material poisonous by inhalation (see §171.8 of this subchapter) shall be marked "Inhalation Hazard" in association with the required labels or placards, as appropriate, and shipping name when required. The marking must be on two opposing sides of a bulk packaging. (See §172.302(b) of this subpart for size of markings on bulk packages.) When the words "Inhalation Hazard" appear on the label, as prescribed in §§172.416 and 172.429, or placard, as prescribed in §§172.540 and 172.555, the "Inhalation Hazard" marking is not required on the package.

(b) Each non-bulk plastic outer packaging used as a single or composite packaging for materials meeting the definition of Division 6.1 (in §173.132 of this subchapter) shall be permanently marked, by embossment or other durable means, with the word "POISON" in letters at least 6.3 mm (0.25 inch) in height. Additional text or symbols related to hazard warning may be included in the marking. The marking shall be located within 150 mm (6 inches) of the closure of the packaging.

(c) A transport vehicle or freight container containing a material poisonous by inhalation in non-bulk packages shall be marked, on each side and each end as specified in §172.332 or §172.336, with the identification number specified for the hazardous material in the §172.101 table, subject to the following provisions and limitations:

(1) The material is in Hazard Zone A or B;

(2) The transport vehicle or freight container is loaded at one facility with 1,000 kg (2,205 pounds) or more aggregate gross weight of the material in non-bulk packages marked with the

49 CFR Ch. I (10-1-14 Edition)

same proper shipping name and identification number; and

(3) If the transport vehicle or freight container contains more than one material meeting the provisions of this paragraph (c), it shall be marked with the identification number for one material, determined as follows:

(i) For different materials in the same hazard zone, with the identification number of the material having the greatest aggregate gross weight; and

(ii) For different materials in both Hazard Zones A and B, with the identification number for the Hazard Zone A material.

(d) For a packaging containing a Division 6.1 PG III material, "PG III" may be marked adjacent to the POISON label. (See §172.405(c).)

[Amdt. 172-123, 55 FR 52592, Dec. 21, 1990, as amended at 57 FR 46624, Oct. 9, 1992; Amdt. 172-151, 62 FR 1228, Jan. 8, 1997; 62 FR 39398, 39405, July 22, 1997; 63 FR 16075, Apr. 1, 1998; 64 FR 10776, Mar. 5, 1999]

§ 172.315 Limited quantities.

(a) *Modes other than air transport.* Except for an article or substance of Class 7 prepared in accordance with subpart I of part 173, a package prepared in accordance with applicable limited quantity requirements in part 173 of this subchapter and offered for transportation by a mode other than air must display the limited quantity marking shown in paragraph (a)(1) of this section. A package displaying this mark is not subject to the marking requirements of §172.301 of this subpart unless the limited quantity package also contains a hazardous substance or a hazardous waste. Required markings need not be duplicated if already marked as prescribed elsewhere in this subpart. As an alternative, a packaging may display the limited quantity "Y" mark shown in paragraph (b) of this section if the package conforms to authorized substance and article provisions and the inner and outer package quantity limits in §173.27(f) of this subchapter.

(1) *Marking description.* The top and bottom portions of the square-on-point and the border forming the square-on-point must be black and the center white or of a suitable contrasting background as follows:

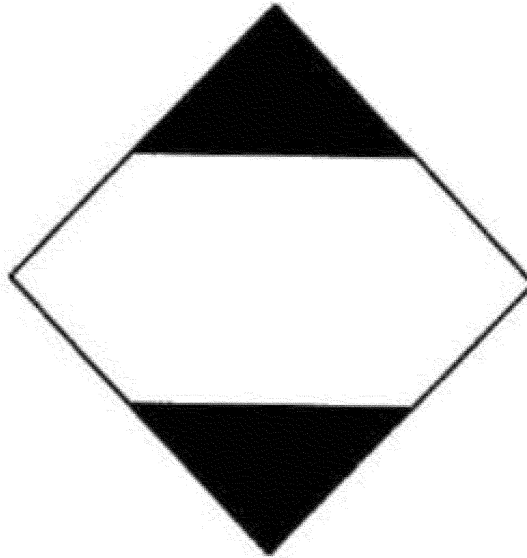

(2) The square-on-point must be durable, legible and of a size relative to the packaging, readily visible, and must be applied on at least one side or one end of the outer packaging. The width of the border forming the square-on-point must be at least 2 mm and the minimum dimension of each side must be 100 mm unless the packaging size requires a reduced size marking that must be no less than 50 mm on each side. When intended for transportation by vessel, a cargo transport unit (see §176.2 of this subchapter) containing packages of hazardous materials in only limited quantities must be marked once on each side and once on each end of the exterior of the unit with an identical mark which must have minimum dimensions of 250 mm on each side.

(b) *Air transport.* Except for an article or substance of Class 7 prepared in ac-

cordance with subpart I of part 173, a package prepared in accordance with air-specific limited quantity requirements prescribed in §173.27 of this subchapter and intended for transportation by air must display the limited quantity mark prescribed in paragraph (b)(1) of this section in addition to other markings required by this subpart (*e.g.*, "RQ", proper shipping name, identification number, as appropriate). Required markings need not be duplicated if already marked as prescribed elsewhere in this subpart.

(1) *Marking Description.* The top and bottom portions of the square-on-point and the border forming the square-on-point must be black and the center white or of a suitable contrasting background and the symbol "Y" must be black and located in the center of the square-on-point and be clearly visible as follows:

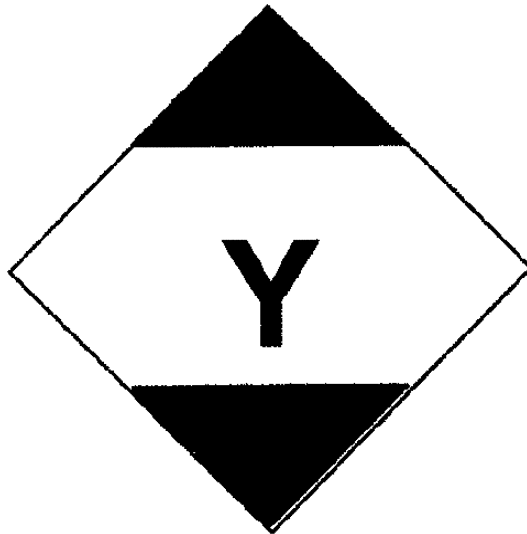

(2) The square-on-point must be durable, legible and of a size relative to the package as to be readily visible. The square-on-point must be applied on at least one side or one end of the outer packaging. The width of the border forming the square-on-point must be at least 2 mm and the minimum dimension of each side must be 100 mm unless the package size requires a reduced size marking that must be no less than 50 mm on each side.

(c) Limited quantity markings prescribed in paragraphs (a) and (b) of this section may use the packaging itself as the contrasting background for the center portion of the marking if the color sufficiently contrasts so that the black border, top and bottom portions of the square-on-point, and the “Y” symbol, if applicable, are clearly recognizable.

(d) *Transitional exceptions*—(1) *Alternative markings*. Except for transportation by aircraft and until December 31, 2015, a package containing a limited quantity may continue to be marked in accordance with the requirements of this section in effect on October 1, 2010 (i.e., square-on-point with identification number only) as an alternative to the marking required by paragraph (a) of this section.

(2) *ORM-D marked packaging*. Except for transportation by aircraft and until December 31, 2020, a packaging marked in accordance with § 172.316 of this part is not required to be marked with the limited quantity marking required by paragraph (a) of this section. For transportation by aircraft and until December 31, 2012, a packaging marked in accordance with § 172.316(a)(1) is not required to be marked with the limited quantity “Y” marking required by paragraph (b) of this section.

[76 FR 82174, Dec. 30, 2011, as amended at 78 FR 1073, Jan. 7, 2013; 78 FR 65478, Oct. 31, 2013]

§ 172.316 Packagings containing materials classed as ORM-D.

(a) Each non-bulk packaging containing a material classed as ORM-D must be marked on at least one side or end with the ORM-D designation immediately following or below the proper shipping name of the material. The ORM designation must be placed within a rectangle that is approximately 6.3 mm (0.25 inches) larger on each side than the designation. Until December 31, 2020, the designation ORM-D is for an ORM-D material, as defined in § 173.144, that is packaged in accordance with §§ 173.63(b), 173.150 through 173.156, and 173.306.

(b) When the ORM-D marking including the proper shipping name can not be affixed on the package surface, it may be on an attached tag.

(c) The marking ORM-D is the certification by the person offering the packaging for transportation that the material is properly described, classed, packaged, marked and labeled (when appropriate) and in proper condition for transportation according to the applicable regulations of this subchapter. This form of certification does not preclude the requirement for a certificate on a shipping paper when required by subpart C of this part.

[Amdt. 172-29, 41 FR 15996, Apr. 15, 1976, as amended by Amdt. 172-123, 55 FR 52592, Dec. 21, 1990; 56 FR 66254, Dec. 20, 1991; 76 FR 3366, Jan. 19, 2011; 78 FR 1113, Jan. 7, 2013; 78 FR 65478, Oct. 31, 2013]

§ 172.317 KEEP AWAY FROM HEAT handling mark.

(a) *General.* For transportation by aircraft, each package containing self-reactive substances of Division 4.1 or organic peroxides of Division 5.2 must be marked with the KEEP AWAY FROM HEAT handling mark specified in this section.

(b) *Location and design.* The marking must be a rectangle measuring at least 105 mm (4.1 inches) in height by 74 mm (2.9 inches) in width. Markings with not less than half this dimension are permissible where the dimensions of the package can only bear a smaller mark.

(c) *KEEP AWAY FROM HEAT handling mark.* The KEEP AWAY FROM HEAT handling mark must conform to the following:

(1) Except for size, the KEEP AWAY FROM HEAT handling mark must appear as follows:

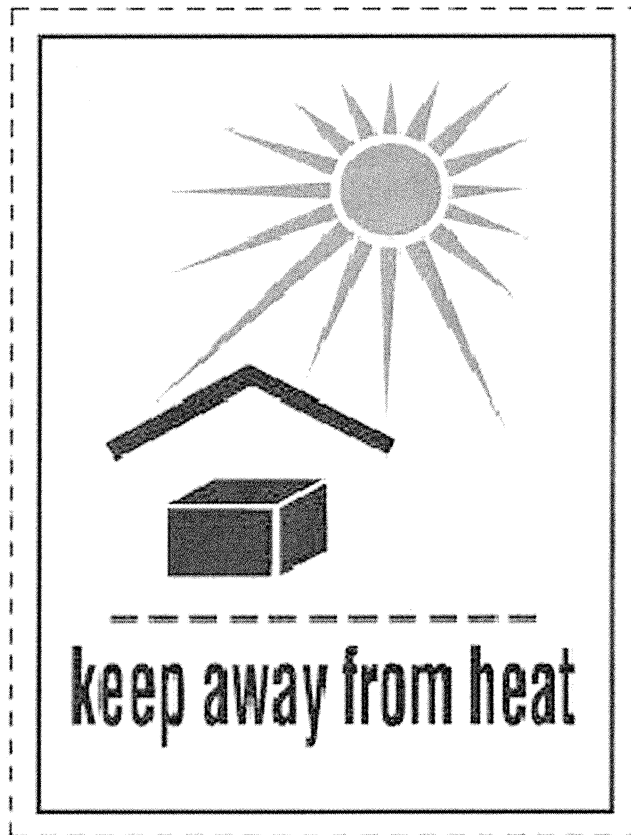

(2) The symbol, letters and border must be black and the background white, except for the starburst which must be red.

(3) The KEEP AWAY FROM HEAT handling marking required by paragraph (a) of this section must be durable, legible and displayed on a background of contrasting color.

[69 FR 76153, Dec. 20, 2004]

§ 172.320 Explosive hazardous materials.

(a) Except as otherwise provided in paragraphs (b), (c), (d) and (e) of this section, each package containing a Class 1 material must be marked with the EX-number for each substance, article or device contained therein.

(b) Except for fireworks approved in accordance with §173.64 of this subchapter, a package of Class 1 materials may be marked as follows, in lieu of the EX number required by paragraph (a) of this section:

(1) With a national stock number issued by the Department of Defense or identifying information, such as a product code required by regulations for commercial explosives specified in 27 CFR part 555, if the national stock number or identifying information can be specifically associated with the EX number assigned; or

(2) For Division 1.4G consumer fireworks reviewed by a Fireworks Certification Agency approved in accordance with 49 CFR part 107 subpart E and certified in accordance with §173.65, with

the FC number assigned by a DOT-approved Fireworks Certification Agency.

(c) When more than five different Class 1 materials are packed in the same package, the package may be marked with only five of the EX-numbers, national stock numbers, product codes, or combination thereof.

(d) The requirements of this section do not apply if the EX number, FC number, product code or national stock number of each explosive item described under a proper shipping description is shown in association with the shipping description required by §172.202(a). Product codes and national stock numbers must be traceable to the specific EX number assigned by the Associate Administrator or FC number assigned by a DOT-approved Fireworks Certification Agency.

(e) The requirements of this section do not apply to the following Class 1 materials:

(1) Those being shipped to a testing agency in accordance with §173.56(d) of this subchapter;

(2) Those being shipped in accordance with §173.56(e) of this subchapter, for the purposes of developmental testing;

(3) Those which meet the requirements of §173.56(h) of this subchapter and therefore are not subject to the approval process of §173.56 of this subchapter;

(4) [Reserved];

(5) Those that are transported in accordance with §173.56(c)(2) of this subchapter and, therefore, are covered by a national security classification currently in effect.

[Amdt. 172-123, 56 FR 66254, Dec. 20, 1991, as amended by Amdt. 172-139, 59 FR 67487, Dec. 29, 1994; 66 FR 45379, Aug. 28, 2001; 74 FR 53188, Oct. 16, 2009; 78 FR 42477, July 16, 2013]

§ 172.322 Marine pollutants.

(a) For vessel transportation of each non-bulk packaging that contains a marine pollutant—

(1) If the proper shipping name for a material which is a marine pollutant does not identify by name the component which makes the material a marine pollutant, the name of that component must be marked on the package in parentheses in association with the marked proper shipping name. Where

two or more components which make a material a marine pollutant are present, the names of at least two of the components most predominantly contributing to the marine pollutant designation must appear in parentheses in association with the marked proper shipping name; and

(2) The MARINE POLLUTANT mark shall be placed in association with the hazard warning labels required by subpart E of this part or, in the absence of any labels, in association with the marked proper shipping name.

(b) A bulk packaging that contains a marine pollutant must—

(1) Be marked with the MARINE POLLUTANT mark on at least two opposing sides or two ends other than the bottom if the packaging has a capacity of less than 3,785 L (1,000 gallons). The mark must be visible from the direction it faces. The mark may be displayed in black lettering on a square-on-point configuration having the same outside dimensions as a placard; or

(2) Be marked on each end and each side with the MARINE POLLUTANT mark if the packaging has a capacity of 3,785 L (1,000 gallons) or more. The mark must be visible from the direction it faces. The mark may be displayed in black lettering on a square-on-point configuration having the same outside dimensions as a placard.

(c) A transport vehicle or freight container that contains a package subject to the marking requirements of paragraph (a) or (b) of this section must be marked with the MARINE POLLUTANT mark. The mark must appear on each side and each end of the transport vehicle or freight container, and must be visible from the direction it faces. This requirement may be met by the marking displayed on a freight container or portable tank loaded on a motor vehicle or rail car. This mark may be displayed in black lettering on a white square-on-point configuration having the same outside dimensions as a placard.

(d) The MARINE POLLUTANT mark is not required—

(1) On single packagings or combination packagings where each single package or each inner packaging of combination packagings has:

§ 172.323

- (i) A net quantity of 5 L (1.3 gallons) or less for liquids; or
- (ii) A net mass of 5 kg (11 pounds) or less for solids
- (2) On a combination packaging containing a marine pollutant, other than a severe marine pollutant, in inner packagings each of which contains:
 - (i) 5 L (1.3 gallons) or less net capacity for liquids; or
 - (ii) 5 kg (11 pounds) or less net capacity for solids.
- (3) Except for transportation by vessel, on a bulk packaging, freight container or transport vehicle that bears a label or placard specified in subparts E or F of this part.

(4) On a package of limited quantity material marked in accordance with §172.315 of this part.

(e) *MARINE POLLUTANT* mark. Effective January 14, 2010 the MARINE POLLUTANT mark must conform to the following:

(1) Except for size, the MARINE POLLUTANT mark must appear as follows:

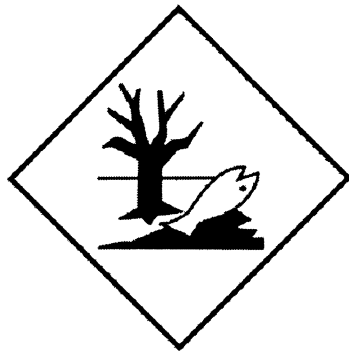

Symbol (fish and tree): Black on white or suitable contrasting background.

(2) The symbol and border must be black and the background white, or the symbol, border and background must be of contrasting color to the surface to which the mark is to be affixed. Each side of the mark must be—

(i) At least 100 mm (4 inches) for marks applied to:

(A) Non-bulk packages, except in the case of packages which, because of

49 CFR Ch. I (10–1–14 Edition)

their size, can only bear smaller marks;

(B) Bulk packages with a capacity of less than 3,785 L (1,000 gallons); or

(ii) At least 250 mm (10 inches) for marks applied to all other bulk packages.

(f) *Exceptions.* See §171.4(c).

[Amdt. 172-127, 57 FR 52938, Nov. 5, 1992, as amended by Amdt. 172-136, 59 FR 38064, July 26, 1994; Amdt. 172-145, 60 FR 49110, Sept. 21, 1995; 66 FR 45379, Aug. 28, 2001; 70 FR 56098, Sept. 23, 2005; 74 FR 2252, Jan. 14, 2009; 76 FR 3367, Jan. 19, 2011]

§ 172.323 Infectious substances.

(a) In addition to other requirements of this subpart, a bulk packaging containing a regulated medical waste, as defined in §173.134(a)(5) of this subchapter, must be marked with a BIOHAZARD marking conforming to 29 CFR 1910.1030(g)(1)(i)—

(1) On two opposing sides or two ends other than the bottom if the packaging has a capacity of less than 3,785 L (1,000 gallons). The BIOHAZARD marking must measure at least 152.4 mm (6 inches) on each side and must be visible from the direction it faces.

(2) On each end and each side if the packaging has a capacity of 3,785 L (1,000 gallons) or more. The BIOHAZARD marking must measure at least 152.4 mm (6 inches) on each side and must be visible from the direction it faces.

(b) For a bulk packaging contained in or on a transport vehicle or freight container, if the BIOHAZARD marking on the bulk packaging is not visible, the transport vehicle or freight container must be marked as required by paragraph (a) of this section on each side and each end.

(c) The background color for the BIOHAZARD marking required by paragraph (a) of this section must be orange and the symbol and letters must be black. Except for size the BIOHAZARD marking must appear as follows:



(d) The BIOHAZARD marking required by paragraph (a) of this section must be displayed on a background of contrasting color. It may be displayed on a plain white square-on-point configuration having the same outside dimensions as a placard, as specified in §172.519(c) of this part.

[67 FR 53135, Aug. 14, 2002, as amended at 76 FR 56314, Sept. 13, 2011]

§ 172.324 Hazardous substances in non-bulk packagings.

For each non-bulk package that contains a hazardous substance—

(a) Except for packages of radioactive material labeled in accordance with §172.403, if the proper shipping name of a material that is a hazardous substance does not identify the hazardous substance by name, the name of the hazardous substance must be marked on the package, in parentheses,

§ 172.325

49 CFR Ch. I (10–1–14 Edition)

in association with the proper shipping name. If the material contains two or more hazardous substances, at least two hazardous substances, including the two with the lowest reportable quantities (RQs), must be identified. For a hazardous waste, the waste code (e.g., D001), if appropriate, may be used to identify the hazardous substance.

(b) The letters “RQ” must be marked on the package in association with the proper shipping name.

(c) A package of limited quantity material marked in accordance with §172.315 must also be marked in accordance with the applicable requirements of this section.

[73 FR 4716, Jan. 28, 2008, as amended at 76 FR 3367, Jan. 19, 2011]

§ 172.325 Elevated temperature materials.

(a) Except as provided in paragraph (b) of this section, a bulk packaging containing an elevated temperature material must be marked on two opposing sides with the word “HOT” in

black or white Gothic lettering on a contrasting background. The marking must be displayed on the packaging itself or in black lettering on a plain white square-on-point configuration having the same outside dimensions as a placard. (See §172.302(b) for size of markings on bulk packagings.)

(b) Bulk packagings containing molten aluminum or molten sulfur must be marked “MOLTEN ALUMINUM” or “MOLTEN SULFUR”, respectively, in the same manner as prescribed in paragraph (a) of this section.

(c) If the identification number is displayed on a white-square-on-point display configuration, as prescribed in §172.336(b), the word “HOT” may be displayed in the upper corner of the same white-square-on-point display configuration. The word “HOT” must be in black letters having a height of at least 50 mm (2.0 inches). Except for size, these markings shall be as illustrated for an Elevated temperature material, liquid, n.o.s.:



[Amdt. 172-125, 58 FR 3348, Jan. 8, 1993, as amended by Amdt. 172-139, 59 FR 67487, Dec. 29, 1994]

§ 172.326 Portable tanks.

(a) *Shipping name.* No person may offer for transportation or transport a portable tank containing a hazardous material unless it is legibly marked on two opposing sides with the proper shipping name specified for the material in the §172.101 table. For transportation by vessel, the minimum height for a proper shipping name marked on a portable tank is 65 mm (2.5 inches).

(b) *Owner's name.* The name of the owner or of the lessee, if applicable, must be displayed on a portable tank that contains a hazardous material.

(c) *Identification numbers.* (1) If the identification number markings re-

quired by §172.302(a) are not visible, a transport vehicle or freight container used to transport a portable tank containing a hazardous material must be marked on each side and each end as required by §172.332 with the identification number specified for the material in the §172.101 table.

(2) Each person who offers a portable tank containing a hazardous material to a motor carrier, for transportation in a transport vehicle or freight container, shall provide the motor carrier with the required identification numbers on placards, orange panels, or the white square-on-point configuration, as appropriate, for each side and each end

§ 172.327

49 CFR Ch. I (10–1–14 Edition)

of the transport vehicle or freight container from which identification numbers on the portable tank are not visible.

(d) *NON-ODORIZED marking on portable tanks containing LPG.* After September 30, 2006, no person may offer for transportation or transport a portable tank containing liquefied petroleum gas (LPG) that is unodorized as authorized in §173.315(b)(1) unless it is legibly marked NON-ODORIZED or NOT ODORIZED on two opposing sides near the marked proper shipping name required by paragraph (a) of this section, or near the placards.

[Amdt. 172-123, 55 FR 52592, Dec. 21, 1990, as amended at 56 FR 66255, Dec. 20, 1991; 69 FR 64471, Nov. 4, 2004; 76 FR 3367, Jan. 19, 2011]

§ 172.327 Petroleum sour crude oil in bulk packaging.

A Bulk packaging used to transport petroleum crude oil containing hydrogen sulfide (*i.e.*, sour crude oil) in suffi-

cient concentration that vapors evolved from the crude oil may present an inhalation hazard must include a marking, label, tag, or sign to warn of the toxic hazard as follows:

(a) The marking must be durable, legible and of a size relative to the package as to be readily visible and similar to the illustration shown in this paragraph with the minimum dimension of each side of the marking at least 100 mm (3.9 inches). The width of the border forming the square-on-point marking must be at least 5 mm. The marking must be displayed at each location (*e.g.*, manhole, loading head) where exposure to hydrogen sulfide vapors may occur.

(b) The border of the square-on-point must be black or red on a white or other suitable contrasting background. The symbol must be black and located in the center of the square-on-point and be clearly visible as follows:



(c) As an alternative to the marking required in (a) and (b) of this section, a label, tag, or sign may be displayed at each location (*e.g.*, manhole, loading head) where exposure to hydrogen sulfide vapors may occur. The label, tag, or sign must be durable, in English, and printed legibly and of a size relative to the package with a warning statement such as “Danger, Possible Hydrogen Sulfide Inhalation Hazard” to communicate the possible risk of exposure to harmful concentrations of hydrogen sulfide gas.

[76 FR 3367, Jan. 19, 2011]

§ 172.328 Cargo tanks.

(a) *Providing and affixing identification numbers.* Unless a cargo tank is already marked with the identification numbers required by this subpart, the identification numbers must be provided or affixed as follows:

(1) A person who offers a hazardous material to a motor carrier for transportation in a cargo tank shall provide the motor carrier the identification numbers on placards or shall affix orange panels containing the required identification numbers, prior to or at the time the material is offered for transportation.

§ 172.330

49 CFR Ch. I (10–1–14 Edition)

(2) A person who offers a cargo tank containing a hazardous material for transportation shall affix the required identification numbers on panels or placards prior to or at the time the cargo tank is offered for transportation.

(3) For a cargo tank transported on or in a transport vehicle or freight container, if the identification number marking on the cargo tank required by §172.302(a) would not normally be visible during transportation—

(i) The transport vehicle or freight container must be marked as required by §172.332 on each side and each end with the identification number specified for the material in the §172.101 table; and

(ii) When the cargo tank is permanently installed within an enclosed cargo body of the transport vehicle or freight container, the identification number marking required by §172.302(a) need only be displayed on each side and end of a cargo tank that is visible when the cargo tank is accessed.

(b) *Required markings: Gases.* Except for certain nurse tanks which must be marked as specified in §173.315(m) of this subchapter, each cargo tank transporting a Class 2 material subject to this subchapter must be marked, in lettering no less than 50 mm (2.0 inches), on each side and each end with—

(1) The proper shipping name specified for the gas in the §172.101 table; or

(2) An appropriate common name for the material (e.g., “Refrigerant Gas”).

(c) *QT/NQT markings.* Each MC 330 and MC 331 cargo tank must be marked near the specification plate, in letters no less than 50 mm (2.0 inches) in height, with—

(1) “QT”, if the cargo tank is constructed of quenched and tempered steel; or

(2) “NQT”, if the cargo tank is constructed of other than quenched and tempered steel.

(d) After October 3, 2005, each on-vehicle manually-activated remote shut-off device for closure of the internal self-closing stop valve must be identified by marking “Emergency Shutoff” in letters at least 0.75 inches in height, in a color that contrasts with its background, and located in an area im-

mediately adjacent to the means of closure.

(e) *NON-ODORIZED marking on cargo tanks containing LPG.* After September 30, 2006, no person may offer for transportation or transport a cargo tank containing liquefied petroleum gas (LPG) that is unodorized as authorized in §173.315(b)(1) unless it is legibly marked NON-ODORIZED or NOT ODORIZED on two opposing sides near the marked proper shipping name as specified in paragraph (b)(1) of this section, or near the placards.

[Amdt. 172–123, 55 FR 52592, Dec. 21, 1990, as amended at 56 FR 66255, Dec. 20, 1991; Amdt. 172–151, 62 FR 1228, Jan. 8, 1997; 62 FR 39045, July 22, 1997; 68 FR 19277, Apr. 18, 2003; 69 FR 64471, Nov. 4, 2004]

§ 172.330 Tank cars and multi-unit tank car tanks.

(a) *Shipping name and identification number.* No person may offer for transportation or transport a hazardous material—

(1) In a tank car unless the following conditions are met:

(i) The tank car must be marked on each side and each end as required by §172.302 with the identification number specified for the material in the §172.101 table; and

(ii) A tank car containing any of the following materials must be marked on each side with the key words of the proper shipping name specified for the material in the §172.101 table, or with a common name authorized for the material in this subchapter (e.g., “Refrigerant Gas”):

- Acrolein, stabilized
- Ammonia, anhydrous, liquefied
- Ammonia solutions (more than 50% ammonia)
- Bromine or Bromine solutions
- Bromine chloride
- Chloroprene, stabilized
- Dispersant gas or Refrigerant gas (as defined in §173.115 of this subchapter)
- Division 2.1 materials
- Division 2.2 materials (in Class DOT 107 tank cars only)
- Division 2.3 materials
- Formic acid
- Hydrocyanic acid, aqueous solutions
- Hydrofluoric acid, solution
- Hydrogen cyanide, stabilized (less than 3% water)
- Hydrogen fluoride, anhydrous

Hydrogen peroxide, aqueous solutions (greater than 20% hydrogen peroxide)
 Hydrogen peroxide, stabilized
 Hydrogen peroxide and peroxyacetic acid mixtures
 Nitric acid (other than red fuming)
 Phosphorus, amorphous
 Phosphorus, white dry *or* Phosphorus, white, under water *or* Phosphorus white, in solution, *or* Phosphorus, yellow dry *or* Phosphorus, yellow, under water *or* Phosphorus, yellow, in solution
 Phosphorus white, molten
 Potassium nitrate and sodium nitrate mixtures
 Potassium permanganate
 Sulfur trioxide, stabilized
 Sulfur trioxide, uninhibited

(2) In a multi-unit tank car tank, unless the tank is marked on two opposite sides, in letters and numerals no less than 50 mm (2.0 inches) high—

(i) With the proper shipping name specified for the material in the §172.101 table or with a common name authorized for the material in this subchapter (e.g., “Refrigerant Gas”); and

(ii) With the identification number specified for the material in the §172.101 table, unless marked in accordance with §§172.302(a) and 172.332 of this subpart.

(b) A motor vehicle or rail car used to transport a multi-unit tank car tank containing a hazardous material must be marked on each side and each end, as required by §172.332, with the identification number specified for the material in the §172.101 table.

(c) After September 30, 2006, no person may offer for transportation or transport a tank car or multi-unit tank car tank containing liquefied petroleum gas (LPG) that is unodorized unless it is legibly marked NON-ODORIZED or NOT ODORIZED on two opposite sides near the marked proper shipping name required by paragraphs (a)(1) and (a)(2) of this section, or near the placards. The NON-ODORIZED or NOT ODORIZED marking may appear on a tank car or multi-unit tank car tank used for both unodorized and odorized LPG.

[Amdt. 172-123, 55 FR 52593, Dec. 21, 1990, as amended at 56 FR 66255, Dec. 20, 1991; 57 FR 45458, Oct. 1, 1992; Amdt. 172-148, 61 FR 28676, June 5, 1996; Amdt. 172-148, 61 FR 50254, Sept. 25, 1996; 66 FR 33425, June 21, 2001; 69 FR 64471, Nov. 4, 2004]

§ 172.331 Bulk packagings other than portable tanks, cargo tanks, tank cars and multi-unit tank car tanks.

(a) Each person who offers a hazardous material to a motor carrier for transportation in a bulk packaging shall provide the motor carrier with the required identification numbers on placards or plain white square-on-point display configurations, as authorized, or shall affix orange panels containing the required identification numbers to the packaging prior to or at the time the material is offered for transportation, unless the packaging is already marked with the identification number as required by this subchapter.

(b) Each person who offers a bulk packaging containing a hazardous material for transportation shall affix to the packaging the required identification numbers on orange panels, square-on-point configurations or placards, as appropriate, prior to, or at the time the packaging is offered for transportation unless it is already marked with identification numbers as required by this subchapter.

(c) For a bulk packaging contained in or on a transport vehicle or freight container, if the identification number marking on the bulk packaging (e.g., an IBC) required by §172.302(a) is not visible, the transport vehicle or freight container must be marked as required by §172.332 on each side and each end with the identification number specified for the material in the §172.101 table.

[Amdt. 172-123, 55 FR 52593, Dec. 21, 1994, as amended by Amdt. 172-151, 62 FR 1228, Jan. 8, 1997; 62 FR 39398, July 22, 1997]

§ 172.332 Identification number markings.

(a) *General.* When required by §172.301, §172.302, §172.313, §172.326, §172.328, §172.330, or §172.331, identification number markings must be displayed on orange panels or placards as specified in this section, or on white square-on-point configurations as prescribed in §172.336(b).

(b) *Orange panels.* Display of an identification number on an orange panel shall be in conformance with the following:

(1) The orange panel must be 160 mm (6.3 inches) high by 400 mm (15.7 inches)

§ 172.334

49 CFR Ch. I (10–1–14 Edition)

wide with a 15 mm (0.6 inches) black outer border. The identification number shall be displayed in 100 mm (3.9 inches) black Helvetica Medium numerals on the orange panel. Measurements may vary from those specified plus or minus 5 mm (0.2 inches).

(2) The orange panel may be made of any durable material prescribed for placards in §172.519, and shall be of the orange color specified for labels or placards in appendix A to this part.

(3) The name and hazard class of a material may be shown in the upper left border of the orange panel in letters not more than 18 points (0.25 in.) high.

(4) Except for size and color, the orange panel and identification numbers shall be as illustrated for Liquefied petroleum gas:



(c) *Placards.* Display of an identification number on a hazard warning placard shall be in conformance with the following:

(1) The identification number shall be displayed across the center area of the placard in 88 mm (3.5 inches) black Alpine Gothic or Alternate Gothic No. 3 numerals on a white background 100 mm (3.9 inches) high and approximately 215 mm (8.5 inches) wide and may be outlined with a solid or dotted line border.

(2) The top of the 100 mm (3.9 inches) high white background shall be approximately 40 mm (1.6 inches) above the placard horizontal center line.

(3) An identification number may be displayed only on a placard corresponding to the primary hazard class of the hazardous material.

(4) For a COMBUSTIBLE placard used to display an identification number, the entire background below the white background for the identification number must be white during transportation by rail and may be white during transportation by highway.

(5) The name of the hazardous material and the hazard class may be shown in letters not more than 18 points high immediately within the upper border of the space on the placard bearing the identification number of the material.

(6) If an identification number is placed over the word(s) on a placard, the word(s) should be substantially covered to maximize the effectiveness of the identification number.

(d) Except for size and color, the display of an identification number on a placard shall be as illustrated for Acetone:



[Amdt. 172-101, 45 FR 74667, Nov. 10, 1980, as amended by Amdt. 172-81, 48 FR 28099, June 20, 1983; Amdt. 172-110, 52 FR 29527, Aug. 10, 1987; Amdt. 172-123, 55 FR 52593, Dec. 21, 1990; 56 FR 66255, Dec. 20, 1991; Amdt. 172-151, 62 FR 1228, Jan. 8, 1997; 65 FR 50459, Aug. 18, 2000; 68 FR 57632, Oct. 6, 2003]

§ 172.334 Identification numbers; prohibited display.

(a) No person may display an identification number on a RADIOACTIVE, EXPLOSIVES 1.1, 1.2, 1.3, 1.4, 1.5 or 1.6, DANGEROUS, or subsidiary hazard placard.

(b) No person may display an identification number on a placard, orange panel or white square-on-point display configuration unless—

(1) The identification number is specified for the material in §172.101;

(2) The identification number is displayed on the placard, orange panel or white square-on-point configuration authorized by §172.332 or §172.336(b), as appropriate, and any placard used for display of the identification number

corresponds to the hazard class of the material specified in §172.504;

(3) Except as provided under §172.336 (c)(4) or (c)(5), the package, freight container, or transport vehicle on which the number is displayed contains the hazardous material associated with that identification number in §172.101.

(c) Except as required by §172.332(c)(4) for a combustible liquid, the identification number of a material may be displayed only on the placards required by the tables in §172.504.

(d) Except as provided in §172.336, a placard bearing an identification number may not be used to meet the requirements of subpart F of this part unless it is the correct identification number for all hazardous materials of the same class in the transport vehicle or freight container on which it is displayed.

(e) Except as specified in §172.338, an identification number may not be displayed on an orange panel on a cargo tank unless affixed to the cargo tank by the person offering the hazardous material for transportation in the cargo tank.

(f) If a placard is required by §172.504, an identification number may not be displayed on an orange panel unless it is displayed in proximity to the placard.

(g) No person shall add any color, number, letter, symbol, or word other than as specified in this subchapter, to any identification number marking display which is required or authorized by this subchapter.

[Amdt. 172-101, 45 FR 74667, Nov. 10, 1980, as amended by Amdt. 172-104, 51 FR 23078, June 25, 1986; Amdt. 172-110, 52 FR 29528, Aug. 10, 1987; Amdt. 172-123, 55 FR 52593, Dec. 21, 1990; 56 FR 66255, Dec. 20, 1991; Amdt. 172-127, 59 FR 49133, Sept. 26, 1994]

§ 172.336 Identification numbers; special provisions.

(a) When not required or prohibited by this subpart, identification numbers may be displayed on a transport vehicle or a freight container in the manner prescribed by this subpart.

(b) Identification numbers, when required, must be displayed on either orange panels (see §172.332(b)) or on a plain white square-on-point display configuration having the same outside

dimensions as a placard. In addition, for materials in hazard classes for which placards are specified and identification number displays are required, but for which identification numbers may not be displayed on the placards authorized for the material (see §172.334(a)), identification numbers must be displayed on orange panels or on the plain white square-on-point display configuration in association with the required placards. An identification number displayed on a white square-on-point display configuration is not considered to be a placard.

(1) The 100 mm (3.9 inch) by 215 mm (8.5 inches) area containing the identification number shall be located as prescribed by §172.332 (c)(1) and (c)(2) and may be outlined with a solid or dotted line border.

(2) [Reserved]

(c) Identification Numbers are not required:

<i>Packaging:</i>	<i>When:</i>	<i>Then the alternative marking requirement is:</i>
On the ends of portable tanks, cargo tanks, or tank cars.	They have more than one compartment and hazardous materials with different identification numbers are being transported therein.	The identification numbers on the sides of the tank are displayed in the same sequence as the compartments containing the materials they identify.
On cargo tanks	They contain only gasoline.	The tank is marked "Gasoline" on each side and rear in letters no less than 50 mm (2 inches) high, or is placarded in accordance with § 172.542(c).
On cargo tanks	They contain only fuel oil.	The cargo tank is marked "Fuel Oil" on each side and rear in letters no less than 50 mm (2 inches) high, or is placarded in accordance with § 172.544(c).

§ 172.338

49 CFR Ch. I (10–1–14 Edition)

<i>Packaging:</i>	<i>When:</i>	<i>Then the alternative marking requirement is:</i>
On one end of nurse tanks if that end contains valves, fittings, regulators or gauges when those appurtenances prevent the markings and placard from being properly placed and visible.	They meet the provisions of § 173.315(m) of this subchapter.	N/A.
On cargo tanks, including compartmented cargo tanks, or tank cars.	They contain more than one petroleum distillate fuel.	The identification number for the liquid petroleum distillate fuel having the lowest flash point is displayed. If the cargo tank also contains gasoline and alcohol fuel blends consisting of more than 10% ethanol the identification number "3475" or "1987," as appropriate, must also be displayed.

damaged identification numbers as soon as practicable. However, in such a case, the numbers may be entered by hand on the appropriate placard, orange panel or white square-on-point display configuration providing the correct identification numbers are entered legibly using an indelible marking material. When entered by hand, the identification numbers must be located in the white display area specified in §172.332. This section does not preclude required compliance with the placarding requirements of subpart F of this subchapter.

[Amdt. 172–110, 52 FR 29528, Aug. 10, 1987]

Subpart E—Labeling

§ 172.400 General labeling requirements.

(a) Except as specified in §172.400a, each person who offers for transportation or transports a hazardous material in any of the following packages or containment devices, shall label the package or containment device with labels specified for the material in the §172.101 table and in this subpart:

- (1) A non-bulk package;
- (2) A bulk packaging, other than a cargo tank, portable tank, or tank car, with a volumetric capacity of less than 18 m³ (640 cubic feet), unless placarded in accordance with subpart F of this part;
- (3) A portable tank of less than 3785 L (1000 gallons) capacity, unless placarded in accordance with subpart F of this part;
- (4) A DOT Specification 106 or 110 multi-unit tank car tank, unless placarded in accordance with subpart F of this part; and
- (5) An overpack, freight container or unit load device, of less than 18 m³ (640 cubic feet), which contains a package for which labels are required, unless placarded or marked in accordance with §172.512 of this part.

(b) Labeling is required for a hazardous material which meets one or more hazard class definitions, in accordance with column 6 of the §172.101 table and the following table:

(d) When a bulk packaging is labeled instead of placarded in accordance with §172.514(c) of this subchapter, identification number markings may be displayed on the package in accordance with the marking requirements of §172.301(a)(1) of this subchapter.

[Amdt. 172–101, 45 FR 74667, Nov. 10, 1980, as amended by Amdt. 172–74, 47 FR 40365, Sept. 30, 1982; Amdt. 172–109, 52 FR 13038, Apr. 20, 1987; Amdt. 172–110, 52 FR 29528, Aug. 10, 1987; Amdt. 172–123, 55 FR 52593, Dec. 21, 1990; 56 FR 66255, Dec. 20, 1991; 65 FR 50459, Aug. 18, 2000; 73 FR 4716, Jan. 28, 2008; 76 FR 43527, July 20, 2011; 78 FR 14714, Mar. 7, 2013; 78 FR 65478, Oct. 31, 2013]

§ 172.338 Replacement of identification numbers.

If more than one of the identification number markings on placards, orange panels, or white square-on-point display configurations that are required to be displayed are lost, damaged or destroyed during transportation, the carrier shall replace all the missing or

Hazard class or division	Label name	Label design or section reference
1.1	EXPLOSIVES 1.1	172.411
1.2	EXPLOSIVES 1.2	172.411
1.3	EXPLOSIVES 1.3	172.411
1.4	EXPLOSIVES 1.4	172.411
1.5	EXPLOSIVES 1.5	172.411
1.6	EXPLOSIVES 1.6	172.411
2.1	FLAMMABLE GAS	172.417
2.2	NONFLAMMABLE GAS	172.415
2.3	POISON GAS	172.416
3 Flammable Liquid (Combustible liquid)	FLAMMABLE LIQUID (none)	172.419
4.1	FLAMMABLE SOLID	172.420
4.2	SPONTANEOUSLY COMBUSTIBLE	172.422
4.3	DANGEROUS WHEN WET	172.423
5.1	OXIDIZER	172.426
5.2	ORGANIC PEROXIDE	172.427
6.1 (material poisonous by inhalation (see § 171.8 of this subchapter)).	POISON INHALATION HAZARD	172.429
6.1 (other than material poisonous by inhalation)	POISON	172.430
6.1 (inhalation hazard, Zone A or B)	POISON INHALATION HAZARD	172.429
6.1 (other than inhalation hazard, Zone A or B)	POISON	172.430
6.2	INFECTIOUS SUBSTANCE ¹	172.432
7 (see § 172.403)	RADIOACTIVE WHITE-I	172.436
7	RADIOACTIVE YELLOW-II	172.438
7	RADIOACTIVE YELLOW-III	172.440
7 (fissile radioactive material; see § 172.402)	FISSILE	172.441
7 (empty packages, see § 173.428 of this subchapter)	EMPTY	172.450
8	CORROSIVE	172.442
9	CLASS 9	172.446

¹The ETIOLOGIC AGENT label specified in regulations of the Department of Health and Human Services at 42 CFR 72.3 may apply to packages of infectious substances.

[Amdt. 172-123, 55 FR 52593, Dec. 21, 1990, as amended at 56 FR 66255, Dec. 20, 1991; Amdt. 172-151, 62 FR 1228, Jan. 8, 1997; 64 FR 10776, Mar. 5, 1999; 64 FR 51918, Sept. 27, 1999; 69 FR 3668, Jan. 26, 2004; 69 FR 64471, Nov. 4, 2004; 78 FR 60753, Oct. 2, 2013]

§ 172.400a Exceptions from labeling.

(a) Notwithstanding the provisions of § 172.400, a label is not required on—

(1) A Dewar flask meeting the requirements in § 173.320 of this subchapter or a cylinder containing a Division 2.1, 2.2, or 2.3 material that is—

- (i) Not overpacked; and
- (ii) Durably and legibly marked in accordance with CGA C-7, Appendix A (IBR; see § 171.7 of this subchapter).

(2) A package or unit of military explosives (including ammunition) shipped by or on behalf of the DOD when in—

(i) Freight containerload, carload or truckload shipments, if loaded and unloaded by the shipper or DOD; or

(ii) Unitized or palletized break-bulk shipments by cargo vessel under charter to DOD if at least one required label is displayed on each unitized or palletized load.

(3) A package containing a hazardous material other than ammunition that is—

(i) Loaded and unloaded under the supervision of DOD personnel, and

(ii) Escorted by DOD personnel in a separate vehicle.

(4) A compressed gas cylinder permanently mounted in or on a transport vehicle.

(5) A freight container, aircraft unit load device or portable tank, which—

(i) Is placarded in accordance with subpart F of this part, or

(ii) Conforms to paragraph (a)(3) or (b)(3) of § 172.512.

(6) An overpack or unit load device in or on which labels representative of each hazardous material in the overpack or unit load device are visible.

(7) A package of low specific activity radioactive material and surface contaminated objects, when transported under § 173.427(a)(6)(vi) of this subchapter.

(b) Certain exceptions to labeling requirements are provided for small

§ 172.401

49 CFR Ch. I (10–1–14 Edition)

quantities and limited quantities in applicable sections in part 173 of this subchapter.

(c) Notwithstanding the provisions of §172.402(a), a Division 6.1 subsidiary hazard label is not required on a package containing a Class 8 (corrosive) material which has a subsidiary hazard of Division 6.1 (poisonous) if the toxicity of the material is based solely on the corrosive destruction of tissue rather than systemic poisoning. In addition, a Division 4.1 subsidiary hazard label is not required on a package bearing a Division 4.2 label.

(d) A package containing a material poisonous by inhalation (see §171.8 of this subchapter) in a closed transport vehicle or freight container may be excepted from the POISON INHALATION HAZARD or POISON GAS label or placard, under the conditions set forth in §171.23(b)(10) of this subchapter.

[Amdt. 172–123, 55 FR 52594, Dec. 21, 1990]

EDITORIAL NOTE: For FEDERAL REGISTER citations affecting §172.400a, see the List of CFR Sections Affected, which appears in the Finding Aids section of the printed volume and on GPO Access.

§ 172.401 Prohibited labeling.

(a) Except as otherwise provided in this section, no person may offer for transportation and no carrier may transport a package bearing a label specified in this subpart unless:

(1) The package contains a material that is a hazardous material, and

(2) The label represents a hazard of the hazardous material in the package.

(b) No person may offer for transportation and no carrier may transport a package bearing any marking or label which by its color, design, or shape could be confused with or conflict with a label prescribed by this part.

(c) The restrictions in paragraphs (a) and (b) of this section, do not apply to packages labeled in conformance with:

(1) The UN Recommendations (IBR, see §171.7 of this subchapter);

(2) The IMDG Code (IBR, see §171.7 of this subchapter);

(3) The ICAO Technical Instructions (IBR, see §171.7 of this subchapter);

(4) The TDG Regulations (IBR, see §171.7 of this subchapter).

(5) The Globally Harmonized System of Classification and Labelling of

Chemicals (GHS) (IBR, see §171.7 of this subchapter).

(d) The provisions of paragraph (a) of this section do not apply to a packaging bearing a label if that packaging is:

(1) Unused or cleaned and purged of all residue;

(2) Transported in a transport vehicle or freight container in such a manner that the packaging is not visible during transportation; and

(3) Loaded by the shipper and unloaded by the shipper or consignee.

[Amdt. 172–9, 41 FR 15996, Apr. 15, 1976, as amended by Amdt. 172–75, 47 FR 44471, Oct. 7, 1982; Amdt. 172–77, 47 FR 54822, Dec. 6, 1982; Amdt. 172–94, 49 FR 38134, Sept. 27, 1984; Amdt. 172–100, 50 FR 41521, Oct. 11, 1985; Amdt. 172–123, 55 FR 52594, Dec. 21, 1990; Amdt. 172–132, 58 FR 50501, Sept. 27, 1993; 66 FR 8647, Feb. 1, 2001; 66 FR 45379, Aug. 28, 2001; 68 FR 75741, 75742, Dec. 31, 2003; 74 FR 2252, Jan. 14, 2009]

§ 172.402 Additional labeling requirements.

(a) *Subsidiary hazard labels.* Each package containing a hazardous material—

(1) Shall be labeled with primary and subsidiary hazard labels as specified in column 6 of the §172.101 table (unless excepted in paragraph (a)(2) of this section); and

(2) For other than Class 1 or Class 2 materials (for subsidiary labeling requirements for Class 1 or Class 2 materials see paragraph (e) or paragraphs (f) and (g), respectively, of this section), if not already labeled under paragraph (a)(1) of this section, shall be labeled with subsidiary hazard labels in accordance with the following table:

SUBSIDIARY HAZARD LABELS

Subsidiary hazard level (packing group)	Subsidiary Hazard (Class or Division)						
	3	4.1	4.2	4.3	5.1	6.1	8
I	X	***	***	X	X	X	X
II	X	X	X	X	X	X	X
III	*	X	X	X	X	X	X

X—Required for all modes.
 *—Required for all modes, except for a material with a flash point at or above 38 °C (100 °F) transported by rail or highway.
 ***—Reserved
 —Impossible as subsidiary hazard.

(b) *Display of hazard class on labels.* The appropriate hazard class or division number must be displayed in the

lower corner of a primary hazard label and a subsidiary hazard label.

(c) *Cargo Aircraft Only label.* Each person who offers for transportation or transports by aircraft a package containing a hazardous material which is authorized on cargo aircraft only shall label the package with a CARGO AIRCRAFT ONLY label specified in §172.448 of this subpart.

(d) *Class 7 (Radioactive) Materials.* Except as otherwise provided in this paragraph, each package containing a Class 7 material that also meets the definition of one or more additional hazard classes must be labeled as a Class 7 material as required by §172.403 and for each additional hazard.

(1) A subsidiary label is not required for a package containing material that satisfies all of the criteria in §173.4, §173.4a, or §173.4b applicable to the subsidiary hazard class.

(2) Each package or overpack containing fissile material, other than fissile-excepted material (see §173.453 of this subchapter) must bear two FISSILE labels, affixed to opposite sides of the package or overpack, which conforms to the figure shown in §172.441; such labels, where applicable, must be affixed adjacent to the labels for radioactive materials.

(e) *Class 1 (explosive) Materials.* In addition to the label specified in column 6 of the §172.101 table, each package of Class 1 material that also meets the definition for:

(1) Division 6.1, Packing Groups I or II, shall be labeled POISON or POISON INHALATION HAZARD, as appropriate.

(2) Class 7, shall be labeled in accordance with §172.403 of this subpart.

(f) *Division 2.2 materials.* In addition to the label specified in column 6 of the §172.101 table, each package of Division 2.2 material that also meets the definition for an oxidizing gas (see §171.8 of

this subchapter) must be labeled OXIDIZER.

(g) *Division 2.3 materials.* In addition to the label specified in column 6 of the §172.101 table, each package of Division 2.3 material that also meets the definition for:

(1) Division 2.1, must be labeled Flammable Gas;

(2) Division 5.1, must be labeled Oxidizer; and

(3) Class 8, must be labeled Corrosive.

[Amdt. 172-123, 55 FR 52594, Dec. 21, 1990, as amended at 56 FR 66255, Dec. 20, 1991; Amdt. 172-139, 59 FR 67490, Dec. 29, 1994; Amdt. 172-140, 60 FR 26805, May 18, 1995; Amdt. 172-149, 61 FR 27173, May 30, 1996; 62 FR 39405, July 22, 1997; 66 FR 33425, June 21, 2001; 69 FR 3668, Jan. 26, 2004; 74 FR 2252, Jan. 14, 2009; 76 FR 56314, Sept. 13, 2011; 79 FR 40609, July 11, 2014]

§ 172.403 Class 7 (radioactive) material.

(a) Unless excepted from labeling by §§173.421 through 173.427 of this subchapter, each package of radioactive material must be labeled as provided in this section.

(b) The proper label to affix to a package of Class 7 (radioactive) material is based on the radiation level at the surface of the package and the transport index. The proper category of label must be determined in accordance with paragraph (c) of this section. The label to be applied must be the highest category required for any of the two determining conditions for the package. RADIOACTIVE WHITE-I is the lowest category and RADIOACTIVE YELLOW-III is the highest. For example, a package with a transport index of 0.8 and a maximum surface radiation level of 0.6 millisievert (60 millirems) per hour must bear a RADIOACTIVE YELLOW-III label.

(c) Category of label to be applied to Class 7 (radioactive) materials packages:

Transport index	Maximum radiation level at any point on the external surface	Label category ¹
0 ²	Less than or equal to 0.005 mSv/h (0.5 mrem/h).	WHITE-I.
More than 0 but not more than 1	Greater than 0.005 mSv/h (0.5 mrem/h) but less than or equal to 0.5 mSv/h (50 mrem/h).	YELLOW-II.
More than 1 but not more than 10	Greater than 0.5 mSv/h (50 mrem/h) but less than or equal to 2 mSv/h (200 mrem/h).	YELLOW-III.

Transport index	Maximum radiation level at any point on the external surface	Label category ¹
More than 10	Greater than 2 mSv/h (200 mrem/h) but less than or equal to 10 mSv/h (1,000 mrem/h).	YELLOW-III (Must be shipped under exclusive use provisions; see 173.441(b) of this subchapter).

¹Any package containing a “highway route controlled quantity” (§ 173.403 of this subchapter) must be labelled as RADIOACTIVE YELLOW-III.

²If the measured TI is not greater than 0.05, the value may be considered to be zero.

(d) *EMPTY label.* See §173.428(e) of this subchapter for EMPTY labeling requirements.

(e) *FISSILE label.* For packages required in §172.402 to bear a FISSILE label, each such label must be completed with the criticality safety index (CSI) assigned in the NRC or DOE package design approval, or in the certificate of approval for special arrangement or the certificate of approval for the package design issued by the Competent Authority for import and export shipments. For overpacks and freight containers required in §172.402 to bear a FISSILE label, the CSI on the label must be the sum of the CSIs for all of the packages contained in the overpack or freight container.

(f) Each package required by this section to be labeled with a RADIOACTIVE label must have two of these labels, affixed to opposite sides of the package. (See §172.406(e)(3) for freight container label requirements).

(g) The following applicable items of information must be entered in the blank spaces on the RADIOACTIVE label by legible printing (manual or mechanical), using a durable weather resistant means of marking:

(1) *Contents.* Except for LSA-1 material, the names of the radionuclides as taken from the listing of radionuclides in §173.435 of this subchapter (symbols which conform to established radiation protection terminology are authorized, *i.e.*, ⁹⁹Mo, ⁶⁰Co, etc.). For mixtures of radionuclides, with consideration of space available on the label, the radionuclides that must be shown must be determined in accordance with §173.433(g) of this subchapter. For LSA-I material, the term “LSA-I” may be used in place of the names of the radionuclides.

(2) *Activity.* The maximum activity of the radioactive contents in the package during transport must be expressed in appropriate SI units (*e.g.*, Becquerels

(Bq), Terabecquerels (TBq)). The activity may also be stated in appropriate customary units (*e.g.*, Curies (Ci), milliCuries (mCi), microCuries (uCi)) in parentheses following the SI units. Abbreviations are authorized. Except for plutonium-239 and plutonium-241, the weight in grams or kilograms of fissile radionuclides (or the mass of each fissile nuclide for mixtures when appropriate) may be inserted instead of activity units. For plutonium-239 and plutonium-241, the weight in grams of fissile radionuclides (or the mass of each fissile nuclide for mixtures when appropriate) may be inserted in addition to the activity units.

(3) *Transport index.* (see §173.403 of this subchapter.)

(h) When one or more packages of Class 7 (radioactive) material are placed within an overpack, the overpack must be labeled as prescribed in this section, except as follows:

(1) The “contents” entry on the label may state “mixed” in place of the names of the radionuclides unless each inside package contains the same radionuclide(s).

(2) The “activity” entry on the label must be determined by adding together the number of becquerels of the Class 7 (radioactive) materials packages contained therein.

(3) For an overpack, the transport index (TI) must be determined by adding together the transport indices of the Class 7 (radioactive) materials packages contained therein, except that for a rigid overpack, the transport index (TI) may alternatively be determined by direct measurement as prescribed in §173.403 of this subchapter under the definition for “transport index,” taken by the person initially offering the packages contained within the overpack for shipment.

(4) The category of Class 7 label for the overpack must be determined from

the table in §172.403(c) using the TI derived according to paragraph (h)(3) of this section, and the maximum radiation level on the surface of the overpack.

(5) The category of the Class 7 label of the overpack, and not that of any of the packages contained therein, must be used in accordance with Table 1 of §172.504(e) to determine when the transport vehicle must be placarded.

(6) For fissile material, the criticality safety index which must be entered on the overpack FISSILE label is the sum of the criticality safety indices of the individual packages in the overpack, as stated in the certificate of approval for the package design issued by the NRC or the U.S. Competent Authority.

[Amdt. 172-29, 41 FR 15996, Apr. 15, 1976]

EDITORIAL NOTE: For FEDERAL REGISTER citations affecting §172.403, see the List of CFR Sections Affected, which appears in the Finding Aids section of the printed volume and at www.fdsys.gov.

§ 172.404 Labels for mixed and consolidated packaging.

(a) *Mixed packaging.* When compatible hazardous materials having different hazard classes are packed within the same packaging, or within the same outside container or overpack as described in §173.25, the packaging, outside container or overpack must be labeled as required for each class of hazardous material contained therein.

(b) *Consolidated packaging.* When two or more packages containing compatible hazardous materials are placed within the same outside container or overpack, the outside container or overpack must be labeled as required for each class of hazardous material contained therein, unless labels representative of each hazardous material in the outside container or overpack are visible.

(c) *Consolidation bins used by a single motor carrier.* Notwithstanding the provisions of paragraph (b) of this section, labeling of a consolidation bin is not required under the following conditions:

(1) The consolidation bin must be reusable, made of materials such as plastic, wood, or metal and must have a capacity of 64 cubic feet or less;

(2) Hazardous material packages placed in the consolidation bin must be properly labeled in accordance with this subpart;

(3) Packages must be compatible as specified in §177.848 of this subchapter;

(4) Packages may only be placed within the consolidation bin and the bin be loaded on a motor vehicle by an employee of a single motor carrier;

(5) Packages must be secured within the consolidation bin by other packages or by other suitable means in such a manner as to prevent shifting of, or significant relative motion between, the packages that would likely compromise the integrity of any package;

(6) The consolidation bin must be clearly and legibly marked on a tag or fixed display device with an indication of each hazard class or division contained within the bin;

(7) The consolidation bin must be properly blocked and braced within the transport vehicle; and

(8) Consolidation bins may only be transported by a single motor carrier, or on railcars transporting such vehicles.

[76 FR 43527, July 20, 2011]

§ 172.405 Authorized label modifications.

(a) For Classes 1, 2, 3, 4, 5, 6, and 8, text indicating a hazard (for example FLAMMABLE LIQUID) is not required on a primary or subsidiary label.

(b) For a package containing Oxygen, compressed, or Oxygen, refrigerated liquid, the OXIDIZER label specified in §172.426 of this subpart, modified to display the word "OXYGEN" instead of "OXIDIZER", and the class number "2" instead of "5.1", may be used in place of the NON-FLAMMABLE GAS and OXIDIZER labels. Notwithstanding the provisions of paragraph (a) of this section, the word "OXYGEN" must appear on the label.

(c) For a package containing a Division 6.1, Packing Group III material, the POISON label specified in §172.430 may be modified to display the text "PG III" instead of "POISON" or

§ 172.406

“TOXIC” below the mid line of the label. Also see § 172.313(d).

[Amdt. 172-123, 55 FR 52594, Dec. 21, 1990, as amended at 56 FR 66255, Dec. 20, 1991; 57 FR 45458, Oct. 1, 1992; 64 FR 10776, Mar. 5, 1999; 66 FR 33425, June 21, 2001]

§ 172.406 Placement of labels.

(a) *General.* (1) Except as provided in paragraphs (b) and (e) of this section, each label required by this subpart must—

(i) Be printed on or affixed to a surface (other than the bottom) of the package or containment device containing the hazardous material; and

(ii) Be located on the same surface of the package and near the proper shipping name marking, if the package dimensions are adequate.

(2) Except as provided in paragraph (e) of this section, duplicate labeling is not required on a package or containment device (such as to satisfy redundant labeling requirements).

(b) *Exceptions.* A label may be printed on or placed on a securely affixed tag, or may be affixed by other suitable means to:

(1) A package that contains no radioactive material and which has dimensions less than those of the required label;

(2) A cylinder; and

(3) A package which has such an irregular surface that a label cannot be satisfactorily affixed.

(c) *Placement of multiple labels.* When primary and subsidiary hazard labels are required, they must be displayed next to each other. Placement conforms to this requirement if labels are within 150 mm (6 inches) of one another.

(d) *Contrast with background.* Each label must be printed on or affixed to a background of contrasting color, or must have a dotted or solid line outer border.

(e) *Duplicate labeling.* Generally, only one of each different required label must be displayed on a package. However, duplicate labels must be displayed on at least two sides or two ends (other than the bottom) of—

(1) Each package or overpack having a volume of 1.8 m³ (64 cubic feet) or more;

49 CFR Ch. I (10-1-14 Edition)

(2) Each non-bulk package containing a radioactive material;

(3) Each DOT 106 or 110 multi-unit tank car tank. Labels must be displayed on each end;

(4) Each portable tank of less than 3,785 L (1000 gallons) capacity;

(5) Each freight container or aircraft unit load device having a volume of 1.8 m³ (64 cubic feet) or more, but less than 18 m³ (640 cubic feet). One of each required label must be displayed on or near the closure; and

(6) An IBC having a volume of 1.8 m³ (64 cubic feet) or more.

(f) *Visibility.* A label must be clearly visible and may not be obscured by markings or attachments.

[Amdt. 172-123, 55 FR 52594, Dec. 21, 1990, as amended at 56 FR 66255, Dec. 20, 1991; Amdt. 172-130, 58 FR 51531, Oct. 1, 1993; 73 FR 4716, Jan. 28, 2008]

§ 172.407 Label specifications.

(a) *Durability.* Each label, whether printed on or affixed to a package, must be durable and weather resistant. A label on a package must be able to withstand, without deterioration or a substantial change in color, a 30-day exposure to conditions incident to transportation that reasonably could be expected to be encountered by the labeled package.

(b) *Design.* (1) Except for size and color, the printing, inner border, and symbol on each label must be as shown in §§ 172.411 through 172.448 of this subpart, as appropriate.

(2) The dotted line border shown on each label is not part of the label specification, except when used as an alternative for the solid line outer border to meet the requirements of § 172.406(d) of this subpart.

(c) *Size.* (1) Each diamond (square-on-point) label prescribed in this subpart must be at least 100 mm (3.9 inches) on each side with each side having a solid line inner border 5.0 to 6.3 mm (0.2 to 0.25 inches) from the edge.

(2) The CARGO AIRCRAFT ONLY label must be a rectangle measuring at least 110 mm (4.3 inches) in height by 120 mm (4.7 inches) in width. The words “CARGO AIRCRAFT ONLY” must be shown in letters measuring at least 6.3 mm (0.25 inches) in height.

(3) Except as otherwise provided in this subpart, the hazard class number, or division number, as appropriate, must be at least 6.3 mm (0.25 inches) and not greater than 12.7 mm (0.5 inches).

(4) When text indicating a hazard is displayed on a label, the label name must be shown in letters measuring at least 7.6 mm (0.3 inches) in height. For SPONTANEOUSLY COMBUSTIBLE or DANGEROUS WHEN WET labels, the words "Spontaneously" and "When Wet" must be shown in letters measuring at least 5.1 mm (0.2 inches) in height.

(5) The symbol on each label must be proportionate in size to that shown in the appropriate section of this subpart.

(d) *Color.* (1) The background color on each label must be as prescribed in §§172.411 through 172.448 of this subpart, as appropriate.

(2) The symbol, text, numbers, and border must be shown in black on a label except that—

(i) White may be used on a label with a one color background of green, red or blue.

(ii) White must be used for the text and class number for the CORROSIVE label.

(iii) White may be used for the symbol for the ORGANIC PEROXIDE label.

(3) Black and any color on a label must be able to withstand, without substantial change, a 72-hour fadeometer test (for a description of equipment designed for this purpose, see ASTM G 23-69 (1975) or ASTM G 26-70).

(4) (i) A color on a label, upon visual examination, must fall within the color tolerances—

(A) Displayed on color charts conforming to the technical specifications for charts set forth in table 1 or 2 in appendix A to this part; or

(B) For labels printed on packaging surfaces, specified in table 3 in appendix A to this part.

(ii) Color charts conforming to appendix A to this part are on display in Office of Hazardous Materials Safety, Office of Hazardous Materials Standards, Room 8422, Nassif Building, 400 Seventh Street, SW., Washington DC 20590-0001.

(5) The following color standards in the PANTONE® formula guide coated/uncoated (see §171.7(b) of this subchapter) may be used to achieve the required colors on markings and hazard warning labels and placards:

(i) For Red—Use PANTONE® 186 U

(ii) For Orange—Use PANTONE® 151 U

(iii) For Yellow—Use PANTONE® 109 U

(iv) For Green—Use PANTONE® 335 U

(v) For Blue—Use PANTONE® 285 U

(vi) For Purple—Use PANTONE® 259 U

(6) Where specific colors from the PANTONE MATCHING SYSTEM® are applied as opaque coatings, such as paint, enamel, or plastic, or where labels are printed directly on the surface of a packaging, a spectrophotometer or other instrumentation must be used to ensure a proper match with the color standards in the PANTONE® formula guide coated/uncoated for colors prescribed in paragraph (d)(5) of this section. PANTONE® is the property of Pantone, Inc.

(7) The specified label color must extend to the edge of the label in the area designated on each label, except for the CORROSIVE, RADIOACTIVE YELLOW-II, and RADIOACTIVE YELLOW-III labels on which the color must extend only to the inner border.

(e) *Form identification.* A label may contain form identification information, including the name of its maker, provided that information is printed outside the solid line inner border in no larger than 10-point type.

(f) *Exceptions.* Except for materials poisonous by inhalation (See §171.8 of this subchapter), a label conforming to specifications in the UN Recommendations (IBR, see §171.7 of this subchapter) may be used in place of a corresponding label that conforms to the requirements of this subpart.

(g) *Trefoil symbol.* The trefoil symbol on the RADIOACTIVE WHITE-I, RADIOACTIVE YELLOW-II, and RADIOACTIVE YELLOW-III labels must meet

§ 172.411

the appropriate specifications in appendix B of this part.

[Amdt. 172-123, 55 FR 52595, Dec. 21, 1990, as amended at 56 FR 66256, Dec. 20, 1991; Amdt. 172-143, 60 FR 50305, Sept. 28, 1995; 64 FR 10776, Mar. 5, 1999; 66 FR 8647, Feb. 1, 2001; 66 FR 44255, Aug. 22, 2001; 67 FR 61013, Sept. 27, 2002; 69 FR 64472, Nov. 4, 2004; 71 FR 78627, Dec. 29, 2006; 75 FR 72, Jan. 4, 2010; 78 FR 1073, Jan. 7, 2013]

§ 172.411 EXPLOSIVE 1.1, 1.2, 1.3, 1.4, 1.5 and 1.6 labels, and EXPLOSIVE Subsidiary label.

(a) Except for size and color, the EXPLOSIVE 1.1, EXPLOSIVE 1.2 and EXPLOSIVE 1.3 labels must be as follows:



(b) In addition to complying with §172.407, the background color on the EXPLOSIVE 1.1, EXPLOSIVE 1.2 and EXPLOSIVE 1.3 labels must be orange. The “**” must be replaced with the appropriate division number and compatibility group letter. The compatibility group letter must be the same size as the division number and must be shown as a capitalized Roman letter.

(c) Except for size and color, the EXPLOSIVE 1.4, EXPLOSIVE 1.5 and EXPLOSIVE 1.6 labels must be as follows:

49 CFR Ch. I (10-1-14 Edition)

EXPLOSIVE 1.4:



EXPLOSIVE 1.5:

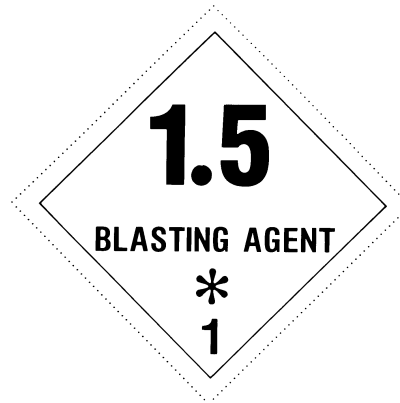

EXPLOSIVE 1.6:

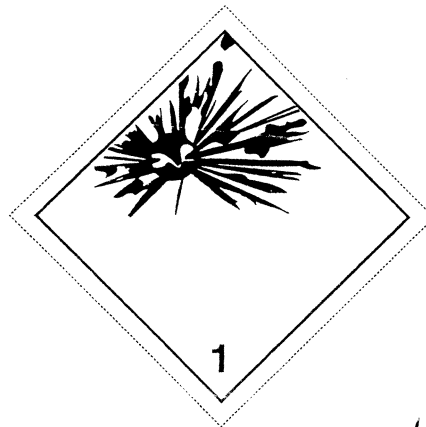

(d) In addition to complying with §172.407, the background color on the EXPLOSIVE 1.4, EXPLOSIVE 1.5 and EXPLOSIVE 1.6 label must be orange. The “*” must be replaced with the appropriate compatibility group. The compatibility group letter must be shown as a capitalized Roman letter. Division numbers must measure at least 30 mm (1.2 inches) in height and at least 5 mm (0.2 inches) in width.

(e) An EXPLOSIVE subsidiary label is required for materials identified in Column (6) of the HMT as having an explosive subsidiary hazard. The division number or compability group letter may be displayed on the subsidiary hazard label. Except for size and color, the EXPLOSIVE subsidiary label must be as follows:

(f) The EXPLOSIVE subsidiary label must comply with §172.407.

[Amdt. 172-123, 56 FR 66256, Dec. 20, 1991, as amended by Amdt. 172-139, 59 FR 67490, Dec. 29, 1994; 66 FR 33425, June 21, 2001; 68 FR 45031, July 31, 2003]

§ 172.415 NON-FLAMMABLE GAS label.

(a) Except for size and color, the NON-FLAMMABLE GAS label must be as follows:

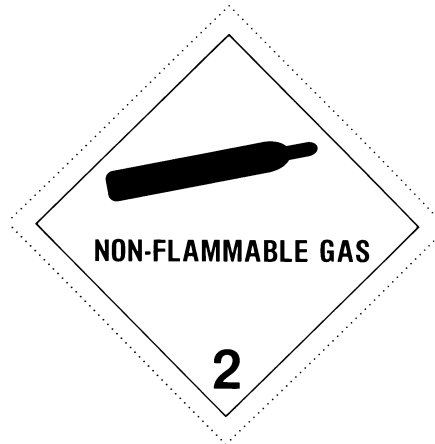

(b) In addition to complying with §172.407, the background color on the NON-FLAMMABLE GAS label must be green.

[Amdt. 172-123, 56 FR 66256, Dec. 20, 1991]

§ 172.416

§ 172.416 POISON GAS label.

(a) Except for size and color, the POISON GAS label must be as follows:



(b) In addition to complying with §172.407, the background on the POISON GAS label and the symbol must be white. The background of the upper diamond must be black and the lower point of the upper diamond must be 14 mm (0.54 inches) above the horizontal center line.

[62 FR 39405, July 22, 1997]

§ 172.417 FLAMMABLE GAS label.

(a) Except for size and color, the FLAMMABLE GAS label must be as follows:

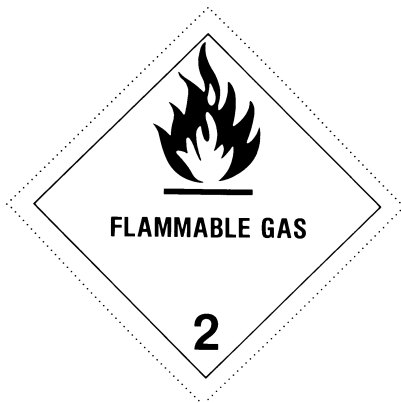

49 CFR Ch. I (10-1-14 Edition)

(b) In addition to complying with §172.407, the background color on the FLAMMABLE GAS label must be red.

[Amdt. 172-123, 56 FR 66257, Dec. 20, 1991]

§ 172.419 FLAMMABLE LIQUID label.

(a) Except for size and color the FLAMMABLE LIQUID label must be as follows:



(b) In addition to complying with §172.407, the background color on the FLAMMABLE LIQUID label must be red.

[Amdt. 172-123, 56 FR 66257, Dec. 20, 1991]

§ 172.420 FLAMMABLE SOLID label.

(a) Except for size and color, the FLAMMABLE SOLID label must be as follows:



(b) In addition to complying with §172.407, the background on the FLAMMABLE SOLID label must be white with vertical red stripes equally spaced on each side of a red stripe placed in the center of the label. The red vertical stripes must be spaced so that, visually, they appear equal in width to the white spaces between them. The symbol (flame) and text (when used) must be overprinted. The text "FLAMMABLE SOLID" may be placed in a white rectangle.

[Amdt. 172-123, 56 FR 66257, Dec. 20, 1991]

§ 172.422 SPONTANEOUSLY COMBUSTIBLE label.

(a) Except for size and color, the SPONTANEOUSLY COMBUSTIBLE label must be as follows:



(b) In addition to complying with §172.407, the background color on the lower half of the SPONTANEOUSLY COMBUSTIBLE label must be red and the upper half must be white.

[Amdt. 172-123, 56 FR 66257, Dec. 20, 1991, as amended at 57 FR 45458, Oct. 1, 1992]

§ 172.423 DANGEROUS WHEN WET label.

(a) Except for size and color, the DANGEROUS WHEN WET label must be as follows:



(b) In addition to complying with §172.407, the background color on the DANGEROUS WHEN WET label must be blue.

[Amdt. 172-123, 56 FR 66257, Dec. 20, 1991]

§ 172.426 OXIDIZER label.

(a) Except for size and color, the OXIDIZER label must be as follows:



(b) In addition to complying with §172.407, the background color on the OXIDIZER label must be yellow.

[Amdt. 172-123, 56 FR 66257, Dec. 20, 1991]

§ 172.427 ORGANIC PEROXIDE label.

(a) Except for size and color, the ORGANIC PEROXIDE label must be as follows:



(b) In addition to complying with §172.407, the background on the ORGANIC PEROXIDE label must be red in the top half and yellow in the lower half.

[71 FR 78627, Dec. 29, 2006]

§ 172.429 POISON INHALATION HAZARD label.

(a) Except for size and color, the POISON INHALATION HAZARD label must be as follows:



(b) In addition to complying with §172.407, the background on the POISON INHALATION HAZARD label and the symbol must be white. The background of the upper diamond must be black and the lower point of the upper diamond must be 14 mm (0.54 inches) above the horizontal center line.

[62 FR 39406, July 22, 1997]

§ 172.430 POISON label.

(a) Except for size and color, the POISON label must be as follows:

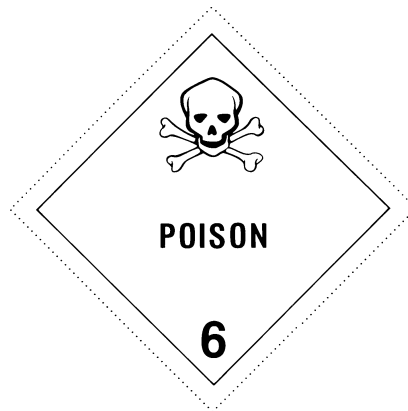

(b) In addition to complying with §172.407, the background on the POISON label must be white. The word "TOXIC" may be used in lieu of the word "POISON".

[Amdt. 172-123, 56 FR 66258, Dec. 20, 1991, as amended by Amdt. 172-139, 59 FR 67490, Dec. 29, 1994]

§ 172.431 [Reserved]

§ 172.432 INFECTIOUS SUBSTANCE label.

(a) Except for size and color, the INFECTIOUS SUBSTANCE label must be as follows:



(b) In addition to complying with §172.407, the background on the INFECTIOUS SUBSTANCE label must be white.

(c) Labels conforming to requirements in place on August 18, 2011 may

§ 172.436

continue to be used until October 1, 2014.

[Amdt. 172-123, 56 FR 66258, Dec. 20, 1991, as amended at 67 FR 53136, Aug. 14, 2002; 76 FR 43527, July 20, 2011; 76 FR 56314, Sept. 13, 2011; 76 FR 81400, Dec. 28, 2011]

§ 172.436 RADIOACTIVE WHITE-I label.

(a) Except for size and color, the RADIOACTIVE WHITE-I label must be as follows:



(b) In addition to complying with § 172.407, the background on the RADIOACTIVE WHITE-I label must be white. The printing and symbol must be black, except for the “I” which must be red.

[Amdt. 172-123, 56 FR 66259, Dec. 20, 1991]

§ 172.438 RADIOACTIVE YELLOW-II label.

(a) Except for size and color, the RADIOACTIVE YELLOW-II must be as follows:

49 CFR Ch. I (10-1-14 Edition)



(b) In addition to complying with § 172.407, the background color on the RADIOACTIVE YELLOW-II label must be yellow in the top half and white in the lower half. The printing and symbol must be black, except for the “II” which must be red.

[Amdt. 172-123, 56 FR 66259, Dec. 20, 1991]

§ 172.440 RADIOACTIVE YELLOW-III label.

(a) Except for size and color, the RADIOACTIVE YELLOW-III label must be as follows:



(b) In addition to complying with § 172.407, the background color on the RADIOACTIVE YELLOW-III label must be yellow in the top half and white in the lower half. The printing

and symbol must be black, except for the "III" which must be red.

[Amdt. 172-123, 56 FR 66259, Dec. 20, 1991]

§ 172.441 **FISSILE label.**

(a) Except for size and color, the FISSILE label must be as follows:

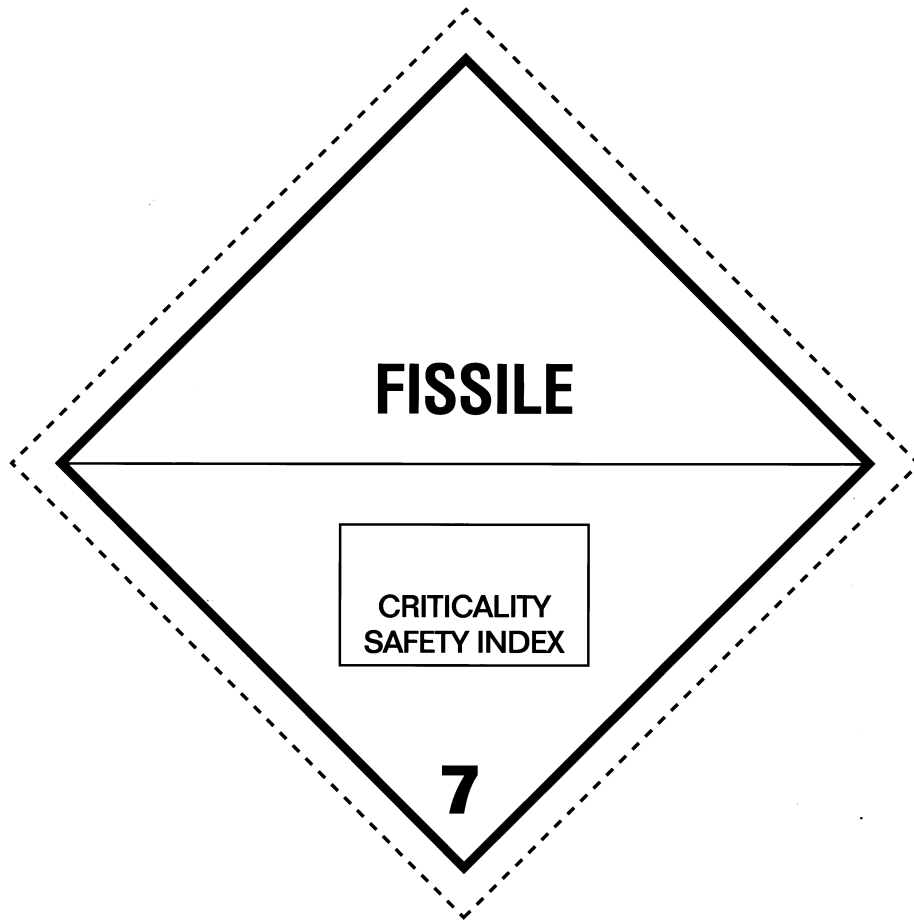

§ 172.442

(b) In addition to complying with §172.407, the background color on the FISSILE label must be white.

[69 FR 3669, Jan. 26, 2004]

§ 172.442 CORROSIVE label.

(a) Except for size and color, the CORROSIVE label must be as follows:

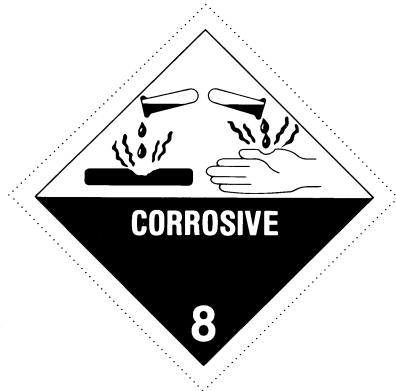

(b) In addition to complying with §172.407, the background on the CORROSIVE label must be white in the top half and black in the lower half.

[Amdt. 172-123, 56 FR 66259, Dec. 20, 1991]

§ 172.444 [Reserved]

§ 172.446 CLASS 9 label.

(a) Except for size and color, the "CLASS 9" (miscellaneous hazardous materials) label must be as follows:

49 CFR Ch. I (10-1-14 Edition)



(b) In addition to complying with §172.407, the background on the CLASS 9 label must be white with seven black vertical stripes on the top half. The black vertical stripes must be spaced, so that, visually, they appear equal in width to the six white spaces between them. The lower half of the label must be white with the class number "9" underlined and centered at the bottom. The solid horizontal line dividing the lower and upper half of the label is optional.

(c) Labels conforming to requirements in place on August 18, 2011 may continue to be used until October 1, 2014.

[Amdt. 172-123, 56 FR 66259, Dec. 20, 1991, as amended at 74 FR 2252, Jan. 14, 2009; 76 FR 43528, July 20, 2011; 76 FR 56314, Sept. 13, 2011; 76 FR 81400, Dec. 28, 2011]

§ 172.448 CARGO AIRCRAFT ONLY label.

(a) Except for size and color, the CARGO AIRCRAFT ONLY label must be as follows:



(b) The CARGO AIRCRAFT ONLY label must be black on an orange background.

(c) A CARGO AIRCRAFT ONLY label conforming to the specifications in this section and in §172.407(c)(2) in effect on October 1, 2008, may be used until January 1, 2013.

[74 FR 2252, Jan. 14, 2009, as amended at 75 FR 72, Jan. 4, 2010]

§ 172.450 EMPTY label.

(a) Each EMPTY label, except for size, must be as follows:

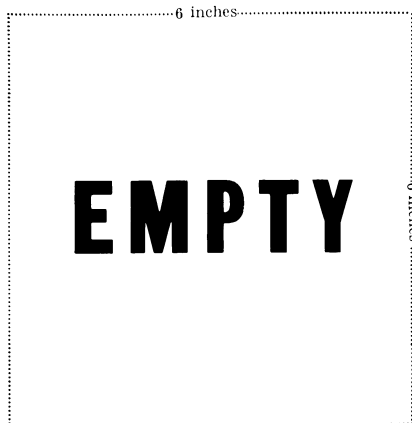

(1) Each side must be at least 6 inches (152 mm.) with each letter at least 1 inch (25.4 mm.) in height.

(2) The label must be white with black printing.

(b) [Reserved]

Subpart F—Placarding

§ 172.500 Applicability of placarding requirements.

(a) Each person who offers for transportation or transports any hazardous material subject to this subchapter shall comply with the applicable placarding requirements of this subpart.

(b) This subpart does not apply to—

- (1) Infectious substances;
- (2) Hazardous materials classed as ORM-D;

(3) Hazardous materials authorized by this subchapter to be offered for transportation as a limited quantity when identified as such on a shipping paper in accordance with §172.203(b) or when marked as such in accordance with §172.315.

(4) Hazardous materials prepared in accordance with §173.13 of this subchapter;

(5) Hazardous materials which are packaged as small quantities under the provisions of §§173.4, 173.4a, 173.4b of this subchapter; and

§ 172.502

(6) Combustible liquids in non-bulk packagings.

[Amdt. 172-123, 55 FR 52599, Dec. 21, 1990, as amended by Amdt. 172-149, 61 FR 27173, May 30, 1996; 74 FR 2253, Jan. 14, 2009; 76 FR 3367, Jan. 19, 2011]

§ 172.502 Prohibited and permissive placarding.

(a) *Prohibited placarding.* Except as provided in paragraph (b) of this section, no person may affix or display on a packaging, freight container, unit load device, motor vehicle or rail car—

(1) Any placard described in this subpart unless—

(i) The material being offered or transported is a hazardous material;

(ii) The placard represents a hazard of the hazardous material being offered or transported; and

(iii) Any placarding conforms to the requirements of this subpart.

(2) Any sign, advertisement, slogan (such as “Drive Safely”), or device that, by its color, design, shape or content, could be confused with any placard prescribed in this subpart.

(b) *Exceptions.* (1) The restrictions in paragraph (a) of this section do not apply to a bulk packaging, freight container, unit load device, transport vehicle or rail car which is placarded in conformance with TDG Regulations, the IMDG Code or the UN Recommendations (IBR, see §171.7 of this subchapter).

(2) The restrictions of paragraph (a) of this section do not apply to the display of a BIOHAZARD marking, a “HOT” marking, a sour crude oil hazard marking, or an identification number on a white square-on-point configuration in accordance with §172.323(c), §172.325(c), §172.327(a), or §172.336(b) of this part, respectively.

(3) The restrictions in paragraph (a)(2) of this section do not apply until October 1, 2001 to a safety sign or safety slogan (e.g., “Drive Safely” or “Drive Carefully”), which was permanently marked on a transport vehicle, bulk packaging, or freight container on or before August 21, 1997.

(c) *Permissive placarding.* Placards may be displayed for a hazardous material, even when not required, if the

49 CFR Ch. I (10-1-14 Edition)

placarding otherwise conforms to the requirements of this subpart.

[Amdt. 172-123, 55 FR 52599, Dec. 21, 1990, as amended at 56 FR 66259, Dec. 20, 1991; Amdt. 172-151, 62 FR 1230, Jan. 8, 1997; 62 FR 39389 and 39407, July 22, 1997; 66 FR 8647, Feb. 1, 2001; 66 FR 33426, June 21, 2001; 67 FR 53137, Aug. 14, 2002; 68 FR 75741, Dec. 31, 2003; 76 FR 3367, Jan. 19, 2011]

§ 172.503 Identification number display on placards.

For procedures and limitations pertaining to the display of identification numbers on placards, see §172.334.

[Amdt. 172-58, 45 FR 34701, May 22, 1980]

§ 172.504 General placarding requirements.

(a) *General.* Except as otherwise provided in this subchapter, each bulk packaging, freight container, unit load device, transport vehicle or rail car containing any quantity of a hazardous material must be placarded on each side and each end with the type of placards specified in tables 1 and 2 of this section and in accordance with other placarding requirements of this subpart, including the specifications for the placards named in the tables and described in detail in §§172.519 through 172.560.

(b) *DANGEROUS placard.* A freight container, unit load device, transport vehicle, or rail car which contains non-bulk packages with two or more categories of hazardous materials that require different placards specified in table 2 of paragraph (e) of this section may be placarded with a DANGEROUS placard instead of the separate placarding specified for each of the materials in table 2 of paragraph (e) of this section. However, when 1,000 kg (2,205 pounds) aggregate gross weight or more of one category of material is loaded therein at one loading facility on a freight container, unit load device, transport vehicle, or rail car, the placard specified in table 2 of paragraph (e) of this section for that category must be applied.

(c) *Exception for less than 454 kg (1,001 pounds).* Except for bulk packagings and hazardous materials subject to §172.505, when hazardous materials covered by table 2 of this section are

transported by highway or rail, placards are not required on—

(1) A transport vehicle or freight container which contains less than 454 kg (1001 pounds) aggregate gross weight of hazardous materials covered by table 2 of paragraph (e) of this section; or

(2) A rail car loaded with transport vehicles or freight containers, none of which is required to be placarded.

The exceptions provided in paragraph (c) of this section do not prohibit the display of placards in the manner prescribed in this subpart, if not otherwise

prohibited (see §172.502), on transport vehicles or freight containers which are not required to be placarded.

(d) *Exception for empty non-bulk packages.* Except for hazardous materials subject to §172.505, a non-bulk packaging that contains only the residue of a hazardous material covered by Table 2 of paragraph (e) of this section need not be included in determining placarding requirements.

(e) *Placarding tables.* Placards are specified for hazardous materials in accordance with the following tables:

TABLE 1

Category of material (Hazard class or division number and additional description, as appropriate)	Placard name	Placard design section reference (§)
1.1	EXPLOSIVES 1.1	172.522
1.2	EXPLOSIVES 1.2	172.522
1.3	EXPLOSIVES 1.3	172.522
2.3	POISON GAS	172.540
4.3	DANGEROUS WHEN WET	172.548
5.2 (Organic peroxide, Type B, liquid or solid, temperature controlled).	ORGANIC PEROXIDE	172.552
6.1 (material poisonous by inhalation (see § 171.8 of this subchapter)).	POISON INHALATION HAZARD	172.555
7 (Radioactive Yellow III label only)	RADIOACTIVE ¹	172.556

¹ RADIOACTIVE placards are also required for: All shipments of unpackaged LSA-I material or SCO-I; all shipments required by §§ 173.427, 173.441, and 173.457 of this subchapter to be operated under exclusive use; and all closed vehicles used in accordance with § 173.443(d).

TABLE 2

Category of material (Hazard class or division number and additional description, as appropriate)	Placard name	Placard design section reference (§)
1.4	EXPLOSIVES 1.4	172.523
1.5	EXPLOSIVES 1.5	172.524
1.6	EXPLOSIVES 1.6	172.525
2.1	FLAMMABLE GAS	172.532
2.2	NON-FLAMMABLE GAS	172.528
3	FLAMMABLE	172.542
Combustible liquid	COMBUSTIBLE	172.544
4.1	FLAMMABLE SOLID	172.546
4.2	SPONTANEOUSLY COMBUSTIBLE	172.547
5.1	OXIDIZER	172.550
5.2 (Other than organic peroxide, Type B, liquid or solid, temperature controlled).	ORGANIC PEROXIDE	172.552
6.1 (other than material poisonous by inhalation)	POISON	172.554
6.2	(None)	
8	CORROSIVE	172.558
9	Class 9 (see § 172.504(f)(9))	172.560
ORM-D	(None)	

(f) *Additional placarding exceptions.* (1) When more than one division placard is required for Class 1 materials on a transport vehicle, rail car, freight container or unit load device, only the placard representing the lowest division number must be displayed.

(2) A FLAMMABLE placard may be used in place of a COMBUSTIBLE placard on—

- (i) A cargo tank or portable tank.
- (ii) A compartmented tank car which contains both flammable and combustible liquids.

§ 172.505

49 CFR Ch. I (10–1–14 Edition)

(3) A NON-FLAMMABLE GAS placard is not required on a transport vehicle which contains non-flammable gas if the transport vehicle also contains flammable gas or oxygen and it is placarded with FLAMMABLE GAS or OXYGEN placards, as required.

(4) OXIDIZER placards are not required for Division 5.1 materials on freight containers, unit load devices, transport vehicles or rail cars which also contain Division 1.1 or 1.2 materials and which are placarded with EXPLOSIVES 1.1 or 1.2 placards, as required.

(5) For transportation by transport vehicle or rail car only, an OXIDIZER placard is not required for Division 5.1 materials on a transport vehicle, rail car or freight container which also contains Division 1.5 explosives and is placarded with EXPLOSIVES 1.5 placards, as required.

(6) The EXPLOSIVE 1.4 placard is not required for those Division 1.4 Compatibility Group S (1.4S) materials that are not required to be labeled 1.4S.

(7) For domestic transportation of oxygen, compressed or oxygen, refrigerated liquid, the OXYGEN placard in §172.530 of this subpart may be used in place of a NON-FLAMMABLE GAS placard.

(8) For domestic transportation, a POISON INHALATION HAZARD placard is not required on a transport vehicle or freight container that is already placarded with the POISON GAS placard.

(9) For Class 9, a CLASS 9 placard is not required for domestic transportation, including that portion of international transportation, defined in §171.8 of this subchapter, which occurs within the United States. However, a bulk packaging must be marked with the appropriate identification number on a CLASS 9 placard, an orange panel, or a white square-on-point display configuration as required by subpart D of this part.

(10) For Division 6.1, PG III materials, a POISON placard may be modified to display the text “PG III” below the mid line of the placard.

(11) For domestic transportation, a POISON placard is not required on a transport vehicle or freight container required to display a POISON INHALA-

TION HAZARD or POISON GAS placard.

(g) For shipments of Class 1 (explosive materials) by aircraft or vessel, the applicable compatibility group letter must be displayed on the placards, or labels when applicable, required by this section. When more than one compatibility group placard is required for Class 1 materials, only one placard is required to be displayed, as provided in paragraphs (g)(1) through (g)(4) of this section. For the purposes of paragraphs (g)(1) through (g)(4), there is a distinction between the phrases *explosive articles* and *explosive substances*. *Explosive article* means an article containing an explosive substance; examples include a detonator, flare, primer or fuse. *Explosive substance* means a substance contained in a packaging that is not contained in an article; examples include black powder and smokeless powder.

(1) Explosive articles of compatibility groups C, D or E may be placarded displaying compatibility group E.

(2) Explosive articles of compatibility groups C, D, or E, when transported with those in compatibility group N, may be placarded displaying compatibility group D.

(3) Explosive substances of compatibility groups C and D may be placarded displaying compatibility group D.

(4) Explosive articles of compatibility groups C, D, E or G, except for fireworks, may be placarded displaying compatibility group E.

[Amdt. 172–123, 55 FR 52600, Dec. 21, 1990]

EDITORIAL NOTE: For FEDERAL REGISTER citations affecting §172.504, see the List of CFR Sections Affected, which appears in the Finding Aids section of the printed volume and at www.fdsys.gov.

§ 172.505 Placarding for subsidiary hazards.

(a) Each transport vehicle, freight container, portable tank, unit load device, or rail car that contains a poisonous material subject to the “Poison Inhalation Hazard” shipping description of §172.203(m) must be placarded with a POISON INHALATION HAZARD or POISON GAS placard, as appropriate, on each side and each end, in

addition to any other placard required for that material in §172.504. Duplication of the POISON INHALATION HAZARD or POISON GAS placard is not required.

(b) In addition to the RADIOACTIVE placard which may be required by §172.504(e) of this subpart, each transport vehicle, portable tank or freight container that contains 454 kg (1,001 pounds) or more gross weight of non-fissile, fissile-excepted, or fissile uranium hexafluoride must be placarded with a CORROSIVE placard on each side and each end.

(c) Each transport vehicle, portable tank, freight container or unit load device that contains a material which has a subsidiary hazard of being dangerous when wet, as defined in §173.124 of this subchapter, shall be placarded with DANGEROUS WHEN WET placards, on each side and each end, in addition to the placards required by §172.504.

(d) Hazardous materials that possess secondary hazards may exhibit subsidiary placards that correspond to the placards described in this part, even when not required by this part (see also §172.519(b) (4) of this subpart).

[Amdt. 172-123, 55 FR 52601, Dec. 21, 1990, as amended at 56 FR 66260, Dec. 20, 1991; 57 FR 45460, Oct. 1, 1992; Amdt. 172-127, 59 FR 49133, Sept. 26, 1994; Amdt. 172-151, 62 FR 1231, Jan. 8, 1997; 62 FR 39398, July 22, 1997; 65 FR 58626, Sept. 29, 2000; 72 FR 55692, Oct. 1, 2007; 79 FR 40610, July 11, 2014]

§ 172.506 Providing and affixing placards: Highway.

(a) Each person offering a motor carrier a hazardous material for transportation by highway shall provide to the motor carrier the required placards for the material being offered prior to or at the same time the material is offered for transportation, unless the carrier's motor vehicle is already placarded for the material as required by this subpart.

(1) No motor carrier may transport a hazardous material in a motor vehicle, unless the placards required for the hazardous material are affixed thereto as required by this subpart.

(2) [Reserved]

(b) [Reserved]

[Amdt. 172-29, 41 FR 15996, Apr. 15, 1976, as amended by Amdt. 172-29A, 41 FR 40679, Sept. 20, 1976]

§ 172.507 Special placarding provisions: Highway.

(a) Each motor vehicle used to transport a package of highway route controlled quantity Class 7 (radioactive) materials (see §173.403 of this subchapter) must have the required RADIOACTIVE warning placard placed on a square background as described in §172.527.

(b) A nurse tank, meeting the provisions of §173.315(m) of this subchapter, is not required to be placarded on an end containing valves, fittings, regulators or gauges when those appurtenances prevent the markings and placard from being properly placed and visible.

[Amdt. 172-103, 51 FR 5971, Feb. 18, 1986, as amended by Amdt. 172-143, 60 FR 50305, Sept. 28, 1995]

§ 172.508 Placarding and affixing placards: Rail.

(a) Each person offering a hazardous material for transportation by rail shall affix to the rail car containing the material, the placards specified by this subpart. Placards displayed on motor vehicles, transport containers, or portable tanks may be used to satisfy this requirement, if the placards otherwise conform to the provisions of this subpart.

(b) No rail carrier may accept a rail car containing a hazardous material for transportation unless the placards for the hazardous material are affixed thereto as required by this subpart.

[Amdt. 172-29, 41 FR 15996, Apr. 15, 1976, as amended by Amdt. 172-123, 55 FR 52601, Dec. 21, 1990]

§ 172.510 Special placarding provisions: Rail.

(a) *White square background.* The following must have the specified placards placed on a white square background, as described in §172.527:

(1) Division 1.1 and 1.2 (explosive) materials which require EXPLOSIVES 1.1 or EXPLOSIVES 1.2 placards affixed to the rail car;

§ 172.512

49 CFR Ch. I (10–1–14 Edition)

(2) Materials classed in Division 2.3 Hazard Zone A or 6.1 Packing Group I Hazard Zone A which require POISON GAS or POISON placards affixed to the rail car, including tank cars containing only a residue of the material; and

(3) Class DOT 113 tank cars used to transport a Division 2.1 (flammable gas) material, including tank cars containing only a residue of the material.

(b) *Chemical ammunition.* Each rail car containing Division 1.1 or 1.2 (explosive) ammunition which also meets the definition of a material poisonous by inhalation (see §171.8 of this subchapter) must be placarded EXPLOSIVES 1.1 or EXPLOSIVES 1.2 and POISON GAS or POISON INHALATION HAZARD.

[Amdt. 172–29, 41 FR 15996, Apr. 15, 1976, as amended by Amdt. 172–103, 51 FR 5971, Feb. 18, 1986; Amdt. 172–110, 52 FR 29528, Aug. 10, 1987; Amdt. 172–111, 52 FR 36671, Sept. 30, 1987; Amdt. 172–123, 55 FR 52601, Dec. 21, 1990; 56 FR 66260, Dec. 20, 1991; 57 FR 45460, Oct. 1, 1992; Amdt. 172–248, 61 FR 28676, June 5, 1996; Amdt. 172–151, 62 FR 1231, Jan. 8, 1997; 62 FR 39398, July 22, 1997]

§ 172.512 Freight containers and aircraft unit load devices.

(a) *Capacity of 640 cubic feet or more.* Each person who offers for transportation, and each person who loads and transports, a hazardous material in a freight container or aircraft unit load device having a capacity of 640 cubic feet or more shall affix to the freight container or aircraft unit load device the placards specified for the material in accordance with §172.504. However:

(1) The placarding exception provided in §172.504(c) applies to motor vehicles transporting freight containers and aircraft unit load devices,

(2) The placarding exception provided in §172.504(c) applies to each freight container and aircraft unit load device being transported for delivery to a consignee immediately following an air or water shipment, and,

(3) Placarding is not required on a freight container or aircraft unit load device if it is only transported by air and is identified as containing a hazardous material in the manner provided in part 7, chapter 2, section 2.7, of the ICAO Technical Instructions (IBR, see §171.7 of this subchapter).

(b) *Capacity less than 18 m³ (640 cubic feet).* (1) Each person who offers for transportation by air, and each person who loads and transports by air, a hazardous material in a freight container or aircraft unit load device having a capacity of less than 18 m³ (640 cubic feet) shall affix one placard of the type specified by paragraph (a) of this section unless the freight container or aircraft unit load device:

(i) Is labeled in accordance with subpart E of this part, including §172.406(e);

(ii) Contains radioactive materials requiring the Radioactive Yellow III label and is placarded with one Radioactive placard and is labeled in accordance with subpart E of this part, including §172.406(e); or,

(iii) Is identified as containing a hazardous material in the manner provided in part 7; chapter 2, section 2.8, of the ICAO Technical Instructions (IBR, see §171.7 of this subchapter).

(2) When hazardous materials are offered for transportation, not involving air transportation, in a freight container having a capacity of less than 640 cubic feet the freight container need not be placarded. However, if not placarded, it must be labeled in accordance with subpart E of this part.

(c) Notwithstanding paragraphs (a) and (b) of this section, packages containing hazardous materials, other than ORM-D, offered for transportation by air in freight containers are subject to the inspection requirements of §175.30 of this chapter.

[Amdt. 172–29, 41 FR 15996, Apr. 15, 1976, as amended by Amdt. 172–29A, 41 FR 40680, Sept. 20, 1976; Amdt. 172–87, 48 FR 53712, Nov. 29, 1983; 48 FR 55469, Dec. 13, 1983; Amdt. 172–103, 51 FR 5971, Feb. 18, 1986; Amdt. 172–111, 52 FR 36671, Sept. 30, 1987; Amdt. 172–123, 55 FR 52601, Dec. 21, 1990; 66 FR 33426, June 21, 2001; 66 FR 45182, Aug. 28, 2001; 68 FR 75741, Dec. 31, 2003; 69 FR 54046, Sept. 7, 2004; 76 FR 56314, Sept. 13, 2011; 78 FR 60753, Oct. 2, 2013]

§ 172.514 Bulk packagings.

(a) Except as provided in paragraph (c) of this section, each person who offers for transportation a bulk packaging which contains a hazardous material, shall affix the placards specified for the material in §§172.504 and 172.505.

(b) Each bulk packaging that is required to be placarded when it contains

a hazardous material, must remain placarded when it is emptied, unless it—

(1) Is sufficiently cleaned of residue and purged of vapors to remove any potential hazard;

(2) Is refilled, with a material requiring different placards or no placards, to such an extent that any residue remaining in the packaging is no longer hazardous; or

(3) Contains the residue of a hazardous substance in Class 9 in a quantity less than the reportable quantity, and conforms to §173.29(b)(1) of this subchapter.

(c) Exceptions. The following packagings may be placarded on only two opposite sides or, alternatively, may be labeled instead of placarded in accordance with subpart E of this part:

(1) A portable tank having a capacity of less than 3,785 L (1000 gallons);

(2) A DOT 106 or 110 multi-unit tank car tank;

(3) A bulk packaging other than a portable tank, cargo tank, or tank car (*e.g.*, a bulk bag or box) with a volumetric capacity of less than 18 cubic meters (640 cubic feet);

(4) *An IBC.* For an IBC labeled in accordance with subpart E of this part instead of placarded, the IBC may display the proper shipping name and UN identification number in accordance with the size requirements of §172.302(b)(2) in place of the UN number on an orange panel, placard or white square-on-point; and

(5) A Large Packaging as defined in §171.8 of this subchapter.

[Amdt. 172-136, 59 FR 38064, July 26, 1994; Amdt. 172-148, 61 FR 50255, Sept. 25, 1996, as amended by 66 FR 45379, Aug. 28, 2001; 69 FR 64473, Nov. 4, 2004; 75 FR 5392, Feb. 2, 2010; 76 FR 43528, July 20, 2011; 77 FR 60942, Oct. 5, 2012]

§ 172.516 Visibility and display of placards.

(a) Each placard on a motor vehicle and each placard on a rail car must be clearly visible from the direction it faces, except from the direction of another transport vehicle or rail car to which the motor vehicle or rail car is coupled. This requirement may be met by the placards displayed on the

freight containers or portable tanks loaded on a motor vehicle or rail car.

(b) The required placarding of the front of a motor vehicle may be on the front of a truck-tractor instead of or in addition to the placarding on the front of the cargo body to which a truck-tractor is attached.

(c) Each placard on a transport vehicle, bulk packaging, freight container or aircraft unit load device must—

(1) Be securely attached or affixed thereto or placed in a holder thereon. (See appendix C to this part.);

(2) Be located clear of appurtenances and devices such as ladders, pipes, doors, and tarpaulins;

(3) So far as practicable, be located so that dirt or water is not directed to it from the wheels of the transport vehicle;

(4) Be located away from any marking (such as advertising) that could substantially reduce its effectiveness, and in any case at least 3 inches (76.0 mm.) away from such marking;

(5) Have the words or identification number (when authorized) printed on it displayed horizontally, reading from left to right;

(6) Be maintained by the carrier in a condition so that the format, legibility, color, and visibility of the placard will not be substantially reduced due to damage, deterioration, or obscurement by dirt or other matter;

(7) Be affixed to a background of contrasting color, or must have a dotted or solid line outer border which contrasts with the background color.

(d) Recommended specifications for a placard holder are set forth in appendix C of this part. Except for a placard holder similar to that contained in appendix C to this part, the means used to attach a placard may not obscure any part of its surface other than the borders.

(e) A placard or placard holder may be hinged provided the required format, color, and legibility of the placard are maintained.

[Amdt. 172-29, 41 FR 15996, Apr. 15, 1976, as amended by Amdt. 172-101, 45 FR 74668, Nov. 10, 1980; Amdt. 172-123, 55 FR 52601, Dec. 21, 1990; 65 FR 50460, Aug. 18, 2000]

§ 172.519 General specifications for placards.

(a) *Strength and durability.* Placards must conform to the following:

(1) A placard may be made of any plastic, metal or other material capable of withstanding, without deterioration or a substantial reduction in effectiveness, a 30-day exposure to open weather conditions.

(2) A placard made of tagboard must be at least equal to that designated commercially as white tagboard. Tagboard must have a weight of at least 80 kg (176 pounds) per ream of 610 by 910 mm (24 by 36-inch) sheets, waterproofing materials included. In addition, each placard made of tagboard must be able to pass a 414 kPa (60 p.s.i.) Mullen test.

(3) Reflective or retroreflective materials may be used on a placard if the prescribed colors, strength and durability are maintained.

(b) *Design.* (1) Except as provided in § 172.332 of this part, each placard must be as described in this subpart, and except for size and color, the printing, inner border and symbol must be as shown in §§ 172.521 through 172.560 of this subpart, as appropriate.

(2) The dotted line border shown on each placard is not part of the placard specification. However, a dotted or solid line outer border may be used when needed to indicate the full size of a placard that is part of a larger format or is on a background of a non-contrasting color.

(3) For other than Class 7 or the DANGEROUS placard, text indicating a hazard (for example, “FLAMMABLE”) is not required. Text may be omitted from the OXYGEN placard only if the specific identification number is displayed on the placard.

(4) For a placard corresponding to the primary or subsidiary hazard class of a material, the hazard class or division number must be displayed in the lower corner of the placard. However, a permanently affixed subsidiary placard meeting the specifications of this section which were in effect on October 1, 2001, (such as, a placard without the hazard class or division number displayed in the lower corner of the placard) and which was installed prior to September 30, 2001, may continue to

be used as a subsidiary placard in domestic transportation by rail or highway, provided the color tolerances are maintained and are in accordance with the display requirements in this subchapter.

(c) *Size.* (1) Each placard prescribed in this subpart must measure at least 250 mm (9.84 inches) on each side and must have a solid line inner border approximately 12.7 mm (0.5 inches) from each edge.

(2) Except as otherwise provided in this subpart, the hazard class or division number, as appropriate, must be shown in numerals measuring at least 41 mm (1.6 inches) in height.

(3) Except as otherwise provided in this subpart, when text indicating a hazard is displayed on a placard, the printing must be in letters measuring at least 41 mm (1.6 inches) in height.

(d) *Color.* (1) The background color, symbol, text, numerals and inner border on a placard must be as specified in §§ 172.521 through 172.560 of this subpart, as appropriate.

(2) Black and any color on a placard must be able to withstand, without substantial change—

(i) A 72-hour fadeometer test (for a description of equipment designed for this purpose, see ASTM G 23–69 or ASTM G 26–70); and

(ii) A 30-day exposure to open weather.

(3) Upon visual examination, a color on a placard must fall within the color tolerances displayed on the appropriate Hazardous Materials Label and Placard Color Tolerance Chart (see § 172.407(d)(4)). As an alternative, the PANTONE® formula guide coated/uncoated as specified for colors in § 172.407(d)(5) may be used.

(4) The placard color must extend to the inner border and may extend to the edge of the placard in the area designated on each placard except the color on the CORROSIVE and RADIOACTIVE placards (black and yellow, respectively) must extend only to the inner border.

(e) *Form identification.* A placard may contain form identification information, including the name of its maker, provided that information is printed outside of the solid line inner border in no larger than 10-point type.

(f) *Exceptions.* When hazardous materials are offered for transportation or transported under the provisions of subpart C of part 171 of this subchapter, a placard conforming to the specifications in the ICAO Technical Instructions, the IMDG Code, or the Transport Canada TDG Regulations (IBR, see §171.7 of this subchapter) may be used in place of a corresponding placard conforming to the requirements of this subpart. However, a bulk packaging, transport vehicle, or freight container containing a material poisonous by inhalation (see §171.8 of this subchapter) must be placarded in accordance with this subpart (see §171.23(b)(10) of this subchapter).

(g) *Trefoil symbol.* The trefoil symbol on the RADIOACTIVE placard must meet the appropriate specification in appendix B of this part.

[Amdt. 172-123, 55 FR 52601, Dec. 21, 1990, as amended at 56 FR 66260, Dec. 20, 1991; 57 FR 45460, Oct. 1, 1992; Amdt. 172-143, 60 FR 50305, Sept. 28, 1995; 65 FR 50460, Aug. 18, 2000; 66 FR 33426, June 21, 2001; 66 FR 44255, Aug. 22, 2001; 67 FR 15743, Apr. 3, 2002; 70 FR 34075, June 13, 2005; 69 FR 64473, Nov. 4, 2004; 72 FR 25176, May 3, 2007; 76 FR 43528, July 20, 2011; 76 FR 56314, Sept. 13, 2011]

§ 172.521 DANGEROUS placard.

(a) Except for size and color, the DANGEROUS placard must be as follows:



(b) In addition to meeting the requirements of §172.519, and appendix B to this part, the DANGEROUS placard must have a red upper and lower triangle. The placard center area and 1/2-

inch (12.7 mm.) border must be white. The inscription must be black with the 1/8-inch (3.2 mm.) border marker in the white area at each end of the inscription red.

[Amdt. 172-29, 41 FR 15996, Apr. 15, 1976, as amended by Amdt. 172-29A, 41 FR 40680, Sept. 20, 1976]

§ 172.522 EXPLOSIVES 1.1, EXPLOSIVES 1.2 and EXPLOSIVES 1.3 placards.

(a) Except for size and color, the EXPLOSIVES 1.1, EXPLOSIVES 1.2 and EXPLOSIVES 1.3 placards must be as follows:



(b) In addition to complying with §172.519 of this subpart, the background color on the EXPLOSIVES 1.1, EXPLOSIVES 1.2, and EXPLOSIVES 1.3 placards must be orange. The “*” shall be replaced with the appropriate division number and, when required, appropriate compatibility group letter. The symbol, text, numerals and inner border must be black.

[Amdt. 172-123, 55 FR 52602, Dec. 21, 1990, as amended at 56 FR 66260, Dec. 20, 1991]

§ 172.523 EXPLOSIVES 1.4 placard.

(a) Except for size and color, the EXPLOSIVES 1.4 placard must be as follows:

§ 172.524

49 CFR Ch. I (10–1–14 Edition)



(b) In addition to complying with § 172.519 of this subpart, the background color on the EXPLOSIVES 1.4 placard must be orange. The “*” shall be replaced, when required, with the appropriate compatibility group letter. The division numeral, 1.4, must measure at least 64 mm (2.5 inches) in height. The text, numerals and inner border must be black.

[Amdt. 172–123, 55 FR 52602, Dec. 21, 1990, as amended at 56 FR 66261, Dec. 20, 1991]

§ 172.524 EXPLOSIVES 1.5 placard.

(a) Except for size and color, the EXPLOSIVES 1.5 placard must be as follows:



(b) In addition to complying with the § 172.519 of this subpart, the background color on EXPLOSIVES 1.5 placard

must be orange. The “*” shall be replaced, when required, with the appropriate compatibility group letter. The division numeral, 1.5, must measure at least 64 mm (2.5 inches) in height. The text, numerals and inner border must be black.

[Amdt. 172–123, 55 FR 52602, Dec. 21, 1990, as amended at 56 FR 66261, Dec. 20, 1991]

§ 172.525 EXPLOSIVES 1.6 placard.

(a) Except for size and color the EXPLOSIVES 1.6 placard must be as follows:



(b) In addition to complying with § 172.519 of this subpart, the background color on the EXPLOSIVES 1.6 placard must be orange. The “*” shall be replaced, when required, with the appropriate compatibility group letter. The division numeral, 1.6, must measure at least 64 mm (2.5 inches) in height. The text, numerals and inner border must be black.

[Amdt. 172–123, 55 FR 52603, Dec. 21, 1990, as amended at 56 FR 66261, Dec. 20, 1991; Amdt. 172–130, 58 FR 51531, Oct. 1, 1993]

§ 172.526 [Reserved]

§ 172.527 Background requirements for certain placards.

(a) Except for size and color, the square background required by § 172.510(a) for certain placards on rail cars, and § 172.507 for placards on motor vehicles containing a package of highway route controlled quantity radioactive materials, must be as follows:

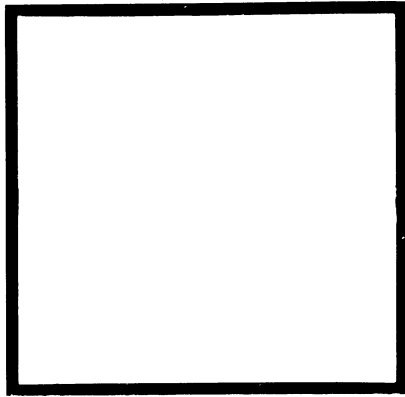

(b) In addition to meeting the requirements of §172.519 for minimum durability and strength, the square background must consist of a white square measuring 14¼ inches (362.0 mm.) on each side surrounded by a black border extending to 15¼ inches (387.0 mm.) on each side.

[Amdt. 172-29, 41 FR 15996, Apr. 15, 1976, as amended by Amdt. 172-64, 46 FR 5316, Jan. 19, 1981; Amdt. 172-78, 48 FR 10226, Mar. 10, 1983]

§ 172.528 NON-FLAMMABLE GAS placard.

(a) Except for size and color, the NON-FLAMMABLE GAS placard must be as follows:



(b) In addition to complying with §172.519, the background color on the NON-FLAMMABLE GAS placard must be green. The letters in both words must be at least 38 mm (1.5 inches)

high. The symbol, text, class number and inner border must be white.

[Amdt. 172-123, 56 FR 66261, Dec. 20, 1991]

§ 172.530 OXYGEN placard.

(a) Except for size and color, the OXYGEN placard must be as follows:



(b) In addition to complying with §172.519 of this subpart, the background color on the OXYGEN placard must be yellow. The symbol, text, class number and inner border must be black.

[Amdt. 172-123, 56 FR 66262, Dec. 20, 1991]

§ 172.532 FLAMMABLE GAS placard.

(a) Except for size and color, the FLAMMABLE GAS placard must be as follows:



(b) In addition to complying with §172.519, the background color on the

§ 172.536

FLAMMABLE GAS placard must be red. The symbol, text, class number and inner border must be white.

[Amdt. 172-123, 56 FR 66262, Dec. 20, 1991]

§ 172.536 [Reserved]

§ 172.540 POISON GAS placard.

(a) Except for size and color, the POISON GAS placard must be as follows:



(b) In addition to complying with §172.519, the background on the POISON GAS placard and the symbol must be white. The background of the upper diamond must be black and the lower point of the upper diamond must be 65 mm (2½ inches) above the horizontal center line. The text, class number, and inner border must be black.

[62 FR 39408, July 22, 1997]

§ 172.542 FLAMMABLE placard.

(a) Except for size and color, the FLAMMABLE placard must be as follows:

49 CFR Ch. I (10-1-14 Edition)



(b) In addition to complying with §172.519, the background color on the FLAMMABLE placard must be red. The symbol, text, class number and inner border must be white.

(c) The word "GASOLINE" may be used in place of the word "FLAMMABLE" on a placard that is displayed on a cargo tank or a portable tank being used to transport gasoline by highway. The word "GASOLINE" must be shown in white.

[Amdt. 172-123, 56 FR 66262, Dec. 20, 1991]

§ 172.544 COMBUSTIBLE placard.

(a) Except for size and color, the COMBUSTIBLE placard must be as follows:



(b) In addition to complying with §172.519, the background color on the COMBUSTIBLE placard must be red.

The symbol, text, class number and inner border must be white. On a COMBUSTIBLE placard with a white bottom as prescribed by §172.332(c)(4), the class number must be red or black.

(c) The words "FUEL OIL" may be used in place of the word "COMBUSTIBLE" on a placard that is displayed on a cargo tank or portable tank being used to transport by highway fuel oil that is not classed as a flammable liquid. The words "FUEL OIL" must be white.

[Amdt. 172-123, 56 FR 66262, Dec. 20, 1991]

§ 172.546 FLAMMABLE SOLID placard.

(a) Except for size and color, the FLAMMABLE SOLID placard must be as follows:



(b) In addition to complying with §172.519, the background on the FLAMMABLE SOLID placard must be white with seven vertical red stripes. The stripes must be equally spaced, with one red stripe placed in the center of the label. Each red stripe and each white space between two red stripes must be 25 mm (1.0 inches) wide. The letters in the word "SOLID" must be at least 38.1 mm (1.5 inches) high. The symbol, text, class number and inner border must be black.

[Amdt. 172-123, 56 FR 66263, Dec. 20, 1991]

§ 172.547 SPONTANEOUSLY COMBUSTIBLE placard.

(a) Except for size and color, the SPONTANEOUSLY COMBUSTIBLE placard must be as follows:



(b) In addition to complying with §172.519, the background color on the SPONTANEOUSLY COMBUSTIBLE placard must be red in the lower half and white in upper half. The letters in the word "SPONTANEOUSLY" must be at least 12 mm (0.5 inch) high. The symbol, text, class number and inner border must be black.

[Amdt. 172-123, 56 FR 66263, Dec. 20, 1991, as amended by Amdt. 172-139, 59 FR 67490, Dec. 29, 1994]

§ 172.548 DANGEROUS WHEN WET placard.

(a) Except for size and color, the DANGEROUS WHEN WET placard must be as follows:



(b) In addition to complying with §172.519, the background color on the DANGEROUS WHEN WET placard must be blue. The letters in the words

§ 172.550

“WHEN WET” must be at least 25 mm (1.0 inches) high. The symbol, text, class number and inner border must be white.

[Amdt. 172-123, 56 FR 66263, Dec. 20, 1991]

§ 172.550 OXIDIZER placard.

(a) Except for size and color, the OXIDIZER placard must be as follows:



49 CFR Ch. I (10-1-14 Edition)

(b) In addition to complying with §172.519, the background color on the OXIDIZER placard must be yellow. The symbol, text, division number and inner border must be black.

[Amdt. 172-123, 56 FR 66263, Dec. 20, 1991]

§ 172.552 ORGANIC PEROXIDE placard.

(a) Except for size and color, the ORGANIC PEROXIDE placard must be as follows:



(b) In addition to complying with §172.519, the background on the ORGANIC PEROXIDE placard must be red in the top half and yellow in the lower half. The text, division number and inner border must be black; the symbol may be either black or white.

(c) For transportation by highway, a Division 5.2 placard conforming to the specifications in this section in effect on December 31, 2006 may continue to be used until January 1, 2014.

[71 FR 78628, Dec. 29, 2006, as amended at 76 FR 43528, July 20, 2011]

§ 172.553 [Reserved]

§ 172.554 POISON placard.

(a) Except for size and color, the POISON placard must be as follows:

§ 172.555

49 CFR Ch. I (10-1-14 Edition)



(b) In addition to complying with §172.519, the background on the POISON placard must be white. The symbol, text, class number and inner border must be black. The word "TOXIC" may be used in lieu of the word "POISON".

[Amdt. 172-123, 56 FR 66264, Dec. 20, 1991, as amended by Amdt. 172-139, 59 FR 67490, Dec. 29, 1994]

§ 172.555 POISON INHALATION HAZARD placard.

(a) Except for size and color, the POISON INHALATION HAZARD placard must be as follows:



(b) In addition to complying with §172.519, the background on the POISON INHALATION HAZARD placard and the symbol must be white. The background of the upper diamond must be black and the lower point of the upper diamond must be 65 mm (2½ inches) above the horizontal center line. The text, class number, and inner border must be black.

[62 FR 39409, July 22, 1997]

§ 172.556 RADIOACTIVE placard.

(a) Except for size and color, the RADIOACTIVE placard must be as follows:



(b) In addition to complying with §172.519, the background color on the RADIOACTIVE placard must be white in the lower portion with a yellow triangle in the upper portion. The base of the yellow triangle must be 29 mm \pm 5 mm (1.1 inches \pm 0.2 inches) above the placard horizontal center line. The

symbol, text, class number and inner border must be black.

[Amdt. 172-123, 56 FR 66264, Dec. 20, 1991; Amdt. 172-130, 58 FR 51531, Oct. 1, 1993; 65 FR 58627, Sept. 29, 2000]

§ 172.558 CORROSIVE placard.

(a) Except for size and color, the CORROSIVE placard must be as follows:



(b) In addition to complying with §172.519, the background color on the CORROSIVE placard must be black in the lower portion with a white triangle in the upper portion. The base of the white triangle must be 38 mm ±5 mm (1.5 inches ±0.2 inches) above the placard horizontal center line. The text and class number must be white. The symbol and inner border must be black.

[Amdt. 172-123, 56 FR 66264, Dec. 20, 1991, as amended at 65 FR 58627, Sept. 29, 2000]

§ 172.560 CLASS 9 placard.

(a) Except for size and color the CLASS 9 (miscellaneous hazardous materials) placard must be as follows:

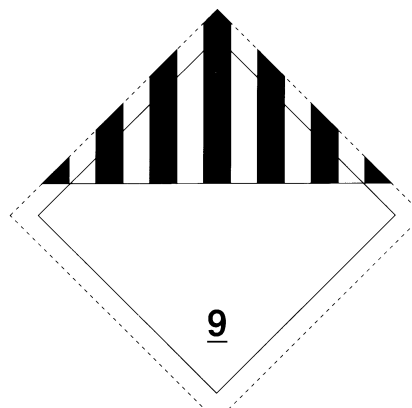

(b) In addition to conformance with §172.519, the background on the CLASS 9 placard must be white with seven black vertical stripes on the top half extending from the top of the placard to one inch above the horizontal centerline. The black vertical stripes must be spaced so that, visually, they appear equal in width to the six white spaces between them. The space below the vertical lines must be white with the class number 9 underlined and centered at the bottom.

[Amdt. 172-123, 56 FR 66264, Dec. 20, 1991, as amended at 57 FR 45460, Oct. 1, 1992]

Subpart G—Emergency Response Information

§ 172.600 Applicability and general requirements.

(a) *Scope.* Except as provided in paragraph (d) of this section, this subpart prescribes requirements for providing and maintaining emergency response information during transportation and at facilities where hazardous materials are loaded for transportation, stored incidental to transportation or otherwise handled during any phase of transportation.

(b) *Applicability.* This subpart applies to persons who offer for transportation, accept for transportation, transfer or otherwise handle hazardous materials during transportation.

(c) *General requirements.* No person to whom this subpart applies may offer for transportation, accept for transportation, transfer, store or otherwise handle during transportation a hazardous material unless:

(1) Emergency response information conforming to this subpart is immediately available for use at all times the hazardous material is present; and

(2) Emergency response information, including the emergency response telephone number, required by this subpart is immediately available to any person who, as a representative of a Federal, State or local government agency, responds to an incident involving a hazardous material, or is conducting an investigation which involves a hazardous material.

(d) *Exceptions.* The requirements of this subpart do not apply to hazardous material which is excepted from the

shipping paper requirements of this subchapter or a material properly classified as an ORM-D.

[Amdt. 172-116, 54 FR 27145, June 27, 1989; 54 FR 28750, July 5, 1989, as amended at 55 FR 33712, Aug. 17, 1990; 172-127, 59 FR 49133, Sept. 26, 1994; Amdt. 172-149, 61 FR 27173, May 30, 1996]

§ 172.602 Emergency response information.

(a) *Information required.* For purposes of this subpart, the term “emergency response information” means information that can be used in the mitigation of an incident involving hazardous materials and, as a minimum, must contain the following information:

(1) The basic description and technical name of the hazardous material as required by §§172.202 and 172.203(k), the ICAO Technical Instructions, the IMDG Code, or the TDG Regulations, as appropriate (IBR, see §171.7 of this subchapter);

(2) Immediate hazards to health;

(3) Risks of fire or explosion;

(4) Immediate precautions to be taken in the event of an accident or incident;

(5) Immediate methods for handling fires;

(6) Initial methods for handling spills or leaks in the absence of fire; and

(7) Preliminary first aid measures.

(b) *Form of information.* The information required for a hazardous material by paragraph (a) of this section must be:

(1) Printed legibly in English;

(2) Available for use away from the package containing the hazardous material; and

(3) Presented—

(i) On a shipping paper;

(ii) In a document, other than a shipping paper, that includes both the basic description and technical name of the hazardous material as required by §§172.202 and 172.203(k), the ICAO Technical Instructions, the IMDG Code, or the TDG Regulations, as appropriate, and the emergency response information required by this subpart (e.g., a material safety data sheet); or

(iii) Related to the information on a shipping paper, a written notification to pilot-in-command, or a dangerous cargo manifest, in a separate document

(e.g., an emergency response guidance document), in a manner that cross-references the description of the hazardous material on the shipping paper with the emergency response information contained in the document. Aboard aircraft, the ICAO “Emergency Response Guidance for Aircraft Incidents Involving Dangerous Goods” and, aboard vessels, the IMO “Emergency Procedures for Ships Carrying Dangerous Goods”, or equivalent documents, may be used to satisfy the requirements of this section for a separate document.

(c) *Maintenance of information.* Emergency response information shall be maintained as follows:

(1) *Carriers.* Each carrier who transports a hazardous material shall maintain the information specified in paragraph (a) of this section and §172.606 of this part in the same manner as prescribed for shipping papers, except that the information must be maintained in the same manner aboard aircraft as the notification of pilot-in-command, and aboard vessels in the same manner as the dangerous cargo manifest. This information must be immediately accessible to train crew personnel, drivers of motor vehicles, flight crew members, and bridge personnel on vessels for use in the event of incidents involving hazardous materials.

(2) *Facility operators.* Each operator of a facility where a hazardous material is received, stored or handled during transportation, shall maintain the information required by paragraph (a) of this section whenever the hazardous material is present. This information must be in a location that is immediately accessible to facility personnel in the event of an incident involving the hazardous material.

[Amdt. 172–116, 54 FR 27146, June 27, 1989; 54 FR 28750, July 5, 1989, as amended by Amdt. 172–116, 55 FR 875, Jan. 10, 1990; Amdt. 172–151, 62 FR 1234, Jan. 8, 1997; 66 FR 45379, Aug. 28, 2001; 68 FR 75741, Dec. 31, 2003]

§ 172.604 Emergency response telephone number.

(a) A person who offers a hazardous material for transportation must provide an emergency response telephone number, including the area code, for use in an emergency involving the haz-

ardous material. For telephone numbers outside the United States, the international access code or the “+” (plus) sign, country code, and city code, as appropriate, that are needed to complete the call must be included. The telephone number must be—

(1) Monitored at all times the hazardous material is in transportation, including storage incidental to transportation;

(2) The telephone number of a person who is either knowledgeable of the hazardous material being shipped and has comprehensive emergency response and incident mitigation information for that material, or has immediate access to a person who possesses such knowledge and information. A telephone number that requires a call back (such as an answering service, answering machine, or beeper device) does not meet the requirements of paragraph (a) of this section; and

(3) Entered on a shipping paper, as follows:

(i) Immediately following the description of the hazardous material required by subpart C of this part; or

(ii) Entered once on the shipping paper in the manner prescribed in paragraph (b) of this section in a prominent, readily identifiable, and clearly visible manner that allows the information to be easily and quickly found, such as by highlighting, use of a larger font or a font that is a different color from other text and information, or otherwise setting the information apart to provide for quick and easy recognition. The offeror may use one of the methods prescribed in this paragraph only if the telephone number applies to each hazardous material entered on the shipping paper, and if it is indicated that the telephone number is for emergency response information (for example: “EMERGENCY CONTACT: * * *”).

(b) The telephone number required by paragraph (a) of this section must be –

(1) The number of the person offering the hazardous material for transportation when that person is also the emergency response information provider (ERI provider). The name of the person, or contract number or other unique identifier assigned by an ERI

provider, identified with the emergency response telephone number must be entered on the shipping paper immediately before, after, above, or below the emergency response telephone number unless the name is entered elsewhere on the shipping paper in a prominent, readily identifiable, and clearly visible manner that allows the information to be easily and quickly found; or

(2) The number of an agency or organization capable of, and accepting responsibility for, providing the detailed information required by paragraph (a)(2) of this section. The person who is registered with the ERI provider must ensure that the agency or organization has received current information on the material before it is offered for transportation. The person who is registered with the ERI provider must be identified by name, or contract number or other unique identifier assigned by the ERI provider, on the shipping paper immediately before, after, above, or below the emergency response telephone number in a prominent, readily identifiable, and clearly visible manner that allows the information to be easily and quickly found, unless the name or identifier is entered elsewhere in a prominent manner as provided in paragraph (b)(1) of this section.

(c) A person preparing shipping papers for continued transportation in commerce must include the information required by this section. If the person preparing shipping papers for continued transportation in commerce elects to assume responsibility for providing the emergency response telephone number required by this section, the person must ensure that all the requirements of this section are met.

(d) The requirements of this section do not apply to—

(1) Hazardous materials that are offered for transportation under the provisions applicable to limited quantities; or

(2) Materials properly described under the following shipping names:

Battery powered equipment.
Battery powered vehicle.
Carbon dioxide, solid.
Castor bean.
Castor flake.
Castor meal.

Castor pomace.

Consumer commodity.

Dry ice.

Engines, internal combustion.

Fish meal, stabilized.

Fish scrap, stabilized.

Krill Meal, PG III.

Refrigerating machine.

Vehicle, flammable gas powered.

Vehicle, flammable liquid powered.

Wheelchair, electric.

(3) Transportation vehicles or freight containers containing lading that has been fumigated and displaying the FUMIGANT marking (*see* §172.302(g)) as required by §173.9 of this subchapter, unless other hazardous materials are present in the cargo transport unit.

[74 FR 53422, Oct. 19, 2009, as amended at 75 FR 53596, Sept. 1, 2010; 77 FR 37984, June 25, 2012; 78 FR 1073, Jan. 7, 2013; 78 FR 60753, Oct. 1, 2013]

§ 172.606 Carrier information contact.

(a) Each carrier who transports or accepts for transportation a hazardous material for which a shipping paper is required shall instruct the operator of a motor vehicle, train, aircraft, or vessel to contact the carrier (e.g., by telephone or mobile radio) in the event of an incident involving the hazardous material.

(b) For transportation by highway, if a transport vehicle, (e.g., a semi-trailer or freight container-on-chassis) contains hazardous material for which a shipping paper is required and the vehicle is separated from its motive power and parked at a location other than a facility operated by the consignor or consignee or a facility (e.g., a carrier's terminal or a marine terminal) subject to the provisions of §172.602(c)(2), the carrier shall—

(1) Mark the transport vehicle with the telephone number of the motor carrier on the front exterior near the brake hose and electrical connections or on a label, tag, or sign attached to the vehicle at the brake hose or electrical connection; or

(2) Have the shipping paper and emergency response information readily available on the transport vehicle.

(c) The requirements specified in paragraph (b) of this section do not apply to an unattended motor vehicle separated from its motive power when

§ 172.700

the motor vehicle is marked on an orange panel, a placard, or a plain white square-on-point configuration with the identification number of each hazardous material loaded therein, and the marking or placard is visible on the outside of the motor vehicle.

[Amdt. 172-151, 62 FR 1234, Jan. 8, 1997, as amended at 62 FR 39398 and 39409, July 22, 1997; 63 FR 16076, Apr. 1, 1998]

Subpart H—Training

SOURCE: Amdt. 172-126, 57 FR 20952, May 15, 1992, unless otherwise noted.

§ 172.700 Purpose and scope.

(a) *Purpose.* This subpart prescribes requirements for training hazmat employees.

(b) *Scope.* Training as used in this subpart means a systematic program that ensures a hazmat employee has familiarity with the general provisions of this subchapter, is able to recognize and identify hazardous materials, has knowledge of specific requirements of this subchapter applicable to functions performed by the employee, and has knowledge of emergency response information, self-protection measures and accident prevention methods and procedures (see § 172.704).

(c) *Modal-specific training requirements.* Additional training requirements for the individual modes of transportation are prescribed in parts 174, 175, 176, and 177 of this subchapter.

§ 172.701 Federal-State relationship.

This subpart and the parts referenced in § 172.700(c) prescribe minimum training requirements for the transportation of hazardous materials. For motor vehicle drivers, however, a State may impose more stringent training requirements only if those requirements—

(a) Do not conflict with the training requirements in this subpart and in part 177 of this subchapter; and

(b) Apply only to drivers domiciled in that State.

§ 172.702 Applicability and responsibility for training and testing.

(a) A hazmat employer shall ensure that each of its hazmat employees is

49 CFR Ch. I (10-1-14 Edition)

trained in accordance with the requirements prescribed in this subpart.

(b) Except as provided in § 172.704(c)(1), a hazmat employee who performs any function subject to the requirements of this subchapter may not perform that function unless instructed in the requirements of this subchapter that apply to that function. It is the duty of each hazmat employer to comply with the applicable requirements of this subchapter and to thoroughly instruct each hazmat employee in relation thereto.

(c) Training may be provided by the hazmat employer or other public or private sources.

(d) A hazmat employer shall ensure that each of its hazmat employees is tested by appropriate means on the training subjects covered in § 172.704.

[Amdt. 172-126, 57 FR 20952, May 15, 1992; 57 FR 22182, May 27, 1992, as amended by Amdt. 172-149, 61 FR 27173, May 30, 1996]

§ 172.704 Training requirements.

(a) Hazmat employee training must include the following:

(1) *General awareness/familiarization training.* Each hazmat employee shall be provided general awareness/familiarization training designed to provide familiarity with the requirements of this subchapter, and to enable the employee to recognize and identify hazardous materials consistent with the hazard communication standards of this subchapter.

(2) *Function-specific training.* (i) Each hazmat employee must be provided function-specific training concerning requirements of this subchapter, or exemptions or special permits issued under subchapter A of this chapter, that are specifically applicable to the functions the employee performs.

(ii) As an alternative to function-specific training on the requirements of this subchapter, training relating to the requirements of the ICAO Technical Instructions and the IMDG Code may be provided to the extent such training addresses functions authorized by subpart C of part 171 of this subchapter.

(3) *Safety training.* Each hazmat employee shall receive safety training concerning—

(i) Emergency response information required by subpart G of part 172;

(ii) Measures to protect the employee from the hazards associated with hazardous materials to which they may be exposed in the work place, including specific measures the hazmat employer has implemented to protect employees from exposure; and

(iii) Methods and procedures for avoiding accidents, such as the proper procedures for handling packages containing hazardous materials.

(4) *Security awareness training.* Each hazmat employee must receive training that provides an awareness of security risks associated with hazardous materials transportation and methods designed to enhance transportation security. This training must also include a component covering how to recognize and respond to possible security threats. New hazmat employees must receive the security awareness training required by this paragraph within 90 days after employment.

(5) *In-depth security training.* Each hazmat employee of a person required to have a security plan in accordance with subpart I of this part who handles hazardous materials covered by the plan, performs a regulated function related to the hazardous materials covered by the plan, or is responsible for implementing the plan must be trained concerning the security plan and its implementation. Security training must include company security objectives, organizational security structure, specific security procedures, specific security duties and responsibilities for each employee, and specific actions to be taken by each employee in the event of a security breach.

(b) *OSHA, EPA, and other training.* Training conducted by employers to comply with the hazard communication programs required by the Occupational Safety and Health Administration of the Department of Labor (29 CFR 1910.120 or 1910.1200) or the Environmental Protection Agency (40 CFR 311.1), or training conducted by employers to comply with security training programs required by other Federal or international agencies, may be used to satisfy the training requirements in paragraph (a) of this section to the extent that such training addresses the

training components specified in paragraph (a) of this section.

(c) *Initial and recurrent training—(1) Initial training.* A new hazmat employee, or a hazmat employee who changes job functions may perform those functions prior to the completion of training provided—

(i) The employee performs those functions under the direct supervision of a properly trained and knowledgeable hazmat employee; and

(ii) The training is completed within 90 days after employment or a change in job function.

(2) *Recurrent training.* A hazmat employee must receive the training required by this subpart at least once every three years. For in-depth security training required under paragraph (a)(5) of this section, a hazmat employee must be trained at least once every three years or, if the security plan for which training is required is revised during the three-year recurrent training cycle, within 90 days of implementation of the revised plan.

(3) *Relevant Training.* Relevant training received from a previous employer or other source may be used to satisfy the requirements of this subpart provided a current record of training is obtained from hazmat employees' previous employer.

(4) *Compliance.* Each hazmat employer is responsible for compliance with the requirements of this subchapter regardless of whether the training required by this subpart has been completed.

(d) *Recordkeeping.* Each hazmat employer must create and retain a record of current training of each hazmat employee, inclusive of the preceding three years, in accordance with this section for as long as that employee is employed by that employer as a hazmat employee and for 90 days thereafter. A hazmat employer must make a hazmat employee's record of current training available upon request, at a reasonable time and location, to an authorized official of the Department of Transportation or of an entity explicitly granted authority to enforce the HMR. The record must include:

(1) The hazmat employee's name;

(2) The most recent training completion date of the hazmat employee's training;

(3) A description, copy, or the location of the training materials used to meet the requirements in paragraph (a) of this section;

(4) The name and address of the person providing the training; and

(5) Certification that the hazmat employee has been trained and tested, as required by this subpart.

(e) *Limitations.* The following limitations apply:

(1) A hazmat employee who repairs, modifies, reconditions, or tests packagings, as qualified for use in the transportation of hazardous materials, and who does not perform any other function subject to the requirements of this subchapter, is not subject to the training requirement of paragraph (a)(3) of this section.

(2) A railroad maintenance-of-way employee or railroad signalman, who does not perform any function subject to the requirements of this subchapter, is not subject to the training requirements of paragraphs (a)(2), (a)(4), or (a)(5) of this section. Initial training for a railroad maintenance-of-way employee or railroad signalman in accordance with this section must be completed by October 1, 2006.

[Amdt. 172-126, 57 FR 20952, May 15, 1992, as amended by Amdt. 172-126, 58 FR 5851, Jan. 22, 1993; Amdt. 172-145, 60 FR 49110, Sept. 21, 1995; Amdt. 172-149, 61 FR 27173, May 30, 1996; 65 FR 50460, Aug. 18, 2000; 68 FR 14521, Mar. 25, 2003; 70 FR 73164, Dec. 9, 2005; 73 FR 4716, Jan. 28, 2008; 73 FR 57005, Oct. 1, 2008; 75 FR 10988, Mar. 9, 2010; 76 FR 56314, Sept. 13, 2011; 78 FR 15326, Mar. 11, 2013]

Subpart I—Safety and Security Plans

SOURCE: 68 FR 14521, Mar. 25, 2003, unless otherwise noted.

§ 172.800 Purpose and applicability.

(a) *Purpose.* This subpart prescribes requirements for development and implementation of plans to address security risks related to the transportation of hazardous materials in commerce.

(b) *Applicability.* Each person who offers for transportation in commerce or transports in commerce one or more of

the following hazardous materials must develop and adhere to a transportation security plan for hazardous materials that conforms to the requirements of this subpart. As used in this section, "large bulk quantity" refers to a quantity greater than 3,000 kg (6,614 pounds) for solids or 3,000 liters (792 gallons) for liquids and gases in a single packaging such as a cargo tank motor vehicle, portable tank, tank car, or other bulk container.

(1) Any quantity of a Division 1.1, 1.2, or 1.3 material;

(2) A quantity of a Division 1.4, 1.5, or 1.6 material requiring placarding in accordance with subpart F of this part;

(3) A large bulk quantity of Division 2.1 material;

(4) A large bulk quantity of Division 2.2 material with a subsidiary hazard of 5.1;

(5) Any quantity of a material poisonous by inhalation, as defined in § 171.8 of this subchapter;

(6) A large bulk quantity of a Class 3 material meeting the criteria for Packing Group I or II;

(7) A quantity of desensitized explosives meeting the definition of Division 4.1 or Class 3 material requiring placarding in accordance with subpart F of this part;

(8) A large bulk quantity of a Division 4.2 material meeting the criteria for Packing Group I or II;

(9) A quantity of a Division 4.3 material requiring placarding in accordance with subpart F of this part;

(10) A large bulk quantity of a Division 5.1 material in Packing Groups I and II; perchlorates; or ammonium nitrate, ammonium nitrate fertilizers, or ammonium nitrate emulsions, suspensions, or gels;

(11) Any quantity of organic peroxide, Type B, liquid or solid, temperature controlled;

(12) A large bulk quantity of Division 6.1 material (for a material poisonous by inhalation see paragraph (5) above);

(13) A select agent or toxin regulated by the Centers for Disease Control and Prevention under 42 CFR part 73 or the United States Department of Agriculture under 9 CFR part 121;

(14) A quantity of uranium hexafluoride requiring placarding under § 172.505(b);

(15) International Atomic Energy Agency (IAEA) Code of Conduct Category 1 and 2 materials including Highway Route Controlled quantities as defined in 49 CFR 173.403 or known radionuclides in forms listed as RAM-QC by the Nuclear Regulatory Commission;

(16) A large bulk quantity of Class 8 material meeting the criteria for Packing Group I.

(c) *Exceptions.* Transportation activities of a farmer, who generates less than \$500,000 annually in gross receipts from the sale of agricultural commodities or products, are not subject to this subpart if such activities are:

(1) Conducted by highway or rail;

(2) In direct support of their farming operations; and

(3) Conducted within a 150-mile radius of those operations.

[68 FR 14521, Mar. 25, 2003, as amended at 70 FR 73164, Dec. 9, 2005; 71 FR 32258, June 2, 2006; 75 FR 10988, Mar. 9, 2010; 75 FR 53597, Sept. 1, 2010; 76 FR 56314, Sept. 13, 2011]

§ 172.802 Components of a security plan.

(a) The security plan must include an assessment of transportation security risks for shipments of the hazardous materials listed in § 172.800, including site-specific or location-specific risks associated with facilities at which the hazardous materials listed in § 172.800 are prepared for transportation, stored, or unloaded incidental to movement, and appropriate measures to address the assessed risks. Specific measures put into place by the plan may vary commensurate with the level of threat at a particular time. At a minimum, a security plan must include the following elements:

(1) *Personnel security.* Measures to confirm information provided by job applicants hired for positions that involve access to and handling of the hazardous materials covered by the security plan. Such confirmation system must be consistent with applicable Federal and State laws and requirements concerning employment practices and individual privacy.

(2) *Unauthorized access.* Measures to address the assessed risk that unauthorized persons may gain access to the hazardous materials covered by the security plan or transport conveyances

being prepared for transportation of the hazardous materials covered by the security plan.

(3) *En route security.* Measures to address the assessed security risks of shipments of hazardous materials covered by the security plan en route from origin to destination, including shipments stored incidental to movement.

(b) The security plan must also include the following:

(1) Identification by job title of the senior management official responsible for overall development and implementation of the security plan;

(2) Security duties for each position or department that is responsible for implementing the plan or a portion of the plan and the process of notifying employees when specific elements of the security plan must be implemented; and

(3) A plan for training hazmat employees in accordance with § 172.704 (a)(4) and (a)(5) of this part.

(c) The security plan, including the transportation security risk assessment developed in accordance with paragraph (a) of this section, must be in writing and must be retained for as long as it remains in effect. The security plan must be reviewed at least annually and revised and/or updated as necessary to reflect changing circumstances. The most recent version of the security plan, or portions thereof, must be available to the employees who are responsible for implementing it, consistent with personnel security clearance or background investigation restrictions and a demonstrated need to know. When the security plan is updated or revised, all employees responsible for implementing it must be notified and all copies of the plan must be maintained as of the date of the most recent revision.

(d) Each person required to develop and implement a security plan in accordance with this subpart must maintain a copy of the security plan (or an electronic file thereof) that is accessible at, or through, its principal place of business and must make the security plan available upon request, at a reasonable time and location, to an authorized official of the Department of

§ 172.804

Transportation or the Department of Homeland Security.

[68 FR 14521, Mar. 25, 2003, as amended at 75 FR 10989, Mar. 9, 2010]

§ 172.804 Relationship to other Federal requirements.

To avoid unnecessary duplication of security requirements, security plans that conform to regulations, standards, protocols, or guidelines issued by other Federal agencies, international organizations, or industry organizations may be used to satisfy the requirements in this subpart, provided such security plans address the requirements specified in this subpart.

§ 172.820 Additional planning requirements for transportation by rail.

(a) *General.* Each rail carrier transporting in commerce one or more of the following materials is subject to the additional safety and security planning requirements of this section:

(1) More than 2,268 kg (5,000 lbs) in a single carload of a Division 1.1, 1.2 or 1.3 explosive;

(2) A quantity of a material poisonous by inhalation in a single bulk packaging; or

(3) A highway route-controlled quantity of a Class 7 (radioactive) material, as defined in §173.403 of this subchapter.

(b) Not later than 90 days after the end of each calendar year, a rail carrier must compile commodity data for the previous calendar year for the materials listed in paragraph (a) of this section. The following stipulations apply to data collected:

(1) Commodity data must be collected by route, a line segment or series of line segments as aggregated by the rail carrier. Within the rail carrier selected route, the commodity data must identify the geographic location of the route and the total number of shipments by UN identification number for the materials specified in paragraph (a) of this section.

(2) A carrier may compile commodity data, by UN number, for all Class 7 materials transported (instead of only highway route controlled quantities of Class 7 materials) and for all Division 6.1 materials transported (instead of

49 CFR Ch. I (10–1–14 Edition)

only Division 6.1 poison inhalation hazard materials).

(c) *Rail transportation route analysis.* For each calendar year, a rail carrier must analyze the safety and security risks for the transportation route(s), identified in the commodity data collected as required by paragraph (b) of this section. The route analysis must be in writing and include the factors contained in appendix D to this part, as applicable.

(1) The safety and security risks present must be analyzed for the route and railroad facilities along the route. For purposes of this section, railroad facilities are railroad property including, but not limited to, classification and switching yards, storage facilities, and non-private sidings. This term does not include an offeror's facility, private track, private siding, or consignee's facility.

(2) In performing the analysis required by this paragraph, the rail carrier must seek relevant information from state, local, and tribal officials, as appropriate, regarding security risks to high-consequence targets along or in proximity to the route(s) utilized. If a rail carrier is unable to acquire relevant information from state, local, or tribal officials, then it must document that in its analysis. For purposes of this section, a high-consequence target means a property, natural resource, location, area, or other target designated by the Secretary of Homeland Security that is a viable terrorist target of national significance, the attack of which by railroad could result in catastrophic loss of life, significant damage to national security or defense capabilities, or national economic harm.

(d) *Alternative route analysis.* (1) For each calendar year, a rail carrier must identify practicable alternative routes over which it has authority to operate, if an alternative exists, as an alternative route for each of the transportation routes analyzed in accordance with paragraph (c) of this section. The carrier must perform a safety and security risk assessment of the alternative routes for comparison to the route analysis prescribed in paragraph (c) of this section. The alternative route analysis must be in writing and include the criteria in appendix D of this part.

When determining practicable alternative routes, the rail carrier must consider the use of interchange agreements with other rail carriers. The written alternative route analysis must also consider:

(i) Safety and security risks presented by use of the alternative route(s);

(ii) Comparison of the safety and security risks of the alternative(s) to the primary rail transportation route, including the risk of a catastrophic release from a shipment traveling along each route;

(iii) Any remediation or mitigation measures implemented on the primary or alternative route(s); and

(iv) Potential economic effects of using the alternative route(s), including but not limited to the economics of the commodity, route, and customer relationship.

(2) In performing the analysis required by this paragraph, the rail carrier should seek relevant information from state, local, and tribal officials, as appropriate, regarding security risks to high-consequence targets along or in proximity to the alternative routes. If a rail carrier determines that it is not appropriate to seek such relevant information, then it must explain its reasoning for that determination in its analysis.

(e) *Route Selection.* A carrier must use the analysis performed as required by paragraphs (c) and (d) of this section to select the route to be used in moving the materials covered by paragraph (a) of this section. The carrier must consider any remediation measures implemented on a route. Using this process, the carrier must at least annually review and select the practicable route posing the least overall safety and security risk. The rail carrier must retain in writing all route review and selection decision documentation and restrict the distribution, disclosure, and availability of information contained in the route analysis to covered persons with a need-to-know, as described in parts 15 and 1520 of this title. This documentation should include, but is not limited to, comparative analyses, charts, graphics or rail system maps.

(f) *Completion of route analysis.* (1) The rail transportation route analysis, al-

ternative route analysis, and route selection process required under paragraphs (c), (d), and (e) of this section must be completed no later than the end of the calendar year following the year to which the analyses apply.

(2) The initial analysis and route selection determinations required under paragraphs (c), (d), and (e) of this section must include a comprehensive review of the entire system. Subsequent analyses and route selection determinations required under paragraphs (c), (d), and (e) of this section must include a comprehensive, system-wide review of all operational changes, infrastructure modifications, traffic adjustments, changes in the nature of high-consequence targets located along, or in proximity to, the route, and any other changes affecting the safety or security of the movements of the materials specified in paragraph (a) of this section that were implemented during the calendar year.

(3) A rail carrier need not perform a rail transportation route analysis, alternative route analysis, or route selection process for any hazardous material other than the materials specified in paragraph (a) of this section.

(g) *Rail carrier point of contact on routing issues.* Each rail carrier must identify a point of contact (including the name, title, phone number and e-mail address) on routing issues involving the movement of materials covered by this section in its security plan and provide this information to:

(1) State and/or regional Fusion Centers that have been established to coordinate with state, local and tribal officials on security issues and which are located within the area encompassed by the rail carrier's rail system; and

(2) State, local, and tribal officials in jurisdictions that may be affected by a rail carrier's routing decisions and who directly contact the railroad to discuss routing decisions.

(h) *Storage, delays in transit, and notification.* With respect to the materials specified in paragraph (a) of this section, each rail carrier must ensure the safety and security plan it develops and implements under this subpart includes all of the following:

(1) A procedure under which the rail carrier must consult with offerors and

§ 172.822

49 CFR Ch. I (10–1–14 Edition)

consignees in order to develop measures for minimizing, to the extent practicable, the duration of any storage of the material incidental to movement (see §171.8 of this subchapter).

(2) Measures to prevent unauthorized access to the materials during storage or delays in transit.

(3) Measures to mitigate risk to population centers associated with in-transit storage.

(4) Measures to be taken in the event of an escalating threat level for materials stored in transit.

(5) Procedures for notifying the consignee in the event of a significant delay during transportation; such notification must be completed within 48 hours after the carrier has identified the delay and must include a revised delivery schedule. A significant delay is one that compromises the safety or security of the hazardous material or delays the shipment beyond its normal expected or planned shipping time. Notification should be made by a method acceptable to both the rail carrier and consignee.

(i) *Recordkeeping.* (1) Each rail carrier must maintain a copy of the information specified in paragraphs (b), (c), (d), (e), and (f) of this section (or an electronic image thereof) that is accessible at, or through, its principal place of business and must make the record available upon request, at a reasonable time and location, to an authorized official of the Department of Transportation or the Department of Homeland Security. Records must be retained for a minimum of two years.

(2) Each rail carrier must restrict the distribution, disclosure, and availability of information collected or developed in accordance with paragraphs (c), (d), (e), and (f) of this section to covered persons with a need-to-know, as described in parts 15 and 1520 of this title.

(j) *Compliance and enforcement.* If the carrier's route selection documentation and underlying analyses are found to be deficient, the carrier may be required to revise the analyses or make changes in route selection. If DOT finds that a chosen route is not the safest and most secure practicable route available, the FRA Associate Adminis-

trator for Safety, in consultation with TSA, may require the use of an alternative route. Prior to making such a determination, FRA and TSA will consult with the Surface Transportation Board (STB) regarding whether the contemplated alternative route(s) would be economically practicable.

[73 FR 20771, Apr. 16, 2008, as amended at 73 FR 72193, Dec. 26, 2008; 76 FR 56314, Sept. 13, 2011]

§ 172.822 Limitation on actions by states, local governments, and Indian tribes.

A law, order, or other directive of a state, political subdivision of a state, or an Indian tribe that designates, limits, or prohibits the use of a rail line (other than a rail line owned by a state, political subdivision of a state, or an Indian tribe) for the transportation of hazardous materials, including, but not limited to, the materials specified in §172.820(a), is preempted. 49 U.S.C. 5125, 20106.

[73 FR 20772, Apr. 16, 2008]

APPENDIX A TO PART 172—OFFICE OF HAZARDOUS MATERIALS TRANSPORTATION COLOR TOLERANCE CHARTS AND TABLES

The following are Munsell notations and Commission Internationale de L'Eclairage (CIE) coordinates which describe the Office of Hazardous Materials Transportation Label and Placard Color Tolerance Charts in tables 1 and 2, and the CIE coordinates for the color tolerances specified in table 3. Central colors and tolerances described in table 2 approximate those described in table 1 while allowing for differences in production methods and materials used to manufacture labels and placards surfaced with printing inks. Primarily, the color charts based on table 1 are for label or placard colors applied as opaque coatings such as paint, enamel or plastic, whereas color charts based on table 2 are intended for use with labels and placards surfaced only with inks.

For labels printed directly on packaging surfaces, table 3 may be used, although compliance with either table 1 or table 2 is sufficient. However, if visual reference indicates that the colors of labels printed directly on package surfaces are outside the table 1 or 2 tolerances, a spectrophotometer or other instrumentation may be required to insure compliance with table 3.

TABLE 1—SPECIFICATIONS FOR COLOR TOLERANCE CHARTS FOR USE WITH LABELS AND PLACARDS SURFACED WITH PAINT, LACQUER, ENAMEL, PLASTIC, OTHER OPAQUE COATINGS, OR INK¹

Color	Munsell notations	CIE data for source C		
		Y	x	y
Red:				
Central color	7.5R 4.0/14	12.00	.5959	.3269
Orange	8.5R 4.0/14	12.00	.6037	.3389
Purple and vivid	6.5R 4.0/14	12.00	.5869	.3184
Grayish	7.5R 4.0/12	12.00	.5603	.3321
Vivid	7.5R 4.0/16	12.00	.6290	.3192
Light	7.5R 4.5/14	15.57	.5775	.3320
Dark	7.5R 3.5/14	09.00	.6226	.3141
Orange:				
Central color	5.OYR 6.0/15	30.05	.5510	.4214
Yellow and Grayish	6.25YR 6.0/15	30.05	.5452	.4329
Red and vivid	3.75YR 6.0/15	30.05	.5552	.4091
Grayish	5.OYR 6.0/13	30.05	.5311	.4154
Vivid	5.OYR 6.0/16	30.05	.5597	.4239
Light	5.OYR 6.5/15	36.20	.5427	.4206
Dark	5.OYR 5.5/15	24.58	.5606	.4218
Yellow:				
Central color	5.OY 8.0/12	59.10	.4562	.4788
Green	6.5Y 8.0/12	59.10	.4498	.4865
Orange and vivid	3.5Y 8.0/12	59.10	.4632	.4669
Grayish	5.OY 8.0/10	59.10	.4376	.4601
Vivid	5.OY 8.0/14	59.10	.4699	.4920
Light	5.OY 8.5/12	68.40	.4508	.4754
Dark	5.OY 7.5/12	50.68	.4620	.4823
Green:				
Central color	7.5G 4.0/9	12.00	.2111	.4121
Bluish	0.5BG 4.0/9	12.00	.1974	.3809
Green-yellow	5.0G 4.0/9	12.00	.2237	.4399
Grayish A	7.5G 4.0/7	12.00	.2350	.3922
Grayish B ²	7.5G 4.0/6	12.00	.2467	.3822
Vivid	7.5G 4.0/11	12.00	.1848	.4319
Light	7.5G 4.5/9	15.57	.2204	.4060
Dark	7.5G 3.5/9	09.00	.2027	.4163
Blue:				
Central color	2.5PB 3.5/10	09.00	.1691	.1744
Purple	4.5PB 3.5/10	09.00	.1796	.1711
Green and vivid	10.0B 3.5/10	09.00	.1557	.1815
Grayish	2.5PB 3.5/8	09.00	.1888	.1964
Vivid	2.5PB 3.5/12	09.00	.1516	.1547
Light	2.5PB 4.0/10	12.00	.1805	.1888
Dark	2.5PB 3.0/10	06.55	.1576	.1600
Purple:				
Central color	10.0P 4.5/10	15.57	.3307	.2245
Reddish purple	2.5RP 4.5/10	15.57	.3584	.2377
Blue purple	7.5P 4.5/10	15.57	.3068	.2145
Reddish gray	10.0P 4.5/8	15.57	.3280	.2391
Gray ²	10.0P 4.5/6.5	15.57	.3254	.2519
Vivid	10.0P 4.5/12	15.57	.3333	.2101
Light	10.0P 5.0/10	19.77	.3308	.2328
Dark	10.0P 4.0/10	12.00	.3306	.2162

¹ Maximum chroma is not limited.
² For the colors green and purple, the minimum saturation (chroma) limits for porcelain enamel on metal are lower than for most other surface coatings. Therefore, the minimum chroma limits of these two colors as displayed on the Charts for comparison to porcelain enamel on metal is low, as shown for green (grayish B) and purple (gray).
 NOTE: CIE=Commission Internationale de L'Eclairage.

TABLE 2—SPECIFICATIONS FOR COLOR TOLERANCE CHARTS FOR USE WITH LABELS AND PLACARDS SURFACED WITH INK

Color/series	Munsell notation	CIE data for source C		
		Y	x	y
Red:				
Central series:				
Central color	6.8R 4.47/12.8	15.34	.5510	.3286
Grayish	7.2R 4.72/12.2	17.37	.5368	.3348
Purple	6.4R 4.49/12.7	15.52	.5442	.3258
Purple and vivid	6.1R 4.33/13.1	14.25	.5529	.3209

TABLE 2—SPECIFICATIONS FOR COLOR TOLERANCE CHARTS FOR USE WITH LABELS AND PLACARDS SURFACED WITH INK—Continued

Color/series	Munsell notation	CIE data for source C		
		Y	x	y
Vivid	6.7R 4.29/13.2	13.99	.5617	.3253
Orange	7.3R 4.47/12.8	15.34	.5572	.3331
Orange and grayish	7.65R 4.70/12.4	17.20	.5438	.3382
Light series:				
Light	7.0R 4.72/13.2	17.32	.5511	.3322
Light and orange	7.4R 4.96/12.6	19.38	.5365	.3392
Light and purple	6.6R 4.79/12.9	17.94	.5397	.3289
Dark series:				
Dark A	6.7R 4.19/12.5	13.30	.5566	.3265
Dark B	7.0R 4.25/12.35	13.72	.5522	.3294
Dark and purple	7.5R 4.23/12.4	13.58	.5577	.3329
Orange:				
Central series:				
Central color	5.0YR 6.10/12.15	31.27	.5193	.4117
Yellow and grayish A	5.8YR 6.22/11.7	32.69	.5114	.4155
Yellow and grayish B	6.1YR 6.26/11.85	33.20	.5109	.4190
Vivid	5.1YR 6.07/12.3	30.86	.5226	.4134
Red and vivid A	3.9YR 5.87/12.75	28.53	.5318	.4038
Red and vivid B	3.6YR 5.91/12.6	29.05	.5291	.4021
Grayish	4.9YR 6.10/11.9	31.22	.5170	.4089
Light series:				
Light and vivid A	5.8YR 6.78/12.7	39.94	.5120	.4177
Light and yellow	6.0YR 6.80/12.8	40.20	.5135	.4198
Light and vivid B	4.9YR 6.60/12.9	37.47	.5216	.4126
Dark series:				
Dark and yellow	5.8YR 5.98/11.0	29.87	.5052	.4132
Dark A	5.1YR 5.80/11.1	27.80	.5127	.4094
Dark B	5.0YR 5.80/11.0	27.67	.5109	.4068
Yellow:				
Central series:				
Central color	4.3Y 7.87/10.3	56.81	.4445	.4589
Vivid A	4.5Y 7.82/10.8	55.92	.4503	.4658
Vivid B	3.3Y 7.72/11.35	54.24	.4612	.4624
Vivid and orange	3.2Y 7.72/10.8	54.25	.4576	.4572
Grayish A	4.1Y 7.95/9.7	58.18	.4380	.4516
Grayish B	5.1Y 8.06/9.05	60.12	.4272	.4508
Green-yellow	5.2Y 7.97/9.9	58.53	.4356	.4605
Light series:				
Light	5.4Y 8.59/10.5	70.19	.4351	.4628
Light and green-yellow	5.4Y 8.56/11.2	69.59	.4414	.4692
Light and vivid	4.4Y 8.45/11.4	67.42	.4490	.4662
Dark series:				
Dark and green-yellow	4.4Y 7.57/9.7	51.82	.4423	.4562
Dark and orange A	3.4Y 7.39/10.4	48.86	.4584	.4590
Dark and orange B	3.5Y 7.41/10.0	49.20	.4517	.4544
Green:				
Central series:				
Central color	9.75G 4.26/7.75	13.80	.2214	.3791
Grayish	10G 4.46/7.5	15.25	.2263	.3742
Blue A	1.4BG 4.20/7.4	13.36	.2151	.3625
Blue B	1.0BG 4.09/7.75	12.60	.2109	.3685
Vivid	8.4G 4.09/8.05	12.59	.2183	.3954
Vivid green-yellow	7.0G 4.23/8.0	13.54	.2292	.4045
Green-yellow	7.85G 4.46/7.7	15.23	.2313	.3914
Light series:				
Light and vivid	9.5G 4.45/8.8	15.21	.2141	.3863
Light and blue	0.2BG 4.31/8.8	14.12	.2069	.3814
Light and green-yellow	8.3G 4.29/9.05	14.01	.2119	.4006
Dark series:				
Dark and green-yellow	7.1G 4.08/7.1	12.55	.2354	.3972
Dark and grayish	9.5G 4.11/6.9	12.70	.2282	.3764
Dark	8.5G 3.97/7.2	11.78	.2269	.3874
Blue:				
Central series:				
Central color	3.5PB 3.94/9.7	11.58	.1885	.1911
Green and grayish A	2.0PB 4.35/8.7	14.41	.1962	.2099
Green and grayish B	1.7PB 4.22/9.0	13.50	.1898	.2053
Vivid	2.9PB 3.81/9.7	10.78	.1814	.1852
Purple and vivid A	4.7PB 3.53/10.0	9.15	.1817	.1727

TABLE 2—SPECIFICATIONS FOR COLOR TOLERANCE CHARTS FOR USE WITH LABELS AND PLACARDS SURFACED WITH INK—Continued

Color/series	Munsell notation	CIE data for source C		
		Y	x	y
Purple and vivid B	5.0PB 3.71/9.9	10.20	.1888	.1788
Grayish	3.75PB 4.03/9.1	12.17	.1943	.1961
Light series:				
Light and green A	1.7PB 4.32/9.2	14.22	.1904	.2056
Light and green B	1.5PB 4.11/9.6	12.72	.1815	.1971
Light and vivid	3.2PB 3.95/10.05	11.70	.1831	.1868
Dark series:				
Dark and grayish	3.9PB 4.01/8.7	12.04	.1982	.1992
Dark and purple A	4.8PB 3.67/9.3	9.95	.1918	.1831
Dark and purple B	5.2PB 3.80/9.05	10.76	.1985	.1885
Purple:				
Central series:				
Central color	9.5P 4.71/11.3	17.25	.3274	.2165
Red	1.0RP 5.31/10.8	22.70	.3404	.2354
Red and vivid A	1.4RP 5.00/11.9	19.78	.3500	.2274
Red and vivid B	0.2RP 4.39/12.5	14.70	.3365	.2059
Vivid	8.0P 4.04/12.0	12.23	.3098	.1916
Blue	7.0P 4.39/10.8	14.71	.3007	.2037
Grayish	8.8P 5.00/10.3	19.73	.3191	.2251
Light series:				
Light and red A	0.85RP 5.56/11.1	25.18	.3387	.2356
Light and red B	1.1RP 5.27/12.3	22.27	.3460	.2276
Light and vivid	9.2P 4.94/11.95	19.24	.3247	.2163
Dark series:				
Dark and grayish	9.6P 4.70/10.9	17.19	.3283	.2204
Dark and vivid	8.4P 4.05/11.6	12.35	.3144	.1970
Dark and blue	7.5P 4.32/10.5	14.19	.3059	.2078

TABLE 3—SPECIFICATION FOR COLORS FOR USE WITH LABELS PRINTED ON PACKAGINGS SURFACES

CIE data for source C	Red	Orange	Yellow	Green	Blue	Purple
x424	.460	.417	.228	.200	.377
y306	.370	.392	.354	.175	.205
x571	.543	.490	.310	.255	.377
y306	.400	.442	.354	.250	.284
x424	.445	.390	.228	.177	.342
y350	.395	.430	.403	.194	.205
x571	.504	.440	.310	.230	.342
y350	.430	.492	.403	.267	.284
Y (high)	23.0	41.6	72.6	20.6	15.9	21.2
Y (low)	7.7	19.5	29.1	7.4	6.5	8.2

[Amdt. 172-50, 44 FR 9757, Feb. 15, 1979; Amdt. 172-50, 44 FR 10984, Feb. 26, 1979, as amended by Amdt. 172-50, 44 FR 22467, Apr. 16, 1979; 50 FR 45731, Nov. 1, 1985; Amdt. 172-127, 59 FR 49133, Sept. 26, 1994]

APPENDIX B TO PART 172—TREFOIL SYMBOL

1. Except as provided in paragraph 2 of this appendix, the trefoil symbol required for RADIOACTIVE labels and placards and required to be marked on certain packages of Class 7

materials must conform to the design and size requirements of this appendix.

2. RADIOACTIVE labels and placards that were printed prior to April 1, 1996, in conformance with the requirements of this subchapter in effect on March 30, 1996, may continue to be used.

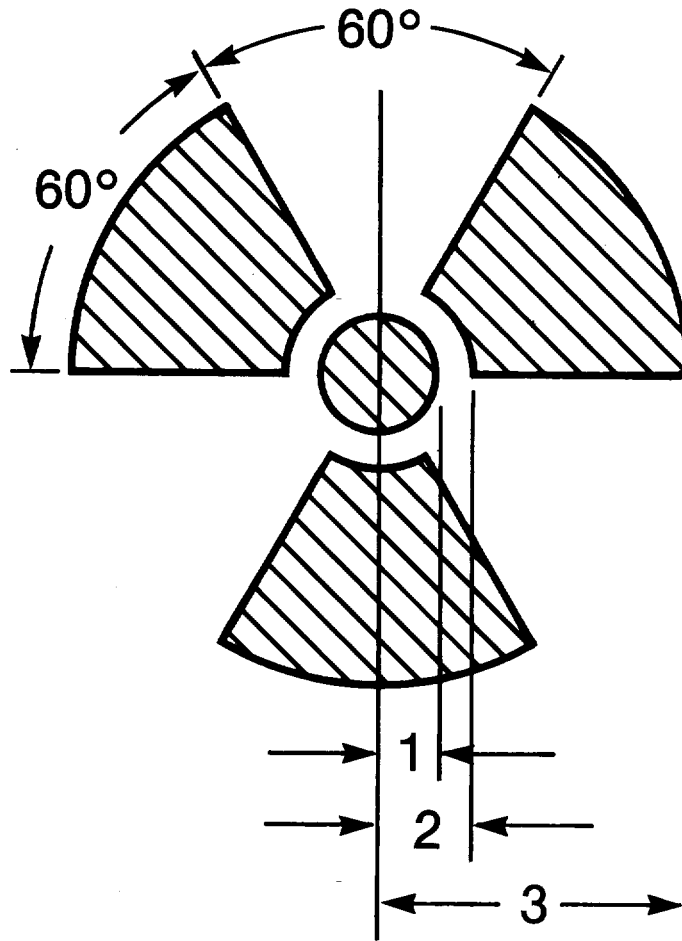

1=Radius of Circle—
Minimum dimensions
4 mm (0.16 inch) for markings and labels
12.5 mm (0.5 inch) for placards
2=1½ Radii

3=5 radii for markings and labels
4½ radii for placards.

[60 FR 50306, Sept. 28, 1995, as amended by
172-143, 61 FR 20750, May 8, 1996]

APPENDIX C TO PART 172—DIMENSIONAL SPECIFICATIONS FOR RECOMMENDED PLACARD HOLDER

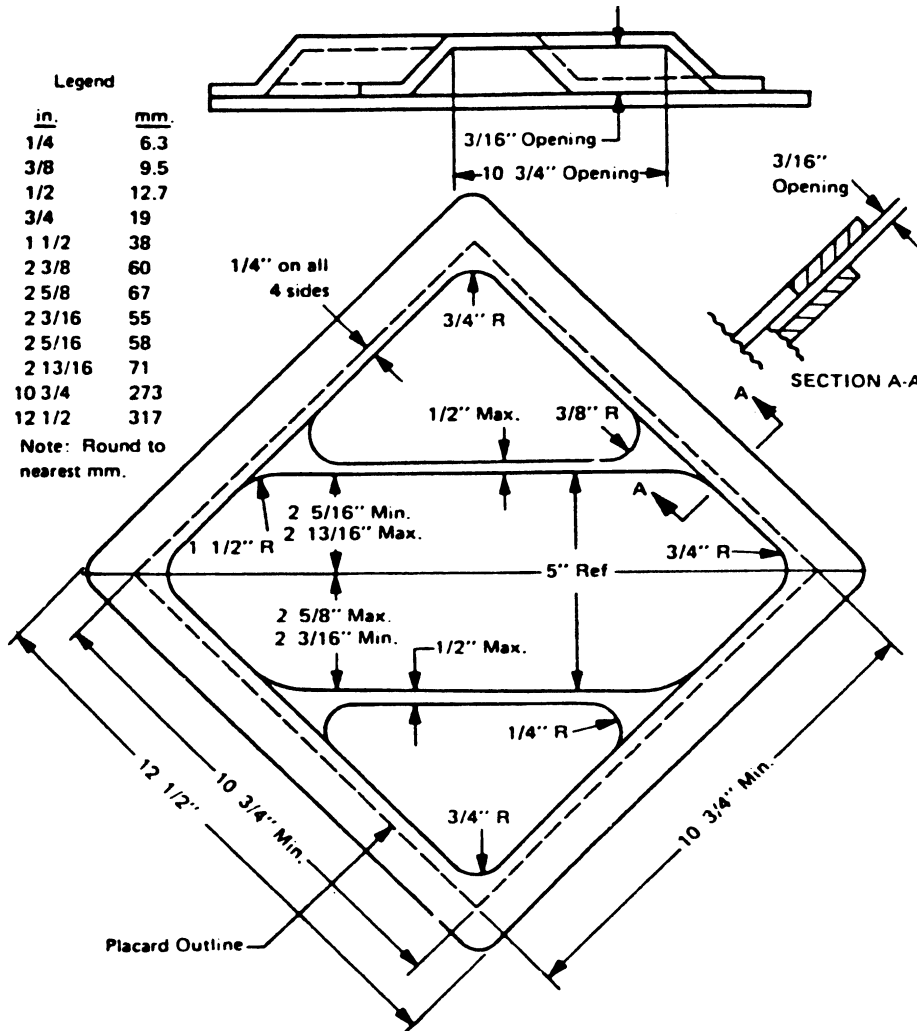

APPENDIX D TO PART 172—RAIL RISK ANALYSIS FACTORS

A. This appendix sets forth the minimum criteria that must be considered by rail carriers when performing the safety and security risk analyses required by §172.820. The risk analysis to be performed may be quantitative, qualitative, or a combination of both. In addition to clearly identifying the hazardous material(s) and route(s) being analyzed, the analysis must provide a thorough

description of the threats, identified vulnerabilities, and mitigation measures implemented to address identified vulnerabilities.

B. In evaluating the safety and security of hazardous materials transport, selection of the route for transportation is critical. For the purpose of rail transportation route analysis, as specified in §172.820(c) and (d), a route may include the point where the carrier takes possession of the material and all track and railroad facilities up to the point

where the material is relinquished to another entity. Railroad facilities are railroad property including, but not limited to, classification and switching yards, storage facilities, and non-private sidings; however, they do not include an offeror's facility, private track, private siding, or consignee's facility. Each rail carrier must use best efforts to communicate with its shippers, consignees, and interlining partners to ensure the safety and security of shipments during all stages of transportation.

C. Because of the varying operating environments and interconnected nature of the rail system, each carrier must select and document the analysis method/model used and identify the routes to be analyzed.

D. The safety and security risk analysis must consider current data and information as well as changes that may reasonably be anticipated to occur during the analysis year. Factors to be considered in the performance of this safety and security risk analysis include:

1. Volume of hazardous material transported;
2. Rail traffic density;
3. Trip length for route;
4. Presence and characteristics of railroad facilities;
5. Track type, class, and maintenance schedule;
6. Track grade and curvature;
7. Presence or absence of signals and train control systems along the route ("dark" versus signaled territory);
8. Presence or absence of wayside hazard detectors;
9. Number and types of grade crossings;
10. Single versus double track territory;
11. Frequency and location of track turn-outs;
12. Proximity to iconic targets;
13. Environmentally sensitive or significant areas;
14. Population density along the route;
15. Venues along the route (stations, events, places of congregation);
16. Emergency response capability along the route;
17. Areas of high consequence along the route, including high consequence targets as defined in §172.820(c);
18. Presence of passenger traffic along route (shared track);
19. Speed of train operations;
20. Proximity to en-route storage or repair facilities;
21. Known threats, including any non-public threat scenarios provided by the Department of Homeland Security or the Department of Transportation for carrier use in the development of the route assessment;
22. Measures in place to address apparent safety and security risks;
23. Availability of practicable alternative routes;

24. Past incidents;
25. Overall times in transit;
26. Training and skill level of crews; and
27. Impact on rail network traffic and congestion.

[73 FR 20772, Apr. 16, 2008]

PART 173—SHIPPERS—GENERAL REQUIREMENTS FOR SHIPMENTS AND PACKAGINGS

Subpart A—General

Sec.

- 173.1 Purpose and scope.
- 173.2 Hazardous materials classes and index to hazard class definitions.
- 173.2a Classification of a material having more than one hazard.
- 173.3 Packaging and exceptions.
- 173.4 Small quantity exceptions.
- 173.4a Excepted quantities.
- 173.5 Agricultural operations.
- 173.5a Oilfield service vehicles, mechanical displacement meter provers, and roadway striping vehicles exceptions.
- 173.5b Portable and mobile refrigeration systems.
- 173.6 Materials of trade exceptions.
- 173.7 Government operations and materials.
- 173.8 Exceptions for non-specification packagings used in intrastate transportation.
- 173.9 Transport vehicles or freight containers containing lading which has been fumigated.
- 173.10 Tank car shipments.
- 173.12 Exceptions for shipment of waste materials.
- 173.13 Exceptions for Class 3, Divisions 4.1, 4.2, 4.3, 5.1, 6.1, and Classes 8 and 9 materials.

Subpart B—Preparation of Hazardous Materials for Transportation

- 173.21 Forbidden materials and packages.
- 173.22 Shipper's responsibility.
- 173.22a Use of packagings authorized under special permits.
- 173.23 Previously authorized packaging.
- 173.24 General requirements for packagings and packages.
- 173.24a Additional general requirements for non-bulk packagings and packages.
- 173.24b Additional general requirements for bulk packagings.
- 173.25 Authorized packagings and over-packs.
- 173.26 Quantity limitations.
- 173.27 General requirements for transportation by aircraft.
- 173.28 Reuse, reconditioning and remanufacture of packagings.
- 173.29 Empty packagings.
- 173.30 Loading and unloading of transport vehicles.

- 173.31 Use of tank cars.
- 173.32 Requirements for the use of portable tanks.
- 173.33 Hazardous materials in cargo tank motor vehicles.
- 173.34 [Reserved]
- 173.35 Hazardous materials in intermediate bulk containers (IBCs).
- 173.36 Hazardous materials in Large Packagings.
- 173.37 Hazardous Materials in Flexible Bulk Containers.
- 173.40 General packaging requirements for toxic materials packaged in cylinders.

Subpart C—Definitions, Classification and Packaging for Class 1

- 173.50 Class 1—Definitions.
- 173.51 Authorization to offer and transport explosives.
- 173.52 Classification codes and compatibility groups of explosives.
- 173.53 Provisions for using old classifications of explosives.
- 173.54 Forbidden explosives.
- 173.55 [Reserved]
- 173.56 New explosives—Definition and procedures for classification and approval.
- 173.57 Acceptance criteria for new explosives.
- 173.58 Assignment of class and division for new explosives.
- 173.59 Description of terms for explosives.
- 173.60 General packaging requirements for explosives.
- 173.61 Mixed packaging requirements.
- 173.62 Specific packaging requirements for explosives.
- 173.63 Packaging exceptions.
- 173.64 Exceptions for Division 1.3 and 1.4 fireworks.
- 173.65 Exceptions for Division 1.4G consumer fireworks.

Subpart D—Definitions, Classification, Packing Group Assignments and Exceptions for Hazardous Material Other Than Class 1 and Class 7

- 173.115 Class 2, Divisions 2.1, 2.2, and 2.3—Definitions.
- 173.116 Class 2—Assignment of hazard zone.
- 173.117–173.119 [Reserved]
- 173.120 Class 3—Definitions.
- 173.121 Class 3—Assignment of packing group.
- 173.124 Class 4, Divisions 4.1, 4.2 and 4.3—Definitions.
- 173.125 Class 4—Assignment of packing group.
- 173.127 Class 5, Division 5.1—Definition and assignment of packing groups.
- 173.128 Class 5, Division 5.2—Definitions and types.
- 173.129 Class 5, Division 5.2—Assignment of packing group.

- 173.132 Class 6, Division 6.1—Definitions.
- 173.133 Assignment of packing group and hazard zones for Division 6.1 materials.
- 173.134 Class 6, Division 6.2—Definitions and exceptions.
- 173.136 Class 8—Definitions.
- 173.137 Class 8—Assignment of packing group.
- 173.140 Class 9—Definitions.
- 173.141 Class 9—Assignment of packing group.
- 173.144 Other Regulated Materials (ORM)—Definitions.
- 173.145 Other Regulated Materials—Assignment of packing group.
- 173.150 Exceptions for Class 3 (flammable and combustible liquids).
- 173.151 Exceptions for Class 4.
- 173.152 Exceptions for Division 5.1 (oxidizers) and Division 5.2 (organic peroxides).
- 173.153 Exceptions for Division 6.1 (poisonous materials).
- 173.154 Exceptions for Class 8 (corrosive materials).
- 173.155 Exceptions for Class 9 (miscellaneous hazardous materials).
- 173.156 Exceptions for limited quantity and ORM.

Subpart E—Non-bulk Packaging for Hazardous Materials Other Than Class 1 and Class 7

- 173.158 Nitric acid.
- 173.159 Batteries, wet.
- 173.159a Exceptions for non-spillable batteries.
- 173.160 Bombs, smoke, non-explosive (corrosive).
- 173.161 Chemical kits and first aid kits.
- 173.162 Gallium.
- 173.163 Hydrogen fluoride.
- 173.164 Mercury (metallic and articles containing mercury).
- 173.165 Polyester resin kits.
- 173.166 Air bag inflators, air bag modules and seat-belt pretensioners.
- 173.167 Consumer commodities.
- 173.168 Chemical oxygen generators.
- 173.170 Black powder for small arms.
- 173.171 Smokeless powder for small arms.
- 173.172 Aircraft hydraulic power unit fuel tank.
- 173.173 Paint, paint-related material, adhesives and ink and resins.
- 173.174 Refrigerating machines.
- 173.175 Permeation devices.
- 173.176 Capacitors.
- 173.181 Pyrophoric materials (liquids).
- 173.182 Barium azide—50 percent or more water wet.
- 173.183 Nitrocellulose base film.
- 173.184 Highway or rail fusee.
- 173.185 Lithium batteries and cells.
- 173.186 Matches.

Pt. 173

49 CFR Ch. I (10–1–14 Edition)

- 173.187 Pyrophoric solids, metals or alloys, n.o.s.
- 173.188 White or yellow phosphorous.
- 173.189 Batteries containing sodium or cells containing sodium.
- 173.192 Packaging for certain toxic gases in Hazard Zone A.
- 173.193 Bromoacetone, methyl bromide, chloropicrin and methyl bromide or methyl chloride mixtures, etc.
- 173.194 Gas identification sets.
- 173.195 Hydrogen cyanide, anhydrous, stabilized (hydrocyanic acid, aqueous solution).
- 173.196 Category A infectious substances.
- 173.197 Regulated medical waste.
- 173.198 Nickel carbonyl.
- 173.199 Category B infectious substances.
- 173.201 Non-bulk packagings for liquid hazardous materials in Packing Group I.
- 173.202 Non-bulk packagings for liquid hazardous materials in Packing Group II.
- 173.203 Non-bulk packagings for liquid hazardous materials in Packing Group III.
- 173.204 Non-bulk, non-specification packagings for certain hazardous materials.
- 173.205 Specification cylinders for liquid hazardous materials.
- 173.206 Packaging requirements for chlorosilanes.
- 173.211 Non-bulk packagings for solid hazardous materials in Packing Group I.
- 173.212 Non-bulk packagings for solid hazardous materials in Packing Group II.
- 173.213 Non-bulk packagings for solid hazardous materials in Packing Group III.
- 173.214 Packagings which require approval by the Associate Administrator.
- 173.216 Asbestos, blue, brown, or white.
- 173.217 Carbon dioxide, solid (dry ice).
- 173.218 Fish meal or fish scrap.
- 173.219 Life-saving appliances.
- 173.220 Internal combustion engines, self-propelled vehicles, mechanical equipment containing internal combustion engines, battery-powered equipment or machinery, fuel cell-powered equipment or machinery.
- 173.221 Polymeric beads, expandable and Plastic molding compound.
- 173.222 Dangerous good in machinery or apparatus.
- 173.223 Packagings for certain flammable solids.
- 173.224 Packaging and control and emergency temperatures for self-reactive materials.
- 173.225 Packaging requirements and other provisions for organic peroxides.
- 173.226 Materials poisonous by inhalation, Division 6.1, Packing Group I, Hazard Zone A.
- 173.227 Materials poisonous by inhalation, Division 6.1, Packing Group I, Hazard Zone B.
- 173.228 Bromine pentafluoride or bromine trifluoride.

- 173.229 Chloric acid solution or chlorine dioxide hydrate, frozen.
- 173.230 Fuel cell cartridges containing hazardous material.

Subpart F—Bulk Packaging for Hazardous Materials Other Than Class 1 and Class 7

- 173.240 Bulk packaging for certain low hazard solid materials.
- 173.241 Bulk packagings for certain low hazard liquid and solid materials.
- 173.242 Bulk packagings for certain medium hazard liquids and solids, including solids with dual hazards.
- 173.243 Bulk packaging for certain high hazard liquids and dual hazard materials which pose a moderate hazard.
- 173.244 Bulk packaging for certain pyrophoric liquids (Division 4.2), dangerous when wet (Division 4.3) materials, and poisonous liquids with inhalation hazards (Division 6.1).
- 173.245 Bulk packaging for extremely hazardous materials such as poisonous gases (Division 2.3).
- 173.247 Bulk packaging for certain elevated temperature materials.
- 173.249 Bromine.

Subpart G—Gases; Preparation and Packaging

- 173.300 [Reserved]
- 173.301 General requirements for shipment of compressed gases and other hazardous materials in cylinders, UN pressure receptacles and spherical pressure vessels.
- 173.301a Additional general requirements for shipment of specification cylinders.
- 173.301b Additional general requirements for shipment of UN pressure receptacles.
- 173.302 Filling of cylinders with nonliquefied (permanent) compressed gases.
- 173.302a Additional requirements for shipment nonliquefied (permanent) compressed gases in specification cylinders.
- 173.302b Additional requirements for shipment of non-liquefied (permanent) compressed gases in UN pressure receptacles.
- 173.303 Charging of cylinders with compressed gas in solution (acetylene).
- 173.304 Filling of cylinders with liquefied compressed gases.
- 173.304a Additional requirements for shipment of liquefied compressed gases in specification cylinders.
- 173.304b Additional requirements for shipment of liquefied compressed gases in UN pressure receptacles.
- 173.305 Charging of cylinders with a mixture of compressed gas and other material.
- 173.306 Limited quantities of compressed gases.
- 173.307 Exceptions for compressed gases.
- 173.308 Cigarette lighter or other similar device charged with fuel.

- 173.309 Fire extinguishers.
- 173.310 Exceptions for radiation detectors.
- 173.311 Metal hydride storage systems.
- 173.312 Requirements for shipment of MEGCs.
- 173.313 UN Portable Tank Table for Liquefied Compressed Gases and Chemical Under Pressure.
- 173.314 Compressed gases in tank cars and multi-unit tank cars.
- 173.315 Compressed gases in cargo tanks and portable tanks.
- 173.316 Cryogenic liquids in cylinders.
- 173.318 Cryogenic liquids in cargo tanks.
- 173.319 Cryogenic liquids in tank cars.
- 173.320 Cryogenic liquids; exceptions.
- 173.321 Ethylamine.
- 173.322 Ethyl chloride.
- 173.323 Ethylene oxide.
- 173.334 Organic phosphates mixed with compressed gas.
- 173.335 Chemical under pressure n.o.s.
- 173.336 Nitrogen dioxide, liquefied, or dinitrogen tetroxide, liquefied.
- 173.337 Nitric oxide.
- 173.338 Tungsten hexafluoride.
- 173.340 Tear gas devices.
- 173.428 Empty Class 7 (radioactive) materials packaging.
- 173.431 Activity limits for Type A and Type B packages.
- 173.433 Requirements for determining basic radionuclide values, and for the listing of radionuclides on shipping papers and labels.
- 173.434 Activity-mass relationships for uranium and natural thorium.
- 173.435 Table of A_1 and A_2 values for radionuclides.
- 173.436 Exempt material activity concentrations and exempt consignment activity limits for radionuclides.
- 173.441 Radiation level limitations and exclusive use provisions.
- 173.442 Thermal limitations.
- 173.443 Contamination control.
- 173.447 Storage incident to transportation—general requirements.
- 173.448 General transportation requirements.
- 173.453 Fissile materials—exceptions.
- 173.457 Transportation of fissile material packages—specific requirements.
- 173.459 Mixing of fissile material packages with non-fissile or fissile-excepted material packages.
- 173.461 Demonstration of compliance with tests.
- 173.462 Preparation of specimens for testing.
- 173.465 Type A packaging tests.
- 173.466 Additional tests for Type A packagings designed for liquids and gases.
- 173.467 Tests for demonstrating the ability of Type B and fissile materials packagings to withstand accident conditions in transportation.
- 173.468 Test for LSA-III material.
- 173.469 Tests for special form Class 7 (radioactive) materials.
- 173.471 Requirements for U.S. Nuclear Regulatory Commission approved packages.
- 173.472 Requirements for exporting DOT Specification Type B and fissile packages.
- 173.473 Requirements for foreign-made packages.
- 173.474 Quality control for construction of packaging.
- 173.475 Quality control requirements prior to each shipment of Class 7 (radioactive) materials.
- 173.476 Approval of special form Class 7 (radioactive) materials.
- 173.477 Approval of packagings containing greater than 0.1 kg of non-fissile or fissile-excepted uranium hexafluoride.

Subpart H [Reserved]

Subpart I—Class 7 (Radioactive) Materials

- 173.401 Scope.
- 173.403 Definitions.
- 173.410 General design requirements.
- 173.411 Industrial packages.
- 173.412 Additional design requirements for Type A packages.
- 173.413 Requirements for Type B packages.
- 173.415 Authorized Type A packages.
- 173.416 Authorized Type B packages.
- 173.417 Authorized fissile materials packages.
- 173.418 Authorized packages—pyrophoric Class 7 (radioactive) materials.
- 173.419 Authorized packages—oxidizing Class 7 (radioactive) materials.
- 173.420 Uranium hexafluoride (fissile, fissile excepted and non-fissile).
- 173.421 Excepted packages for limited quantities of Class 7 (radioactive) materials.
- 173.422 Additional requirements for excepted packages containing Class 7 (radioactive) materials.
- 173.423 Requirements for multiple hazard limited quantity Class 7 (radioactive) materials.
- 173.424 Excepted packages for radioactive instruments and articles.
- 173.425 Table of activity limits—excepted quantities and articles.
- 173.426 Excepted packages for articles containing natural uranium or thorium.
- 173.427 Transport requirements for low specific activity (LSA) Class 7 (radioactive) material and surface contaminated objects (SCO).
- 173.461 Demonstration of compliance with tests.
- 173.462 Preparation of specimens for testing.
- 173.465 Type A packaging tests.
- 173.466 Additional tests for Type A packagings designed for liquids and gases.
- 173.467 Tests for demonstrating the ability of Type B and fissile materials packagings to withstand accident conditions in transportation.
- 173.468 Test for LSA-III material.
- 173.469 Tests for special form Class 7 (radioactive) materials.
- 173.471 Requirements for U.S. Nuclear Regulatory Commission approved packages.
- 173.472 Requirements for exporting DOT Specification Type B and fissile packages.
- 173.473 Requirements for foreign-made packages.
- 173.474 Quality control for construction of packaging.
- 173.475 Quality control requirements prior to each shipment of Class 7 (radioactive) materials.
- 173.476 Approval of special form Class 7 (radioactive) materials.
- 173.477 Approval of packagings containing greater than 0.1 kg of non-fissile or fissile-excepted uranium hexafluoride.

Subparts J–O [Reserved]

- APPENDIX A TO PART 173 [RESERVED]
- APPENDIX B TO PART 173—PROCEDURE FOR TESTING CHEMICAL COMPATIBILITY AND RATE OF PERMEATION IN PLASTIC PACKAGING AND RECEPTACLES

§ 173.1

49 CFR Ch. I (10–1–14 Edition)

APPENDIX C TO PART 173—PROCEDURE FOR BASE-LEVEL VIBRATION TESTING

APPENDIX D TO PART 173—TEST METHODS FOR DYNAMITE (EXPLOSIVE, BLASTING, TYPE A)

APPENDIXES E–G TO PART 173 [RESERVED]

APPENDIX H TO PART 173—METHOD OF TESTING FOR SUSTAINED COMBUSTIBILITY

AUTHORITY: 49 U.S.C. 5101–5128, 44701; 49 CFR 1.81, 1.96 and 1.97.

EDITORIAL NOTE: Nomenclature changes to part 173 appear at 70 FR 56098, Sept. 23, 2005.

Subpart A—General

§ 173.1 Purpose and scope.

(a) This part includes:

(1) Definitions of hazardous materials for transportation purposes;

(2) Requirements to be observed in preparing hazardous materials for shipment by air, highway, rail, or water, or any combination thereof; and

(3) Inspection, testing, and retesting responsibilities for persons who retest, recondition, maintain, repair and rebuild containers used or intended for use in the transportation of hazardous materials.

(b) A shipment of hazardous materials that is not prepared in accordance with this subchapter may not be offered for transportation by air, highway, rail, or water. It is the responsibility of each hazmat employer subject to the requirements of this subchapter to ensure that each hazmat employee is trained in accordance with the requirements prescribed in this subchapter. It is the duty of each person who offers hazardous materials for transportation to instruct each of his

officers, agents, and employees having any responsibility for preparing hazardous materials for shipment as to applicable regulations in this subchapter.

(c) In general, the Hazardous Materials Regulations (HMR) contained in this subchapter are based on the UN Recommendations and are consistent with international regulations issued by the International Civil Aviation Organization (ICAO Technical Instructions) and the International Maritime Organization (IMDG Code). However, the HMR are not consistent in all respects with the UN Recommendations, the ICAO Technical Instructions or the IMDG Code, and compliance with the HMR will not guarantee acceptance by regulatory bodies outside of the United States.

[Amdt. 173–94, 41 FR 16062, Apr. 15, 1976, as amended by Amdt. 173–100, 41 FR 40476, Sept. 20, 1976; Amdt. 173–161, 48 FR 2655, Jan. 20, 1983; Amdt. 173–224, 55 FR 52606, Dec. 21, 1990; Amdt. 173–231, 57 FR 20953, May 15, 1992; 64 FR 10776, Mar. 5, 1999; 68 FR 61941, Oct. 30, 2003]

§ 173.2 Hazardous materials classes and index to hazard class definitions.

The hazard class of a hazardous material is indicated either by its class (or division) number, its class name, or by the letters “ORM-D”. The following table lists class numbers, division numbers, class or division names and those sections of this subchapter which contain definitions for classifying hazardous materials, including forbidden materials.

Class No.	Division No. (if any)	Name of class or division	49 CFR reference for definitions
None		Forbidden materials	173.21
None		Forbidden explosives	173.54
1	1.1	Explosives (with a mass explosion hazard)	173.50
1	1.2	Explosives (with a projection hazard)	173.50
1	1.3	Explosives (with predominately a fire hazard)	173.50
1	1.4	Explosives (with no significant blast hazard)	173.50
1	1.5	Very insensitive explosives; blasting agents	173.50
1	1.6	Extremely insensitive detonating substances	173.50
2	2.1	Flammable gas	173.115
2	2.2	Non-flammable compressed gas	173.115
2	2.3	Poisonous gas	173.115
3		Flammable and combustible liquid	173.120
4	4.1	Flammable solid	173.124
4	4.2	Spontaneously combustible material	173.124
4	4.3	Dangerous when wet material	173.124
5	5.1	Oxidizer	173.127
5	5.2	Organic peroxide	173.128
6	6.1	Poisonous materials	173.132

Class No.	Division No. (if any)	Name of class or division	49 CFR reference for definitions
6	6.2	Infectious substance (Etiologic agent)	173.134
7		Radioactive material	173.403
8		Corrosive material	173.136
9		Miscellaneous hazardous material	173.140
None		Other regulated material: ORM-D	173.144

[Amdt. 173-224, 55 FR 52606, Dec. 21, 1990, as amended at 57 FR 45460, Oct. 1, 1992; Amdt. 173-234, 58 FR 51531, Oct. 1, 1993]

§ 173.2a Classification of a material having more than one hazard.

(a) *Classification of a material having more than one hazard.* Except as provided in paragraph (c) of this section, a material not specifically listed in the §172.101 table that meets the definition of more than one hazard class or division as defined in this part, shall be classed according to the highest applicable hazard class of the following hazard classes, which are listed in descending order of hazard:

- (1) Class 7 (radioactive materials, other than limited quantities).
- (2) Division 2.3 (poisonous gases).
- (3) Division 2.1 (flammable gases).
- (4) Division 2.2 (nonflammable gases).
- (5) Division 6.1 (poisonous liquids), Packing Group I, poisonous-by-inhalation only.

(6) A material that meets the definition of a pyrophoric material in §173.124(b)(1) of this subchapter (Division 4.2).

(7) A material that meets the definition of a self-reactive material in §173.124(a)(2) of this subchapter (Division 4.1).

(8) Class 3 (flammable liquids), Class 8 (corrosive materials), Division 4.1 (flammable solids), Division 4.2 (spontaneously combustible materials), Division 4.3 (dangerous when wet materials), Division 5.1 (oxidizers) or Division 6.1 (poisonous liquids or solids other than Packing Group I, poisonous-by-inhalation). The hazard class and packing group for a material meeting more than one of these hazards shall be determined using the precedence table in paragraph (b) of this section.

- (9) Combustible liquids.
- (10) Class 9 (miscellaneous hazardous materials).

(b) *Precedence of hazard table for Classes 3 and 8 and Divisions 4.1, 4.2, 4.3, 5.1 and 6.1.* The following table ranks those materials that meet the definition of Classes 3 and 8 and Divisions 4.1, 4.2, 4.3, 5.1 and 6.1:

PRECEDENCE OF HAZARD TABLE
[Hazard class or division and packing group]

	4.2	4.3	5.1 I ¹	5.1 II ¹	5.1 III ¹	6.1, I dermal	6.1, I oral	6.1 II	6.1 III	8, I liquid	8, I solid	8, II liquid	8, II solid	8, III liquid	8, III solid
3 I ²		4.3				3	3	3	3	3	(3)	3	(3)	3	(3)
3 II ²		4.3				3	3	3	3	8	(3)	3	(3)	3	(3)
3 III ²		4.3				6.1	6.1	6.1	3 ⁴	8	(3)	8	(3)	3	(3)
4.1 II ²	4.2	4.3	5.1	4.1	4.1	6.1	6.1	4.1	4.1	(3)	8	(3)	4.1	(3)	4.1
4.1 III ²	4.2	4.3	5.1	4.1	4.1	6.1	6.1	6.1	4.1	(3)	8	(3)	8	(3)	4.1
4.2 II		4.3	5.1	4.2	4.2	6.1	6.1	4.2	4.2	8	8	4.2	4.2	4.2	4.2
4.2 III		4.3	5.1	5.1	4.2	6.1	6.1	6.1	4.2	8	8	8	8	4.2	4.2
4.3 I			5.1	4.3	4.3	6.1	4.3	4.3	4.3	4.3	4.3	4.3	4.3	4.3	4.3
4.3 II			5.1	4.3	4.3	6.1	4.3	4.3	4.3	8	8	4.3	4.3	4.3	4.3
4.3 III			5.1	5.1	4.3	6.1	6.1	6.1	4.3	8	8	8	8	4.3	4.3
5.1 I ¹						5.1	5.1	5.1	5.1	5.1	5.1	5.1	5.1	5.1	5.1
5.1 II ¹						6.1	5.1	5.1	5.1	8	8	5.1	5.1	5.1	5.1
5.1 III ¹						6.1	6.1	6.1	5.1	8	8	8	8	5.1	5.1
6.1 I, Dermal										8	6.1	6.1	6.1	6.1	6.1
6.1 I, Oral										8	6.1	6.1	6.1	6.1	6.1
6.1 II, Inhalation										8	6.1	6.1	6.1	6.1	6.1
6.1 II, Dermal ...										8	6.1	6.1	6.1	6.1	6.1
6.1 II, Oral										8	8	8	6.1	6.1	6.1

PRECEDENCE OF HAZARD TABLE—Continued

[Hazard class or division and packing group]

	4.2	4.3	5.1 I ¹	5.1 II ¹	5.1 III ¹	6.1, I dermal	6.1, I oral	6.1 II	6.1 III	8, I liquid	8, I solid	8, II liquid	8, II solid	8, III liquid	8, III solid
6.1 III										8	8	8	8	8	8

¹ See § 173.127.

² Materials of Division 4.1 other than self-reactive substances and solid desensitized explosives, and materials of Class 3 other than liquid desensitized explosives.

³ Denotes an impossible combination.

⁴ For pesticides only, where a material has the hazards of Class 3, Packing Group III, and Division 6.1, Packing Group III, the primary hazard is Division 6.1, Packing Group III.

NOTE 1: The most stringent packing group assigned to a hazard of the material takes precedence over other packing groups; for example, a material meeting Class 3 PG II and Division 6.1 PG I (oral toxicity) is classified as Class 3 PG I.

NOTE 2: A material which meets the definition of Class 8 and has an inhalation toxicity by dusts and mists which meets criteria for Packing Group I specified in §173.133(a)(1) must be classed as Division 6.1 if the oral or dermal toxicity meets criteria for Packing Group I or II. If the oral or dermal toxicity meets criteria for Packing Group III or less, the material must be classed as Class 8.

(c) The following materials are not subject to the provisions of paragraph (a) of this section because of their unique properties:

(1) A Class 1 (explosive) material that meets any other hazard class or division as defined in this part shall be assigned a division in Class 1. Class 1 materials shall be classed and approved in accordance with §173.56 of this part;

(2) A Division 5.2 (organic peroxide) material that meets the definition of any other hazard class or division as defined in this part, shall be classed as Division 5.2;

(3) A Division 6.2 (infectious substance) material that also meets the definition of another hazard class or division, other than Class 7, or that also is a limited quantity Class 7 material, shall be classed as Division 6.2;

(4) A material that meets the definition of a wetted explosive in §173.124(a)(1) of this subchapter (Division 4.1). Wetted explosives are either specifically listed in the §172.101 table or are approved by the Associate Administrator (see §173.124(a)(1) of this subchapter); and

(5) A limited quantity of a Class 7 (radioactive) material that meets the definition for more than one hazard

class or division shall be classed in accordance with §173.423.

[Amdt. 173–224, 55 FR 52606, Dec. 21, 1990, as amended at 56 FR 66264, Dec. 20, 1991; Amdt. 173–241, 59 FR 67490, Dec. 29, 1994; Amdt. 173–247, 60 FR 48787, Sept. 20, 1995; Amdt. 173–244, 60 FR 50307, Sept. 28, 1995; 64 FR 10776, Mar. 5, 1999; 66 FR 33426, June 21, 2001; 66 FR 45182, 45379, Aug. 28, 2001; 68 FR 45032, July 31, 2003]

§ 173.3 Packaging and exceptions.

(a) The packaging of hazardous materials for transportation by air, highway, rail, or water must be as specified in this part. Methods of manufacture, packing, and storage of hazardous materials, that affect safety in transportation, must be open to inspection by a duly authorized representative of the initial carrier or of the Department. Methods of manufacture and related functions necessary for completion of a DOT specification or U.N. standard packaging must be open to inspection by a representative of the Department.

(b) The regulations setting forth packaging requirements for a specific material apply to all modes of transportation unless otherwise stated, or unless exceptions from packaging requirements are authorized.

(c) *Salvage drums.* Packages of hazardous materials that are damaged, defective, or leaking; packages found to be not conforming to the requirements of this subchapter after having been placed in transportation; and, hazardous materials that have spilled or leaked may be placed in a metal or plastic removable head salvage drum that is compatible with the lading and shipped for repackaging or disposal under the following conditions:

(1) Except as provided in paragraph (c)(7) of this section, the drum must be a UN 1A2, 1B2, 1N2 or 1H2 tested and marked for Packing Group III or higher

performance standards for liquids or solids and a leakproofness test of 20 kPa (3 psig). Alternatively, a drum manufactured and marked prior to October 1, 1993 as a salvage drum, in accordance with the provisions of this section in effect on September 30, 1991, is authorized. Capacity of the drum may not exceed 450 L (119 gallons).

(2) Each drum shall be provided when necessary with sufficient cushioning and absorption material to prevent excessive shifting of the damaged package and to eliminate the presence of any free liquid at the time the salvage drum is closed. All cushioning and absorbent material used in the drum must be compatible with the hazardous material.

(3) Each salvage packaging must be marked with the proper shipping name of the hazardous material inside the packaging and the name and address of the consignee. In addition, the packaging must be marked "SALVAGE" or "SALVAGE DRUM".

(4) Each drum shall be labeled as prescribed for the respective material.

(5) The shipper shall prepare shipping papers in accordance with subpart C of part 172 of this subchapter.

(6) The overpack requirements of §173.25 do not apply to drums used in accordance with this paragraph.

(7) A salvage packaging marked "T" in accordance with applicable provisions in the UN Recommendations may be used.

(d) *Salvage cylinders.* Cylinders of hazardous materials that are damaged or leaking may be overpacked in a non-DOT specification full opening hinged head or fully removable head steel salvage cylinder under the following conditions:

(1) Only a cylinder containing a Division 2.1, 2.2, 2.3, 3, 6.1, or a Class 8 material may be overpacked in a salvage cylinder. A cylinder containing acetylene may not be overpacked in a salvage cylinder.

(2) Each salvage cylinder—

(i) Must be designed, constructed and marked in accordance with Section VIII, Division I of the ASME Code (IBR, see §171.7 of this subchapter) with a minimum design margin of 4 to 1. Salvage cylinders may not be equipped with a pressure relief device. Damaged

cylinders must be securely positioned in the salvage cylinder to prevent excessive movement. The overpack requirements of §173.25 of this part do not apply to salvage cylinders used in accordance with this section.

(ii) Must have a maximum water capacity of 450 L (119 gallons).

(iii) Except for liquefied nitrous oxide and carbon dioxide, contents of the damaged or leaking cylinder must be limited in pressure and volume so that if totally discharged into the salvage cylinder, the pressure in the salvage cylinder will not exceed $\frac{1}{4}$ of the MAWP at 55 °C (131 °F).

(iv) Must have gaskets, valves and fittings that are compatible with the hazardous materials contained within.

(3) Each salvage cylinder must be plainly and durably marked. Unless otherwise specified, the markings below must be in the same area on any portion of the upper end:

(i) The proper shipping name of the hazardous material contained inside the packaging;

(ii) The name and address of the consignee or consignor;

(iii) The name and address or registered symbol of the manufacturer; and

(iv) The words "SALVAGE CYLINDER" in letters at least 50 mm (2.0 inches) high on opposite sides near the middle of the cylinder; stamping on the sidewall is not authorized.

(4) Each salvage cylinder must be labeled for the hazardous material contained inside the packaging.

(5) The shipper must prepare shipping papers in accordance with subpart C of part 172 of this subchapter.

(6) Transportation is authorized by motor vehicle and cargo vessel only.

(7) Each salvage cylinder must be cleaned and purged after each use.

(8) In addition to the training requirements of §§172.700 through 172.704 of this subchapter, a person who loads, unloads or transports a salvage cylinder must be trained in handling, loading and unloading the salvage cylinder.

(9) *Cylinder Requalification:* At least once every five years, each cylinder must be visually inspected (internally and externally) in accordance with CGA Pamphlet C-6 (IBR, see §171.7 of

§ 173.4

this subchapter) and pressure tested. A minimum test pressure of at least 1½ times MAWP must be maintained for at least 30 seconds. The cylinder must be examined under test pressure and removed from service if a leak or a defect is found.

(i) The retest and inspection must be performed by a person familiar with salvage cylinders and trained and experienced in the use of the inspection and testing equipment.

(ii) Each salvage cylinder that is successfully requalified must be durably and legibly marked with the word "Tested" followed by the requalification date (month/year), e.g., "Tested 9/04." The marking must be in letters and numbers at least 12 mm (0.5 inches) high. The requalification marking may be placed on any portion of the upper end of the cylinder near the marking required in (d)(3) of this section or on a metal plate permanently secured to the cylinder. Stamping on the cylinder sidewall is not authorized.

(10) Record retention: The owner of each salvage cylinder or his authorized agent shall retain a record of the most recent visual inspection and pressure test until the salvage cylinder is requalified. The records must be made available to a DOT representative upon request.

(e) *Emergency transportation of DOT 3A480 or 3AA480 cylinders and DOT 106A500 multi-unit tank car tanks.* (1) A DOT 3A480 or DOT 3AA480 cylinder containing chlorine or sulphur dioxide that has developed a leak in a valve or fusible plug may be repaired temporarily by trained personnel using a Chlorine Institute Kit "A" (IBR, see §171.7 of this subchapter). The repaired cylinder is authorized to be transported by private or contract carrier one time, one way, from the point of discovery to a proper facility for discharge and examination.

(2) A DOT 106A500 multi-unit tank car tank containing chlorine or sulphur dioxide that has developed a leak in the valve or fusible plug may be temporarily repaired by trained personnel using a Chlorine Institute Kit "B" (IBR, see §171.7 of this subchapter). The repaired tank is authorized to be transported by private or contract carrier one time, one way, from the point

49 CFR Ch. I (10–1–14 Edition)

of discovery to a proper facility for discharge and examination.

(3) Training for personnel making the repairs in paragraphs (d)(1) and (d)(2) of this section must include:

(i) Proper use of the devices and tools in the applicable kits;

(ii) Use of respiratory equipment and all other safety equipment; and

(iii) Knowledge of the properties of chlorine and sulphur dioxide.

(4) Packagings repaired with "A" or "B" kits must be properly blocked and braced to ensure the packagings are secured in the transport vehicle.

[Amdt. 173–224, 55 FR 52607, Dec. 21, 1990, as amended at 56 FR 66265, Dec. 20, 1991; Amdt. 173–234, 58 FR 51531, Oct. 1, 1993; Amdt. 173–261, 62 FR 24719, May 6, 1997; 66 FR 45380, Aug. 28, 2001; 68 FR 48569, Aug. 14, 2003; 69 FR 76154, Dec. 20, 2004; 70 FR 3307, Jan. 24, 2005; 68 FR 61941, Oct. 30, 2003; 70 FR 34397, June 14, 2005; 70 FR 56098, Sept. 23, 2005; 75 FR 27213, May 14, 2010; 76 FR 43528, July 20, 2011]

§ 173.4 Small quantities for highway and rail.

(a) When transported domestically by highway or rail in conformance with this section, quantities of Division 2.2 (except aerosols with no subsidiary hazard), Class 3, Division 4.1, Division 4.2 (PG II and III), Division 4.3 (PG II and III), Division 5.1, Division 5.2, Division 6.1, Class 7, Class 8, and Class 9 materials are not subject to any other requirements when—

(1) The maximum quantity of material per inner receptacle or article is limited to—

(i) Thirty (30) mL (1 ounce) for authorized liquids, other than Division 6.1, Packing Group I, Hazard Zone A or B materials;

(ii) Thirty (30) g (1 ounce) for authorized solid materials;

(iii) One (1) g (0.04 ounce) for authorized materials meeting the definition of a Division 6.1, Packing Group I, Hazard Zone A or B material; and

(iv) [Reserved]

(v) Thirty (30) mL water capacity (1.8 cubic inches) for authorized Division 2.2 materials.

(2) With the exception of temperature sensing devices, each inner receptacle:

(i) Is not liquid-full at 55 °C (131 °F), and

(ii) Is constructed of plastic having a minimum thickness of no less than 0.2

mm (0.008 inch), or earthenware, glass, or metal;

(3) Each inner receptacle with a removable closure has its closure held securely in place with wire, tape, or other positive means;

(4) Unless equivalent cushioning and absorbent material surrounds the inside packaging, each inner receptacle is securely packed in an inside packaging with cushioning and absorbent material that:

(i) Will not react chemically with the material, and

(ii) Is capable of absorbing the entire contents (if a liquid) of the receptacle;

(5) The inside packaging is securely packed in a strong outer packaging;

(6) The completed package, as demonstrated by prototype testing, is capable of sustaining—

(i) Each of the following free drops made from a height of 1.8 m (5.9 feet) directly onto a solid unyielding surface without breakage or leakage from any inner receptacle and without a substantial reduction in the effectiveness of the package:

(A) One drop flat on bottom;

(B) One drop flat on top;

(C) One drop flat on the long side;

(D) One drop flat on the short side; and

(E) One drop on a corner at the junction of three intersecting edges; and

(ii) A compressive load as specified in § 178.606(c) of this subchapter.

NOTE TO PARAGRAPH (a)(6): Each of the tests in paragraph (a)(6) of this section may be performed on a different but identical package; *i.e.*, all tests need not be performed on the same package.

(7) Placement of the material in the package or packing different materials in the package does not result in a violation of § 173.21;

(8) The gross mass of the completed package does not exceed 29 kg (64 pounds);

(9) The package is not opened or otherwise altered until it is no longer in commerce; and

(10) The shipper certifies conformance with this section by marking the outside of the package with the statement “This package conforms to 49 CFR 173.4 for domestic highway or rail transport only.”

(b) A package containing a Class 7 (radioactive) material also must conform to the requirements of § 173.421(a)(1) through (a)(5), § 173.424(a) through (g), or § 173.426(a) through (c) as applicable.

(c) Packages which contain a Class 2 (other than those authorized in paragraph (a) of this section), Division 4.2 (PG I), or Division 4.3 (PG I) material conforming to paragraphs (a)(1) through (10) of this section may be offered for transportation or transported if approved by the Associate Administrator.

(d) Lithium batteries and cells are not eligible for the exceptions provided in this section.

[74 FR 2253, Jan. 14, 2009, as amended at 75 FR 5393, Feb. 2, 2010; 76 FR 3368, Jan. 19, 2011; 79 FR 40610, July 11, 2014]

§ 173.4a Excepted quantities.

(a) Excepted quantities of materials other than articles transported in accordance with this section are not subject to any additional requirements of this subchapter except for:

(1) The shipper's responsibilities to properly class their material in accordance with § 173.22 of this subchapter;

(2) Sections 171.15 and 171.16 of this subchapter pertaining to the reporting of incidents; and

(3) For a Class 7 (Radioactive) material the requirements for an excepted package.

(4) Packagings for which retention of liquid is a basic function must be capable of withstanding without leakage the pressure differential specified in § 173.27(c) of this part.

(b) *Authorized materials.* Only materials authorized for transport aboard passenger aircraft and appropriately classed within one of the following hazard classes or divisions may be transported in accordance with this section:

(1) Division 2.2 material with no subsidiary hazard. An aerosol is not included as authorized Division 2.2 material;

(2) Class 3 materials;

(3) Class 4 (PG II and III) materials except for self-reactive materials;

(4) Division 5.1 (PG II and III);

(5) Division 5.2 materials only when contained in a chemical kit, first aid kit or a polyester resin kit;

§ 173.4a

49 CFR Ch. I (10–1–14 Edition)

(6) Division 6.1, other than PG I, Hazard Zone A or B material;

(7) Class 7, Radioactive material in excepted packages

(8) Class 8 (PG II and III), except for UN2803 (Gallium) and UN2809 (Mercury); and

(9) Class 9, except for UN1845 (Carbon dioxide, solid or Dry ice), and lithium batteries and cells.

(c) *Inner packaging limits.* The maximum quantity of hazardous materials in each inner packaging is limited to:

(1) For toxic material with a Division 6.1 primary or subsidiary hazard, PG I or II—

(i) 1 g (0.04 ounce) for solids; or

(ii) 1 mL (0.03 ounce) for liquids;

(2) 30 g (1 ounce) or 30 mL (1 ounce) for solids or liquids other than those covered in paragraph (c)(1) of this section; and

(3) For gases a water capacity of 30 mL (1.8 cubic inches) or less.

(d) *Outer packaging aggregate quantity limits.* The maximum aggregate quantity of hazardous material contained in each outer packaging must not exceed the limits provided in the following paragraphs. For outer packagings containing more than one hazardous material, the aggregate quantity of hazardous material must not exceed the lowest permitted maximum aggregate quantity. The limits are as follows:

(1) For other than a Division 2.2 or Division 5.2 material:

(i) Packing Group I—300 g (0.66 pounds) for solids or 300 mL (0.08 gallons) for liquids;

(ii) Packing Group II—500 g (1.1 pounds) for solids or 500 mL (0.1 gallons) for liquids;

(iii) Packing Group III—1 kg (2.2 pounds) for solids or 1 L (0.2 gallons) for liquids;

(2) For Division 2.2 material, 1 L (61 cubic inches); or

(3) For Division 5.2 material, 500 g (1.1 pounds) for solids or 500 mL (0.1 gallons) for liquids.

(e) *Packaging materials.* Packagings used for the transport of excepted quantities must meet the following:

(1) Each inner receptacle must be constructed of plastic, or of glass, porcelain, stoneware, earthenware or metal. When used for liquid hazardous materials, plastic inner packagings

must have a thickness of not less than 0.2 mm (0.008 inch).

(2) Each inner packaging with a removable closure must have its closure held securely in place with wire, tape or other positive means. Each inner receptacle having a neck with molded screw threads must have a leak proof, threaded type cap. The closure must not react chemically with the material.

(3) Each inner packaging must be securely packed in an intermediate packaging with cushioning material in such a way that, under normal conditions of transport, it cannot break, be punctured or leak its contents. The intermediate packaging must completely contain the contents in case of breakage or leakage, regardless of package orientation. For liquid hazardous materials, the intermediate packaging must contain sufficient absorbent material that:

(i) Will absorb the entire contents of the inner packaging.

(ii) Will not react dangerously with the material or reduce the integrity or function of the packaging materials.

(iii) The absorbent material may be the cushioning material.

(4) The intermediate packaging must be securely packed in a strong, rigid outer packaging.

(5) Placement of the material in the package or packing different materials in the package must not result in a violation of §173.21.

(6) Each package must be of such a size that there is adequate space to apply all necessary markings.

(7) The package is not opened or otherwise altered until it is no longer in commerce.

(8) Overpacks may be used and may also contain packages of hazardous material or other materials not subject to the HMR subject to the requirements of §173.25.

(f) *Package tests.* The completed package as prepared for transport, with inner packagings filled to not less than 95% of their capacity for solids or 98% for liquids, must be capable of withstanding, as demonstrated by testing which is appropriately documented, without breakage or leakage of any inner packaging and without significant reduction in effectiveness:

(1) Drops onto a solid unyielding surface from a height of 1.8 m (5.9 feet):

(i) Where the sample is in the shape of a box, it must be dropped in each of the following orientations:

- (A) One drop flat on the bottom;
- (B) One drop flat on the top;
- (C) One drop flat on the longest side;
- (D) One drop flat on the shortest side; and
- (E) One drop on a corner at the junction of three intersecting edges.

(ii) Where the sample is in the shape of a drum, it must be dropped in each of the following orientations:

- (A) One drop diagonally on the top chime, with the center of gravity directly above the point of impact;
- (B) One drop diagonally on the base chime; and
- (C) One drop flat on the side.

(2) A compressive load as specified in §178.606(c) of this subchapter. Each of the tests in this paragraph (f) of this section may be performed on a different but identical package; that is, all tests need not be performed on the same package.

(g) *Marking.* Excepted quantities of hazardous materials packaged, marked, and otherwise offered and transported in accordance with this section must be durably and legibly marked with the following marking:

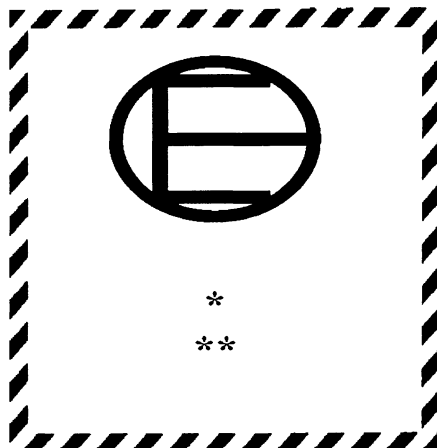

(1) The “*” must be replaced by the primary hazard class, or when assigned, the division of each of the hazardous materials contained in the package. The “**” must be replaced by

the name of the shipper or consignee if not shown elsewhere on the package.

(2) The marking must not be less than 100 mm (3.9 inches) by 100 mm (3.9 inches), and must be durable and clearly visible.

(3) When packages of excepted quantities are contained in an overpack, and the package marking required by this section is not visible inside the overpack, the excepted quantities marking must also be placed on the overpack. Additionally, an overpack containing packages of excepted quantities is not required to be marked with the word “OVERPACK.”

(h) *Documentation.* (1) For transportation by highway or rail, no shipping paper is required.

(2) For transport by air, a shipping paper is not required, except that, if a document such as an air waybill accompanies a shipment, the document must include the statement “Dangerous Goods in Excepted Quantities” and indicate the number of packages.

(3) For transport by vessel, a shipping paper is required and must include the statement “Dangerous Goods in Excepted Quantities” and indicate the number of packages.

(i) *Training.* Each person who offers or transports excepted quantities of hazardous materials must know about the requirements of this section.

(j) *Restrictions.* Hazardous material packaged in accordance with this section may not be carried in checked or carry-on baggage.

[74 FR 2254, Jan. 14, 2009, as amended at 75 FR 72, Jan. 4, 2010; 76 FR 3368, Jan. 19, 2011]

§ 173.4b De minimis exceptions.

(a) Packing Group II and III materials in Class 3, Division 4.1, Division 4.2, Division 4.3, Division 5.1, Division 6.1, Class 8, and Class 9 do not meet the definition of a hazardous material in §171.8 of this subchapter when packaged in accordance with this section and, therefore, are not subject to the requirements of this subchapter.

(1) The maximum quantity of material per inner receptacle or article is limited to—

- (i) One (1) mL (0.03 ounce) for authorized liquids; and
- (ii) One (1) g (0.04 ounce) for authorized solid materials;

§ 173.4b

49 CFR Ch. I (10–1–14 Edition)

(2) Each inner receptacle with a removable closure has its closure held securely in place with wire, tape, or other positive means;

(3) Unless equivalent cushioning and absorbent material surrounds the inside packaging, each inner receptacle is securely packed in an inside packaging with cushioning and absorbent material that:

(i) Will not react chemically with the material, and

(ii) Is capable of absorbing the entire contents (if a liquid) of the receptacle;

(4) The inside packaging is securely packed in a strong outer packaging;

(5) The completed package is capable of sustaining—

(i) Each of the following free drops made from a height of 1.8 m (5.9 feet) directly onto a solid unyielding surface without breakage or leakage from any inner receptacle and without a substantial reduction in the effectiveness of the package:

(A) One drop flat on bottom;

(B) One drop flat on top;

(C) One drop flat on the long side;

(D) One drop flat on the short side; and

(E) One drop on a corner at the junction of three intersecting edges; and

(ii) A compressive load as specified in § 178.606(c) of this subchapter. Each of the tests in this paragraph (a)(5) may be performed on a different but identical package; that is, all tests need not be performed on the same package.

(6) Placement of the material in the package or packing different materials in the package does not result in a violation of § 173.21;

(7) The aggregate quantity of hazardous material per package does not exceed 100 g (0.22 pounds) for solids or 100 mL (3.38 ounces) for liquids;

(8) The gross mass of the completed package does not exceed 29 kg (64 pounds);

(9) The package is not opened or otherwise altered until it is no longer in commerce; and

(10) For transportation by aircraft:

(i) The hazardous material is authorized to be carried aboard passenger-carrying aircraft in Column 9A of the § 172.101 Hazardous Materials Table; and

(ii) Material packed in accordance with this section may not be carried in checked or carry-on baggage.

(b) Non-infectious specimens, such as specimens of mammals, birds, amphibians, reptiles, fish, insects and other invertebrates containing small quantities of Ethanol (UN1170), Formaldehyde solution, flammable (UN1198), Alcohols, n.o.s. (UN1987) and Isopropanol (UN1219) are not subject to the requirements of this subchapter provided the following packaging, marking and documentation provisions, as applicable, are met:

(1) The specimens are:

(i) Wrapped in a paper towel or cheesecloth moistened with alcohol or an alcohol solution and placed in a plastic bag that is heat-sealed. Any free liquid in the bag must not exceed 30 mL; or

(ii) Placed in vials or other rigid containers with no more than 30 mL of alcohol or alcohol solution. The containers are placed in a plastic bag that is heat-sealed;

(2) The bagged specimens are placed in another plastic bag with sufficient absorbent material to absorb the entire liquid contents inside the primary receptacle. The outer plastic bag is then heat-sealed;

(3) The completed bag is placed in a strong outer packaging with sufficient cushioning material that conforms to subpart B of part 173;

(4) The aggregate net quantity of flammable liquid in one outer packaging may not exceed 1 L; and

(5) The outer package must be legibly marked "Scientific research specimens, 49 CFR 173.4b applies."

(6) *Documentation.* (i) For transportation by highway or rail, no shipping paper is required.

(ii) For transport by air, a shipping paper is not required, except that, if a document such as an air waybill accompanies a shipment of specimens containing hazardous materials excepted under the terms of this section, the document must include the statement "Scientific research specimens, 49 CFR 173.4b applies" and the number of packages indicated.

(iii) For transport by vessel, a shipping paper is not required; however,

the Dangerous Cargo Manifest must include the statement “Scientific research specimens, 49 CFR 173.4b applies” and the number of packages indicated. Vessel stowage is the same as for hazardous materials in excepted quantities.

(7) *Training.* Each person who offers or transports excepted quantities of hazardous materials must know about the requirements of this section.

(8) *Restrictions.* Except as provided in § 175.10, for transportation by aircraft, hazardous material packaged in accordance with this section may not be carried in checked or carry-on baggage by a passenger or crew member.

[74 FR 2255, Jan. 14, 2009, as amended at 75 FR 5393, Feb. 2, 2010; 76 FR 3368, Jan. 19, 2011; 78 FR 1073, Jan. 7, 2013]

§ 173.5 Agricultural operations.

(a) For other than a Class 2 material, the transportation of an agricultural product over local roads between fields of the same farm is excepted from the requirements of this subchapter. A Class 2 material transported over local roads between fields of the same farm is excepted from subparts G and H of part 172 of this subchapter. In either instance, transportation of the hazardous material is subject to the following conditions:

(1) It is transported by a farmer who is an intrastate private motor carrier; and

(2) The movement of the agricultural product conforms to requirements of the State in which it is transported and is specifically authorized by a State statute or regulation in effect before October 1, 1998.

(b) The transportation of an agricultural product to or from a farm, within 150 miles of the farm, is excepted from the requirements in subparts G and H of part 172 of this subchapter and from the specific packaging requirements of this subchapter when:

(1) It is transported by a farmer who is an intrastate private motor carrier;

(2) The total amount of agricultural product being transported on a single motor vehicle does not exceed:

(i) 7,300 kg (16,094 lbs.) of ammonium nitrate fertilizer properly classed as Division 5.1, PG III, in a bulk packaging, or

(ii) 1900 L (502 gallons) for liquids or gases, or 2,300 kg (5,070 lbs.) for solids, of any other agricultural product;

(3) The movement and packaging of the agricultural product conform to the requirements of the State in which it is transported and are specifically authorized by a State statute or regulation in effect before October 1, 1998; and

(4) Each person having any responsibility for transporting the agricultural product or preparing the agricultural product for shipment has been instructed in the applicable requirements of this subchapter.

(c) Formulated liquid agricultural products in specification packagings of 220 L (58 gallons) capacity, or less, with closures manifolded to a closed mixing system and equipped with positive dry disconnect devices may be transported by a private motor carrier between a final distribution point and an ultimate point of application or for loading aboard an airplane for aerial application.

(d) *Moveable fuel storage tenders.* A non-DOT specification cargo tank motor vehicle may be used to transport Liquefied petroleum gas, UN1075, including Propane, UN1978, as moveable fuel storage tender used exclusively for agricultural purposes when operated by a private carrier under the following conditions:

(1) The cargo tank must have a minimum design pressure of 250 psig.

(2) The cargo tank must meet the requirements of the HMR in effect at the time of its manufacture and must be marked accordingly. For questions regarding these requirements, contact PHMSA by either:

(i) Telephone (800) 467-4922 or (202) 366-4488 (local); or

(ii) By electronic mail (e-mail) to: infocntr@dot.gov.

(3) The cargo tank must have a water capacity of 1,200 gallons or less.

(4) The cargo tank must conform to applicable requirements in National Fire Protection Association (NFPA) 58, Liquefied Petroleum Gas Code (IBR, see § 171.7 of this subchapter).

(5) The cargo tank must be securely mounted on a motor vehicle.

§ 173.5a

(6) The cargo tank must be filled in accordance with §173.315(b) for liquefied petroleum gas.

(7) The cargo tank must be painted white, aluminum, or other light-reflecting color.

(8) Transportation of the filled moveable fuel storage tender is limited to movements over local roads between fields using the shortest practical distance.

(9) Transportation of the moveable fuel storage tender between its point of use and a liquefied petroleum gas distribution facility is authorized only if the cargo tank contains no more than five percent of its water capacity. A moveable fuel storage tender may only be filled at the consumer's premises or point of use.

(e) *Liquid soil pesticide fumigants.* MC 306 and DOT 406 cargo tank motor vehicles and DOT 57 portable tanks may be used to transport liquid soil pesticide fumigants, Pesticides, liquid, toxic, flammable, n.o.s., *flash point not less than 23 degrees C*, 6.1, UN2903, PG II, exclusively for agricultural operations by a private motor carrier between a bulk loading facility and a farm (including between farms). However, transportation is not to exceed 150 miles between the loading facility and the farm, and not more than five days are permitted for intermediate stops for temporary storage. Additionally, transport is permitted only under the following conditions:

(1) *Cargo tanks.* MC 306 and DOT 406 cargo tank motor vehicles must:

(i) Meet qualification and maintenance requirements (including periodic testing and inspection) in accordance with subpart E of part 180 of this subchapter;

(ii) Conform to the pressure relief system requirements specified in §173.243(b)(1);

(iii) For MC 306 cargo tanks, be equipped with stop-valves capable of being remotely closed by manual and mechanical means; and

(iv) For DOT 406 cargo tanks, conform to the bottom outlet requirements specified in §173.243(b)(2).

(2) *Portable tanks.* DOT 57 portable tanks must—

(i) Be constructed of stainless steel; and

49 CFR Ch. I (10–1–14 Edition)

(ii) Meet qualification and maintenance requirements of subpart G of part 180 of this subchapter.

(f) See §173.315(m) pertaining to nurse tanks of anhydrous ammonia.

(g) See §173.6 pertaining to materials of trade.

(h) See §172.800(b) pertaining to security plans.

[Amdt. 173-259, 62 FR 1215, Jan. 8, 1997, as amended by Amdt. 173-262, 62 FR 49566, Sept. 22, 1997; Amdt. 173-259, 63 FR 8142, Feb. 18, 1998; 65 FR 50460, Aug. 18, 2000; 70 FR 73165, Dec. 9, 2005; 73 FR 4717, Jan. 28, 2008; 76 FR 5491, Feb. 1, 2011]

§ 173.5a Oilfield service vehicles, mechanical displacement meter provers, and roadway striping vehicles exceptions.

(a) *Oilfield service vehicles.* Notwithstanding §173.29 of this subchapter, a cargo tank motor vehicle used in oilfield servicing operations is not subject to the specification requirements of this subchapter provided—

(1) The cargo tank and equipment contains only residual amounts (*i.e.*, it is emptied so far as practicable) of a flammable liquid alone or in combination with water,

(2) No flame producing device is operated during transportation, and

(3) The proper shipping name is preceded by “RESIDUE: LAST CONTAINED * * * ” on the shipping paper for each movement on a public highway.

(b) *Mechanical displacement meter provers.* (1) A mechanical displacement meter prover, as defined in §171.8 of this subchapter, permanently mounted on a truck chassis or trailer and transported by motor vehicle is excepted from the specification packaging requirements in part 178 of this subchapter provided it—

(i) Contains only the residue of a Division 2.1 (flammable gas) or Class 3 (flammable liquid) material. For liquids, the meter prover must be drained to not exceed 10% of its capacity or, to the extent that draining of the meter prover is impracticable, to the maximum extent practicable. For gases, the meter prover must not exceed 25% of the marked pressure rating;

(ii) Has a water capacity of 3,785 L (1,000 gallons) or less;

(iii) Is designed and constructed in accordance with chapters II, III, IV, V and VI of ASME Standard B31.4 (IBR, see §171.7 of this subchapter);

(iv) Is marked with the MAWP determined from the pipe component with the lowest pressure rating; and

(v) Is equipped with rear-end protection as prescribed in §178.337-10(c) of this subchapter and 49 CFR 393.86 of the Federal Motor Carrier Safety Regulations.

(2) The description on the shipping paper for a meter prover containing the residue of a hazardous material must include the phrase "RESIDUE: LAST CONTAINED * * * " before the basic description.

(3) *Periodic test and inspection.* (i) Each meter prover must be externally visually inspected once a year. The external visual inspection must include at a minimum: checking for leakage, defective fittings and welds, defective closures, significant dents and other defects or abnormalities which indicate a potential or actual weakness that could render the meter prover unsafe for transportation; and

(ii) Each meter prover must be pressure tested once every 5 years at not less than 75% of design pressure. The pressure must be held for a period of time sufficiently long to assure detection of leaks, but in no case less than 5 minutes.

(4) In addition to the training requirements in subpart H, the person who performs the visual inspection or pressure test and/or signs the inspection report must have the knowledge and ability to perform them as required by this section.

(5) A meter prover that fails the periodic test and inspection must be rejected and removed from hazardous materials service unless the meter prover is adequately repaired, and thereafter, a successful test is conducted in accordance with the requirements of this section.

(6) Prior to any repair work, the meter prover must be emptied of any hazardous material. A meter prover containing flammable lading must be purged.

(7) Each meter prover successfully completing the external visual inspection and the pressure test must be marked with the test date (month/year), and the type of test or inspection as follows:

(i) V for external visual inspection; and

(ii) P for pressure test.

The marking must be on the side of a tank or the largest piping component in letters 32 mm (1.25 inches) high on a contrasting background.

(8) The owner must retain a record of the most recent external visual inspection and pressure test until the next test or inspection of the same type is successfully completed. The test or inspection report must include the following:

(i) Serial number or other meter prover identifier;

(ii) Type of test or inspection performed;

(iii) Test date (month/year);

(iv) Location of defects found, if any, and method used to repair each defect;

(v) Name and address of person performing the test or inspection;

(vi) Disposition statement, such as "Meter Prover returned to service" or "Meter Prover removed from service".

(c) *Roadway striping.* In addition to conformance with all other applicable requirements of this subchapter, non-DOT specification cargo tanks used for roadway striping are authorized provided all the following conditions in this paragraph (c) are met.

(1) *Authorized materials.* Only the hazardous materials listed in the table below may be transported in roadway striping vehicles. Cargo tanks may not be filled to a capacity that would be greater than liquid full at 130 °F.

HAZARDOUS MATERIALS DESCRIPTION

Proper shipping name	Hazard class/ division	Identification number	Packing group
Adhesives, containing a flammable liquid	3	UN1133	II
Paint including paint, lacquer, enamel, stain, shellac solution, varnish, polish, liquid filler, and liquid lacquer base.	3	UN1263	II
Paint related material including paint thinning drying, removing, or reducing compound.	3	UN1263	II

HAZARDOUS MATERIALS DESCRIPTION—Continued

Proper shipping name	Hazard class/ division	Identification number	Packing group
Flammable liquids, n.o.s. ^a	3	UN1993	II
Gasoline	3	UN1203	II
Acetone ^b	3	UN1090	II
Dichloromethane ^b	6.1	UN1593	III
Ethyl methyl ketone or Methyl ethyl ketone ^b	3	UN1193	II
Ethyl acetate ^b	3	UN1173	II
Methanol ^b	3	UN1230	II
Organic peroxide type E, liquid (Dibenzoyl peroxide) ^c	5.2	UN3107	II
Petroleum distillates, n.o.s. or Petroleum products, n.o.s. ^b	3	UN1268	III
1,1,1-Trichloroethane ^b	6.1	UN2831	III
Toluene ^b	3	UN1294	II
Xylenes ^b	3	UN1307	II, III
Environmentally hazardous substance, liquid, n.o.s. ^c	9	UN3082	III
Corrosive liquid, basic, organic, n.o.s. ^c	8	UN3267	III
Corrosive liquids, n.o.s. ^c	8	UN1760	III
Elevated temperature liquid, n.o.s., at or above 100 °C and below its flash point (including molten metals, molten salts, etc.) ^d .	9	UN3257	III

a: Adhesive containing ethyl acetate.
 b: Solvent.
 c: Catalyst.
 d: Thermoplastic material non-hazardous at room temperature.

(2) *Cargo tank requirements.* Each non-DOT specification cargo tank used for roadway striping must be securely bolted to a motor vehicle and must—

- (i) Be constructed and certified in conformance with the HMR in effect at the time of its manufacture and must be marked accordingly. For questions regarding these requirements, contact PHMSA by either: (1) Telephone (800) 467-4922 or (202) 366-4488 (local); or (2) by electronic mail (e-mail) to: infocntr@dot.gov;
- (ii) Have a minimum design pressure of 100 psig;
- (iii) Have a maximum capacity of 500 gallons;
- (iv) For solvents and organic peroxides, the cargo tank may not contain more than 50 gallons;
- (v) Be given an external visual inspection prior to each use to ensure that it has not been damaged on the previous trip;
- (vi) Be retested and reinspected in accordance with §180.407(c) of this subchapter as specified for an MC 331 cargo tank motor vehicle; and
- (vii) Be securely mounted to a motor vehicle in accordance with the securement provisions prescribed in §§393.100 through 393.106 of this title.

(3) *Test records.* The owner or operator of the roadway striping vehicle must maintain hydrostatic test records in accordance with §180.417(b) and must make those records available to any

representative of the Department of Transportation upon request.

(4) *Marking.* A non-DOT specification cargo tank used for roadway striping must be plainly marked on both sides near the middle in letters at least two inches in height on a contrasting background “ROADWAY STRIPING”.

(5) *Operational controls.* A non-DOT specification cargo tank used for roadway striping may not be pressurized when the motor vehicle is traveling to and from job sites. Additionally, the distance traveled by a non-DOT specification cargo tank used for roadway striping may not exceed 750 miles. Thermoplastic resin may only be heated during roadway striping operations.

[70 FR 3308, Jan. 24, 2005, as amended at 75 FR 27213, May 14, 2010; 76 FR 5492, Feb. 1, 2011]

§ 173.5b Portable and mobile refrigeration systems.

This section authorizes the highway transportation of residual amounts of Division 2.2 refrigerant gases or anhydrous ammonia contained in non-specification pressure vessels that are components of refrigeration systems, which may or may not be permanently mounted to a transport vehicle, used for agricultural operations. These refrigeration systems are used at field sites to cool (pre-cool) produce before the produce is loaded into trucks or

railcars for market or used to supplement stationary refrigeration systems during peak harvest times. The components of these refrigeration systems are commonly known as vacuum tubes, accumulators, refrigeration units, ice makers, pressure coolers, or evaporators.

(a) *General packaging requirements.* Each non-specification pressure vessel must conform to the following:

(1) Each pressure vessel must be designed, manufactured, and maintained in accordance with applicable requirements of the ASME Code (IBR, see §171.7 of this subchapter).

(2) Except as authorized in this section, each pressure vessel and associated piping must be rated at a maximum allowable work pressure (MAWP) of 250 psig. The pressure in these components may not exceed MAWP.

(3) Any part of the piping or pressure vessel separated from another component of the refrigeration system by means of a valve, blank flange, or other device must be equipped with a pressure relief valve set at MAWP. All lines that must be disconnected for transportation purposes must be closed by means of a cap, plug or blank flange, and valves at the end of disconnected lines must be tightly closed.

(4) The aggregate total volumetric capacity of components within the refrigeration system authorized for highway transportation in accordance with this section may not exceed 2,500 gallons per vehicle.

(5) Each pressure vessel and associated piping containing anhydrous ammonia must conform to the following:

(i) Piping with a diameter of 2 inches or more must conform to ASTM A 53 Schedule 40 or ASTM A106 Schedule 40 (IBR, see §171.7 of this subchapter).

(ii) Piping with a diameter of less than 2 inches must conform to ASTM A 53 Schedule 80 or ASTM A 106 Schedule 80 (IBR, see §171.7 of this subchapter).

(iii) The words "Inhalation Hazard" must be marked as required in special provision 13 in §172.102 of this subchapter and, when practicable, within 24 inches of the placard.

(b) *Refrigeration systems placed into service prior to June 1, 1991.* (1) For refrigeration systems placed into service prior to June 1, 1991, each pressure ves-

sel and associated piping for the condensing line ("high side") must be rated at an MAWP of not less than 250 psig. Each pressure vessel and associated piping for the evaporating line ("low side") must be rated at an MAWP of not less than 150 psig, except that each pressure vessel or associated piping that will contain refrigerant gas during transportation must be rated at an MAWP of not less than 250 psig. During transportation, pressure in the components that are part of the evaporating line may not exceed 150 psig.

(2) Each pressure vessel and associated piping that is part of the evaporating line must be marked "LOW SIDE" in a permanent and clearly visible manner. The evaporating line must have a pressure gauge with corresponding temperature markings mounted so as to be easily readable when standing on the ground. The gauge must be permanently marked or tagged "SATURATION GAUGE".

(3) Each pressure vessel and associated piping with an MAWP of 250 psig or greater containing liquid anhydrous ammonia must be isolated using appropriate means from piping and components marked "LOW SIDE".

(4) Liquid lading is only authorized in system components with a rated MAWP of not less than 250 psig.

(5) Prior to transportation, each pressure vessel and associated piping with a rated MAWP of less than 250 psig must be relieved of enough gaseous lading to ensure that the MAWP is not exceeded at transport temperatures up to 54 °C (130 °F).

(6) Refrigeration systems placed into service prior to June 1, 1991, may continue in service until October 1, 2017.

(c) Prior to transportation over public highways, each pressure vessel and associated piping must be drained of refrigerant gas or liquid anhydrous ammonia to the extent practicable. Drained contents must be recovered in conformance with all applicable environmental regulations. Residual liquid anhydrous ammonia in each component may not exceed one percent of the component's total volumetric capacity or 10 gallons, whichever is less.

(d) *System inspection and testing.* (1) Each refrigeration system authorized

§ 173.6

49 CFR Ch. I (10–1–14 Edition)

under this section must be visually inspected every year. The visual inspection must include items listed in §180.407(d)(2) of this subchapter applicable to refrigeration systems. A certificate of the annual visual inspection must be dated and signed by the person performing the inspection and must contain that person's company affiliation. The certificate must remain at the equipment owner's office.

(2) Each refrigeration system authorized under this section must be proof pressure tested every two years beginning with the initial pressure test performed after manufacture. Additional pressure tests must be performed after any modification, repair or damage to a part of the system pressurized with refrigerant gas. System test pressures may not be less than one-and-one-half (1.50) times the rated MAWP of the system component or piping.

(3) Pressure relief valves must be successfully tested every two years at the MAWP for the components or piping to which they are attached. Pressure relief valves may be replaced and marked every 5 years with valves certified at the appropriate MAWP, in which case the valves need not be tested every two years. Valves that do not pass the test must be repaired or replaced.

(e) *Test markings and reports.* (1) Evidence of testing specified in paragraph (d) of this section must be marked on the right forward side of the refrigeration system with 2 inch high letters indicating type of last test (V = visual; P = pressure: hydrostatic or pneumatic) and the month/year in which it was performed. Reports and all of the requirements for records of inspections including markings must be completed as specified in part 180.

(2) Pressure relief valves must be durably marked with either the date of last test, set-pressure and testing company or the date of last replacement, set-pressure, and certifying company, as applicable.

[74 FR 16142, Apr. 9, 2009]

§ 173.6 Materials of trade exceptions.

When transported by motor vehicle in conformance with this section, a material of trade (see §171.8 of this subchapter) is not subject to any other requirements of this subchapter besides

those set forth or referenced in this section.

(a) *Materials and amounts.* A material of trade is limited to the following:

(1) A Class 3, 8, 9, Division 4.1, 5.1, 5.2, 6.1, or ORM-D material contained in a packaging having a gross mass or capacity not over—

(i) 0.5 kg (1 pound) or 0.5 L (1 pint) for a Packing Group I material;

(ii) 30 kg (66 pounds) or 30 L (8 gallons) for a Packing Group II, Packing Group III, or ORM-D material;

(iii) 1500 L (400 gallons) for a diluted mixture, not to exceed 2 percent concentration, of a Class 9 material.

(2) A Division 2.1 or 2.2 material in a cylinder with a gross weight not over 100 kg (220 pounds), in a Dewar flask meeting the requirements of §173.320, or a permanently mounted tank manufactured to the ASME Code of not more than 70 gallon water capacity for a non-liquefied Division 2.2 material with no subsidiary hazard.

(3) A Division 4.3 material in Packing Group II or III contained in a packaging having a gross capacity not exceeding 30 mL (1 ounce).

(4) A Division 6.2 material, other than a Category A infectious substance, contained in human or animal samples (including, but not limited to, secretions, excreta, blood and its components, tissue and tissue fluids, and body parts) being transported for research, diagnosis, investigational activities, or disease treatment or prevention, or is a biological product or regulated medical waste. The material must be contained in a combination packaging. For liquids, the inner packaging must be leakproof, and the outer packaging must contain sufficient absorbent material to absorb the entire contents of the inner packaging. For sharps, the inner packaging (sharps container) must be constructed of a rigid material resistant to punctures and securely closed to prevent leaks or punctures, and the outer packaging must be securely closed to prevent leaks or punctures. For solids, liquids, and sharps, the outer packaging must be a strong, tight packaging securely closed and secured against shifting, including relative motion between packages, within the vehicle on which it is being transported.

(i) For other than a regulated medical waste, the amount of Division 6.2 material in a combination packaging must conform to the following limitations:

(A) One or more inner packagings, each of which may not contain more than 0.5 kg (1.1 lbs) or 0.5 L (17 ounces), and an outer packaging containing not more than 4 kg (8.8 lbs) or 4 L (1 gallon); or

(B) A single inner packaging containing not more than 16 kg (35.2 lbs) or 16 L (4.2 gallons) in a single outer packaging.

(ii) For a regulated medical waste, a combination packaging must consist of one or more inner packagings, each of which may not contain more than 4 kg (8.8 lbs) or 4 L (1 gallon), and an outer packaging containing not more than 16 kg (35.2 lbs) or 16 L (4.2 gallons).

(5) This section does not apply to a hazardous material that is self-reactive (see §173.124), poisonous by inhalation (see §173.133), or a hazardous waste.

(6) A limited quantity package prepared in accordance with §173.63(b), §173.150, §173.151(b) and (c), §173.152, §173.153, §173.154, §173.155, §173.161, §173.165, §173.167, §173.306(i), or §173.309(d) of this subchapter. Division 4.3 substances must be prepared in accordance with paragraph (a)(3) of this section. Class 7 (radioactive) substances, instruments and articles are not authorized under the provisions of this section.

(b) *Packaging.* (1) Packagings must be leak tight for liquids and gases, sift proof for solids, and be securely closed, secured against shifting, and protected against damage.

(2) Each material must be packaged in the manufacturer's original packaging, or a packaging of equal or greater strength and integrity.

(3) Outer packagings are not required for receptacles (e.g., cans and bottles) that are secured against shifting in cages, carts, bins, boxes or compartments.

(4) For gasoline, a packaging must be made of metal or plastic and conform to the requirements of this subchapter or to the requirements of the Occupational Safety and Health Administration of the Department of Labor con-

tained in 29 CFR 1910.106(d)(2) or 1926.152(a)(1).

(5) A cylinder or other pressure vessel containing a Division 2.1 or 2.2 material must conform to packaging, qualification, maintenance, and use requirements of this subchapter, except that outer packagings are not required. Manifolding of cylinders is authorized provided all valves are tightly closed.

(c) *Hazard communication.* (1) A non-bulk packaging other than a cylinder (including a receptacle transported without an outer packaging) must be marked with a common name or proper shipping name to identify the material it contains, including the letters "RQ" if it contains a reportable quantity of a hazardous substance.

(2) A bulk packaging containing a diluted mixture of a Class 9 material must be marked on two opposing sides with the four-digit identification number of the material. The identification number must be displayed on placards, orange panels or, alternatively, a white square-on-point configuration having the same outside dimensions as a placard (at least 273 mm (10.8 inches) on a side), in the manner specified in §172.332 (b) and (c) of this subchapter.

(3) A DOT specification cylinder (except DOT specification 39) must be marked and labeled as prescribed in this subchapter. Each DOT-39 cylinder must display the markings specified in 178.65(i).

(4) The operator of a motor vehicle that contains a material of trade must be informed of the presence of the hazardous material (including whether the package contains a reportable quantity) and must be informed of the requirements of this section.

(d) *Aggregate gross weight.* Except for a material of trade authorized by paragraph (a)(1)(iii) of this section, the aggregate gross weight of all materials of trade on a motor vehicle may not exceed 200 kg (440 pounds).

(e) *Other exceptions.* A material of trade may be transported on a motor vehicle under the provisions of this section with other hazardous materials

§ 173.7

49 CFR Ch. I (10–1–14 Edition)

without affecting its eligibility for exceptions provided by this section.

[Amdt. 173-259, 62 FR 1216, Jan. 8, 1997, as amended by Amdt. 173-262, 62 FR 49566, Sept. 22, 1997; 62 FR 51560, Oct. 1, 1997; Amdt. 173-259, 63 FR 8142, Feb. 18, 1998; 63 FR 52849, Oct. 1, 1998; 66 FR 45381, Aug. 28, 2001; 67 FR 53137, Aug. 14, 2002; 68 FR 75742, Dec. 31, 2003; 68 FR 61941, Oct. 30, 2003; 71 FR 32258, June 2, 2006; 72 FR 55692, Oct. 1, 2007; 78 FR 1113, Jan. 7, 2013; 78 FR 15326, Mar. 11, 2013; 78 FR 65478, Oct. 31, 2013]

§ 173.7 Government operations and materials.

(a) Hazardous materials offered for transportation by, for, or to the Department of Defense (DOD) of the U.S. Government, including commercial shipments pursuant to a DOD contract, must be packaged in accordance with the regulations in this subchapter or in packagings of equal or greater strength and efficiency as certified by DOD in accordance with the procedures prescribed by “Packaging of Hazardous Material, DLAD 4145.41/AR 700-143/AFJI 24-210/NAVSUPINST 4030.55B/MCO 4030.40B (IBR, see §171.7 of this subchapter).” Hazardous materials offered for transportation by DOD under this provision may be reshipped by any shipper to any consignee provided the original packaging has not been damaged or altered in any manner.

(1) Hazardous materials sold by the DOD in packagings that are not marked in accordance with the requirements of this subchapter may be shipped from DOD installations if the DOD certifies in writing that the packagings are equal to or greater in strength and efficiency than the packaging prescribed in this subchapter. The shipper shall obtain such a certification in duplicate for each shipment. He shall give one copy to the originating carrier and retain the other for no less than 1 year.

(2) [Reserved]

(b) Shipments of hazardous materials, made by or under the direction or supervision of the U.S. Department of Energy (DOE) or the Department of Defense (DOD), for the purpose of national security, and which are escorted by personnel specifically designated by or under the authority of those agencies, are not subject to the requirements of this subchapter. For transpor-

tation by a motor vehicle or a rail car, the escorts must be in a separate transport vehicle from the transport vehicle carrying the hazardous materials that are excepted by this paragraph. A document certifying that the shipment is for the purpose of national security must be in the possession of the person in charge of providing security during transportation.

(c) Shipments of explosive samples, not exceeding 1 g net weight, offered by and consigned to the Bureau of Alcohol, Tobacco and Firearms (ATF) of the Department of the Treasury are not otherwise subject to the regulations in parts 110-189 of this subchapter when placed in a specifically designed multi-unit assembly packed in a strong outer packaging. The packaging must be of a type accepted by ATF as capable of precluding a propagation of any explosion outside the packaging. The second component from the outside of the packaging must be marked or tagged to indicate the presence of an explosive.

(d) Notwithstanding the requirements of §§173.416 and 173.417 of this subchapter, packagings made by or under the direction of the U.S. Department of Energy may be used for the transportation of Class 7 materials when evaluated, approved, and certified by the Department of Energy against packaging standards equivalent to those specified in 10 CFR part 71. Packages shipped in accordance with this paragraph shall be marked and otherwise prepared for shipment in a manner equivalent to that required by this subchapter for packagings approved by the Nuclear Regulatory Commission.

(e) Class 1 (explosive) materials owned by the Department of Defense and packaged prior to January 1, 1990, in accordance with the requirements of this subchapter in effect at that time, are excepted from the marking and labeling requirements of part 172 of this subchapter and the packaging and package marking requirements of part 178 of this subchapter, provided the packagings have maintained their integrity and the explosive material is declared as “government-owned goods packaged prior to January 1, 1990” on the shipping papers. In addition, packages of these materials owned by the

Department of Defense that are marked and labeled in conformance with the requirements of the HMR that were in effect at the time they were originally marked and labeled are excepted from the current marking and labeling requirements.

(f) The requirements of this subchapter do not apply to shipments of hazardous materials carried aboard an aircraft that is not owned by a government or engaged in carrying persons or property for commercial purposes, but is under the exclusive direction and control of the government for a period of not less than 90 days as specified in a written contract or lease. An aircraft is under the exclusive direction and control of a government when the government exercises responsibility for:

(1) Approving crew members and determining they are qualified to operate the aircraft;

(2) Determining the airworthiness and directing maintenance of the aircraft; and

(3) Dispatching the aircraft, including the times of departure, airports to be used, and type and amount of cargo to be carried.

[29 FR 18671, Dec. 29, 1964. Redesignated at 32 FR 5606, Apr. 5, 1967]

EDITORIAL NOTE: FOR FEDERAL REGISTER citations affecting §173.7, see the List of CFR Sections Affected, which appears in the Finding Aids section of the printed volume and at www.fdsys.gov.

§ 173.8 Exceptions for non-specification packagings used in intrastate transportation.

(a) *Non-specification bulk packagings.* Notwithstanding requirements for specification packagings in subpart F of this part and parts 178 and 180 of this subchapter, a non-specification bulk packaging may be used for transportation of a hazardous material by an intrastate motor carrier until July 1, 2000, in accordance with the provisions of paragraph (d) of this section.

(b) *Non-specification cargo tanks for petroleum products.* Notwithstanding requirements for specification packagings in subpart F of this part and parts 178 and 180 of this subchapter, a non-specification cargo tank motor vehicle having a capacity of less than 13,250 L (3,500 gallons) may be used by

an intrastate motor carrier for transportation of a flammable liquid petroleum product in accordance with the provisions of paragraph (d) of this section.

(c) *Permanently secured non-bulk tanks for petroleum products.* Notwithstanding requirements for specification packagings in subpart F of this part 173 and parts 178 and 180 of this subchapter, a non-specification metal tank permanently secured to a transport vehicle and protected against leakage or damage in the event of a turnover, having a capacity of less than 450 L (119 gallons), may be used by an intrastate motor carrier for transportation of a flammable liquid petroleum product in accordance with the provisions of paragraph (d) of this section.

(d) *Additional requirements.* A packaging used under the provisions of paragraphs (a), (b) or (c) of this section must—

(1) Be operated by an intrastate motor carrier and in use as a packaging for hazardous material before October 1, 1998;

(2) Be operated in conformance with the requirements of the State in which it is authorized;

(3) Be specifically authorized by a State statute or regulation in effect before October 1, 1998, for use as a packaging for the hazardous material being transported;

(4) Be offered for transportation and transported in conformance with all other applicable requirements of this subchapter;

(5) Not be used to transport a flammable cryogenic liquid, hazardous substance, hazardous waste, or a marine pollutant (except for gasoline); and

(6) For a tank authorized under paragraph (b) or (c) of this section, conform to all requirements in part 180 (except for §180.405(g)) of this subchapter in the same manner as required for a DOT specification MC 306 cargo tank motor vehicle.

[Amdt. 173-259, 62 FR 1216, Jan. 8, 1997, as amended by Amdt. 172-262, 62 FR 49567, Sept. 22, 1997; Amdt. 173-259, 63 FR 8142, Feb. 18, 1998; 66 FR 45380, Aug. 28, 2001; 76 FR 56315, Sept. 13, 2011]

§ 173.9

49 CFR Ch. I (10–1–14 Edition)

§ 173.9 Transport vehicles or freight containers containing lading which has been fumigated.

(a) For the purpose of this section, not including 49 CFR part 387, a rail car, freight container, truck body, or trailer in which the lading has been fumigated with any material, or is undergoing fumigation, is a package containing a hazardous material.

(b) No person may offer for transportation or transport a rail car, freight container, truck body, or trailer in which the lading has been fumigated or treated with any material, or is undergoing fumigation, unless the FUMIGANT marking specified in paragraph (e) of this section is prominently displayed so that it can be seen by any person attempting to enter the interior of the transport vehicle or freight container. For domestic transportation, a hazard warning label authorized by EPA under 40 CFR part 156 may be used as an alternative to the FUMIGANT marking.

(c) No person may affix or display on a rail car, freight container, truck body, or trailer the FUMIGANT marking specified in paragraph (e) of this section, unless the lading has been fumigated or is undergoing fumigation.

(d) The FUMIGANT marking required by paragraph (b) of this section must remain on the rail car, freight container, truck body, or trailer until the rail car, freight container, truck body, or trailer has been completely ventilated either by opening the doors of the unit or by mechanical ventilation to ensure no harmful concentration of gas remains after fumigation has been completed.

(e) *FUMIGANT marking.* (1) The FUMIGANT marking must consist of red or black letters on a white background that is at least 30 cm (11.8 inches) wide and at least 25 cm (9.8 inches) high. Except for size and color, the FUMIGANT marking must be as follows:

DANGER

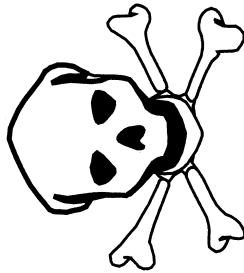

**THIS UNIT IS UNDER FUMIGATION
WITH * _____ APPLIED ON**

Date _____

Time _____

Ventilated on _____

DO NOT ENTER

(2) The "*" shall be replaced with the technical name of the fumigant.

(f) A closed cargo transport unit that has been fumigated is not subject to any other provisions of this subchapter if it—

(1) Has been completely ventilated either by opening the doors of the unit or by mechanical ventilation after fumigation, and

(2) Displays the FUMIGANT marking, including the date of ventilation.

§ 173.10

(g) For international shipments, transport documents should indicate the date of fumigation, type and amount of fumigant used, and instructions for disposal of any residual fumigant, including fumigation devices.

(h) Any person subject to the requirements of this section, solely due to the fumigated lading, must be informed of the requirements of this section and the safety precautions necessary to protect themselves and others in the event of an incident or accident involving the fumigated lading.

(i) Any person who offers for transportation or transports a rail car, freight container, truck body or trailer that is subject to this subchapter solely because of the hazardous materials designation specified in paragraph (a) of this section is not subject to any requirements of this subchapter other than those contained in this section.

[71 FR 78629, Dec. 29, 2006]

§ 173.10 Tank car shipments.

(a) Tank cars containing any 2.1 material (including a cryogenic liquid) or Class 3 material with a flash point below 38 °C (100 °F), except liquid road asphalt or tar, may not be offered for transportation unless originally consigned or subsequently reconsigned to parties having private-siding (see Note 1 of this section) or to parties using railroad siding facilities which have been equipped for piping the liquid from tank cars to permanent storage tanks of sufficient capacity to receive contents of car.

(b) A tank car containing any Class 2 material must not be offered for transportation unless the car is consigned for delivery (see paragraph (c) of this section) and unloading on a private track (see Note 1 of this section) except that where no private track is available, delivery and unloading on carrier tracks is permitted provided the following conditions are complied with:

(1) Any tank car of DOT-106A or 110A type (see §§179.300 and 179.301 of this subchapter) may be offered for transportation and the loaded unit tanks may be removed from car frame on carrier tracks, provided the shipper has obtained from the delivering carrier and filed with originating carrier, written permission (see Note 2 of this sec-

tion) for such removal. The consignee must furnish adequately safe mechanical hoist, obtained from the carrier if desirable, by which the tanks shall be lifted from the car and deposited directly upon vehicles furnished by the consignee for immediate removal from carrier property or tanks must be lifted by adequately safe mechanical hoist from car directly to vessels for further transportation.

(c) Any tank car of other than DOT-106A or 110A type (see §§179.300 and 179.301 of this subchapter), containing anhydrous ammonia, liquefied hydrocarbon or liquefied petroleum gas, and having interior pipes of liquid and gas discharge valves equipped with check valves, may be consigned for delivery and unloading on carrier tracks, if the lading is piped directly from the car to permanent storage tanks of sufficient capacity to receive the entire contents of the car. Such cars may also be consigned for storage on a private track or on a carrier track when designated by the carrier for such storage.

(d) For cars of the DOT-106A or 110A type (see §§179.300 and 179.301 of this subchapter), the tanks must be placed in position and attached to the car structure by the shipper.

(e) Class 3 materials with a flash point below 38 °C (100 °F) and Division 2.1 materials (including a cryogenic liquid) may not be loaded into tank cars on carrier property from tank trucks or drums.

NOTE 1: For this purpose, a private track is a track outside of carrier's right-of-way, yard, and terminals, and of which the carrier does not own either the rails, ties, roadbed or right-of-way; or a track or portion of a track which is devoted to the purpose of its user, either by lease or written agreement; in which case the lease or written agreement will be considered as equivalent to ownership.

NOTE 2: Carriers should give permission for the unloading of these containers on carrier tracks only where no private siding is available within reasonable trucking distance of final destination. The danger involved is the release of compressed gases due to accidental

damage to container in handling. The exposure to this danger decreases directly with the isolation of the unloading point.

[29 FR 18773, Dec. 29, 1964. Redesignated at 32 FR 5606, Apr. 5, 1967, and by Amdt. 173-162, 48 FR 10226, Mar. 10, 1983, and amended by Amdt. 173-180, 49 FR 42735, Oct. 24, 1984; Amdt. 173-207, 53 FR 38274, Sept. 29, 1988; Amdt. 173-224, 55 FR 52608, Dec. 21, 1990; 56 FR 66265, Dec. 20, 1991; Amdt. 173-234, 58 FR 51532, Oct. 1, 1993; 67 FR 61013, Sept. 27, 2002]

§ 173.12 Exceptions for shipment of waste materials.

(a) *Open head drums.* If a hazardous material that is a hazardous waste is required by this subchapter to be shipped in a closed head drum (i.e., a drum with a 7.0 cm (3 inches) or less bung opening) and the hazardous waste contains solids or semisolids that make its placement in a closed head drum impracticable, an equivalent (except for closure) open head drum may be used for the hazardous waste.

(b) *Lab packs.* (1) Waste materials prohibited by paragraph (b)(3) of this section are not authorized for transport in packages authorized by this paragraph (b). Waste materials classed as Class or Division 3, 4.1, 4.2, 4.3, 5.1, 5.2, 6.1, 8, or 9 are excepted from the specification packaging requirements of this subchapter for combination packagings if packaged in accordance with this paragraph (b) and transported for disposal or recovery by highway, rail or cargo vessel. In addition, a generic description from the §172.101 Hazardous Materials Table may be used in place of specific chemical names, when two or more chemically compatible waste materials in the same hazard class are packaged in the same outside packaging.

(2) Combination packaging requirements:

(i) *Inner packagings.* The inner packagings must be either glass, not exceeding 4 L (1 gallon) rated capacity, or metal or plastic, not exceeding 20 L (5.3 gallons) rated capacity. Inner packagings containing liquid must be surrounded by a chemically compatible absorbent material in sufficient quantity to absorb the total liquid contents.

(ii) *Outer packaging.* Each outer packaging may contain only one class of waste material. The following outer packagings are authorized except that

Division 4.2 Packing Group I materials must be packaged using UN standard steel or plastic drums tested and marked to the Packing Group I performance level for liquids or solids; and bromine pentafluoride and bromine trifluoride may not be packaged using UN 4G fiberboard boxes:

(A) A UN 1A2, UN 1B2 or UN 1N2 metal drum, a UN 1D plywood drum, a UN 1G fiber drum, or a UN 1H2 plastic drum, tested and marked to at least the Packing Group III performance level for liquids or solids;

(B) At a minimum, a double-walled UN 4G fiberboard box made out of 500 pound burst-strength fiberboard fitted with a polyethylene liner at least 3 mils (0.003 inches) thick and when filled during testing to 95 percent capacity with a solid material, successfully passes the tests prescribed in §§178.603 (drop) and 178.606 (stacking), and is capable of passing the tests prescribed in §178.608 (vibration) to at least the Packing Group II performance level for liquids or solids; or

(C) A UN 11G fiberboard intermediate bulk container (IBC) or a UN 11HH2 composite IBC, fitted with a polyethylene liner at least 6 mils (0.006 inches) thick, that successfully passes the tests prescribed in subpart O of part 178 and §178.603 to at least the Packing Group II performance level for liquids or solids; a UN 11HH2 is composed of multiple layers of encapsulated corrugated fiberboard between inner and outer layers of woven coated polypropylene.

(iii) The gross weight of each completed combination package may not exceed 205 kg (452 lbs).

(3) *Prohibited materials.* The following waste materials may not be packaged or described under the provisions of this paragraph (b): a material poisonous-by-inhalation, a temperature controlled material unless it complies with §173.21(f)(1), a Division 6.1, Packing Group I material, chloric acid, and oleum (fuming sulfuric acid).

(c) *Reuse of packagings.* A previously used packaging may be reused for the shipment of waste material transported for disposal or recovery, not subject to the reconditioning and reuse provisions contained in §173.28 and part

§ 173.12

49 CFR Ch. I (10–1–14 Edition)

178 of this subchapter, under the following conditions:

(1) Except as authorized by this paragraph, the waste must be packaged in accordance with this part and offered for transportation in accordance with the requirements of this subchapter.

(2) Transportation is performed by highway only.

(3) A package is not offered for transportation less than 24 hours after it is finally closed for transportation, and each package is inspected for leakage and is found to be free from leaks immediately prior to being offered for transportation.

(4) Each package is loaded by the shipper and unloaded by the consignee, unless the motor carrier is a private or contract carrier.

(5) The packaging may be used only once under this paragraph and may not be used again for shipment of hazardous materials except in accordance with § 173.28.

(d) *Technical names for n.o.s. descriptions.* The requirements for the inclusion of technical names for n.o.s. descriptions on shipping papers and package markings, §§ 172.203 and 172.301 of this subchapter, respectively, do not apply to packages prepared in accordance with paragraph (b) of this section, except that packages containing materials meeting the definition of a hazardous substance must be described as required in § 172.203 of this subchapter and marked as required in § 172.324 of this subchapter.

(e) *Segregation requirements.* Waste materials packaged according to paragraph (b) of this section and transported in conformance with this paragraph (e) are not subject to the segregation requirements in §§ 174.81(d), 176.83(b), and 177.848(d) if blocked and braced in such a manner that they are separated from incompatible materials by a minimum horizontal distance of 1.2 m (4 feet) and the packages are loaded at least 100 mm (4 inches) off the floor of the freight container, unit load device, transport vehicle, or rail car. The following conditions specific to incompatible materials also apply:

(1) *General restrictions.* The freight container, unit load device, transport vehicle, or rail car may not contain any Class 1 explosives, Class 7 radio-

active material, or uncontainerized hazardous materials;

(2) *Waste cyanides and waste acids.* For waste cyanides stored, loaded, and transported with waste acids:

(i) The cyanide or a cyanide mixture may not exceed 2 kg (4.4 pounds) net weight per inner packaging and may not exceed 10 kg (22 pounds) net weight per outer packaging; a cyanide solution may not exceed 2 L (0.6 gallon) per inner packaging and may not exceed 10 L (3.0 gallons) per outer packaging; and

(ii) The acids must be packaged in lab packs in accordance paragraph (b) of this section or in single packagings authorized for the acid in Column (8B) of the § 172.101 Hazardous Materials Table of this subchapter not to exceed 208 L (55 gallons) capacity.

(3) *Waste Division 4.2 materials and waste Class 8 liquids.* For waste Division 4.2 materials stored, loaded, and transported with waste Class 8 liquids:

(i) The Division 4.2 material may not exceed 2 kg (4.4 pounds) net weight per inner packaging and may not exceed 10 kg (22 pounds) net weight per outer packaging; and

(ii) The Class 8 liquid must be packaged in lab packs in accordance with paragraph (b) of this section or in single packagings authorized for the material in Column (8B) of the § 172.101 Hazardous Materials Table of this subchapter not to exceed 208 L (55 gallons) capacity.

(4) *Waste Division 6.1 Packing Group I, Hazard Zone A material and waste Class 3, Class 8 liquids, or Division 4.1, 4.2, 4.3, 5.1 and 5.2 materials.* For waste Division 6.1 Packing Group I, Hazard Zone A material stored, loaded, and transported with waste Class 8 liquids, or Division 4.2, 4.3, 5.1 and 5.2 materials:

(i) The Division 6.1 Packing Group I, Hazard Zone A material must be packaged in accordance with § 173.226(c) of this subchapter and overpacked in a UN standard steel or plastic drum meeting the Packing Group I performance level;

(ii) The Class 8 liquid must be packaged in lab packs in accordance with paragraph (b) of this section or in single packagings authorized for the material in Column (8B) of the § 172.101

Hazardous Materials Table of this subchapter not to exceed 208 L (55 gallons) capacity.

(iii) The Division 4.2 material may not exceed 2 kg (4.4 pounds) net weight per inner packaging and may not exceed 10 kg (22 pounds) net weight per outer packaging;

(iv) The Division 5.1 materials may not exceed 2 kg (4.4 pounds) net weight per inner packaging and may not exceed 10 kg (22 pounds) net weight per outer packaging. The aggregate net weight per freight container, unit load device, transport vehicle, or rail car may not exceed 100 kg (220 pounds);

(v) The Division 5.2 material may not exceed 1 kg (2.2 pounds) net weight per inner packaging and may not exceed 5 kg (11 pounds) net weight per outer packaging. Organic Peroxide, Type B material may not exceed 0.5 kg (1.1 pounds) net weight per inner packaging and may not exceed 2.5 kg (5.5 pounds) net weight per outer packaging. The aggregate net weight per freight container, unit load device, transport vehicle, or rail car may not exceed 50 kg (110 pounds).

(f) *Additional exceptions.* Lab packs conforming to the requirements of this section are not subject to the following:

(1) The overpack marking and labeling requirements in §173.25(a)(2) of this subchapter when secured to a pallet with shrink-wrap or stretch-wrap except that labels representative of each Hazard Class or Division in the overpack must be visibly displayed on two opposing sides.

(2) The restrictions for overpacks containing Class 8, Packing Group I material and Division 5.1, Packing Group I material in §173.25(a)(5) of this subchapter. These waste materials may be overpacked with other materials.

(g) *Household waste.* Household waste, as defined in §171.8 of this subchapter, is not subject to the requirements of this subchapter when transported in

accordance with applicable state, local, or tribal requirements.

[Amdt. 173-224, 55 FR 52609, Dec. 21, 1990, as amended at 56 FR 66265, Dec. 20, 1991; Amdt. 173-231, 57 FR 52939, Nov. 5, 1992; Amdt. 173-138, 59 FR 49133, Sept. 26, 1994; 65 FR 50460, Aug. 18, 2000; 65 FR 58629, Sept. 29, 2000; 68 FR 48569, Aug. 14, 2003; 70 FR 3309, Jan. 24, 2005; 73 FR 4717, Jan. 28, 2008; 74 FR 2255, Jan. 14, 2009; 75 FR 27214, May 14, 2010; 76 FR 56315, Sept. 13, 2011; 77 FR 60942, Oct. 5, 2012; 78 FR 1073, Jan. 7, 2013; 78 FR 15326, Mar. 11, 2013]

§ 173.13 Exceptions for Class 3, Divisions 4.1, 4.2, 4.3, 5.1, 6.1, and Classes 8 and 9 materials.

(a) A Class 3, 8 or 9, or Division 4.1, 4.2, 4.3, 5.1, or 6.1 material is excepted from the labeling (except for the CARGO AIRCRAFT ONLY label), placarding and segregation requirements of this subchapter if prepared for transportation in accordance with the requirements of this section. A material that meets the definition of a material poisonous by inhalation may not be offered for transportation or transported under provisions of this section.

(b) A hazardous material conforming to the requirements of this section may be transported by motor vehicle and rail car. In addition, packages prepared in accordance with this section may be transported by aircraft under the following conditions:

(1) *Cargo-only aircraft.* Only hazardous materials permitted to be transported aboard either a passenger or cargo-only aircraft by column (9A) or (9B) of the Hazardous Materials Table in §172.101 of this subchapter are authorized aboard cargo-only aircraft.

(2) *Passenger carrying aircraft.* Only hazardous materials permitted to be transported aboard a passenger aircraft by column (9A) of the Hazardous Materials Table in §172.101 of this subchapter are authorized aboard passenger aircraft. The completed package, assembled as for transportation, must be successfully tested in accordance with part 178 of this subchapter at the Packing Group I level. A hazardous material which meets the definition of a Division 5.1 (oxidizer) at the Packing Group I level in accordance with §173.127(b)(1)(i) of this subchapter may not be transported aboard a passenger aircraft.

§ 173.21

49 CFR Ch. I (10–1–14 Edition)

(3) Packages offered for transportation aboard either passenger or cargo-only aircraft must meet the requirements for transportation by aircraft specified in §173.27 of this subchapter.

(c) A hazardous material permitted by paragraph (a) of this section must be packaged as follows:

(1) For liquids:

(i) The hazardous material must be placed in a tightly closed glass, plastic or metal inner packaging with a maximum capacity not exceeding 1.2 L. Sufficient outage must be provided such that the inner packaging will not become liquid full at 55 °C (130 °F). The net quantity (measured at 20 °C (68 °F)) of liquid in any inner packaging may not exceed 1 L. For transportation by aircraft, the net quantity in one package may not exceed the quantity specified in columns (9A) or (9B), as appropriate.

(ii) The inner packaging must be placed in a hermetically sealed barrier bag which is impervious to the lading, and then wrapped in a non-reactive absorbent material in sufficient quantity to completely absorb the contents of the inner packaging. Alternatively, the inner packaging may first be wrapped in a non-reactive absorbent material and then placed in the hermetically sealed barrier bag. The combination of inner packaging, absorbent material, and bag must be placed in a snugly fitting metal can.

(iii) The metal can must be securely closed. For liquids that are in Division 4.2 or 4.3, the metal can must be hermetically sealed. For Division 4.2 materials in Packing Group I, the metal can must be tested in accordance with part 178 of this subchapter at the Packing Group I performance level.

(iv) The metal can must be placed in a fiberboard box that is placed in a hermetically sealed barrier bag which is impervious to the lading.

(v) The intermediate packaging must be placed inside a securely closed, outer packaging conforming to §173.201.

(vi) Not more than four intermediate packagings are permitted in an outer packaging.

(2) For solids:

(i) The hazardous material must be placed in a tightly closed glass, plastic or metal inner packaging. The net quantity of material in any inner packaging may not exceed 2.85kg (6.25 pounds). For transportation by aircraft, the net quantity in one package may not exceed the quantity specified in columns (9A) or (9B), as appropriate.

(ii) The inner packaging must be placed in a hermetically sealed barrier bag which is impervious to the lading.

(iii) The barrier bag and its contents must be placed in a fiberboard box that is placed in a hermetically-sealed barrier bag which is impervious to the lading.

(iv) The intermediate packaging must be placed inside an outer packaging conforming to §173.211.

(v) Not more than four intermediate packagings are permitted in an outer packaging.

(d) The outside of the package must be marked, in association with the proper shipping name, with the statement: "This package conforms to 49 CFR 173.13."

[Amdt. 173–253, 61 FR 27173, May 30, 1996, as amended at 65 FR 50460, Aug. 18, 2000; 66 FR 45381, Aug. 28, 2001; 70 FR 3309, Jan. 24, 2005; 71 FR 54395, Sept. 14, 2006; 75 FR 27215, May 14, 2010]

Subpart B—Preparation of Hazardous Materials for Transportation

§ 173.21 Forbidden materials and packages.

Unless otherwise provided in this subchapter, the offering for transportation or transportation of the following is forbidden:

(a) Materials that are designated "Forbidden" in Column 3 of the §172.101 table.

(b) Forbidden explosives as defined in §173.54 of this part.

(c) Electrical devices, such as batteries and battery-powered devices, which are likely to create sparks or generate a dangerous evolution of heat, unless packaged in a manner which precludes such an occurrence.

(d) For carriage by aircraft, any package which has a magnetic field of more than 0.00525 gauss measured at 4.5

m (15 feet) from any surface of the package.

(e) A material in the same packaging, freight container, or overpack with another material, the mixing of which is likely to cause a dangerous evolution of heat, or flammable or poisonous gases or vapors, or to produce corrosive materials.

(f) A package containing a material which is likely to decompose with a self-accelerated decomposition temperature (SADT) of 50 °C (122 °F) or less, or polymerize at a temperature of 54 °C (130 °F) or less with an evolution of a dangerous quantity of heat or gas when decomposing or polymerizing, unless the material is stabilized or inhibited in a manner to preclude such evolution. The SADT may be determined by any of the test methods described in Part II of the UN Manual of Tests and Criteria (IBR, see §171.7 of this subchapter).

(1) A package meeting the criteria of paragraph (f) of this section may be required to be shipped under controlled temperature conditions. The control temperature and emergency temperature for a package shall be as specified in the table in this paragraph based upon the SADT of the material. The control temperature is the temperature above which a package of the material may not be offered for transportation or transported. The emergency temperature is the temperature at which, due to imminent danger, emergency measures must be initiated.

§ 173.21 TABLE: METHOD OF DETERMINING CONTROL AND EMERGENCY TEMPERATURE.

SADT ¹	Control temperatures	Emergency temperature
SADT ≤20 °C (68 °F).	20 °C (36 °F) below SADT.	10 °C (18 °F) below SADT.
20 °C (68 °F) <SADT ≤35 °C (95 °F).	15 °C (27 °F) below SADT.	10 °C (18 °F) below SADT.
35 °C (95 °F) <SADT ≤50 °C (122 °F).	10 °C (18 °F) below SADT.	5 °C (9 °F) below SADT.
50 °C (122 °F) <SADT.	(²)	(²)

¹ Self-accelerating decomposition temperature.
² Temperature control not required.

(2) For self-reactive materials listed in §173.224(b) table control and emer-

gency temperatures, where required are shown in Columns 5 and 6, respectively. For organic peroxides listed in The Organic Peroxides Table in §173.225 control and emergency temperatures, where required, are shown in Columns 7a and 7b, respectively.

(3) Refrigeration may be used as a means of stabilization only when approved by the Associate Administrator. Approvals issued by the Bureau of Explosives are no longer valid (see §171.19 of this subchapter). Methods of stabilization approved by the Associate Administrator are as follows:

(i) For highway transportation:

(A) A material meeting the criteria of this paragraph (f) may be transported only in a transport vehicle, freight container, or motor vehicle equipped with a mechanical refrigeration unit, or loaded with a consumable refrigerant, capable of maintaining the inside temperature of the hazardous material at or below the control temperature required for the material during transportation.

(B) Each package containing a material meeting the criteria of this paragraph (f) must be loaded and maintained at or below the control temperature required for the material. The temperature of the material must be determined by appropriate means and entered on a written record at the time the packaging is loaded.

(C) The vehicle operator shall monitor the inside temperature of the transport vehicle, freight container, or motor vehicle and enter that temperature on a written record at the time the package is loaded and thereafter at intervals not exceeding two hours. Alternatively, a transport vehicle, freight container, or motor vehicle may be equipped with a visible or audible warning device that activates when the inside temperature of the transport vehicle, freight container, or motor vehicle exceeds the control temperature required for the material. The warning device must be readily visible or audible, as appropriate, from the vehicle operator's seat in the vehicle.

(D) The carrier shall advise the vehicle operator of the emergency temperature for the material, and provide the vehicle operator with written procedures that must be followed to assure

§ 173.22

49 CFR Ch. I (10–1–14 Edition)

maintenance of the control temperature inside the transport vehicle, freight container, or motor vehicle. The written procedures must include instructions for the vehicle operator on actions to take if the inside temperature exceeds the control temperature and approaches or reaches the emergency temperature for the material. In addition, the written temperature-control procedures must identify enroute points where the consumable refrigerant may be procured, or where repairs to, or replacement of, the mechanical refrigeration unit may be accomplished.

(E) The vehicle operator shall maintain the written temperature-control procedures, and the written record of temperature measurements specified in paragraph (f)(3)(i)(C) of this section, if applicable, in the same manner as specified in §177.817 of this subchapter for shipping papers.

(F) If the control temperature is maintained by use of a consumable refrigerant (e.g., dry ice or liquid nitrogen), the quantity of consumable refrigerant must be sufficient to maintain the control temperature for twice the average transit time under normal conditions of transportation.

(G) A material that has a control temperature of 40 °C (104 °F) or higher may be transported by common carrier. A material that has a control temperature below 40 °C (104 °F) must be transported by a private or contract carrier.

(ii) For transportation by vessel, shipments are authorized in accordance with the control temperature requirements in 7.3.7 of the IMDG Code (IBR, see §171.7 of this subchapter).

(g) Packages which give off a flammable gas or vapor, released from a material not otherwise subject to this subchapter, likely to create a flammable mixture with air in a transport vehicle.

(h) Packages containing materials (other than those classed as explosive) which will detonate in a fire.

(1) For purposes of this paragraph, “detonate” means an explosion in which the shock wave travels through the material at a speed greater than the speed of sound.

(2) When tests are required to evaluate the performance of a package under the provisions of this paragraph, the testing must be done or approved by one of the agencies specified in §173.56.

(i) Except for a package containing a lighter design sample that meets the requirements of §173.308(b)(2), a package containing a lighter (see §171.8 of this subchapter) containing a Division 2.1 material, of a design that has not been examined and successfully tested by an authorized person under the criteria specified in §173.308(a)(4) or, a lighter design containing a Class 3 material, that has not been approved by the Associate Administrator.

(j) An organic peroxide of the “ketone peroxide” category which contains more than 9 percent available oxygen as calculated using the equation in §173.128(a)(4)(ii). The category, ketone peroxide, includes, but is not limited to:

Acetyl acetone peroxide
Cyclohexanone peroxide(s)
Diacetone alcohol peroxides
Methylcyclohexanone peroxide(s)
Methyl ethyl ketone peroxide(s)
Methyl isobutyl ketone peroxide(s)

(k) Notwithstanding any other provision of this subchapter, including subpart C of part 171 and 175.10(a)(2) of this subchapter, an oxygen generator (chemical) as cargo on a passenger-carrying aircraft. This prohibition does not apply to an oxygen generator for medical or personal use of a passenger that meets the requirements of §175.10(a)(7) of this subchapter.

[Amdt. 173–224, 55 FR 52609, Dec. 21, 1990]

EDITORIAL NOTE: For FEDERAL REGISTER citations affecting §173.21, see the List of CFR Sections Affected, which appears in the Finding Aids section of the printed volume and at www.fdsys.gov.

§ 173.22 Shipper’s responsibility.

(a) Except as otherwise provided in this part, a person may offer a hazardous material for transportation in a packaging or container required by this part only in accordance with the following:

(1) The person shall class and describe the hazardous material in accordance with parts 172 and 173 of this subchapter, and

(2) The person shall determine that the packaging or container is an authorized packaging, including part 173 requirements, and that it has been manufactured, assembled, and marked in accordance with:

(i) Section 173.7(a) and parts 173, 178, or 179 of this subchapter;

(ii) A specification of the Department in effect at the date of manufacture of the packaging or container;

(iii) National or international regulations based on the UN Recommendations (IBR, see §171.7 of this subchapter), as authorized in §173.24(d)(2);

(iv) An approval issued under this subchapter; or

(v) An exemption or special permit issued under subchapter A of this chapter.

(3) In making the determination under paragraph (a)(2) of this section, the person may accept:

(i) Except for the marking on the bottom of a metal or plastic drum with a capacity over 100 L which has been reconditioned, remanufactured or otherwise converted, the manufacturer's certification, specification, approval, or exemption or special permit marking (see §§178.2 and 179.1 of this subchapter); or

(ii) With respect to cargo tanks provided by a carrier, the manufacturer's identification plate or a written certification of specification or exemption or special permit provided by the carrier.

(4)(i) For a DOT Specification or UN standard packaging subject to the requirements of part 178 of this subchapter, a person must perform all functions necessary to bring the package into compliance with parts 173 and 178 of this subchapter, as identified by the packaging manufacturer or subsequent distributor (for example, applying closures consistent with the manufacturer's closure instructions) in accordance with §178.2 of this subchapter.

(ii) For other than a bulk package or a cylinder, a person must retain a copy of the manufacturer's notification, including closure instructions (see §178.2(c) of this subchapter). For a bulk package or a cylinder, a person must retain a copy of the manufacturer's notification, including closure instructions (see §178.2(c) of this subchapter),

unless permanently embossed or printed on the package. A copy of the manufacturer's notification, including closure instructions (see §178.2(c) of this subchapter), unless permanently embossed or printed on the package when applicable, must be made available for inspection by a representative of the Department upon request for at least 90 days once the package is offered to the initial carrier for transportation in commerce. Subsequent offerors of a filled and otherwise properly prepared unaltered package are not required to maintain manufacturer notification (including closure instructions).

(iii) When applicable, a person must retain a copy of any supporting documentation used to determine an equivalent level of performance under the selective testing variation in §178.601(g)(1) of this subchapter. Such documentation is to be retained by the person certifying compliance with §178.601(g)(1), as prescribed in §178.601(1), and retained as prescribed in paragraph (a)(4)(ii) of this section.

(b) No person may offer a motor carrier any hazardous material specified in 49 CFR 385.403 unless that motor carrier holds a safety permit issued by the Federal Motor Carrier Safety Administration.

(c) Prior to each shipment of fissile radioactive materials, and Type B or highway route controlled quantity packages of radioactive materials (see §173.403), the shipper shall notify the consignee of the dates of shipment and expected arrival. The shipper shall also notify each consignee of any special loading/unloading instructions prior to his first shipment. For any shipment of irradiated reactor fuel, the shipper shall provide physical protection in compliance with a plan established under:

(1) Requirements prescribed by the U.S. Nuclear Regulatory Commission, or

(2) Equivalent requirements approved by the Associate Administrator.

[Amdt. 173-100, 42 FR 2689, Jan. 13, 1977]

EDITORIAL NOTE: For FEDERAL REGISTER citations affecting §173.22, see the List of CFR Sections Affected, which appears in the Finding Aids section of the printed volume and at www.fdsys.gov.

§ 173.22a Use of packagings authorized under special permits.

(a) Except as provided in paragraph (b) of this section, no person may offer a hazardous material for transportation in a packaging the use of which is dependent upon an exemption or special permit issued under subpart B of part 107 of this title, unless that person is the holder of or a party to the exemption or special permit.

(b) If an exemption or special permit authorizes the use of a packaging for the transportation of a hazardous material by any person or class of persons other than or in addition to the holder of the exemption or special permit, that person or a member of that class of persons may use the packaging for the purposes authorized in the exemption or special permit subject to the terms specified therein. Copies of exemptions and special permits may be obtained by accessing the Hazardous Materials Safety Web site at <http://www.phmsa.dot.gov/hazmat/regs/sp-a> or by writing to the Associate Administrator for Hazardous Materials Safety, U.S. Department of Transportation, East Building, 1200 New Jersey Avenue, SE., Washington, DC 20590–0001, Attention: Records Center.

(c) When an exemption or special permit issued to a person who offers a hazardous material contains requirements that apply to a carrier of the hazardous material, the offeror shall furnish a copy of the current exemption or special permit to the carrier before or at the time a shipment is tendered.

[70 FR 73165, Dec. 9, 2005, as amended at 72 FR 55692, Oct. 1, 2007; 76 FR 56315, Sept. 13, 2011]

§ 173.23 Previously authorized packaging.

(a) When the regulations specify a packaging with a specification marking prefix of “DOT,” a packaging marked prior to January 1, 1970, with the prefix of “ICC” may be used in its place if the packaging otherwise conforms to applicable specification requirements.

(b) [Reserved]

(c) After July 2, 1982, a seamless aluminum cylinder manufactured in conformance with and for use under DOT special permit (SP) or exemption (E)

6498, 7042, 8107, 8364 or 8422 may be continued in use if marked before or at the time of the next retest with either the specification identification “3AL” immediately above the special permit or exemption number, or the DOT mark (e.g., DOT 3AL 1800) in proximity to the special permit or exemption marking.

(d) Cylinders (spheres) manufactured and marked under DOT special permit (SP) or exemption (E) 6616 prior to January 1, 1983, may be continued in use if marked before or at the time of the next retest with the specification identification “4BA” near the special permit or exemption marking.

(e) After October 1, 1984, cylinders manufactured for use under special permit (SP) or exemption (E) 6668 or 8404 may be continued in use, and must be marked “DOT-4LXXXYY” (XXX to be replaced by the service pressure, YY to be replaced by the letters “AL”, if applicable) in compliance with Specification 4L (§178.57 of this subchapter) on or before January 1, 1986. The “DOT-4LXXXYY” must appear in proximity to other required special permit or exemption markings.

(f) An MC 331 cargo tank motor vehicle must conform to structural integrity requirements in §178.337-3 or to corresponding requirements in effect at the time of manufacture.

(g) A non-bulk packaging manufactured, tested, marked, and certified on or before September 30, 1996, in accordance with the applicable provisions of subparts L and M of part 178 of this subchapter in effect on September 30, 1995, may be used as authorized by this subchapter if the packaging conforms to all requirements applicable at the time of manufacture. In addition, such a packaging may be reused as authorized by §173.28 without a nominal thickness marking, if it conforms to the minimum thickness criteria prescribed in §173.28(b)(4).

(h) A packaging that is permanently marked with a special permit number, “DOT-SP” or “DOT-E,” for which the provisions of the special permit have been incorporated into this subchapter may continue to be used for the life of the packaging without obliterating or otherwise removing the special permit number.

(i) An exemption packaging or shipping paper that is permanently marked "DOT-E" prior to October 1, 2007, may continue in use as long as the exemption or special permit remains valid, unless otherwise specified in the exemption or special permit.

[Amdt. 173-3, 33 FR 14921, Oct. 4, 1968]

EDITORIAL NOTE: For FEDERAL REGISTER citations affecting §173.23, see the List of CFR Sections Affected, which appears in the Finding Aids section of the printed volume and at www.fdsys.gov.

§ 173.24 General requirements for packagings and packages.

(a) *Applicability.* Except as otherwise provided in this subchapter, the provisions of this section apply to—

- (1) Bulk and non-bulk packagings;
- (2) New packagings and packagings which are reused; and
- (3) Specification and non-specification packagings.

(b) Each package used for the shipment of hazardous materials under this subchapter shall be designed, constructed, maintained, filled, its contents so limited, and closed, so that under conditions normally incident to transportation—

(1) Except as otherwise provided in this subchapter, there will be no identifiable (without the use of instruments) release of hazardous materials to the environment;

(2) The effectiveness of the package will not be substantially reduced; for example, impact resistance, strength, packaging compatibility, etc. must be maintained for the minimum and maximum temperatures, changes in humidity and pressure, and shocks, loadings and vibrations, normally encountered during transportation;

(3) There will be no mixture of gases or vapors in the package which could, through any credible spontaneous increase of heat or pressure, significantly reduce the effectiveness of the packaging;

(4) There will be no hazardous material residue adhering to the outside of the package during transport.

(c) *Authorized packagings.* A packaging is authorized for a hazardous material only if—

(1) The packaging is prescribed or permitted for the hazardous material

in a packaging section specified for that material in Column 8 of the §172.101 table and conforms to applicable requirements in the special provisions of Column 7 of the §172.101 table and, for specification packagings (but not including UN standard packagings manufactured outside the United States), the specification requirements in parts 178 and 179 of this subchapter; or

(2) The packaging is permitted under, and conforms to, provisions contained in subparts B or C of part 171 of this subchapter or §173.3, §173.4, §173.4a, §173.4b, §173.5, §173.5a, §173.6, §173.7, §173.8, §173.27, or §176.11 of this subchapter.

(d) *Specification packagings and UN standard packagings manufactured outside the U.S.—*(1) *Specification packagings.* A specification packaging, including a UN standard packaging manufactured in the United States, must conform in all details to the applicable specification or standard in part 178 or part 179 of this subchapter.

(2) UN standard packagings manufactured outside the United States. A UN standard packaging manufactured outside the United States, in accordance with national or international regulations based on the UN Recommendations (IBR, see §171.7 of this subchapter), may be imported and used and is considered to be an authorized packaging under the provisions of paragraph (c)(1) of this section, subject to the following conditions and limitations:

(i) The packaging fully conforms to applicable provisions in the UN Recommendations and the requirements of this subpart, including reuse provisions;

(ii) The packaging is capable of passing the prescribed tests in part 178 of this subchapter applicable to that standard; and

(iii) The competent authority of the country of manufacture provides reciprocal treatment for UN standard packagings manufactured in the U.S.

(e) *Compatibility.* (1) Even though certain packagings are specified in this part, it is, nevertheless, the responsibility of the person offering a hazardous material for transportation to

ensure that such packagings are compatible with their lading. This particularly applies to corrosivity, permeability, softening, premature aging and embrittlement.

(2) Packaging materials and contents must be such that there will be no significant chemical or galvanic reaction between the materials and contents of the package.

(3) *Plastic packagings and receptacles.*

(i) Plastic used in packagings and receptacles must be of a type compatible with the lading and may not be permeable to an extent that a hazardous condition is likely to occur during transportation, handling or refilling.

(ii) Each plastic packaging or receptacle which is used for liquid hazardous materials must be capable of withstanding without failure the procedure specified in appendix B of this part (“Procedure for Testing Chemical Compatibility and Rate of Permeation in Plastic Packagings and Receptacles”). The procedure specified in appendix B of this part must be performed on each plastic packaging or receptacle used for Packing Group I materials. The maximum rate of permeation of hazardous lading through or into the plastic packaging or receptacles may not exceed 0.5 percent for materials meeting the definition of a Division 6.1 material according to §173.132 and 2.0 percent for other hazardous materials, when subjected to a temperature no lower than—

(A) 18 °C (64 °F) for 180 days in accordance with Test Method 1 in appendix B of this part;

(B) 50 °C (122 °F) for 28 days in accordance with Test Method 2 in appendix B of this part; or

(C) 60 °C (140 °F) for 14 days in accordance with Test Method 3 in appendix B of this part.

(iii) Alternative procedures or rates of permeation are permitted if they yield a level of safety equivalent to or greater than that provided by paragraph (e)(3)(ii) of this section and are specifically approved by the Associate Administrator.

(4) *Mixed contents.* Hazardous materials may not be packed or mixed together in the same outer packaging with other hazardous or nonhazardous materials if such materials are capable

of reacting dangerously with each other and causing—

(i) Combustion or dangerous evolution of heat;

(ii) Evolution of flammable, poisonous, or asphyxiant gases; or

(iii) Formation of unstable or corrosive materials.

(5) Packagings used for solids, which may become liquid at temperatures likely to be encountered during transportation, must be capable of containing the hazardous material in the liquid state.

(f) *Closures.* (1) Closures on packagings shall be so designed and closed that under conditions (including the effects of temperature, pressure and vibration) normally incident to transportation—

(i) Except as provided in paragraph (g) of this section, there is no identifiable release of hazardous materials to the environment from the opening to which the closure is applied; and

(ii) The closure is leakproof and secured against loosening. For air transport, stoppers, corks or other such friction closures must be held in place by positive means.

(2) Except as otherwise provided in this subchapter, a closure (including gaskets or other closure components, if any) used on a specification packaging must conform to all applicable requirements of the specification and must be closed in accordance with information, as applicable, provided by the manufacturer’s notification required by §178.2 of this subchapter.

(g) *Venting.* Venting of packagings, to reduce internal pressure which may develop by the evolution of gas from the contents, is permitted only when—

(1) Except for shipments of cryogenic liquids as specified in §173.320(c) and of carbon dioxide, solid (dry ice), transportation by aircraft is not involved;

(2) Except as otherwise provided in this subchapter, the evolved gases are not poisonous, likely to create a flammable mixture with air or be an asphyxiant under normal conditions of transportation;

(3) The packaging is designed so as to preclude an unintentional release of hazardous materials from the receptacle;

(4) For bulk packagings, other than IBCs, venting is authorized for the specific hazardous material by a special provision in the §172.101 table or by the applicable bulk packaging specification in part 178 of this subchapter; and

(5) Intermediate bulk packagings (IBCs) may be vented when required to reduce internal pressure that may develop by the evolution of gas subject to the requirements of paragraphs (g)(1) through (g)(3) of this section. The IBC must be of a type that has successfully passed (with the vent in place) the applicable design qualification tests with no release of hazardous material.

(h) *Outage and filling limits*—(1) *General*. When filling packagings and receptacles for liquids, sufficient ullage (outage) must be left to ensure that neither leakage nor permanent distortion of the packaging or receptacle will occur as a result of an expansion of the liquid caused by temperatures likely to be encountered during transportation. Requirements for outage and filling limits for non-bulk and bulk packagings are specified in §§173.24a(d) and 173.24b(a), respectively.

(2) *Compressed gases and cryogenic liquids*. Filling limits for compressed gases and cryogenic liquids are specified in §§173.301 through 173.306 for cylinders and §§173.314 through 173.319 for bulk packagings.

(i) *Air transportation*. Except as provided in subpart C of part 171 of this subchapter, packages prepared under §173.167 of this part, or packages prepared under Packing Instruction Y963 of the ICAO Technical Instructions, packages offered or intended for transportation by aircraft must conform to the general requirements for transportation by aircraft in §173.27.

[Amdt. 173-224, 55 FR 52610, Dec. 21, 1990, as amended by Amdt. 173-227, 56 FR 49989, Oct. 2, 1991; 56 FR 66265, Dec. 20, 1991; Amdt. 173-238, 59 FR 38064, July 26, 1994; Amdt. 173-241, 59 FR 67491, Dec. 29, 1994; Amdt. 173-242, 60 FR 26805, May 18, 1995; 66 FR 8647, Feb. 1, 2001; 66 FR 45379, 81, Aug. 28, 2001; 68 FR 45032, July 31, 2003; 68 FR 75742, Dec. 31, 2003; 69 FR 76154, Dec. 20, 2004; 72 FR 25176, May 3, 2007; 73 FR 4717, Jan. 28, 2008; 74 FR 2255, Jan. 14, 2009; 78 FR 65479, Oct. 31, 2013]

§ 173.24a Additional general requirements for non-bulk packagings and packages.

(a) *Packaging design*. Except as provided in §172.312 of this subchapter:

(1) *Inner packaging closures*. A combination packaging containing liquid hazardous materials must be packed so that closures on inner packagings are upright.

(2) *Friction*. The nature and thickness of the outer packaging must be such that friction during transportation is not likely to generate an amount of heat sufficient to alter dangerously the chemical stability of the contents.

(3) *Securing and cushioning*. Inner packagings of combination packagings must be so packed, secured and cushioned to prevent their breakage or leakage and to control their shifting within the outer packaging under conditions normally incident to transportation. Cushioning material must not be capable of reacting dangerously with the contents of the inner packagings or having its protective properties significantly weakened in the event of leakage.

(4) *Metallic devices*. Nails, staples and other metallic devices shall not protrude into the interior of the outer packaging in such a manner as to be likely to damage inner packagings or receptacles.

(5) *Vibration*. Each non-bulk package must be capable of withstanding, without rupture or leakage, the vibration test procedure specified in §178.608 of this subchapter.

(b) *Non-bulk packaging filling limits*. (1) A single or composite non-bulk packaging may be filled with a liquid hazardous material only when the specific gravity of the material does not exceed that marked on the packaging, or a specific gravity of 1.2 if not marked, except as follows:

(i) A Packing Group I packaging may be used for a Packing Group II material with a specific gravity not exceeding the greater of 1.8, or 1.5 times the specific gravity marked on the packaging, provided all the performance criteria can still be met with the higher specific gravity material;

(ii) A Packing Group I packaging may be used for a Packing Group III

material with a specific gravity not exceeding the greater of 2.7, or 2.25 times the specific gravity marked on the packaging, provided all the performance criteria can still be met with the higher specific gravity material; and

(iii) A Packing Group II packaging may be used for a Packing Group III material with a specific gravity not exceeding the greater of 1.8, or 1.5 times the specific gravity marked on the packaging, provided all the performance criteria can still be met with the higher specific gravity material.

(2) Except as otherwise provided in this section, a non-bulk packaging may not be filled with a hazardous material to a gross mass greater than the maximum gross mass marked on the packaging.

(3) A single or composite non-bulk packaging which is tested and marked for liquid hazardous materials may be filled with a solid hazardous material to a gross mass, in kilograms, not exceeding the rated capacity of the packaging in liters, multiplied by the specific gravity marked on the packaging, or 1.2 if not marked. In addition:

(i) A single or composite non-bulk packaging which is tested and marked for Packing Group I liquid hazardous materials may be filled with a solid Packing Group II hazardous material to a gross mass, in kilograms, not exceeding the rated capacity of the packaging in liters, multiplied by 1.5, multiplied by the specific gravity marked on the packaging, or 1.2 if not marked.

(ii) A single or composite non-bulk packaging which is tested and marked for Packing Group I liquid hazardous materials may be filled with a solid Packing Group III hazardous material to a gross mass, in kilograms, not exceeding the rated capacity of the packaging in liters, multiplied by 2.25, multiplied by the specific gravity marked on the packaging, or 1.2 if not marked.

(iii) A single or composite non-bulk packaging which is tested and marked for Packing Group II liquid hazardous materials may be filled with a solid Packing Group III hazardous material to a gross mass, in kilograms, not exceeding the rated capacity of the packaging in liters, multiplied by 1.5, multiplied by the specific gravity marked on the packaging, or 1.2 if not marked.

(4) Packagings tested as prescribed in §178.605 of this subchapter and marked with the hydrostatic test pressure as prescribed in §178.503(a)(5) of this subchapter may be used for liquids only when the vapor pressure of the liquid conforms to one of the following:

(i) The vapor pressure must be such that the total pressure in the packaging (i.e., the vapor pressure of the liquid plus the partial pressure of air or other inert gases, less 100 kPa (15 psia)) at 55 °C (131 °F), determined on the basis of a maximum degree of filling in accordance with paragraph (d) of this section and a filling temperature of 15 °C (59 °F), will not exceed two-thirds of the marked test pressure;

(ii) The vapor pressure at 50 °C (122 °F) must be less than four-sevenths of the sum of the marked test pressure plus 100 kPa (15 psia); or

(iii) The vapor pressure at 55 °C (131 °F) must be less than two-thirds of the sum of the marked test pressure plus 100 kPa (15 psia).

(5) No hazardous material may remain on the outside of a package after filling.

(c) *Mixed contents.* (1) An outer non-bulk packaging may contain more than one hazardous material only when—

(i) The inner and outer packagings used for each hazardous material conform to the relevant packaging sections of this part applicable to that hazardous material;

(ii) The package as prepared for shipment meets the performance tests prescribed in part 178 of this subchapter for the packing group indicating the highest order of hazard for the hazardous materials contained in the package;

(iii) Corrosive materials (except ORM-D) in bottles are further packed in securely closed inner receptacles before packing in outer packagings; and

(iv) For transportation by aircraft, the total net quantity does not exceed the lowest permitted maximum net quantity per package as shown in Column 9a or 9b, as appropriate, of the §172.101 table. The permitted maximum net quantity must be calculated in kilograms if a package contains both a liquid and a solid.

(2) A packaging containing inner packagings of Division 6.2 materials

may not contain other hazardous materials except—

(i) Refrigerants, such as dry ice or liquid nitrogen, as authorized under the HMR;

(ii) Anticoagulants used to stabilize blood or plasma; or

(iii) Small quantities of Class 3, Class 8, Class 9, or other materials in Packing Groups II or III used to stabilize or prevent degradation of the sample, provided the quantity of such materials does not exceed 30 mL (1 ounce) or 30 g (1 ounce) in each inner packaging. The maximum quantity in an outer package, including a hazardous material used to preserve or stabilize a sample, may not exceed 4 L (1 gallon) or 4 kg (8.8 pounds). Such preservatives are not subject to the requirements of this subchapter.

(d) Liquids must not completely fill a receptacle at a temperature of 55 °C (131 °F) or less.

[Amdt. 173-224, 55 FR 52611, Dec. 21, 1990, as amended at 56 FR 66265, Dec. 20, 1991; 57 FR 45460, Oct. 1, 1992; 58 FR 51532, Oct. 1, 1993; Amdt. 173-255, 61 FR 50624, Sept. 26, 1996; 66 FR 45380, Aug. 28, 2001; 68 FR 61941, Oct. 30, 2003; 71 FR 32258, June 2, 2006]

§ 173.24b Additional general requirements for bulk packagings.

(a) *Outage and filling limits.* (1) Except as otherwise provided in this subchapter, liquids and liquefied gases must be so loaded that the outage is at least five percent for materials poisonous by inhalation, or at least one percent for all other materials, of the total capacity of a cargo tank, portable tank, tank car (including dome capacity), multi-unit tank car tank, or any compartment thereof, at the following reference temperatures—

(i) 46 °C (115 °F) for a noninsulated tank;

(ii) 43 °C (110 °F) for a tank car having a thermal protection system, incorporating a metal jacket that provides an overall thermal conductance at 15.5 °C (60 °F) of no more than 10.22 kilojoules per hour per square meter per degree Celsius (0.5 Btu per hour per square foot per degree F) temperature differential; or

(iii) 41 °C (105 °F) for an insulated tank.

(2) Hazardous materials may not be loaded into the dome of a tank car. If the dome of the tank car does not provide sufficient outage, vacant space must be left in the shell to provide the required outage.

(b) *Equivalent steel.* For the purposes of this section, the reference stainless steel is stainless steel with a guaranteed minimum tensile strength of 51.7 deka newtons per square millimeter (75,000 psi) and a guaranteed elongation of 40 percent or greater. Where the regulations permit steel other than stainless steel to be used in place of a specified stainless steel (for example, as in § 172.102 of this subchapter, special provision B30), the minimum thickness for the steel must be obtained from one of the following formulas, as appropriate:

Formula for metric units

$$e_1 = (12.74e_0) / (Rm_1 A_1)^{1/3}$$

Formula for non-metric units

$$e_1 = (144.2e_0) / (Rm_1 A_1)^{1/3}$$

where:

e_0 = Required thickness of the reference stainless steel in mm or inches respectively;

e_1 = Equivalent thickness of the steel used in mm or inches respectively;

Rm_1 = Specified minimum tensile strength of the steel used in deka-newtons per square millimeter or pounds per square inch respectively; and

A_1 = Specified minimum percentage elongation of the steel used multiplied by 100 (for example, 20 percent times 100 equals 20). Elongation values used must be determined from a 50 mm or 2 inch test specimen.

(c) Air pressure in excess of ambient atmospheric pressure may not be used to load or unload any lading which may create an air-enriched mixture within the flammability range of the lading in the vapor space of the tank.

(d) A bulk packaging may not be loaded with a hazardous material that:

(1) Is at a temperature outside of the packaging's design temperature range; or

(2) Except as otherwise provided in this subchapter, exceeds the maximum weight of lading marked on the specification plate.

(e) *Stacking of IBCs and Large Packagings.* (1) IBCs and Large Packagings

§ 173.25

not designed and tested to be stacked. No packages or freight (hazardous or otherwise) may be stacked upon an IBC or a Large Packaging that was not designed and tested to be stacked upon.

(2) IBCs and Large Packagings designed and tested to be stacked. The superimposed weight placed upon an IBC or a Large Packaging designed to be stacked may not exceed the maximum permissible stacking test mass marked on the packaging.

(f) *UN portable tanks.* (1) A UN portable tank manufactured in the United States must conform in all details to the applicable requirements in parts 172, 173, 178 and 180 of this subchapter.

(2) *UN portable tanks manufactured outside the United States.* A UN portable tank manufactured outside the United States, in accordance with national or international regulations based on the UN Recommendations (IBR, see §171.7 of this subchapter), which is an authorized packaging under §173.24 of this subchapter, may be filled, offered and transported in the United States, if the §172.101 Table of this subchapter authorizes the hazardous material for transportation in the UN portable tank and it conforms to the applicable T codes, and tank provision codes, or other special provisions assigned to the hazardous material in Column (7) of the Table. In addition, the portable tank must—

(i) Conform to applicable provisions in the UN Recommendations (IBR, see §171.7 of this subchapter) and the requirements of this subpart;

(ii) Be capable of passing the prescribed tests and inspections in part 180 of this subchapter applicable to the UN portable tank specification;

(iii) Be designed and manufactured according to the ASME Code (IBR, see §171.7 of this subchapter) or a pressure vessel design code approved by the Associate Administrator;

(iv) Be approved by the Associate Administrator when the portable tank is designed and constructed under the provisions of an alternative arrangement (see §178.274(a)(2) of this subchapter); and

(v) The competent authority of the country of manufacture must provide reciprocal treatment for UN portable

49 CFR Ch. I (10–1–14 Edition)

tanks manufactured in the United States.

[Amdt. 173-224, 55 FR 52612, Dec. 21, 1990, as amended at 56 FR 66266, Dec. 20, 1991; Amdt. 173-234, 58 FR 51532, Oct. 1, 1993; Amdt. 173-243, 60 FR 40038, Aug. 4, 1995; Amdt. 173-252, 61 FR 28676, June 5, 1996; Amdt. 173-255, 61 FR 50624, Sept. 26, 1996; 66 FR 33426, June 21, 2001; 67 FR 15743, Apr. 3, 2002; 68 FR 75742, Dec. 31, 2003; 74 FR 2255, Jan. 14, 2009; 76 FR 56315, Sept. 13, 2011]

§ 173.25 Authorized packagings and overpacks.

(a) Authorized packages containing hazardous materials may be offered for transportation in an overpack as defined in §171.8 of this subchapter, if all of the following conditions are met:

(1) The package meets the requirements of §§173.21 and 173.24 of this subchapter.

(2) The overpack is marked with the proper shipping name and identification number, when applicable, and is labeled as required by this subchapter for each hazardous material contained therein, unless marking and labels representative of each hazardous material in the overpack are visible.

(3) Each package subject to the orientation marking requirements of §172.312 of this subchapter is packed in the overpack with its filling holes up and the overpack is marked with package orientation marking arrows on two opposite vertical sides of the overpack with the arrows pointing in the correct direction of orientation.

(4) The overpack is marked with the word “OVERPACK” when specification packagings are required, or for Class 7 (radioactive) material when a Type A, Type B(U), Type B(M) or industrial package is required. The “OVERPACK” marking is not required when the required markings representative of each package type contained in the overpack are visible from the outside of the overpack.

(5) Packages containing Class 8 (corrosive) materials in Packing Group I or Division 5.1 (oxidizing) materials in Packing Group I may not be overpacked with any other materials.

(6) For limited quantities and ORM material, the overpack is marked with a limited quantity marking prescribed in §172.315 of this subchapter or, the ORM marking prescribed in §172.316 of

this subchapter, unless a limited quantity or ORM marking representative of the hazardous material in the overpack is visible.

(7) For excepted quantities, the overpack is marked with the required marking of §173.4a of this part unless visible.

(b) Shrink-wrapped or stretch-wrapped trays may be used as outer packagings for inner packagings prepared in accordance with the limited quantity provisions or consumer commodity provisions of this subchapter, provided that—

(1) Inner packagings are not fragile, liable to break or be easily punctured, such as those made of glass, porcelain, stoneware or certain plastics; and

(2) Each complete package does not exceed 20 kg (44 lbs) gross weight.

(c) Hazardous materials which are required to be labeled POISON may be transported in the same motor vehicle with material that is marked or known to be foodstuffs, feed or any edible material intended for consumption by humans or animals provided the hazardous material is marked, labeled, and packaged in accordance with this subchapter, conforms to the requirements of paragraph (a) of this section and is overpacked as specified in §177.841(e) of this subchapter or in an overpack which is a UN 1A2, 1B2, or 1N2 drum tested and marked for a Packing Group II or higher performance level.

[Amdt. 173-165, 48 FR 28099, June 20, 1983, as amended by Amdt. 173-224, 55 FR 52612 Dec. 21, 1990; 56 FR 66266, Dec. 20, 1991; Amdt. 173-234, 58 FR 51532, Oct. 1, 1993; Amdt. 173-214, 59 FR 67491, Dec. 29, 1994; 64 FR 10776, Mar. 5, 1999; 68 FR 45032, July 31, 2003; 69 FR 76155, Dec. 20, 2004; 70 FR 34397, June 14, 2005; 73 FR 57005, Oct. 1, 2008; 76 FR 3368, Jan. 19, 2011; 78 FR 1113, Jan. 7, 2013; 78 FR 65479, Oct. 31, 2013; 79 FR 40610, July 11, 2014]

§ 173.26 Quantity limitations.

When quantity limitations do not appear in the packaging requirements of this subchapter, the permitted gross weight or capacity authorized for a packaging is as shown in the packaging specification or standard in part 178 or 179, as applicable, of this subchapter.

[Amdt. 173-224, 55 FR 52612, Dec. 21, 1990]

§ 173.27 General requirements for transportation by aircraft.

(a) The requirements of this section are in addition to requirements prescribed elsewhere under this part and apply to packages offered or intended for transportation aboard aircraft. Except for materials not subject to performance packaging requirements in subpart E of this part, a packaging containing a Packing Group III material with a primary or subsidiary risk of Division 4.1, 4.2, 4.3, 5.1, or Class 8 must meet the Packing Group II performance level when offered for transportation by aircraft.

(b) *Packages authorized onboard aircraft.* (1) When Column 9a of the §172.101 table indicates that a material is “Forbidden”, that material may not be offered for transportation or transported aboard passenger-carrying aircraft.

(2) When Column 9b of the §172.101 table indicates that a material is “Forbidden”, that material may not be offered for transportation or transported aboard aircraft.

(3) The maximum quantity of hazardous material in a package that may be offered for transportation or transported aboard a passenger-carrying aircraft or cargo aircraft may not exceed that quantity prescribed for the material in Column 9a or 9b, respectively, of the §172.101 table.

(4) A package containing a hazardous material which is authorized aboard cargo aircraft but not aboard passenger aircraft must be labeled with the CARGO AIRCRAFT ONLY label required by §172.402(c) of this subchapter and may not be offered for transportation or transported aboard passenger-carrying aircraft.

(c) *Pressure requirements.* (1) Packagings must be designed and constructed to prevent leakage that may be caused by changes in altitude and temperature during transportation aboard aircraft.

(2) Packagings for which retention of liquid is a basic function must be capable of withstanding without leakage the greater of—

(i) An internal pressure which produces a gauge pressure of not less than 75 kPa (11 psig) for liquids in Packing

Group III of Class 3 or Division 6.1; or 95 kPa (14 psig) for other liquids; or

(ii) A pressure related to the vapor pressure of the liquid to be conveyed, determined by one of the following:

(A) The total gauge pressure measured in the receptacle (i.e., the vapor pressure of the material and the partial pressure of air or other inert gases, less 100 kPa (15 psia)) at 55 °C (131 °F), multiplied by a safety factor of 1.5; determined on the basis of a filling temperature of 15 °C (59 °F) and a degree of filling such that the receptacle is not completely liquid full at a temperature of 55 °C (131 °F) or less;

(B) 1.75 times the vapor pressure at 50 °C (122 °F) less 100 kPa (15 psia); or

(C) 1.5 times the vapor pressure at 55 °C (131 °) less 100 kPa (15 psia).

(3) Notwithstanding the provisions of paragraph (c)(2) of this section—

(i) Hazardous materials may be contained in an inner packaging which does not itself meet the pressure requirement provided that the inner packaging is packed within a supplementary packaging which does meet the pressure requirement and other applicable packaging requirements of this subchapter.

(ii) Packagings which are subject to the hydrostatic pressure test and marking requirements of §§ 178.605 and 178.503(a)(5), respectively, of this subchapter must have a marked test pressure of not less than 250 kPa (36 psig) for liquids in Packing Group I, 80 kPa (12 psig) for liquids in Packing Group III of Class 3 or Division 6.1, and 100 kPa (15 psig) for other liquids.

(d) *Closures.* The body and closure of any packaging must be constructed to be able to adequately resist the effects of temperature and vibration occurring in conditions normally incident to air transportation. Inner packaging or receptacle closures of combination packages containing liquids must be held securely, tightly and effectively in place by secondary means. Examples of such secondary methods include: Adhesive tape, friction sleeves, welding or soldering, locking wires, locking rings, induction heat seals, and child-resistant closures. The closure device must be designed so that it is unlikely that it can be incorrectly or incompletely closed. Closures must be as follows:

(1) *Packing Group I.* An inner packaging containing liquids of Packing Group I must have a secondary means of closure applied and packed in accordance with paragraph (e) of this section.

(2) *Packing Groups II and III.* When a secondary means of closure cannot be applied or is impracticable to apply to an inner packaging containing liquids of Packing Groups II and III, this requirement may be satisfied by securely closing the inner packaging and placing it in a leakproof liner or bag before placing the inner packaging in its outer packaging.

(e) *Absorbent materials.* Except as otherwise provided in this subchapter, Packing Group I liquid hazardous materials of Classes 3, 4, or 8, or Divisions 5.1 or 6.1 that are packaged in combination packagings and offered for air transport in glass, earthenware, plastic, or metal inner packagings must be packed using absorbent material as follows:

(1) Inner packagings must be packed in a rigid and leakproof receptacle or intermediate packaging containing sufficient absorbent material to absorb the entire contents of the inner packaging before packing the inner packaging in its outer package.

(2) Absorbent material must not react dangerously with the liquid (see §§ 173.24 and 173.24a.).

(f) *Combination packagings*—(1) *Excepted quantities.* For authorized materials and inner and outer package quantity limits for combination packages of *excepted quantities* intended for transportation by aircraft, see § 173.4a of this part. Unless otherwise specified in this part, or in Subpart C of part 171 of this subchapter, when combination packagings are intended for transportation aboard an aircraft, inner packagings must conform to the quantity limitations set forth in table 1 of this paragraph for transport aboard passenger-carrying aircraft and table 2 of this paragraph for transport aboard cargo-only aircraft.

(2) *Limited quantities.* (i) Unless otherwise specified in this part, or in subpart C of part 171 of this subchapter, when a limited quantity of hazardous material packaged in a combination

packaging is intended for transportation aboard an aircraft, the inner and outer packagings must conform to the quantity limitations set forth in Table 3 of this paragraph. Substances and articles must be authorized for transportation aboard a passenger-carrying aircraft (see Column (9A) of the §172.101 Hazardous Materials Table of this subchapter). As such, not all unauthorized substances or articles may be indicated in this section. Unless otherwise expected, packages must be marked and labeled in accordance with this section and any additional requirements in subparts D and E, respectively, of part 172 of this subchapter. Materials or articles *not* authorized as limited quantity by aircraft are:

- (A) Those in Packing Group I;
- (B) Class 1 (explosive) material (see §173.63(b) of this part for exceptions provided to certain articles of Division 1.4S) and Class 7 (radioactive) material (see §§173.421 through 173.425 of this part, as applicable, for exceptions provided to certain substances, instruments or articles of Class 7);
- (C) Divisions 2.1 (flammable gas) (*except* Aerosols (UN1950) and Receptacles, small (UN2037) without subsidiary risk) and Division 2.3 (toxic gas);
- (D) Divisions 4.1 (self-reactive), 4.2 (spontaneously combustible) (primary or subsidiary risk), and 4.3 (dangerous when wet) (liquids);
- (E) Division 5.2 (organic peroxide) (*except* when contained in a Chemical or First aid kit (UN3316) or Polyester resin kit (UN3269) (Types D, E and F non-temperature controlled only));
- (F) Class 8 (corrosive) materials UN2794, UN2795, UN2803, UN2809, UN3028, UN3506; and
- (G) All Class 9 (miscellaneous) materials *except for* UN1941, UN1990, UN2071,

UN3077, UN3082, UN3316, UN3334, UN3335, and ID8000.

(ii) Effective January 1, 2012, packages must be marked with the limited quantity “Y” mark as prescribed in §172.315 of this part when conforming to Table 3 of this paragraph. Until December 31, 2012, a package may instead be marked with the proper shipping name “Consumer commodity” and “ORM-D-AIR” (including “Charcoal, NA1361) if it contains a consumer commodity, as authorized by this subchapter in effect on October 1, 2010.

(iii) Strong outer packagings are required and a completed package may not exceed 30 kg (66 lbs) gross weight.

(iv) A secondary means of closure required for all liquids contained in inner packagings. If this requirement cannot be satisfied, the use of an intermediate and leakproof form of containment, such as a liner, is required.

(v) Packages must be capable of passing a 1.2 m drop test on to a rigid, non-resilient, flat and horizontal surface, in the position most likely to cause damage. The criteria for passing the test is that the outer packaging must not exhibit any damage affecting safety in transport and there must be no leakage from the inner packagings.

(vi) Each package must be capable of withstanding, without breakage or leakage of any inner packaging, a force applied to the top surface for a duration of 24 hours equivalent to the total weight of identical packages if stacked to a height of 3 m (including the test sample).

(vii) Except for UN3082, inner packagings of combination packagings containing liquids must be capable of passing the appropriate pressure differential test prescribed in paragraph (c) of this section.

(3) The tables are as follows:

TABLE 1—MAXIMUM NET CAPACITY OF INNER PACKAGING FOR TRANSPORTATION ON PASSENGER-CARRYING AIRCRAFT

Maximum net quantity per package from Column 9a of the § 172.101 table	Maximum authorized net capacity of each inner packaging	
	Glass, earthenware or fiber inner packagings	Metal or plastic inner packagings
Liquids:		
Not greater than 0.5L	0.5L	0.5L.
Greater than 0.5L, not greater than 1L	0.5L	1L.
Greater than 1L, not greater than 5L	1L	5L.
Greater than 5L, not greater than 60L	2.5L	10L.

TABLE 1—MAXIMUM NET CAPACITY OF INNER PACKAGING FOR TRANSPORTATION ON PASSENGER-CARRYING AIRCRAFT—Continued

Maximum net quantity per package from Column 9a of the § 172.101 table	Maximum authorized net capacity of each inner packaging	
	Glass, earthenware or fiber inner packagings	Metal or plastic inner packagings
Greater than 60L, not greater than 220L	5L	25L.
Greater than 220L	No limit	No limit.
Solids:		
Not greater than 5 kg	0.5 kg	1 kg.
Greater than 5 kg, not greater than 25 kg	1 kg	2.5 kg.
Greater than 25 kg, not greater than 200 kg	5 kg	10 kg.
Greater than 200 kg	No limit	No limit.

TABLE 2—MAXIMUM NET CAPACITY OF INNER PACKAGING FOR TRANSPORTATION ON CARGO AIRCRAFT

Maximum net quantity per package from Column 9b of the § 172.101 table	Maximum authorized net capacity of each inner packaging	
	Glass, earthenware or fiber inner packagings	Metal or plastic inner packagings
Liquids:		
Not greater than 2.5L	1L	1L.
Greater than 2.5L, not greater than 30L	2.5L	2.5L.
Greater than 30L, not greater than 60L	5L	10L.
Greater than 60L, not greater than 220L	5L	25L.
Greater than 220L	No limit	No limit.
Solids:		
Not greater than 15 kg	1 kg	2.5 kg.
Greater than 15 kg, not greater than 50 kg	2.5 kg	5 kg.
Greater than 50 kg, not greater than 200 kg	5 kg	10 kg.
Greater than 200 kg	No limit	No limit.

TABLE 3—MAXIMUM NET QUANTITY OF EACH INNER AND OUTER PACKAGING FOR MATERIALS AUTHORIZED FOR TRANSPORTATION AS LIMITED QUANTITY BY AIRCRAFT

Hazard class or division	Maximum authorized net quantity of each inner packaging		Maximum authorized net quantity of each outer package	Notes
	Glass, earthenware or fiber inner packagings	Metal or plastic inner packagings		
Class 1	Forbidden (See note).	See § 173.63(b) of this part for exceptions provided to certain articles of Division 1.4S.
Class 2	30 kg Gross	<i>Authorized materials:</i> Aerosols (UN1950) in Divisions 2.1 and 2.2, and Receptacles, small (UN2037) in Divisions 2.1 and 2.2 without subsidiary risk and Fuel cells cartridges (UN3478, UN3479), see § 173.230 of this part.
Class 3	PG I: Forbidden. PG II: 0.5L	PG II: 0.5L	PG II: 1L*	*Maximum net quantity per outer package with corrosive subsidiary risk (e.g., UN2924, UN3286) is 0.5L. For Class 3 base materials as part of a Polyester resin kit (UN3269), see § 173.165 of this part for additional requirements, as applicable. Inner packaging limit for UN3269 base material is 1.0 L. For Fuel cell cartridges containing flammable liquids (UN3473), see § 173.230 of this part.

TABLE 3—MAXIMUM NET QUANTITY OF EACH INNER AND OUTER PACKAGING FOR MATERIALS AUTHORIZED FOR TRANSPORTATION AS LIMITED QUANTITY BY AIRCRAFT—Continued

Hazard class or division	Maximum authorized net quantity of each inner packaging		Maximum authorized net quantity of each outer package	Notes
	Glass, earthenware or fiber inner packagings	Metal or plastic inner packagings		
Division 4.1 (does not include self-reactive material).	PG III: 2.5L* *Corrosive subsidiary risk (e.g., UN2924) or toxic (e.g., UN1992) is 1L.	PG III: 5.0L* *Corrosive subsidiary risk (e.g., UN2924) or toxic (e.g., UN1992) is 1L.	PG III: 10L*	*Maximum net quantity per outer package with corrosive subsidiary risk (e.g., UN2924) is 1L and toxic subsidiary risk (e.g., UN1992) is 2L. For Class 3 base materials as part of a Polyester resin kit (UN3269), see § 173.165 of this part for additional requirements, as applicable. Inner packaging limit for UN3269 base material is 1.0 L.
	PG I: Forbidden.			
	PG II: 0.5 kg	PG II: 0.5 kg	PG II: 5 kg*	*Maximum net quantity per outer package with toxic subsidiary risk (e.g., UN3179) is 1 kg.
Division 4.2 (Primary or subsidiary).	PG III: 1 kg	PG III: 1 kg	PG III: 10 kg*	*Maximum net quantity per outer package with corrosive subsidiary risk (e.g., UN3180) is 5 kg.
	Forbidden*	25 kg (net mass)*	*Until December 31, 2012, Charcoal (NA1361), PG III, may be transported as a limited quantity and may be renamed Consumer commodity and reclassified ORM-D-AIR, if eligible.
Division 4.3 (solid material only).	PG I solids and all liquids regardless of Packing Group: Forbidden.			
	PG II: 0.5 kg	PG II: 0.5 kg	PG II: 5 kg*	*Maximum net quantity per outer package with toxic subsidiary risk (e.g., UN3134) is 1 kg. For fuel cell cartridges containing water reactive substances (UN3476), see § 173.230 of this part.
	PG III: 1 kg	PG III: 1 kg	PG III: 10 kg*	*Maximum net quantity per outer package with corrosive or flammable subsidiary risk (e.g., UN3131 or UN3132, respectively) is 5 kg.
Division 5.1 (Liquid or solid material).	PG I: Forbidden.			
Division 5.1 (liquid material).	PG II: 0.1L	PG II: 0.1L	PG II: 0.5L.	
Division 5.1 (solid material).	PG III: 0.5L	PG III: 0.5L	PG III: 1.0L.	
	PG II: 0.5 kg	PG II: 0.5 kg	PG II: 2.5 kg*	*Maximum net quantity per outer package with toxic subsidiary risk (e.g., UN3087) is 1 kg.
	PG III: 1.0 kg	PG III: 1.0 kg	PG III: 10 kg*	*Maximum net quantity per outer package with corrosive subsidiary risk (e.g., UN3085) is 1 kg.
Division 5.2 (liquid material).	30 mL	30 mL	1 kg	<i>Authorized materials:</i> Types D, E and F are authorized only as part of a Chemical or First aid kit (UN3316) packaged in accordance with § 173.161 of this part or a Polyester resin kit (UN3269) packaged in accordance with § 173.165 of this part. See §§ 173.161 and 173.165, as applicable, for additional requirements.
Division 5.2 (solid material).	100g	100g	1 kg	Solid activators of Types D, E and F are limited to 100 g per inner packaging for UN3316 and UN3269. See §§ 173.161 and 173.165, as applicable, for additional requirements.

TABLE 3—MAXIMUM NET QUANTITY OF EACH INNER AND OUTER PACKAGING FOR MATERIALS AUTHORIZED FOR TRANSPORTATION AS LIMITED QUANTITY BY AIRCRAFT—Continued

Hazard class or division	Maximum authorized net quantity of each inner packaging		Maximum authorized net quantity of each outer package	Notes
	Glass, earthenware or fiber inner packagings	Metal or plastic inner packagings		
Division 6.1	PG I (Inhalation or otherwise): Forbidden.			
Division 6.1 (liquid material).	PG II: 0.1L	PG II: 0.1L	PG II: 1.0L*	*Maximum net quantity per outer package with corrosive subsidiary risk (e.g., UN3289) is 0.5L.
Division 6.1 (solid material).	PG III: 0.5L	PG III: 0.5L	PG III: 2.0L.	
	PG II: 0.5 kg	PG II: 0.5 kg	PG II: 1.0 kg.	
Class 7	PG III: 1.0 kg	PG III: 1.0 kg	PG III: 10 kg.	See §§ 173.421 through 173.425 of this part, as applicable, for exceptions provided to certain substances, instruments or articles of Class 7.
Class 7	Forbidden (See note).			
Class 8	PG I: Forbidden.			
Class 8 (liquid material).	PG II: 0.1L	PG II: 0.1L	PG II: 0.5L	For "Fuel cell cartridges containing corrosive substances" (UN3477), see § 173.230 of this part.
Class 8 (solid material).	PG III: 0.5L	PG III: 0.5L	PG III: 1.0L.	
	PG II: 0.5 kg	PG II: 0.5 kg	PG II: 5.0 kg*	*Maximum net quantity per outer package for UN2430 is 1.0 kg. UN2794, UN2795, UN2803, UN2809, UN3028 are not authorized as limited quantity.
Class 9 (liquid material).	PG III: 1.0 kg	PG III: 1.0 kg	PG III: 5.0 kg.	<i>Authorized materials:</i> UN1941, UN1990, UN2071, UN3077, UN3082, UN3334, and UN3335. Additionally, Consumer commodity (ID8000) in accordance with § 173.167 of this part and Chemical kit or First aid kit (UN3316) in accordance with § 173.161 of this part are authorized.
	30 mL (UN3316); 5.0L (UN1941, UN1990, UN3082, UN3334).	30 mL (UN3316); 5.0L (UN1941, UN1990, UN3082, UN3334).	1 kg (UN3316); 30 kg gross (all other authorized Class 9 material).	
Class 9 (solid material).	100 g (UN3316); 5.0 kg (UN2071, UN3077, UN3335).	100 g (UN3316); 5.0 kg (UN2071, UN3077, UN3335).	1 kg (UN3316); 30 kg gross (all other authorized Class 9 material).	

(g) *Cylinders.* For any cylinder containing hazardous materials and incorporating valves, sufficient protection must be provided to prevent operation of, and damage to, the valves during transportation, by one of the following methods:

(1) By equipping each cylinder with securely attached valve caps or protective headrings; or

(2) By boxing or crating the cylinder.

(h) Tank cars and cargo tanks. Any tank car or cargo tank containing a hazardous material may not be transported aboard aircraft.

(i) Effective October 1, 2006, each person who offers a hazardous material for transportation by aircraft must in-

clude the certification statement specified in § 172.204(c)(3).

[Amdt. 173–224, 55 FR 52612, Dec. 21, 1990, as amended at 56 FR 66266, Dec. 20, 1991; Amdt. 173–138, 59 FR 49133, Sept. 26, 1994; 65 FR 58629, Sept. 29, 2000; 66 FR 45380, Aug. 28, 2001; 68 FR 45032, July 31, 2003; 69 FR 76155, Dec. 20, 2004; 71 FR 14602, Mar. 22, 2006; 73 FR 57006, Oct. 1, 2008; 75 FR 53597, Sept. 1, 2010; 76 FR 3368, Jan. 19, 2011; 76 FR 82175, Dec. 30, 2011; 77 FR 22509, Apr. 16, 2012; 78 FR 65479, Oct. 31, 2013]

§ 173.28 Reuse, reconditioning and re-manufacture of packagings.

(a) *General.* Packagings and receptacles used more than once must be in such condition, including closure devices and cushioning materials, that

they conform in all respects to the prescribed requirements of this subchapter. Before reuse, each packaging must be inspected and may not be reused unless free from incompatible residue, rupture, or other damage which reduces its structural integrity. Packagings not meeting the minimum thickness requirements prescribed in paragraph (b)(4)(i) of this section may not be reused or reconditioned for reuse.

(b) *Reuse of non-bulk packaging.* A non-bulk packaging used more than once must conform to the following provisions and limitations:

(1) A non-bulk packaging which, upon inspection, shows evidence of a reduction in integrity may not be reused unless it is reconditioned in accordance with paragraph (c) of this section.

(2) Before reuse, packagings subject to the leakproofness test with air prescribed in §178.604 of this subchapter shall be—

(i) Retested without failure in accordance with §178.604 of this subchapter using an internal air pressure (gauge) of at least 48 kPa (7.0 psig) for Packing Group I and 20 kPa (3.0 psig) for Packing Group II and Packing Group III; and

(ii) Marked with the letter “L”, with the name and address or symbol of the person conducting the test, and the last two digits of the year the test was conducted. Symbols, if used, must be registered with the Associate Administrator.

(3) Packagings made of paper (other than fiberboard), plastic film, or textile are not authorized for reuse;

(4) Metal and plastic drums and jerricans used as single packagings or the outer packagings of composite packagings are authorized for reuse only when they are marked in a permanent manner (e.g., embossed) in mm with the nominal (for metal packagings) or minimum (for plastic packagings) thickness of the packaging material, as required by §178.503(a)(9) of this subchapter, and—

(i) Except as provided in paragraph (b)(4)(ii) of this section, conform to the following minimum thickness criteria:

Maximum capacity not over	Minimum thickness of packaging material	
	Metal drum or jerrican	Plastic drum or jerrican
20 L	0.63 mm (0.025 inch)	1.1 mm (0.043 inch).
30 L	0.73 mm (0.029 inch)	1.1 mm (0.043 inch).
40 L	0.73 mm (0.029 inch)	1.8 mm (0.071 inch).
60 L	0.92 mm (0.036 inch)	1.8 mm (0.071 inch).
120 L	0.92 mm (0.036 inch)	2.2 mm (0.087 inch).
220 L	0.92 mm (0.036 inch) ¹ .	2.2 mm (0.087 inch).
450 L	1.77 mm (0.070 inch)	5.0 mm (0.197 inch).

¹Metal drums or jerricans with a minimum thickness of 0.82 mm body and 1.09 mm heads which are manufactured and marked prior to January 1, 1997 may be reused. Metal drums or jerricans manufactured and marked on or after January 1, 1997, and intended for reuse, must be constructed with a minimum thickness of 0.82 mm body and 1.11 mm heads.

(ii) For stainless steel drums and jerricans, conform to a minimum wall thickness as determined by the following equivalence formula:

FORMULA FOR METRIC UNITS

$$e_1 = \frac{21.4 \times e_0}{\sqrt[3]{Rm_1 \times A_1}}$$

FORMULA FOR U.S. STANDARD UNITS

$$e_1 = \frac{21.4 \times e_0}{\sqrt[3]{(Rm_1 \times A_1)/145}}$$

where:

e_1 = required equivalent wall thickness of the metal to be used (in mm or, for U.S. Standard units, use inches).

e_0 = required minimum wall thickness for the reference steel (in mm or, for U.S. Standard units, use inches).

Rm_1 = guaranteed minimum tensile strength of the metal to be used (in N/mm² or for U.S. Standard units, use psi).

A_1 = guaranteed minimum elongation (as a percentage) of the metal to be used on fracture under tensile stress (see paragraph (c)(1) of this section).

(5) Plastic inner receptacles of composite packagings must have a minimum thickness of 1.0 mm (0.039 inch).

(6) A previously used non-bulk packaging may be reused for the shipment of hazardous waste, not subject to the reconditioning and reuse provisions of

§ 173.28

49 CFR Ch. I (10–1–14 Edition)

this section, in accordance with § 173.12(c).

(7) Notwithstanding the provisions of paragraph (b)(2) of this section, a packaging otherwise authorized for reuse may be reused without being leakproofness tested with air provided the packaging—

(i) Is refilled with a material which is compatible with the previous lading;

(ii) Is refilled and offered for transportation by the original filler;

(iii) Is transported in a transport vehicle or freight container under the exclusive use of the refiller of the packaging; and

(iv) Is constructed of—

(A) Stainless steel, monel or nickel with a thickness not less than one and one-half times the minimum thickness prescribed in paragraph (b)(4) of this section;

(B) Plastic, provided the packaging is not refilled for reuse on a date more than five years from the date of manufacture marked on the packaging in accordance with § 178.503(a)(6) of this subchapter; or

(C) Another material or thickness when approved under the conditions established by the Associate Administrator for reuse without retesting.

(c) *Reconditioning of non-bulk packaging.* (1) For the purpose of this subchapter, reconditioning of metal drums is:

(i) Cleaning to base material of construction, with all former contents, internal and external corrosion, and any external coatings and labels removed;

(ii) Restoring to original shape and contour, with chimes (if any) straightened and sealed, and all non-integral gaskets replaced; and

(iii) Inspecting after cleaning but before painting. Packagings that have visible pitting, significant reduction in material thickness, metal fatigue, damaged threads or closures, or other significant defects, must be rejected.

(2) For the purpose of this subchapter, reconditioning of a non-bulk packaging other than a metal drum includes:

(i) Removal of all former contents, external coatings and labels, and cleaning to the original materials of construction;

(ii) Inspection after cleaning with rejection of packagings with visible damage such as tears, creases or cracks, or damaged threads or closures, or other significant defects;

(iii) Replacement of all non-integral gaskets and closure devices with new or refurbished parts, and cushioning and cushioning materials; and components including gaskets, closure devices and cushioning and cushioning material. (For a UN 1H1 plastic drum, replacing a removable gasket or closure device with another of the same design and material that provides equivalent performance does not constitute reconditioning); and

(iv) Ensuring that the packagings are restored to a condition that conforms in all respects with the prescribed requirements of this subchapter.

(3) A person who reconditions a packaging manufactured and marked under the provisions of subpart L of part 178 of this subchapter, shall mark that packaging as required by § 178.503(c) and (d) of this subchapter. The marking is the certification of the reconditioner that the packaging conforms to the standard for which it is marked and that all functions performed by the reconditioner which are prescribed by this subchapter have been performed in compliance with this subchapter.

(4) The markings applied by the reconditioner may be different from those applied by the manufacturer at the time of original manufacture, but may not identify a greater performance capability than that for which the original design type had been tested (for example, the reconditioner may mark a drum which was originally marked as 1A1/Y1.8 as 1A1/Y1.2 or 1A1/Z2.0).

(5) Packagings which have significant defects which cannot be repaired may not be reused.

(d) *Remanufacture of non-bulk packagings.* For the purpose of this subchapter, remanufacture is the conversion of a non-specification, non-bulk packaging to a DOT specification or U.N. standard, the conversion of a packaging meeting one specification or standard to another specification or standard (for example, conversion of 1A1 non-removable head drums to 1A2

removable head drums) or the replacement of integral structural packaging components (such as non-removable heads on drums). A person who remanufactures a non-bulk packaging to conform to a specification or standard in part 178 of this subchapter is subject to the requirements of part 178 of this subchapter as a manufacturer.

(e) *Non-reusable containers.* A packaging marked as NRC according to the DOT specification or UN standard requirements of part 178 of this subchapter may be reused for the shipment of any material not required by this subchapter to be shipped in a DOT specification or UN standard packaging.

(f) A Division 6.2 packaging to be reused must be disinfected prior to reuse by any means effective for neutralizing the infectious substance the packaging previously contained. A secondary packaging or outer packaging conforming to the requirements of §173.196 or §173.199 need not be disinfected prior to reuse if no leakage from the primary receptacle has occurred. Drums or jerricans not meeting the minimum thickness requirements prescribed in paragraph (b)(4)(i) of this section may not be reused or reconditioned for reuse.

[Amdt. 173-224, 55 FR 52614, Dec. 21, 1990]

EDITORIAL NOTE: For FEDERAL REGISTER citations affecting §173.28, see the List of CFR Sections Affected, which appears in the Finding Aids section of the printed volume and at www.fdsys.gov.

§ 173.29 Empty packagings.

(a) General. Except as otherwise provided in this section, an empty packaging containing only the residue of a hazardous material shall be offered for transportation and transported in the same manner as when it previously contained a greater quantity of that hazardous material.

(b) Notwithstanding the requirements of paragraph (a) of this section, an empty packaging is not subject to any other requirements of this subchapter if it conforms to the following provisions:

(1) Any hazardous material shipping name and identification number markings, any hazard warning labels or placards, and any other markings indi-

cating that the material is hazardous (e.g., RQ, INHALATION HAZARD) are removed, obliterated, or securely covered in transportation. This provision does not apply to transportation in a transport vehicle or a freight container if the packaging is not visible in transportation and the packaging is loaded by the shipper and unloaded by the shipper or consignee;

(2) The packaging—

(i) Is unused;

(ii) Is sufficiently cleaned of residue and purged of vapors to remove any potential hazard;

(iii) Is refilled with a material which is not hazardous to such an extent that any residue remaining in the packaging no longer poses a hazard; or

(iv) Contains only the residue of—

(A) An ORM-D material; or

(B) A Division 2.2 non-flammable gas, other than ammonia, anhydrous, and with no subsidiary hazard, at a gauge pressure less than 200 kPa (29.0 psig); at 20 °C (68 °F); and

(3) Any material contained in the packaging does not meet the definitions in §171.8 of this subchapter for a hazardous substance, a hazardous waste, or a marine pollutant.

(c) A non-bulk packaging containing only the residue of a hazardous material covered by Table 2 of §172.504 of this subchapter that is not a material poisonous by inhalation or its residue shipped under the subsidiary placarding provisions of §172.505—

(1) Does not have to be included in determining the applicability of the placarding requirements of subpart F of part 172 of this subchapter; and

(2) Is not subject to the shipping paper requirements of this subchapter when collected and transported by a contract or private carrier for reconditioning, remanufacture or reuse.

(d) Notwithstanding the stowage requirements in Column 10a of the §172.101 table for transportation by vessel, an empty drum or cylinder may be stowed on deck or under deck.

(e) Specific provisions for describing an empty packaging on a shipping paper appear in §172.203(e) of this subchapter.

(f) [Reserved]

§ 173.30

49 CFR Ch. I (10–1–14 Edition)

(g) A package which contains a residue of an elevated temperature material may remain marked in the same manner as when it contained a greater quantity of the material even though it no longer meets the definition in §171.8 of this subchapter for an elevated temperature material.

(h) A package that contains a residue of a hazardous substance, Class 9, listed in the §172.101 Table, Appendix A, Table I, that does not meet the definition of another hazard class and is not a hazardous waste or marine pollutant, may remain marked, labeled and, if applicable, placarded in the same manner as when it contained a greater quantity of the material even though it no longer meets the definition in §171.8 of this subchapter for a hazardous substance.

[Amdt. 173–224, 55 FR 52614, Dec. 21, 1990, as amended by Amdt. 173–227, 56 FR 49989, Oct. 2, 1991; Amdt. 173–231, 57 FR 52939, Nov. 5, 1992; Amdt. 173–251, 61 FR 28676, June 5, 1996; Amdt. 173–260, 62 FR 1236, Jan. 8, 1997; 64 FR 10776, Mar. 5, 1999; 68 FR 48569, Aug. 14, 2003; 69 FR 64473, Nov. 4, 2004; 75 FR 72, Jan. 4, 2010]

§ 173.30 Loading and unloading of transport vehicles.

A person who is subject to the loading and unloading regulations in this subchapter must load or unload hazardous materials into or from a transport vehicle or vessel in conformance with the applicable loading and unloading requirements of parts 174, 175, 176, and 177 of this subchapter.

[68 FR 61941, Oct. 30, 2003]

§ 173.31 Use of tank cars.

(a) *General.* (1) No person may offer a hazardous material for transportation in a tank car unless the tank car meets the applicable specification and packaging requirements of this subchapter or, when this subchapter authorizes the use of a non-DOT specification tank car, the applicable specification to which the tank was constructed.

(2) Tank cars and appurtenances may be used for the transportation of any commodity for which they are authorized in this part and specified on the certificate of construction (AAR Form 4–2 or by addendum on Form R–1). See §179.5 of this subchapter. Transfer of a

tank car from one specified service on its certificate of construction to another may be made only by the owner or with the owner's authorization. A tank car proposed for a commodity service other than specified on its certificate of construction must be approved for such service by the AAR's Tank Car Committee.

(3) No person may fill a tank car overdue for periodic inspection with a hazardous material and then offer it for transportation. Any tank car marked as meeting a DOT specification and any non-specification tank car transporting a hazardous material must have a periodic inspection and test conforming to subpart F of part 180 of this subchapter.

(4) No railroad tank car, regardless of its construction date, may be used for the transportation in commerce of any hazardous material unless the air brake equipment support attachments of such tank car conform to the standards for attachments set forth in §§179.100–16 and 179.200–19 of this subchapter.

(5) No railroad tank car, regardless of its construction date, may be used for the transportation in commerce of any hazardous material with a self-energized manway located below the liquid level of the lading.

(6) Unless otherwise specifically provided in this part:

(i) When the tank car delimiter is an "A," offerors may also use tank cars with a delimiter "S," "J" or "T".

(ii) When the tank car delimiter is an "S," offerors may also use tank cars with a delimiter "J" or "T".

(iii) When a tank car delimiter is a "T" offerors may also use tank cars with a delimiter of "J".

(iv) When a tank car delimiter is a "J", offerors may not use a tank car with any other delimiter.

(7) A class DOT-103 or DOT-104 tank car may continue to be used for the transportation of a hazardous material if it meets the requirements of this subchapter and the design requirements in part 179 of this subchapter in effect on September 30, 2003; however, no new construction is authorized.

(8) A tank car authorized by the Transport Canada TDG Regulations (IBR, see §171.7 of this subchapter) may

be used provided it conforms to the applicable requirements in §171.12 of this subchapter.

(b) *Safety systems*—(1) *Coupler vertical restraint*. Each tank car conforming to a DOT specification and any other tank car used for transportation of a hazardous material must be equipped with a coupler vertical restraint system that meets the requirements of §179.14 of this subchapter.

(2) *Pressure relief devices*. (i) Pressure relief devices on tank cars must conform to part 179 of this subchapter.

(ii) A single-unit tank car transporting a Division 6.1 PG I or II, or Class 2, 3, or 4 material must have a reclosing pressure relief device. However, a single-unit tank car built before January 1, 1991, and equipped with a non-reclosing pressure relief device may be used to transport a Division 6.1 PG I or II material or a Class 4 liquid provided such materials do not meet the definition of a material poisonous by inhalation.

(3) *Tank-head puncture-resistance requirements*. The following tank cars must have a tank-head puncture-resistance system that conforms to the requirements in §179.16 of this subchapter, or to the corresponding requirements in effect at the time of installation:

(i) Tank cars transporting a Class 2 material.

(ii) Tank cars constructed from aluminum or nickel plate that are used to transport hazardous material.

(iii) Except as provided in paragraph (b)(3)(iv) of this section, those tank cars specified in paragraphs (b)(3)(i) and (ii) of this section not requiring a tank-head puncture resistance system prior to July 1, 1996, must have a tank-head puncture resistance system installed no later than July 1, 2006.

(iv) Class DOT 105A tank cars built prior to September 1, 1981, having a tank capacity less than 70 kl (18,500 gallons), and used to transport a Division 2.1 (flammable gas) material, must have a tank-head puncture-resistant system installed no later than July 1, 2001.

(4) *Thermal protection requirements*. The following tank cars must have thermal protection that conforms to

the requirements of §179.18 of this subchapter:

(i) Tank cars transporting a Class 2 material, except for a class 106, 107A, 110, and 113 tank car. A tank car equipped with a thermal protection system conforming to §179.18 of this subchapter, or that has an insulation system having an overall thermal conductance of no more than 0.613 kilojoules per hour, per square meter, per degree Celsius temperature differential (0.03 B.t.u. per square foot, per hour, per degree Fahrenheit temperature differential), conforms to this requirement.

(ii) A tank car transporting a Class 2 material that was not required to have thermal protection prior to July 1, 1996, must be equipped with thermal protection no later than July 1, 2006.

(5) *Bottom-discontinuity protection requirements*. No person may offer for transportation a hazardous material in a tank car with bottom-discontinuity protection unless the tank car has bottom-discontinuity protection that conforms to the requirements of E9.00 and E10.00 of the AAR Specifications for Tank Cars (IBR, see §171.7 of this subchapter). Tank cars not requiring bottom-discontinuity protection under the terms of Appendix Y of the AAR Specifications for Tank Cars as of July 1, 1996, must conform to these requirements no later than July 1, 2006, except that tank cars transporting a material that is hazardous only because it meets the definition of an elevated temperature material or because it is molten sulfur do not require bottom discontinuity protection.

(6) *Scheduling of modifications and progress reporting*. The date of conformance for the continued use of tank cars subject to paragraphs (b)(4), (b)(5), and (f) of this section and §173.314(j) is subject to the following conditions and limitations.

(i) Each tank car owner shall modify, reassign, retire, or remove at least 50 percent of their in-service tank car fleet within the first half of the compliance period and the remainder of their in-service tank car fleet during the second half of the compliance period.

(ii) By October 1 of each year, each owner of a tank car subject to this

§ 173.31

49 CFR Ch. I (10–1–14 Edition)

paragraph (b)(6) shall submit to the Federal Railroad Administration, Hazardous Materials Division, Office of Safety Assurance and Compliance, 1120 Vermont Avenue, Mail Stop 25, Washington, DC 20590, a progress report that shows the total number of in-service tank cars that need head protection, thermal protection, or bottom-discontinuity protection; the number of new or different tank cars acquired to replace those tank cars required to be upgraded to a higher service pressure; and the total number of tank cars modified, reassigned, acquired, retired, or removed from service the previous year.

(c) *Tank car test pressure.* A tank car used for the transportation of a hazardous material must have a tank test pressure equal to or greater than the greatest of the following:

(1) Except for shipments of carbon dioxide, anhydrous hydrogen chloride, vinyl fluoride, ethylene, or hydrogen, 133 percent of the sum of lading vapor pressure at the reference temperature of 46 °C (115 °F) for non-insulated tank cars or 41 °C (105 °F) for insulated tank cars plus static head, plus gas padding pressure in the vacant space of a tank car;

(2) 133 percent of the maximum loading or unloading pressure, whichever is greater;

(3) 20.7 Bar (300 psig) for materials that are poisonous by inhalation (see § 173.31(e)(2)(i) for compliance dates);

(4) The minimum pressure prescribed by the specification in part 179 of this subchapter; or

(5) The minimum test pressure prescribed for the specific hazardous material in the applicable packaging section in subpart F or G of this part.

(d) *Examination before shipping.* (1) No person may offer for transportation a tank car containing a hazardous material or a residue of a hazardous material unless that person determines that the tank car is in proper condition and safe for transportation. As a minimum, each person offering a tank car for transportation must perform an external visual inspection that includes:

(i) Except where insulation or a thermal protection system precludes an inspection, the tank shell and heads for abrasion, corrosion, cracks, dents, dis-

tortions, defects in welds, or any other condition that makes the tank car unsafe for transportation;

(ii) The piping, valves, fittings, and gaskets for corrosion, damage, or any other condition that makes the tank car unsafe for transportation;

(iii) For missing or loose bolts, nuts, or elements that make the tank car unsafe for transportation;

(iv) All closures on tank cars and determine that the closures and all fastenings securing them are properly tightened in place by the use of a bar, wrench, or other suitable tool;

(v) Protective housings for proper securement;

(vi) The pressure relief device, including a careful inspection of the rupture disc in non-reclosing pressure relief devices, for corrosion or damage that may alter the intended operation of the device. The rupture disc is not required to be removed prior to visual inspection if the tank car contains the residue, as defined in § 171.8 of this subchapter, of a Class 8, PG II or PG III material with no subsidiary hazard or the residue of a Class 9 elevated temperature material;

(vii) Each tell-tale indicator after filling and prior to transportation to ensure the integrity of the rupture disc;

(viii) The external thermal protection system, tank-head puncture resistance system, coupler vertical restraint system, and bottom discontinuity protection for conditions that make the tank car unsafe for transportation;

(ix) The required markings on the tank car for legibility; and

(x) The periodic inspection date markings to ensure that the inspection and test intervals are within the prescribed intervals.

(2) Closures on tank cars are required, in accordance with this subchapter, to be designed and closed so that under conditions normally incident to transportation, including the effects of temperature and vibration, there will be no identifiable release of a hazardous material to the environment. In any action brought to enforce this section, the lack of securement of any closure to a tool-tight condition, detected at any point, will establish a

rebuttable presumption that a proper inspection was not performed by the offeror of the car. That presumption may be rebutted by any evidence indicating that the lack of securement resulted from a specific cause not within the control of the offeror.

(e) *Special requirements for materials poisonous by inhalation*—(1) *Interior heater coils*. Tank cars used for materials poisonous by inhalation may not have interior heater coils.

(2) Tank car specifications. A tank car used for a material poisonous by inhalation must have a tank test pressure of 20.7 Bar (300 psig) or greater, head protection, and a metal jacket (e.g., DOT 105S300W), except that—

(i) A higher test pressure is required if otherwise specified in this subchapter; and

(ii) Each tank car constructed on or after March 16, 2009, and used for the transportation of PIH materials must meet the applicable authorized tank car specifications and standards listed in §173.244(a)(2) or (3) and §173.314(c) or (d).

(iii) A tank car meeting the applicable authorized tank car specifications listed in §173.244(a)(2) or (3), or §173.314(c) or (d) is authorized for the transportation of a material poisonous by inhalation for a period of 20 years after the date of original construction.

(iv) A tank car owner retiring or otherwise removing a tank car from service transporting materials poisonous by inhalation, other than because of damage to the car, must retire or remove cars constructed of non-normalized steel in the head or shell before removing any car in service transporting materials poisonous by inhalation constructed of normalized steel meeting the applicable DOT specification.

(f) *Special requirements for hazardous substances*. (1) A tank car used for a hazardous substance listed in paragraph (f)(2) of this section must have a tank test pressure of at least 13.8 Bar (200 psig), head protection and a metal jacket, except that—

(i) No metal jacket is required if—

(A) The tank test pressure is 23.4 Bar (340 psig) or higher; or

(B) The tank shell and heads are manufactured from AAR steel specification TC-128, normalized;

(ii) A higher test pressure is required if otherwise specified in this subchapter; and

(iii) Other than as provided in paragraph (b)(6) of this section, a tank car which does not conform to the requirements of this paragraph (f)(1), and was authorized for a hazardous substance under the regulations in effect on June 30, 1996, may continue in use until July 1, 2006.

(2) *List of hazardous substances*. Hazardous substances for which the provisions of this paragraph (f) apply are as follows:

Aldrin
 Allyl chloride
 alpha-BHC
 beta-BHC
 delta-BHC
 gamma-BHC
 Bis(2-chloroethyl) ether
 Bromoform
 Carbon tetrachloride
 Chlordane
 p-Chloroaniline
 Chlorobenzene
 Chlorobenzilate
 p-Chloro-m-cresol
 2-Chloroethyl vinyl ether
 Chloroform
 2-Chloronaphthalene
 o-Chlorophenol
 3-Chloropropionitrile
 DDE
 DDT
 1,2-Dibromo-3-chloropropane
 m-Dichlorobenzene
 o-Dichlorobenzene
 p-Dichlorobenzene
 3,3'-Dichlorobenzidine
 1,4-Dichloro-2-butene
 1,1-Dichloroethane
 1,2-Dichloroethane
 1,1-Dichloroethylene
 Dichloroisopropyl ether
 Dichloromethane @
 2,4-Dichlorophenol
 2,6-Dichlorophenol
 1,2-Dichloropropane
 1,3-Dichloropropene
 Dieldrin
 alpha-Endosulfan
 beta-Endosulfan
 Endrin
 Endrin aldehyde
 Heptachlor
 Heptachlor epoxide
 Hexachlorobenzene
 Hexachlorobutadiene
 Hexachloroethane
 Hexachlorophene
 Hexachloropropene
 Isodrin

§ 173.32

Kepone
Methoxychlor
4,4'-Methylenebis(2-chloroaniline)
Methylene bromide
Pentachlorobenzene
Pentachloroethane
Pentachloronitrobenzene (PCNB)
Pentachlorophenol
Polychlorinated biphenyls (PCBs)
Pronamide
Silvex (2,4,5-TP)
2,4,5-T
TDE
1,2,4,5-Tetrachlorobenzene
2,3,7,8-Tetrachlorodibenzo-p-dioxin (TCDD)
Tetrachloroethane
Tetrachloroethylene
2,3,4,6-Tetrachlorophenol
Toxaphene
1,2,4-Trichlorobenzene
1,1,1-Trichloroethane
1,1,2-Trichloroethane
Trichloroethylene
2,4,5-Trichlorophenol
2,4,6-Trichlorophenol
Tris(2,3-dibromopropyl) phosphate

(g) *Tank car loading and unloading.* When placed for loading or unloading and before unsecuring any closure, a tank car must be protected against movement or coupling as follows:

(1) Each hazmat employee who is responsible for loading or unloading a tank car must secure access to the track to prevent entry by other rail equipment, including motorized service vehicles. Derails, lined and locked switches, portable bumper blocks, or other equipment that provides an equivalent level of security may be used to satisfy this requirement.

(2) Caution signs must be displayed on the track or on the tank cars to warn persons approaching the cars from the open end of the track and must be left up until after all closures are secured and the cars are in proper condition for transportation. The caution signs must be of metal or other durable material, rectangular, at 30.48 cm (12 inches) high by 38.10 cm (15 inches) wide, and bear the word "STOP." The word "STOP" must appear in letters at least 10.16 cm (4 inches) high. The letters must be white on a blue background. Additional words, such as "Tank Car Connected" or "Crew at Work," may also appear in white letters under the word "STOP."

(3) At least one wheel on the tank car must be blocked against movement in both directions, and the hand brakes

49 CFR Ch. I (10–1–14 Edition)

must be set. If multiple tank cars are coupled together, sufficient hand brakes must be set and wheels blocked to prevent movement in both directions.

[Amdt. 173–245, 60 FR 49072, Sept. 21, 1995, as amended by Amdt. 173–245, 61 FR 33254, June 26, 1996; Amdt. 173–256, 61 FR 51338, Oct. 1, 1996; 65 FR 58629, Sept. 29, 2000; 66 FR 33427, June 21, 2001; 66 FR 45379, 45381, Aug. 28, 2001; 68 FR 48569, Aug. 14, 2003; 68 FR 75743, Dec. 31, 2003; 68 FR 61941, Oct. 30, 2003; 70 FR 34075, June 13, 2005; 72 FR 25176, May 3, 2007; 72 FR 55692, Oct. 1, 2007; 74 FR 1799, Jan. 13, 2009; 75 FR 27215, May 14, 2010]

§ 173.32 Requirements for the use of portable tanks.

(a) *General requirements.* No person may offer a hazardous material for transportation in a portable tank except as authorized by this subchapter.

(1) Except as otherwise provided in this subpart, no person may use a portable tank for the transportation of a hazardous material unless it meets the requirements of this subchapter.

(2) No person may fill and offer for transportation a portable tank when the prescribed periodic test or inspection under subpart G of part 180 of this subchapter has become due until the test or inspection has been successfully completed. This requirement does not apply to any portable tank filled prior to the test or inspection due date.

(3) When a portable tank is used as a cargo tank motor vehicle, it must conform to all the requirements prescribed for cargo tank motor vehicles. (See § 173.33.)

(b) *Substitute packagings.* A particular Specification portable tank may be substituted for another portable tank as follows:

(1) An IM or UN portable tank may be used whenever an IM or UN portable tank having less stringent requirements is authorized provided the portable tank meets or exceeds the requirements for pressure-relief devices, bottom outlets and any other special provisions specified in § 172.102(c)(7)(vi) of this subchapter.

(2) Where a Specification IM101 or IM102 portable tank is prescribed, a UN portable tank or Specification 51 portable tank otherwise conforming to the special commodity requirements of § 172.102(c)(7) of this subchapter for the

material to be transported may be used.

(3) A DOT Specification 51 portable tank may be used whenever a DOT Specification 56, 57, or 60 portable tank is authorized. A DOT Specification 60 portable tank may be used whenever a DOT Specification 56 or 57 portable tank is authorized. A higher integrity tank used instead of a specified portable tank must meet the same design profile; for example, a DOT Specification 51 portable tank must be lined if used instead of a lined DOT Specification 60 portable tank.

(4) A portable tank authorized by the Transport Canada TDG Regulations (IBR, see § 171.7 of this subchapter) may be used provided it conforms to the applicable requirements in § 171.12 of this subchapter.

(c) *Grandfather provisions for portable tanks*—(1) *Continued use of Specification 56 and 57 portable tanks.* Continued use of an existing portable tank constructed to DOT Specification 56 or 57 is authorized only for a portable tank constructed before October 1, 1996. A stainless steel portable tank internally lined with polyethylene that was constructed on or before October 1, 1996, and that meets all requirements of DOT Specification 57 except for being equipped with a polypropylene discharge ball valve and polypropylene secondary discharge opening closure, may be marked as a Specification 57 portable tank and used in accordance with the provisions of this section.

(2) A DOT Specification 51, IM 101, or IM 102 portable tank may not be manufactured after January 1, 2003; however, such tanks may continue to be used for the transportation of a hazardous material provided they meet the requirements of this subchapter, including the specification requirements and the requirements of this subchapter for the transportation of the particular hazardous material according to the T codes in effect on September 30, 2001 or the new T codes in § 172.102(c)(7)(i), and provided the portable tanks conform to the periodic inspection and tests specified for the particular portable tank in subpart G of part 180 of this subchapter. After January 1, 2003, all newly manufactured portable tanks must conform to the requirements for

the design, construction and approval of UN portable tanks as specified in §§ 178.273, 178.274, 178.275, 178.276, 178.277 and part 180, subpart G, of this subchapter.

(3) A DOT Specification portable tank manufactured prior to January 1, 1992 that is equipped with a non-reclosing pressure relief device may continue in service for the hazardous materials for which it is authorized. Except for a DOT Specification 56 or 57 portable tank, a DOT Specification portable tank manufactured after January 1, 1992, used for materials meeting the definition for Division 6.1 liquids, Packing Group I or II, Class 2 gases, or Class 3 or 4 liquids, must be equipped with a reclosing pressure relief valve having adequately sized venting capacity unless otherwise specified in this subchapter (see §§ 178.275(f)(1) and 178.277 of this subchapter).

(4) Any portable tank container constructed prior to May 15, 1950, complying with the requirements of either the ASME Code for Unfired Pressure Vessels, 1946 Edition, or the API ASME Code for Unfired Pressure Vessels, 1943 Edition, may be used for the transportation of liquefied compressed gas, provided it fulfills all the requirements of the part and specifications for the particular gas or gases to be transported. Such portable tanks must be marked “ICC Specification 51X” on the plate required by the specification, except as modified by any or all of the following:

(i) Portable tanks designed and constructed in accordance with Pars. U-68, U-69, or U-201 of the ASME Code, 1943 and 1946 editions, may be used. Portable tanks designed and constructed in accordance with Par. U-68 or Par. U-69 may be re-rated at a working pressure 25 percent in excess of the design pressure for which the portable tank was originally constructed. If the portable tank is re-rated, the re-rated pressure must be marked on the plate as follows: “Re-rated working pressure—psig”.

(ii) Loading and unloading accessories, valves, piping, fittings, safety and gauging devices, do not have to comply with the requirements for the particular location on the portable tank.

(5) Any ICC Specification 50 portable tank fulfilling the requirements of that specification may be continued in service for transportation of a liquefied petroleum gas if it is retested every five years in accordance with the requirements in §180.605 of this subchapter. Use of existing portable tanks is authorized. New construction is not authorized.

(d) *Determination of an authorized portable tank.* Prior to filling and offering a portable tank for transportation, the shipper must ensure that the portable tank conforms to the authorized specification and meets the applicable requirements in this subchapter for the hazardous material. The shipper must ensure that the MAWP, design pressure or test pressure of the portable tank, as applicable, is appropriate for the hazardous material being transported. Determination of the applicable pressure must take into account the maximum pressure used to load or unload the hazardous material, the vapor pressure, static head and surge pressures of the hazardous material and the temperatures that the hazardous material will experience during transportation.

(e) *External inspection prior to filling.* Each portable tank must be given a complete external inspection prior to filling. Any unsafe condition must be corrected prior to its being filled and offered for transportation. The external inspection shall include a visual inspection of:

(1) The shell, piping, valves and other appurtenances for corroded areas, dents, defects in welds and other defects such as missing, damaged, or leaking gaskets;

(2) All flanged connections or blank flanges for missing or loose nuts and bolts;

(3) All emergency devices for corrosion, distortion, or any damage or defect that could prevent their normal operation;

(4) All required markings on the tank for legibility; and

(5) Any device for tightening manhole covers to ensure such devices are operative and adequate to prevent leakage at the manhole cover.

(f) *Loading requirements.* (1) A hazardous material may not be loaded into

a portable tank if the hazardous material would:

(i) Damage the portable tank;

(ii) React with the portable tank; or

(iii) Otherwise compromise its product retention capability.

(2) A hazardous material may not be loaded in a DOT Specification 51, DOT Specification 60, an IM or UN portable tank unless the portable tank has a pressure relief device that provides total relieving capacity meeting the requirements of this subchapter.

(3) Except during a pressure test, a portable tank may not be subjected to a pressure greater than its marked maximum allowable working pressure or, when appropriate, its marked design pressure.

(4) A portable tank may not be loaded to a gross mass greater than the maximum allowable gross mass specified on its identification plate.

(5) Except for a non-flowable solid or a liquid with a viscosity of 2,680 centistokes (millimeters squared per second) or greater at 20 °C (68 °F), an IM or UN portable tank, or compartment thereof, having a volume greater than 7,500 L (1,980 gallons) may not be loaded to a filling density of more than 20% and less than 80% by volume. This filling restriction does not apply if a portable tank is divided by partitions or surge plates into compartments of not more than 7,500 L (1,980 gallons) capacity; this portable tank must not be offered for transportation in an ullage condition liable to produce an unacceptable hydraulic force due to surge.

(6) The outage for a portable tank may not be less than 2% at a temperature of 50 °C (122 °F) unless otherwise specified in this subchapter. For UN portable tanks, the applicable maximum filling limits apply as specified according to the assigned TP codes in Column (7) of the §172.101 Table of this subchapter except when transported domestically.

(7) Each tell-tale indicator or pressure gauge located in the space between a frangible disc and a safety relief valve mounted in series must be checked after the tank is filled and prior to transportation to ensure that the frangible disc is leak free. Any leakage through the frangible disc

must be corrected prior to offering the tank for transportation.

(8) During filling, the temperature of the hazardous materials shall not exceed the limits of the design temperature range of the portable tank.

(9) The maximum mass of liquefied compressed gas per liter (gallon) of shell capacity (kg/L or lbs./gal.) may not exceed the density of the liquefied compressed gas at 50 °C (122 °F). The portable tank must not be liquid full at 60 °C (140 °F).

(g) *Additional requirements for specific modal transport.* In addition to other applicable requirements, the following apply:

(1) A portable tank containing a hazardous material may not be loaded onto a highway or rail transport vehicle unless loaded entirely within the horizontal outline of the vehicle, without overhang or projection of any part of the tank assembly.

(2) An IM or UN portable tank used for the transportation of flammable liquids by rail may not be fitted with non-reclosing pressure relief devices except in series with reclosing pressure relief valves.

(3) A portable tank or Specification 106A or 110A multi-unit tank car containing a hazardous material may not be offered for transportation aboard a passenger vessel unless:

(i) The vessel is operating under a change to its character of vessel certification as defined in §171.8 of this subchapter; and

(ii) The material is permitted to be transported aboard a passenger vessel in the §172.101 Table of this subchapter.

(h) *Additional general commodity-specific requirements.* In addition to other applicable requirements, the following requirements apply:

(1) Each uninsulated portable tank used for the transportation of a liquefied compressed gas must have an exterior surface finish that is significantly reflective, such as a light-reflecting color if painted, or a bright reflective metal or other material if unpainted.

(2) If a hazardous material is being transported in a molten state, the portable tank must be thermally insulated with suitable insulation material of sufficient thickness that the overall thermal conductance is not more than

0.080 Btu per hour per square foot per degree Fahrenheit differential.

(3) No person may offer a liquid hazardous material of Class 3, PG I or II, or PG III with a flash point of less than 100 °F (38 °C); Division 5.1, PG I or II; or Division 6.1, PG I or II, in an IM or UN portable tank that is equipped with a bottom outlet as authorized in Column (7) of the §172.101 Table of this subchapter by assignment of a T Code in the appropriate proper shipping name entry, for unloading to a facility while it remains on a transport vehicle with the power unit attached unless—

(i) The tank outlets conform to §178.275(d)(3) of this subchapter; or

(ii) The facility at which the IM or UN portable tank is to be unloaded conforms to the requirements in §177.834(o) of this subchapter.

(i) *Additional requirements for portable tanks other than IM specification and UN portable tanks.* (1) The bursting strength of any piping and fittings must be at least four times the design pressure of the tank, and at least four times the pressure to which, in any instance, it may be subjected in service by the action of a pump or other device (not including safety relief valves) that may subject piping to pressures greater than the design pressure of the tank.

(2) Pipe joints must be threaded, welded or flanged. If threaded pipe is used, the pipe and pipe fittings must not be lighter than Schedule 80 weight. Where copper tubing is permitted, joints must be brazed or be of equally strong metal union type. The melting point of brazing material may not be lower than 1,000 °F (537.8 °C). The method of joining tubing must not decrease the strength of the tubing such as by the cutting of threads.

(3) Non-malleable metals may not be used in the construction of valves or fittings.

(4) Suitable provision must be made in every case to allow for expansion, contraction, jarring and vibration of all pipe. Slip joints may not be used for this purpose.

(5) Piping and fittings must be grouped in the smallest practicable space and must be protected from damage as required by the specification.

(6) All piping, valves and fittings on every portable tank must be leakage

tested with gas or air after installation and proved tight at not less than the design pressure of the portable tank on which they are used. In the event of replacement, all such piping, valves, or fittings must be tested in accordance with the requirements of this section before the portable tank is returned to transportation service. The requirements of this section apply to all hoses used on portable tanks, except that hoses may be tested either before or after installation on the portable tank.

(7) All materials used in the construction of portable tanks and their appurtenances may not be subject to destructive attack by the contents of the portable tank.

(8) No aluminum, copper, silver, zinc nor their alloys may be used. Brazed joints may not be used. All parts of a portable tank and its appurtenances used for anhydrous ammonia must be steel.

(9) Each outlet of a portable tank used for the transportation of non-refrigerated liquefied compressed gases, except carbon dioxide, must be provided with a suitable automatic excess-flow valve (see definition in §178.337-1(g) of this subchapter). The valve must be located inside the portable tank or at a point outside the portable tank where the line enters or leaves the portable tank. The valve seat must be located inside the portable tank or may be located within a welded flange or its companion flange, or within a nozzle or within a coupling. The installation must be made in such a manner as to reasonably assure that any undue strain which causes failure requiring functioning of the valve shall cause failure in such a manner that it will not impair the operation of the valve.

(i) A safety device connection or liquid level gauging device that is constructed so that the outward flow of the tank contents will not exceed that passed by an opening of 0.1397 cm (0.0550 inches) is not required to be equipped with excess-flow valves.

(ii) An excess-flow valve must close automatically if the flow reaches the rated flow of gas or liquid specified by the original valve manufacturer when piping mounted directly on the valve is sheared off before the first valve,

pump, or fitting downstream from the excess flow valve.

(iii) An excess-flow valve may be designed with a by-pass, not to exceed a 0.1016 cm (0.040 inches) diameter opening to allow equalization of pressure.

(iv) Filling and discharge lines must be provided with manually operated shut-off valves located as close to the tank as practical. Unless this valve is manually operable at the valve, the line must also have a manual shut-off valve. The use of “Stop-Check” valves to satisfy with one valve the requirements of this section is forbidden. For portable tanks used for refrigerated liquefied gases, a “stop check” valve may be used on the vapor side of the pressure buildup circuit.

(10) Each portable tank used for carbon dioxide or nitrous oxide must be lagged with a suitable insulation material of such thickness that the overall thermal conductance is not more than 0.08 Btu per square foot per degree Fahrenheit differential in temperature per hour. The conductance must be determined at 60 °Fahrenheit. Insulation material used on portable tanks for nitrous oxide must be noncombustible.

(11) Refrigerating or heating coils must be installed in portable tanks used for carbon dioxide and nitrous oxide. Such coils must be tested externally to at least the same pressure as the test pressure of the portable tank. The coils must also be tested internally to at least twice the working pressure of the heating or refrigerating system to be used, but in no case less than the test pressure of the portable tank. Such coils must be securely anchored. In the event of leakage, the refrigerant or heating medium to be circulated through the coil or coils must have no adverse chemical reaction with the portable tank or its contents.

(12) Excess flow valves are not required for portable tanks used for the transport of refrigerated liquefied gases.

[66 FR 33427, June 21, 2001, as amended at 67 FR 15743, Apr. 3, 2002; 68 FR 32413, May 30, 2003; 68 FR 57632, Oct. 6, 2003; 68 FR 75742, 75743, Dec. 31, 2003; 69 FR 54046, Sept. 7, 2004; 72 FR 25176, May 3, 2007; 76 FR 81400, Dec. 28, 2011]

§ 173.33 Hazardous materials in cargo tank motor vehicles.

(a) *General requirements.* (1) No person may offer or accept a hazardous material for transportation in a cargo tank motor vehicle except as authorized by this subchapter.

(2) Two or more materials may not be loaded or accepted for transportation in the same cargo tank motor vehicle if, as a result of any mixture of the materials, an unsafe condition would occur, such as an explosion, fire, excessive increase in pressure or heat, or the release of toxic vapors.

(3) No person may fill and offer for transportation a specification cargo tank motor vehicle for which the prescribed periodic retest or reinspection under subpart E of part 180 of this subchapter is past due until the retest or inspection has been successfully completed. This requirement does not apply to a cargo tank supplied by a motor carrier who is other than the person offering the hazardous material for transportation (see §180.407(a)(1) of this subchapter), or to any cargo tank filled prior to the retest or inspection due date.

(b) *Loading requirements.* (1) A hazardous material may not be loaded in a cargo tank if during transportation any part of the tank in contact with the hazardous material lading would have a dangerous reaction with the hazardous material.

(2) A cargo tank may not be loaded with a hazardous material that will have an adverse effect on the tank's integrity or—

(i) May combine chemically with any residue or contaminants in the tank to produce an explosion, fire, excessive increase in pressure, release of toxic vapors or other unsafe condition.

(ii)–(iii) [Reserved]

(iv) May severely corrode or react with the tank material at any concentration and temperature that will exist during transportation.

(v) Is prohibited by §173.21 or §173.24 of this subchapter.

(3) Air pressure in excess of ambient atmospheric pressure may not be used to load or unload any lading which may create an air-enriched mixture within the flammability range of the lading in the vapor space of the tank.

(4) To prevent cargo tank rupture in a loading or unloading accident, the loading or unloading rate used must be less than or equal to that indicated on the cargo tank specification plate, except as specified in §173.318(b)(6). If no loading or unloading rate is marked on the specification plate, the loading or unloading rate and pressure used must be limited such that the pressure in the tank may not exceed 130% of the MAWP.

(c) *Maximum Lading Pressure.* (1) Prior to loading and offering a cargo tank motor vehicle for transportation with material that requires the use of a specification cargo tank, the person must confirm that the cargo tank motor vehicle conforms to the specification required for the lading and that the MAWP of the cargo tank is greater than or equal to the largest pressure obtained under the following conditions:

(i) For compressed gases and certain refrigerated liquids that are not cryogenic liquids, the pressure prescribed in §173.315 of this subchapter.

(ii) For cryogenic liquids, the pressure prescribed in §173.318 of this subchapter.

(iii) For liquid hazardous materials loaded in DOT specification cargo tanks equipped with a 1 psig normal vent, the sum of the tank static head plus 1 psig. In addition, for hazardous materials loaded in these cargo tanks, the vapor pressure of the lading at 115 °F must be not greater than 1 psig, except for gasoline transported in accordance with Special Provision B33 in §172.102(c)(3) of this subchapter.

(iv) For liquid hazardous materials not covered in paragraph (c)(1)(i), (ii), or (iii) of this section, the sum of the vapor pressure of the lading at 115 °F, plus the tank static head exerted by the lading, plus any pressure exerted by the gas padding, including air in the ullage space or dome.

(v) The pressure prescribed in subpart B, D, E, F, G, or H of this part, as applicable.

(vi) The maximum pressure in the tank during loading or unloading.

(2) Any Specification MC 300, MC 301, MC 302, MC 303, MC 305, MC 306 or MC 312, cargo tank motor vehicle with no marked design pressure or marked with

§ 173.33

49 CFR Ch. I (10–1–14 Edition)

a design pressure of 3 psig or less may be used for an authorized lading where the pressure derived from §173.33(c)(1) is less than or equal to 3 psig. After December 31, 1990, a cargo tank may not be loaded and offered for transportation unless marked or remarked with an MAWP or design pressure in accordance with 49 CFR 180.405(k).

(3) Any Specification MC 310 or MC 311 cargo tank motor vehicle may be used for an authorized lading where the pressure derived from §173.33(c)(1) is less than or equal to the MAWP or MWP, respectively, as marked on the specification plate.

(4) Any cargo tank marked or certified before August 31, 1995, marked with a design pressure rather than an MAWP may be used for an authorized lading where the largest pressure derived from §173.33(c)(1) is less than or equal to the design pressure marked on the cargo tank.

(5) Any material that meets the definition of a Division 6.1, Packing Group I or II (poisonous liquid) material must be loaded in a cargo tank motor vehicle having a MAWP of 25 psig or greater.

(6) *Substitute packagings.* Unless otherwise specified, where MC 307, MC 312, DOT 407 or DOT 412 cargo tanks are authorized, minimum tank design pressure is 172.4 kPa (25 psig) for any Packing Group I or Packing Group II liquid lading that meets more than one hazard class definition.

(d) *Relief system.* (1) Non-reclosing pressure relief devices are not authorized in any cargo tank except when in series with a reclosing pressure relief device. However, a cargo tank marked or certified before August 31, 1995 which is fitted with non-reclosing pressure relief devices may continue to be used in any hazardous material service for which it is authorized. The requirements in this paragraph do not apply to MC 330, MC 331 and MC 338 cargo tanks.

(2) Each cargo tank motor vehicle used to transport a liquid hazardous material with a gas pad must have a pressure relief system that provides the venting capacity prescribed in §178.345-10(e) of this subchapter. The requirements in this paragraph do not

apply to MC 330, MC 331 and MC 338 cargo tanks.

(3) A cargo tank motor vehicle made to a specification listed in column 1 may have pressure relief devices or outlets conforming to the applicable specification to which the tank was constructed, or the pressure relief devices or outlets may be modified to meet the applicable requirement for the specification listed in column 2 without changing the markings on the tank specification plate. The venting capacity requirements of the original DOT cargo tank specification must be met whenever a pressure relief valve is modified.

Column 1	Column 2
MC 300, MC 301, MC 302, MC 303, MC 305.	MC 306 or DOT 406.
MC 306	DOT 406.
MC 304	MC 307 or DOT 407.
MC 307	DOT 407.
MC 310, MC 311	MC 312 or DOT 412.
MC 312	DOT 412.
MC 330	MC 331.

(e) *Retention of hazardous materials in product piping during transportation.* DOT specification cargo tanks used for the transportation of any material that is a Division 6.1 (poisonous liquid) material, oxidizer liquid, liquid organic peroxide or corrosive liquid (corrosive to skin only) may not be transported with hazardous materials lading retained in the piping, unless the cargo tank motor vehicle is equipped with bottom damage protection devices meeting the requirements of §178.337-10 or §178.345-8(b) of this subchapter, or the accident damage protection requirements of the specification under which it was manufactured. This requirement does not apply to a residue which remains after the piping is drained. A sacrificial device (see §178.345-1 of this subchapter) may not be used to satisfy the accident damage protection requirements of this paragraph.

(f) An MC 331 type cargo tank may be used where MC 306, MC 307, MC 312, DOT 406, DOT 407 or DOT 412 type cargo tanks are authorized. An MC 307, MC 312, DOT 407 or DOT 412 type cargo tank may be used where MC 306 or DOT 406 type cargo tanks are authorized. A higher integrity tank used instead of a

specified tank must meet the same design profile (for example, an MC 331 cargo tank must be lined if used in place of a lined MC 312 cargo tank.)

(g) *Remote control of self-closing stop valves—MC 330, MC 331 and MC 338 cargo tanks.* Each liquid or vapor discharge opening in an MC 330 or MC 331 cargo tank and each liquid filling and liquid discharge line in an MC 338 cargo tank must be provided with a remotely controlled internal self-closing stop valve except when an MC 330 or MC 331 cargo tank is marked and used exclusively to transport carbon dioxide; an MC 338 is used to transport argon, carbon dioxide, helium, krypton, neon, nitrogen, or xenon; or an MC 338 utilizes an external self-closing stop valve to comply with the requirements in §178.338–11(b). However, if the cargo tank motor vehicle was certified before January 1, 1995, this requirement is applicable only when an MC 330 or MC 331 cargo tank is used to transport a flammable liquid, flammable gas, hydrogen chloride (refrigerated liquid), or anhydrous ammonia; or when an MC 338 cargo tank is used to transport flammable ladings.

(h) A cargo tank motor vehicle authorized by the Transport Canada TDG Regulations (IBR, see §171.7 of this subchapter) may be used provided it conforms to the applicable requirements in §171.12 of this subchapter.

[Amdt. 173–212, 54 FR 25005, June 12, 1989]

EDITORIAL NOTE: For FEDERAL REGISTER citations affecting §173.33, see the List of CFR Sections Affected, which appears in the Finding Aids section of the printed volume and at www.fdsys.gov.

§ 173.34 [Reserved]

§ 173.35 Hazardous materials in IBCs.

(a) No person may offer or accept a hazardous material for transportation in an IBC except as authorized by this subchapter. Each IBC used for the transportation of hazardous materials must conform to the requirements of its specification and regulations for the transportation of the particular commodity. A specification IBC, for which the prescribed periodic retest or inspection under subpart D of part 180 of this subchapter is past due, may not be filled and offered for transportation until the retest or inspection have been

successfully completed. This requirement does not apply to any IBC filled prior to the retest or inspection due date.

(b) *Initial use and reuse of IBCs.* (Also see §180.352 of this subchapter.) An IBC other than a multiwall paper IBC (13M1 and 13M2) may be reused. If an inner liner is required, the inner liner must be replaced before each reuse. Before an IBC is filled and offered for transportation, the IBC and its service equipment must be given an external visual inspection, by the person filling the IBC, to ensure that:

(1) The IBC is free from corrosion, contamination, cracks, cuts, or other damage which would render it unable to pass the prescribed design type test to which it is certified and marked; and

(2) The IBC is marked in accordance with requirements in §178.703 of this subchapter. Additional marking allowed for each design type may be present. Required markings that are missing, damaged or difficult to read must be restored or returned to original condition.

(c) A metal IBC, or a part thereof, subject to thinning by mechanical abrasion or corrosion due to the lading, must be protected by providing a suitable increase in thickness of material, a lining or some other suitable method of protection. Increased thickness for corrosion or abrasion protection must be added to the wall thickness specified in §178.705(c)(1)(iv) of this subchapter.

(d) Notwithstanding requirements in §173.24b of this subpart, when filling an IBC with liquids, sufficient ullage must be left to ensure that, at the mean bulk temperature of 50 °C (122 °F), the IBC is not filled to more than 98 percent of its water capacity.

(e) Where two or more closure systems are fitted in series, the system nearest to the hazardous material being carried must be closed first.

(f) During transportation—

(1) No hazardous material may remain on the outside of the IBC; and

(2) Each IBC must be securely fastened to or contained within the transport unit.

(g) Each IBC used for transportation of solids which may become liquid at temperatures likely to be encountered

during transportation must also be capable of containing the substance in the liquid state.

(h) Liquid hazardous materials may only be offered for transportation in a metal, rigid plastic, or composite IBC that is appropriately resistant to an increase in internal pressure likely to develop during transportation.

(1) A rigid plastic or composite IBC may only be filled with a liquid having a vapor pressure less than or equal to the greater of the following two values: The first value is determined from any of the methods in paragraphs (h)(1)(i), (ii) or (iii) of this section. The second value is determined by the method in paragraph (h)(1)(iv) of this section.

(i) The gauge pressure (pressure in the IBC above ambient atmospheric pressure) measured in the IBC at 55 °C (131 °F). This gauge pressure must not exceed two-thirds of the marked test pressure and must be determined after the IBC was filled and closed at 15 °C (60 °F) to less than or equal to 98 percent of its capacity.

(ii) The absolute pressure (vapor pressure of the hazardous material plus atmospheric pressure) in the IBC at 50 °C (122 °F). This absolute pressure must not exceed four-sevenths of the sum of the marked test pressure and 100 kPa (14.5 psia).

(iii) The absolute pressure (vapor pressure of the hazardous material plus atmospheric pressure) in the IBC at 55 °C (131 °F). This absolute pressure must not exceed two-thirds of the sum of the marked test pressure and 100 kPa (14.5 psia).

(iv) Twice the static pressure of the substance, measured at the bottom of the IBC. This value must not be less than twice the static pressure of water.

(2) Liquids having a vapor pressure greater than 110 kPa (16 psig) at 50 °C (122 °F) or 130 kPa (18.9 psig) at 55 °C (131 °F) may not be transported in metal IBCs.

(i) The requirements in this section do not apply to DOT-56 or -57 portable tanks.

(j) No IBC may be filled with a Packing Group I liquid. Rigid plastic, composite, flexible, wooden or fiberboard IBC used to transport Packing Group I solid materials may not exceed 1.5 cubic meters (53 cubic feet) capacity.

For Packing Group I solids, a metal IBC may not exceed 3 cubic meters (106 cubic feet) capacity.

(k) When an IBC is used for the transportation of liquids with a flash point of 60 °C (140 °F) (closed cup) or lower, or powders with the potential for dust explosion, measures must be taken during product loading and unloading to prevent a dangerous electrostatic discharge.

(1) *IBC filling limits.* (1) Except as provided in this section, an IBC may not be filled with a hazardous material in excess of the maximum gross mass marked on that container.

(2) An IBC which is tested and marked for Packing Group II liquid materials may be filled with a Packing Group III liquid material to a gross mass not exceeding 1.5 times the maximum gross mass marked on that container, if all the performance criteria can still be met at the higher gross mass.

(3) An IBC which is tested and marked for liquid hazardous materials may be filled with a solid hazardous material to a gross mass not exceeding the maximum gross mass marked on that container. In addition, an IBC intended for the transport of liquids which is tested and marked for Packing Group II liquid materials may be filled with a Packing Group III solid hazardous material to a gross mass not exceeding the marked maximum gross mass multiplied by 1.5 if all the performance criteria can still be met at the higher gross mass.

(4) An IBC which is tested and marked for Packing Group I solid materials may be filled with a Packing Group II solid material to a gross mass not exceeding the maximum gross mass marked on that container, multiplied by 1.5, if all the performance criteria can be met at the higher gross mass; or a Packing Group III solid material to a gross mass not exceeding the maximum gross mass marked on the IBC, multiplied by 2.25, if all the performance criteria can be met at the higher gross mass. An IBC which is tested and marked for Packing Group II solid materials may be filled with a Packing Group III solid material to a gross mass not exceeding the maximum gross

mass marked on the IBC, multiplied by 1.5.

[Amdt. 173-238, 59 FR 38064, July 26, 1994, as amended by Amdt. 173-243, 60 FR 40038, Aug. 4, 1995; 64 FR 10777, Mar. 5, 1999; 66 FR 45380, 45381, Aug. 28, 2001; 68 FR 48569, Aug. 14, 2003; 71 FR 78631, Dec. 29, 2006; 75 FR 5393, Feb. 2, 2010; 77 FR 60942, Oct. 5, 2012]

§ 173.36 Hazardous materials in Large Packagings.

(a) No person may offer or accept a hazardous material for transportation in a Large Packaging except as authorized by this subchapter. Except as otherwise provided in this subchapter, no Large Packaging may be filled with a Packing Group I or II material. Each Large Packaging used for the transportation of hazardous materials must conform to the requirements of its specification and regulations for the transportation of the particular commodity.

(b) *Packaging design.* (1) *Inner packaging closures.* A Large Packaging containing liquid hazardous materials must be packed so that closures on inner packagings are upright.

(2) *Flexible Large Packagings.* Flexible Large Packagings (e.g., 51H) are only authorized for use with flexible inner packagings.

(3) *Friction.* The nature and thickness of the outer packaging must be such that friction during transportation is not likely to generate an amount of heat sufficient to dangerously alter the chemical stability of the contents.

(4) *Securing and cushioning.* Inner packagings of Large Packagings must be packed, secured and cushioned to prevent their breakage or leakage and to control their shifting within the outer packaging under conditions normally incident to transportation. Cushioning material must not be capable of reacting dangerously with the contents of the inner packagings or having its protective properties significantly weakened in the event of leakage.

(5) *Metallic devices.* Nails, staples and other metallic devices must not protrude into the interior of the outer packaging in such a manner as to be likely to damage inner packagings or receptacles.

(c) *Initial use and reuse of Large Packagings.* A Large Packaging may be re-

used. If an inner packaging is constructed of paper or flexible plastic, the inner packaging must be replaced before each reuse. Before a Large Packaging is filled and offered for transportation, the Large Packaging must be given an external visual inspection, by the person filling the Large Packaging, to ensure:

(1) The Large Packaging is free from corrosion, contamination, cracks, cuts, or other damage which would render it unable to pass the prescribed design type test to which it is certified and marked; and

(2) The Large Packaging is marked in accordance with requirements in §178.910 of this subchapter. Additional marking allowed for each design type may be present. Required markings that are missing, damaged or difficult to read must be restored or returned to original condition.

(d) During transportation—

(1) No hazardous material may remain on the outside of the Large Packaging; and

(2) Each Large Packaging must be securely fastened to or contained within the transport unit.

(e) Each Large Packaging used for transportation of solids which may become liquid at temperatures likely to be encountered during transportation may not be transported in paper or fiber inner packagings. The inner packagings must be capable of containing the substance in the liquid state.

(f) Liquid hazardous materials may only be offered for transportation in inner packagings appropriately resistant to an increase of internal pressure likely to develop during transportation.

(g) A Large Packaging used to transport hazardous materials may not exceed 3 cubic meters (106 cubic feet) capacity.

(h) *Mixed contents.* (1) An outer Large Packaging may contain more than one hazardous material only when—

(i) The inner and outer packagings used for each hazardous material conform to the relevant packaging sections of this part applicable to that hazardous material, and not result in a violation of §173.21;

(ii) The package as prepared for shipment meets the performance tests prescribed in part 178 of this subchapter for the hazardous materials contained in the package;

(iii) Corrosive materials (except ORM–D) in bottles are further packed in securely closed inner receptacles before packing in outer packagings; and

(iv) For transportation by aircraft, the total net quantity does not exceed the lowest permitted maximum net quantity per package as shown in Column 9a or 9b, as appropriate, of the §172.101 table. The permitted maximum net quantity must be calculated in kilograms if a package contains both a liquid and a solid.

(2) A packaging containing inner packagings of Division 6.2 materials may not contain other hazardous materials, except dry ice.

(i) When a Large Packaging is used for the transportation of liquids with a flash point of 60.5 °C (141 °F) (closed cup) or lower, or powders with the potential for dust explosion, measures must be taken during product loading and unloading to prevent a dangerous electrostatic discharge.

[75 FR 5393, Feb. 2, 2010]

§ 173.37 Hazardous Materials in Flexible Bulk Containers.

(a) No person may offer or accept a hazardous material for transportation in a Flexible Bulk Container except as authorized by this subchapter. Each Flexible Bulk Container used for the transportation of hazardous materials must conform to the requirements of its specification and regulations for the transportation of the particular commodity.

(b) *Initial use and reuse of Flexible Bulk Containers.* A Flexible Bulk Container may be reused. Before a Flexible Bulk Container is filled and offered for transportation, the Flexible Bulk Container must be given an external visual inspection by the person filling the Flexible Bulk Container to ensure:

(1) The Flexible Bulk Container is free from corrosion, contamination, cracks, cuts, or other damage that would render it unable to pass the prescribed design type test to which it is certified and marked; and

(2) The Flexible Bulk Container is marked in accordance with requirements in §178.1010 of this subchapter. Required markings that are missing, damaged or difficult to read must be restored or returned to original condition.

(3) The following components must be examined to determine structural serviceability:

(i) Textile slings;

(ii) Load-bearing structure straps;

(iii) Body fabric; and

(iv) Lock device parts including metal and textile parts are free from protrusions or damage.

(4) The use of Flexible Bulk Containers for the transport of hazardous materials is permitted for a period not to exceed two years from the date of manufacture of the Flexible Bulk Container.

(c) During transportation—

(1) No hazardous material may remain on the outside of the Flexible Bulk Container; and

(2) Each Flexible Bulk Container must be securely fastened to or contained within the transport unit.

(3) If restraints such as banding or straps are used, these straps must not be over-tightened to an extent that causes damage or deformation to the Flexible Bulk Container.

(4) Flexible Bulk Containers must be transported in a conveyance with rigid sides and ends that extend at least two-thirds of the height of the Flexible Bulk Container.

(5) Flexible Bulk Containers must not be stacked for highway or rail transportation.

(6) Flexible Bulk Containers must not be transported in cargo transport units when offered for transportation by vessel.

(7) Flexible Bulk Containers when transported by barge must be stowed in such a way that there are no void spaces between the Flexible Bulk Containers in the barge. If the Flexible Bulk Containers do not completely fill the barge, adequate measures must be taken to avoid shifting of cargo. The maximum permissible height of the stack of Flexible Bulk Containers must not exceed 3 containers high.

(d) A Flexible Bulk Container used to transport hazardous materials may not

exceed 15 cubic meters (530 cubic feet) capacity.

[78 FR 1073, Jan. 7, 2013]

§ 173.40 General packaging requirements for toxic materials packaged in cylinders.

When this section is referenced for a Hazard Zone A or B hazardous material elsewhere in this subchapter, the requirements in this section are applicable to cylinders used for that material.

(a) *Authorized cylinders.* (1) A cylinder must conform to a DOT specification or a UN standard prescribed in subpart C of part 178 of this subchapter, except that acetylene cylinders and non-refillable cylinders are not authorized. The use of UN tubes and MEGCs is prohibited for Hazard Zone A materials.

(2) The use of a specification 3AL cylinder made of aluminum alloy 6351-T6 is prohibited for a Division 2.3 Hazard Zone A material or a Division 6.1 Hazard Zone A material.

(3) A UN composite cylinder certified to ISO-11119-3 is not authorized for a Division 2.3 Hazard Zone A or B material.

(4) For UN seamless cylinders used for Hazard Zone A materials, the maximum water capacity is 85 L.

(b) *Outage and pressure requirements.* For DOT specification cylinders, the pressure at 55 °C (131 °F) of Hazard Zone A and Hazard Zone B materials may not exceed the service pressure of the cylinder. Sufficient outage must be provided so that the cylinder will not be liquid full at 55 °C (131 °F).

(c) *Closures.* Each cylinder containing a Hazard Zone A material must be closed with a plug or valve conforming to the following:

(1) Each plug or valve must have a taper-threaded connection directly to the cylinder and be capable of withstanding the test pressure of the cylinder without damage or leakage. For UN pressure receptacles, each valve must be capable of withstanding the test pressure of the pressure receptacle and be connected directly to the pressure receptacle by either a taper thread or other means which meets the requirements of ISO 10692-2: (IBR, see §171.7 of this subchapter).

(2) Each valve must be of the packless type with non-perforated dia-

phragm, except that, for corrosive materials, a valve may be of the packed type with an assembly made gas-tight by means of a seal cap with gasketed joint attached to the valve body or the cylinder to prevent loss of material through or past the packing.

(3) Each valve outlet must be sealed by a threaded cap or threaded solid plug and inert gasketing material.

(4) The materials of construction for the cylinder, valves, plugs, outlet caps, luting, and gaskets must be compatible with each other and with the lading.

(d) *Additional handling protection.* Each cylinder or cylinder overpack combination offered for transportation containing a Division 2.3 or 6.1 Hazard Zone A or B material must conform to the valve damage protection performance requirements of this section. In addition to the requirements of this section, overpacks must conform to the overpack provisions of §173.25.

(1) DOT specification cylinders must conform to the following:

(i) Each cylinder with a wall thickness at any point of less than 2.03 mm (0.08 inch) and each cylinder that does not have fitted valve protection must be overpacked in a box. The box must conform to overpack provisions in §173.25. Box and valve protection must be of sufficient strength to protect all parts of the cylinder and valve, if any, from deformation and breakage resulting from a drop of 2.0 m (7 ft) or more onto a non-yielding surface, such as concrete or steel, impacting at an orientation most likely to cause damage. "Deformation" means a cylinder or valve that is bent, distorted, mangled, misshapen, twisted, warped, or in a similar condition.

(ii) Each cylinder with a valve must be equipped with a protective metal cap, other valve protection device, or an overpack which is sufficient to protect the valve from breakage or leakage resulting from a drop of 2.0 m (7 ft) onto a non-yielding surface, such as concrete or steel. Impact must be at an orientation most likely to cause damage.

(2) Each UN cylinder containing a Hazard Zone A or Hazard Zone B material must have a minimum test pressure in accordance with P200 of the UN Recommendations (IBR, see §171.7 of

§ 173.50

this subchapter). For Hazard Zone A gases, the cylinder must have a minimum wall thickness of 3.5 mm if made of aluminum alloy or 2 mm if made of steel or, alternatively, cylinders may be packed in a rigid outer packaging that meets the Packing Group I performance level when tested as prepared for transport, and that is designed and constructed to protect the cylinder and valve from puncture or damage that may result in release of the gas.

(e) *Interconnection*. Cylinders may not be manifolded or connected. This provision does not apply to MEGCs containing Hazard Zone B materials in accordance with § 173.312.

[67 FR 51642, Aug. 8, 2002, as amended at 67 FR 61289, Sept. 30, 2002; 68 FR 24660, May 8, 2003; 71 FR 33880, June 12, 2006; 76 FR 3371, Jan. 19, 2011]

Subpart C—Definitions, Classification and Packaging for Class 1

SOURCE: Amdt. 173–224, 55 FR 52617, Dec. 21, 1990, unless otherwise noted.

§ 173.50 Class 1—Definitions.

(a) *Explosive*. For the purposes of this subchapter, an *explosive* means any substance or article, including a device, which is designed to function by explosion (*i.e.*, an extremely rapid release of gas and heat) or which, by chemical reaction within itself, is able to function in a similar manner even if not designed to function by explosion, unless the substance or article is otherwise classed under the provisions of this subchapter. The term includes a pyrotechnic substance or article, unless the substance or article is otherwise classed under the provisions of this subchapter.

(b) Explosives in Class 1 are divided into six divisions as follows:

(1) *Division 1.1* consists of explosives that have a mass explosion hazard. A mass explosion is one which affects almost the entire load instantaneously.

(2) *Division 1.2* consists of explosives that have a projection hazard but not a mass explosion hazard.

(3) *Division 1.3* consists of explosives that have a fire hazard and either a minor blast hazard or a minor projec-

49 CFR Ch. I (10–1–14 Edition)

tion hazard or both, but not a mass explosion hazard.

(4) *Division 1.4* consists of explosives that present a minor explosion hazard. The explosive effects are largely confined to the package and no projection of fragments of appreciable size or range is to be expected. An external fire must not cause virtually instantaneous explosion of almost the entire contents of the package.

(5) *Division 1.5*¹ consists of very insensitive explosives. This division is comprised of substances which have a mass explosion hazard but are so insensitive that there is very little probability of initiation or of transition from burning to detonation under normal conditions of transport.

(6) *Division 1.6*² consists of extremely insensitive articles that do not have a mass explosion hazard. This division is comprised of articles that contain only extremely insensitive substances and that demonstrate a negligible probability of accidental initiation or propagation.

[Amdt. 173–224, 55 FR 52617 Dec. 21, 1990, as amended at 56 FR 66267, Dec. 20, 1991; 66 FR 45183, Aug. 28, 2001; 68 FR 48569, Aug. 14, 2003; 78 FR 1074, Jan. 7, 2013]

§ 173.51 Authorization to offer and transport explosives.

(a) Unless otherwise provided in this subpart, no person may offer for transportation or transport an explosive, unless it has been tested and classed and approved by the Associate Administrator (§ 173.56).

(b) Reports of explosives approved by the Department of Defense or the Department of Energy must be filed with, and receive acknowledgement in writing by, the Associate Administrator prior to such explosives being offered for transportation.

[Amdt. 173–224, 55 FR 52617, Dec. 21, 1990, as amended by 66 FR 45379, Aug. 28, 2001]

¹The probability of transition from burning to detonation is greater when large quantities are transported in a vessel.

²The risk from articles of Division 1.6 is limited to the explosion of a single article.

§ 173.52 Classification codes and compatibility groups of explosives.

(a) The classification code for an explosive, which is assigned by the Associate Administrator in accordance with this subpart, consists of the division number followed by the compatibility group letter. Compatibility group letters are used to specify the controls for the transportation, and storage related thereto, of explosives and to prevent an increase in hazard that might result if certain types of explosives were stored or transported together. Transportation compatibility requirements for

carriers are prescribed in §§174.81, 175.78, 176.83 and 177.848 of this subchapter for transportation by rail, air, vessel, and public highway, respectively, and storage incidental thereto.

(b) Compatibility groups and classification codes for the various types of explosives are set forth in the following tables. Table 1 sets forth compatibility groups and classification codes for substances and articles described in the first column of table 1. Table 2 shows the number of classification codes that are possible within each explosive division. Altogether, there are 35 possible classification codes for explosives.

TABLE 1—CLASSIFICATION CODES

Description of substances or article to be classified	Compat- ibility group	Classi- fication code
Primary explosive substance	A	1.1A
Article containing a primary explosive substance and not containing two or more effective protective features. Some articles, such as detonators for blasting, detonator assemblies for blasting and primers, cap-type, are included, even though they do not contain primary explosives..	B	1.1B 1.2B 1.4B
Propellant explosive substance or other deflagrating explosive substance or article containing such explosive substance.	C	1.1C 1.2C 1.3C 1.4C
Secondary detonating explosive substance or black powder or article containing a secondary detonating explosive substance, in each case without means of initiation and without a propelling charge, or article containing a primary explosive substance and containing two or more effective protective features.	D	1.1D 1.2D 1.4D 1.5D
Article containing a secondary detonating explosive substance, without means of initiation, with a propelling charge (other than one containing flammable liquid or gel or hypergolic liquid).	E	1.1E 1.2E 1.4E
Article containing a secondary detonating explosive substance with its means of initiation, with a propelling charge (other than one containing flammable liquid or gel or hypergolic liquid) or without a propelling charge.	F	1.1F 1.2F 1.3F 1.4F
Pyrotechnic substance or article containing a pyrotechnic substance, or article containing both an explosive substance and an illuminating, incendiary, tear-producing or smoke-producing substance (other than a water-activated article or one containing white phosphorus, phosphide or flammable liquid or gel or hypergolic liquid).	G	1.1G 1.2G 1.3G 1.4G
Article containing both an explosive substance and white phosphorus	H	1.2H 1.3H
Article containing both an explosive substance and flammable liquid or gel	J	1.1J 1.2J 1.3J
Article containing both an explosive substance and a toxic chemical agent	K	1.2K 1.3K
Explosive substance or article containing an explosive substance and presenting a special risk (e.g., due to water-activation or presence of hypergolic liquids, phosphides or pyrophoric substances) needing isolation of each type.	L	1.1L 1.2L 1.3L
Articles containing only extremely insensitive substances	N	1.6N
Substance or article so packed or designed that any hazardous effects arising from accidental functioning are limited to the extent that they do not significantly hinder or prohibit fire fighting or other emergency response efforts in the immediate vicinity of the package.	S	1.4S

TABLE 2—SCHEME OF CLASSIFICATION OF EXPLOSIVES, COMBINATION OF HAZARD DIVISION WITH COMPATIBILITY GROUP

Hazard division	Compatibility group														A-S
	A	B	C	D	E	F	G	H	J	K	L	N	S		
1.1	1.1A	1.1B	1.1C	1.1D	1.1E	1.1F	1.1G		1.1J		1.1L				9
1.2		1.2B	1.2C	1.2D	1.2E	1.2F	1.2G	1.2H	1.2J	1.2K	1.2L				10
1.3			1.3C			1.3F	1.3G	1.3H	1.3J	1.3K	1.3L				7

TABLE 2—SCHEME OF CLASSIFICATION OF EXPLOSIVES, COMBINATION OF HAZARD DIVISION WITH COMPATIBILITY GROUP—Continued

Hazard division	Compatibility group													
	A	B	C	D	E	F	G	H	J	K	L	N	S	A-S
1.4		1.4B	1.4C	1.4D	1.4E	1.4F	1.4G						1.4S	7
1.5				1.5D										1
1.6												1.6N		1
Total	1	3	4	4	3	4	4	2	3	2	3	1	1	35

[Amdt. 173–224, 55 FR 52617, Dec. 21, 1990, as amended by Amdt. 173–241, 59 FR 67492, Dec. 29, 1994; 64 FR 51918, Sept. 27, 1999; 66 FR 45379, Aug. 28, 2001; 76 FR 56315, Sept. 13, 2011; 78 FR 1074, Jan. 7, 2013]

§ 173.53 Provisions for using old classifications of explosives.

Where the classification system in effect prior to January 1, 1991, is referenced in State or local laws, ordinances or regulations not pertaining to the transportation of hazardous materials, the following table may be used to compare old and new hazard class names:

Current classification	Class name prior to Jan. 1, 1991
Division 1.1	Class A explosives.
Division 1.2	Class A or Class B explosives.
Division 1.3	Class B explosive.
Division 1.4	Class C explosives.
Division 1.5	Blasting agents.
Division 1.6	No applicable hazard class.

§ 173.54 Forbidden explosives.

Unless otherwise provided in this subchapter, the following explosives shall not be offered for transportation or transported:

- (a) An explosive that has not been approved in accordance with §173.56 of this subpart.
- (b) An explosive mixture or device containing a chlorate and also containing:
 - (1) An ammonium salt, including a substituted ammonium or quaternary ammonium salt; or
 - (2) An acidic substance, including a salt of a weak base and a strong acid.
- (c) A leaking or damaged package or article containing an explosive.
- (d) Propellants that are unstable, condemned or deteriorated.
- (e) Nitroglycerin, diethylene glycol dinitrate, or any other liquid explosives not specifically authorized by this subchapter.

(f) A loaded firearm (except as provided in 49 CFR 1544.219).

(g) Fireworks that combine an explosive and a detonator.

(h) Fireworks containing yellow or white phosphorus.

(i) A toy torpedo, the maximum outside dimension of which exceeds 23 mm (0.906 inch), or a toy torpedo containing a mixture of potassium chlorate, black antimony (antimony sulfide), and sulfur, if the weight of the explosive material in the device exceeds 0.26 g (0.01 ounce).

(j) Explosives specifically forbidden in the §172.101 table of this subchapter.

(k) Explosives not meeting the acceptance criteria specified in §173.57 of this subchapter.

(l) An explosive article with its means of initiation or ignition installed, unless approved in accordance with §173.56.

[Amdt. 173–224, 55 FR 52617 Dec. 21, 1990, as amended at 56 FR 66267, Dec. 20, 1991; Amdt. 173–236, 58 FR 50236, Sept. 24, 1993; 67 FR 61013, Sept. 27, 2002; 68 FR 48569, Aug. 14, 2003]

§ 173.55 [Reserved]

§ 173.56 New explosives—definition and procedures for classification and approval.

(a) Definition of new explosive. For the purposes of this subchapter a *new explosive* means an explosive produced by a person who:

- (1) Has not previously produced that explosive; or
- (2) Has previously produced that explosive but has made a change in the formulation, design or process so as to

alter any of the properties of the explosive. An explosive will not be considered a “new explosive” if an agency listed in paragraph (b) of this section has determined, and confirmed in writing to the Associate Administrator, that there are no significant differences in hazard characteristics from the explosive previously approved.

(b) Examination, classification and approval. Except as provided in §§173.64 and 173.65, no person may offer a new explosive for transportation unless that person has specified to the examining agency the ranges of composition of ingredients and compounds, showing the intended manufacturing tolerances in the composition of substances or design of articles which will be allowed in that material or device, and unless it has been examined, classed and approved as follows:

(1) Except for an explosive made by or under the direction or supervision of the Department of Defense (DOD) or the Department of Energy (DOE), a new explosive must be examined and assigned a recommended shipping description, division and compatibility group, based on the tests and criteria prescribed in §§173.52, 173.57 and 173.58. The person requesting approval of the new explosive must submit to the Associate Administrator a report of the examination and assignment of a recommended shipping description, division, and compatibility group. If the Associate Administrator finds the approval request meets the regulatory criteria, the new explosive will be approved in writing and assigned an EX number. The examination must be performed by a person who is approved by the Associate Administrator under the provisions of subpart H of part 107 of this chapter and who—

(i) Has (directly, or through an employee involved in the examination) at least ten years of experience in the examination, testing and evaluation of explosives;

(ii) Does not manufacture or market explosives, and is not controlled by or financially dependent on any entity that manufactures or markets explosives, and whose work with respect to explosives is limited to examination, testing and evaluation; and

(iii) Is a resident of the United States.

(2) A new explosive made by or under the direction or supervision of a component of the DOD may be examined, classed, and concurred in by:

(i) U.S. Army Technical Center for Explosives Safety (SMCAC-EST), Naval Sea Systems Command (SEA-9934), or Air Force Safety Agency (SEW), when approved by the Chairman, DOD Explosives Board, in accordance with the DOD Explosives Hazard Classification Procedures (IBR, see §171.7 of the subchapter); or

(ii) The agencies and procedures specified in paragraph (b)(1) of this section.

(3) A new explosive made by or under the direction or supervision of the Department of Energy (DOE) may be—

(i) Examined by the DOE in accordance with the DOD Explosives Hazard Classification Procedures, and must be classed and approved by DOE; or

(ii) Examined, classed, and approved in accordance with paragraph (b)(1) of this section.

(4) For a material shipped under the description of “ammonium nitrate-fuel oil mixture (ANFO)”, the only test required for classification purposes is the Cap Sensitivity Test—Test Method 5(a) prescribed in the Explosive Test Manual (UN Manual of Tests and Criteria) (IBR, see §171.7 of the subchapter). The test must be performed by an agency listed in paragraph (b)(1), (b)(2), or (b)(3) of this section, the manufacturer, or the shipper. A copy of the test report must be submitted to the Associate Administrator before the material is offered for transportation, and a copy of the test report must be retained by the shipper for as long as that material is shipped. At a minimum, the test report must contain the name and address of the person or organization conducting the test, date of the test, quantitative description of the mixture, including prill size and porosity, and a description of the test results.

(c) Filing DOD or DOE approval report. DOD or DOE must file a copy of

each approval, accompanied by supporting laboratory data, with the Associate Administrator and receive acknowledgement in writing before offering the new explosive for transportation, unless the new explosive is:

(1) Being transported under paragraph (d) or (e) of this section; or

(2) Covered by a national security classification currently in effect.

(d) Transportation of explosive samples for examination. Notwithstanding the requirements of paragraph (b) of this section with regard to the transportation of a new explosive that has not been approved, a person may offer a sample of a new explosive for transportation, by railroad, highway, or vessel from the place where it was produced to an agency identified in paragraph (b) of this section, for examination if—

(1) The new explosive has been assigned a tentative shipping description and class in writing by the testing agency;

(2) The new explosive is packaged as required by this part according to the tentative description and class assigned, unless otherwise specified in writing by the testing agency; and,

(3) The package is labeled as required by this subchapter and the following is marked on the package:

(i) The words “SAMPLE FOR LABORATORY EXAMINATION”;

(ii) The net weight of the new explosive; and

(iii) The tentative shipping name and identification number.

(e) Transportation of unapproved explosives for developmental testing. Notwithstanding the requirements of paragraph (b) of this section, the owner of a new explosive that has not been examined or approved may transport that new explosive from the place where it was produced to an explosives testing range if—

(1) It is not a primary (a 1.1A initiating) explosive or a forbidden explosive according to this subchapter;

(2) It is described as a Division 1.1 explosive (substance or article) and is packed, marked, labeled, described on shipping papers and is otherwise offered for transportation in conformance with the requirements of this subchapter applicable to Division 1.1;

(3) It is transported in a motor vehicle operated by the owner of the explosive; and

(4) It is accompanied by a person, in addition to the operator of the motor vehicle, who is qualified by training and experience to handle the explosive.

(f) Notwithstanding the requirements of paragraphs (b) and (d) of this section, the Associate Administrator may approve a new explosive on the basis of an approval issued for the explosive by the competent authority of a foreign government, or when examination of the explosive by a person approved by the Associate Administrator is impracticable, on the basis of reports of tests conducted by disinterested third parties, or may approve the transportation of an explosives sample for the purpose of examination by a person approved by the Associate Administrator.

(g) An explosive may be transported under subparts B or C of part 171 or §176.11 of this subchapter without the approval of the Associate Administrator as required by paragraph (b) of this section if the Associate Administrator has acknowledged in writing the acceptability of an approval issued by the competent authority of a foreign government pursuant to the provisions of the UN Recommendations, the ICAO Technical Instructions, the IMDG Code (IBR, see §171.7 of this subchapter), or other national or international regulations based on the UN Recommendations. In such a case, a copy of the foreign competent authority approval, and a copy of the written acknowledgement of its acceptance must accompany each shipment of that explosive.

(h) The requirements of this section do not apply to cartridges, small arms which are:

(1) Not a forbidden explosive under §173.54 of this subchapter;

(2) Ammunition for rifle, pistol, shotgun, or tools;

(3) Ammunition with inert projectile or blank ammunition; and

(4) Ammunition not exceeding 50 caliber for rifle or pistol cartridges or 8 gauge for shotgun shells.

Cartridges, small arms meeting the criteria of this paragraph (h) may be assigned a classification code of 1.4S by the manufacturer.

(i) If experience or other data indicate that the hazard of a material or a device containing an explosive composition is greater or less than indicated according to the definition and criteria specified in §§173.50, 173.56, and 173.58 of this subchapter, the Associate Administrator may specify a classification or except the material or device from the requirements of this subchapter.

(j) [Reserved]

[Amdt. 173-224, 55 FR 52617 Dec. 21, 1990, as amended at 56 FR 66267, Dec. 20, 1991; Amdt. 173-234, 58 FR 51532, Oct. 1, 1993; 62 FR 51560, Oct. 1, 1997; 63 FR 37461, July 10, 1998; 64 FR 10777, Mar. 5, 1999; 66 FR 45379, Aug. 28, 2001; 68 FR 75743, Dec. 31, 2003; 72 FR 25177, May 3, 2007; 78 FR 1074, Jan. 7, 2013; 78 FR 42477, July 16, 2013]

§ 173.57 Acceptance criteria for new explosives.

(a) Unless otherwise excepted, an explosive substance must be subjected to the Drop Weight Impact Sensitivity Test (Test Method 3(a)(i)), the Friction Sensitivity Test (Test Method 3(b)(iii)), the Thermal Stability Test (Test Method 3(c)) at 75 °C (167 °F) and the Small-Scale Burning Test (Test Method 3(d)(i)), each as described in the Explosive Test Manual (UN Manual of Tests and Criteria) (IBR, see §171.7 of this subchapter). A substance is forbidden for transportation if any one of the following occurs:

(1) For a liquid, failure to pass the test criteria when tested in the Drop Weight Impact Sensitivity Test apparatus for liquids;

(2) For a solid, failure to pass the test criteria when tested in the Drop Weight Impact Sensitivity Test apparatus for solids;

(3) The substance has a friction sensitiveness equal to or greater than that of dry pentaerythrite tetranitrate (PETN) when tested in the Friction Sensitivity Test;

(4) The substance fails to pass the test criteria specified in the Thermal Stability Test at 75 °C (167 °F); or

(5) Explosion occurs when tested in the Small-Scale Burning Test.

(b) An explosive article, packaged or unpackaged, or a packaged explosive substance must be subjected to the Thermal Stability Test for Articles and Packaged Articles (Test method 4(a)(i))

and the Twelve Meter Drop Test (Test Method 4(b)(ii)), when appropriate, in the Explosive Test Manual. An article or packaged substance is forbidden for transportation if evidence of thermal instability or excessive impact sensitivity is found in those tests according to the criteria and methods of assessing results prescribed therein.

(c) Dynamite (explosive, blasting, type A) is forbidden for transportation if any of the following occurs:

(1) It does not have, when uniformly mixed with the absorbent material, a satisfactory antacid in a quantity sufficient to have the acid neutralizing power of an amount of magnesium carbonate equal to one percent of the nitroglycerin or other liquid explosive ingredient;

(2) During the centrifuge test (Test Method D-2, in appendix D to this part) or the compression test (Test Method D-3 in appendix D to this part), a non-gelatin dynamite loses more than 3 percent by weight of the liquid explosive or a gelatin dynamite loses more than 10 percent by weight of the liquid explosive; or

(3) During the leakage test (Test Method D-1 in appendix D to this part), there is any loss of liquid.

[Amdt. 173-224, 55 FR 52617 Dec. 21, 1990, as amended at 58 FR 51532, Oct. 1, 1993; 64 FR 51918, Sept. 27, 1999; 68 FR 75743, Dec. 31, 2003; 76 FR 56315, Sept. 13, 2011]

§ 173.58 Assignment of class and division for new explosives.

(a) *Division 1.1, 1.2, 1.3, and 1.4 explosives.* In addition to the test prescribed in §173.57 of this subchapter, a substance or article in these divisions must be subjected to Test Methods 6(a), 6(b), and 6(c), as described in the UN Manual of Tests and Criteria (IBR, see §171.7 of this subchapter), for assignment to an appropriate division. The criteria for assignment of class and division are as follows:

(1) Division 1.1 if the major hazard is mass explosion;

(2) Division 1.2 if the major hazard is dangerous projections;

(3) Division 1.3 if the major hazard is radiant heat or violent burning, or both, but there is no blast or projection hazard;

(4) Division 1.4 if there is a small hazard with no mass explosion and no projection of fragments of appreciable size or range;

(5) Division 1.4 Compatibility Group S (1.4S) if the hazardous effects are confined within the package or the blast and projection effects do not significantly hinder emergency response efforts. The UN Test Type 6(d) is used to determine whether a Division 1.4S classification is appropriate for an item assigned a proper shipping name to which special provision 347 (see §172.102 of this subchapter) applies; or

(6) Not in the explosive class if the substance or article does not have significant explosive hazard or if the effects of explosion are completely confined within the article.

(b) *Division 1.5 explosive.* Except for ANFO, a substance that has been examined in accordance with the provisions §173.57(a) of this subchapter, must be subjected to the following additional tests: Cap Sensitivity Test, Princess Incendiary Spark Test, DDT Test, and External Fire Test, each as described in the Explosive Test Manual. A material may not be classed as a Division 1.5 explosive if any of the following occurs:

(1) Detonation occurs in the Cap Sensitivity Test (Test Method 5(a));

(2) Detonation occurs in the DDT Test (Test Method 5(b)(ii));

(3) An explosion, evidenced by a loud noise and projection of fragments, occurs in the External Fire Test (Test Method 5(c), or

(4) Ignition or explosion occurs in the Princess Incendiary Spark Test (Test Method 5(d)).

(c) Division 1.6 explosive. (1) In order to be classed as a 1.6 explosive, an article must pass all of the following tests, as prescribed in the Explosive Test Manual:

(i) The 1.6 Article External Fire Test;

(ii) The 1.6 Article Slow Cook-off Test;

(iii) The 1.6 Article Propagation Test; and

(iv) The 1.6 Article Bullet Impact Test.

(2) A substance intended for use as the explosive load in an article of Division 1.6 must be an extremely insensitive detonating substance (EIDS). In

order to determine if a substance is an EIDS, it must be subjected to the tests in paragraphs (c)(2)(i) through (c)(2)(x) of this section, which are described in the Explosive Test Manual. The substance must be tested in the form (i.e., composition, granulation, density, etc.) in which it is to be used in the article. A substance is not an EIDS if it fails any of the following tests:

(i) The Drop Weight Impact Sensitivity Test;

(ii) The Friction Sensitivity Test;

(iii) The Thermal Sensitivity Test at 75 °C (167 °F);

(iv) The Small Scale Burning Test;

(v) The EIDS Cap Test;

(vi) The EIDS Gap Test;

(vii) The Susan Test;

(viii) The EIDS Bullet Impact Test;

(ix) The EIDS External Fire Test; and

(x) The EIDS Slow Cook-off Test.

(d) The Associate Administrator may waive or modify certain test(s) identified in §§173.57 and 173.58 of this subchapter, or require additional testing, if appropriate. In addition, the Associate Administrator may limit the quantity of explosive in a device.

(e) Each explosive is assigned a compatibility group letter by the Associate Administrator based on the criteria prescribed in §173.52(b) of this subchapter.

[Amdt. 173–224, 55 FR 52617 Dec. 21, 1990, as amended at 56 FR 66267, Dec. 20, 1991; 63 FR 52849, Oct. 1, 1998; 66 FR 45379, Aug. 28, 2001; 68 FR 75743, Dec. 31, 2003; 76 FR 3371, Jan. 19, 2011; 76 FR 56315, Sept. 13, 2011]

§ 173.59 Description of terms for explosives.

For the purpose of this subchapter, a description of the following terms is provided for information only. They must not be used for purposes of classification or to replace proper shipping names prescribed in §172.101 of this subchapter.

Ammonium-nitrate—fuel oil mixture (ANFO). A blasting explosive containing no essential ingredients other than prilled ammonium nitrate and fuel oil.

Ammunition. Generic term related mainly to articles of military application consisting of all types of bombs, grenades, rockets, mines, projectiles

and other similar devices or contrivances.

Ammunition, illuminating, with or without burster, expelling charge or propelling charge. Ammunition designed to produce a single source of intense light for lighting up an area. The term includes illuminating cartridges, grenades and projectiles, and illuminating and target identification bombs. The term excludes the following articles which are listed separately: *cartridges, signal; signal devices; hand signals; distress flares, aerial and flares, surface.*

Ammunition, incendiary. Ammunition containing an incendiary substance which may be a solid, liquid or gel including white phosphorus. Except when the composition is an explosive *per se*, it also contains one or more of the following: a propelling charge with primer and igniter charge, or a fuze with burster or expelling charge. The term includes: *Ammunition, incendiary, liquid or gel, with burster, expelling charge or propelling charge; Ammunition, incendiary with or without burster, expelling charge or propelling charge; and Ammunition, incendiary, white phosphorus, with burster, expelling charge or propelling charge.*

Ammunition, practice. Ammunition without a main bursting charge, containing a burster or expelling charge. Normally it also contains a fuze and propelling charge. The term excludes the following article which is listed separately: *Grenades, practice.*

Ammunition, proof. Ammunition containing pyrotechnic substance, used to test the performance or strength of new ammunition, weapon component or assemblies.

Ammunition, smoke. Ammunition containing a smoke-producing substance such as chlorosulphonic acid mixture (CSAM), titanium tetrachloride (FM), white phosphorus, or smoke-producing substance whose composition is based on hexachlorothannol (HC) or red phosphorus. Except when the substance is an explosive *per se*, the ammunition also contains one or more of the following: a propelling charge with primer and igniter charge, or a fuze with burster or expelling charge. The term includes: *Ammunition, smoke, with or without burster, expelling charge or propelling charge; Ammunition, smoke,*

white phosphorus with burster, expelling charge or propelling charge.

Ammunition, tear-producing with burster, expelling charge or propelling charge. Ammunition containing tear-producing substance. It may also contain one or more of the following: a pyrotechnic substance, a propelling charge with primer and igniter charge, or a fuze with burster or expelling charge.

Ammunition, toxic. Ammunition containing toxic agent. It may also contain one or more of the following: a pyrotechnic substance, a propelling charge with primer and igniter charge, or a fuze with burster or expelling charge.

Articles, explosive, extremely insensitive (Articles, EEI). Articles that contain only extremely insensitive substances and which demonstrate a negligible probability of accidental initiation or propagation under normal conditions of transport and which have passed Test Series 7.

Articles, pyrophoric. Articles which contain a pyrophoric substance (capable of spontaneous ignition when exposed to air) and an explosive substance or component. The term excludes articles containing white phosphorus.

Articles, pyrotechnic for technical purposes. Articles which contain pyrotechnic substances and are used for technical purposes, such as heat generation, gas generation, theatrical effects, etc. The term excludes the following articles which are listed separately: all ammunition; *cartridges, signal; cutters, cable, explosive; fireworks; flares, aerial; flares, surface; release devices, explosives; rivets, explosive; signal devices, hand; signals, distress; signals, railway track, explosive; and signals, smoke.*

Auxiliary explosive component, isolated. A small device that explosively performs an operation related to the article's functioning, other than its main explosive loads' performance. Functioning of the component does not cause any reaction of the main explosive loads contained within the article.

Black powder (gunpowder). Substance consisting of an intimate mixture of

charcoal or other carbon and either potassium or sodium nitrate, and sulphur. It may be meal, granular, compressed, or pelletized.

Bombs. Explosive articles which are dropped from aircraft. They may contain a flammable liquid with bursting charge, a photo-flash composition or bursting charge. The term excludes *torpedoes* (aerial) and includes *bombs*, *photo-flash*; *bombs* with bursting charge; *bombs with flammable liquids*, with bursting charge.

Boosters. Articles consisting of a charge of detonating explosive without means of initiation. They are used to increase the initiating power of detonators or detonating cord.

Bursters, explosive. Articles consisting of a small charge of explosive to open projectiles or other ammunition in order to disperse their contents.

Cartridges, blank. Articles that consist of a cartridge case with a center or rim fire primer and a confined charge of smokeless or black powder, but no projectile. Used in training, saluting, or in starter pistols, tools, etc.

Cartridges, flash. Articles consisting of a casing, a primer and flash powder, all assembled in one piece for firing.

Cartridges for weapons. (1) Fixed (assembled) or semi-fixed (partially assembled) ammunition designed to be fired from weapons. Each cartridge includes all the components necessary to function the weapon once. The name and description should be used for military small arms cartridges that cannot be described as cartridges, small arms. Separate loading ammunition is included under this name and description when the propelling charge and projectile are packed together (see also Cartridges, blank).

(2) Incendiary, smoke, toxic, and tear-producing cartridges are described under *ammunition, incendiary*, etc.

Cartridges for weapons, inert projectile. Ammunition consisting of a casing with propelling charge and a solid or empty projectile.

Cartridges, oil well. Articles consisting of a casing of thin fiber, metal or other material containing only propellant explosive. The term excludes charges, shaped, commercial.

Cartridges, power device. Articles designed to accomplish mechanical ac-

tions. They consist of a casing with a charge of deflagrating explosive and a means of ignition. The gaseous products of the deflagration produce inflation, linear or rotary motion; activate diaphragms, valves or switches, or project fastening devices or extinguishing agents.

Cartridges, signal. Articles designed to fire colored flares or other signals from signal pistols or devices.

Cartridges, small arms. Ammunition consisting of a cartridge case fitted with a center or rim fire primer and containing both a propelling charge and solid projectile(s). They are designed to be fired in weapons of caliber not larger than 19.1 mm. Shotgun cartridges of any caliber are included in this description. The term excludes: Cartridges, small arms, blank, and some military small arms cartridges listed under *Cartridges for weapons, inert projectile*.

Cases, cartridge, empty with primer. Articles consisting of a cartridge case made from metal, plastics or other non-flammable materials, in which only the explosive component is the primer.

Cases, combustible, empty, without primer. Articles consisting of cartridge cases made partly or entirely from nitrocellulose.

Charges, bursting. Articles consisting of a charge of detonating explosive such as hexolite, octolite, or plastics-bonded explosive designed to produce effect by blast or fragmentation.

Charges, demolition. Articles consisting of a charge of detonating explosive in a casing of fiberboard, plastics, metal or other material. The term excludes articles identified as bombs, mines, etc.

Charges, depth. Articles consisting of a charge of detonating explosive contained in a drum or projectile. They are designed to detonate under water.

Charges, expelling. A charge of deflagrating explosive designed to eject the payload from the parent article without damage.

Charges, explosive, without detonator. Articles consisting of a charge of detonating explosive without means of initiation, used for explosive welding, joining, forming, and other processes.

Charges, propelling. Articles consisting of propellant charge in any physical form, with or without a casing, for use in cannon or for reducing drag for projectiles or as a component of rocket motors.

Charges, propelling for cannon. Articles consisting of a propellant charge in any physical form, with or without a casing, for use in a cannon.

Charges, shaped, without detonator. Articles consisting of a casing containing a charge of detonating explosive with a cavity lined with rigid material, without means of initiation. They are designed to produce a powerful, penetrating jet effect.

Charges, shaped, flexible, linear. Articles consisting of a V-shaped core of a detonating explosive clad by a flexible metal sheath.

Charges, supplementary, explosive. Articles consisting of a small removable booster used in the cavity of a projectile between the fuze and the bursting charge.

Components, explosive train, n.o.s. Articles containing an explosive designed to transmit a detonation or deflagration within an explosive train.

Consumer firework. Any finished firework device that is in a form intended for use by the public that complies with any limits and requirements of the APA Standard 87-1 (IBR, see §171.7 of this subchapter) and the construction, performance, chemical composition, and labeling requirements codified by the U.S. Consumer Product Safety Commission in 16 CFR parts 1500 and 1507. A consumer firework does not include firework devices, kits or components banned by the U.S. Consumer Product Safety Commission in 16 CFR 1500.17 (a)(8).

Contrivance, water-activated with burster, expelling charge or propelling charge. Articles whose functioning depends of physico-chemical reaction of their contents with water.

Cord, detonating, flexible. Articles consisting of a core of detonating explosive enclosed in spun fabric with plastics or other covering.

Cord (fuse) detonating, metal clad. Articles consisting of a core of detonating explosive clad by a soft metal tube with or without protective covering. When the core contains a sufficiently

small quantity of explosive, the words "mild effect" are added.

Cord igniter. Articles consisting of textile yarns covered with black powder or another fast-burning pyrotechnic composition and a flexible protective covering, or consisting of a core of black powder surrounded by a flexible woven fabric. It burns progressively along its length with an external flame and is used to transmit ignition from a device to a charge or primer.

Cutters, cable, explosive. Articles consisting of a knife-edged device which is driven by a small charge of deflagrating explosive into an anvil.

Detonator assemblies, non-electric, for blasting. Non-electric detonators assembled with and activated by such means as safety fuse, shock tube, flash tube, or detonating cord. They may be of instantaneous design or incorporate delay elements. Detonating relays incorporating detonating cord are included. Other detonating relays are included in Detonators, nonelectric.

Detonators. Articles consisting of a small metal or plastic tube containing explosives such as lead azide, PETN, or combinations of explosives. They are designed to start a detonation train. They may be constructed to detonate instantaneously, or may contain a delay element. They may contain no more than 10 g of total explosives weight, excluding ignition and delay charges, per unit. The term includes: detonators for ammunition; detonators for blasting, both electric and non-electric; and detonating relays without flexible detonating cord.

Dynamite. A detonating explosive containing a liquid explosive ingredient (generally nitroglycerin, similar organic nitrate esters, or both) that is uniformly mixed with an absorbent material, such as wood pulp, and usually contains materials such as nitrocellulose, sodium and ammonium nitrate.

Entire load and total contents. The phrase means such a substantial portion of the material explodes that the practical hazard should be assessed by assuming simultaneous explosion of the whole of the explosive content of the load or package.

Explode. The term indicates those explosive effects capable of endangering

life and property through blast, heat, and projection of missiles. It encompasses both deflagration and detonation.

Explosion of the total contents. The phrase is used in testing a single article or package or a small stack of articles or packages.

Explosive, blasting. Detonating explosive substances used in mining, construction, and similar tasks. Blasting explosives are assigned to one of five types. In addition to the ingredients listed below for each type, blasting explosives may also contain inert components, such as kieselguhr, and other minor ingredients, such as coloring agents and stabilizers.

Explosive, blasting, type A. Substances consisting of liquid organic nitrates, such as nitroglycerin, or a mixture of such ingredients with one or more of the following: nitrocellulose, ammonium nitrate or other inorganic nitrates, aromatic nitro-derivatives, or combustible materials, such as wood-meal and aluminum powder. Such explosives must be in powdery, gelatinous, plastic or elastic form. The term includes dynamite, blasting gelatine and gelatine dynamites.

Explosive, blasting, type B. Substances consisting of a mixture of ammonium nitrate or other inorganic nitrates with an explosive, such as trinitrotoluene, with or without other substances, such as wood-meal or aluminum powder, or a mixture of ammonium nitrate or other inorganic nitrates with other combustible substances which are not explosive ingredients. Such explosives may not contain nitroglycerin, similar liquid organic nitrates, or chlorates.

Explosive, blasting, type C. Substances consisting of a mixture of either potassium or sodium chlorate or potassium, sodium or ammonium perchlorate with organic nitro-derivatives or combustible materials, such as wood-meal or aluminum powder, or a hydrocarbon. Such explosives must not contain nitroglycerin or any similar liquid organic nitrate.

Explosive, blasting, type D. Substances consisting of a mixture of organic nitrate compounds and combustible materials, such as hydrocarbons and aluminum powder. Such explosives must

not contain nitroglycerin, any similar liquid organic nitrate, chlorate or ammonium-nitrate. The term generally includes plastic explosives.

Explosive, blasting, type E. Substances consisting of water as an essential ingredient and high proportions of ammonium nitrate or other oxidizer, some or all of which are in solution. The other constituents may include nitro-derivatives, such as trinitrotoluene, hydrocarbons or aluminum powder. The term includes: explosives, emulsion; explosives, slurry; and explosives, watergel.

Explosive, deflagrating. A substance, e.g., propellant, which reacts by deflagration rather than detonation when ignited and used in its normal manner.

Explosive, detonating. A substance which reacts by detonation rather than deflagration when initiated and used in its normal manner.

Explosive, extremely insensitive substance (EIS). A substance that has demonstrated through tests that it is so insensitive that there is very little probability of accidental initiation.

Explosive, primary. Explosive substance which is manufactured with a view to producing a practical effect by explosion, is very sensitive to heat, impact, or friction, and even in very small quantities, detonates. The major primary explosives are mercury fulminate, lead azide, and lead styphnate.

Explosive, secondary. An explosive substance which is relatively insensitive (when compared to primary explosives) and is usually initiated by primary explosives with or without the aid of boosters or supplementary charges. Such an explosive may react as a deflagrating or as a detonating explosive.

Fireworks. Pyrotechnic articles designed for entertainment.

Flares. Articles containing pyrotechnic substances which are designed to illuminate, identify, signal, or warn. The term includes: flares, aerial and flares, surface.

Flash powder. Pyrotechnic substance which, when ignited, produces an intense light.

Fracturing devices, explosive, for oil wells, without detonators. Articles consisting of a charge of detonating explosive contained in a casing without the

means of initiation. They are used to fracture the rock around a drill shaft to assist the flow of crude oil from the rock.

Fuse/Fuze. Although these two words have a common origin (French fusee, fusil) and are sometimes considered to be different spellings, it is useful to maintain the convention that fuse refers to a cord-like igniting device, whereas fuze refers to a device used in ammunition which incorporates mechanical, electrical, chemical, or hydrostatic components to initiate a train by deflagration or detonation.

Fuse, igniter. Articles consisting of a metal tube with a core of deflagrating explosives.

Fuse, instantaneous, non-detonating (Quickmatch). Article consisting of cotton yarns impregnated with fine black powder. It burns with an external flame and is used in ignition trains for fireworks, etc.

Fuse, safety. Article consisting of a core of fine-grained black powder surrounded by a flexible woven fabric with one or more protective outer coverings. When ignited, it burns at a predetermined rate without any explosive effect.

Fuzes. Articles designed to start a detonation or deflagration in ammunition. They incorporate mechanical, electrical, chemical, or hydrostatic components and generally protective features. The term includes: Fuzes, detonating; fuzes detonating with protective features; and fuzes igniting.

Grenades, hand or rifle. Articles which are designed to be thrown by hand or to be projected by rifle. The term includes: grenades, hand or rifle, with bursting charge; and grenades, practice, hand or rifle. The term excludes: grenades, smoke.

Igniters. Articles containing one or more explosive substance used to start deflagration of an explosive train. They may be actuated chemically, electrically, or mechanically. The term excludes: cord, igniter; fuse, igniter; fuse, instantaneous, non-detonating; fuze, igniting; lighters, fuse, instantaneous, non-detonating; fuzes, igniting; lighters, fuse; primers, cap type; and primers, tubular.

Initiation, means of. A general term used in connection with the method

employed to ignite a deflagrating train of explosive or pyrotechnic substances (for example: a primer for propelling charge, an igniter for a rocket motor or an igniting fuze).

Initiation, means of. (1) A device intended to cause the detonation of an explosive (for example: detonator, detonator for ammunition, or detonating fuze).

(2) The term *with its own means of initiation* means that the contrivance has its normal initiating device assembled to it and this device is considered to present a significant risk during transport but not one great enough to be unacceptable. The term does not apply, however, to a contrivance packed together with its means of initiation, provided the device is packaged so as to eliminate the risk of causing detonation of the contrivance in the event of functioning of the initiating device. The initiating device can even be assembled in the contrivance provided there are protective features ensuring that the device is very unlikely to cause detonation of the contrivance under conditions which are associated with transport.

(3) For the purposes of classification, any means of initiation without two effective protective features should be regarded as Compatibility Group B; an article with its own means of initiation, without two effective protective features, is Compatibility Group F. A means of initiation which itself possesses two effective protective features is Compatibility Group D, and an article with its own means of initiation which possesses two effective features is Compatibility Group D or E. A means of initiation, adjudged as having two effective protective features, must be approved by the Associate Administrator. A common and effective way of achieving the necessary degree of protection is to use a means of initiation which incorporates two or more independent safety features.

Jet perforating guns, charged, oil well, without detonator. Articles consisting of a steel tube or metallic strip, into which are inserted shaped charges connected by detonating cord, without means of initiation.

Lighters, fuse. Articles of various design actuated by friction, percussion,

or electricity and used to ignite safety fuse.

Mass explosion. Explosion which affects almost the entire load virtually instantaneously.

Mines. Articles consisting normally of metal or composition receptacles and bursting charge. They are designed to be operated by the passage of ships, vehicles, or personnel. The term includes Bangalore torpedoes.

Phlegmatized. The term means that a substance (or “phlegmatizer”) has been added to an explosive to enhance its safety in handling and transport. The phlegmatizer renders the explosive insensitive, or less sensitive, to the following actions: heat, shock, impact, percussion or friction. Typical phlegmatizing agents include, but are not limited to: wax, paper, water, polymers (such as chlorofluoropolymers), alcohol and oils (such as petroleum jelly and paraffin).

Powder cake (powder paste). Substance consisting of nitrocellulose impregnated with not more than 60 percent of nitroglycerin or other liquid organic nitrates or a mixture of these.

Powder, smokeless. Substance based on nitrocellulose used as propellant. The term includes propellants with a single base (nitrocellulose (NC) alone), those with a double base (such as NC and nitroglycerin (NG)) and those with a triple base (such as NC/NG/nitroguanidine). Cast pressed or bag-charges of smokeless powder are listed under *charges, propelling* and *charges, propelling for cannon*.

Primers, cap type. Articles consisting of a metal or plastic cap containing a small amount of primary explosive mixture that is readily ignited by impact. They serve as igniting elements in small arms cartridges and in percussion primers for propelling charges.

Primers, tubular. Articles consisting of a primer for ignition and an auxiliary charge of deflagrating explosive, such as black powder, used to ignite the propelling charge in a cartridge case for cannon, etc.

Projectiles. Articles, such as a shell or bullet, which are projected from a cannon or other artillery gun, rifle, or other small arm. They may be inert, with or without tracer, or may contain a burster, expelling charge or bursting

charge. The term includes: projectiles, inert, with tracer; projectiles, with burster or expelling charge; and projectiles, with bursting charge.

Propellant, liquid. Substances consisting of a deflagrating liquid explosive, used for propulsion.

Propellant, solid. Substances consisting of a deflagrating solid explosive, used for propulsion.

Propellants. Deflagrating explosives used for propulsion or for reducing the drag of projectiles.

Release devices, explosive. Articles consisting of a small charge of explosive with means of initiation. They sever rods or links to release equipment quickly.

Rocket motors. Articles consisting of a solid, liquid, or hypergolic propellant contained in a cylinder fitted with one or more nozzles. They are designed to propel a rocket or guided missile. The term includes: rocket motors; rocket motors with hypergolic liquids with or without an expelling charge; and rocket motors, liquid fuelled.

Rockets. Articles containing a rocket motor and a payload which may be an explosive warhead or other device. The term includes: guided missiles; rockets, line-throwing; rockets, liquid fuelled, with bursting charge; rockets, with bursting charge; rockets, with expelling charge; and rockets, with inert head.

Signals. Articles consisting of pyrotechnic substances designed to produce signals by means of sound, flame, or smoke or any combination thereof. The term includes: signal devices, hand; signals, distress ship; signals, railway track, explosive; signals, smoke.

Sounding devices, explosive. Articles consisting of a charge of detonating explosive. They are dropped from ships and function when they reach a predetermined depth or the sea bed.

Substance, explosive, very insensitive (Substance, EVI) N.O.S. Substances which present a mass explosive hazard but which are so insensitive that there is very little probability of initiation, or of transition from burning to detonation under normal conditions of transport and which have passed test series 5.

Torpedoes. Articles containing an explosive or non-explosive propulsion

system and designed to be propelled through water. They may contain an inert head or warhead. The term includes: torpedoes, liquid fuelled, with inert head; torpedoes, liquid fuelled, with or without bursting charge; and torpedoes, with bursting charge.

Tracers for ammunition. Sealed articles containing pyrotechnic substances, designed to reveal the trajectory of a projectile.

Warheads. Articles containing detonating explosives, designed to be fitted to a rocket, guided missile, or torpedo. They may contain a burster or expelling charge or bursting charge. The term includes: warhead rocket with bursting charge; and warheads, torpedo, with bursting charge.

[Amdt. 173-224, 55 FR 52617 Dec. 21, 1990, as amended at 56 FR 66267, Dec. 20, 1991; Amdt. 173-241, 59 FR 67492, Dec. 29, 1994; 64 FR 10777, Mar. 5, 1999; 66 FR 45379, Aug. 28, 2001; 76 FR 3371, Jan. 19, 2011; 78 FR 1074, Jan. 7, 2013; 78 FR 42477, July 16, 2013]

§ 173.60 General packaging requirements for explosives.

(a) Unless otherwise provided in this subpart and in §173.7(a), packaging used for Class 1 (explosives) materials must meet Packing Group II requirements. Each packaging used for an explosive must be capable of meeting the test requirements of subpart M of part 178 of this subchapter, at the specified level of performance, and the applicable general packaging requirements of paragraph (b) of this section.

(b) The general requirements for packaging of explosives are as follows:

(1) Nails, staples, and other closure devices, made of metal, having no protective covering may not penetrate to the inside of the outer packaging unless the inner packaging adequately protects the explosive against contact with the metal.

(2) The closure device of containers for liquid explosives must provide double protection against leakage, such as a screw cap secured in place with tape.

(3) Inner packagings, fittings, and cushioning materials, and the placing of explosive substances or articles in packages, must be such that the explosive substance is prevented from becoming loose in the outer packaging during transportation. Metallic compo-

nents of articles must be prevented from making contact with metal packagings. Articles containing explosive substances not enclosed in an outer casing must be separated from each other in order to prevent friction and impact. Padding, trays, partitioning in the inner or outer packaging, molded plastics or receptacles may be used for this purpose.

(4) When the packaging includes water that could freeze during transportation, a sufficient amount of anti-freeze, such as denatured ethyl alcohol, must be added to the water to prevent freezing. If the anti-freeze creates a fire hazard, it may not be used. When a percentage of water in the substance is specified, the combined weight of water and anti-freeze may be substituted.

(5) If an article is fitted with its own means of ignition or initiation, it must be effectively protected from accidental actuation during normal conditions of transportation.

(6) The entry of explosive substances into the recesses of double-seamed metal packagings must be prevented.

(7) The closure device of a metal drum must include a suitable gasket; if the closure device includes metal-to-metal screw-threads, the ingress of explosive substances into the threading must be prevented.

(8) Whenever loose explosive substances or the explosive substance of an uncased or partly cased article may come into contact with the inner surface of metal packagings (1A2, 1B2, 4A, 4B and metal receptacles), the metal packaging should be provided with an inner liner or coating.

(9) Packagings must be made of materials compatible with, and impermeable to, the explosives contained in the package, so that neither interaction between the explosives and the packaging materials, nor leakage, causes the explosive to become unsafe in transportation, or the hazard division or compatibility group to change (see §173.24(e)(2)).

(10) An explosive article containing an electrical means of initiation that is sensitive to external electromagnetic radiation, must have its means of initiation effectively protected from electromagnetic radiation sources (for example, radar or radio

§ 173.61

transmitters) through either design of the packaging or of the article, or both.

(11) Plastic packagings may not be able to generate or accumulate sufficient static electricity to cause the packaged explosive substances or articles to initiate, ignite or inadvertently function. Metal packagings must be compatible with the explosive substance they contain.

(12) Explosive substances may not be packed in inner or outer packagings where the differences in internal and external pressures, due to thermal or other effects, could cause an explosion or rupture of the package.

(13) Packagings for water soluble substances must be water resistant. Packagings for desensitized or phlegmatized substances must be closed to prevent changes in concentration during transport. When containing less alcohol, water, or phlegmatizer than specified in its proper shipping description, the substance is a "forbidden" material.

(14) Large and robust explosives articles, normally intended for military use, without their means of initiation or with their means of initiation containing at least two effective protective features, may be carried unpackaged provided that a negative result was obtained in Test Series 4 of the UN Manual of Tests and Criteria on an unpackaged article. When such articles have propelling charges or are self-propelled, their ignition systems must be protected against conditions encountered during normal transportation. Such unpackaged articles may be fixed to cradles or contained in crates or other suitable handling, storage or launching devices in such a way that they will not become loose during normal conditions of transport and are in accordance with DOD-approved procedures. When such large explosive articles, as part of their operational safety and suitability tests, are subjected to testing that meets the intentions of Test Series 4 of the UN Manual of Tests and Criteria with successful test results, they may be offered for transportation in accordance with the requirements prescribed in (b)(14) above sub-

49 CFR Ch. I (10–1–14 Edition)

ject to approval by the Associate Administrator.

[Amdt. 173-260, 62 FR 24719, May 6, 1997, as amended at 65 FR 50461, Aug. 18, 2000; 76 FR 43529, July 20, 2011]

§ 173.61 Mixed packaging requirements.

(a) An explosive may not be packed in the same outside packaging with any other material that could, under normal conditions of transportation, adversely affect the explosive or its packaging unless packaged by DOD or DOE in accordance with § 173.7(a).

(b) Hardware necessary for assembly of explosive articles at the point-of-use may be packed in the same outside packaging with the explosive articles. The hardware must be securely packed in a separate inside packaging. Sufficient cushioning materials must be used to ensure that all inside packagings are securely packed in the outside packaging.

(c) The following explosives may not be packed together with other Class 1 explosives: UN 0029, UN 0030, UN 0073, UN 0106, UN 0107, UN 0255, UN 0257, UN 0267, UN 0350, UN 0360, UN 0361, UN 0364, UN 0365, UN 0366, UN 0367, UN 0408, UN 0409, UN 0410, UN 0455, UN 0456, and UN 0500. These explosives may be mixed-packed with each other in accordance with the compatibility requirements prescribed in paragraph (e) of this section.

(d) Division 1.1 and 1.2 explosives may not be packed with the following explosives: UN 0333, UN 0334, UN 0335, UN 0336, and UN 0337.

(e) Except as prescribed in paragraphs (c) and (d) of this section, different explosives may be packed in one outside packaging in accordance with the following compatibility requirements:

(1) Explosives of the same compatibility group and same division number may be packed together.

(2) Explosives of the same compatibility group or authorized combination of compatibility group but different division number may be packed together, provided that the whole package is treated as though its entire contents were comprised of the lower division number. For example, a mixed package of Division 1.2 explosives and

Division 1.4 explosives, compatibility group D, must be treated as 1.2D explosives. However, when 1.5D explosives are packed together with 1.2D explosives, the whole package must be treated as 1.1D explosives.

(3) Explosives of compatibility group S may be packaged together with explosives of any other compatibility group except A or L, and the combined package may be treated as belonging to any of the packaged compatibility groups except S.

(4) Explosives of compatibility group L shall only be packed with an identical explosive.

(5) Explosives articles of compatibility groups C, D, or E may be packed together and the entire package shall be treated as belonging to compatibility group E.

(6) Explosives articles of compatibility groups C, D, E, or N may be packed together and the entire package shall be treated as belonging to compatibility group D.

(7) Explosives substances of compatibility groups C and D may be packaged together and the entire package shall be treated as belonging to compatibility group D.

(8) Explosive articles of compatibility group G, except for fireworks and articles requiring special packaging, may be packaged together with explosive articles of compatibility groups C, D or E and the combined package shall be treated as belonging to compatibility group E.

[Amdt. 173-224, 55 FR 52617 Dec. 21, 1990, as amended at 56 FR 66267, Dec. 20, 1991; 65 FR 50461, Aug. 18, 2000; 66 FR 33429, June 21, 2001; 66 FR 45381, Aug. 28, 2001; 69 FR 54046, Sept. 7, 2004; 73 FR 4717, Jan. 28 2008]

§ 173.62 Specific packaging requirements for explosives.

(a) Except as provided in §173.7 of this subchapter, when the §172.101 Table specifies that an explosive must be packaged in accordance with this section, only packagings which conform to the provisions of paragraphs (b) and (c) of this section or §173.7(e) of this subchapter and the applicable requirements in §§173.60 and 173.61 may be used unless otherwise approved by the Associate Administrator.

(b) *Explosives Table.* The Explosives Table specifies the Packing Instructions assigned to each explosive. Explosives are identified in the first column in numerical sequence by their identification number (ID #), which is listed in column 4 of the §172.101 table, of this subchapter. The second column of the Explosives Table specifies the Packing Instruction (PI) which must be used for packaging the explosive. The Explosives Packing Method Table in paragraph (c) of this section defines the methods of packaging. The Packing Instructions are identified using a 3 digit designation. The Packing Instruction prefixed by the letters "US" is particular to the United States and not found in applicable international regulations.

EXPLOSIVES TABLE

ID#	PI
UN0004	112
UN0005	130
UN0006	130
UN0007	130
UN0009	130
UN0010	130
UN0012	130
UN0014	130
UN0015	130
UN0016	130
UN0018	130
UN0019	130
UN0020	101
UN0021	101
UN0027	113
UN0028	113
UN0029	131
UN0030	131
UN0033	130
UN0034	130
UN0035	130
UN0037	130
UN0038	130
UN0039	130
UN0042	132
UN0043	133
UN0044	133
UN0048	130
UN0049	135
UN0050	135
UN0054	135
UN0055	136
UN0056	130
UN0059	137
UN0060	132
UN0065	139
UN0066	140
UN0070	134
UN0072	112(a)
UN0073	133
UN0074	110(a) or 110(b)
UN0075	115
UN0076	112
UN0077	114(a) or 114(b)
UN0078	112

§ 173.62

49 CFR Ch. I (10–1–14 Edition)

EXPLOSIVES TABLE—Continued

EXPLOSIVES TABLE—Continued

ID#	PI
UN0079	112(b) or 112(c)
UN0081	116
UN0082	116 or 117
UN0083	116
UN0084	116
UN0092	135
UN0093	135
UN0094	113
UN0099	134
UN0101	140
UN0102	139
UN0103	140
UN0104	139
UN0105	140
UN0106	141
UN0107	141
UN0110	141
UN0113	110(a) or 110(b)
UN0114	110(a) or 110(b)
UN0118	112
UN0121	142
UN0124	US1
UN0129	110(a) or 110(b)
UN0130	110(a) or 110(b)
UN0131	142
UN0132	114(b)
UN0133	112(a)
UN0135	110(a) or 110(b)
UN0136	130
UN0137	130
UN0138	130
UN0143	115
UN0144	115
UN0146	112
UN0147	112(b)
UN0150	112(a) or 112(b)
UN0151	112
UN0153	112(b) or 112(c)
UN0154	112
UN0155	112(b) or 112(c)
UN0159	111
UN0160	114(b)
UN0161	114(b)
UN0167	130
UN0168	130
UN0169	130
UN0171	130
UN0173	134
UN0174	134
UN0180	130
UN0181	130
UN0182	130
UN0183	130
UN0186	130
UN0190	101
UN0191	135
UN0192	135
UN0193	135
UN0194	135
UN0195	135
UN0196	135
UN0197	135
UN0204	134
UN0207	112(b) or 112(c)
UN0208	112(b) or 112(c)
UN0209	112
UN0212	133
UN0213	112(b) or 112(c)
UN0214	112
UN0215	112
UN0216	112(b) or 112(c)
UN0217	112(b) or 112(c)

ID#	PI
UN0218	112(b) or 112(c)
UN0219	112
UN0220	112
UN0221	130
UN0222	112(b) or 112(c)
UN0224	110(a) or 110(b)
UN0225	133
UN0226	112(a)
UN0234	114(a) or 114(b)
UN0235	114(a) or 114(b)
UN0236	114(a) or 114(b)
UN0237	138
UN0238	130
UN0240	130
UN0241	116 or 117
UN0242	130
UN0243	130
UN0244	130
UN0245	130
UN0246	130
UN0247	101
UN0248	144
UN0249	144
UN0250	101
UN0254	130
UN0255	131
UN0257	141
UN0266	112
UN0267	131
UN0268	133
UN0271	143
UN0272	143
UN0275	134
UN0276	134
UN0277	134
UN0278	134
UN0279	130
UN0280	130
UN0281	130
UN0282	112
UN0283	132
UN0284	141
UN0285	141
UN0286	130
UN0287	130
UN0288	138
UN0289	139
UN0290	139
UN0291	130
UN0292	141
UN0293	141
UN0294	130
UN0295	130
UN0296	134
UN0297	130
UN0299	130
UN0300	130
UN0301	130
UN0303	130
UN0305	113
UN0306	133
UN0312	135
UN0313	135
UN0314	142
UN0315	142
UN0316	141
UN0317	141
UN0318	141
UN0319	133
UN0320	133
UN0321	130
UN0322	101

EXPLOSIVES TABLE—Continued

ID#	PI
UN0323	134
UN0324	130
UN0325	142
UN0326	130
UN0327	130
UN0328	130
UN0329	130
UN0330	130
UN0331	116 or 117
UN0332	116 or 117
UN0333	135
UN0334	135
UN0335	135
UN0336	135
UN0337	135
UN0338	130
UN0339	130
UN0340	112(a) or 112(b)
UN0341	112(b)
UN0342	114(a)
UN0343	111
UN0344	130
UN0345	130
UN0346	130
UN0347	130
UN0348	130
UN0349	101
UN0350	101
UN0351	101
UN0352	101
UN0353	101
UN0354	101
UN0355	101
UN0356	101
UN0357	101
UN0358	101
UN0359	101
UN0360	131
UN0361	131
UN0362	130
UN0363	130
UN0364	133
UN0365	133
UN0366	133
UN0367	141
UN0368	141
UN0369	130
UN0370	130
UN0371	130
UN0372	141
UN0373	135
UN0374	134
UN0375	134
UN0376	133
UN0377	133
UN0378	133
UN0379	136
UN0380	101
UN0381	134
UN0382	101
UN0383	101
UN0384	101
UN0385	112(b) or 112(c)
UN0386	112(b) or 112(c)
UN0387	112(b) or 112(c)
UN0388	112(b) or 112(c)
UN0389	112(b) or 112(c)
UN0390	112(b) or 112(c)
UN0391	112(a)
UN0392	112(b) or 112(c)
UN0393	112(b)
UN0394	112(a)

EXPLOSIVES TABLE—Continued

ID#	PI
UN0395	101
UN0396	101
UN0397	101
UN0398	101
UN0399	101
UN0400	101
UN0401	112
UN0402	112(b) or 112(c)
UN0403	135
UN0404	135
UN0405	135
UN0406	114(b)
UN0407	114(b)
UN0408	141
UN0409	141
UN0410	141
UN0411	112(b) or 112(c)
UN0412	130
UN0413	130
UN0414	130
UN0415	143
UN0417	130
UN0418	135
UN0419	135
UN0420	135
UN0421	135
UN0424	130
UN0425	130
UN0426	130
UN0427	130
UN0428	135
UN0429	135
UN0430	135
UN0431	135
UN0432	135
UN0433	111
UN0434	130
UN0435	130
UN0436	130
UN0437	130
UN0438	130
UN0439	137
UN0440	137
UN0441	137
UN0442	137
UN0443	137
UN0444	137
UN0445	137
UN0446	136
UN0447	136
UN0448	114(b)
UN0449	101
UN0450	101
UN0451	130
UN0452	141
UN0453	130
UN0454	142
UN0455	131
UN0456	131
UN0457	130
UN0458	130
UN0459	130
UN0460	130
UN0461	101
UN0462	101
UN0463	101
UN0464	101
UN0465	101
UN0466	101
UN0467	101
UN0468	101
UN0469	101

EXPLOSIVES TABLE—Continued

ID#	PI
UN0470	101
UN0471	101
UN0472	101
UN0473	101
UN0474	101
UN0475	101
UN0476	101
UN0477	101
UN0478	101
UN0479	101
UN0480	101
UN0481	101
UN0482	101
UN0483	112(b) or 112(c)
UN0484	112(b) or 112(c)
UN0486	101
UN0487	135
UN0488	130
UN0489	112(b) or 112(c)
UN0490	112(b) or 112(c)
UN0491	143
UN0492	135
UN0493	135
UN0494	US1
UN0495	115
UN0496	112(b) or 112(c)
UN0497	115
UN0498	114(b)
UN0499	114(b)
UN0500	131
UN0501	114(b)
UN0502	130
UN0503	135
UN0504	112(c)
UN0505	135
UN0506	135
UN0507	135
UN0508	114(b)
UN0509	114(b)
NA0124	US1
NA0276	134
NA0323	134
NA0331	116 or 117
NA0337	135
NA0349	133
NA0494	US1

(c) Explosives must be packaged in accordance with the following table:

(1) The first column lists, in alpha-numeric sequence, the packing methods prescribed for explosives in the Explosives Table of paragraph (b) of this section.

(2) The second column specifies the inner packagings that are required. If inner packagings are not required, a notation of “Not necessary” appears in the column. The term “Not necessary” means that a suitable inner packaging may be used but is not required.

(3) The third column specifies the intermediate packagings that are required. If intermediate packagings are not required, a notation of “Not necessary” appears in the column. The term “Not necessary” means that a suitable intermediate packaging may be used but is not required.

(4) The fourth column specifies the outer packagings which are required. If inner packagings and/or intermediate packagings are specified in the second and third columns, then the packaging specified in the fourth column must be used as the outer packaging of a combination packaging; otherwise it may be used as a single packaging.

(5) Packing Instruction 101 may be used for any explosive substance or article if an equivalent level of safety is shown to be maintained subject to the approval of the Associate Administrator.

TABLE OF PACKING METHODS

Packing instruction	Inner packagings	Intermediate packagings	Outer packagings
101	This Packing Instruction may be used as an alternative to a specifically assigned packing method with the approval of the Associate Administrator prior to transportation. When this packing instruction is used, the following must be marked on the shipping documents: “Packaging approved by the competent authority of the United States of America (USA)”.		
PARTICULAR PACKING REQUIREMENTS OR EXCEPTIONS:			
1. Samples of new or existing explosive substances or articles may be transported as directed by the Associate Administrator for purposes including: testing, classification, research and development, quality control, or as a commercial sample. Explosive samples which are wetted or desensitized must be limited to 25 kg. Explosive samples which are not wetted or desensitized must be limited to 10 kg in small packages as specified by the Associate Administrator for Hazardous Materials Safety			
110(a)	Bags	Bags	Drums.

TABLE OF PACKING METHODS—Continued

Packing instruction	Inner packagings	Intermediate packagings	Outer packagings
<p>PARTICULAR PACKING REQUIREMENTS OR EXCEPTIONS:</p> <p>1. The Intermediate packagings must be filled with water saturated material such as an anti-freeze solution or wetted cushioning.</p> <p>2. Outer packagings must be filled with water saturated material such as an anti-freeze solution or wetted cushioning. Outer packagings must be constructed and sealed to prevent evaporation of the wetting solution, except when 0224 is being carried dry.</p>	<p>plastics,</p> <p>textile, plastic coated or lined.</p> <p>rubber</p> <p>textile, rubberized ..</p> <p>textile</p> <p>Receptacles</p> <p>wood</p>	<p>plastics,</p> <p>textile, plastic coated or lined.</p> <p>rubber</p> <p>textile, rubberized ..</p> <p>Receptacles</p> <p>plastics</p> <p>metal</p> <p>wood</p>	<p>steel (1A1 or 1A2).</p> <p>other metal (1N1 or 1N2).</p> <p>plastics-(1H1 or 1H2).</p>
<p>110(b)</p> <p>PARTICULAR PACKING REQUIREMENTS OR EXCEPTIONS</p> <p>For UN 0074, 0113, 0114, 0129, 0130, 0135 and 0224, the following conditions must be satisfied:</p> <p>a. inner packagings must not contain more than 50 g of explosive substance (quantity corresponding to dry substance);</p> <p>b. each inner packaging must be separated from other inner packagings by dividing partitions; and</p> <p>c. the outer packaging must not be partitioned with more than 25 compartments</p>	<p>Bags</p> <p>rubber, conductive</p> <p>plastics, conductive ..</p> <p>Receptacles</p> <p>metal</p> <p>wood</p> <p>rubber, conductive</p> <p>plastics, conductive ..</p>	<p>Dividing partitions</p> <p>metal</p> <p>wood</p> <p>plastics</p> <p>fibreboard</p>	<p>Boxes.</p> <p>natural wood, sift-proof wall (4C2).</p> <p>plywood (4D).</p> <p>reconstituted wood (4F).</p>
<p>111</p> <p>PARTICULAR PACKING REQUIREMENTS OR EXCEPTIONS:</p> <p>For UN0159, inner packagings are not required when metal (1A1, 1A2, 1B1, 1B2, 1N1 or 1N2) or plastics (1H1 or 1H2) drums are used as outer packagings.</p>	<p>Bags</p> <p>paper, water-proofed.</p> <p>plastics</p> <p>textile, rubberized ..</p> <p>Sheets</p> <p>plastics</p> <p>textile, rubberized ..</p> <p>Receptacles</p> <p>wood</p>	<p>Not necessary</p>	<p>Boxes.</p> <p>steel (4A).</p> <p>aluminum (4B).</p> <p>other metal (4N).</p> <p>natural wood, ordinary (4C1).</p> <p>natural wood, sift proof (4C2).</p> <p>plywood (4D).</p> <p>reconstituted wood (4F).</p> <p>fiberboard (4G).</p> <p>plastics, expanded (4H1).</p> <p>plastics, solid (4H2).</p> <p>Drums</p> <p>steel (1A1 or 1A2).</p> <p>aluminum (1B1 or 1B2).</p> <p>other metal (1N1 or 1N2).</p> <p>plywood (1D).</p> <p>fiberboard (1G).</p> <p>plastics (1H1 or 1H2).</p>
<p>112(a)</p>	<p>Bags</p>	<p>Bags</p>	<p>Boxes.</p>

TABLE OF PACKING METHODS—Continued

Packing instruction	Inner packagings	Intermediate packagings	Outer packagings
<p>PARTICULAR PACKING REQUIREMENTS OR EXCEPTIONS:</p> <ol style="list-style-type: none"> For UN Nos. 0004, 0076, 0078, 0154, 0219 and 0394, packagings must be lead free. Intermediate packagings are not required if leakproof drums are used as the outer packaging. For UN0072 and UN0226, intermediate packagings are not required. 	<p>paper, multiwall, water resistant. plastics textile textile, rubberized .. woven plastics</p> <p>Receptacles metal plastics wood</p>	<p>plastics textile, plastic coated or lined. Receptacles metal plastics wood</p>	<p>steel (4A). aluminum (4B). other metal (4N). natural wood, ordinary (4C1). natural wood, sift proof (4C2). plywood (4D). reconstituted wood (4F). fiberboard (4G). plastics, expanded (4H1). plastics, solid (4H2).</p> <p>Drums steel (1A1 or 1A2). aluminum (1B1 or 1B2). other metal (1N1 or 1N2). plywood (1D). fiber (1G). plastics (1H1 or 1H2).</p>
<p>112(b) This packing instruction applies to dry solids other than powders. PARTICULAR PACKING REQUIREMENTS OR EXCEPTIONS:</p> <ol style="list-style-type: none"> For UN 0004, 0076, 0078, 0154, 0216, 0219 and 0386, packagings must be lead free. For UN0209, bags, sift-proof (5H2) are recommended for flake or prilled TNT in the dry state and a maximum net mass of 30 kg.. For UN0222, inner packagings are not required. 	<p>Bags paper, Kraft paper, multiwall, water resistant. plastics textile textile, rubberized plastics. woven plastics</p>	<p>Bags (for UN0150 only) plastics textile, plastic coated or lined.</p>	<p>Bags. woven plastics sift-proof (5H2/3). plastics, film (5H4). textile, sift-proof (5L2). textile, water resistant (5L3). paper, multiwall, water resistant (5M2).</p> <p>Boxes steel (4A). aluminum (4B). other metal (4N). natural wood, ordinary (4C1). natural wood, sift proof (4C2). plywood (4D) reconstituted wood (4F). fiberboard (4G). plastics, expanded (4H1). plastics, solid (4H2).</p> <p>Drums steel (1A1 or 1A2). aluminum (1B1 or 1B2). plywood (1D). other metal (1N1 or 1N2). fiber (1G). plastics (1H1 or 1H2).</p>
<p>112(c) This packing instruction applies to solid dry powders.</p>	<p>Bags</p>	<p>Bags</p>	<p>Boxes.</p>

TABLE OF PACKING METHODS—Continued

Packing instruction	Inner packagings	Intermediate packagings	Outer packagings
<p>PARTICULAR PACKING REQUIREMENTS OR EXCEPTIONS:</p> <ol style="list-style-type: none"> For UN 0004, 0076, 0078, 0154, 0216, 0219 and 0386, packagings must be lead free. For UN0209, bags, sift-proof (5H2) are recommended for flake or prilled TNT in the dry state. Bags must not exceed a maximum net mass of 30 kg.. Inner packagings are not required if drums are used as the outer packaging.. At least one of the packagings must be sift-proof. 	<p>paper, multiwall, water resistant. plastics woven plastics Receptacles fiberboard metal plastics wood</p>	<p>paper, multiwall, water resistant with inner lining. plastics Receptacles metal plastics wood</p>	<p>steel (4A). aluminum (4B). other metal (4N). natural wood, ordinary (4C1). natural wood, sift proof (4C2). plywood (4D). reconstituted wood (4F). fiberboard (4G). plastics, solid (4H2). Drums. plastics (1H1 or 1H2). steel (1A1 or 1A2). aluminum (1B1 or 1B2). other metal (1N1 or 1N2). plywood (1D). fiber (1G).</p>
<p>113 PARTICULAR PACKING REQUIREMENTS OR EXCEPTIONS:</p> <ol style="list-style-type: none"> For UN0094 and UN0305, no more than 50 g of substance must be packed in an inner packaging. For UN0027, inner packagings are not necessary when drums are used as the outer packaging. At least one of the packagings must be sift-proof. Sheets must only be used for UN0028. 	<p>Bags paper plastics textile, rubberized .. Receptacles fiberboard metal plastics wood Sheets paper, kraft paper, waxed</p>	<p>Not necessary</p>	<p>Boxes. steel (4A). aluminum (4B). other metal (4N). natural wood, ordinary (4C1). natural wood, sift-proof walls (4C2). plywood (4D). reconstituted wood (4F). fiberboard (4G). plastics, solid (4H2). Drums plastics (1H1 or 1H2). steel (1A1 or 1A2). aluminum-(1B1 or 1B2). other metal (1N1 or 1N2). plywood (1D). fiber (1G).</p>
<p>114(a)</p>	<p>Bags</p>	<p>Bags</p>	<p>Boxes</p>

TABLE OF PACKING METHODS—Continued

Packing instruction	Inner packagings	Intermediate packagings	Outer packagings
<p>This packing instruction applies to wetted solids PARTICULAR PACKING REQUIREMENTS OR EXCEPTIONS:</p> <ol style="list-style-type: none"> For UN 0077, 0234, 0235 and 0236, packagings must be lead free. For UN0342, inner packagings are not required when metal (1A1, 1A2, 1B1, 1B2, 1N1 or 1N2) or plastics (1H1 or 1H2) drums are used as outer packagings. Intermediate packagings are not required if leakproof removable head drums are used as the outer packaging. 	<p>plastics</p> <p>textile</p> <p>woven plastics</p> <p>Receptacles</p> <p>metal</p> <p>plastics</p> <p>wood</p>	<p>plastics</p> <p>textile, plastic coated or lined.</p> <p>Receptacles</p> <p>metal</p> <p>plastics</p> <p>Dividing partitions</p> <p>wood</p>	<p>steel (4A).</p> <p>other metal (4N).</p> <p>natural wood, ordinary (4C1).</p> <p>natural wood, sift proof walls (4C2).</p> <p>plywood (4D).</p> <p>reconstituted wood (4F).</p> <p>fiberboard (4G).</p> <p>plastics, solid (4H2).</p> <p>Drums.</p> <p>steel (1A1 or 1A2).</p> <p>aluminum (1B1 or 1B2).</p> <p>other metal (1N1 or 1N2)</p> <p>plywood (1D).</p> <p>fiber (1G).</p> <p>plastics (1H1 or 1H2).</p>
<p>114(b) PARTICULAR PACKING REQUIREMENTS OR EXCEPTIONS:</p> <ol style="list-style-type: none"> For UN Nos. 0077, 0132, 0234, 0235 and 0236, packagings must be lead free. For UN0160 and UN0161, when metal drums (1A2, 1B2 or 1N2) are used as the outer packaging, metal packagings must be so constructed that the risk of explosion, by reason of increased internal pressure from internal or external causes, is prevented. For UN0160, UN0161, and UN0508, inner packagings are not necessary if drums are used as the outer packaging. For UN0508 and UN0509, metal packagings must not be used. 	<p>Bags</p> <p>paper, kraft</p> <p>plastics</p> <p>textile, sift-proof</p> <p>woven plastics, sift-proof..</p> <p>Receptacles</p> <p>fiberboard</p> <p>metal</p> <p>paper</p> <p>plastics</p> <p>wood</p> <p>woven plastics, sift-proof..</p>	<p>Not necessary</p>	<p>Boxes</p> <p>natural wood, ordinary (4C1).</p> <p>natural wood, sift-proof walls (4C2).</p> <p>plywood (4D).</p> <p>reconstituted wood (4F).</p> <p>fiberboard (4G).</p> <p>Drums.</p> <p>steel (1A1 or 1A2).</p> <p>aluminum (1B1 or 1B2).</p> <p>other metal (1N1 or 1N2).</p> <p>plywood (1D).</p> <p>fiber (1G).</p> <p>plastics (1H1 or 1H2).</p>
115	Receptacles	Bags	Boxes

TABLE OF PACKING METHODS—Continued

Packing instruction	Inner packagings	Intermediate packagings	Outer packagings
<p>PARTICULAR PACKING REQUIREMENTS OR EXCEPTIONS:</p> <ol style="list-style-type: none"> For liquid explosives, inner packagings must be surrounded with non-combustible absorbent cushioning material in sufficient quantity to absorb the entire liquid content. Metal receptacles should be cushioned from each other. The net mass of explosive per package may not exceed 30 kg when boxes are used as outer packaging. The net volume of explosive in each package other than boxes must not exceed 120 liters. For UN 0075, 0143, 0495 and 0497 when boxes are used as the outer packaging, inner packagings must have taped screw cap closures and be not more than 5 liters capacity each. A composite packaging consisting of a plastic receptacle in a metal drum (6HA1) may be used in lieu of combination packagings. Liquid substances must not freeze at temperatures above -15 °C (+5 °F). For UN0144, intermediate packagings are not necessary. Aluminum drums (1B1 and 1B2) and metal, other than steel or aluminum, drums (1N1 and 1N2) must not be used.. 	<p>metal</p> <p>plastics</p> <p>wood</p>	<p>plastics in metal receptacles.</p> <p>Drums</p> <p>metal</p> <p>Receptacles</p> <p>wood</p>	<p>natural wood, ordinary (4C1).</p> <p>natural wood, sift proof walls (4C2).</p> <p>plywood (4D).</p> <p>reconstituted wood (4F).</p> <p>fiberboard (4G).</p> <p>Drums.</p> <p>plastics (1H1 or 1H2).</p> <p>steel (1A1 or 1A2).</p> <p>aluminum (1B1 or 1B2).</p> <p>other metal (1N1 or 1N2).</p> <p>plywood (1D).</p> <p>fiber (1G).</p> <p>Specification MC-200 containers may be used for transport by motor vehicle.</p>
<p>116</p> <p>PARTICULAR PACKING REQUIREMENTS OR EXCEPTIONS:</p> <ol style="list-style-type: none"> For UN 0082, 0241, 0331 and 0332, inner packagings are not necessary if leakproof removable head drums are used as the outer packaging. For UN 0082, 0241, 0331 and 0332, inner packagings are not required when the explosive is contained in a material impervious to liquid. For UN0081, inner packagings are not required when contained in rigid plastic that is impervious to nitric esters. For UN0331, inner packagings are not required when bags (5H2), (5H3) or (5H4) are used as outer packagings. Bags (5H2 or 5H3) must be used only for UN0082, 0241, 0331 and 0332. For UN0081, bags must not be used as outer packagings. 	<p>Bags</p> <p>paper, water and oil.</p> <p>resistant</p> <p>plastics</p> <p>textile, plastic coated or.</p> <p>lined</p> <p>woven plastics, sift-proof.</p> <p>Receptacles</p> <p>fiberboard, water resistant.</p> <p>metal</p> <p>plastics</p> <p>wood, sift-proof</p> <p>Sheets</p> <p>paper, water resistant.</p> <p>paper, waxed</p> <p>plastics</p>	<p>Not Necessary</p> <p>Not necessary</p>	<p>Bags</p> <p>woven plastics (5H1/2/3).</p> <p>paper, multiwall, water resistant (5M2).</p> <p>plastics, film (5H4).</p> <p>textile, sift-proof (5L2).</p> <p>textile, water resistant (5L3).</p> <p>Boxes.</p> <p>steel (4A).</p> <p>aluminum (4B).</p> <p>other metal (4N).</p> <p>wood, natural, ordinary (4C1).</p> <p>natural wood, sift proof walls (4C2).</p> <p>plywood (4D).</p> <p>reconstituted wood (4F).</p> <p>fiberboard (4G).</p> <p>plastics, solid (4H2).</p> <p>Drums.</p> <p>steel (1A1 or 1A2).</p> <p>aluminum (1B1 or 1B2).</p> <p>other metal (1N1 or 1N2).</p> <p>plywood (1D).</p> <p>fiber (1G).</p> <p>plastics (1H1 or 1H2).</p> <p>Jerricans.</p> <p>steel (3A1 or 3A2).</p> <p>plastics (3H1 or 3H2).</p>
<p>117</p>	<p>Not necessary</p>	<p>Not necessary</p>	<p>IBCs.</p>

TABLE OF PACKING METHODS—Continued

Packing instruction	Inner packagings	Intermediate packagings	Outer packagings
<p>PARTICULAR PACKING REQUIREMENTS OR EXCEPTIONS:</p> <p>1. This packing instruction may only be used for explosives of UN0082 when they are mixtures of ammonium nitrate or other inorganic nitrates with other combustible substances that are not explosive ingredients. Such explosives must not contain nitroglycerin, similar liquid organic nitrates, liquid or solid nitrocarbons, or chlorates.</p> <p>2. This packing instruction may only be used for explosives of UN0241 that consist of water as an essential ingredient and high proportions of ammonium nitrate or other oxidizers, some or all of which are in solution. The other constituents may include hydrocarbons or aluminum powder, but must not include nitro-derivatives such as trinitrotoluene.</p> <p>3. Metal IBCs must not be used for UN0082 and UN 0241.</p> <p>4. Flexible IBCs may only be used for solids.</p>			<p>metal (11A), (11B), (11N), (21A), (21B), (21N), (31A), (31B), (31N).</p> <p>flexible (13H2), (13H3), (13H4), (13L2), (13L3), (13L4), (13M2).</p> <p>rigid plastics (11H1), (11H2), (21H1), (21H2), (31H1), (31H2).</p> <p>composite (11HZ1), (11HZ2), (21HZ1), (21HZ2), (31HZ1), (31HZ2).</p>
<p>130 Particular Packaging Requirements:</p> <p>1. The following applies to UN 0006, 0009, 0010, 0015, 0016, 0018, 0019, 0034, 0035, 0038, 0039, 0048, 0056, 0137, 0138, 0168, 0169, 0171, 0181, 0182, 0183, 0186, 0221, 0238, 0243, 0244, 0245, 0246, 0254, 0280, 0281, 0286, 0287, 0297, 0299, 0300, 0301, 0303, 0321, 0328, 0329, 0344, 0345, 0346, 0347, 0362, 0363, 0370, 0412, 0424, 0425, 0434, 0435, 0436, 0437, 0438, 0451, 0459 and 0488. Large and robust explosives articles, normally intended for military use, without their means of initiation or with their means of initiation containing at least two effective protective features, may be carried unpackaged. When such articles have propelling charges or are self-propelled, their ignition systems must be protected against stimuli encountered during normal conditions of transport. A negative result in Test Series 4 on an unpackaged article indicates that the article can be considered for transport unpackaged. Such unpackaged articles may be fixed to cradles or contained in crates or other suitable handling devices.</p> <p>2. Subject to approval by the Associate Administrator, large explosive articles, as part of their operational safety and suitability tests, subjected to testing that meets the intentions of Test Series 4 of the UN Manual of Tests and Criteria with successful test results, may be offered for transportation in accordance with the requirements of this subchapter</p>	<p>Not necessary</p>	<p>Not necessary</p>	<p>Boxes.</p> <p>Steel (4A). Aluminum (4B). Other metal (4N). Wood natural, ordinary (4C1). Wood natural, sift-proof walls (4C2). Plywood (4D). Reconstituted wood (4F). Fiberboard (4G). Plastics, expanded (4H1). Plastics, solid (4H2). Drums. Steel (1A1 or 1A2). Aluminum (1B1 or 1B2). Other metal (1N1 or 1N2). Plywood (1D). Fiber (1G). Plastics (1H1 or 1H2). Large Packagings. Steel (50A). Aluminum (50B). Metal other than steel or aluminum (50N). Rigid plastics (50H). Natural wood (50C). Plywood (50D). Reconstituted wood (50F). Rigid fiberboard (50G).</p>
<p>131</p>	<p>Bags</p>	<p>Not Necessary</p>	<p>Boxes</p>

TABLE OF PACKING METHODS—Continued

Packing instruction	Inner packagings	Intermediate packagings	Outer packagings
<p>PARTICULAR PACKING REQUIREMENTS OR EXCEPTIONS:</p> <p>1. For UN 0029, 0267 and 0455, bags and reels may not be used as inner packagings.</p> <p>2. For UN 0030, 0255 and 0456, inner packagings are not required when detonators are packed in pasteboard tubes, or when their leg wires are wound on spools with the caps either placed inside the spool or securely taped to the wire on the spool, so as to restrict free moving of the caps and to protect them from impact forces.</p> <p>3. For UN 0360, 0361 and 0500, detonators are not required to be attached to the safety fuse, metal-clad mild detonating cord, detonating cord, or shock tube. Inner packagings are not required if the packing configuration restricts free moving of the caps and protects them from impact forces.</p>	<p>paper</p> <p>plastics</p> <p>Receptacles</p> <p>fiberboard</p> <p>metal</p> <p>plastics</p> <p>wood</p> <p>Reels</p>		<p>steel (4A).</p> <p>aluminum (4B).</p> <p>other metal (4N).</p> <p>wood, natural, ordinary (4C1).</p> <p>natural wood, sift proof walls (4C2).</p> <p>plywood (4D).</p> <p>reconstituted wood (4F).</p> <p>fiberboard (4G).</p> <p>Drums.</p> <p>steel (1A1 or 1A2).</p> <p>Aluminum (1B1 or 1B2).</p> <p>other metal (1N1 or 1N2).</p> <p>Plywood (1D).</p> <p>fiber (1G).</p> <p>plastics (1H1 or 1H2).</p>
<p>132(a)</p> <p>For articles consisting of closed metal, plastic or fiberboard casings that contain detonating explosives, or consisting of plastics-bonded detonating explosives.</p>	<p>Not necessary</p>	<p>Not necessary</p>	<p>Boxes</p> <p>steel (4A).</p> <p>aluminum (4B).</p> <p>other metal (4N).</p> <p>wood, natural, ordinary (4C1).</p> <p>wood, natural, sift proof walls (4C2).</p> <p>plywood (4D).</p> <p>reconstituted wood (4F).</p> <p>fiberboard (4G).</p> <p>plastics, solid (4H2).</p>
<p>132(b)</p> <p>For articles without closed casings</p>	<p>Receptacles</p> <p>fiberboard</p> <p>metal</p> <p>plastics</p> <p>wood</p> <p>Sheets</p> <p>paper</p> <p>plastics</p>	<p>Not necessary</p>	<p>Boxes</p> <p>steel (4A).</p> <p>aluminum (4B).</p> <p>other metal (4N).</p> <p>wood, natural, ordinary (4C1).</p> <p>wood, natural, sift proof walls (4C2).</p> <p>plywood (4D).</p> <p>reconstituted wood (4F).</p> <p>fiberboard (4G).</p> <p>plastics, solid (4H2).</p>
<p>133</p> <p>PARTICULAR PACKING REQUIREMENTS OR EXCEPTIONS:</p> <p>1. For UN 0043, 0212, 0225, 0268 and 0306 trays are not authorized as inner packagings.</p>	<p>Receptacles</p> <p>fiberboard</p> <p>metal</p> <p>plastics</p> <p>wood</p> <p>Trays, fitted with dividing partitions fiberboard plastics wood</p>	<p>.....</p> <p>Intermediate packagings are only required when trays are used as inner packagings..</p> <p>Receptacles</p> <p>fiberboard</p> <p>metal</p> <p>plastics</p> <p>wood</p>	<p>Boxes.</p> <p>steel (4A).</p> <p>aluminum (4B).</p> <p>other metal (4N).</p> <p>wood, natural, ordinary (4C1).</p> <p>wood, natural, sift proof walls (4C2).</p> <p>plywood (4D).</p> <p>reconstituted wood (4F).</p> <p>fiberboard (4G).</p> <p>plastics, solid (4H2).</p>
<p>134</p>	<p>Bags</p>	<p>Not necessary</p>	<p>Boxes.</p>

TABLE OF PACKING METHODS—Continued

Packing instruction	Inner packagings	Intermediate packagings	Outer packagings
.....	water resistant Receptacles fiberboard metal plastics wood Sheets fiberboard, cor- rugated. Tubes fiberboard		steel (4A). aluminum (4B). other metal (4N). wood, natural, ordi- nary (4C1). wood, natural, sift proof walls (4C2). plywood (4D). reconstituted wood (4F). fiberboard (4G). plastics, expanded (4H1). plastics, solid (4H2). Drums. fiberboard (1G). plastics (1H1 or 1H2). steel (1A1 or 1A2). aluminum (1B1 or 1B2). other metal (1N1 or 1N2). plywood (1D).
135	Bags paper plastics Receptacles fiberboard metal plastics wood Sheets paper plastics	Not necessary	Boxes. steel (4A). aluminum (4B). other metal (4N). wood, natural, ordi- nary (4C1). wood, natural, sift proof walls (4C2). plywood (4D). reconstituted wood (4F). fiberboard (4G). plastics, expanded (4H1). plastics, solid (4H2). Drums. steel (1A1 or 1A2). aluminum (1B1 or 1B2). other metal (1N1 or 1N2). plywood (1D). fiber (1G). plastics (1H1 or 1H2).
136	Bags	Not necessary	Boxes.

TABLE OF PACKING METHODS—Continued

Packing instruction	Inner packagings	Intermediate packagings	Outer packagings
.....	plastics textile Boxes. fiberboard plastics wood Dividing partitions in the outer packagings		steel (4A). aluminum (4B). other metal (4N). wood, natural, ordi- nary (4C1). wood, natural, sift proof walls (4C2). plywood (4D). reconstituted wood (4F). fiberboard (4G). plastics, solid (4H2). Drums. steel (1A1 or 1A2). aluminum (1B1 or 1B2). other metal (1N1 or 1N2). plywood (1D). fiber (1G). plastics (1H1 or 1H2).
137 PARTICULAR PACKING REQUIREMENTS OR EXCEPTIONS: For UN 0059, 0439, 0440 and 0441, when the shaped charges are packed singly, the conical cavity must face downwards and the package marked "THIS SIDE UP". When the shaped charges are packed in pairs, the con- ical cavities must face inwards to min- imize the jetting effect in the event of accidental initiation.	Bags plastics Boxes fiberboard wood Tubes fiberboard metal plastics Dividing partitions in the outer packagings	Not necessary	Boxes. steel (4A). aluminum (4B). other metal (4N). wood, natural, ordi- nary (4C1). wood, natural, sift proof walls (4C2). plywood (4D). reconstituted wood (4F). fiberboard (4G). Drums. steel (1A1 or 1A2). aluminum (1B1 or 1B2). other metal (1N1 or 1N2). plywood (1D). fiber (1G). plastics (1H1 or 1H2).
138	Bags	Not necessary	Boxes.

TABLE OF PACKING METHODS—Continued

Packing instruction	Inner packagings	Intermediate packagings	Outer packagings
<p>PARTICULAR PACKING REQUIREMENTS OR EXCEPTIONS: If the ends of the articles are sealed, inner packagings are not necessary.</p>	Plastics		steel (4A). aluminum (4B). other metal (4N). wood, natural, ordinary (4C1). wood, natural, sift proof walls (4C2). plywood (4D). reconstituted wood (4F). fiberboard (4G). plastics, solid (4H2). Drums. fiberboard (1G). plastics (1H1 or 1H2). steel (1A1 or 1A2). aluminum (1B1 or 1B2). other metal (1N1 or 1N2).
<p>139 PARTICULAR PACKING REQUIREMENTS OR EXCEPTIONS: 1. For UN 0065, 0102, 0104, 0289 and 0290, the ends of the detonating cord must be sealed, for example, by a plug firmly fixed so that the explosive cannot escape. The ends of CORD DETONATING flexible must be fastened securely. 2. For UN0065 and UN0289, inner packagings are not required when they are fastened securely in coils.</p>	Bags plastics Receptacles fiberboard metal plastics wood Reels Sheets paper plastics	Not necessary	Boxes. steel (4A). aluminum (4B). other metal (4N). wood, natural, ordinary (4C1). wood, natural, sift proof walls (4C2). plywood (4D). reconstituted wood (4F). fiberboard (4G). plastics, solid (4H2). Drums. steel (1A1 or 1A2). aluminum (1B1 or 1B2). other metal (1N1 or 1N2). plywood (1D). fiber (1G). plastics (1H1 or 1H2).
<p>140</p>	Bags	Not necessary	Boxes.

TABLE OF PACKING METHODS—Continued

Packing instruction	Inner packagings	Intermediate packagings	Outer packagings
<p>PARTICULAR PACKING REQUIREMENTS OR EXCEPTIONS:</p> <ol style="list-style-type: none"> If the ends of UN0105 are sealed, no inner packagings are required. For UN0101, the packaging must be sift-proof except when the fuse is covered by a paper tube and both ends of the tube are covered with removable caps. For UN0101, steel or aluminum boxes or drums must not be used. 	<p>plastics</p> <p>Reels</p> <p>Sheets</p> <p>paper, kraft</p> <p>plastics</p> <p>Receptacles</p> <p>wood</p>		<p>steel (4A). aluminum (4B). other metal (4N). wood, natural, ordinary (4C1). wood, natural, sift proof walls (4C2). plywood (4D). reconstituted wood (4F). fiberboard (4G). plastics, solid (4H2).</p> <p>Drums.</p> <p>plastics (1H1 or 1H2). steel (1A1 or 1A2). aluminum (1B1 or 1B2). other metal (1N1 or 1N2). plywood (1D). fiber (1G).</p>
<p>141</p>	<p>Receptacles</p> <p>fiberboard</p> <p>metal</p> <p>plastics</p> <p>wood</p> <p>Trays, fitted with dividing partitions</p> <p>plastics</p> <p>wood</p> <p>Dividing partitions in the outer packagings</p>	<p>Not necessary</p>	<p>Boxes.</p> <p>steel (4A). aluminum (4B). other metal (4N). wood, natural, ordinary (4C1). wood, natural, sift proof walls (4C2). plywood (4D). reconstituted wood (4F). fiberboard (4G). plastics, solid (4H2).</p> <p>Drums.</p> <p>steel (1A1 or 1A2). aluminum (1B1 or 1B2). other metal (1N1 or 1N2). plywood (1D). fiber (1G). plastics (1H1 or 1H2).</p>
<p>142</p>	<p>Bags</p>	<p>Not necessary</p>	<p>Boxes.</p>

TABLE OF PACKING METHODS—Continued

Packing instruction	Inner packagings	Intermediate packagings	Outer packagings
.....	paper plastics Receptacles fiberboard metal plastics wood Sheets paper Trays, fitted with divid- ing partitions plastics		steel (4A). aluminum (4B). other metal (4N). wood, natural, ordi- nary (4C1). wood, natural, sift proof walls (4C2). plywood (4D). reconstituted wood (4F). fiberboard (4G). plastics, solid (4H2). Drums. steel (1A1 or 1A2). aluminum (1B1 or 1B2). other metal (1N1 or 1N2). plywood (1D). fiber (1G). plastics (1H1 or 1H2).
143 PARTICULAR PACKING REQUIREMENTS OR EXCEPTIONS: 1. For UN 0271, 0272, 0415 and 0491 when metal packagings are used, metal packagings must be so con- structed that the risk of explosion, by reason of increase in internal pres- sure from internal or external causes is prevented. 2. Composite packagings (6HH2) (plas- tic receptacle with outer solid box) may be used in lieu of combination packagings.	Bag paper, kraft plastics textile textile, rubberized .. Receptacles fiberboard metal plastics wood Trays, fitted with divid- ing partitions plastics wood	Not necessary	Boxes. steel (4A). aluminum (4B). other metal (4N). wood, natural, ordi- nary (4C1). wood, natural, sift proof walls (4C2). plywood (4D). reconstituted wood (4F). fiberboard (4G). plastics, solid (4H2). Drums. steel (1A1 or 1A2). aluminum (1B1 or 1B2). other metal (1N1 or 1N2). plywood (1D). fiber (1G). plastics (1H1 or 1H2).
144	Receptacles	Not necessary	Boxes.

TABLE OF PACKING METHODS—Continued

Packing instruction	Inner packagings	Intermediate packagings	Outer packagings
<p>PARTICULAR PACKING REQUIREMENTS OR EXCEPTIONS: For UN0248 and UN 0249, packagings must be protected against the ingress of water. When CONTRIVANCES, WATER ACTIVATED are transported unpackaged, they must be provided with at least two independent protective features that prevent the ingress of water.</p>	<p>fiberboard metal plastics wood Dividing partitions in the outer packagings</p>		<p>steel (4A). aluminum (4B). other metal (4N). wood, natural, ordinary (4C1) with metal liner. plywood (4D) with metal liner. reconstituted wood (4F) with metal liner. plastics, expanded (4H1). plastics, solid (4H2). Drums. steel (1A1 or 1A2). aluminum (1B1 or 1B2). other metal (1N1 or 1N2). plastics (1H1 or 1H2). plywood (1D).</p>
<p>US 1</p>			

1. A jet perforating gun, charged, oil well may be transported under the following conditions:
 - a. Initiation devices carried on the same motor vehicle or offshore supply vessel must be segregated; each kind from every other kind, and from any gun, tool or other supplies, unless approved in accordance with § 173.56. Segregated initiation devices must be carried in a container having individual pockets for each such device or in a fully enclosed steel container lined with a non-sparking material. No more than two segregated initiation devices per gun may be carried on the same motor vehicle.
 - b. Each shaped charge affixed to the gun may not contain more than 112 g (4 ounces) of explosives.
 - c. Each shaped charge if not completely enclosed in glass or metal, must be fully protected by a metal cover after installation in the gun.
 - d. A jet perforating gun classed as 1.1D or 1.4D may be transported by highway by private or contract carriers engaged in oil well operations.
 - (i) A motor vehicle transporting a gun must have specially built racks or carrying cases designed and constructed so that the gun is securely held in place during transportation and is not subject to damage by contact, one to the other or any other article or material carried in the vehicle; and
 - (ii) The assembled gun packed on the vehicle may not extend beyond the body of the motor vehicle.
 - e. A jet perforating gun classed as 1.4D may be transported by a private offshore supply vessel only when the gun is carried in a motor vehicle as specified in paragraph (d) of this packing method or on offshore well tool pallets provided that:
 - (i) All the conditions specified in paragraphs (a), (b), and (c) of this packing method are met;
 - (ii) The total explosive contents do not exceed 90.8 kg (200 pounds) per tool pallet;
 - (iii) Each cargo vessel compartment may contain up to 90.8 kg (200 pounds) of explosive content if the segregation requirements in § 176.83(b) of this subchapter are met; and
 - (iv) When more than one vehicle or tool pallet is stowed "on deck" a minimum horizontal separation of 3 m (9.8 feet) must be provided.

[Amdt. 173–260, 62 FR 24720, May 6, 1997]

EDITORIAL NOTES: 1. For FEDERAL REGISTER citations affecting § 173.62, see the List of CFR Sections Affected, which appears in the Finding Aids section of the printed volume and at www.fdsys.gov.

2. At 78 FR 65479, Oct. 31, 2013, § 173.62 was amended by revising Table of Packing Methods, Packing Instructions 116; however, the amendment could not be incorporated because the amendatory instruction does not include text to revise that entry.

§ 173.63 Packaging exceptions.

(a) Cord, detonating (UN 0065), having an explosive content not exceeding 6.5 g (0.23 ounces) per 30 centimeter length (one linear foot) may be offered for transportation domestically and transported as Cord, detonating (UN 0289), Division 1.4 Compatibility Group D

(1.4D) explosives, if the gross weight of all packages containing Cord, detonating (UN 0065), does not exceed 45 kg (99 pounds) per:

- (1) Transport vehicle, freight container, or cargo-only aircraft;
- (2) Off-shore down-hole tool pallet carried on an off-shore supply vessel;

(3) Cargo compartment of a cargo vessel; or

(4) Passenger-carrying aircraft used to transport personnel to remote work sites, such as offshore drilling units.

(b) *Limited quantities of Cartridges, small arms, Cartridges, power device, Cartridges for tools, blank, and Cases, cartridge, empty with primer.* (1)(i) Cartridges, small arms, Cartridges, power device (*used to project fastening devices*), Cartridges for tools, blank, and Cases, cartridge, empty with primer that have been classed as Division 1.4S explosive may be offered for transportation and transported as limited quantities when packaged in accordance with paragraph (b)(2) of this section. Packages containing such articles may be marked with either the marking prescribed in § 172.315(a) or (b) of this subchapter and offered for transportation and transported by any mode. For transportation by aircraft, the package must conform to the applicable requirements of § 173.27 of this part. In addition, packages containing such articles offered for transportation by aircraft must be marked with the proper shipping name as prescribed in the § 172.101 Hazardous Materials Table of this subchapter. Packages containing such articles are not subject to the shipping paper requirements of subpart C of part 172 of this subchapter unless the material meets the definition of a hazardous substance, hazardous waste, marine pollutant, or is offered for transportation and transported by aircraft or vessel. Additionally, packages containing such articles are excepted from the requirements of subparts E (Labeling) and F (Placarding) of part 172 of this subchapter.

(ii) Until December 31, 2012, a package containing such articles may be marked with the proper shipping name “Cartridges, small arms” or “Cartridges, power device (*used to project fastening devices*)” and reclassified as “ORM–D–AIR” material if it contains properly packaged articles as authorized by this subchapter on October 1, 2010. Additionally, for transportation by aircraft, Cartridge, power devices must be successfully tested under the UN Test Series 6(d) criteria for reclassification as ORM–D–AIR material effective July 1, 2011. Until December 31,

2020, a package containing such articles may be marked with the proper shipping name “Cartridges, small arms” or “Cartridges, power device (*used to project fastening devices*),” “Cartridges for tools, blank,” and “Cases, cartridge empty with primer” and reclassified as “ORM–D” material if it contains properly packaged articles as authorized by this subchapter on October 1, 2010.

(iii) Cartridges, small arms, Cartridges, power device (*used to project fastening devices*), Cartridges for tools, blank, and Cases, cartridge empty with primer that may be shipped as a limited quantity or ORM–D material are as follows:

(A) Ammunition for rifle, pistol or shotgun;

(B) Ammunition with inert projectiles or blank ammunition;

(C) Ammunition having no tear gas, incendiary, or detonating explosive projectiles;

(D) Ammunition not exceeding 12.7 mm (50 caliber or 0.5 inch) for rifle or pistol, cartridges or 8 gauge for shotshells;

(E) Cartridges for tools, blank; and

(F) Cases, cartridge, empty with primer.

(G) Cartridges, power device (*used to project fastening devices*).

(2) Packaging for Cartridges, small arms, Cartridges for tools, blank, Cases, cartridge empty with primer, and eligible Cartridges, power device as limited quantity or ORM–D material must be as follows:

(i) Ammunition must be packed in inside boxes, or in partitions that fit snugly in the outside packaging, or in metal clips;

(ii) Primers must be protected from accidental initiation;

(iii) Inside boxes, partitions or metal clips must be packed in securely-closed strong outside packagings;

(iv) Maximum gross weight is limited to 30 kg (66 pounds) per package; and

(v) Cartridges for tools, blank, Cartridges, power devices which are used to project fastening devices, Cases, cartridge, empty with primer, and 22 caliber rim-fire cartridges may be packaged loose in strong outside packagings.

(c)–(e) [Reserved]

(f) Detonators containing no more than 1 g explosive (excluding ignition and delay charges) that are electric blasting caps with leg wires 4 feet long or longer, delay connectors in plastic sheaths, or blasting caps with empty plastic tubing 12 feet long or longer may be packed as follows in which case they are excepted from the packaging requirements of § 173.62:

(1) No more than 50 detonators in one inner packaging;

(2) IME Standard 22 container (IBR, see § 171.7 of this subchapter) or compartment is used as the outer packaging;

(3) No more than 1000 detonators in one outer packaging; and

(4) No material may be loaded on top of the IME Standard 22 container and no material may be loaded against the outside door of the IME Standard 22 compartment.

(g) Detonators that are classed as 1.4B or 1.4S and contain no more than 1 g of explosive (excluding ignition and delay charges) may be packed as follows in which case they are excepted from the packaging requirements of § 173.62:

(1) No more than 50 detonators in one inner packaging;

(2) IME Standard 22 container is used as the outer packaging;

(3) No more than 1000 detonators in one outer packaging; and

(4) Each inner packaging is marked "1.4B Detonators" or "1.4S Detonators", as appropriate.

[Amdt. 173-224, 55 FR 52617, Dec. 21, 1990, as amended at 56 FR 66268, Dec. 20, 1991; Amdt. 173-236, 58 FR 50536, Sept. 24, 1993; Amdt. 173-253, 61 FR 27175, May 30, 1996; 68 FR 75743, Dec. 31, 2003; 71 FR 14602, Mar. 22, 2006; 76 FR 3371, Jan. 19, 2011; 78 FR 1084, 1113, Jan. 7, 2013; 78 FR 65480, Oct. 31, 2013]

§ 173.64 Exceptions for Division 1.3 and 1.4 fireworks.

(a) Notwithstanding the requirements of § 173.56(b), Division 1.3 and 1.4 fireworks (see § 173.65 for Division 1.4G consumer fireworks) may be classed and approved by the Associate Administrator without prior examination and offered for transportation if the following conditions are met:

(1) The fireworks are manufactured in accordance with the applicable re-

quirements in APA Standard 87-1 (IBR, see § 171.7 of this subchapter);

(2) The device must pass a thermal stability test conducted by a third-party laboratory, or the manufacturer. The test must be performed by maintaining the device, or a representative prototype of a large device such as a display shell, at a temperature of 75 °C (167 °F) for 48 consecutive hours. When a device contains more than one component, those components that could be in physical contact with each other in the finished device must be placed in contact with each other during the thermal stability test;

(3) The manufacturer applies in writing to the Associate Administrator following the applicable requirements in APA Standard 87-1, and is notified in writing by the Associate Administrator that the fireworks have been classed, approved, and assigned an EX number. Each application must be complete and include all relevant background data and copies of all applicable drawings, test results, and any other pertinent information on each device for which approval is being requested. The manufacturer must sign the application and certify that the device for which approval is requested conforms to APA Standard 87-1, that the descriptions and technical information contained in the application are complete and accurate, and that no duplicate application has been submitted to a fireworks certification agency. If the application is denied, the manufacturer will be notified in writing of the reasons for the denial. The Associate Administrator may require that the fireworks be examined by an agency listed in § 173.56(b)(1).

(b) [Reserved]

[78 FR 42477, July 16, 2013]

§ 173.65 Exceptions for Division 1.4G consumer fireworks.

(a) Notwithstanding the requirements of §§ 173.56(b), 173.56(f), 173.56(i), and 173.64, Division 1.4G consumer fireworks may be offered for transportation provided the following conditions are met:

(1) The fireworks are manufactured in accordance with the applicable requirements in APA Standard 87-1 (IBR, see § 171.7 of this subchapter);

§ 173.115

49 CFR Ch. I (10–1–14 Edition)

(2) The device must pass a thermal stability test. The test must be performed by maintaining the device, or a representative prototype of the device, at a temperature of 75 °C (167 °F) for 48 consecutive hours. When a device contains more than one component, those components that could be in physical contact with each other in the finished device must be placed in contact with each other during the thermal stability test;

(3) The manufacturer of the Division 1.4G consumer firework applies in writing to a DOT-approved Fireworks Certification Agency, and is notified in writing by the DOT-approved Fireworks Certification Agency that the firework has been:

(i) Certified that it complies with APA Standard 87–1, and meets the requirements of this section; and

(ii) Assigned an FC number.

(4) The manufacturer’s application must be complete and include:

(i) Detailed diagram of the device;

(ii) Complete list of the chemical compositions, formulations and quantities used in the device;

(iii) Results of the thermal stability test; and

(iv) Signed certification declaring that the device for which certification is requested conforms to the APA Standard 87–1, that the descriptions and technical information contained in the application are complete and accurate, and that no duplicate applications have been submitted to PHMSA. If the application is denied, the Fireworks Certification Agency must notify the manufacturer in writing of the reasons for the denial. As detailed in the DOT-approval issued to the Fireworks Certification Agency, following the issuance of a denial from a Fireworks Certification Agency, a manufacturer may seek reconsideration from the Fireworks Certification Agency, or may appeal the reconsideration decision of the Fireworks Certification Agency to PHMSA’s Administrator.

(b) *Recordkeeping requirements.* Following the certification of each Division 1.4G consumer firework as permitted by paragraph (a) of this section, the manufacturer and importer must maintain a paper record or an electronic image of the certificate, dem-

onstrating compliance with this section. Each record must clearly provide the unique identifier assigned to the firework device and the Fireworks Certification Agency that certified the device. The record must be accessible at or through its principal place of business and be made available, upon request, to an authorized official of a Federal, State, or local government agency at a reasonable time and location. Copies of certification records must be maintained by each importer, manufacturer, or a foreign manufacturer’s U.S. agent, for five (5) years after the device is imported. The certification record must be made available to a representative of PHMSA upon request.

[78 FR 42477, July 16, 2013]

Subpart D—Definitions Classification, Packing Group Assignments and Exceptions for Hazardous Materials Other Than Class 1 and Class 7

SOURCE: Amdt. 173–224, 55 FR 52634 Dec. 21, 1990, unless otherwise noted.

§ 173.115 Class 2, Divisions 2.1, 2.2, and 2.3—Definitions.

(a) *Division 2.1 (Flammable gas).* For the purpose of this subchapter, a *flammable gas* (Division 2.1) means any material which is a gas at 20 °C (68 °F) or less and 101.3 kPa (14.7 psia) of pressure (a material which has a boiling point of 20 °C (68 °F) or less at 101.3 kPa (14.7 psia)) which—

(1) Is ignitable at 101.3 kPa (14.7 psia) when in a mixture of 13 percent or less by volume with air; or

(2) Has a flammable range at 101.3 kPa (14.7 psia) with air of at least 12 percent regardless of the lower limit. Except for aerosols, the limits specified in paragraphs (a)(1) and (a)(2) of this section shall be determined at 101.3 kPa (14.7 psia) of pressure and a temperature of 20 °C (68 °F) in accordance with the ASTM E681–85, Standard Test Method for Concentration Limits of Flammability of Chemicals or other equivalent method approved by the Associate Administrator. The flammability of aerosols is determined by the

tests specified in paragraph (1) of this section.

(b) Division 2.2 (*non-flammable, non-poisonous compressed gas—including compressed gas, liquefied gas, pressurized cryogenic gas, compressed gas in solution, asphyxiant gas and oxidizing gas*). For the purpose of this subchapter, a non-flammable, nonpoisonous compressed gas (Division 2.2) means any material (or mixture) which—

(1) Exerts in the packaging a gauge pressure of 200 kPa (29.0 psig/43.8 psia) or greater at 20 °C (68 °F), is a liquefied gas or is a cryogenic liquid, and

(2) Does not meet the definition of Division 2.1 or 2.3.

(c) Division 2.3 (*Gas poisonous by inhalation*). For the purpose of this subchapter, a *gas poisonous by inhalation* (Division 2.3) means a material which is a gas at 20 °C (68 °F) or less and a pressure of 101.3 kPa (14.7 psia) (a material which has a boiling point of 20 °C (68 °F) or less at 101.3 kPa (14.7 psia)) and which—

(1) Is known to be so toxic to humans as to pose a hazard to health during transportation, or

(2) In the absence of adequate data on human toxicity, is presumed to be toxic to humans because when tested on laboratory animals it has an LC₅₀ value of not more than 5000 mL/m³ (see §173.116(a) of this subpart for assignment of Hazard Zones A, B, C or D). LC₅₀ values for mixtures may be determined using the formula in §173.133(b)(1)(i) or CGA P-20 (IBR, see §171.7 of this subchapter).

(d) *Non-liquefied compressed gas*. A gas, which when packaged under pressure for transportation is entirely gaseous at -50 °C (-58 °F) with a critical temperature less than or equal to -50 °C (-58 °F), is considered to be a non-liquefied compressed gas.

(e) *Liquefied compressed gas*. A gas, which when packaged under pressure for transportation is partially liquid at temperatures above -50 °C (-58 °F), is considered to be a liquefied compressed gas. A liquefied compressed gas is further categorized as follows:

(1) *High pressure liquefied gas* which is a gas with a critical temperature between -50 °C (-58 °F) and + 65 °C (149 °F), and

(2) *Low pressure liquefied gas* which is a gas with a critical temperature above + 65 °C (149 °F).

(f) *Compressed gas in solution*. A *compressed gas in solution* is a non-liquefied compressed gas which is dissolved in a solvent.

(g) *Cryogenic liquid*. A *cryogenic liquid* means a refrigerated liquefied gas having a boiling point colder than -90 °C (-130 °F) at 101.3 kPa (14.7 psia) absolute. A material meeting this definition is subject to requirements of this subchapter without regard to whether it meets the definition of a non-flammable, non-poisonous compressed gas in paragraph (b) of this section.

(h) *Flammable range*. The term *flammable range* means the difference between the minimum and maximum volume percentages of the material in air that forms a flammable mixture.

(i) *Service pressure*. The term *service pressure* means the authorized pressure marking on the packaging. For example, for a cylinder marked "DOT 3A1800", the service pressure is 12410 kPa (1800 psig).

(j) *Refrigerant gas or Dispersant gas*. The terms *Refrigerant gas* and *Dispersant gas* apply to all nonpoisonous refrigerant gases; dispersant gases (fluorocarbons) listed in §172.101 of this subchapter and §§173.304, 173.314(c), 173.315(a), and 173.315(h) and mixtures thereof; and any other compressed gas having a vapor pressure not exceeding 260 psia at 54 °C(130 °F), used only as a refrigerant, dispersant, or blowing agent.

(k) For Division 2.2 gases, the oxidizing ability shall be determined by tests or by calculation in accordance with ISO 10156 (including Technical Corrigendum 1) (IBR, see §171.7 of this subchapter).

(1) The following applies to aerosols (see §171.8 of this subchapter):

(1) An aerosol must be assigned to Division 2.1 if the contents include 85% by mass or more flammable components and the chemical heat of combustion is 30 kJ/g or more;

(2) An aerosol must be assigned to Division 2.2 if the contents contain 1% by mass or less flammable components and the heat of combustion is less than 20 kJ/g.

§ 173.116

(3) Aerosols not meeting the provisions of paragraphs (1)(1) or (1)(2) of this section must be classed in accordance with the appropriate tests of the UN Manual of Tests and Criteria (IBR, see §171.7 of this subchapter). An aerosol which was tested in accordance with the requirements of this subchapter in effect on December 31, 2005, is not required to be retested.

(4) Division 2.3 gases may not be transported in an aerosol container.

(5) When the contents are classified as Division 6.1, PG III or Class 8, PG II or III, the aerosol must be assigned a subsidiary hazard of Division 6.1 or Class 8, as appropriate.

(6) Substances of Division 6.1, PG I or II, and substances of Class 8, PG I are forbidden from transportation in an aerosol container.

(7) Flammable components are Class 3 flammable liquids, Division 4.1 flammable solids, or Division 2.1 flammable gases. The chemical heat of combustion must be determined in accordance with the UN Manual of Tests and Criteria (IBR, see §171.7 of this subchapter).

[Amdt. 173–224, 55 FR 52634, Dec. 21, 1990]

EDITORIAL NOTE: For FEDERAL REGISTER citations affecting §173.115, see the List of CFR Sections Affected, which appears in the Finding Aids section of the printed volume and on GPO Access.

§ 173.116 Class 2—Assignment of hazard zone.

(a) The hazard zone of a Class 2, Division 2.3 material is assigned in column 7 of the §172.101 table. There are no hazard zones for Divisions 2.1 and 2.2. When the §172.101 table provides more than one hazard zone for a Division 2.3 material, or indicates that the hazard zone be determined on the basis of the grouping criteria for Division 2.3, the hazard zone shall be determined by applying the following criteria:

Hazard zone	Inhalation toxicity
A	LC ₅₀ less than or equal to 200 ppm.
B	LC ₅₀ greater than 200 ppm and less than or equal to 1000 ppm.
C	LC ₅₀ greater than 1000 ppm and less than or equal to 3000 ppm.
D	LC ₅₀ greater than 3000 ppm or less than or equal to 5000 ppm.

(b) The criteria specified in paragraph (a) of this section are represented graphically in §173.133, Figure 1.

[Amdt. 173–224, 55 FR 52634, Dec. 21, 1990, as amended at 56 FR 66268, Dec. 20, 1991; Amdt. 173–138, 59 FR 49133, Sept. 26, 1994; 67 FR 61013, Sept. 27, 2002]

§§ 173.117–173.119 [Reserved]

§ 173.120 Class 3—Definitions.

(a) *Flammable liquid.* For the purpose of this subchapter, a *flammable liquid* (Class 3) means a liquid having a flash point of not more than 60 °C (140 °F), or any material in a liquid phase with a flash point at or above 37.8 °C (100 °F) that is intentionally heated and offered for transportation or transported at or above its flash point in a bulk packaging, with the following exceptions:

(1) Any liquid meeting one of the definitions specified in §173.115.

(2) Any mixture having one or more components with a flash point of 60 °C (140 °F) or higher, that make up at least 99 percent of the total volume of the mixture, if the mixture is not offered for transportation or transported at or above its flash point.

(3) Any liquid with a flash point greater than 35 °C (95 °F) that does not sustain combustion according to ASTM D 4206 (IBR, see §171.7 of this subchapter) or the procedure in appendix H of this part.

(4) Any liquid with a flash point greater than 35 °C (95 °F) and with a fire point greater than 100 °C (212 °F) according to ISO 2592 (IBR, see §171.7 of this subchapter).

(5) Any liquid with a flash point greater than 35 °C (95 °F) which is in a water-miscible solution with a water content of more than 90 percent by mass.

(b) *Combustible liquid.* (1) For the purpose of this subchapter, a *combustible liquid* means any liquid that does not meet the definition of any other hazard class specified in this subchapter and has a flash point above 60 °C (140 °F) and below 93 °C (200 °F).

(2) A flammable liquid with a flash point at or above 38 °C (100 °F) that does not meet the definition of any other hazard class may be reclassified as a combustible liquid. This provision

does not apply to transportation by vessel or aircraft, except where other means of transportation is impracticable. An elevated temperature material that meets the definition of a Class 3 material because it is intentionally heated and offered for transportation or transported at or above its flash point may not be reclassified as a combustible liquid.

(3) A combustible liquid that does not sustain combustion is not subject to the requirements of this subchapter as a combustible liquid. Either the test method specified in ASTM D 4206 or the procedure in appendix H of this part may be used to determine if a material sustains combustion when heated under test conditions and exposed to an external source of flame.

(c) Flash point. (1) *Flash point* means the minimum temperature at which a liquid gives off vapor within a test vessel in sufficient concentration to form an ignitable mixture with air near the surface of the liquid. It shall be determined as follows:

(i) For a homogeneous, single-phase, liquid having a viscosity less than 45 S.U.S. at 38 °C (100 °F) that does not form a surface film while under test, one of the following test procedures shall be used:

(A) Standard Method of Test for Flash Point by Tag Closed Cup Tester, (ASTM D 56) (IBR; *see* §171.7 of this subchapter);

(B) Standard Test Methods for Flash Point of Liquids by Small Scale Closed-Cup Apparatus, (ASTM D 3278) (IBR; *see* §171.7 of this subchapter); or

(C) Standard Test Methods for Flash Point by Small Scale Closed Tester, (ASTM D 3828) (IBR; *see* §171.7 of this subchapter).

(ii) For a liquid other than one meeting all the criteria of paragraph (c)(1)(i) of this section, one of the following test procedures must be used:

(A) Standard Test Methods for Flash Point by Pensky-Martens Closed Cup Tester, (ASTM D 93) (IBR; *see* §171.7 of this subchapter). For cutback asphalt, use Method B of ASTM D 93 or alternative tests authorized in this standard;

(B) Standard Test Methods for Flash Point of Liquids by Small Scale

Closed-Cup Apparatus (ASTM D 3278) (IBR; *see* §171.7 of this subchapter);

(C) Determination of Flash/No Flash—Closed Cup Equilibrium Method (ISO 1516) (IBR; *see* §171.7 of this subchapter);

(D) Determination of Flash point—Closed Cup Equilibrium Method (ISO 1523) (IBR; *see* §171.7 of this subchapter);

(E) Determination of Flash Point—Pensky-Martens Closed Cup Method (ISO 2719) (IBR; *see* §171.7 of this subchapter);

(F) Determination of Flash Point—Rapid Equilibrium Closed Cup Method (ISO 3679) (IBR; *see* §171.7 of this subchapter);

(G) Determination of Flash/No Flash—Rapid Equilibrium Closed Cup Method (ISO 3680) (IBR; *see* §171.7 of this subchapter); or

(H) Determination of Flash Point—Abel Closed-Cup Method (ISO 13736) (IBR; *see* §171.7 of this subchapter).

(2) For a liquid that is a mixture of compounds that have different volatility and flash points, its flash point shall be determined as specified in paragraph (c)(1) of this section, on the material in the form in which it is to be shipped. If it is determined by this test that the flash point is higher than -7 °C (20 °F) a second test shall be made as follows: a portion of the mixture shall be placed in an open beaker (or similar container) of such dimensions that the height of the liquid can be adjusted so that the ratio of the volume of the liquid to the exposed surface area is 6 to one. The liquid shall be allowed to evaporate under ambient pressure and temperature (20 to 25 °C (68 to 77 °F)) for a period of 4 hours or until 10 percent by volume has evaporated, whichever comes first. A flash point is then run on a portion of the liquid remaining in the evaporation container and the lower of the two flash points shall be the flash point of the material.

(3) For flash point determinations by Setaflash closed tester, the glass syringe specified need not be used as the method of measurement of the test sample if a minimum quantity of 2 mL (0.1 ounce) is assured in the test cup.

(d) If experience or other data indicate that the hazard of a material is

§ 173.121

49 CFR Ch. I (10–1–14 Edition)

greater or less than indicated by the criteria specified in paragraphs (a) and (b) of this section, the Associate Administrator may revise the classification or make the material subject or not subject to the requirements of parts 171 through 185 of this subchapter.

(e) *Transitional provisions.* The Class 3 classification criteria in effect on December 31, 2006, may continue to be used until January 1, 2012.

[Amdt. 173–224, 55 FR 52634 Dec. 21, 1990, as amended by Amdt. 173–227, 56 FR 49989, Oct. 2, 1991; 56 FR 66268, Dec. 20, 1991; 57 FR 45461, Oct. 1, 1992; Amdt. 173–241, 59 FR 67506, 67507, Dec. 29, 1994; Amdt. 173–255, 61 FR 50625, Sept. 26, 1996; Amdt. 173–261, 62 FR 24731, May 6, 1997; 66 FR 45379, 45381, Aug. 28, 2001; 68 FR 75743, Dec. 31, 2003; 71 FR 78631, Dec. 29, 2006; 76 FR 3371, Jan. 19, 2011; 76 FR 43529, July 20, 2011; 76 FR 56316, Sept. 13, 2011]

§ 173.121 Class 3—Assignment of packing group.

(a)(1) The packing group of a Class 3 material is as assigned in column 5 of the §172.101 Table. When the §172.101 Table provides more than one packing group for a hazardous material, the packing group must be determined by applying the following criteria:

Packing group	Flash point (closed-cup)	Initial boiling point
I	≤35 °C (95 °F)
II	<23 °C (73 °F)	>35 °C (95 °F)
III	≥23 °C, ≤60 °C (≥73 °F, ≤140 °F)	>35 °C (95 °F)

(2) The initial boiling point of a Class 3 material may be determined by using one of the following test methods:

(i) Standard Test Method for Distillation of Petroleum Products at Atmospheric Pressure (ASTM D 86) (IBR; see §171.7 of this subchapter);

(ii) Standard Test Method for Distillation Range of Volatile Organic Liquids (ASTM D 1078) (IBR; see §171.7 of this subchapter);

(iii) Petroleum Products—Determination of Distillation Characteristics at Atmospheric Pressure (ISO 3405) (IBR; see §171.7 of this subchapter);

(iv) Petroleum Products—Determination of Boiling Range Distribution—Gas Chromatography Method (ISO 3924) (IBR; see §171.7 of this subchapter); or

(v) Volatile Organic Liquids—Determination of Boiling Range of Organic Solvents Used as Raw Materials (ISO 4626) (IBR; see §171.7 of this subchapter).

(b) *Criteria for inclusion of viscous Class 3 materials in Packing Group III.* (1) Viscous Class 3 materials in Packing Group II with a flash point of less than 23 °C (73 °F) may be grouped in Packing Group III provided that—

(i) Less than 3 percent of the clear solvent layer separates in the solvent separation test;

(ii) The mixture does not contain any substances with a primary or a subsidiary risk of Division 6.1 or Class 8;

(iii) The capacity of the packaging is not more than 30 L (7.9 gallons); except that for transportation by highway, rail or cargo aircraft, the capacity of the package is not more than 100 L (26.3 gallons); and

(iv) The viscosity and flash point are in accordance with the following table:

Flow time t in seconds	Jet diameter in mm	Flash point c.c.
20<=t<=60	4	above 17 °C (62.6 °F).
60<=t<=100	4	above 10 °C (50 °F).
20<=t<=32	6	above 5 °C (41 °F).
32<=t<=44	6	above –1 °C (31.2 °F).
44<=t<=100	6	above –5 °C (23 °F).
100<t	6	–5 °C (23 °F) and below.

(2) The methods by which the tests referred to in paragraph (b)(1) of this section shall be performed are as follows:

(i) *Viscosity test.* The flow time in seconds is determined at 23 °C (73.4 °F) using the ISO standard cup with a 4 mm (0.16 inch) jet as set forth in ISO 2431 (IBR, see §171.7 of this subchapter). Where the flow time exceeds 100 seconds, a further test is carried out using the ISO standard cup with a 6 mm (0.24 inch) jet.

(ii) *Solvent Separation Test.* This test is carried out at 23 °C (73 °F) using a 100.0 mL(3 ounces) measuring cylinder of the stoppered type of approximately 25.0 cm (9.8 inches) total height and of a uniform internal diameter of approximately 30 mm (1.2 inches) over the calibrated section. The sample should be stirred to obtain a uniform consistency, and poured in up to the 100 mL (3 ounces) mark. The stopper should be inserted and the cylinder left standing undisturbed for 24 hours. After 24

hours, the height of the upper separated layer should be measured and the percentage of this layer as compared with the total height of the sample calculated.

(c) *Transitional provisions.* The criteria for packing group assignments in effect on December 31, 2006, may continue to be used until January 1, 2012.

[Amdt. 173-224, 55 FR 52634, Dec. 21, 1990, as amended at 56 FR 66268, Dec. 20, 1991; Amdt. 173-241, 59 FR 67507, Dec. 29, 1994 Amdt. 173-255, 61 FR 50625, Sept. 26, 1996; 64 FR 10777, Mar. 5, 1999; 64 FR 51918, Sept. 27, 1999; 66 FR 45381, Aug. 28, 2001; 68 FR 75744, Dec. 31, 2003; 71 FR 78631, Dec. 29, 2006; 76 FR 3372, Jan. 19, 2011; 76 FR 43529, July 20, 2011; 78 FR 1085, Jan. 7, 2013]

§ 173.124 Class 4, Divisions 4.1, 4.2 and 4.3—Definitions.

(a) *Division 4.1 (Flammable Solid).* For the purposes of this subchapter, *flammable solid* (Division 4.1) means any of the following three types of materials:

(1) Desensitized explosives that—

(i) When dry are Explosives of Class 1 other than those of compatibility group A, which are wetted with sufficient water, alcohol, or plasticizer to suppress explosive properties; and

(ii) Are specifically authorized by name either in the §172.101Table or have been assigned a shipping name and hazard class by the Associate Administrator under the provisions of—

(A) A special permit issued under subchapter A of this chapter; or

(B) An approval issued under §173.56(i) of this part.

(2)(i) Self-reactive materials are materials that are thermally unstable and that can undergo a strongly exothermic decomposition even without participation of oxygen (air). A material is excluded from this definition if any of the following applies:

(A) The material meets the definition of an explosive as prescribed in subpart C of this part, in which case it must be classed as an explosive;

(B) The material is forbidden from being offered for transportation according to §172.101 of this subchapter or §173.21;

(C) The material meets the definition of an oxidizer or organic peroxide as prescribed in subpart D of this part, in which case it must be so classed;

(D) The material meets one of the following conditions:

(1) Its heat of decomposition is less than 300 J/g; or

(2) Its self-accelerating decomposition temperature (SADT) is greater than 75 °C (167 °F) for a 50 kg package; or

(3) It is an oxidizing substance in Division 5.1 containing less than 5.0% combustible organic substances; or

(E) The Associate Administrator has determined that the material does not present a hazard which is associated with a Division 4.1 material.

(ii) *Generic types.* Division 4.1 self-reactive materials are assigned to a generic system consisting of seven types. A self-reactive substance identified by technical name in the Self-Reactive Materials Table in §173.224 is assigned to a generic type in accordance with that table. Self-reactive materials not identified in the Self-Reactive Materials Table in §173.224 are assigned to generic types under the procedures of paragraph (a)(2)(iii) of this section.

(A) *Type A.* Self-reactive material type A is a self-reactive material which, as packaged for transportation, can detonate or deflagrate rapidly. Transportation of type A self-reactive material is forbidden.

(B) *Type B.* Self-reactive material type B is a self-reactive material which, as packaged for transportation, neither detonates nor deflagrates rapidly, but is liable to undergo a thermal explosion in a package.

(C) *Type C.* Self-reactive material type C is a self-reactive material which, as packaged for transportation, neither detonates nor deflagrates rapidly and cannot undergo a thermal explosion.

(D) *Type D.* Self-reactive material type D is a self-reactive material which—

(1) Detonates partially, does not deflagrate rapidly and shows no violent effect when heated under confinement;

(2) Does not detonate at all, deflagrates slowly and shows no violent effect when heated under confinement; or

(3) Does not detonate or deflagrate at all and shows a medium effect when heated under confinement.

(E) *Type E.* Self-reactive material type E is a self-reactive material which, in laboratory testing, neither detonates nor deflagrates at all and shows only a low or no effect when heated under confinement.

(F) *Type F.* Self-reactive material type F is a self-reactive material which, in laboratory testing, neither detonates in the cavitated state nor deflagrates at all and shows only a low or no effect when heated under confinement as well as low or no explosive power.

(G) *Type G.* Self-reactive material type G is a self-reactive material which, in laboratory testing, does not detonate in the cavitated state, will not deflagrate at all, shows no effect when heated under confinement, nor shows any explosive power. A type G self-reactive material is not subject to the requirements of this subchapter for self-reactive material of Division 4.1 provided that it is thermally stable (self-accelerating decomposition temperature is 50 °C (122 °F) or higher for a 50 kg (110 pounds) package). A self-reactive material meeting all characteristics of type G except thermal stability is classed as a type F self-reactive, temperature control material.

(iii) *Procedures for assigning a self-reactive material to a generic type.* A self-reactive material must be assigned to a generic type based on—

(A) Its physical state (i.e. liquid or solid), in accordance with the definition of liquid and solid in §171.8 of this subchapter;

(B) A determination as to its control temperature and emergency temperature, if any, under the provisions of §173.21(f);

(C) Performance of the self-reactive material under the test procedures specified in the UN Manual of Tests and Criteria (IBR, see §171.7 of this subchapter) and the provisions of paragraph (a)(2)(iii) of this section; and

(D) Except for a self-reactive material which is identified by technical name in the Self-Reactive Materials Table in §173.224(b) or a self-reactive material which may be shipped as a sample under the provisions of §173.224, the self-reactive material is approved in writing by the Associate Administrator. The person requesting approval

shall submit to the Associate Administrator the tentative shipping description and generic type and—

(1) All relevant data concerning physical state, temperature controls, and tests results; or

(2) An approval issued for the self-reactive material by the competent authority of a foreign government.

(iv) *Tests.* The generic type for a self-reactive material must be determined using the testing protocol from Figure 20.1 (a)-(b) (Flow Chart Scheme for Self-Reactive Substances and Organic Peroxides) from the UN Manual of Tests and Criteria (IBR, see §171.7 of this subchapter).

(3) Readily combustible solids are materials that—

(i) Are solids which may cause a fire through friction, such as matches;

(ii) Show a burning rate faster than 2.2 mm (0.087 inches) per second when tested in accordance with the UN Manual of Tests and Criteria (IBR, see §171.7 of this subchapter); or

(iii) Any metal powders that can be ignited and react over the whole length of a sample in 10 minutes or less, when tested in accordance with the UN Manual of Tests and Criteria.

(b) *Division 4.2 (Spontaneously Combustible Material).* For the purposes of this subchapter, *spontaneously combustible material* (Division 4.2) means—

(1) *A pyrophoric material.* A pyrophoric material is a liquid or solid that, even in small quantities and without an external ignition source, can ignite within five (5) minutes after coming in contact with air when tested according to UN Manual of Tests and Criteria.

(2) *Self-heating material.* A self-heating material is a material that through a process where the gradual reaction of that substance with oxygen (in air) generates heat. If the rate of heat production exceeds the rate of heat loss, then the temperature of the substance will rise which, after an induction time, may lead to self-ignition and combustion. A material of this type which exhibits spontaneous ignition or if the temperature of the sample exceeds 200 °C (392 °F) during the 24-hour test period when tested in accordance with UN Manual of Tests and Criteria

(IBR; see §171.7 of this subchapter), is classed as a Division 4.2 material.

(c) *Division 4.3 (Dangerous when wet material)*. For the purposes of this chapter, *dangerous when wet material* (Division 4.3) means a material that, by contact with water, is liable to become spontaneously flammable or to give off flammable or toxic gas at a rate greater than 1 L per kilogram of the material, per hour, when tested in accordance with UN Manual of Tests and Criteria.

[Amdt. 173-224, 55 FR 52634, Dec. 21, 1990]

EDITORIAL NOTE: For FEDERAL REGISTER citations affecting §173.124, see the List of CFR Sections Affected, which appears in the Finding Aids section of the printed volume and on GPO Access.

§ 173.125 Class 4—Assignment of packing group.

(a) The packing group of a Class 4 material is assigned in column (5) of the §172.101 Table. When the §172.101 Table provides more than one packing group for a hazardous material, the packing group shall be determined on the basis of test results following test methods given in the UN Manual of Tests and Criteria (IBR, see §171.7 of this subchapter) and by applying the appropriate criteria given in this section.

(b) Packing group criteria for readily combustible materials of Division 4.1 are as follows:

(1) Powdered, granular or pasty materials must be classified in Division 4.1 when the time of burning of one or more of the test runs, in accordance with the UN Manual of Tests and Criteria, is less than 45 seconds or the rate of burning is more than 2.2 mm/s. Powders of metals or metal alloys must be classified in Division 4.1 when they can be ignited and the reaction spreads over the whole length of the sample in 10 minutes or less.

(2) Packing group criteria for readily combustible materials of Division 4.1 are assigned as follows:

(i) For readily combustible solids (other than metal powders), Packing Group II if the burning time is less than 45 seconds and the flame passes the wetted zone. Packing Group II must be assigned to powders of metal or metal alloys if the zone of reaction

spreads over the whole length of the sample in 5 minutes or less.

(ii) For readily combustible solids (other than metal powders), Packing Group III must be assigned if the burning rate time is less than 45 seconds and the wetted zone stops the flame propagation for at least 4 minutes. Packing Group III must be assigned to metal powders if the reaction spreads over the whole length of the sample in more than 5 minutes but not more than 10 minutes.

(c) Packing group criteria for Division 4.2 materials is as follows:

(1) Pyrophoric liquids and solids of Division 4.2 are assigned to Packing Group I.

(2) A self-heating material is assigned to—

(i) Packing Group II, if the material gives a positive test result when tested with a 25 mm cube size sample at 140 °C; or

(ii) Packing Group III, if—

(A) A positive test result is obtained in a test using a 100 mm sample cube at 140 °C and a negative test result is obtained in a test using a 25 mm sample cube at 140 °C and the substance is transported in packagings with a volume of more than 3 cubic meters; or

(B) A positive test result is obtained in a test using a 100 mm sample cube at 120 °C and a negative result is obtained in a test using a 25 mm sample cube at 140 °C and the substance is transported in packagings with a volume of more than 450 L; or

(C) A positive result is obtained in a test using a 100 mm sample cube at 100 °C and a negative result is obtained in a test using a 25 mm sample cube at 140 °C and the substance is transported in packagings with a volume of less than 450 L.

(d) A Division 4.3 dangerous when wet material is assigned to—

(1) Packing Group I, if the material reacts vigorously with water at ambient temperatures and demonstrates a tendency for the gas produced to ignite spontaneously, or which reacts readily with water at ambient temperatures such that the rate of evolution of flammable gases is equal or greater than 10 L per kilogram of material over any one minute;

§ 173.127

49 CFR Ch. I (10–1–14 Edition)

(2) Packing Group II, if the material reacts readily with water at ambient temperatures such that the maximum rate of evolution of flammable gases is equal to or greater than 20 L per kilogram of material per hour, and which does not meet the criteria for Packing Group I; or

(3) Packing Group III, if the material reacts slowly with water at ambient temperatures such that the maximum rate of evolution of flammable gases is greater than 1 L per kilogram of material per hour, and which does not meet the criteria for Packing Group I or II.

[Amdt. 173–224, 55 FR 52634 Dec. 21, 1990, as amended by Amdt. 173–255, 61 FR 50625, Sept. 26, 1996; Amdt. 173–261, 62 FR 24731, May 6, 1997; 62 FR 51560, Oct. 1, 1997; 66 FR 45380, Aug. 28, 2001; 68 FR 75744, Dec. 31, 2003]

§ 173.127 Class 5, Division 5.1—Definition and assignment of packing groups.

(a) *Definition.* For the purpose of this subchapter, *oxidizer* (Division 5.1) means a material that may, generally by yielding oxygen, cause or enhance the combustion of other materials.

(1) A solid material is classed as a Division 5.1 material if, when tested in accordance with the UN Manual of Tests and Criteria (IBR, see §171.7 of this subchapter), its mean burning time is less than or equal to the burning time of a 3:7 potassium bromate/cellulose mixture.

(2) A liquid material is classed as a Division 5.1 material if, when tested in accordance with the UN Manual of Tests and Criteria, it spontaneously ignites or its mean time for a pressure rise from 690 kPa to 2070 kPa gauge is less than the time of a 1:1 nitric acid (65 percent)/cellulose mixture.

(b) *Assignment of packing groups.* (1) The packing group of a Division 5.1 material which is a solid shall be assigned using the following criteria:

(i) Packing Group I, for any material which, in either concentration tested, exhibits a mean burning time less than the mean burning time of a 3:2 potassium bromate/cellulose mixture.

(ii) Packing Group II, for any material which, in either concentration tested, exhibits a mean burning time less than or equal to the mean burning time of a 2:3 potassium bromate/cel-

lulose mixture and the criteria for Packing Group I are not met.

(iii) Packing Group III for any material which, in either concentration tested, exhibits a mean burning time less than or equal to the mean burning time of a 3:7 potassium bromate/cellulose mixture and the criteria for Packing Group I and II are not met.

(2) The packing group of a Division 5.1 material which is a liquid shall be assigned using the following criteria:

(i) Packing Group I for:

(A) Any material which spontaneously ignites when mixed with cellulose in a 1:1 ratio; or

(B) Any material which exhibits a mean pressure rise time less than the pressure rise time of a 1:1 perchloric acid (50 percent)/cellulose mixture.

(ii) Packing Group II, any material which exhibits a mean pressure rise time less than or equal to the pressure rise time of a 1:1 aqueous sodium chlorate solution (40 percent)/cellulose mixture and the criteria for Packing Group I are not met.

(iii) Packing Group III, any material which exhibits a mean pressure rise time less than or equal to the pressure rise time of a 1:1 nitric acid (65 percent)/cellulose mixture and the criteria for Packing Group I and II are not met.

[Amdt. 173–261, 62 FR 24732, May 6, 1997, as amended at 68 FR 75744, Dec. 31, 2003]

§ 173.128 Class 5, Division 5.2—Definitions and types.

(a) *Definitions.* For the purposes of this subchapter, *organic peroxide* (Division 5.2) means any organic compound containing oxygen (O) in the bivalent -O-O- structure and which may be considered a derivative of hydrogen peroxide, where one or more of the hydrogen atoms have been replaced by organic radicals, unless any of the following paragraphs applies:

(1) The material meets the definition of an explosive as prescribed in subpart C of this part, in which case it must be classed as an explosive;

(2) The material is forbidden from being offered for transportation according to §172.101 of this subchapter or §173.21;

(3) The Associate Administrator has determined that the material does not

present a hazard which is associated with a Division 5.2 material; or

(4) The material meets one of the following conditions:

(i) For materials containing no more than 1.0 percent hydrogen peroxide, the available oxygen, as calculated using the equation in paragraph (a)(4)(ii) of this section, is not more than 1.0 percent, or

(ii) For materials containing more than 1.0 percent but not more than 7.0 percent hydrogen peroxide, the available oxygen, content (O_a) is not more than 0.5 percent, when determined using the equation:

$$O_a = 16 \times \sum_{i=1}^k \frac{n_i c_i}{m_i}$$

where, for a material containing k species of organic peroxides:

n_i = number of -O-O- groups per molecule of the i th species

c_i = concentration (mass percent) of the i th species

m_i = molecular mass of the i th species

(b) *Generic types.* Division 5.2 organic peroxides are assigned to a generic system which consists of seven types. An organic peroxide identified by technical name in the Organic Peroxides Table in §173.225 is assigned to a generic type in accordance with that table. Organic peroxides not identified in the Organic Peroxides table are assigned to generic types under the procedures of paragraph (c) of this section.

(1) *Type A.* Organic peroxide type A is an organic peroxide which can detonate or deflagrate rapidly as packaged for transport. Transportation of type A organic peroxides is forbidden.

(2) *Type B.* Organic peroxide type B is an organic peroxide which, as packaged for transport, neither detonates nor deflagrates rapidly, but can undergo a thermal explosion.

(3) *Type C.* Organic peroxide type C is an organic peroxide which, as packaged for transport, neither detonates nor deflagrates rapidly and cannot undergo a thermal explosion.

(4) *Type D.* Organic peroxide type D is an organic peroxide which—

(i) Detonates only partially, but does not deflagrate rapidly and is not affected by heat when confined;

(ii) Does not detonate, deflagrates slowly, and shows no violent effect if heated when confined; or

(iii) Does not detonate or deflagrate, and shows a medium effect when heated under confinement.

(5) *Type E.* Organic peroxide type E is an organic peroxide which neither detonates nor deflagrates and shows low, or no, effect when heated under confinement.

(6) *Type F.* Organic peroxide type F is an organic peroxide which will not detonate in a cavitated state, does not deflagrate, shows only a low, or no, effect if heated when confined, and has low, or no, explosive power.

(7) *Type G.* Organic peroxide type G is an organic peroxide which will not detonate in a cavitated state, will not deflagrate at all, shows no effect when heated under confinement, and shows no explosive power. A type G organic peroxide is not subject to the requirements of this subchapter for organic peroxides of Division 5.2 provided that it is thermally stable (self-accelerating decomposition temperature is 50 °C (122 °F) or higher for a 50 kg (110 pounds) package). An organic peroxide meeting all characteristics of type G except thermal stability and requiring temperature control is classed as a type F, temperature control organic peroxide.

(c) *Procedure for assigning an organic peroxide to a generic type.* An organic peroxide shall be assigned to a generic type based on—

(1) Its physical state (i.e., liquid or solid), in accordance with the definitions for liquid and solid in §171.8 of this subchapter;

(2) A determination as to its control temperature and emergency temperature, if any, under the provisions of §173.21(f); and

(3) Performance of the organic peroxide under the test procedures specified in the UN Manual of Tests and Criteria (IBR, see §171.7 of this subchapter), and the provisions of paragraph (d) of this section.

(d) *Approvals.* (1) An organic peroxide must be approved, in writing, by the Associate Administrator, before being offered for transportation or transported, including assignment of a generic type and shipping description, except for—

§ 173.129

49 CFR Ch. I (10–1–14 Edition)

(i) An organic peroxide which is identified by technical name in the Organic Peroxides Table in §173.225(c);

(ii) A mixture of organic peroxides prepared according to §173.225(b); or

(iii) An organic peroxide which may be shipped as a sample under the provisions of §173.225(b).

(2) A person applying for an approval must submit all relevant data concerning physical state, temperature controls, and tests results or an approval issued for the organic peroxide by the competent authority of a foreign government.

(e) *Tests.* The generic type for an organic peroxide shall be determined using the testing protocol from Figure 20.1(a) (Classification and Flow Chart Scheme for Organic Peroxides) from the UN Manual of Tests and Criteria (IBR, see §171.7 of this subchapter).

[Amdt. 173–224, 55 FR 52634, Dec. 21, 1990, as amended at 56 FR 66268, Dec. 20, 1991; Amdt. 173–234, 58 FR 51532, Oct. 1, 1993; Amdt. 173–241, 59 FR 67508, Dec. 29, 1994; Amdt. 173–261, 62 FR 24732, May 6, 1997; 65 FR 58629, Sept. 29, 2000; 66 FR 8647, Feb. 1, 2001; 66 FR 45379, Aug. 28, 2001; 68 FR 75744, Dec. 31, 2003; 69 FR 76155, Dec. 20, 2004]

§ 173.129 Class 5, Division 5.2—Assignment of packing group.

All Division 5.2 materials are assigned to Packing Group II in column 5 of the §172.101 table.

§ 173.132 Class 6, Division 6.1—Definitions.

(a) For the purpose of this subchapter, *poisonous material* (Division 6.1) means a material, other than a gas, which is known to be so toxic to humans as to afford a hazard to health during transportation, or which, in the absence of adequate data on human toxicity:

(1) Is presumed to be toxic to humans because it falls within any one of the following categories when tested on laboratory animals (whenever possible, animal test data that has been reported in the chemical literature should be used):

(i) *Oral Toxicity.* A liquid or solid with an LD₅₀ for acute oral toxicity of not more than 300 mg/kg.

(ii) *Dermal Toxicity.* A material with an LD₅₀ for acute dermal toxicity of not more than 1000 mg/kg.

(iii) *Inhalation Toxicity.* (A) A dust or mist with an LC₅₀ for acute toxicity on inhalation of not more than 4 mg/L; or

(B) A material with a saturated vapor concentration in air at 20 °C (68 °F) greater than or equal to one-fifth of the LC₅₀ for acute toxicity on inhalation of vapors and with an LC₅₀ for acute toxicity on inhalation of vapors of not more than 5000 mL/m³; or

(2) Is an irritating material, with properties similar to tear gas, which causes extreme irritation, especially in confined spaces.

(b) For the purposes of this subchapter—

(1) LD₅₀ (median lethal dose) for acute oral toxicity is the statistically derived single dose of a substance that can be expected to cause death within 14 days in 50% of young adult albino rats when administered by the oral route. The LD₅₀ value is expressed in terms of mass of test substance per mass of test animal (mg/kg).

(2) LD₅₀ for acute dermal toxicity means that dose of the material which, administered by continuous contact for 24 hours with the shaved intact skin (avoiding abrading) of an albino rabbit, causes death within 14 days in half of the animals tested. The number of animals tested must be sufficient to give statistically valid results and be in conformity with good pharmacological practices. The result is expressed in mg/kg body mass.

(3) LC₅₀ for acute toxicity on inhalation means that concentration of vapor, mist, or dust which, administered by continuous inhalation for one hour to both male and female young adult albino rats, causes death within 14 days in half of the animals tested. If the material is administered to the animals as a dust or mist, more than 90 percent of the particles available for inhalation in the test must have a diameter of 10 microns or less if it is reasonably foreseeable that such concentrations could be encountered by a human during transport. The result is expressed in mg/L of air for dusts and mists or in mL/m³ of air (parts per million) for vapors. See §173.133(b) for LC₅₀ determination for mixtures and for limit tests.

(i) When provisions of this subchapter require the use of the LC₅₀ for

acute toxicity on inhalation of dusts and mists based on a one-hour exposure and such data is not available, the LC₅₀ for acute toxicity on inhalation based on a four-hour exposure may be multiplied by four and the product substituted for the one-hour LC₅₀ for acute toxicity on inhalation.

(ii) When the provisions of this subchapter require the use of the LC₅₀ for acute toxicity on inhalation of vapors based on a one-hour exposure and such data is not available, the LC₅₀ for acute toxicity on inhalation based on a four-hour exposure may be multiplied by two and the product substituted for the one-hour LC₅₀ for acute toxicity on inhalation.

(iii) A solid substance should be tested if at least 10 percent of its total mass is likely to be dust in a respirable range, e.g. the aerodynamic diameter of that particle-fraction is 10 microns or less. A liquid substance should be tested if a mist is likely to be generated in a leakage of the transport containment. In carrying out the test both for solid and liquid substances, more than 90% (by mass) of a specimen prepared for inhalation toxicity testing must be in the respirable range as defined in this paragraph (b)(3)(iii).

(c) For purposes of classifying and assigning packing groups to mixtures possessing oral or dermal toxicity hazards according to the criteria in §173.133(a)(1), it is necessary to determine the acute LD₅₀ of the mixture. If a mixture contains more than one active constituent, one of the following methods may be used to determine the oral or dermal LD₅₀ of the mixture:

(1) Obtain reliable acute oral and dermal toxicity data on the actual mixture to be transported;

(2) If reliable, accurate data is not available, classify the formulation according to the most hazardous constituent of the mixture as if that constituent were present in the same concentration as the total concentration of all active constituents; or

(3) If reliable, accurate data is not available, apply the formula:

$$\frac{C_{A+}}{T_A} + \frac{C_B}{T_B} + \frac{C_Z}{T_Z} = \frac{100}{T_M}$$

where:

C = the % concentration of constituent A, B ... Z in the mixture;

T = the oral LD₅₀ values of constituent A, B ... Z;

T_M = the oral LD₅₀ value of the mixture.

NOTE TO FORMULA IN PARAGRAPH (c)(3): This formula also may be used for dermal toxicities provided that this information is available on the same species for all constituents. The use of this formula does not take into account any potentiation or protective phenomena.

(d) The foregoing categories shall not apply if the Associate Administrator has determined that the physical characteristics of the material or its probable hazards to humans as shown by documented experience indicate that the material will not cause serious sickness or death.

[Amdt. 173-224, 55 FR 52634, Dec. 21, 1990, as amended at 56 FR 66268, Dec. 20, 1991; Amdt. 173-234, 58 FR 51532, Oct. 1, 1993; Amdt. 173-261, 62 FR 24732, May 6, 1997; 62 FR 45702, Aug. 28, 1997; 65 FR 58629, Sept. 29, 2000; 66 FR 45379, 45382, Aug. 28, 2001; 69 FR 76155, Dec. 20, 2004; 72 FR 55692, Oct. 1, 2007; 76 FR 43529, July 20, 2011]

§ 173.133 Assignment of packing group and hazard zones for Division 6.1 materials.

(a) The packing group of Division 6.1 materials shall be as assigned in column 5 of the §172.101 table. When the §172.101 table provides more than one packing group or hazard zone for a hazardous material, the packing group and hazard zone shall be determined by applying the following criteria:

(1) The packing group assignment for routes of administration other than inhalation of vapors shall be in accordance with the following table:

Packing group	Oral toxicity LD ₅₀ (mg/kg)	Dermal toxicity LD ₅₀ (mg/kg)	Inhalation toxicity by dusts and mists LC ₅₀ (mg/L)
I	≤5.0	≤50	≤0.2
II	>5.0 and ≤50	>50 and ≤200	>0.2 and ≤2.0
III	>50 and ≤300	>200 and ≤1000	>2.0 and ≤4.0

§ 173.133

49 CFR Ch. I (10–1–14 Edition)

(2)(i) The packing group and hazard zone assignments for liquids (see §173.115(c) of this subpart for gases) based on inhalation of vapors shall be in accordance with the following table:

Packing Group	Vapor concentration and toxicity
I (Hazard Zone A)	$V \geq 500$ LC ₅₀ and LC ₅₀ ≤ 200 mL/M ³ .
I (Hazard Zone B)	$V \geq 10$ LC ₅₀ ; LC ₅₀ ≤ 1000 mL/m ³ ; and the criteria for Packing Group I, Hazard Zone A are not met.
II	$V \geq$ LC ₅₀ ; LC ₅₀ ≤ 3000 mL/m ³ ; and the criteria for Packing Group I, are not met.
III	$V \geq 2$ LC ₅₀ ; LC ₅₀ ≤ 5000 mL/m ³ ; and the criteria for Packing Groups I and II, are not met.

NOTE 1: V is the saturated vapor concentration in air of the material in mL/m³ at 20 °C and standard atmospheric pressure.
 NOTE 2: A liquid in Division 6.1 meeting criteria for Packing Group I, Hazard Zones A or B stated in paragraph (a)(2) of this section is a material poisonous by inhalation subject to the additional hazard communication requirements in §§ 172.203(m), 172.313 and table 1 of § 172.504(e) of this subchapter.

(ii) These criteria are represented graphically in Figure 1:

**Figure 1
Inhalation Toxicity: Packing Group and
Hazard Zone Borderlines**

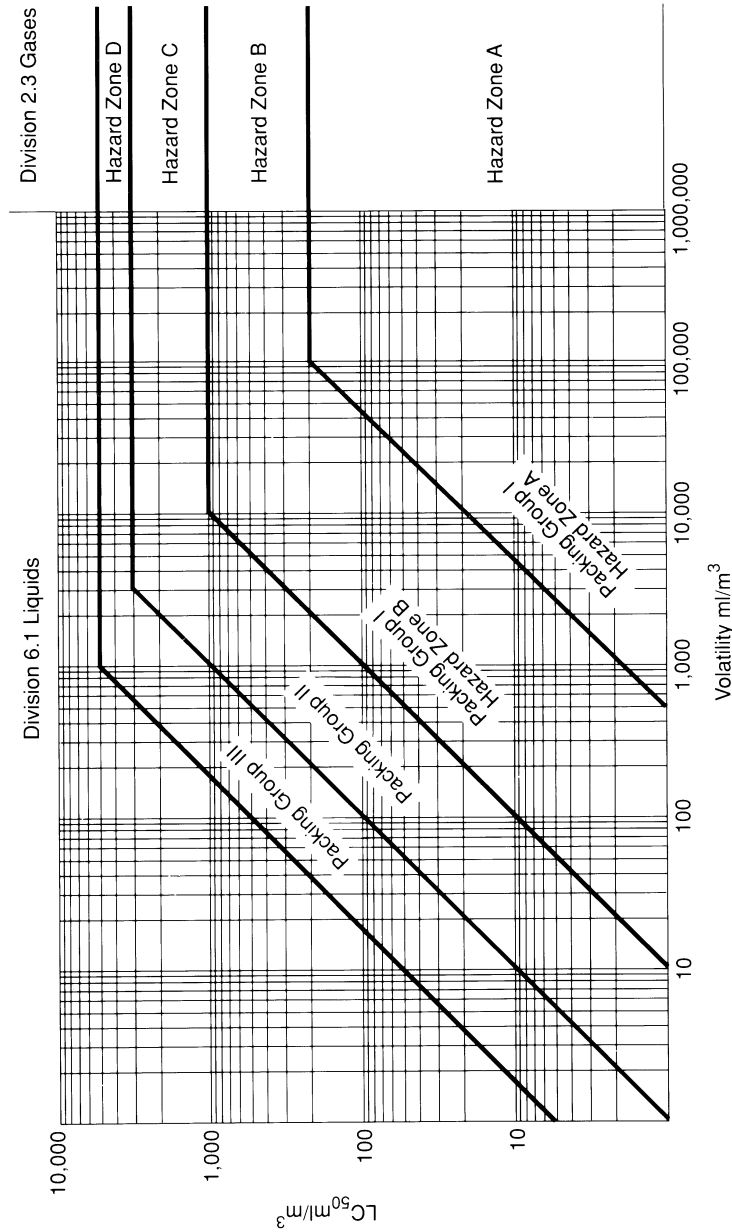

(3) When the packing group determined by applying these criteria is different for two or more (oral, dermal or inhalation) routes of administration,

the packing group assigned to the material shall be that indicated for the highest degree of toxicity for any of the routes of administration.

§ 173.133

49 CFR Ch. I (10–1–14 Edition)

(4) Notwithstanding the provisions of this paragraph, the packing group and hazard zone of a tear gas substance is as assigned in column 5 of the §172.101 table.

(b) The packing group and hazard zone for Division 6.1 mixtures that are poisonous (toxic) by inhalation may be determined by one of the following methods:

(1) Where LC₅₀ data is available on each of the poisonous (toxic) substances comprising the mixture—

(i) The LC₅₀ of the mixture is estimated using the formula:

$$LC_{50}(\text{mixture}) = \frac{1}{\sum_{i=1}^n \frac{f_i}{LC_{50i}}}$$

where

f_i = mole fraction of the ith component substance of the liquid.

LC_{50i} = mean lethal concentration of the ith component substance in mL/m³

(ii) The volatility of each component substance is estimated using the formula:

$$V_i = P_i \times \frac{10^6}{101.3} \text{ mL/m}^3$$

where:

P_i = partial pressure of the ith component substance in kPa at 20 °C and one atmospheric pressure. P_i may be calculated according to Raoult's Law using appropriate activity coefficients. Where activity coefficients are not available, the coefficient may be assumed to be 1.0.

(iii) The ratio of the volatility to the LC₅₀ is calculated using the formula:

$$R = \sum_{i=1}^n \frac{V_i}{LC_{50i}}$$

(iv) Using the calculated values LC₅₀ (mixture) and R, the packing group for the mixture is determined as follows:

Packaging group (hazard zone)	Ratio of volatility and LC ₅₀
I (Hazard Zone A) ..	R ≥500 and LC ₅₀ (mixture) ≤200 mL/m ³ .
I (Hazard Zone B) ..	R ≥10 and LC ₅₀ (mixture) ≤1000 mL/m ³ ; and the criteria for Packing Group I, Hazard Zone A are not met.
II	R ≥1 and LC ₅₀ (mixture) ≤3000 mL/m ³ ; and the criteria for Packing Group I, Hazard Zones A and B are not met.

Packaging group (hazard zone)	Ratio of volatility and LC ₅₀
III	R ≥1/5 and LC ₅₀ (mixture) ≤5000 mL/m ³ ; and the criteria for Packing Group I, Hazard Zones A and B and Packing Group II are not met.

(2) In the absence of LC₅₀ data on the poisonous (toxic) constituent substances, the mixture may be assigned a packing group and hazard zone based on the following simplified threshold toxicity tests. When these threshold tests are used, the most restrictive packing group and hazard zone must be determined and used for the transportation of the mixture.

(i) A mixture is assigned to Packing Group I, Hazard Zone A only if both the following criteria are met:

(A) A sample of the liquid mixture is vaporized and diluted with air to create a test atmosphere of 200 mL/m³ vaporized mixture in air. Ten albino rats (five male and five female) are exposed to the test atmosphere as determined by an analytical method appropriate for the material being classified for one hour and observed for fourteen days. If five or more of the animals die within the fourteen-day observation period, the mixture is presumed to have an LC₅₀ equal to or less than 200 mL/m³.

(B) A sample of the vapor in equilibrium with the liquid mixture is diluted with 499 equal volumes of air to form a test atmosphere. Ten albino rats (five male and five female) are exposed to the test atmosphere for one hour and observed for fourteen days. If five or more of the animals die within the fourteen-day observation period, the mixture is presumed to have a volatility equal to or greater than 500 times the mixture LC₅₀.

(ii) A mixture is assigned to Packing Group I, Hazard Zone B only if both the following criteria are met, and the mixture does not meet the criteria for Packing Group I, Hazard Zone A:

(A) A sample of the liquid mixture is vaporized and diluted with air to create a test atmosphere of 1000 mL/m³ vaporized mixture in air. Ten albino rats (five male and five female) are exposed to the test atmosphere for one hour and observed for fourteen days. If five or more of the animals die within the fourteen-day observation period, the

mixture is presumed to have an LC₅₀ equal to or less than 1000 mL/m³.

(B) A sample of the vapor in equilibrium with the liquid mixture is diluted with 9 equal volumes of air to form a test atmosphere. Ten albino rats (five male and five female) are exposed to the test atmosphere for one hour and observed for fourteen days. If five or more of the animals die within the fourteen-day observation period, the mixture is presumed to have a volatility equal to or greater than 10 times the mixture LC₅₀.

(iii) A mixture is assigned to Packing Group II only if both the following criteria are met, and the mixture does not meet the criteria for Packing Group I (Hazard Zones A or B):

(A) A sample of the liquid mixture is vaporized and diluted with air to create a test atmosphere of 3000 mL/m³ vaporized mixture in air. Ten albino rats (five male and five female) are exposed to the test atmosphere for one hour and observed for fourteen days. If five or more of the animals die within the fourteen-day observation period, the mixture is presumed to have an LC₅₀ equal to or less than 3000 mL/m³.

(B) A sample of the vapor in equilibrium with the liquid mixture is used to form a test atmosphere. Ten albino rats (five male and five female) are exposed to the test atmosphere for one hour and observed for fourteen days. If five or more of the animals die within the fourteen-day observation period, the mixture is presumed to have a volatility equal to or greater than the mixture LC₅₀.

(iv) A mixture is assigned to Packing Group III only if both the following criteria are met, and the mixture does not meet the criteria for Packing Groups I (Hazard Zones A or B) or Packing Group II (Hazard Zone C):

(A) A sample of the liquid mixture is vaporized and diluted with air to create a test atmosphere of 5000 mL/m³ vaporized mixture in air. Ten albino rats (five male and five female) are exposed to the test atmosphere for one hour and observed for fourteen days. If five or more of the animals die within the fourteen-day observation period, the mixture is presumed to have an LC₅₀ equal to or less than 5000 mL/m³.

(B) The vapor pressure of the liquid mixture is measured and if the vapor concentration is equal to or greater than 1000 mL/m³, the mixture is presumed to have a volatility equal to or greater than 1/5 the mixture LC₅₀.

(c) *Transitional provisions.* The criteria for packing group assignments in effect on December 31, 2006, may continue to be used until January 1, 2012.

[Amdt. 173-224, 55 FR 52634, Dec. 21, 1990, as amended at 56 FR 66268, Dec. 20, 1991; 57 FR 45461, Oct. 1, 1992; Amdt. 173-234, 58 FR 51532, Oct. 1, 1993; Amdt. 173-138, 59 FR 49133, Sept. 26, 1994; Amdt. 173-255, 61 FR 50626, Sept. 26, 1996; 66 FR 45183, 45380, Aug. 28, 2001; 66 FR 49556, Sept. 28, 2001; 69 FR 54046, Sept. 7, 2004; 71 FR 54395, Sept. 14, 2006; 71 FR 78631, Dec. 29, 2006; 74 FR 53188, Oct. 16, 2009; 76 FR 43529, July 20, 2011]

§ 173.134 Class 6, Division 6.2—Definitions and exceptions.

(a) *Definitions and classification criteria.* For the purposes of this subchapter, the following definitions and classification criteria apply to Division 6.2 materials.

(1) *Division 6.2 (Infectious substance)* means a material known or reasonably expected to contain a pathogen. A pathogen is a microorganism (including bacteria, viruses, rickettsiae, parasites, fungi) or other agent, such as a proteinaceous infectious particle (prion), that can cause disease in humans or animals. An infectious substance must be assigned the identification number UN 2814, UN 2900, UN 3373, or UN 3291 as appropriate, and must be assigned to one of the following categories:

(i) *Category A:* An infectious substance in a form capable of causing permanent disability or life-threatening or fatal disease in otherwise healthy humans or animals when exposure to it occurs. An exposure occurs when an infectious substance is released outside of its protective packaging, resulting in physical contact with humans or animals. A Category A infectious substance must be assigned to identification number UN 2814 or UN 2900, as appropriate. Assignment to UN 2814 or UN 2900 must be based on the known medical history or symptoms of the source patient or animal, endemic

local conditions, or professional judgment concerning the individual circumstances of the source human or animal.

(ii) *Category B*: An infectious substance that is not in a form generally capable of causing permanent disability or life-threatening or fatal disease in otherwise healthy humans or animals when exposure to it occurs. This includes Category B infectious substances transported for diagnostic or investigational purposes. A Category B infectious substance must be described as “Biological substance, Category B” and assigned identification number UN 3373. This does not include regulated medical waste, which must be assigned identification number UN 3291.

(2) *Biological product* means a virus, therapeutic serum, toxin, antitoxin, vaccine, blood, blood component or derivative, allergenic product, or analogous product, or arsphenamine or derivative of arsphenamine (or any other trivalent arsenic compound) applicable to the prevention, treatment, or cure of a disease or condition of human beings or animals. A *biological product* includes a material subject to regulation under 42 U.S.C. 262 or 21 U.S.C. 151–159. Unless otherwise excepted, a *biological product* known or reasonably expected to contain a pathogen that meets the definition of a Category A or B infectious substance must be assigned the identification number UN 2814, UN 2900, or UN 3373, as appropriate.

(3) *Culture* means an infectious substance containing a pathogen that is intentionally propagated. *Culture* does not include a human or animal patient specimen as defined in paragraph (a)(4) of this section.

(4) *Patient specimen* means human or animal material collected directly from humans or animals and transported for research, diagnosis, investigational activities, or disease treatment or prevention. *Patient specimen* includes excreta, secretions, blood and its components, tissue and tissue swabs, body parts, and specimens in transport media (e.g., transwabs, culture media, and blood culture bottles).

(5) *Regulated medical waste or clinical waste or (bio) medical waste* means a

waste or reusable material derived from the medical treatment of an animal or human, which includes diagnosis and immunization, or from biomedical research, which includes the production and testing of biological products. Regulated medical waste or clinical waste or (bio) medical waste containing a Category A infectious substance must be classed as an infectious substance, and assigned to UN2814 or UN2900, as appropriate.

(6) *Sharps* means any object contaminated with a pathogen or that may become contaminated with a pathogen through handling or during transportation and also capable of cutting or penetrating skin or a packaging material. *Sharps* includes needles, syringes, scalpels, broken glass, culture slides, culture dishes, broken capillary tubes, broken rigid plastic, and exposed ends of dental wires.

(7) *Toxin* means a Division 6.1 material from a plant, animal, or bacterial source. A *toxin* containing an infectious substance or a *toxin* contained in an infectious substance must be classed as Division 6.2, described as an infectious substance, and assigned to UN 2814 or UN 2900, as appropriate.

(8) *Used health care product* means a medical, diagnostic, or research device or piece of equipment, or a personal care product used by consumers, medical professionals, or pharmaceutical providers that does not meet the definition of a patient specimen, biological product, or regulated medical waste, is contaminated with potentially infectious body fluids or materials, and is not decontaminated or disinfected to remove or mitigate the infectious hazard prior to transportation.

(b) *Exceptions*. The following are not subject to the requirements of this subchapter as Division 6.2 materials:

(1) A material that does not contain an infectious substance or that is unlikely to cause disease in humans or animals.

(2) Non-infectious biological materials from humans, animals, or plants. Examples include non-infectious cells, tissue cultures, blood or plasma from individuals not suspected of having an infectious disease, DNA, RNA or other non-infectious genetic elements.

(3) A material containing micro-organisms that are non-pathogenic to humans or animals.

(4) A material containing pathogens that have been neutralized or inactivated such that they no longer pose a health risk.

(5) A material with a low probability of containing an infectious substance, or where the concentration of the infectious substance is at a level naturally occurring in the environment so it cannot cause disease when exposure to it occurs. Examples of these materials include: Foodstuffs; environmental samples, such as water or a sample of dust or mold; and substances that have been treated so that the pathogens have been neutralized or deactivated, such as a material treated by steam sterilization, chemical disinfection, or other appropriate method, so it no longer meets the definition of an infectious substance.

(6) A biological product, including an experimental or investigational product or component of a product, subject to Federal approval, permit, review, or licensing requirements, such as those required by the Food and Drug Administration of the U.S. Department of Health and Human Services or the U.S. Department of Agriculture.

(7) Blood collected for the purpose of blood transfusion or the preparation of blood products; blood products; plasma; plasma derivatives; blood components; tissues or organs intended for use in transplant operations; and human cell, tissues, and cellular and tissue-based products regulated under authority of the Public Health Service Act (42 U.S.C. 264-272) and/or the Food, Drug, and Cosmetic Act (21 U.S.C. 332 *et seq.*).

(8) Blood, blood plasma, and blood components collected for the purpose of blood transfusion or the preparation of blood products and sent for testing as part of the collection process, except where the person collecting the blood has reason to believe it contains an infectious substance, in which case the test sample must be shipped as a Category A or Category B infectious substance in accordance with §173.196 or §173.199, as appropriate.

(9) Dried blood spots or specimens for fecal occult blood detection placed on

absorbent filter paper or other material.

(10) A Division 6.2 material, other than a Category A infectious substance, contained in a patient sample being transported for research, diagnosis, investigational activities, or disease treatment or prevention, or a biological product, when such materials are transported by a private or contract carrier in a motor vehicle used exclusively to transport such materials. Medical or clinical equipment and laboratory products may be transported aboard the same vehicle provided they are properly packaged and secured against exposure or contamination. If the human or animal sample or biological product meets the definition of regulated medical waste in paragraph (a)(5) of this section, it must be offered for transportation and transported in conformance with the appropriate requirements for regulated medical waste.

(11) A human or animal sample (including, but not limited to, secreta, excreta, blood and its components, tissue and tissue fluids, and body parts) being transported for routine testing not related to the diagnosis of an infectious disease, such as for drug/alcohol testing, cholesterol testing, blood glucose level testing, prostate specific antibody testing, testing to monitor kidney or liver function, or pregnancy testing, or for tests for diagnosis of non-infectious diseases, such as cancer biopsies, and for which there is a low probability the sample is infectious.

(12) Laundry and medical equipment and used health care products, as follows:

(i) Laundry or medical equipment conforming to the regulations of the Occupational Safety and Health Administration of the Department of Labor in 29 CFR 1910.1030. This exception includes medical equipment intended for use, cleaning, or refurbishment, such as reusable surgical equipment, or equipment used for testing where the components within which the equipment is contained essentially function as packaging. This exception does not apply to medical equipment being transported for disposal.

(ii) Used health care products not conforming to the requirements in 29

§ 173.134

49 CFR Ch. I (10–1–14 Edition)

CFR 1910.1030 and being returned to the manufacturer or the manufacturer's designee are excepted from the requirements of this subchapter when offered for transportation or transported in accordance with this paragraph (b)(12). For purposes of this paragraph, a health care product is used when it has been removed from its original packaging. Used health care products contaminated with or suspected of contamination with a Category A infectious substance may not be transported under the provisions of this paragraph.

(A) Each used health care product must be drained of free liquid to the extent practicable and placed in a watertight primary container designed and constructed to assure that it remains intact under conditions normally incident to transportation. For a used health care product capable of cutting or penetrating skin or packaging material, the primary container must be capable of retaining the product without puncture of the packaging under normal conditions of transport. Each primary container must be marked with a BIOHAZARD marking conforming to 29 CFR 1910.1030(g)(1)(i).

(B) Each primary container must be placed inside a watertight secondary container designed and constructed to assure that it remains intact under conditions normally incident to transportation. The secondary container must be marked with a BIOHAZARD marking conforming to 29 CFR 1910.1030(g)(1)(i).

(C) The secondary container must be placed inside an outer packaging with sufficient cushioning material to prevent movement between the secondary container and the outer packaging. An itemized list of the contents of the primary container and information concerning possible contamination with a Division 6.2 material, including its possible location on the product, must be placed between the secondary container and the outside packaging.

(D) Each person who offers or transports a used health care product under the provisions of this paragraph must know about the requirements of this paragraph.

(13) Any waste or recyclable material, other than regulated medical waste, including—

(i) Household waste as defined in §171.8, when transported in accordance with applicable state, local, or tribal requirements.

(ii) Sanitary waste or sewage;

(iii) Sewage sludge or compost;

(iv) Animal waste generated in animal husbandry or food production; or

(v) Medical waste generated from households and transported in accordance with applicable state, local, or tribal requirements.

(14) Corpses, remains, and anatomical parts intended for interment, cremation, or medical research at a college, hospital, or laboratory.

(15) Forensic material transported on behalf of a U.S. Government, state, local or Indian tribal government agency, except that—

(i) Forensic material known or suspected to contain a Category B infectious substance must be shipped in a packaging conforming to the provisions of §173.24.

(ii) Forensic material known or suspected to contain a Category A infectious substance or an infectious substance listed as a select agent in 42 CFR part 73 must be transported in packaging capable of meeting the test standards in §178.609 of this subchapter. The secondary packaging must be marked with a BIOHAZARD symbol conforming to specifications in 29 CFR 1910.1030(g)(1)(i). An itemized list of contents must be enclosed between the secondary packaging and the outer packaging.

(16) Agricultural products and food as defined in the Federal Food, Drug, and Cosmetics Act (21 U.S.C. 332 *et seq.*).

(c) *Exceptions for regulated medical waste.* The following provisions apply to the transportation of regulated medical waste:

(1) A regulated medical waste transported by a private or contract carrier is excepted from—

(i) The requirement for an "INFECTIOUS SUBSTANCE" label if the outer packaging is marked with a "BIOHAZARD" marking in accordance with 29 CFR 1910.1030; and

(ii) The specific packaging requirements of §173.197, if packaged in a rigid non-bulk packaging conforming to the general packaging requirements of

§§ 173.24 and 173.24a and packaging requirements specified in 29 CFR 1910.1030, provided the material does not include a waste concentrated stock culture of an infectious substance. Sharps containers must be securely closed to prevent leaks or punctures.

(2) The following materials may be offered for transportation and transported as a regulated medical waste when packaged in a rigid non-bulk packaging conforming to the general packaging requirements of §§ 173.24 and 173.24a and packaging requirements specified in 29 CFR 1910.1030 and transported by a private or contract carrier in a vehicle used exclusively to transport regulated medical waste:

- (i) Waste stock or culture of a Category B infectious substance;
- (ii) Plant and animal waste regulated by the Animal and Plant Health Inspection Service (APHIS);
- (iii) Waste pharmaceutical materials;
- (iv) Laboratory and recyclable wastes;
- (v) Infectious substances that have been treated to eliminate or neutralize pathogens;
- (vi) Forensic materials being transported for final destruction;
- (vii) Rejected or recalled health care products;
- (viii) Documents intended for destruction in accordance with the Health Insurance Portability and Accountability Act of 1996 (HIPAA) requirements;
- (ix) Medical or clinical equipment and laboratory products provided they are properly packaged and secured against exposure or contamination; or
- (x) Sharps in sharp containers provided the containers are securely closed to prevent leaks or punctures; do not exceed 18 gallons capacity; registered under the Medical Device Regulations of FDA; made of puncture resistant plastic that meets ASTM Standard F2132-01, Standard Specification for Puncture Resistance of Materials Used in Containers for Discarded Medical Needles and Other Sharps; and are securely fitted into wheeled racks that hold them in an upright position. The wheeled racks must contain full rows of sharps containers secured in place by a moveable bar; and must be securely held in place on the motor ve-

hicle by straps or load bars during transportation. No shelf in any wheeled rack may exceed the manufacturer's recommended load capacity.

(d) If an item listed in paragraph (b) or (c) of this section meets the definition of another hazard class or if it is a hazardous substance, hazardous waste, or marine pollutant, it must be offered for transportation and transported in accordance with applicable requirements of this subchapter.

(e) *Transitional provisions.* The authorization for continued use of the criteria for packing group assignments in effect on December 31, 2006 ended on January 1, 2012.

[67 FR 53138, Aug. 14, 2002, as amended at 68 FR 57632, Oct. 6, 2003; 70 FR 56098, Sept. 23, 2005; 71 FR 32258, June 2, 2006; 71 FR 78631, Dec. 29, 2006; 72 FR 55692, Oct. 1, 2007; 73 FR 4718, Jan. 28, 2008; 74 FR 2257, Jan. 14, 2009; 76 FR 43530, July 20, 2011; 77 FR 60942, Oct. 5, 2012; 78 FR 15327, Mar. 11, 2013]

§ 173.136 Class 8—Definitions.

(a) For the purpose of this subchapter, "corrosive material" (Class 8) means a liquid or solid that causes full thickness destruction of human skin at the site of contact within a specified period of time. A liquid, or a solid which may become liquid during transportation, that has a severe corrosion rate on steel or aluminum based on the criteria in § 173.137(c)(2) is also a corrosive material. Whenever practical, *in vitro* test methods authorized in § 173.137 of this part or historical data authorized in paragraph (c) of this section should be used to determine whether a material is corrosive.

(b) If human experience or other data indicate that the hazard of a material is greater or less than indicated by the results of the tests specified in paragraph (a) of this section, PHMSA may revise its classification or make the determination that the material is not subject to the requirements of this subchapter.

(c) Skin corrosion test data produced no later than September 30, 1995, using the procedures of part 173, appendix A, in effect on September 30, 1995 (see 49 CFR part 173, appendix A, revised as of

§ 173.137

October 1, 1994) for appropriate exposure times may be used for classification and assignment of packing group for Class 8 materials corrosive to skin.

[Amdt. 173-224, 55 FR 52634, Dec. 21, 1990, as amended at 56 FR 66270, Dec. 20, 1991; Amdt. 173-234, 58 FR 51532, Oct. 1, 1993; Amdt. 173-241, 59 FR 67508, Dec. 29, 1994; Amdt. 173-261, 62 FR 24732, May 6, 1997; 69 FR 76155, Dec. 20, 2004; 71 FR 78631, Dec. 29, 2006; 76 FR 3372, Jan. 19, 2011]

§ 173.137 Class 8—Assignment of packing group.

The packing group of a Class 8 material is indicated in Column 5 of the §172.101 Table. When the §172.101 Table provides more than one packing group for a Class 8 material, the packing group must be determined using data obtained from tests conducted in accordance with the OECD Guideline for the Testing of Chemicals, Number 435, “*In Vitro* Membrane Barrier Test Method for Skin Corrosion” (IBR, *see* §171.7 of this subchapter) or Number 404, “Acute Dermal Irritation/Corrosion” (IBR, *see* §171.7 of this subchapter). A material that is determined not to be corrosive in accordance with OECD Guideline for the Testing of Chemicals, Number 430, “*In Vitro* Skin Corrosion: Transcutaneous Electrical Resistance Test (TER)” (IBR, *see* §171.7 of this subchapter) or Number 431, “*In Vitro* Skin Corrosion: Human Skin Model Test” (IBR, *see* §171.7 of this subchapter) may be considered not to be corrosive to human skin for the purposes of this subchapter without further testing. However, a material determined to be corrosive in accordance with Number 430 or Number 431 must be further tested using Number 435 or Number 404. The packing group assignment using data obtained from tests conducted in accordance with OECD Guideline Number 404 or Number 435 must be as follows:

(a) *Packing Group I*. Materials that cause full thickness destruction of intact skin tissue within an observation period of up to 60 minutes starting after the exposure time of three minutes or less.

(b) *Packing Group II*. Materials other than those meeting Packing Group I criteria that cause full thickness destruction of intact skin tissue within

49 CFR Ch. I (10–1–14 Edition)

an observation period of up to 14 days starting after the exposure time of more than three minutes but not more than 60 minutes.

(c) *Packing Group III*. Materials, other than those meeting Packing Group I or II criteria—

(1) That cause full thickness destruction of intact skin tissue within an observation period of up to 14 days starting after the exposure time of more than 60 minutes but not more than 4 hours; or

(2) That do not cause full thickness destruction of intact skin tissue but exhibit a corrosion on either steel or aluminum surfaces exceeding 6.25 mm (0.25 inch) a year at a test temperature of 55 °C (130 °F) when tested on both materials. The corrosion may be determined in accordance with the UN Manual of Tests and Criteria (IBR, *see* §171.7 of this subchapter) or other equivalent test methods.

NOTE TO §173.137: When an initial test on either a steel or aluminum surface indicates the material being tested is corrosive, the follow up test on the other surface is not required.

[Amdt. 173-224, 55 FR 52634, Dec. 21, 1990, as amended at 56 FR 66270, Dec. 20, 1991; Amdt. 173-241, 59 FR 67508, Dec. 29, 1994; Amdt. 173-261, 62 FR 24733, May 6, 1997; 68 FR 75744, Dec. 31, 2003; 69 FR 76155, Dec. 20, 2004; 71 FR 78631, Dec. 29, 2006; 74 FR 2257, Jan. 14, 2009; 76 FR 3372, Jan. 19, 2011]

§ 173.140 Class 9—Definitions.

For the purposes of this subchapter, *miscellaneous hazardous material* (Class 9) means a material which presents a hazard during transportation but which does not meet the definition of any other hazard class. This class includes:

(a) Any material which has an anesthetic, noxious or other similar property which could cause extreme annoyance or discomfort to a flight crew member so as to prevent the correct performance of assigned duties; or

(b) Any material that meets the definition in §171.8 of this subchapter for an elevated temperature material, a hazardous substance, a hazardous waste, or a marine pollutant.

[Amdt. 173-224, 57 FR 45463, Oct. 1, 1992, as amended by Amdt. 173-231, 57 FR 52939, Nov. 5, 1992; Amdt. 173-233, 58 FR 33305, June 16, 1993]

§ 173.141 Class 9—Assignment of packing group.

The packing group of a Class 9 material is as indicated in column 5 of the §172.101 table.

§ 173.144 Other Regulated Material (ORM)—Definitions.

Until December 31, 2020 and for the purposes of this subchapter, “ORM-D material” means a material such as a Consumer commodity, Cartridges, small arms, Cartridges, power devices (*used to project fastening devices*), Cartridges for tools, blank, and Cases, cartridge, empty with primer, which, although otherwise subject to the regulations of this subchapter, presents a limited hazard during transportation due to its form, quantity and packaging. The article or substance must be a material for which exceptions are provided in Column (8A) of the §172.101 Hazardous Materials Table.

[78 FR 65481, Oct. 31, 2013]

§ 173.145 Other Regulated Materials—Assignment of packing group.

Packing groups are not assigned to ORM-D materials.

§ 173.150 Exceptions for Class 3 (flammable and combustible liquids).

(a) *General.* Exceptions for hazardous materials shipments in the following paragraphs are permitted only if this section is referenced for the specific hazardous material in the §172.101 Table of this subchapter.

(b) *Limited quantities.* Limited quantities of flammable liquids (Class 3) and combustible liquids are excepted from labeling requirements, unless the material is offered for transportation or transported by aircraft, and are excepted from the specification packaging requirements of this subchapter when packaged in combination packagings according to this paragraph. For transportation by aircraft, the package must also conform to applicable requirements of §173.27 of this part (*e.g.*, authorized materials, inner packaging quantity limits and closure securement) and only hazardous material authorized aboard passenger-carrying aircraft may be transported as a limited quantity. A limited quantity package

that conforms to the provisions of this section is not subject to the shipping paper requirements of subpart C of part 172 of this subchapter, unless the material meets the definition of a hazardous substance, hazardous waste, marine pollutant, or is offered for transportation and transported by aircraft or vessel, and is eligible for the exceptions provided in §173.156 of this part. In addition, shipments of limited quantities are not subject to subpart F (Placarding) of part 172 of this subchapter. Each package must conform to the packaging requirements of subpart B of this part and may not exceed 30 kg (66 pounds) gross weight. Except for transportation by aircraft, the following combination packagings are authorized:

(1) For flammable liquids in Packing Group I, inner packagings not over 0.5 L (0.1 gallon) net capacity each, packed in a strong outer packaging;

(2) For flammable liquids in Packing Group II, inner packagings not over 1.0 L (0.3 gallons) net capacity each, packed in a strong outer packaging.

(3) For flammable liquids in Packing Group III and combustible liquids, inner packagings not over 5.0 L (1.3 gallons) net capacity each, packed in a strong outer packaging.

(c) *Consumer commodities.* Until December 31, 2020, a limited quantity package containing a “consumer commodity” as defined in §171.8 of this subchapter, may be renamed “Consumer commodity” and reclassified as ORM-D or, until December 31, 2012, as ORM-D-AIR material and offered for transportation and transported in accordance with the applicable provisions of this subchapter in effect on October 1, 2010.

(d) *Alcoholic beverages.* (1) An alcoholic beverage (wine and distilled spirits as defined in 27 CFR 4.10 and 5.11), when transported via motor vehicle, vessel, or rail, is not subject to the requirements of this subchapter if the alcoholic beverage:

(i) Contains 24 percent or less alcohol by volume;

(ii) Is contained in an inner packaging of 5 L (1.3 gallons) or less; or

(iii) Is a Packing Group III alcoholic beverage contained in a packaging 250 liters (66 gallons) or less;

§ 173.150

49 CFR Ch. I (10–1–14 Edition)

(2) An alcoholic beverage (wine and distilled spirits as defined in 27 CFR 4.10 and 5.11), when transported via aircraft, is not subject to the requirements of this subchapter if the alcoholic beverage:

(i) Contains 24 percent or less alcohol by volume;

(ii) For transportation aboard a passenger-carrying aircraft, contains more than 24% but not more than 70% alcohol by volume when in unopened retail packagings not exceeding 5 liters (1.3 gallons) carried in carry-on or checked baggage, with a total net quantity per person of 5 liters (1.3) gallons (See §175.10(a)(4) of this subchapter); or

(iii) When carried as cargo, contains more than 24% but not more than 70% alcohol by volume in an inner packaging not exceeding 5 L (1.3 gallons).

(e) *Aqueous solutions of alcohol.* An aqueous solution containing 24 percent or less alcohol by volume and no other hazardous material—

(1) May be reclassified as a combustible liquid.

(2) Is not subject to the requirements of this subchapter if it contains no less than 50 percent water.

(f) *Combustible liquids.* (1) A flammable liquid with a flash point at or above 38 °C (100 °F) that does not meet the definition of any other hazard class may be reclassified as a combustible liquid. This provision does not apply to transportation by vessel or aircraft, except where other means of transportation is impracticable.

(2) The requirements in this subchapter do not apply to a material classed as a combustible liquid in a non-bulk packaging unless the combustible liquid is a hazardous substance, a hazardous waste, or a marine pollutant.

(3) A combustible liquid that is in a bulk packaging or a combustible liquid that is a hazardous substance, a hazardous waste, or a marine pollutant is not subject to the requirements of this subchapter except those pertaining to:

(i) Shipping papers, waybills, switching orders, and hazardous waste manifests;

(ii) Marking of packages;

(iii) Display of identification numbers on bulk packages;

(iv) For bulk packagings only, placarding requirements of subpart F of part 172 of this subchapter;

(v) Carriage aboard aircraft and vessels (for packaging requirements for transport by vessel, see §176.340 of this subchapter);

(vi) Reporting incidents as prescribed by §§171.15 and 171.16 of this subchapter;

(vii) Packaging requirements of subpart B of this part and, in addition, non-bulk packagings must conform with requirements of §173.203;

(viii) The requirements of §§173.1, 173.21, 173.24, 173.24a, 173.24b, 174.1, 177.804, 177.817, 177.834(j), and 177.837(d) of this subchapter;

(ix) The training requirements of subpart H of part 172 of this subchapter.

(x) Emergency response information requirements of subpart G of part 172.

(4) A combustible liquid that is not a hazardous substance, a hazardous waste, or a marine pollutant is not subject to the requirements of this subchapter if it is a mixture of one or more components that—

(i) Has a flash point at or above 93 °C (200 °F),

(ii) Comprises at least 99 percent of the volume of the mixture, and

(iii) Is not offered for transportation or transported as a liquid at a temperature at or above its flash point.

(g) *Limited quantities of retail products containing ethyl alcohol.* (1) Beverages, food, cosmetics and medicines, medical screening solutions, and concentrates sold as retail products containing ethyl alcohol classed as a flammable liquid or flammable solid containing not more than 70% ethyl alcohol by volume for liquids, by weight for solids are excepted from the HMR provided that:

(i) For non-glass inner packagings:

(A) The volume does not exceed 16 fluid ounces in capacity for liquids; or

(B) For volumes greater than 16 fluid ounces but not exceeding 1 gallon the company name and the words “Contains Ethyl Alcohol” are marked on the package;

(C) Solids containing ethyl alcohol may be packaged in non-glass inner packagings not exceeding 1 pounds capacity;

(D) For weight greater than one pound up to 8 pounds the company name and the words "Contains Ethyl Alcohol" are marked on the package.

(ii) For glass inner packagings:

(A) The volume does not exceed 8 fluid ounces in capacity; or

(B) For volumes greater than 8 fluid ounces to 16 fluid ounces the company name and the words "Contains Ethyl Alcohol" are marked on the package;

(C) Solids containing ethyl alcohol may be packaged in glass inner packagings not exceeding ½ pound;

(D) For weight greater than ½ pound up to 1 pound the company name and the words "Contains Ethyl Alcohol" are marked on the package.

(iii) The net liquid contents of all inner packagings in any single outer packaging may not exceed 192 fluid ounces. The net solid contents of all inner packagings in any single outer packaging may not exceed 32 pounds. The gross weight of any single outer package shipped may not exceed 65 pounds; Inner packagings must be secured and cushioned within the outer package to prevent breakage, leakage, and movement.

(2) Beverages, food, cosmetics and medicines, medical screening solutions, and concentrates sold as retail products containing ethyl alcohol classed as a flammable liquid or flammable solid containing more than 70% ethyl alcohol by volume, by weight for solids are excepted from the HMR provided that:

(i) For inner packagings containing liquids the volume does not exceed 8 fluid ounces in capacity;

(ii) Solids containing ethyl alcohol are not packed in inner packagings exceeding ½ pound in weight;

(iii) The net liquid contents of all inner packagings in any single outer packaging may not exceed 192 fluid ounces. The net solid contents of all inner packagings in any single outer packaging may not exceed 32 pounds. The gross weight of any single outer package shipped may not exceed 65 pounds. Inner packagings must be secured and cushioned within the outer package to prevent breakage, leakage, and movement.

(3) For transportation by passenger or cargo aircraft, no outer package

may be transported which contains an inner packaging exceeding:

(i) 16 fluid ounces of flammable liquid, or

(ii) 1 pound of solids containing flammable liquid.

[Amdt. 173-224, 55 FR 52634, Dec. 21, 1990]

EDITORIAL NOTE: For FEDERAL REGISTER citations affecting § 173.150, see the List of CFR Sections Affected, which appears in the Finding Aids section of the printed volume and at www.fdsys.gov.

§ 173.151 Exceptions for Class 4.

(a) *General.* Exceptions for hazardous materials shipments in the following paragraphs are permitted only if this section is referenced for the specific hazardous material in the § 172.101 table of this subchapter.

(b) *Limited quantities of Division 4.1.* Limited quantities of flammable solids (Division 4.1) in Packing Groups II and III and, where authorized by this section, charcoal briquettes (Division 4.2) in Packing Group III, are excepted from labeling requirements unless the material is offered for transportation or transported by aircraft, and are excepted from the specification packaging requirements of this subchapter when packaged in combination packagings according to this paragraph. If authorized for transportation by aircraft, the package must also conform to applicable requirements of § 173.27 of this part (*e.g.*, authorized materials, inner packaging quantity limits and closure securement) and only hazardous material authorized aboard passenger-carrying aircraft may be transported as a limited quantity. A limited quantity package that conforms to the provisions of this section is not subject to the shipping paper requirements of subpart C of part 172 of this subchapter, unless the material meets the definition of a hazardous substance, hazardous waste, marine pollutant, or is offered for transportation and transported by aircraft or vessel, and is eligible for the exceptions provided in § 173.156 of this part. In addition, shipments of limited quantities are not subject to subpart F (Placarding) of part 172 of this subchapter. Each package must conform to the packaging requirements of subpart B of this part and may not exceed 30 kg (66 pounds)

§ 173.152

gross weight. Except for transportation by aircraft, the following combination packagings are authorized:

(1) For flammable solids in Packing Group II, inner packagings not over 1.0 kg (2.2 pounds) net capacity each, packed in a strong outer packaging.

(2) For flammable solids in Packing Group III, inner packagings not over 5.0 kg (11 pounds) net capacity each, packed in a strong outer packaging.

(c) *Consumer commodities*. Until December 31, 2020, a limited quantity package (including Charcoal briquettes (NA1361)) containing a “consumer commodity” as defined in §171.8 of this subchapter, may be renamed “Consumer commodity” and reclassified as ORM-D or, until December 31, 2012, as ORM-D-AIR material and offered for transportation and transported in accordance with the applicable provisions of this subchapter in effect on October 1, 2010. For transportation by aircraft, the maximum net mass for Charcoal briquettes (NA1361) is 25 kg per package.

(d) *Limited quantities of Division 4.3*. Limited quantities of dangerous when wet solids (Division 4.3) in Packing Groups II and III are excepted from labeling requirements, unless the material is offered for transportation or transported by aircraft, and are excepted from the specification packaging requirements of this subchapter when packaged in combination packagings according to this paragraph. For transportation by aircraft, the package must also conform to applicable requirements of §173.27 of this part (*e.g.*, authorized materials, inner packaging quantity limits and closure securement) and only hazardous material authorized aboard passenger-carrying aircraft may be transported as a limited quantity. A limited quantity package that conforms to the provisions of this section is not subject to the shipping paper requirements of subpart C of part 172 of this subchapter, unless the material meets the definition of a hazardous substance, hazardous waste, marine pollutant, or is offered for transportation and transported by aircraft or vessel. In addition, shipments of limited quantities are not subject to subpart F (Placarding) of part 172 of this subchapter. Each package must conform to the packaging requirements of

49 CFR Ch. I (10–1–14 Edition)

subpart B of this part and may not exceed 30 kg (66 pounds) gross weight. Except for transportation by aircraft, the following combination packagings are authorized:

(1) For dangerous when wet solids in Packing Group II, inner packagings not over 0.5 kg (1.1 pounds) net capacity each, packed in a strong outer packaging.

(2) For dangerous when wet solids in Packing Group III, inner packagings not over 1.0 kg (2.2 pounds) net capacity each, packed in a strong outer packaging.

[Amdt. 173–224, 55 FR 52634, Dec. 21, 1990, as amended by Amdt. 173–231, 57 FR 52940, Nov. 5, 1992; Amdt. 173–234, 58 FR 51532, Oct. 1, 1993; Amdt. 173–255, 61 FR 50626, Sept. 26, 1996; 69 FR 76156, Dec. 20, 2004; 70 FR 34398, June 14, 2005; 71 FR 14602, Mar. 22, 2006; 72 FR 55692, Oct. 1, 2007; 76 FR 3373, Jan. 19, 2011; 76 FR 82177, Dec. 30, 2011; 78 FR 1114, Jan. 7, 2013]

§ 173.152 Exceptions for Division 5.1 (oxidizers) and Division 5.2 (organic peroxides).

(a) *General*. Exceptions for hazardous materials shipments in the following paragraphs are permitted only if this section is referenced for the specific hazardous material in the §172.101 table of this subchapter.

(b) *Limited quantities*. Limited quantities of oxidizers (Division 5.1) in Packing Group II and III and organic peroxides (Division 5.2) are excepted from labeling requirements, unless the material is offered for transportation or transported by aircraft, and are excepted from the specification packaging requirements of this subchapter when packaged in combination packagings according to this paragraph. For transportation by aircraft, the package must also conform to applicable requirements of §173.27 of this part (*e.g.*, authorized materials, inner packaging quantity limits and closure securement) and only hazardous material authorized aboard passenger-carrying aircraft may be transported as a limited quantity. A limited quantity package that conforms to the provisions of this section is not subject to the shipping paper requirements of subpart C of part 172 of this subchapter, unless the material meets the definition of a hazardous substance, hazardous waste, marine

pollutant, or is offered for transportation and transported by aircraft or vessel, and is eligible for the exceptions provided in §173.156 of this part. In addition, shipments of limited quantities are not subject to subpart F (Placarding) of part 172 of this subchapter. Each package must conform to the packaging requirements of subpart B of this part and may not exceed 30 kg (66 pounds) gross weight. Except for transportation by aircraft, the following combination packagings are authorized:

(1) For oxidizers in Packing Group II, inner packagings not over 1.0 L (0.3 gallon) net capacity each for liquids or not over 1.0 kg (2.2 pounds) net capacity each for solids, packed in a strong outer packaging.

(2) For oxidizers in Packing Group III, inner packagings not over 5 L (1.3 gallons) net capacity each for liquids or not over 5.0 kg (11 lbs) net capacity each for solids, packed in a strong outer packaging.

(3) For organic peroxides that do not require temperature control during transportation—

(i) Except for transportation by aircraft, for Type B or C organic peroxides, inner packagings not over 25 mL (0.845 ounces) net capacity each for liquids or 100 g (3.528 ounces) net capacity for solids, packed in a strong outer packaging.

(ii) For Type D, E, or F organic peroxides, inner packagings not over 125 mL (4.22 ounces) net capacity each for liquids or 500 g (17.64 ounces) net capacity for solids, packed in a strong outer packaging.

(c) *Consumer commodities.* Until December 31, 2020, a limited quantity package containing a “consumer commodity” as defined in §171.8 of this subchapter, may be renamed “Consumer commodity” and reclassified as ORM-D or, until December 31, 2012, as ORM-D-AIR material and offered for transportation and transported in accordance

with the applicable provisions of this subchapter in effect on October 1, 2010.

[Amdt. 173-224, 55 FR 52634, Dec. 21, 1990, as amended by Amdt. 173-231, 57 FR 52940, Nov. 5, 1992; Amdt. 173-241, 59 FR 67508, Dec. 29, 1994; Amdt. 173-261, 62 FR 24733, May 6, 1997; 66 FR 45381, Aug. 28, 2001; 68 FR 45033, July 31, 2003; 69 FR 76156, Dec. 20, 2004; 71 FR 14603, Mar. 22, 2006; 72 FR 55692, Oct. 1, 2007; 76 FR 3374, Jan. 19, 2011; 78 FR 1114, Jan. 7, 2013]

§ 173.153 Exceptions for Division 6.1 (poisonous materials).

(a) *General.* Exceptions for hazardous materials shipments in the following paragraphs are permitted only if this section is referenced for the specific hazardous material in the §172.101 table of this subchapter.

(b) *Limited quantities.* The exceptions in this paragraph do not apply to poison-by-inhalation materials. Limited quantities of poisonous material (Division 6.1) in Packing Groups II and III are excepted from the labeling requirements, unless the material is offered for transportation or transported by aircraft, and are excepted from the specification packaging requirements of this subchapter when packaged in combination packagings according to this paragraph. For transportation by aircraft, the package must also conform to applicable requirements of §173.27 of this part (*e.g.*, authorized materials, inner packaging quantity limits and closure securement) and only hazardous material authorized aboard passenger-carrying aircraft may be transported as a limited quantity. A limited quantity package that conforms to the provisions of this section is not subject to the shipping paper requirements of subpart C of part 172 of this subchapter, unless the material meets the definition of a hazardous substance, hazardous waste, marine pollutant, or is offered for transportation and transported by aircraft or vessel, and is eligible for the exceptions provided in §173.156 of this part. In addition, shipments of limited quantities are not subject to subpart F (Placarding) of part 172 of this subchapter. Each package must conform to the packaging requirements of subpart B of this part and may not exceed 30 kg (66 pounds) gross weight. Except

for transportation by aircraft, the following combination packagings are authorized:

(1) For poisonous materials in Packing Group II, inner packagings not over 100 mL (3.38 ounces) each for liquids or 0.5 kg (1.1 pounds) each for solids, packed in a strong outer packaging. Inner packagings containing a liquid poisonous material which is also a drug or medicine in Packing Group II may be increased to not over 250 mL (8 ounces) each and packed in a strong outer packaging.

(2) For poisonous materials in Packing Group III, inner packagings not over 5 L (1.3 gallons) each for liquids or 5.0 kg (11 pounds) each for solids, packed in a strong outer packaging.

(c) *Consumer commodities.* Until December 31, 2020, a limited quantity package of poisonous material in Packing Group III or a drug or medicine in Packing Group II or III that is also a “consumer commodity” as defined in §171.8 of this subchapter, may be renamed “Consumer commodity” and reclassified as ORM–D or, until December 31, 2012, as ORM–D–AIR material and offered for transportation and transported in accordance with the applicable provisions of this subchapter in effect on October 1, 2010.

[Amdt. 173–224, 55 FR 52634, Dec. 21, 1990, as amended by Amdt. 173–231, 57 FR 52940, Nov. 5, 1992; 66 FR 45381, Aug. 28, 2001; 68 FR 45033, July 31, 2003; 69 FR 76156, Dec. 20, 2004; 71 FR 14603, Mar. 22, 2006; 71 FR 54938, Sept. 20, 2006; 76 FR 3374, Jan. 19, 2011; 78 FR 1114, Jan. 7, 2013]

§ 173.154 Exceptions for Class 8 (corrosive materials).

(a) *General.* Exceptions for hazardous materials shipments in the following paragraphs are permitted only if this section is referenced for the specific hazardous material in the §172.101 table of this subchapter.

(b) *Limited quantities.* Limited quantities of corrosive material (Class 8) in Packing Groups II and III are excepted from labeling requirements, unless the material is offered for transportation or transported by aircraft, and are excepted from the specification packaging requirements of this subchapter when packaged in combination packagings according to this paragraph. For

transportation by aircraft, the package must also conform to the applicable requirements of §173.27 of this part (*e.g.*, authorized materials, inner packaging quantity limits and closure securement) and only hazardous material authorized aboard passenger-carrying aircraft may be transported as a limited quantity. A limited quantity package that conforms to the provisions of this section is not subject to the shipping paper requirements of subpart C of part 172 of this subchapter, unless the material meets the definition of a hazardous substance, hazardous waste, marine pollutant, or is offered for transportation and transported by aircraft or vessel, and is eligible for the exceptions provided in §173.156 of this part. In addition, shipments of limited quantities are not subject to subpart F (Placarding) of part 172 of this subchapter. Each package must conform to the packaging requirements of subpart B of this part and may not exceed 30 kg (66 pounds) gross weight. Except for transportation by aircraft, the following combination packagings are authorized:

(1) For corrosive materials in Packing Group II, inner packagings not over 1.0 L (0.3 gallon) net capacity each for liquids or not over 1.0 kg (2.2 pounds) net capacity each for solids, packed in a strong outer packaging.

(2) For corrosive materials in Packing Group III, inner packagings not over 5.0 L (1.3 gallons) net capacity each for liquids or not over 5.0 kg (11 lbs) net capacity each for solids, packed in a strong outer packaging.

(c) *Consumer commodities.* Until December 31, 2020, a limited quantity package containing a “consumer commodity” as defined in §171.8 of this subchapter, may be renamed “Consumer commodity” and reclassified as ORM–D or, until December 31, 2012, as ORM–D–AIR material and offered for transportation and transported in accordance with the applicable provisions of this subchapter in effect on October 1, 2010.

(d) *Materials corrosive to aluminum or steel only.* Except for a hazardous substance, a hazardous waste, or a marine pollutant, a material classed as a Class 8, Packing Group III, material solely because of its corrosive effect—

(1) On aluminum is not subject to any other requirements of this subchapter when transported by motor vehicle or rail car in a packaging constructed of materials that will not react dangerously with or be degraded by the corrosive material; or

(2) On steel is not subject to any other requirements of this subchapter when transported by motor vehicle or rail car in a bulk packaging constructed of materials that will not react dangerously with or be degraded by the corrosive material.

[Amdt. 173-224, 55 FR 52634, Dec. 21, 1990, as amended at 56 FR 66270, Dec. 20, 1991; 57 FR 45463, Oct. 1, 1992; Amdt. 173-231, 57 FR 52940, Nov. 5, 1992; 68 FR 45033, July 31, 2003; 69 FR 76157, Dec. 20, 2004; 71 FR 14603, Mar. 22, 2006; 72 FR 55693, Oct. 1, 2007; 76 FR 3374, Jan. 19, 2011; ; 78 FR 1114, Jan. 7, 2013]

§ 173.155 Exceptions for Class 9 (miscellaneous hazardous materials).

(a) *General.* Exceptions for hazardous materials shipments in the following paragraphs are permitted only if this section is referenced for the specific hazardous material in the § 172.101 table of this subchapter.

(b) *Limited quantities of Class 9 materials.* Limited quantities of miscellaneous hazardous materials in Packing Groups II and III are excepted from labeling requirements, unless the material is offered for transportation or transported by aircraft, and are excepted from the specification packaging requirements of this subchapter when packaged in combination packagings according to this paragraph. Unless otherwise specified in paragraph (c) of this section, packages of limited quantities intended for transportation by aircraft must conform to the applicable requirements (*e.g.*, authorized materials, inner packaging quantity limits and closure securement) of § 173.27 of this part. A limited quantity package that conforms to the provisions of this section is not subject to the shipping paper requirements of subpart C of part 172 of this subchapter, unless the material meets the definition of a hazardous substance, hazardous waste, marine pollutant, or is offered for transportation and transported by aircraft or vessel, and is eligible for the exceptions provided in

§ 173.156 of this part. In addition, packages of limited quantities are not subject to subpart F (Placarding) of part 172 of this subchapter. Each package must conform to the packaging requirements of subpart B of this part and may not exceed 30 kg (66 pounds) gross weight. Except for transportation by aircraft, the following combination packagings are authorized:

(1) For miscellaneous materials in Packing Group II, inner packagings not over 1.0 L (0.3 gallon) net capacity each for liquids or not over 1.0 kg (2.2 pounds) net capacity each for solids, packed in a strong outer packaging.

(2) For miscellaneous materials in Packing Group III, inner packagings not over 5.0 L (1.3 gallons) net capacity each for liquids or not over 5.0 kg (11 lbs) net capacity each for solids, packed in a strong outer packaging.

(c) *Consumer commodities.* Until December 31, 2020, a limited quantity package containing a “consumer commodity” as defined in § 171.8 of this subchapter, may be renamed “Consumer commodity” and reclassified as ORM-D or, until December 31, 2012, as ORM-D-AIR material and offered for transportation and transported in accordance with the applicable provisions of this subchapter in effect on October 1, 2010.

[Amdt. 173-224, 55 FR 52634, Dec. 21, 1990, as amended at 56 FR 66270, Dec. 20, 1991; Amdt. 173-231, 57 FR 52940, Nov. 5, 1992; Amdt. 173-253, 61 FR 27174, May 30, 1996; 71 FR 14603, Mar. 22, 2006; 76 FR 3375, Jan. 19, 2011; 78 FR 1114, Jan. 7, 2013]

§ 173.156 Exceptions for limited quantity and ORM.

(a) Exceptions for hazardous materials shipments in the following paragraphs are permitted only if this section is referenced for the specific hazardous material in the § 172.101 Table or in a packaging section in this part.

(b) Packagings for limited quantity and ORM-D are specified according to hazard class in §§ 173.150 through 173.155, 173.306 and 173.309(b). In addition to exceptions provided for limited quantity and ORM-D materials elsewhere in this part, the following are provided:

(1) Strong outer packagings as specified in this part, marking requirements specified in subpart D of part 172 of this

§ 173.158

49 CFR Ch. I (10–1–14 Edition)

subchapter, and the 30 kg (66 pounds) gross weight limitation when—

- (i) Unitized in cages, carts, boxes or similar overpacks;
- (ii) Offered for transportation or transported by:
 - (A) Rail;
 - (B) Private or contract motor carrier; or
 - (C) Common carrier in a vehicle under exclusive use for such service; and
- (iii) Transported to or from a manufacturer, a distribution center, or a retail outlet, or transported to a disposal facility from one offeror.

(2) The 30 kg (66 pounds) gross weight limitation does not apply to packages of limited quantity materials marked in accordance with §172.315 of this subchapter, or, until December 31, 2020, materials classed and marked as ORM-D and described as a Consumer commodity, as defined in §171.8 of this subchapter, when offered for transportation or transported by highway or rail between a manufacturer, a distribution center, and a retail outlet provided—

- (i) Inner packagings conform to the quantity limits for inner packagings specified in §§173.150(b), 173.152(b), 173.154(b), 173.155(b), 173.306 (a) and (b), and 173.309(b), as appropriate;
- (ii) The inner packagings are packed into corrugated fiberboard trays to prevent them from moving freely;
- (iii) The trays are placed in a fiberboard box which is banded and secured to a wooden pallet by metal, fabric, or plastic straps, to form a single palletized unit;
- (iv) The package conforms to the general packaging requirements of subpart B of this part;
- (v) The maximum net quantity of hazardous material permitted on one palletized unit is 250 kg (550 pounds); and

[78 FR 1114, Jan. 7, 2013, as amended at 78 FR 65481, Oct. 31, 2013]

Subpart E—Non-bulk Packaging for Hazardous Materials Other Than Class 1 and Class 7

SOURCE: Amdt. 173–224, 55 FR 52643, Dec. 21, 1990, unless otherwise noted.

§ 173.158 Nitric acid.

(a) Nitric acid exceeding 40 percent concentration may not be packaged with any other material.

(b) Nitric acid in any concentration which does not contain sulfuric acid or hydrochloric acid as impurities, when offered for transportation or transported by rail, highway, or water shall be packaged in specification containers as follows:

(1) 1A1 stainless steel drums are authorized, subject to the following limitations:

(i) Stainless steel used in drums must conform to the following thicknesses:

Nominal (marked) capacity (in liters) of 1A1 drum	Minimum thickness (in mm) of stainless steel
55	0.9
115	1.2
210	1.5
450	2.0

(ii) Drums weighing less than 85 percent of their original tare weight may not be used.

(iii) Type 304 or other grades of equivalent corrosion-resistant steels in the as-welded condition are permissible for nitric acid concentrations up to and including 78 percent.

(iv) For all concentrations of nitric acid, the following are permissible:

- (A) Type 304 heat-treated (quenched in water at 1040 °C (1900 °F)),
- (B) Stabilized Type 347 in the as-welded condition,
- (C) Stabilized Type 347 stress-relieved (845–900 °C (1550–1650 °F)),
- (D) Stabilized Type 347 heat-treated (quenched in water at 1040 °C (1900 °F)), or
- (E) Other grades of equivalent corrosion resistance.

(v) All parts of drum exposed to lading must be capable of withstanding the corrosive effect of nitric acid to the extent that 65 percent boiling nitric acid does not penetrate the metal more than 0.0381 mm (0.002 inches) per month. (ASTM A 262 may be used for a suitable corrosion test procedure.)

(vi) In addition to marking required by §178.503 of this subchapter, the following marks, in lettering of at least 12.7 mm (0.5 inch) height, must be placed on drums used to transport nitric acid:

(A) The type of steel used in body and head sheets as identified by American Iron and Steel Institute type number, and, in addition, the letters "HT" following the steel designation on containers subject to stress relieving or heat treatment during manufacture.

(B) The thickness in mm of metal in thinnest part. When the thickness of metal in the body differs from that in the head, both must be indicated with slanting line between and with the gauge of the body indicated first.

(C) Original tare weight in kilograms, preceded by the letters "TW."

An example of the markings required by paragraphs (b)(1)(vi) (A), (B), and (C) of this section is "304HT/1.9/2.7/TW55."

(2) 4H1 expanded plastics outer packagings with glass inner receptacles of not greater than 2.5 L (0.66 gallon) capacity each. No more than four 2.5 L (0.66 gallon) inner receptacles may be packed in one outer packaging.

(c) Nitric acid of 80 percent or greater concentration which does not contain sulfuric acid or hydrochloric acid as impurities, when offered for transportation or transported by rail, highway, or water may be packaged in 1B1 aluminum drums.

(d) Nitric acid of 90 percent or greater concentration, when offered for transportation or transported by rail, highway, or water may be packaged as follows:

(1) In 4C1, 4C2, 4D or 4F wooden boxes with inner packagings consisting of glass bottles further individually overpacked in tightly closed metal packagings. Glass bottles must be of 2.5 L (0.66 gallon) or less capacity and cushioned with a non-reactive, absorbent material within the metal packagings.

(2) In combination packagings with 1A2, 1B2, 1N2, 1D, 1G, 1H2, 3H2, 4A, 4B, 4N or 4G outer packagings with inner glass packagings of 2.5 L (0.66 gallons) or less capacity cushioned with a non-reactive, absorbent material and packed within a tightly closed intermediate packaging of metal or plastic.

(e) Nitric acid of less than 90 percent concentration, when offered for transportation or transported by rail, highway, or water may be packaged in 4A, 4B, or 4N metal boxes, 4G fiberboard boxes or 4C1, 4C2, 4D or 4F wooden boxes with inside glass packagings of

not over 2.5 L (0.66 gallon) capacity each.

(f) Nitric acid of 70 percent or less concentration, when offered for transportation or transported by rail, highway, or water, may be packaged as follows:

(1) In composite packagings 6PA1, 6PA2, 6PB1, 6PB2, 6PC, 6PD1, 6PH1, or 6PH2. 6HH1 and 6HA1 composite packaging with plastic inner receptacles meeting the compatibility requirements §173.24(e) (e.g., PFA Teflon) are authorized.

(2) In 4H1 expanded plastic boxes with inner glass packagings of not over 2.5 L (0.66 gallon) each.

(3) In combination packagings with 1A2, 1B2, 1N2, 1D, 1G, 1H2, 3H2, 4C1, 4C2, 4D, 4F, 4G, 4A, 4B or 4N outer packagings and plastic inner packagings not over 2.5 L (0.66 gallon) capacity further individually overpacked in tightly closed metal packagings.

(g) Nitric acid of more than 70 percent concentration, when offered for transportation or transported by cargo aircraft only, must be packaged in combination packagings with 1A2, 1B2, 1N2, 1D, 1G, 1H2, 3H2, 4C1, 4C2, 4D, 4F, 4G, 4A, 4B or 4N outer packagings with glass or earthenware inner packagings of not over 1 L (0.3 gallon) or glass ampoules of not over 0.5 L (0.1 gallon).

(h) Nitric acid of less than 70 percent concentration, when offered for transportation in cargo aircraft only must be packaged in combination packagings with 1A2, 1B2, 1N2, 1D, 1G, 1H2, 3H2, 4C1, 4C2, 4D, 4F, 4G, 4A, 4B or 4N outer packagings with inner packagings of—

(1) Glass or earthenware not over 2.5 L (0.66 gallon) capacity;

(2) Plastic not over 2.5 L (0.66 gallon) capacity further individually overpacked in tightly closed metal packagings; or

(3) Glass ampoule not over 0.5 L (0.1 gallon) capacity.

[Amdt. 173-224, 55 FR 52643, Dec. 21, 1990, as amended at 56 FR 66270, Dec. 20, 1991; Amdt. 173-241, 59 FR 67509, Dec. 29, 1994; Amdt. 173-255, 61 FR 50626, Sept. 26, 1996; 68 FR 75744, Dec. 31, 2003; 78 FR 1085, Jan. 7, 2013]

§ 173.159 Batteries, wet.

(a) Electric storage batteries, containing electrolyte acid or alkaline

corrosive battery fluid (wet batteries), may not be packed with other materials except as provided in paragraphs (g) and (h) of this section and in §§ 173.220 and 173.222; and any battery or battery-powered device must be prepared and packaged for transport in a manner to prevent:

(1) A dangerous evolution of heat (*i.e.*, an amount of heat sufficient to be dangerous to packaging or personal safety to include charring of packaging, melting of packaging, scorching of packaging, or other evidence);

(2) Short circuits, including, but not limited to:

(i) Packaging each battery or each battery-powered device when practicable, in fully enclosed inner packagings made of non-conductive material;

(ii) Separating or packaging batteries and battery-powered devices in a manner to prevent contact with other batteries, devices or conductive materials (*e.g.*, metal) in the packagings; or

(iii) Ensuring exposed terminals are protected with non-conductive caps, non-conductive tape, or by other appropriate means; and

(3) *Damage to terminals.* If not impact resistant, the outer packaging must not be used as the sole means of protecting the battery terminals from damage or short circuiting. Batteries must be securely cushioned and packed to prevent shifting which could loosen terminal caps or reorient the terminals. Batteries contained in devices must be securely installed. Terminal protection methods include but are not limited to:

(i) Securely attaching covers of sufficient strength to protect the terminals;

(ii) Packaging the battery in a rigid plastic packaging; or

(iii) Constructing the battery with terminals that are recessed or otherwise protected so that the terminals will not be subjected to damage if the package is dropped.

(b) For transportation by aircraft:

(1) The packaging for wet batteries must incorporate an acid- or alkali-proof liner, or include a supplementary packaging with sufficient strength and adequately sealed to prevent leakage of

electrolyte fluid in the event of spillage; and

(2) Any battery-powered device, equipment or vehicle must be packaged for transport in a manner to prevent unintentional activation or must have an independent means of preventing unintentional activation (*e.g.*, packaging restricts access to activation switch, switch caps or locks, recessed switches, trigger locks, temperature sensitive circuit breakers, etc.).

(c) The following specification packagings are authorized for batteries packed without other materials provided all requirements of paragraph (a) of this section, and for transportation by aircraft, paragraph (b) of this section are met:

(1) Wooden box: 4C1, 4C2, 4D, or 4F.

(2) Fiberboard box: 4G.

(3) Plywood drum: 1D.

(4) Fiber drum: 1G.

(5) Plastic drum: 1H2.

(6) Plastic jerrican: 3H2.

(7) Plastic box: 4H2.

(d) The following non-specification packagings are authorized for batteries packed without other materials provided all requirements of paragraph (a) of this section, and for transportation by aircraft, paragraph (b) of this section are met:

(1) Electric storage batteries are firmly secured to skids or pallets capable of withstanding the shocks normally incident to transportation are authorized for transportation by rail, highway, or vessel. The height of the completed unit must not exceed 1½ times the width of the skid or pallet. The unit must be capable of withstanding, without damage, a superimposed weight equal to two times the weight of the unit or, if the weight of the unit exceeds 907 kg (2,000 pounds), a superimposed weight of 1814 kg (4,000 pounds). Battery terminals must not be relied upon to support any part of the superimposed weight and must not short out if a conductive material is placed in direct contact with them.

(2) Electric storage batteries weighing 225 kg (500 pounds) or more, consisting of carriers' equipment, may be shipped by rail when mounted on suitable skids. Such shipments may not be offered in interchange service.

(3) One to three batteries not over 11.3 kg (25 pounds) each, packed in strong outer boxes. The maximum authorized gross weight is 34 kg (75 pounds).

(4) Not more than four batteries not over 7 kg (15 pounds) each, packed in strong outer fiberboard or wooden boxes. The maximum authorized gross weight is 30 kg (65 pounds).

(5) Not more than five batteries not over 4.5 kg (10 pounds) each, packed in strong outer fiberboard or wooden boxes. The maximum authorized gross weight is 30 kg (65 pounds).

(6) Single batteries not exceeding 34 kg (75 pounds) each, packed in 5-sided slip covers or in completely closed fiberboard boxes. Slip covers and boxes must be of solid or double-faced corrugated fiberboard of at least 91 kg (200 pounds) Mullen test strength. The slip cover or fiberboard box must fit snugly and provide inside top clearance of at least 1.3 cm (0.5 inch) above battery terminals and filler caps with reinforcement in place. Assembled for shipment, the bottom edges of the slipcover must come to within 2.5 cm (1 inch) of the bottom of the battery. The completed package (battery and box or slip cover) must be capable of withstanding a top-to-bottom compression test of at least 225 kg (500 pounds) without damage to battery terminal caps, cell covers or filler caps.

(7) Single batteries exceeding 34 kg (75 pounds) each may be packed in completely closed fiberboard boxes. Boxes must be of double-wall corrugated fiberboard of at least 181 kg (400 pounds) test, or solid fiberboard testing at least 181 kg (400 pounds); a box may have hand holes in its ends provided that the hand holes will not materially weaken the box. Sides and ends of the box must have cushioning between the battery and walls of the box; combined thickness of cushioning material and walls of the box must not be less than 1.3 cm (0.5 inch); and cushioning must be excelsior pads, corrugated fiberboard, or other suitable cushioning material. The bottom of the battery must be protected by a minimum of one excelsior pad or by a double-wall corrugated fiberboard pad. The top of the battery must be protected by a wood frame, corrugated trays or scored sheets of

corrugated fiberboard having minimum test of 91 kg (200 pounds), or other equally effective cushioning material. Top protection must bear evenly on connectors and/or edges of the battery cover to facilitate stacking of batteries. No more than one battery may be placed in one box. The maximum authorized gross weight is 91 kg (200 pounds).

(e) When transported by highway or rail, electric storage batteries containing electrolyte or corrosive battery fluid are not subject to any other requirements of this subchapter, if all of the following are met:

(1) No other hazardous materials may be transported in the same vehicle;

(2) The batteries must be loaded or braced so as to prevent damage and short circuits in transit;

(3) Any other material loaded in the same vehicle must be blocked, braced, or otherwise secured to prevent contact with or damage to the batteries; and

(4) The transport vehicle may not carry material shipped by any person other than the shipper of the batteries.

(f) Batteries can be considered as non-spillable provided they are capable of withstanding the following two tests, without leakage of battery fluid from the battery:

(1) *Vibration test.* The battery must be rigidly clamped to the platform of a vibration machine, and a simple harmonic motion having an amplitude of 0.8 mm (0.03 inches) with a 1.6 mm (0.063 inches) maximum total excursion must be applied. The frequency must be varied at the rate of 1 Hz/min between the limits of 10 Hz to 55 Hz. The entire range of frequencies and return must be traversed in 95 ±5 minutes for each mounting position (direction of vibrator) of the battery. The battery must be tested in three mutually perpendicular positions (to include testing with fill openings and vents, if any, in an inverted position) for equal time periods.

(2) *Pressure differential test.* Following the vibration test, the battery must be stored for six hours at 24 °C ±4 °C (75 °F ±7 °F) while subjected to a pressure differential of at least 88 kPa (13 psig). The battery must be tested in three mutually perpendicular positions (to

§ 173.159a

include testing with fill openings and vents, if any, in an inverted position) for at least six hours in each position.

(g) Electrolyte, acid or alkaline corrosive battery fluid, packed with batteries wet or dry, must be packed in one of the following specification packagings:

(1) In 4C1, 4C2, 4D, or 4F wooden boxes with inner receptacles of glass, not over 4.0 L (1 gallon) each with not over 8.0 L (2 gallons) total in each outside container. Inside containers must be well-cushioned and separated from batteries by a strong solid wooden partition. The completed package must conform to Packing Group III requirements.

(2) Electrolyte, acid, or alkaline corrosive battery fluid included with electric storage batteries and filling kits may be packed in strong rigid outer packagings when shipments are made by, for, or to the Departments of the Army, Navy, or Air Force of the United States. Packagings must conform to military specifications. The electrolyte, acid, or alkaline corrosive battery fluid must be packed in polyethylene bottles of not over 1.0 L (0.3 gallon) capacity each. Not more than 24 bottles, securely separated from electric storage batteries and kits, may be offered for transportation or transported in each package.

(3) In 4G fiberboard boxes with not more than 12 inside packagings of polyethylene or other material resistant to the lading, each not over 2.0 L (0.5 gallon) capacity each. Completed packages must conform to Packing Group III requirements. Inner packagings must be adequately separated from the storage battery. The maximum authorized gross weight is 29 kg (64 pounds). These packages are not authorized for transportation by aircraft.

(h) Dry batteries or battery charger devices may be packaged in 4G fiberboard boxes with inner receptacles containing battery fluid. Completed packagings must conform to Packing Group III requirements. Not more than 12 inner receptacles may be packed in one outer box. The maximum authorized gross weight is 34 kg (75 pounds).

(i) When approved by the Associate Administrator, electric storage batteries, containing electrolyte or corro-

49 CFR Ch. I (10–1–14 Edition)

sive battery fluid in a separate reservoir from which fluid is injected into the battery cells by a power device cartridge assembled with the battery, and which meet the criteria of paragraph (f) are not subject to any other requirements of this subchapter.

[74 FR 2257, Jan. 14, 2009]

§ 173.159a Exceptions for non-spillable batteries.

(a) Exceptions for hazardous materials shipments in the following paragraphs are permitted only if this section is referenced for the specific hazardous material in the §172.101 table or in a packaging section in this part.

(b) Non-spillable batteries offered for transportation or transported in accordance with this section are subject to the incident reporting requirements. For transportation by aircraft, a telephone report in accordance with §171.15(a) is required if a fire, violent rupture, explosion or dangerous evolution of heat (*i.e.*, an amount of heat sufficient to be dangerous to packaging or personal safety to include charring of packaging, melting of packaging, scorching of packaging, or other evidence) occurs as a direct result of a non-spillable battery. For all modes of transportation, a written report in accordance with §171.16(a) is required if a fire, violent rupture, explosion or dangerous evolution of heat occurs as a direct result of a non-spillable battery.

(c) Non-spillable batteries are excepted from the packaging requirements of §173.159 under the following conditions:

(1) Non-spillable batteries must be securely packed in strong outer packagings or secured to skids or pallets capable of withstanding the shocks normally incident to transportation. The batteries must meet the requirements of §173.159(a), be loaded or braced so as to prevent damage and short circuits in transit, and any other material loaded in the same vehicle must be blocked, braced, or otherwise secured to prevent contact with or damage to the batteries. A non-spillable battery which is an integral part of and necessary for the operation of mechanical or electronic equipment must be securely fastened in the battery holder on the equipment.

(2) The battery and outer packaging must be plainly and durably marked "NON-SPILLABLE" or "NON-SPILLABLE BATTERY." The requirement to mark the outer package does not apply when the battery is installed in a piece of equipment that is transported unpackaged.

(d) Non-spillable batteries are excepted from all other requirements of this subchapter when offered for transportation and transported in accordance with paragraph (c) of this section and the following:

(1) At a temperature of 55 °C (131 °F), the battery must not contain any unabsorbed free-flowing liquid, and must be designed so that electrolyte will not flow from a ruptured or cracked case; and

(2) For transport by aircraft, when contained in a battery-powered device, equipment or vehicle must be prepared and packaged for transport in a manner to prevent unintentional activation in conformance with §173.159(b)(2) of this Subpart.

(3) For transport by aircraft, must be transported as cargo and may not be carried onboard an aircraft by passengers or crewmembers in carry-on baggage, checked baggage, or on their person unless specifically excepted by §175.10.

[74 FR 2258, Jan. 14, 2009, as amended at 75 FR 72, Jan. 4, 2010; 77 FR 60942, Oct. 5, 2012; 78 FR 1085, Jan. 7, 2013; 78 FR 15328, Mar. 11, 2013]

§ 173.160 Bombs, smoke, non-explosive (corrosive).

Bombs, smoke, non-explosive may be shipped provided they are without ignition elements, bursting charges, detonating fuses or other explosive components. They must be packaged in metal (4A, 4B, 4N), wooden (4C1, 4C2), plywood (4D), or reconstituted wood (4F), fiberboard (4G) or solid plastic (4H2) boxes, or metal (1A2, 1B2, 1N2), plastic (1H2), plywood drums (1D), or fiber (1G) drums that meet Packing Group II requirements.

[78 FR 1085, Jan. 7, 2013]

§ 173.161 Chemical kits and first aid kits.

(a) *Applicability.* Chemical kits and first aid kits contain one or more com-

patible items of hazardous materials in boxes, cases, *etc.* that, for example, are used for medical, analytical, diagnostic, testing, or repair purposes.

(b) *Authorized materials.* (1) The kits may only contain hazardous materials for which packaging exceptions are provided in column 8(A) of the §172.101 Hazardous Materials Table in this subchapter. For transportation by aircraft, the kits may only contain quantities of hazardous materials authorized as excepted quantities or as limited quantities in §§173.4a and 173.27(f) of this part, respectively. Materials forbidden for transportation by passenger aircraft or cargo aircraft may not be included in the kits.

(2) The packing group assigned to the chemical kit and first aid kit as a whole must be the most stringent packing group assigned to any individual substance in the kit and must be shown on the shipping paper, if applicable, in accordance with subpart C of part 172 of this subchapter.

(c) *Packaging.* Except for transportation by aircraft or vessel, chemical kits and first aid kits must be packaged in combination packagings conforming to the packaging requirements of subpart B of this part. For transportation by aircraft or vessel, chemical kits and first aid kits must be packaged in specification combination packagings based on the performance level of the most stringent packing group of material contained within the kit. For transportation by aircraft, friction-type closures must be secured by secondary means and inner packagings intended to contain liquids must be capable of meeting the pressure differential requirements prescribed in §173.27(c) of this subchapter. Inner and outer packaging quantity limits for packages are as follows:

(1) Except for liquids of Division 5.2 (organic peroxide), inner packagings containing not more than 250 mL. Except for transportation by aircraft, for Division 5.2 (organic peroxide) liquids of Type B and C, inner packagings containing not more than 25 mL and for Division 5.2 (organic peroxide) liquids of Type D, E and F, inner packagings containing not more than 125 mL. For transportation by aircraft, for Division 5.2 (organic peroxide) liquids of Type D,

§ 173.162

49 CFR Ch. I (10–1–14 Edition)

E and F (only), inner packagings containing not more than 125 mL;

(2) Except for solids of Division 5.2 (organic peroxide) of Type B and C, inner packagings containing not more than 250 g. Except for transportation by aircraft, for a Division 5.2 (organic peroxide) solid of Type B and C, inner packagings containing not more than 100 g. For transportation by aircraft, for a Division 5.2 (organic peroxide) solid of Type D, E and F (only), inner packagings containing not more than 250 g;

(3) No more than 10 L or 10 kg of hazardous material may be contained in one outer package (excluding dry ice). For transportation by aircraft, no more than 1 L or 1 kg of hazardous material may be contained in one kit (excluding dry ice);

(4) Each package must conform to the packaging requirements of subpart B of this part and may not exceed 30 kg (66 pounds) gross weight;

(5) Except for Carbon dioxide, solid (Dry ice), UN1845, no other hazardous materials may be packed within the same outer packaging as the kits. Dry ice must be packaged in accordance with §173.217 of this subchapter;

(6) The kits must include sufficient absorbent material to completely absorb the contents of any liquid hazardous materials contained in the kits. The contents must be separated, placed, or packed, and closed with cushioning material to protect them from damage; and

(7) The contents of the kits must be packed so there will be no possibility of the mixture of contents causing dangerous evolution of heat or gas.

(d) *Exceptions.* (1)(i) Chemical kits and first aid kits are eligible for the excepted quantity exceptions provided in §§173.4 and 173.4a of this part. For transportation by aircraft, chemical kits and first aid kits are eligible for the limited quantity provisions provided in §173.27(f) of this part. For inner packaging quantity limits, see §173.27(f), Table 3.

(ii) A package conforming to the provisions of this section is not subject to the shipping paper requirements of subpart C of part 172 of this subchapter, unless the material meets the definition of a hazardous substance, haz-

ardous waste, marine pollutant, or is offered for transportation and transported by aircraft or vessel. Chemical kits and First aid kits conforming to this section may be marked as a limited quantity as prescribed in §172.315 of this subchapter and, if applicable, are eligible for the exceptions provided in §173.156 of this part. Additionally, chemical and first aid kits conforming to this section are not subject to part 174 (carriage by rail) or part 177 (carriage by highway) of this subchapter when marked in accordance with §172.315 of this subchapter.

(2) Consumer commodities. Until December 31, 2020, a limited quantity package containing a “consumer commodity” as defined in §171.8 of this subchapter may be renamed “Consumer commodity” and reclassified as ORM-D or, until December 31, 2012, as ORM-D-AIR material and offered for transportation and transported in accordance with the applicable provisions of this subchapter in effect on October 1, 2010.

(3) Kits that are carried on board transport vehicles for first aid or operating purposes are not subject to the requirements of this subchapter.

[76 FR 3375, Jan. 19, 2011, as amended at 78 FR 1115, Jan. 7, 2013]

§ 173.162 Gallium.

(a) Except when packaged in cylinders or steel flasks, gallium must be packaged in packagings which meet the requirements of part 178 of this subchapter at the Packing Group I performance level for transportation by aircraft, and at the Packing Group III performance level for transport by highway, rail or vessel, as follows:

(1) In combination packagings intended to contain liquids consisting of glass, earthenware or rigid plastic inner packagings with a maximum net mass of 15 kg (33 pounds) each. The inner packagings must be packed in wood boxes (4C1, 4C2, 4D, 4F), fiberboard boxes (4G), plastic boxes (4H1, 4H2), fiber drums (1G) or steel, metal, other than steel or aluminum, and plastic drums or jerricans (1A1, 1A2, 1N1, 1N2, 1H1, 1H2, 3A2 or 3H2) with sufficient cushioning materials to prevent breakage. Either the inner packagings or the outer packagings must have an inner liner that is leakproof or bags of

strong leakproof and puncture-resistant material impervious to the contents and completely surrounding the contents to prevent it from escaping from the package, irrespective of its position.

(2) In packagings intended to contain liquids consisting of semi-rigid plastic inner packagings of not more than 2.5 kg (5.5 pounds) net capacity each, individually enclosed in a sealed, leak-tight bag of strong puncture-resistant material. The sealed bags must be packed in wooden (4C1, 4C2), plywood (4D), reconstituted wood (4F), fiberboard (4G), plastic (4H1, 4H2) or metal, other than steel or aluminum (4N) boxes or in fiber (1G), steel (1A1, 1A2), metal, other than steel or aluminum (1N1, 1N2), or plastic (1H1 or 1H2) drums, that are lined with leak-tight, puncture-resistant material. Bags and liner material must be chemically resistant to gallium.

(3) Cylinders and steel flasks with vaulted bottoms are also authorized.

(b) When it is necessary to transport gallium at low temperatures in order to maintain it in a completely solid state, the above packagings may be overpacked in a strong, water-resistant outer packaging which contains dry ice or other means of refrigeration. If a refrigerant is used, all of the above materials used in the packaging of gallium must be chemically and physically resistant to the refrigerant and must have impact resistance at the low temperatures of the refrigerant employed. If dry ice is used, the outer packaging must permit the release of carbon dioxide gas.

(c) Manufactured articles or apparatuses, each containing not more than 100 mg (0.0035 ounce) of gallium and packaged so that the quantity of gallium per package does not exceed 1 g (0.35 ounce) are not subject to the requirements of this subchapter. For transportation by aircraft, such articles and apparatuses must be transported as cargo and may not be carried onboard an aircraft by passengers or crewmembers in carry-on baggage, checked baggage, or on their person unless specifically excepted by § 175.10.

[64 FR 10777, Mar. 5, 1999; as amended at 66 FR 33430, June 21, 2001; 78 FR 1085, Jan. 7, 2013]

§ 173.163 Hydrogen fluoride.

(a) Hydrogen fluoride (hydrofluoric acid, anhydrous) must be packaged as follows:

(1) In specification 3, 3A, 3AA, 3B, 3BN, or 3E cylinders; or in specification 4B, 4BA, or 4BW cylinders except that brazed 4B, 4BA, and 4BW cylinders are not authorized. The filling density may not exceed 85 percent of the cylinder's water weight capacity. In place of the periodic volumetric expansion test, cylinders used in exclusive service may be given a complete external visual inspection in conformance with part 180, subpart C, of this subchapter, at the time such requalification becomes due.

(2) In a UN cylinder, as specified in part 178 of this subchapter, having a minimum test pressure of 10 bar and a maximum filling ratio of 0.84.

(b) A cylinder removed from hydrogen fluoride service must be condemned in accordance with § 180.205 of this subchapter. Alternatively, at the direction of the owner, the requalifier may render the cylinder incapable of holding pressure.

[71 FR 33880, June 12, 2006]

§ 173.164 Mercury (metallic and articles containing mercury).

(a) For transportation by aircraft, mercury must be packaged in packagings which meet the requirements of part 178 of this subchapter at the Packing Group I performance level, as follows:

(1) In inner packagings of earthenware, glass or plastic containing not more than 3.5 kg (7.7 pounds) of mercury, or inner packagings that are glass ampoules containing not more than 0.5 kg (1.1 pounds) of mercury, or iron or steel quicksilver flasks containing not more than 35 kg (77 pounds) of mercury. The inner packagings or flasks must be packed in steel drums (1A1, 1A2), metal, other than steel or aluminum drums (1N1, 1N2), steel jerricans (3A2), wooden boxes (4C1, 4C2), plywood boxes (4D), reconstituted wood boxes (4F), fiberboard boxes (4G), metal, other than steel or aluminum boxes (4N), plastic boxes (4H2), plywood drums (1D) or fiber drums (1G).

(2) [Reserved]

(3) When inner packagings of earthenware, glass or plastic are used, they must be packed in the outer packaging with sufficient cushioning material to prevent breakage.

(4) Either the inner packagings or the outer packagings must have inner linings or bags of strong leakproof and puncture-resistant material impervious to mercury, completely surrounding the contents, so that the escape of mercury will be prevented irrespective of the position of the package.

(5) When transported as cargo, lamps are excepted from the requirements of this subchapter provided, each lamp contains not more than 1 g of mercury and is packaged so that there is not more than 30 g of mercury per package. Packages must be so designed and constructed such that when dropped from a height of not less than 0.5 meter (1.5 feet) the packages must still be fit for transport and there must be no damage to the contents.

(b) When transported as cargo, manufactured articles or apparatuses, each containing not more than 100 mg (0.0035 ounce) of mercury and packaged so that the quantity of mercury per package does not exceed 1 g (0.035 ounce) are not subject to the requirements of this subchapter.

(c) Manufactured articles or apparatuses containing mercury are excepted from the specification packaging requirements of this subchapter when packaged as follows:

(1) Manufactured articles or apparatuses of which metallic mercury is a component part, such as manometers, pumps, thermometers, switches, etc. (for electron tubes, mercury vapor tubes and similar tubes, see paragraph (c)(3) of this section), must be in strong outer packagings, having sealed inner liners or bags of strong leakproof and puncture-resistant material impervious to mercury, which will prevent the escape of mercury from the package irrespective of its position. Mercury switches and relays are excepted from these packaging requirements, if they are totally enclosed, leakproof and in sealed metal or plastic units.

(2) When transported as cargo, thermometers, switches and relays, each containing a total quantity of not

more than 15 g (0.53 ounces) of mercury, are excepted from the requirements of this subchapter if installed as an integral part of a machine or apparatus and so fitted that shock of impact damage, leading to leakage of mercury, is unlikely to occur under conditions normally incident to transport.

(3) Electron tubes, mercury vapor tubes and similar tubes must be packaged as follows:

(i) Tubes which are packed in strong outer packagings with all seams and joints sealed with self-adhesive, pressure-sensitive tape which will prevent the escape of mercury from the package, are authorized up to a total net quantity of 450 g (15.9 ounces) of mercury per package;

(ii) Tubes with more than 450 g (15.9 ounces) of mercury are authorized only when packed in strong outer packagings, having sealed inner liners or bags of strong leakproof and puncture-resistant material impervious to mercury which will prevent escape of mercury from the package irrespective of its position;

(iii) Tubes which do not contain more than 5 g (0.2 ounce) of mercury each and which are packed in the manufacturer's original packagings, are authorized up to a total net quantity of 30 g (1.1 ounces) of mercury per package;

(iv) Tubes which are completely jacketed in sealed leakproof metal cases are authorized in the manufacturer's original packagings.

(4) A person offering for transportation electron tubes, mercury vapor tubes, and similar tubes shall indicate the quantity of mercury therein on the shipping paper.

(5) Mercurial barometers conforming to paragraph (c)(1) of this section, which are loaded and unloaded from an aircraft under the supervision of, and accompanied in flight by, a National Weather Service official or similar United States agency official, are excepted from any other requirements of this subchapter.

(d) For transportation by other than aircraft, mercury must be packaged—

(1) In any packaging which meets the requirements of part 178 of this subchapter at the Packing Group III performance level; or

(2) In non-specification reusable metal packagings.

(e) Except for a hazardous substance or a hazardous waste or for transportation by aircraft or vessel, packages containing less than 0.45 kg (1.0 pound) net weight of mercury are not subject to the requirements of this subchapter.

(f) For vessel transport, manufactured articles or instruments containing less than 0.45 kg (1.0 pound) of mercury are not subject to the requirements of this subchapter.

[Amdt. 173-224, 55 FR 52643, Dec. 21, 1990, as amended at 56 FR 66270, Dec. 20, 1991; Amdt. 173-241, 59 FR 67509, Dec. 29, 1994; Amdt. 173-246, 60 FR 49110, Sept. 21, 1995; 64 FR 10777, 10778, Mar. 5, 1999; 68 FR 57632, Oct. 6, 2003; 78 FR 1085, Jan. 7, 2013]

§ 173.165 Polyester resin kits.

(a) Polyester resin kits consisting of a base material component (Class 3, Packing Group II or III) and an activator component (Type D, E, or F organic peroxide that does not require temperature control)—

(1) The organic peroxide component must be packed in inner packagings not over 125 mL (4.22 fluid ounces) net capacity each for liquids or 500 g (17.64 ounces) net capacity each for solids.

(2)(i) Except for transportation by aircraft, the flammable liquid component must be packaged in suitable inner packagings.

(ii) For transportation by aircraft, a Packing Group II base material is limited to a quantity of 5 L (1.3 gallons) in metal or plastic inner packagings and 1 L (0.3 gallons) in glass inner packagings. A Packing Group III base material is limited to a quantity of 10 L (2.6 gallons) in metal or plastic inner packagings and 2.5 L (0.66 gallons) in glass inner packagings.

(3) If the flammable liquid component and the organic peroxide component will not interact dangerously in the event of leakage, they may be packed in the same outer packaging.

(4) The Packing Group assigned will be II or III, according to the criteria for Class 3, applied to the base material. Additionally, polyester resin kits must be packaged in specification combination packagings, based on the performance level required of the base material (II or III) contained within the

kit, as prescribed in §173.202 or §173.203 of this subchapter, as appropriate.

(5) For transportation by aircraft, the following additional requirements apply:

(i) Closures on inner packagings containing liquids must be secured by secondary means;

(ii) Inner packagings containing liquids must be capable of meeting the pressure differential requirements prescribed in §173.27(c); and

(iii) The total quantity of activator and base material may not exceed 5 kg (11 lbs) per package for a Packing Group II base material. The total quantity of activator and base material may not exceed 10 kg (22 lbs) per package for a Packing Group III base material. The total quantity of polyester resin kits per package is calculated on a one-to-one basis (*i.e.*, 1 L equals 1 kg).

(b) Polyester resin kits are eligible for the Small Quantity exceptions in §173.4 and the Excepted Quantity exceptions in §173.4a, as applicable.

(c) *Limited quantities.* Limited quantity packages of polyester resin kits are excepted from labeling requirements, unless the material is offered for transportation or transported by aircraft, and are excepted from the specification packaging requirements of this subchapter when packaged in combination packagings according to this paragraph. For transportation by aircraft, only hazardous material authorized aboard passenger-carrying aircraft may be transported as a limited quantity. A limited quantity package that conforms to the provisions of this section is not subject to the shipping paper requirements of subpart C of part 172 of this subchapter, unless the material meets the definition of a hazardous substance, hazardous waste, marine pollutant, or is offered for transportation and transported by aircraft or vessel, and is eligible for the exceptions provided in §173.156 of this part. In addition, shipments of limited quantities are not subject to subpart F (Placarding) of part 172 of this subchapter. Each package must conform to the general packaging requirements of subpart B of this part and may not exceed 30 kg (66 pounds) gross weight.

(1) For other than transportation by aircraft, the organic peroxide component must be packed in inner packagings not over 125 mL (4.22 fluid ounces) net capacity each for liquids or 500 g (17.64 ounces) net capacity each for solids. For transportation by aircraft, the organic peroxide component must be packed in inner packagings not over 30 mL (4.22 fluid ounces) net capacity each for liquids or 100 g (17.64 ounces) net capacity each for solids.

(2) Except for transportation by aircraft, the flammable liquid component must be packed in inner packagings not over 5 L (1.3 gallons) net capacity each for a Packing Group II and Packing Group III liquid. For transportation by aircraft, the flammable liquid component must be packed in inner packagings not over 1 L (0.26 gallons) net capacity each for a Packing Group II material. The flammable liquid component must be packed in metal or plastic inner packagings not over 5.0 L (1.3 gallons) net capacity each or glass inner packagings not over 2.5 L (0.66 gallons) net capacity each for a Packing Group III material.

(3) If the flammable liquid component and the organic peroxide component will not interact dangerously in the event of leakage, they may be packed in the same outer packaging.

(4) For transportation by aircraft, the following additional requirements apply:

(i) Closures on inner packagings containing liquids must be secured by secondary means as prescribed in § 173.27(d);

(ii) Inner packagings containing liquids must be capable of meeting the pressure differential requirements prescribed in § 173.27(c);

(iii) The total quantity of activator and base material may not exceed 1 kg (2.2 lbs) per package for a Packing Group II base material. The total quantity of activator and base material may not exceed 5 kg (11 lbs) per package for a Packing Group III base material. The total quantity of polyester resin kits per package is calculated on a one-to-one basis (*i.e.*, 1 L equals 1 kg);

(iv) *Drop test capability.* Fragile inner packagings must be packaged to prevent failure under conditions normally incident to transport. Packages of con-

sumer commodities must be capable of withstanding a 1.2 m drop on solid concrete in the position most likely to cause damage; and

(v) *Stack test capability.* Packages of consumer commodities must be capable of withstanding, without failure or leakage of any inner packaging and without any significant reduction in effectiveness, a force applied to the top surface for a duration of 24 hours equivalent to the total weight of identical packages if stacked to a height of 3.0 m (including the test sample).

(d) *Consumer commodities.* Until December 31, 2020, a limited quantity package of polyester resin kits that are also consumer commodities as defined in § 171.8 of this subchapter may be renamed “Consumer commodity” and reclassified as ORM–D or, until December 31, 2012, as ORM–D–AIR material and offered for transportation and transported in accordance with the applicable provisions of this subchapter in effect on October 1, 2010.

[78 FR 65481, Oct. 31, 2013]

§ 173.166 Air bag inflators, air bag modules and seat-belt pretensioners.

(a) *Definitions.* An *air bag inflator* (consisting of a casing containing an igniter, a booster material, a gas generant and, in some cases, a pressure receptacle (cylinder)) is a gas generator used to inflate an air bag in a supplemental restraint system in a motor vehicle. An *air bag module* is the air bag inflator plus an inflatable bag assembly. A *seat-belt pretensioner* contains similar hazardous materials and is used in the operation of a seat-belt restraining system in a motor vehicle.

(b) *Classification.* (1) An air bag inflator, air bag module, or seat-belt pretensioner, excluding those which contain flammable or toxic gases or mixtures thereof, may be classed as Class 9 (UN3268) if the air bag inflator, air bag module, or seat-belt pretensioner, or if more than a single air bag inflator, air bag module, or seat-belt pretensioner is involved then the representative of the maximum parameters of each design type, is examined and successfully tested by a person or agency who is authorized by the

Associate Administrator to perform examination and testing of explosives under §173.56(b)(1), and who:

(i) Does not manufacture or market explosives, air bag inflators, air bag modules, or seat-belt pretensioners, is not owned in whole or in part, or is not financially dependent upon any entity that manufactures or markets explosives, air bag inflators, air bag modules, or seat-belt pretensioners;

(ii) Performs all examination and testing in accordance with the applicable requirements as specified in Special Provision 160 (see §172.102 of this subchapter); and

(iii) Maintains records in accordance with paragraph (g) of this section.

(iv) By adhering to all the provisions specified in paragraph (b)(1) of this section, the Class 9 (UN3268) air bag inflator, air bag module, or seat-belt pretensioner design is not required to be submitted to the Associate Administrator for approval or assigned an EX number;

(2) An air bag inflator, air bag module, or seat-belt pretensioner may be classed as Division 1.4G if the maximum parameters of each design type has been examined and successfully tested by a person or agency who is authorized by the Associate Administrator to perform such examination and testing of explosives under §173.56(b)(1). For domestic transport, air bag inflators, air bag modules or seat-belt pretensioners that meet the criteria for a Division 1.4G explosive must be transported using the description, "UN0431, Articles, pyrotechnic for technical purposes" as specified in Special Provision 161 (see §172.102 of this subchapter). Further, as a Class 1 explosive, the manufacturer must submit to the Associate Administrator a report of the examination and assignment of a recommended shipping description, division, and compatibility group, and if the Associate Administrator finds the approval request meets the regulatory criteria, the explosive may be approved in writing and assigned an EX number; or

(3) The manufacturer has submitted an application, including a classification issued by the competent authority of a foreign government to the Associate Administrator, and received writ-

ten notification from the Associate Administrator that the device has been approved for transportation and assigned an EX number.

(c) *EX numbers.* (1) When an air bag inflator, air bag module, or seat-belt pretensioner is classed and approved as a Division 1.4G and offered for transportation, the shipping paper must contain the EX number or product code for each approved inflator, module, or pretensioner in association with the basic description required by §172.202(a) of this subchapter. Product codes must be traceable to the specific EX number assigned to the inflator, module, or pretensioner by the Associate Administrator. Further, if the EX number or product code is contained on the shipping paper then it is not required to be marked on the outside package.

(2) An air bag inflator, air bag module, or seat-belt pretensioner when classed as a Class 9 (UN3268) under the terms of paragraph (b)(1) of this section, is excepted from the EX number requirements of this paragraph (c).

(d) *Exceptions.* (1) An air bag inflator, air bag module, or seat-belt pretensioner that is classed as a Class 9 (UN3268) under the terms of paragraph (b)(1) of this section and is installed in a motor vehicle, aircraft, boat or other transport conveyance or its completed components, such as steering columns or door panels, is not subject to the requirements of this subchapter. An air bag inflator, air bag module, or seat-belt pretensioner that has been classed as a Division 1.4G and approved by the Associate Administrator and is installed in a motor vehicle, aircraft, boat or other transport conveyance or its completed components, such as steering columns or door panels, is not subject to the requirements of this subchapter.

(2) An air bag module containing an inflator that has been previously approved by the Associate Administrator for transportation is not required to be submitted for further examination or approval. For classifications granted after July 30, 2013, if the Class 9 designation for the inflator is contingent upon packaging or other special means specified by the authorized testing agency, the modules must be tested and certified separately to determine if

they can be shipped as “UN3268, Air bag modules, 9, PG III”.

(3) An air bag module containing an inflator that has previously been approved by the Associate Administrator as a Division 2.2 material is not required to be submitted for further examination to be reclassified as a Class 9 material.

(4) *Shipments to recycling or waste disposal facilities.* When offered for domestic transportation by highway, rail freight, cargo vessel or cargo aircraft, a serviceable air bag inflator, air bag module, or seat-belt pretensioner classed as either Class 9 (UN3268) or Division 1.4G removed from a motor vehicle that was manufactured as required for use in the United States may be offered for transportation and transported without compliance with the shipping paper requirement prescribed in paragraph (c) of this section. However, when these articles are shipped to a recycling facility, the word “Recycled” must be entered on the shipping paper immediately after the basic description prescribed in §172.202 of this subchapter. No more than one device is authorized in the packaging prescribed in paragraph (e)(1), (2) or (3) of this section. The device must be cushioned and secured within the package to prevent movement during transportation.

(e) *Packagings.* Rigid, outer packagings, meeting the general packaging requirements of part 173 are authorized as follows. Additionally, the UN specification packagings listed in paragraphs (e)(1), (2), and (3) of this section must meet the packaging specification and performance requirements of part 178 of this subchapter at the Packing Group III performance level. The packagings must be designed and constructed to prevent movement of the articles and inadvertent activation. Further, if the Class 9 designation is contingent upon packaging specified by the authorized testing agency, shipments of the air bag inflator, air bag module, or seat-belt pretensioner must be in compliance with the prescribed packaging.

(1) 1A2, 1B2, 1N2, 1D, 1G, or 1H2 drums.

(2) 3A2, 3B2, or 3H2 jerricans.

(3) 4A, 4B, 4N, 4C1, 4C2, 4D, 4F, 4G, 4H1, or 4H2 boxes.

(4) *Reusable high-strength containers or dedicated handling devices.* (i) Reusable containers manufactured from high-strength plastic, metal, or other suitable material, or other dedicated handling devices are authorized for shipment of air bag inflators, air bag modules, and seat-belt pretensioners from a manufacturing facility to the assembly facility, subject to the following conditions:

(A) The gross weight of the containers or handling devices may not exceed 1000 kg (2205 pounds). Containers or handling devices must provide adequate support to allow stacking at least three units high with no resultant damage;

(B) If not completely enclosed by design, the container or handling device must be covered with plastic, fiberboard, metal, or other suitable material. The covering must be secured to the container by banding or other comparable methods; and

(C) Internal dunnage must be sufficient to prevent movement of the devices within the container.

(ii) Reusable containers manufactured from high-strength plastic, metal, or other suitable material, or other dedicated handling devices are authorized for shipment of air bag inflators, air bag modules, and seat-belt pretensioners only to, between, and from, intermediate handling locations, provided they meet the conditions specified in paragraphs (e)(4)(i)(A) through (C) of this section and:

(A) The packages may be opened and re-packed by an intermediate handler as long as no modifications or changes are made to the packagings; and

(B) Transportation must be made by private or contract carrier.

(5) Packagings which were previously authorized in an approval issued by the Associate Administrator may continue to be used, provided a copy of the approval is maintained while such packaging is being used.

(6) *Devices removed from a vehicle.* When removed from, or were intended to be used in, a motor vehicle that was manufactured as required for use in the United States and offered for domestic transportation by highway to Recycling or Waste Disposal facilities, a serviceable air bag inflator, air bag

module, or seat-belt pretensioner classed as Class 9 UN3268 may be offered for transportation and transported in the following additional packaging:

(i) Specification and non-specification steel drums with a wall and lid thickness not less than 20 gauge. The lid must be securely affixed with a lever-locking or bolted-ring assembly. The lid of the drum must provide ventilation of the drum contents in a fire. The drum may be filled with any combination of air bag inflators, air bag modules, or seat-belt pretensioner devices to a capacity not greater than fifty (50) percent of the drum's total volume. In addition, inner packagings or cushioning may not be used to fill the void space; or

(ii) Outer packaging consisting of 4H2 solid plastic boxes or non-specification rugged reusable plastic outer packaging and inner static-resistant plastic bags or trays. If not completely enclosed by design, the container or handling device must be covered with plastic, fiberboard, metal or other suitable material. The covering must be secured to the container by banding or other comparable methods. The articles must be packed to prevent movement within the container during transportation.

(f) *Labeling.* Notwithstanding the provisions of §172.402 of this subchapter, each package or handling device must display a CLASS 9 label. Additional labeling is not required when the package contains no hazardous materials other than the devices.

(g) *Recordkeeping requirements.* (1) Following the examination of each new design type classed as a Class 9 in accordance with paragraph (b)(1) of this section, the person that conducted the examination must prepare a test report and provide the test report to the manufacturer of the air bag inflator, air bag module, or seat-belt pretensioner. At a minimum, the test report must contain the following information:

(i) Name and address of the test facility;

(ii) Name and address of the applicant;

(iii) Manufacturer of the device. For a foreign manufacturer, the U.S. agent or importer must be identified;

(iv) A test report number, drawing of the device, and description of the air bag inflator, air bag module, or seat-belt pretensioner in sufficient detail to ensure that the test report is traceable (e.g. a unique product identifier) to a specific inflator design;

(v) The tests conducted and the results; and

(vi) A certification that the air bag inflator, air bag module, or seat-belt pretensioner is classed as a Class 9 (UN3268).

(2) For at least fifteen (15) years after testing, a copy of each test report must be maintained by the authorizing testing agency. For as long as any air bag inflator, air bag module, or seat-belt pretensioner design is being manufactured, and for at least fifteen (15) years thereafter, a copy of each test report must be maintained by the manufacturer of the product.

(3) Test reports must be made available to a representative of the Department upon request.

[78 FR 45892, July 30, 2013]

§ 173.167 Consumer commodities.

(a) Effective January 1, 2013, a "consumer commodity" (see §171.8 of this subchapter) when offered for transportation by aircraft may only include articles or substances of Class 2 (non-toxic aerosols only), Class 3 (Packing Group II and III only), Division 6.1 (Packing Group III only), UN3077, UN3082, UN3175, UN3334, and UN3335, provided such materials do not have a subsidiary risk and are authorized aboard a passenger-carrying aircraft. Consumer commodities are excepted from the specification outer packaging requirements of this subchapter. Packages prepared under the requirements of this section are excepted from labeling and shipping papers when transported by highway or rail. Except as indicated in §173.24(i), each completed package must conform to §§173.24 and 173.24a of this subchapter. Additionally, except for the pressure differential requirements in §173.27(c), the requirements of §173.27 do not apply to packages prepared in accordance with this section. Packages prepared under the requirements of this section may

be offered for transportation and transported by all modes. As applicable, the following apply:

(1) *Inner and outer packaging quantity limits.* (i) Non-toxic aerosols, as defined in §171.8 of this subchapter and constructed in accordance with §173.306 of this part, in non-refillable, non-metal containers not exceeding 120 mL (4 fluid ounces) each, or in non-refillable metal containers not exceeding 820 mL (28 ounces) each, except that flammable aerosols may not exceed 500 mL (16.9 ounces) each;

(ii) Liquids, in inner packagings not exceeding 500 mL (16.9 ounces) each. Liquids must not completely fill an inner packaging at 55 °C;

(iii) Solids, in inner packagings not exceeding 500 g (1.0 pounds) each; or

(iv) Any combination thereof not to exceed 30 kg (66 pounds) gross weight as prepared for shipment.

(2) *Closures.* Friction-type closures must be secured by positive means. The body and closure of any packaging must be constructed so as to be able to adequately resist the effects of temperature and vibration occurring in conditions normally incident to air transportation. The closure device must be so designed that it is unlikely that it can be incorrectly or incompletely closed.

(3) *Absorbent material.* Inner packagings must be tightly packaged in strong outer packagings. Absorbent and cushioning material must not react dangerously with the contents of inner packagings. Glass or earthenware inner packagings containing liquids of Class 3 or Division 6.1, sufficient absorbent material must be provided to absorb the entire contents of the largest inner packaging contained in the outer packaging. Absorbent material is not required if the glass or earthenware inner packagings are sufficiently protected as packaged for transport that it is unlikely a failure would occur and, if a failure did occur, that it would be unlikely that the contents would leak from the outer packaging.

(4) *Drop test capability.* Breakable inner packagings (e.g., glass, earthenware, or brittle plastic) must be packaged to prevent failure under conditions normally incident to transport. Packages of consumer commodities as

prepared for transport must be capable of withstanding a 1.2 m drop on solid concrete in the position most likely to cause damage.

(5) *Stack test capability.* Packages of consumer commodities must be capable of withstanding, without failure or leakage of any inner packaging and without any significant reduction in effectiveness, a force applied to the top surface for a duration of 24 hours equivalent to the total weight of identical packages if stacked to a height of 3.0 m (including the test sample).

(b) When offered for transportation by aircraft:

(1) Packages prepared under the requirements of this section are to be marked as a limited quantity in accordance with §172.315(b)(1) and labeled as a Class 9 article or substance, as appropriate, in accordance with subpart E of part 172 of this subchapter; and

(2) *Pressure differential capability:* Except for UN3082, inner packagings intended to contain liquids must be capable of meeting the pressure differential requirements (75 kPa) prescribed in §173.27(c) of this part. The capability of a packaging to withstand an internal pressure without leakage that produces the specified pressure differential should be determined by successfully testing design samples or prototypes.

[78 FR 1115, Jan. 7, 2013, as amended at 78 FR 65482, Oct. 31, 2013]

§ 173.168 Chemical oxygen generators.

An oxygen generator, chemical (defined in §171.8 of this subchapter) may be transported only under the following conditions:

(a) *Approval.* A chemical oxygen generator that is shipped with an explosive or non-explosive means of initiation attached must be classed and approved by the Associate Administrator in accordance with the procedures specified in §173.56 of this subchapter.

(b) *Impact resistance.* A chemical oxygen generator, without any packaging, must be capable of withstanding a 1.8 meter drop onto a rigid, non-resilient, flat and horizontal surface, in the position most likely to cause actuation or loss of contents.

(c) *Protection against inadvertent actuation.* A chemical oxygen generator must incorporate one of the following

means of preventing inadvertent actuation:

(1) A chemical oxygen generator that is not installed in protective breathing equipment (PBE):

(i) Mechanically actuated devices:

(A) Two pins, installed so that each is independently capable of preventing the actuator from striking the primer;

(B) One pin and one retaining ring, each installed so that each is independently capable of preventing the actuator from striking the primer; or

(C) A cover securely installed over the primer and a pin installed so as to prevent the actuator from striking the primer and cover.

(ii) Electrically actuated devices: The electrical leads must be mechanically shorted and the mechanical short must be shielded in metal foil.

(iii) Devices with a primer but no actuator: A chemical oxygen generator that has a primer but no actuating mechanism must have a protective cover over the primer to prevent actuation from external impact.

(2) A chemical oxygen generator installed in a PBE must contain a pin installed so as to prevent the actuator from striking the primer, and be placed in a protective bag, pouch, case or cover such that the protective breathing equipment is fully enclosed in such a manner that the protective bag, pouch, case or cover prevents unintentional actuation of the oxygen generator.

(d) *Packaging.* A chemical oxygen generator and a chemical oxygen generator installed in equipment, (e.g., a PBE) must be placed in a rigid outer packaging that—

(1) Conforms to the requirements of either:

(i) Part 178, subparts L and M, of this subchapter at the Packing Group I or II performance level; or

(ii) The performance criteria in Air Transport Association (ATA) Specification No. 300 for a Category I Shipping Container.

(2) With its contents, is capable of meeting the following additional requirements when transported by cargo-only aircraft:

(i) The Flame Penetration Resistance Test specified in appendix E to part 178 of this subchapter.

(ii) The Thermal Resistance Test specified in appendix D to part 178 of this subchapter.

(e) *Equipment marking.* The outside surface of a chemical oxygen generator must be marked to indicate the presence of an oxygen generator (e.g., “oxygen generator, chemical”). The outside surface of equipment containing a chemical oxygen generator that is not readily apparent (e.g., a sealed passenger service unit) must be clearly marked to indicate the presence of the oxygen generator (example: “Oxygen Generator Inside”).

(f) *Items forbidden in air transportation.* (1) A chemical oxygen generator is forbidden for transportation on board a passenger-carrying aircraft.

(2) A chemical oxygen generator is forbidden for transportation by both passenger-carrying and cargo-only aircraft after:

(i) The manufacturer’s expiration date; or

(ii) The contents of the generator have been expended.

[72 FR 4455, Jan. 31, 2007, as amended at 72 FR 55097, Sept. 28, 2007; 74 FR 2259, Jan. 14, 2009; 74 FR 53188, Oct. 16, 2009; 76 FR 56316, Sept. 13, 2011]

§ 173.170 Black powder for small arms.

Black powder for small arms that has been classed in Division 1.1 may be reclassified as a Division 4.1 material, for domestic transportation by motor vehicle, rail freight, and cargo vessel only, subject to the following conditions:

(a) The powder must be examined and approved for Division 1.1 and Division 4.1 classification in accordance with §§ 173.56 and 173.58;

(b) The total quantity of black powder in one motor vehicle, rail car, or freight container may not exceed 45.4 kg (100 pounds) net mass, and no more than four freight containers may be on board one cargo vessel;

(c) The black powder must be packed in inner metal or heavy wall conductive plastic receptacles not over 454 g (16 ounces) net capacity each, with no more than 25 cans in one outer UN 4G fiberboard box. The inner packagings must be arranged and protected so as to prevent simultaneous ignition of the contents. The complete package must

§ 173.171

be of the same type which has been examined as required in § 173.56;

(d) Each completed package must be marked "BLACK POWDER FOR SMALL ARMS" and "NA 0027"; and

(e) Each package must bear the FLAMMABLE SOLID label.

[Amdt. 173-255, 61 FR 50626, Sept. 26, 1996, as amended at Amdt. 173-255, 62 FR 14338, Mar. 26, 1997]

§ 173.171 Smokeless powder for small arms.

Smokeless powder for small arms which has been classed in Division 1.3 or Division 1.4 may be reclassified in Division 4.1, for domestic transportation by motor vehicle, rail car, vessel, or cargo-only aircraft, subject to the following conditions:

(a) Powders that have been approved as Division 1.3C or Division 1.4C may be reclassified to Division 4.1 in accordance with §§ 173.56 and 173.58 of this part.

(b) The total quantity of smokeless powder may not exceed 45.4 kg (100 pounds) net mass in:

(1) One rail car, motor vehicle, or cargo-only aircraft; or

(2) One freight container on a vessel, not to exceed four freight containers per vessel.

(c) Only combination packagings with inner packagings not exceeding 3.6 kg (8 pounds) net mass are authorized. Inner packagings must be arranged and protected so as to prevent simultaneous ignition of the contents. The complete package must be of the same type which has been examined as required in § 173.56 of this part.

(d) Inside packages that have been examined and approved by the Associate Administrator may be packaged in UN 4G fiberboard boxes meeting the Packing Group I performance level, provided all inside containers are packed to prevent shifting and the net weight of smokeless powder in any one box does not exceed 7.3 kg (16 pounds).

[Amdt. 173-224, 55 FR 52643, Dec. 21, 1990, as amended at 56 FR 66270, Dec. 20, 1991; Amdt. 173-241, 59 FR 67509, Dec. 29, 1994; Amdt. 173-253, 61 FR 27174, May 30, 1996; 66 FR 45379, Aug. 28, 2001; 68 FR 61941, Oct. 30, 2003; 75 FR 53597, Sept. 1, 2010; 78 FR 14714, Mar. 7, 2013; 78 FR 65482, Oct. 31, 2013]

49 CFR Ch. I (10-1-14 Edition)

§ 173.172 Aircraft hydraulic power unit fuel tank.

Aircraft hydraulic power unit fuel tanks containing a mixture of anhydrous hydrazine and monomethyl hydrazine (M86 fuel) and designed for installation as complete units in aircraft are excepted from the specification packaging requirements of this subchapter when they conform to either of the following conditions:

(a) The unit must consist of an aluminum pressure vessel made from tubing and having welded heads. Primary containment of the fuel within this vessel must consist of a welded aluminum bladder having a maximum internal volume of 46 L (12 gallons). The outer vessel must have a minimum design gauge pressure of 1,275 kPa (185 psig) and a minimum burst gauge pressure of 2,755 kPa (400 psig). Each vessel must be leak-checked during manufacture and before shipment and must be found leakproof. The complete inner unit must be securely packed in non-combustible cushioning material, such as vermiculite, in a strong outer tightly closed metal packaging which will adequately protect all fittings. Maximum quantity of fuel per unit and package is 42 L (11 gallons); or

(b) The unit must consist of an aluminum pressure vessel. Primary containment of the fuel within this vessel must consist of a welded hermetically sealed fuel compartment with an elastomeric bladder having a maximum internal volume of 46 L (12 gallons). The pressure vessel must have a minimum design gauge pressure of 5,170 kPa (750 psig). Each vessel must be leak-checked during manufacture and before shipment and must be securely packed in non-combustible cushioning material, such as vermiculite, in a strong outer tightly closed metal packaging which will adequately protect all fittings. Maximum quantity of fuel per unit and package is 42 L (11 gallons).

[Amdt. 173-224, 55 FR 52643, Dec. 21, 1990, as amended by 66 FR 45380]

§ 173.173 Paint, paint-related material, adhesives, ink and resins.

(a) When the § 172.101 table specifies that a hazardous material be packaged under this section, the following requirements apply. Except as otherwise

provided in this part, the description "Paint" is the proper shipping name for paint, lacquer, enamel, stain, shellac, varnish, liquid aluminum, liquid bronze, liquid gold, liquid wood filler, and liquid lacquer base. The description "Paint-related material" is the proper shipping name for a paint thinning, drying, reducing or removing compound. However, if a more specific description is listed in the §172.101 table of this subchapter, that description must be used.

(b) Paint, paint-related material, adhesives, ink and resins must be packaged as follows:

(1) As prescribed in §173.202 of this part if it is a Packing Group II material or §173.203 of this part if it is a Packing Group III material; or

(2) In inner glass packagings of not over 1 L (0.3 gallon) capacity each or inner metal packagings of not over 5 L (1 gallon) each, packed in a strong outer packaging. Packages must conform to the packaging requirements of subpart B of this part but need not conform to the requirements of part 178 of this subchapter.

[Amdt. 173-224, 55 FR 52643, Dec. 21, 1990, as amended at 56 FR 66270, Dec. 20, 1991; Amdt. 173-241, 59 FR 67509, Dec. 29, 1994]

§ 173.174 Refrigerating machines.

A refrigerating machine assembled for shipment and containing 7 kg (15 pounds) or less of a flammable liquid for its operation in a strong, tight receptacle is excepted from labeling (except when offered for transportation or transported by air) and the specification packaging requirements of this subchapter. In addition, shipments are not subject to subpart F of part 172 of this subchapter (Placarding), to part 174 of this subchapter (Carriage by rail) except §174.24 (Shipping papers) and to part 177 (Carriage by highway) of this subchapter except §177.817 (Shipping papers).

§ 173.175 Permeation devices.

Permeation devices that contain hazardous materials and that are used for calibrating air quality monitoring devices are not subject to the requirements of this subchapter provided the following requirements are met:

(a) Each device must be constructed of a material compatible with the hazardous materials it contains;

(b) The total contents of hazardous materials in each device is limited to 2 ml (0.07 ounces) and the device must not be liquid full at 55 °C (131 °F);

(c) Each permeation device must be placed in a sealed, high impact resistant, tubular inner packaging of plastic or equivalent material. Sufficient absorbent material must be contained in the inner packaging to completely absorb the contents of the device. The closure of the inner packaging must be securely held in place with wire, tape or other positive means;

(d) Each inner packaging must be contained in a secondary packaging constructed of metal, or plastic having a minimum thickness of 1.5 mm (0.06 inches). The secondary packaging must be hermetically sealed;

(e) The secondary packaging must be securely packed in strong outer packaging. The completed package must be capable of withstanding, without breakage or leakage of any inner packaging and without significant reduction in effectiveness:

(1) The following free drops onto a rigid, non resilient, flat and horizontal surface from a height of 1.8 m (5.9 feet):

- (i) One drop flat on the bottom;
- (ii) One drop flat on the top;
- (iii) One drop flat on the long side;
- (iv) One drop flat on the short side;
- (v) One drop on a corner at the junction of three intersecting edges; and

(2) A force applied to the top surface for a duration of 24 hours, equivalent to the total weight of identical packages if stacked to a height of 3 m (10 feet) (including the test sample).

(3) Each of the above tests may be performed on different but identical packages.

(f) The gross mass of the completed package must not exceed 30 kg.

(g) For transportation by aircraft, permeation devices must be transported as cargo and may not be carried onboard an aircraft by passengers or crewmembers in carry-on baggage, checked baggage, or on their person unless specifically excepted by §175.10.

[76 FR 43530, July 20, 2011, as amended at 78 FR 1087, Jan. 7, 2013]

§ 173.176 Capacitors.

(a) Capacitors, including capacitors containing an electrolyte that does not meet the definition of any hazard class or division as defined in this part, must conform to the following requirements:

(1) Capacitors not installed in equipment must be transported in an uncharged state;

(2) Each capacitor must be protected against a potential short circuit hazard in transport as follows:

(i) When a capacitor's energy storage capacity is less than or equal to 10 Wh or when the energy storage capacity of each capacitor in a module is less than or equal to 10 Wh, the capacitor or module must be protected against short circuit or be fitted with a metal strap connecting the terminals; or

(ii) When the energy storage capacity of a capacitor or a capacitor in a module is more than 10 Wh, the capacitor or module must be fitted with a metal strap connecting the terminals;

(3) Capacitors containing an electrolyte that meets the definition of one or more hazard class or division as defined in this part, must be designed to withstand a 95 kPa (0.95 bar, 14 psi) pressure differential;

(4) Capacitors must be designed and constructed to safely relieve pressure that may build up in use, through a vent or a weak point in the capacitor casing. Any liquid that is released upon venting must be contained by the packaging or by the equipment in which a capacitor is installed; and

(5) Capacitors must be marked with the energy storage capacity in Wh.

(b) Capacitors must be packed in strong outer packagings. For transport by air, capacitors must be securely cushioned within the outer packagings. Capacitors installed in equipment may be offered for transport unpackaged or on pallets, when the capacitors are afforded equivalent protection by the equipment in which they are contained.

(c) Capacitors containing an electrolyte not meeting the definition of any hazard class or division as defined in this part, including when installed in equipment, are not subject to any other requirements of this subchapter.

(d) Capacitors containing an electrolyte that meets the definition of one or

more hazard class or division as defined in this part, with an energy storage capacity of 10 Wh or less are not subject to any other requirements of this subchapter, when they are capable of withstanding a 1.2 m (3.9 feet) drop test unpackaged onto a rigid, non-resilient, flat and horizontal surface without loss of contents.

(e) Capacitors containing an electrolyte meeting the definition of one or more hazard class or division as defined in this part, that are not installed in equipment, and with an energy storage capacity of more than 10 Wh are subject to the requirements of this subchapter.

(f) Capacitors installed in equipment and containing an electrolyte meeting the definition of one or more hazard class or division as defined in this part, are not subject to any other requirements of this subchapter, provided the equipment is packaged in a strong outer packaging and in such a manner as to prevent accidental functioning of the capacitors during transport. Large, robust equipment containing capacitors may be offered for transport unpackaged or on pallets when the capacitors are afforded equivalent protection by the equipment in which they are contained.

[78 FR 1087, Jan. 7, 2013, as amended at 78 FR 65482, Oct. 31, 2013]

§ 173.181 Pyrophoric materials (liquids).

When the §172.101 table specifies that a hazardous material be packaged under this section, only the following non-bulk packagings are authorized:

(a) Specification steel or nickel cylinders prescribed for any compressed gas except acetylene having a minimum design pressure of 1206 kPa (175 psig). Cylinders with valves must be:

(1) Equipped with steel valve protection caps or collars, unless overpacked; or

(2) Overpacked in a wooden box (4C1, 4C2, 4D or 4F); fiberboard box (4G), or plastic box (4H1 or 4H2). Cylinders must be secured to prevent shifting in the box and, when offered for transportation or transported, must be so loaded that pressure relief devices remain in the vapor space of the cylinder. (See §177.838(h) of this subchapter.)

(b) Steel boxes (4A), aluminum boxes (4B), metal boxes, other than steel or aluminum (4N), wooden boxes (4C1, 4C2, 4D, or 4F) or fiberboard boxes (4G); steel drums (1A1 or 1A2), aluminum drums (1B1 or 1B2), metal drums, other than steel or aluminum (1N1 or 1N2), plywood drums (1D), or fiber drums (1G); or steel jerricans (3A1 or 3A2) or aluminum jerricans (3B1 or 3B2) enclosing not more than four strong, tight metal cans with inner receptacles of glass or metal, not over 1 L (0.3 gallon) capacity each, having positive screwcap closures adequately gasketed. Inner packagings must be cushioned on all sides with dry, absorbent, incombustible material in a quantity sufficient to absorb the entire contents. The strong, tight metal cans must be closed by positive means, not by friction.

(c) Steel drums (1A1 or 1A2), aluminum drums (1B1 or 1B2), metal drums, other than steel or aluminum (1N1 or 1N2) or fiber drums (1G); steel jerricans (3A1 or 3A2) or aluminum jerricans (3B1 or 3B2); or steel boxes (4A), aluminum boxes (4B) or metal boxes, other than steel or aluminum (4N) not exceeding 220 L (58 gallons) capacity each with strong, tight inner metal cans not over 4.0 L (1 gallon) capacity each. The strong, tight metal cans must be closed by positive means, not friction.

[Amdt. 173-224, 55 FR 52643, Dec. 21, 1990, as amended at 56 FR 66270, Dec. 20, 1991; 65 FR 58629, Sept. 29, 2000; 66 FR 45183, 45380, Aug. 28, 2001; 68 FR 24660, May 8, 2003; 68 FR 61941, Oct. 30, 2003; 78 FR 1087, Jan. 7, 2013]

§ 173.182 Barium azide—50 percent or more water wet.

Barium azide—50 percent or more water wet, must be packed in wooden boxes (4C1, 4C2, 4D, or 4F) or fiber drums (1G) with inner glass packagings not over 0.5 kg (1.1 pounds) capacity each. Packagings must have rubber stoppers wire tied for securement. If transportation is to take place when and where freezing weather is possible, a suitable antifreeze solution must be used to prevent freezing. Each packaging must conform to the requirements of part 178 of this subchapter at the Packing Group I performance level.

§ 173.183 Nitrocellulose base film.

Films, nitrocellulose base, must be packaged in packagings conforming to the requirements of part 178 of this subchapter at the Packing Group III performance level, as follows:

(a) In steel drums (1A2), aluminum drums (1B2), other metal drums (4A2), steel jerricans (3A2), aluminum jerricans (3B2), steel, aluminum or other metal (4A, 4B, 4N) boxes, wooden (4C1, 4C2), plywood (4D) or reconstituted wood (4F) boxes or plywood drums (1D) with each reel in a tightly closed metal can, polypropylene canister, or strong cardboard or fiberboard inner packaging with cover held in place by adhesive tape or paper; or

(b) In fiberboard (4G) boxes or fiber drums (1G) with a single tightly closed metal can, polypropylene canister, or strong cardboard or fiberboard inner packaging with cover held in place by adhesive tape or paper; authorized only for not over 600 m (1969 feet) of film.

[Amdt. 173-224, 55 FR 52643 Dec. 21, 1990, as amended by Amdt. 173-255, 61 FR 50627, Sept. 26, 1996; 78 FR 1087, Jan. 7, 2013]

§ 173.184 Highway or rail fusee.

(a) A fusee is a device designed to burn at a controlled rate and to produce visual effects for signaling purposes. The composition of the fusee must be such that the fusee will not ignite spontaneously or undergo marked decomposition when subjected to a temperature of 75 °C (167 °F) for 48 consecutive hours.

(b) Fusees (highway and railway) must be packaged in steel (1A2), aluminum (1B2) or other metal (1N2) drums, steel (3A2) or aluminum (3B2) jerricans, steel (4A), aluminum (4B) or other metal (4N) boxes, wooden (4C1, 4C2), plywood (4D) or reconstituted wood (4F) boxes or in fiberboard boxes (4G), plywood (1D) or fiber (1G) drums. If the fusees are equipped with spikes packagings must have reinforced ends to prevent penetration of spikes through the outer packagings; packages must be capable of passing drop test requirements (§ 178.603 of this subchapter), including at least one drop with spike in a downward position, and other requirements of part 178 of this

§ 173.185

49 CFR Ch. I (10–1–14 Edition)

subchapter, at the Packing Group II performance level.

[Amdt. 173–224, 55 FR 52643, Dec. 21, 1990, as amended at 66 FR 45379; 78 FR 1088, Jan. 7, 2013]

§ 173.185 Lithium cells and batteries.

As used in this section, *lithium cell(s) or battery(ies)* includes both lithium metal and lithium ion chemistries. *Equipment* means the device or apparatus for which the lithium cells or batteries will provide electrical power for its operation.

(a) *Classification.* (1) Each lithium cell or battery must be of the type proven to meet the criteria in Part III, sub-section 38.3 of the UN Manual of Tests and Criteria (IBR; see §171.7 of this subchapter). Lithium cells and batteries are subject to these tests regardless of whether the cells used to construct the battery are of a tested type.

(i) Cells and batteries manufactured according to a type meeting the requirements of sub-section 38.3 of the UN Manual of Tests and Criteria, Revision 3, Amendment 1 or any subsequent revision and amendment applicable at the date of the type testing may continue to be transported, unless otherwise provided in this subchapter.

(ii) Cell and battery types only meeting the requirements of the UN Manual of Tests and Criteria, Revision 3, are no longer valid. However, cells and batteries manufactured in conformity with such types before July 2003 may continue to be transported if all other applicable requirements are fulfilled.

(2) Each person who manufactures lithium cells or batteries must create a record of satisfactory completion of the testing required by this paragraph prior to offering the lithium cell or battery for transport and must:

(i) Maintain this record for as long as that design is offered for transportation and for one year thereafter; and

(ii) Make this record available to an authorized representative of the Federal, state or local government upon request.

(3) Except for cells or batteries meeting the requirements of paragraph (c) of this section, each lithium cell or battery must:

(i) Incorporate a safety venting device or be designed to preclude a vio-

lent rupture under conditions normally incident to transport;

(ii) Be equipped with effective means of preventing external short circuits; and

(iii) Be equipped with an effective means of preventing dangerous reverse current flow (e.g., diodes or fuses) if a battery contains cells, or a series of cells that are connected in parallel.

(b) *Packaging.* (1) Each package offered for transportation containing lithium cells or batteries, including lithium cells or batteries packed with, or contained in, equipment, must meet all applicable requirements of subpart B of this part.

(2) Lithium cells or batteries, including lithium cells or batteries packed with, or contained in, equipment, must be packaged in a manner to prevent:

(i) Short circuits;

(ii) Movement within the outer package; and

(iii) Accidental activation of the equipment.

(3) For packages containing lithium cells or batteries offered for transportation:

(i) The lithium cells or batteries must be placed in non-metallic inner packagings that completely enclose the cells or batteries, and separate the cells or batteries from contact with equipment, other devices, or conductive materials (e.g., metal) in the packaging.

(ii) The inner packagings containing lithium cells or batteries must be placed in one of the following packagings meeting the requirements of part 178, subparts L and M, of this subchapter at the Packing Group II level:

(A) Metal (4A, 4B, 4N), wooden (4C1, 4C2, 4D, 4F), fiberboard (4G), or solid plastic (4H1, 4H2) box;

(B) Metal (1A2, 1B2, 1N2), plywood (1D), fiber (1G), or plastic (1H2) drum;

(C) Metal (3A2, 3B2) or plastic (3H2) jerrican.

(iii) When packed with equipment lithium cells or batteries must:

(A) Be placed in inner packagings that completely enclose the cell or battery, then placed in an outer packaging. The completed package for the cells or batteries must meet the Packing Group II performance requirements

as specified in paragraph (b)(3)(ii) of this section; or

(B) Be placed in inner packagings that completely enclose the cell or battery, then placed with equipment in a package that meets the Packing Group II performance requirements as specified in paragraph (b)(3)(ii) of this section.

(4) When lithium cells or batteries are contained in equipment:

(i) The outer packaging must be constructed of suitable material of adequate strength and design in relation to the capacity and intended use of the packaging, unless the lithium cells or batteries are afforded equivalent protection by the equipment in which they are contained;

(ii) Equipment must be secured against movement within the outer packaging and be packed so as to prevent accidental operation during transport; and

(iii) Any spare lithium ion cells or batteries packed with the equipment must be packaged in accordance with paragraph (b)(3) of this section.

(5) Lithium batteries that weigh 12 kg (26.5 pounds) or more and have a strong, impact-resistant outer casing and assemblies of such batteries, may be packed in strong outer packagings; in protective enclosures (for example, in fully enclosed or wooden slatted crates); or on pallets or other handling devices, instead of packages meeting the UN performance packaging requirements in paragraphs (b)(3)(ii) and (b)(4) of this section. Batteries or battery assemblies must be secured to prevent inadvertent movement, and the terminals may not support the weight of other superimposed elements. Batteries or battery assemblies packaged in accordance with this paragraph are not permitted for transportation by passenger-carrying aircraft, and may be transported by cargo aircraft only if approved by the Associate Administrator.

(c) *Exceptions for smaller cells or batteries.* A package containing lithium cells or batteries, or lithium cells or batteries packed with, or contained in, equipment, that meets the conditions of this paragraph, is excepted from the requirements in subparts C through H of part 172 of this subchapter and the

UN performance packaging requirements in paragraphs (b)(3)(ii) and (b)(4) of this section under the following conditions and limitations.

(1) *Size limits:*

(i) The Watt-hour rating may not exceed 20 Wh for a lithium ion cell or 100 Wh for a lithium ion battery. After December 31, 2015, each lithium ion battery subject to this provision must be marked with the Watt-hour rating on the outside case.

(ii) The lithium content may not exceed 1 g for a lithium metal cell or 2 g for a lithium metal battery.

(iii) Except when lithium metal cells or batteries are packed with or contained in equipment in quantities less than 5 kg net weight, the outer package that contains lithium metal cells or batteries must be marked: "PRIMARY LITHIUM BATTERIES—FORBIDDEN FOR TRANSPORT ABOARD PASSENGER AIRCRAFT" or "LITHIUM METAL BATTERIES—FORBIDDEN FOR TRANSPORT ABOARD PASSENGER AIRCRAFT."

(iv) For transportation by highway or rail only, the lithium content of the cell and battery may be increased to 5 g for a lithium metal cell and 25 g for a lithium metal battery and 60 Wh for a lithium ion cell or 300 Wh for a lithium ion battery provided the outer package is marked: "LITHIUM BATTERIES—FORBIDDEN FOR TRANSPORT ABOARD AIRCRAFT AND VESSEL."

(v) The marking specified in paragraphs (c)(1)(ii) and (c)(1)(iii) of this section must have a background of contrasting color, and the letters in the marking must be:

(A) At least 6 mm (0.25 inch) on packages having a gross weight of 30 kg (66 pounds) or less, except that smaller font may be used as necessary when package dimensions so require.

(B) At least 12 mm (0.5 inch) in height on packages having a gross weight of more than 30 kg (66 pounds).

(vi) Except when lithium cells or batteries are packed with, or contained in, equipment, each package must not exceed 30 kg (66 pounds) gross weight.

(2) *Packaging.* Except when lithium cells or batteries are contained in equipment, each package must be capable of withstanding a 1.2 meter drop

§ 173.185

49 CFR Ch. I (10–1–14 Edition)

test, in any orientation, without damage to the cells or batteries contained in the package, without shifting of the contents that would allow battery-to-battery (or cell-to-cell) contact, and without release of the contents of the package.

(3) *Hazard communication.* Except for a package containing button cell batteries installed in equipment (including circuit boards), or no more than four lithium cells or two lithium batteries installed in the equipment:

(i) The outer package must be marked with:

(A) An indication that the package contains “lithium metal” or “lithium ion” cells or batteries, as appropriate;

(B) An indication that the package is to be handled with care and that a flammable hazard exists if the package is damaged;

(C) An indication that special procedures must be followed in the event the package is damaged, to include inspection and repacking if necessary;

(D) A telephone number for additional information.

(ii) Each shipment of one or more packages marked in accordance with this paragraph must be accompanied by a document that includes the following:

(A) An indication that the package contains “lithium metal” or “lithium ion” cells or batteries, as appropriate;

(B) An indication that the package is to be handled with care and that a flammable hazard exists if the package is damaged;

(C) An indication that special procedures must be followed in the event the package is damaged, to include inspection and repacking if necessary; and

(D) A telephone number for additional information.

(4) *Air transportation.* For transportation by aircraft, lithium cells and batteries may not exceed the limits in the following table. The limits on the maximum number of batteries and maximum net quantity of batteries in the following table may not be combined in the same package:

Contents	Lithium metal cells and/or batteries with a lithium content not more than 0.3 g	Lithium metal cells with a lithium content more than 0.3 g but not more than 1 g	Lithium metal batteries with a lithium content more than 0.3 g but not more than 2 g	Lithium ion cells and/or batteries with a Watt-hour rating not more than 2.7 Wh	Lithium ion cells with a Watt-hour rating more than 2.7 Wh but not more than 20 Wh	Lithium ion batteries with a Watt-hour rating more than 2.7 Wh but not more than 100 Wh
Maximum number of cells/batteries per package.	No Limit	8 cells	2 batteries	No Limit	8 cells	2 batteries.
Maximum net quantity (mass) per package.	2.5 kg	n/a	n/a	2.5 kg	n/a	n/a.

(i) The outer package must be durably and legibly marked with the following handling marking, which is du-

table, legible and displayed on a background of contrasting color:



(A) The marking must be not less than 120 mm (4.7 inches) wide by 110 mm (4.3 inches) high except markings of 105 mm (4.1 inches) wide by 74 mm (2.9 inches) high may be used on a package containing lithium batteries when the package is too small for the larger marking;

(B) The symbols and letters must be black and the border must be red;

(C) The "*" must be replaced by "lithium ion battery" and/or "Lithium metal battery" as appropriate and the "xxx-xxx-xxxx" must be replaced by a telephone number for additional information; and

(D) When packages required to bear the handling marking are placed in an overpack, the handling marking must either be clearly visible through the overpack, or the handling marking must also be affixed on the outside of the overpack, and the overpack must be marked with the word "Overpack".

(ii) Each shipment with packages required to bear the handling marking must include an indication the shipment contains "lithium ion batteries" or "lithium metal batteries," as appropriate, and when an air waybill is used, an indication on the air waybill of compliance with this paragraph (c)(4) (or the applicable ICAO Packing Instruction).

(iii) For lithium batteries packed with, or contained in, equipment, the number of batteries in each package is limited to the minimum number required to power the piece of equipment, plus two spares, and the total net quantity (mass) of the lithium cells or batteries in the completed package must not exceed 5 kg.

(iv) Each person who prepares a package for transport containing lithium cells or batteries, including cells or batteries packed with, or contained in, equipment in accordance with the conditions and limitations in this paragraph, must receive adequate instruction on these conditions and limitations, commensurate with their responsibilities.

(v) A package that exceeds the number or quantity (mass) limits in the table shown in this paragraph (c)(4) is subject to all applicable requirements of this subchapter, except that a package containing no more than 2.5 kg lithium metal cells or 10 kg lithium ion cells or batteries is not subject to:

(A) The UN performance packaging requirements in paragraphs (b)(3)(ii) of this section when the package displays both the lithium battery handling marking and the Class 9 label; and

(B) The shipping paper requirements of subpart C of part 172 when the offeror provides the air carrier alternative written documentation containing the name and address of the offeror and consignee, the UN number, an indication of compliance with this paragraph (c)(4) applies (or the applicable ICAO Packing Instruction), and the number of packages and the gross mass of each package and notification is given to the pilot-in-command in accordance with §175.33 of this subchapter.

(d) *Lithium cells or batteries shipped for disposal or recycling.* A lithium cell or battery, including a lithium cell or battery contained in equipment, that is transported by motor vehicle to a permitted storage facility or disposal site, or for purposes of recycling, is excepted from the testing and record keeping requirements of paragraph (a) and the specification packaging requirements of paragraph (b)(3) of this section, when packed in a strong outer packaging conforming to the requirements of §§173.24 and 173.24a. A lithium cell or battery that meets the size, packaging, and hazard communication conditions in paragraph (c)(1)–(3) of this section is excepted from subparts C through H of part 172 of this subchapter.

(e) *Low production runs and prototypes.* Low production runs (i.e., annual production runs consisting of not more than 100 lithium cells or batteries), or prototype lithium cells or batteries transported for purposes of testing, are excepted from the testing and record keeping requirements of paragraph (a) of this section provided:

(1) Except as provided in paragraph (e)(3) of this section, each cell or battery is individually packed in a non-metallic inner packaging, inside an outer packaging, and is surrounded by cushioning material that is non-combustible and non-conductive;

(2) The inner packages containing lithium cells or batteries are packed in one of the following packagings that meet the requirements of part 178, Subparts L and M at Packing Group I level.

(i) Metal (4A, 4B, 4N), wooden (4C1, 4C2, 4D, 4F), or solid plastic (4H2) box;

(ii) Metal (1A2, 1B2, 1N2), plywood (1D), or plastic (1H2) drum.

(3) Lithium batteries that weigh 12 kg (26.5 pounds) or more and have a strong, impact-resistant outer casing or assemblies of such batteries, may be packed in strong outer packagings, in protective enclosures (for example, in fully enclosed or wooden slatted crates), or on pallets or other handling devices, instead of packages meeting the UN performance packaging requirements in paragraphs (b)(3)(ii) and (b)(4) of this section. The battery or battery assembly must be secured to prevent inadvertent movement, and the terminals may not support the weight of other superimposed elements;

(4) Irrespective of the limit specified in column (9B) of the §172.101 Hazardous Materials Table, the battery or battery assembly prepared for transport in accordance with this paragraph may have a mass exceeding 35 kg gross weight when transported by cargo aircraft; and

(5) Batteries or battery assemblies packaged in accordance with this paragraph are not permitted for transportation by passenger-carrying aircraft, and may be transported by cargo aircraft only if approved by the Associate Administrator prior to transportation.

(f) *Damaged, defective, or recalled cells or batteries.* Lithium cells or batteries, that have been damaged or identified by the manufacturer as being defective for safety reasons, that have the potential of producing a dangerous evolution of heat, fire, or short circuit (e.g. those being returned to the manufacturer for safety reasons) may be transported by highway, rail or vessel only, and must be packaged as follows:

(1) Each cell or battery must be placed in individual, non-metallic inner packaging that completely encloses the cell or battery;

(2) The inner packaging must be surrounded by cushioning material that is non-combustible, non-conductive, and absorbent; and

(3) Each inner packaging must be individually placed in one of the following packagings meeting the requirements of part 178, subparts L and M, of this subchapter at the Packing Group I level:

(i) Metal (4A, 4B, 4N), wooden (4C1, 4C2, 4D, 4F), or solid plastic (4H2) box;

(ii) Metal (1A2, 1B2, 1N2), plywood (1D), or plastic (1H2) drum; and

(4) The outer package must be marked with an indication that the package contains a “Damaged/defective lithium ion battery” and/or “Damaged/defective lithium metal battery” as appropriate.

(g) *Approval.* A lithium cell or battery that does not conform to the provisions of this subchapter may be transported only under conditions approved by the Associate Administrator.

[79 FR 46036, Aug. 6, 2014]

§ 173.186 Matches.

(a) Matches must be of a type which will not ignite spontaneously or undergo marked decomposition when subjected for 8 consecutive hours to a temperature of 93 °C (200 °F).

(b) *Definitions.* (1) *Fusee matches* are matches the heads of which are prepared with a friction-sensitive igniter composition and a pyrotechnic composition which burns with little or no flame, but with intense heat.

(2) *Safety matches* are matches combined with or attached to the box, book or card that can be ignited by friction only on a prepared surface.

(3) *Strike anywhere matches* are matches that can be ignited by friction on a solid surface.

(4) *Wax “Vesta” matches* are matches that can be ignited by friction either on a prepared surface or on a solid surface.

(c) Safety matches and wax “Vesta” matches must be tightly packed in securely closed inner packagings to prevent accidental ignition under conditions normally incident to transportation, and further packed in outer fiberboard, wooden, or other equivalent-type packagings. These matches in outer packagings not exceeding 23 kg (50 pounds) gross weight are not subject to any other requirement (except marking) of this subchapter. These matches may be packed in the same outer packaging with materials not subject to this subchapter.

(d) Strike-anywhere matches may not be packed in the same outer packaging with any material other than safety matches or wax “Vesta” matches, which must be packed in separate inner packagings.

(e) *Packagings.* Strike-anywhere matches must be tightly packed in securely closed chipboard, fiberboard, wooden, or metal inner packagings to prevent accidental ignition under conditions normally incident to transportation. Each inner packaging may contain no more than 700 strike-anywhere matches and must be packed in outer steel drums (1A1, 1A2), aluminum drums (1B1, 1B2), other metal drums (1N1, 1N2), steel jerricans (3A1, 3A2), aluminum jerricans (3B1, 3B2), steel (4A), aluminum (4N), other metal (4N) boxes, wooden (4C1, 4C2), plywood (4D), reconstituted wood (4F) or fiberboard (4G) boxes, plywood (1D) or fiber (1G) drums. Gross weight of fiberboard boxes (4G) must not exceed 30 kg (66 pounds). Gross weight of other outer packagings must not exceed 45 kg (100 pounds).

[Amdt. 173-224, 55 FR 52643, Dec. 21, 1990, as amended at 69 FR 76157, Dec. 20, 2004; 78 FR 1088, Jan. 7, 2013]

§ 173.187 Pyrophoric solids, metals or alloys, n.o.s.

Packagings for pyrophoric solids, metals, or alloys, n.o.s. must conform to the requirements of part 178 of this subchapter at the packing group performance level specified in the §172.101 Table. These materials must be packaged as follows:

(a) In steel, aluminum or other metal boxes (4A, 4B or 4N) and contain no more than 15 kg (33 pounds) each.

(b) In wooden boxes (4C1, 4C2, 4D, or 4F) with inner metal receptacles which have a positive (not friction) means of closure and contain not more than 15 kg (33 pounds) each.

(c) In fiberboard boxes (4G) with inner metal receptacles which have a positive (not friction) means of closure and contain not more than 7.5 kg (17 pounds) each.

(d) In steel, aluminum or other metal drums (1A1, 1A2, 1B1, 1B2, 1N1 or 1N2) with a gross mass not exceeding 150 kg (331 pounds) per drum.

(e) In plywood drums (1D) with inner metal receptacles which have a positive (not friction) means of closure and contain not more than 15 kg (33 pounds) each.

§ 173.188

49 CFR Ch. I (10–1–14 Edition)

(f) In fiber drums (1G) with inner metal receptacles which have a positive (not friction) means of closure and contain not more than 15 kg (33 pounds) each.

(g) In specification cylinders, as prescribed for any compressed gas, except for Specifications 8 and 3HT.

[71 FR 78632, Dec. 29, 2006, as amended at 78 FR 1088, Jan. 7, 2013]

§ 173.188 White or yellow phosphorus.

Phosphorus, white or yellow, when offered for transportation or transported by rail, highway, or water, must be packaged in water or dry in packagings conforming to the requirements of part 178 of this subchapter at the Packing Group I performance level, as follows:

(a) When placed in water, it must be packaged in specification packagings as follows:

(1) Steel, aluminum or other metal boxes (4A, 4B or 4N) or wooden boxes (4C1, 4C2, 4D, or 4F) with:

(i) Inner hermetically sealed (soldered) metal cans, enclosed in other hermetically sealed (soldered) metal cans, or

(ii) Inner water-tight metal cans containing not over 0.5 kg (1 pound) of phosphorus with screw-top closures; or

(2) Steel, aluminum or other metal drums (1A1, 1B1 or 1N1) not over 250 L (66 gallons) capacity each or steel, aluminum or other metal drums (1A2, 1B2, or 1N2) not over 115 L (30 gallons) capacity each.

(b) When dry, it must be cast solid and shipped in packagings as follows:

(1) Steel, aluminum or other metal drums (1A2, 1B2 or 1N2) not over 115 L (30 gallons) capacity each, or

(2) In projectiles or bombs when shipped by, for, or to the Departments of the Army, Navy, or Air Force of the United States Government, without bursting elements.

[Amdt. 173–224, 55 FR 52643, Dec. 21, 1990, as amended at 56 FR 66271, Dec. 20, 1991; 78 FR 1088, Jan. 7, 2013]

§ 173.189 Batteries containing sodium or cells containing sodium.

(a) Batteries and cells may not contain any hazardous material other than sodium, sulfur or sodium compounds (*e.g.*, sodium polysulfides, sodium

tetrachloroaluminate, *etc.*). Cells not forming a component of a completed battery may not be offered for transportation at a temperature at which any liquid sodium is present in the cell. Batteries may only be offered for transportation, or transported, at a temperature at which any liquid sodium present in the battery conforms to the conditions prescribed in paragraph (d) of this section.

(b) Cells must be protected against short circuit and must consist of hermetically sealed metal casings that fully enclose the hazardous materials and that are so constructed and closed as to prevent the release of the hazardous materials under normal conditions of transport. Cells must be placed in suitable outer packagings with sufficient cushioning material to prevent contact between cells and between cells and the internal surfaces of the outer packaging, and to ensure that no dangerous shifting of the cells within the outer packaging occurs in transport. Cells must be packaged in 1A2, 1B2, 1N2, 1D, 1G, 1H2, 4A, 4B, 4N, 4C1, 4C2, 4D, 4F, 4G, 4H1, 4H2, 3A2, 3B2 or 3H2) outer packagings that meet the requirements of part 178 of this subchapter at the Packing Group II performance level.

(c) Batteries must consist of cells secured within, and fully enclosed by a metal casing so constructed and closed as to prevent the release of the hazardous materials under normal conditions of transport. Batteries may be offered for transportation, and transported, unpacked or in protective packagings that are not subject to the requirements of part 178 of this subchapter.

(d) Batteries containing any liquid sodium may not be offered for transportation, or transported, by aircraft. Batteries containing liquid sodium may be transported by motor vehicle, rail car or vessel under the following conditions:

(1) Batteries must be equipped with an effective means of preventing external short circuits, such as by providing complete electrical insulation of battery terminals or other external electrical connectors. Battery terminals or other electrical connectors penetrating the heat insulation fitted in battery

casings must be provided with thermal insulation sufficient to prevent the temperature of the exposed surfaces of such devices from exceeding 55 °C (130 °F).

(2) No battery may be offered for transportation if the temperature at any point on the external surface of the battery exceeds 55 °C (130 °F).

(3) If any external source of heating is used during transportation to maintain sodium in batteries in a molten state, means must be provided to ensure that the internal temperature of the battery does not reach or exceed 400 °C (752 °F).

(4) When loaded in a transport vehicle or freight container:

(i) Batteries must be secured so as to prevent significant shifting within the transport vehicle or freight container under conditions normally incident to transportation;

(ii) Adequate ventilation and/or separation between batteries must be provided to ensure that the temperature at any point on the external surface of the battery casing will not exceed 240 °C (464 °F) during transportation; and

(iii) No other hazardous materials, with the exception of cells containing sodium, may be loaded in the same transport vehicle or freight container. Batteries must be separated from all other freight by a distance of not less than 0.5 m (1.6 feet).

(e) Vehicles, machinery and equipment powered by sodium batteries must be consigned under the entry "Battery-powered vehicle or Battery-powered equipment."

[Amdt. 173-241, 59 FR 67511, Dec. 29, 1994, as amended by Amdt. 173-256, 61 FR 51338, Oct. 1, 1996; 66 FR 45380, Aug. 28, 2001; 68 FR 61941, Oct. 30, 2003; 74 FR 2259, Jan. 14, 2009; 76 FR 43530, July 20, 2011; 78 FR 1088, Jan. 7, 2013]

§ 173.192 Packaging for certain toxic gases in Hazard Zone A.

When §172.101 of this subchapter specifies a toxic material must be packaged under this section, only the following cylinders are authorized:

(a) Specification 3A1800, 3AA1800, 3AL1800, 3E1800, or seamless UN cylinders with a minimum test pressure in accordance with P200 of the UN Recommendations (IBR, see §171.7 of this subchapter).

(1) Specification 3A, 3AA, or 3AL cylinders may not exceed 57 kg (125 lb) water capacity (nominal).

(2) Specification 3AL cylinders may only be offered for transportation or transported by highway and rail.

(b) Packagings must conform to the requirements of §173.40.

(c) For cylinders used for phosgene:

(1) The filling density may not exceed 125 percent;

(2) A cylinder may not contain more than 68 kg (150 lb) of phosgene; and

(3) Each cylinder containing phosgene must be tested for leakage before it is offered for transportation or transported and must show no leakage. The leakage test must consist of immersing the cylinder and valve, without the protective cap attached, in a bath of water at a temperature of approximately 66 °C (150 °F) for at least 30 minutes, during which time frequent examinations must be made to note any escape of gas. The valve of the cylinder may not be loosened after this test. Suitable safeguards must be provided to protect personnel and facilities should failure occur during the test. As an alternative, each cylinder containing phosgene may be tested for leakage by a method approved in writing by the Associate Administrator.

[67 FR 51643, Aug. 8, 2002, as amended at 71 FR 33880, June 12, 2006]

§ 173.193 Bromoacetone, methyl bromide, chloropicrin and methyl bromide or methyl chloride mixtures, etc.

(a) Bromoacetone must be packaged as follows in metal boxes (4A, 4B or 4N) or wooden boxes (4C1, 4C2, 4D or 4F) with inner glass receptacles or tubes in hermetically sealed metal receptacles in corrugated fiberboard cartons. Bottles may not contain over 500 g (17.6 ounces) of liquid each and must be cushioned in cans with at least 12.7 mm (0.5 inch) of absorbent material. Total amount of liquid in the outer box must not exceed 11 kg (24 pounds). Packagings must conform to the requirements of part 178 of this subchapter at the Packing Group I performance level.

(b) Bromoacetone, methyl bromide, chloropicrin and methyl bromide mixtures, chloropicrin and methyl chloride mixtures, and chloropicrin mixtures

charged with non-flammable, non-liquefied compressed gas must be packed in Specification 3A, 3AA, 3B, 3C, 3E, 4A, 4B, 4BA, 4BW, or 4C cylinders having not over 113 kg (250 pounds) water capacity (nominal). This capacity does not apply to shipments of methyl bromide.

(c) Methyl bromide mixtures containing up to 2% chloropicrin must be packaged in 4G fiberboard boxes with inside metal cans containing not over one pound each, or inside metal cans with a minimum wall thickness of 0.007 inch containing not over 1¾ pounds each. The one-pound can must be capable of withstanding an internal pressure of 130 psig without leakage or permanent distortion. Vapor pressure of the contents must not exceed 130 psig at 55 °C (130 °F). The 1¾-pound can must be capable of withstanding an internal pressure of 140 psig without leakage or permanent distortion. Vapor pressure of the contents must not exceed 140 psig at 55 °C (130 °F). Cans must not be liquid full at 130 °F. Cans must be constructed of tinplate or lined with suitable material and must have concave or pressure ends.

(d) Cylinders, except those containing methyl bromide, must conform to § 173.40 of this part.

[Amdt. 173–224, 55 FR 52643, Dec. 21, 1990, as amended at 56 FR 66271, Dec. 20, 1991; 57 FR 45463, Oct. 1, 1992; 78 FR 1088, Jan. 7, 2013]

§ 173.194 Gas identification sets.

Gas identification sets containing poisonous material must be packaged in packagings conforming to the requirements of part 178 of this subchapter at the Packing Group I performance level, as follows:

(a) In glass inner receptacles, hermetically sealed, of not over 40 mL (1.4 fluid ounces) each. Each glass inner receptacle must in turn be placed in a sealed fiberboard receptacle, cushioned with absorbent material. Not more than 12 fiberboard receptacles must in turn be placed in a 4G fiberboard box. No more than four boxes, well-cushioned, may in turn be placed in a steel cylinder. The cylinder must have a wall thickness of at least 3.7 mm (0.146 inch) and must have a hermetically sealed steel closure.

(b) When the poisonous material is absorbed in a medium such as activated charcoal or silical gel, gas identification sets may be shipped as follows:

(1) If the poisonous material does not exceed 5 mL (0.2 fluid ounce) if a liquid or 5 g (0.2 ounce) if a solid, it may be packed in glass inner receptacles of not over 120 mL (4.1 fluid ounces) each. Each glass receptacle, cushioned with absorbent material must be packed in a hermetically sealed metal can of not less than 0.30 mm (0.012 inch) wall thickness. Metal cans, surrounded on all sides by at least 25 mm (1 inch) of dry sawdust, must be packed in 4A, 4B or 4N metal boxes or 4C1, 4C2, 4D or 4F wooden boxes. Not more than 100 mL (3.4 fluid ounces) or 100 g (3.5 ounces) of poisonous materials may be packed in one outer box.

(2) If the poisonous material does not exceed 5 mL (0.2 fluid ounce) if a liquid or 20 g (0.7 ounce) if a solid, it may be packed in glass inner receptacles with screw-top closures of not less than 60 mL (2 fluid ounces), hermetically sealed. Twelve bottles containing poisonous material, not to exceed 100 mL (3.4 fluid ounces) or 100 g (3.5 ounces), or both, may be placed in a plastic carrying case, each glass receptacle surrounded by absorbent cushioning and each separated from the other by sponge rubber partitions. The plastic carrying case must be placed in a tightly fitting fiberboard box which in turn must be placed in a tightly fitting 4A, 4B or 4N metal box or 4C1, 4C2, 4D or 4F wooden box.

[Amdt. 173–224, 55 FR 52643, Dec. 21, 1990, as amended at 66 FR 45183, 45381, Aug. 28, 2001; 78 FR 1088, Jan. 7, 2013]

§ 173.195 Hydrogen cyanide, anhydrous, stabilized (hydrocyanic acid, aqueous solution).

(a) Hydrogen cyanide, anhydrous, stabilized, must be packed in specification cylinders or UN pressure receptacles as follows:

(1) As prescribed in § 173.192;

(2) Specification 3A480, 3A480X, 3AA480, or 3A1800 metal cylinders of not over 126 kg (278 pounds) water capacity (nominal);

(3) Shipments in 3AL cylinders are authorized only when transported by highway and rail; or

(4) UN cylinders, as specified in part 178, with a minimum test pressure of 100 bar and a maximum filling ratio of 0.55. The use of UN tubes and MEGCs is not authorized.

(b) Cylinders may not be charged with more than 0.27 kg (0.6 pound) of liquid per 0.45 kg (1 pound) water capacity of cylinder. Each filled cylinder must be tested for leakage before being offered for transportation or transported and must show absolutely no leakage; this test must consist of passing a piece of Guignard's sodium picrate paper over the closure of the cylinder, without the protection cap attached, to detect any escape of hydrogen cyanide from the cylinder. Other equally efficient test methods may be used in place of sodium picrate paper.

(c) Packagings for hydrogen cyanide must conform to §173.40.

[Amdt. 173-224, 55 FR 52643, Dec. 21, 1990, as amended at 56 FR 66271, Dec. 20, 1991; 71 FR 33880, June 12, 2006]

§ 173.196 Category A infectious substances.

(a) *Category A infectious substances packaging.* A packaging for a Division 6.2 material that is a Category A infectious substance must meet the test standards of §178.609 of this subchapter and must be marked in conformance with §178.503(f) of this subchapter. A packaging for a Category A infectious substance is a triple packaging consisting of the following components:

(1) A leakproof primary receptacle.

(2) A leakproof secondary packaging. If multiple fragile primary receptacles are placed in a single secondary packaging, they must be either wrapped individually or separated to prevent contact between them.

(3) A rigid outer packaging of adequate strength for its capacity, mass and intended use; including, drums (1A1, 1A2, 1B1, 1B2, 1N1, 1N2, 1H1, 1H2, 1D, 1G); boxes (4A, 4B, 4N, 4C1, 4C2, 4D, 4F, 4G, 4H1, 4H2); or jerricans (3A1, 3A2, 3B1, 3B2, 3H1, 3H2). The outer packaging must measure not less than 100 mm (3.9 inches) at its smallest overall external dimension.

(4) For a liquid infectious substance, an absorbent material placed between the primary receptacle and the secondary packaging. The absorbent ma-

terial must be sufficient to absorb the entire contents of all primary receptacles.

(5) An itemized list of contents enclosed between the secondary packaging and the outer packaging.

(6) The primary receptacle or secondary packaging used for infectious substances must be capable of withstanding, without leakage, an internal pressure producing a pressure differential of not less than 95 kPa (0.95 bar, 14 psi).

(7) The primary receptacle or secondary packaging used for infectious substances must be capable of withstanding without leakage temperatures in the range of -40°C to $+55^{\circ}\text{C}$ (-40°F to $+131^{\circ}\text{F}$).

(b) *Additional requirements for packaging Category A infectious substances.* Category A infectious substances must be packaged according to the following requirements, depending on the physical state and other characteristics of the material.

(1) *Infectious substances shipped at ambient temperatures or higher.* Primary receptacles must be made of glass, metal, or plastic. Positive means of ensuring a leakproof seal must be provided, such as heat seal, skirted stopper, or metal crimp seal. If screw caps are used, they must be secured by positive means, such as with adhesive tape, paraffin sealing tape, or manufactured locking closure. Lyophilized substances may also be transported in primary receptacles that are flame-sealed with glass ampoules or rubber-stoppered glass vials fitted with metal seals.

(2) *Infectious substances shipped refrigerated or frozen (ice, pre-frozen packs, dry ice).* Ice, dry ice, or other refrigerant must be placed around the secondary packagings or in an overpack with one or more complete packages marked in accordance with §178.503 of this subchapter. Interior supports must be provided to secure the secondary packagings in the original position after the ice or dry ice has dissipated. If ice is used, the outer packaging or overpack must be leakproof. If dry ice is used, the outer packaging or overpack must permit the release of carbon dioxide gas and otherwise meet the provisions in §173.217. The primary receptacle and the secondary packaging

must maintain their integrity at the temperature of the refrigerant used, as well as the temperatures and pressures of transport by aircraft to which they could be subjected if refrigeration were lost.

(3) *Infectious substances shipped in liquid nitrogen.* The primary receptacle and the secondary packaging must maintain their integrity at the temperature of the liquid nitrogen as well as the temperatures and pressures of transport by aircraft to which they could be subjected if refrigeration were lost. Refrigerated liquid nitrogen packagings must be metal vacuum insulated vessels or flasks vented to the atmosphere to prevent any increase in pressure within the packaging. The use of safety relief valves, check valves, frangible discs, or similar devices in the vent lines is prohibited. Fill and discharge openings must be protected against the entry of foreign materials that might cause an increase in the internal pressure. The package orientation markings specified in § 172.312(a) of this subchapter must be marked on the packaging. The packaging must be designed to prevent the release of any refrigerated liquid nitrogen irrespective of the packaging orientation.

(c) Live animals may not be used to transport infectious substances unless such substances cannot be sent by any other means. An animal containing or contaminated with an infectious substance must be transported under terms and conditions approved by the Associate Administrator for Hazardous Materials Safety.

(d) Body parts, organs or whole bodies meeting the definition of Division 6.2 material must be packaged as follows:

(1) In Division 6.2 packaging, as specified in paragraphs (a) and (b) of this section; or

(2) In packaging meeting the requirements of § 173.197.

[67 FR 53140, Aug. 14, 2002, as amended at 71 FR 32260, June 2, 2006; 74 FR 2259, Jan. 14, 2009; 78 FR 1088, Jan. 7, 2013]

§ 173.197 Regulated medical waste.

(a) *General provisions.* Non-bulk packagings, Large Packagings, and non-specification bulk outer packagings used for the transportation of regu-

lated medical waste or clinical waste or (bio) medical waste must be rigid containers meeting the provisions of subpart B of this part.

(b) *Non-bulk packagings.* Except as provided in § 173.134(c) of this subpart, non-bulk packagings for regulated medical waste or clinical waste or (bio) medical waste must be UN standard packagings conforming to the requirements of part 178 of this subchapter at the Packing Group II performance level. A non-bulk packaging used as a sharps container must be puncture-resistant for sharps and sharps with residual fluid as demonstrated by conducting the performance tests in part 178, subpart M, of this subchapter on packagings containing materials representative of the sharps and fluids (such as sterile sharps) intended to be transported in the packagings. Sharps containers must be securely closed to prevent leaks or punctures in conformance with the instructions provided by the packaging manufacturer in accordance with § 178.2(c) of this subchapter.

(c) *Large Packagings.* Large Packagings constructed, tested, and marked in accordance with the requirements specified in subparts P and Q of part 178 of this subchapter and conforming to other requirements of this paragraph (c) may be used for the transportation of regulated medical waste, provided the waste is contained in inner packagings conforming to the requirements of paragraph (e) of this section. * * * Each Large Packaging design must be capable of meeting the vibration test specified in § 178.819 of this subchapter. Each Large Packaging is subject to the periodic design requalification requirements for IBCs in § 178.801(e) of this subchapter, and to the proof of compliance requirements of § 178.801(j) and record retention requirements of § 178.801(l) of this subchapter. Inner packagings used for liquids must be rigid.

(1) *Authorized packagings.* Only the following Large Packagings are authorized for the transportation of liquid or solid regulated medical waste:

- (i) Metal: 50A, 50B, or 50N.
- (ii) Rigid plastic: 50H.

(2) *Additional requirements.* Each Large Packaging used to transport liquid regulated medical waste must contain absorbent material in sufficient quantity and appropriate location to absorb the entire amount of liquid present in the event of an unintentional release of contents. Each Large Packaging design intended for the transportation of sharps containers must be puncture resistant and capable of retaining liquids. The design must also be tested and certified as meeting the performance tests specified for intermediate bulk containers intended for the transportation of liquids in subpart O of part 178 of this subchapter.

(d) *Non-specification bulk packaging.* A wheeled cart (Cart) or bulk outer packaging (BOP) is authorized as an outer packaging for the transportation of regulated medical waste in accordance with the provisions of this paragraph (d).

(1) *General requirements.* The following requirements apply to the transportation of regulated medical waste in Carts or BOPs:

(i) Regulated medical waste in each Cart or BOP must be contained in non-bulk inner packagings conforming to paragraph (e) of this section.

(ii) Each Cart or BOP must have smooth, non-porous interior surfaces free of cracks, crevices, and other defects that could damage plastic film inner packagings or impede disinfection operations.

(iii) Except as otherwise provided in this paragraph (d), each Cart or BOP must be used exclusively for the transportation of regulated medical waste. Prior to reuse, each Cart or BOP must be disinfected by any means effective for neutralizing the infectious substance the packaging previously contained.

(iv) Untreated concentrated stock cultures of infectious substances containing Category A materials may not be transported in a Cart or BOP.

(v) Division 6.1 toxic waste or Class 7 radioactive waste, with the exception of chemotherapeutic waste, may not be transported in a Cart or BOP.

(vi) Division 6.1 or Class 7 chemotherapeutic waste; untreated concentrated stock cultures of infectious substances containing Category B

infectious substances; unabsorbed liquids; and sharps containers may be transported in a Cart or BOP only if packaged in rigid non-bulk packagings conforming to paragraph (a) of this section.

(2) *Wheeled cart (Cart).* A Cart is authorized as an outer packaging for the transportation of regulated medical waste if it conforms to the following requirements:

(i) Each Cart must consist of a solid, one-piece body with a nominal volume not exceeding 1,655 L (437 gallons).

(ii) Each Cart must be constructed of metal, rigid plastic, or fiberglass fitted with a lid to prevent leakage during transport.

(iii) Each Cart must be capable of meeting the requirements of §178.810 (drop test) at the Packing Group II performance level.

(iv) Inner packagings must be placed into a Cart and restrained in such a manner as to minimize the risk of breakage.

(3) *Bulk outer packaging (BOP).* A BOP is authorized as an outer packaging for regulated medical waste if it conforms to the following requirements:

(i) Each BOP must be constructed of metal or fiberglass and have a capacity of at least 3.5 cubic meters (123.6 cubic feet) and not more than 45 cubic meters (1,590 cubic feet).

(ii) Each BOP must have bottom and side joints of fully welded or seamless construction and a rigid, weatherproof top to prevent the intrusion of water (e.g., rain or snow).

(iii) Each opening in a BOP must be fitted with a closure to prevent the intrusion of water or the release of any liquid during all loading, unloading, and transportation operations.

(iv) In the upright position, each BOP must be leakproof and able to contain a liquid quantity of at least 300 liters (79.2 gallons) with closures open.

(v) Inner packagings must be placed in a BOP in such a manner as to minimize the risk of breakage. Rigid inner packagings may not be placed in the same BOP with plastic film bag inner packagings unless separated from each other by rigid barriers or dividers to prevent damage to the packagings caused by load shifting during normal conditions of transportation.

(vi) Division 6.1 or Class 7 chemotherapeutic waste, untreated concentrated stock cultures of infectious substances containing Category B infectious substances, unabsorbed liquids, and sharps may be transported in a BOP only if separated and secured as required in paragraph (d)(3)(v) of this section.

(e) *Inner packagings authorized for Large Packagings, Carts, and BOPs.* After September 30, 2003, inner packagings must be durably marked or tagged with the name and location (city and state) of the offeror, except when the entire contents of the Large Packaging, Cart, or BOP originates at a single location and is delivered to a single location.

(1) *Solids.* A plastic film bag is authorized as an inner packaging for solid regulated medical waste transported in a Cart, Large Packaging, or BOP. Waste material containing absorbed liquid may be packaged as a solid in a plastic film bag if the bag contains sufficient absorbent material to absorb and retain all liquid during transportation.

(i) The film bag may not exceed a volume of 175 L (46 gallons). The film bag must be marked and certified by its manufacturer as having passed the tests prescribed for tear resistance in ASTM D 1922, “Standard Test Method for Propagation Tear Resistance of Plastic Film and Thin Sheeting by Pendulum Method” (IBR, § 171.7 of this subchapter) and for impact resistance in ASTM D 1709, “Standard Test Methods for Impact Resistance of Plastic Film by the Free-Falling Dart Method” (IBR, § 171.7 of this subchapter). The film bag must meet an impact resistance of 165 grams and a tearing resistance of 480 grams in both the parallel and perpendicular planes with respect to the length of the bag.

(ii) The plastic film bag must be closed with a minimum of entrapped air to prevent leakage in transportation. The bag must be capable of being held in an inverted position with the closed end at the bottom for a period of 5 minutes without leakage.

(iii) When used as an inner packaging for Carts or BOPs, a plastic film bag may not weigh more than 10 kg (22 lbs.) when filled.

(2) *Liquids.* Liquid regulated medical waste or clinical waste or (bio) medical waste transported in a Large Packaging, Cart, or BOP must be packaged in a rigid inner packaging conforming to the provisions of subpart B of this part, conforming to the provisions of subpart B of this part. Liquid materials are not authorized for transportation in inner packagings having a capacity greater than 19 L (5 gallons).

(3) *Sharps.* Sharps transported in a Large Packaging, Cart, or BOP must be packaged in a puncture-resistant inner packaging (sharps container). Each sharps container must be securely closed to prevent leaks or punctures in conformance with instructions provided by the packaging manufacturer. Each sharps container exceeding 76 L (20 gallons) in volume must be capable of passing the performance tests in part 178, subpart M, of this subchapter at the Packing Group II performance level. A sharps container may be reused only if it conforms to the following criteria:

(i) The sharps container is specifically approved and certified by the U.S. Food and Drug Administration as a medical device for reuse.

(ii) The sharps container must be permanently marked for reuse.

(iii) The sharps container must be disinfected prior to reuse by any means effective for the infectious substance the container previously contained.

(iv) The sharps container must have a capacity greater than 7.57 L (2 gallons) and not greater than 151.42 L (40 gallons) in volume.

[67 FR 53140, Aug. 14, 2002, as amended at 68 FR 57632, Oct. 6, 2003; 68 FR 75744, Dec. 31, 2003; 71 FR 32261, June 2, 2006; 71 FR 78632, Dec. 29, 2006; 75 FR 60339, Sept. 30, 2010]

§ 173.198 Nickel carbonyl.

(a) Nickel carbonyl must be packed in specification steel or nickel cylinders as prescribed for any compressed gas except acetylene. A cylinder used exclusively for nickel carbonyl may be given a complete external visual inspection instead of the pressure test required by § 180.205 of this subchapter. Visual inspection must be in accordance with CGA Pamphlet C-6 (IBR, see § 171.7 of this subchapter).

(b) Packagings for nickel carbonyl must conform to §173.40.

[Amdt. 173-224, 55 FR 52643, Dec. 21, 1990, as amended at 67 FR 51643, Aug. 8, 2002; 68 FR 75742, Dec. 31, 2003]

§ 173.199 Category B infectious substances.

(a) *Category B infectious substances.* Except as provided in this paragraph (a), Category B infectious substances are excepted from all other requirements of this subchapter when offered for transportation or transported in accordance with this section. Category B infectious substances offered for transportation or transported under the provisions of this section are subject to the incident reporting requirements in §§171.15 and 171.16 of this subchapter and to the requirements in §175.75(b) of this subchapter concerning cargo location. Except as provided in paragraph (a)(9) of this section, a Category B infectious substance meeting the definition of a hazard class other than Division 6.2 must be offered for transportation or transported in accordance with applicable requirements of this subchapter.

(1) A Category B infectious substance must be packaged in a triple packaging consisting of a primary receptacle, a secondary packaging, and a rigid outer packaging.

(2) Primary receptacles must be packed in secondary packaging in such a way that, under normal conditions of transport, they cannot break, be punctured, or leak their contents into the secondary packaging.

(3) Secondary packagings must be secured in rigid outer packagings with suitable cushioning material such that any leakage of the contents will not impair the protective properties of the cushioning material or the outer packaging.

(4) The completed package must be designed, constructed, maintained, filled, its contents limited, and closed so that under conditions normally encountered in transportation, including removal from a pallet or overpack for subsequent handling, there will be no release of hazardous material into the environment. Package effectiveness must not be substantially reduced for minimum and maximum temperatures,

changes in humidity and pressure, and shocks, loadings and vibrations normally encountered during transportation. The packaging must be capable of successfully passing the drop tests in §178.609(d) and (h) of this subchapter at a drop height of at least 1.2 meters (3.9 feet). Following the drop tests, there must be no leakage from the primary receptacle, which must remain protected by absorbent material, when required, in the secondary packaging. At least one surface of the outer packaging must have a minimum dimension of 100 mm by 100 mm (3.9 inches).

(5) The following mark must be displayed on the outer packaging on a background of contrasting color. The width of the line must be at least 2 mm (0.08 inches) and the letters and numbers must be at least 6 mm (0.24 inches) high. The size of the mark must be such that no side of the diamond is less than 50 mm (1.97 inches) in length. The proper shipping name "Biological substances, Category B" must be marked on the outer packaging adjacent to the diamond-shaped mark in letters that are at least 6 mm (0.24 inches) high.

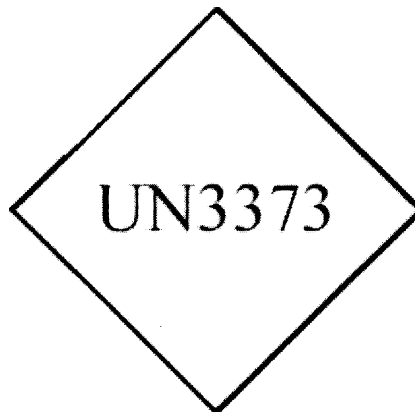

(6) When packages are placed in an overpack, the package markings required by this section must be either clearly visible or reproduced on the outside of the overpack.

(7) The name and telephone number of a person who is either knowledgeable about the material being shipped and has comprehensive emergency response and incident mitigation information for the material, or has immediate access to a person who possesses

such knowledge and information, must be included on a written document (such as an air waybill or bill of lading) or on the outer packaging.

(8) For transportation by aircraft, each package, overpack, pallet, or unit load device containing a Category B infectious substance must be inspected for leakage when it is unloaded from the aircraft. If evidence of leakage is found, the cargo compartment in which the package, overpack, pallet, or unit load device was transported must be disinfected. Disinfection may be by any means that will make the material released ineffective at transmitting disease.

(9) A packaging containing inner packagings of Category B infectious substances may not contain other hazardous materials except—

(i) Refrigerants, such as dry ice or liquid nitrogen, as authorized under paragraph (d) of this section;

(ii) Anticoagulants used to stabilize blood or plasma; or

(iii) Small quantities of Class 3, Class 8, Class 9, or other materials in Packing Groups II and III used to stabilize or prevent degradation of the sample, provided the quantity of such materials does not exceed 30 mL (1 ounce) or 30 g (1 ounce) in each inner packaging. Such preservatives are not subject to the requirements of this subchapter.

(10) Clear instructions on filling and closing a packaging used to transport a Category B infectious substance must be provided by the packaging manufacturer and subsequent distributors to the consignor or person who prepares the package to enable the package to be correctly prepared for transport. A copy or electronic image of these instructions must be retained by the manufacturer and subsequent distributors for at least one year from the date of issuance, and made available for inspection by a Federal or state government representative upon request. Packagings must be filled and closed in accordance with the information provided by the packaging manufacturer or subsequent distributor.

(b) *Liquid Category B infectious substances.* Liquid Category B infectious substances must be packaged in conformance with the following provisions:

(1) The primary receptacle must be leakproof.

(2) Absorbent material must be placed between the primary receptacle and secondary packaging. If several fragile primary receptacles are placed in a single secondary packaging, they must be either individually wrapped or separated to prevent contact between them. The absorbent material must be of sufficient quantity to absorb the entire contents of the primary receptacles and not compromise the integrity of the cushioning material or the outer packaging.

(3) The secondary packaging must be leakproof.

(4) For shipments by aircraft, the primary receptacle or the secondary packaging must be capable of withstanding without leakage an internal pressure producing a pressure differential of not less than 95 kPa (0.95 bar, 14 psi).

(5) For shipments by aircraft, the maximum quantity contained in each primary receptacle, including any material used to stabilize or prevent degradation of the sample, may not exceed 1 L (34 ounces), and the maximum quantity contained in each outer packaging, including any material used to stabilize or prevent degradation of the samples, may not exceed 4 L (1 gallon). The outer packaging limitation does not include ice, dry ice, or liquid nitrogen when used to maintain the integrity of the material.

(c) *Solid Category B infectious substances.* Solid Category B infectious substances must be packaged in a triple packaging, consisting of a primary receptacle, secondary packaging, and outer packaging, conforming to the following provisions:

(1) The primary receptacle must be siftproof.

(2) If several fragile primary receptacles are placed in a single secondary packaging, they must be either individually wrapped or separated to prevent contact between them.

(3) The secondary packaging must be siftproof.

(4) If residual liquid may be present in the primary receptacle during transportation, then the material must be transported in accordance with requirements in paragraph (b) of this section. A solid material that may become

liquid during transportation must be transported in accordance with paragraph (b) of this section.

(5) Except for packages containing body parts, organs, or whole bodies, for shipment by aircraft, the outer packaging may not contain more than 4 kg (8.8 pounds), including any material used to stabilize or prevent degradation of the samples. The outer packaging limitation does not include ice, dry ice, or liquid nitrogen when used to maintain the integrity of the material.

(d) *Refrigerated or frozen specimens (ice, dry ice, and liquid nitrogen)*. In addition to complying with the requirements in this paragraph (d), dry ice and liquid nitrogen must be offered for transportation or transported in accordance with the applicable requirements of this subchapter.

(1) Ice or dry ice must be placed outside the secondary packaging or in an overpack. Interior supports must be provided to secure the secondary packagings in the original position. If ice is used, the outside packaging must be leakproof or must have a leakproof liner. If dry ice is used, the outside packaging must permit the release of carbon dioxide gas and otherwise meet the provisions in §173.217. The primary receptacle and secondary packaging must maintain their integrity at the temperature of the refrigerant used, as well as the temperatures and pressures of transport by aircraft they could be subjected to if refrigeration were lost, and sufficient absorbent material must be provided to absorb all liquid, including melted ice.

(2) The package is marked "Carbon dioxide, solid" or "Dry ice" and an indication that the material being refrigerated is used for diagnostic or treatment purposes (e.g., frozen medical specimens).

(e) *Training*. Each person who offers or transports a Category B infectious substance under the provisions of this section must know about the requirements of this section.

[67 FR 53142, Aug. 14, 2002, as amended at 71 FR 32261, June 2, 2006; 72 FR 55693, Oct. 1, 2007; 78 FR 1088, Jan. 7, 2013]

§ 173.201 Non-bulk packagings for liquid hazardous materials in Packing Group I.

(a) When §172.101 of this subchapter specifies that a liquid hazardous material be packaged under this section, only non-bulk packagings prescribed in this section may be used for its transportation. Each packaging must conform to the general packaging requirements of subpart B of part 173, to the requirements of part 178 of this subchapter at the Packing Group I performance level, and to the requirements of the special provisions of column 7 of the §172.101 table.

(b) The following combination packagings are authorized:

Outer packagings:

Steel drum: 1A1 or 1A2
 Aluminum drum: 1B1 or 1B2
 Metal drum other than steel or aluminum:
 1N1 or 1N2
 Plywood drum: 1D
 Fiber drum: 1G
 Plastic drum: 1H1 or 1H2
 Steel jerrican: 3A1 or 3A2
 Plastic jerrican: 3H1 or 3H2
 Aluminum jerrican: 3B1 or 3B2
 Steel box: 4A
 Aluminum box: 4B
 Natural wood box: 4C1 or 4C2
 Plywood box: 4D
 Reconstituted wood box: 4F
 Fiberboard box: 4G
 Expanded plastic box: 4H1
 Solid plastic box: 4H2
 Metal box other than steel or aluminum: 4N

Inner packagings:

Glass or earthenware receptacles
 Plastic receptacles
 Metal receptacles
 Glass ampoules

(c) Except for transportation by passenger aircraft, the following single packagings are authorized:

Steel drum: 1A1 or 1A2
 Aluminum drum: 1B1 or 1B2
 Metal drum other than steel, or aluminum:
 1N1 or 1N2
 Plastic drum: 1H1 or 1H2
 Steel jerrican: 3A1 or 3A2
 Plastic jerrican: 3H1 or 3H2
 Aluminum jerrican: 3B1 or 3B2
 Plastic receptacle in steel, aluminum, fiber or plastic drum: 6HA1, 6HB1, 6HG1, 6HH1
 Plastic receptacle in steel, aluminum, wood-en, plywood or fiberboard box: 6HA2, 6HB2, 6HC, 6HD2 or 6HG2
 Glass, porcelain or stoneware in steel, aluminum or fiber drum: 6PA1, 6PB1 or 6PG1

§ 173.202

Glass, porcelain or stoneware in steel, aluminum, wooden or fiberboard box: 6PA2, 6PB2, 6PC or 6PG2

Glass, porcelain or stoneware in solid or expanded plastic packaging: 6PH1 or 6PH2

Cylinders, specification or UN standard, as prescribed for any compressed gas, except 3HT and those prescribed for acetylene.

[Amdt. 173-224, 55 FR 52634, Dec. 21, 1990, as amended by Amdt. 173-241, 59 FR 67518, Dec. 29, 1994; Amdt. 173-261, 62 FR 24734, May 6, 1997; 71 FR 33880, June 12, 2006; 78 FR 1089, Jan. 7, 2013]

§ 173.202 Non-bulk packagings for liquid hazardous materials in Packing Group II.

(a) When §172.101 of this subchapter specifies that a liquid hazardous material be packaged under this section, only non-bulk packagings prescribed in this section may be used for its transportation. Each packaging must conform to the general packaging requirements of subpart B of part 173, to the requirements of part 178 of this subchapter at the Packing Group I or II performance level (unless otherwise excepted), and to the particular requirements of the special provisions of column 7 of the §172.101 table.

(b) The following combination packagings are authorized:

Outer packagings:

Steel drum: 1A1 or 1A2
Aluminum drum: 1B1 or 1B2
Metal drum other than steel or aluminum: 1N1 or 1N2
Plywood drum: 1D
Fiber drum: 1G
Plastic drum: 1H1 or 1H2
Wooden barrel: 2C2
Steel jerrican: 3A1 or 3A2
Plastic jerrican: 3H1 or 3H2
Aluminum jerrican: 3B1 or 3B2
Steel box: 4A
Aluminum box: 4B
Natural wood box: 4C1 or 4C2
Plywood box: 4D
Reconstituted wood box: 4F
Fiberboard box: 4G
Expanded plastic box: 4H1
Solid plastic box: 4H2
Metal box other than steel or aluminum: 4N

Inner packagings:

Glass or earthenware receptacles
Plastic receptacles
Metal receptacles
Glass ampoules

(c) Except for transportation by passenger aircraft, the following single packagings are authorized:

49 CFR Ch. I (10-1-14 Edition)

Steel drum: 1A1 or 1A2

Aluminum drum: 1B1 or 1B2

Metal drum other than steel or aluminum: 1N1 or 1N2

Plastic drum: 1H1 or 1H2

Fiber drum: 1G (with liner)

Wooden barrel: 2C1

Steel jerrican: 3A1 or 3A2

Plastic jerrican: 3H1 or 3H2

Aluminum jerrican: 3B1 or 3B2

Plastic receptacle in steel, aluminum, fiber or plastic drum: 6HA1, 6HB1, 6HG1 or 6HH1

Plastic receptacle in steel, aluminum, wooden, plywood or fiberboard box: 6HA2, 6HB2, 6HC, 6HD2 or 6HG2

Glass, porcelain or stoneware in steel, aluminum or fiber drum: 6PA1, 6PB1 or 6PG1

Glass, porcelain or stoneware in steel, aluminum, wooden or fiberboard box: 6PA2, 6PB2, 6PC or 6PG2

Glass, porcelain or stoneware in solid or expanded plastic packaging: 6PH1 or 6PH2

Plastic receptacle in plywood drum: 6HD1

Glass, porcelain or stoneware in plywood drum or wickerwork hamper: 6PD1 or 6PD2

Cylinders, specification, as prescribed for any compressed gas, except for Specifications 8 and 3HT

[Amdt. 173-224, 55 FR 52643, Dec. 21, 1990, as amended at 56 FR 66271, Dec. 20, 1991; Amdt. 173-241, 59 FR 67518, Dec. 29, 1994; Amdt. 173-261, 62 FR 24734, May 6, 1997; 62 FR 51560, Oct. 1, 1997; 78 FR 1089, Jan. 7, 2013]

§ 173.203 Non-bulk packagings for liquid hazardous materials in Packing Group III.

(a) When §172.101 of this subchapter specifies that a liquid hazardous material be packaged under this section, only non-bulk packagings prescribed in this section may be used for its transportation. Each packaging must conform to the general packaging requirements of subpart B of part 173, to the requirements of part 178 of this subchapter at the Packing Group I, II or III performance level, and to the requirements of the special provisions of column 7 of the §172.101 table.

(b) The following combination packagings are authorized:

Outer packagings:

Steel drum: 1A1 or 1A2
Aluminum drum: 1B1 or 1B2
Metal drum other than steel or aluminum: 1N1 or 1N2
Plywood drum: 1D
Fiber drum: 1G
Plastic drum: 1H1 or 1H2
Wooden barrel: 2C2
Steel jerrican: 3A1 or 3A2
Plastic jerrican: 3H1 or 3H2

Aluminum jerrican: 3B1 or 3B2
 Steel box: 4A
 Aluminum box: 4B
 Natural wood box: 4C1 or 4C2
 Plywood box: 4D
 Reconstituted wood box: 4F
 Fiberboard box: 4G
 Expanded plastic box: 4H1
 Solid plastic box: 4H2
 Metal box other than steel or aluminum: 4N
Inner packagings:
 Glass or earthenware receptacles
 Plastic receptacles
 Metal receptacles
 Glass ampoules

(c) The following single packagings are authorized:

Steel drum: 1A1 or 1A2
 Aluminum drum: 1B1 or 1B2
 Metal drum other than steel or aluminum: 1N1
 Plastic drum: 1H1 or 1H2
 Fiber drum: 1G (with liner)
 Wooden barrel: 2C1
 Steel jerrican: 3A1 or 3A2
 Plastic jerrican: 3H1 or 3H2
 Aluminum jerrican: 3B1 or 3B2
 Plastic receptacle in steel, aluminum, fiber or plastic drum: 6HA1, 6HB1, 6HG1 or 6HH1
 Plastic receptacle in steel, aluminum, wooden, plywood or fiberboard box: 6HA2, 6HB2, 6HC, 6HD2 or 6HG2
 Glass, porcelain or stoneware in steel, aluminum or fiber drum: 6PA1, 6PB1, or 6PG1
 Glass, porcelain or stoneware in steel, aluminum, wooden or fiberboard box: 6PA2, 6PB2, 6PC or 6PG2
 Glass, porcelain or stoneware in solid or expanded plastic packaging: 6PH1 or 6PH2
 Plastic receptacle in plywood drum: 6HD1
 Glass, porcelain or stoneware in plywood drum or wickerwork hamper: 6PD1 or 6PD2
 Cylinders, as prescribed for any compressed gas, except for Specifications 8 and 3HT

[Amdt. 173-224, 55 FR 52643, Dec. 21, 1990, as amended at 56 FR 66271, Dec. 20, 1991; Amdt. 173-241, 59 FR 67518, Dec. 29, 1994; Amdt. 173-261, 62 FR 24734, May 6, 1997; 78 FR 1089, Jan. 7, 2013]

§ 173.204 Non-bulk, non-specification packagings for certain hazardous materials.

When §172.101 of this subchapter specifies that a liquid or solid hazardous material be packaged under this section, any appropriate non-bulk packaging which conforms to the general packaging requirements of subpart B of part 173 may be used for its transportation. Packagings need not conform to the requirements of part 178 of this subchapter.

§ 173.205 Specification cylinders for liquid hazardous materials.

When §172.101 of this subchapter specifies that a hazardous material must be packaged under this section, the use of any specification or UN cylinder, except those specified for acetylene, is authorized. Cylinders used for toxic materials in Division 6.1 or 2.3 must conform to the requirements of §173.40.

[71 FR 33881, June 12, 2006]

§ 173.206 Packaging requirements for chlorosilanes.

(a) When §172.101 of this subchapter specifies that a hazardous material be packaged under this section, only non-bulk packagings prescribed in this section may be used for its transportation. Each packaging must conform to the general packaging requirements of subpart B of part 173, to the requirements of part 178 of this subchapter at the Packing Group I or II performance level (unless otherwise excepted), and to the particular requirements of the special provisions of Column (7) of the §172.101 Table.

(b) The following combination packagings are authorized:

Outer packagings:

Steel drum: 1A2
 Plastic drum: 1H2
 Plywood drum: 1D
 Fiber drum: 1G
 Steel box: 4A
 Natural wood box: 4C1 or 4C2
 Plywood box: 4D
 Reconstituted wood box: 4F
 Fiberboard box: 4G
 Expanded plastic box: 4H1
 Solid plastic box: 4H2

Inner packagings:

Glass or Steel receptacle

(c) Except for transportation by passenger aircraft, the following single packagings are authorized:

Steel drum: 1A1
 Steel jerrican: 3A1
 Plastic receptacle in steel drum: 6HA1
 Cylinders (for liquids in PG I), specification or UN standard, as prescribed for any compressed gas, except Specification 3HT and those prescribed for acetylene

§ 173.211

Cylinders (for liquids in PG II), specification, as prescribed for any compressed gas, except Specification 8 and 3HT cylinders.

[74 FR 2259, Jan. 14, 2009, as amended at 75 FR 72, Jan. 4, 2010]

§ 173.211 Non-bulk packagings for solid hazardous materials in Packing Group I.

(a) When §172.101 of this subchapter specifies that a solid hazardous material be packaged under this section, only non-bulk packagings prescribed in this section may be used for its transportation. Each package must conform to the general packaging requirements of subpart B of part 173, to the requirements of part 178 of this subchapter at the Packing Group I performance level, and to the requirements of the special provisions of column 7 of the §172.101 table.

(b) The following combination packagings are authorized:

Outer packagings:

Steel drum: 1A1 or 1A2
Aluminum drum: 1B1 or 1B2
Metal drum other than steel or aluminum: 1N1 or 1N2
Plywood drum: 1D
Fiber drum: 1G
Plastic drum: 1H1 or 1H2
Wooden barrel: 2C2
Steel jerrican: 3A1 or 3A2
Plastic jerrican: 3H1 or 3H2
Aluminum jerrican: 3B1 or 3B2
Steel box: 4A
Aluminum box: 4B
Natural wood box: 4C1 or 4C2
Plywood box: 4D
Reconstituted wood box: 4F
Fiberboard box: 4G
Solid plastic box: 4H2
Metal box other than steel or aluminum: 4N

Inner packagings:

Glass or earthenware receptacles
Plastic receptacles
Metal receptacles
Glass ampoules

(c) Except for transportation by passenger aircraft, the following single packagings are authorized:

Steel drum: 1A1 or 1A2
Aluminum drum: 1B1 or 1B2
Metal drum other than steel or aluminum: 1N1 or 1N2
Plastic drum: 1H1 or 1H2
Fiber drum: 1G
Steel jerrican: 3A1 or 3A2
Plastic jerrican: 3H1 or 3H2

49 CFR Ch. I (10–1–14 Edition)

Aluminum jerrican: 3B1 or 3B2
Steel box with liner: 4A
Aluminum box with liner: 4B
Metal box other than steel or aluminum: 4N
Natural wood box, sift proof: 4C2
Plastic receptacle in steel, aluminum, plywood, fiber or plastic drum: 6HA1, 6HB1, 6HD1, 6HG1 or 6HH1
Glass, porcelain or stoneware in steel, aluminum, plywood or fiber drum: 6PA1, 6PB1, 6PD1 or 6PG1
Glass, porcelain or stoneware in steel, aluminum, wooden or fiberboard box: 6PA2, 6PB2, 6PC or 6PG2
Glass, porcelain or stoneware in expanded or solid plastic packaging: 6PH1 or 6PH2
Cylinders, as prescribed for any compressed gas, except for Specification 8 and 3HT

[Amdt. 173-224, 55 FR 52643, Dec. 21, 1990, as amended at 56 FR 66271, Dec. 20, 1991; 57 FR 45463, Oct. 1, 1992; Amdt. 173-241, 59 FR 67511, 67518, Dec. 29, 1994; Amdt. 173-261, 62 FR 24734, May 6, 1997; 69 FR 76157, Dec. 20, 2004; 78 FR 1089, Jan. 7, 2013]

§ 173.212 Non-bulk packagings for solid hazardous materials in Packing Group II.

(a) When §172.101 of this subchapter specifies that a solid hazardous material be packaged under this section, only non-bulk packagings prescribed in this section may be used for its transportation. Each package must conform to the general packaging requirements of subpart B of part 173, to the requirements of part 178 of this subchapter at the Packing Group I or II performance level, and to the requirements of the special provisions of column 7 of the §172.101 table.

(b) The following combination packagings are authorized:

Outer packagings:

Steel drum: 1A1 or 1A2
Aluminum drum: 1B1 or 1B2
Metal drum other than steel or aluminum: 1N1 or 1N2
Plywood drum: 1D
Fiber drum: 1G
Plastic drum: 1H1 or 1H2
Wooden barrel: 2C2
Steel jerrican: 3A1 or 3A2
Plastic jerrican: 3H1 or 3H2
Aluminum jerrican: 3B1 or 3B2
Steel box: 4A
Aluminum box: 4B
Natural wood box: 4C1 or 4C2
Plywood box: 4D
Reconstituted wood box: 4F
Fiberboard box: 4G
Solid plastic box: 4H2
Metal box other than steel or aluminum: 4N

Inner packagings:

Glass or earthenware receptacles
 Plastic receptacles
 Metal receptacles
 Glass ampoules

(c) Except for transportation by passenger aircraft, the following single packagings are authorized:

Steel drum: 1A1 or 1A2
 Aluminum drum: 1B1 or 1B2
 Plywood drum: 1D
 Plastic drum: 1H1 or 1H2
 Fiber drum: 1G
 Metal drum other than steel or aluminum:
 1N1 or 1N2
 Wooden barrel: 2C1 or 2C2
 Steel jerrican: 3A1 or 3A2
 Plastic jerrican: 3H1 or 3H2
 Aluminum jerrican: 3B1 or 3B2
 Steel box: 4A
 Steel box with liner: 4A
 Aluminum box: 4B
 Aluminum box with liner: 4B
 Metal box other than steel or aluminum: 4N
 Natural wood box: 4C1
 Natural wood box, sift proof: 4C2
 Plywood box: 4D
 Reconstituted wood box: 4F
 Fiberboard box: 4G
 Expanded plastic box: 4H1
 Solid plastic box: 4H2
 Bag, woven plastic: 5H1, 5H2 or 5H3
 Bag, plastic film: 5H4
 Bag, textile: 5L1, 5L2 or 5L3
 Bag, paper, multiwall, water resistant: 5M2
 Plastic receptacle in steel, aluminum, plywood, fiber or plastic drum: 6HA1, 6HB1, 6HD1, 6HG1 or 6HH1
 Plastic receptacle in steel, aluminum, wood, plywood or fiberboard box: 6HA2, 6HB2, 6HC, 6HD2 or 6HG2
 Glass, porcelain or stoneware in steel, aluminum, plywood or fiber drum: 6PA1, 6PB1, 6PD1 or 6PG1
 Glass, porcelain or stoneware in steel, aluminum, wooden or fiberboard box: 6PA2, 6PB2, 6PC or 6PG2
 Glass, porcelain or stoneware in expanded or solid plastic packaging: 6PH1 or 6PH2
 Cylinders, as prescribed for any compressed gas, except for Specification 8 and 3HT

[Amdt. 173-224, 55 FR 52634, Dec. 21, 1990, as amended by Amdt. 173-241, 59 FR 67511, 67518, Dec. 29, 1994; Amdt. 173-261, 62 FR 24734, May 6, 1997; 69 FR 76157, Dec. 20, 2004; 70 FR 34398, June 14, 2005; 78 FR 1089, Jan. 7, 2013]

§ 173.213 Non-bulk packagings for solid hazardous materials in Packing Group III.

(a) When §172.101 of this subchapter specifies that a solid hazardous material be packaged under this section, only non-bulk packagings prescribed in

this section may be used for its transportation. Each package must conform to the general packaging requirements of subpart B of part 173, to the requirements of part 178 of this subchapter at the Packing Group I, II or III performance level, and to the requirements of the special provisions of column 7 of the §172.101 table.

(b) The following combination packagings are authorized:

Outer packagings:

Steel drum: 1A1 or 1A2
 Aluminum drum: 1B1 or 1B2
 Metal drum other than steel or aluminum:
 1N1 or 1N2
 Plywood drum: 1D
 Fiber drum: 1G
 Plastic drum: 1H1 or 1H2
 Wooden barrel: 2C2
 Steel jerrican: 3A1 or 3A2
 Plastic jerrican: 3H1 or 3H2
 Aluminum jerrican: 3B1 or 3B2
 Steel box: 4A
 Aluminum box: 4B
 Natural wood box: 4C1 or 4C2
 Plywood box: 4D
 Reconstituted wood box: 4F
 Fiberboard box: 4G
 Solid plastic box: 4H2
 Metal box other than steel or aluminum: 4N

Inner packagings:

Glass or earthenware receptacles
 Plastic receptacles
 Metal receptacles
 Glass ampoules

(c) The following single packagings are authorized:

Steel drum: 1A1 or 1A2
 Aluminum drum: 1B1 or 1B2
 Plywood drum: 1D
 Plastic drum: 1H1 or 1H2
 Fiber drum: 1G
 Metal drum other than steel or aluminum:
 1N1 or 1N2
 Wooden barrel: 2C1 or 2C2
 Steel jerrican: 3A1 or 3A2
 Plastic jerrican: 3H1 or 3H2
 Aluminum jerrican: 3B1 or 3B2
 Steel box: 4A
 Steel box with liner: 4A
 Aluminum box: 4B
 Aluminum box with liner: 4B
 Metal box other than steel or aluminum: 4N
 Natural wood box: 4C1
 Natural wood box, sift proof: 4C2
 Plywood box: 4D
 Reconstituted wood box: 4F
 Fiberboard box: 4G
 Expanded plastic box: 4H1
 Solid plastic box: 4H2
 Bag, woven plastic: 5H1, 5H2 or 5H3
 Bag, plastic film: 5H4

§ 173.214

Bag, textile: 5L1, 5L2 or 5L3
Bag, paper, multiwall, water resistant: 5M2
Plastic receptacle in steel, aluminum, plywood, fiber or plastic drum: 6HA1, 6HB1, 6HD1, 6HG1 or 6HH1
Plastic receptacle in steel, aluminum, wood, plywood or fiberboard box: 6HA2, 6HB2, 6HC, 6HD2 or 6HG2
Glass, porcelain or stoneware in steel, aluminum, plywood or fiber drum: 6PA1, 6PB1, 6PD1 or 6PG1
Glass, porcelain or stoneware in steel, aluminum, wooden or fiberboard box: 6PA2, 6PB2, 6PC or 6PG2
Glass, porcelain or stoneware in expanded or solid plastic packaging: 6PH1 or 6PH2
Cylinders, as prescribed for any compressed gas, except for Specification 8 and 3HT

[Amdt. 173-224, 55 FR 52643, Dec. 21, 1990, as amended by Amdt. 173-241, 59 FR 67511, 67518, Dec. 29, 1994; Amdt. 173-261, 62 FR 24734, May 6, 1997; 69 FR 76158, Dec. 20, 2004; 70 FR 34398, June 14, 2005; 78 FR 1089, Jan. 7, 2013]

§ 173.214 Packagings which require approval by the Associate Administrator.

When §172.101 of this subchapter specifies that a hazardous material be packaged under this section, packagings and method of shipment must be approved by the Associate Administrator prior to the first shipment.

[Amdt. 173-224, 55 FR 52643, Dec. 21, 1990, as amended at 66 FR 45379, Aug. 28, 2001]

§ 173.216 Asbestos, blue, brown or white.

(a) Asbestos, blue, brown or white, includes each of the following hydrated mineral silicates: chrysolite, crocidolite, amosite, anthophyllite asbestos, tremolite asbestos, actinolite asbestos, and every product containing any of these materials.

(b) [Reserved]

(c) Packagings for asbestos must conform to the general packaging requirements of subpart B of this part but need not conform to the requirements of part 178 of this subchapter. Asbestos must be offered for transportation and transported in—

(1) Rigid, leaktight packagings, such as metal, plastic or fiber drums, portable tanks, hopper-type rail cars, or hopper-type motor vehicles;

(2) Bags or other non-rigid packagings in closed freight containers, motor vehicles, or rail cars that are loaded by and for the exclusive use of

49 CFR Ch. I (10-1-14 Edition)

the consignor and unloaded by the consignee;

(3) Bags or other non-rigid packagings which are dust and sift proof must be placed in rigid outer packagings or closed freight containers.

[Amdt. 173-224, 55 FR 52643, Dec. 21, 1990, as amended at 66 FR 45379, Aug. 28, 2001; 68 FR 45034, July 31, 2003; 71 CFR 78632, Dec. 29, 2006]

§ 173.217 Carbon dioxide, solid (dry ice).

(a) Carbon dioxide, solid (dry ice), when offered for transportation or transported by aircraft or water, must be packed in packagings designed and constructed to permit the release of carbon dioxide gas to prevent a buildup of pressure that could rupture the packagings. Packagings must conform to the general packaging requirements of subpart B of this part but need not conform to the requirements of part 178 of this subchapter.

(b) For transportation by vessel:

(1) Each transport vehicle and freight container containing solid carbon dioxide must be conspicuously marked on two sides “WARNING CO₂ SOLID (DRY ICE).”

(2) Other packagings containing solid carbon dioxide must be marked “CARBON DIOXIDE, SOLID—DO NOT STOW BELOW DECKS.”

(c) For transportation by aircraft:

(1) In addition to the applicable marking requirements in subpart D of part 172, the net mass of the carbon dioxide, solid (dry ice) must be marked on the outside of the package. This provision also applies to unit load devices (ULDs) when the ULD contains dry ice and is considered the packaging.

(2) The shipper must make arrangements with the operator for each shipment.

(3) The quantity limits per package shown in Columns (9A) and (9B) of the Hazardous Materials Table in §172.101 are not applicable to dry ice being used as a refrigerant for other than hazardous materials loaded in a unit load device or other type of pallet. In such a case, the unit load device or other type of pallet must allow the venting of the carbon dioxide gas to prevent a

dangerous build up of pressure, and be identified to the operator.

(4) Dry ice is excepted from the shipping paper requirements of subpart C of part 172 of this subchapter provided alternative written documentation is supplied containing the following information: proper shipping name (Dry ice or Carbon dioxide, solid), class 9, UN number 1845, the number of packages, and the net quantity of dry ice in each package. The information must be included with the description of the materials.

(5) Carbon dioxide, solid (dry ice), in quantities not exceeding 2.5 kg (5.5 pounds) per package and used as a refrigerant for the contents of the package is excepted from all other requirements of this subchapter if the requirements of paragraph (a) of this section are complied with and the package is marked "Carbon dioxide, solid" or "Dry ice", is marked with the name of the contents being cooled, and is marked with the net weight of the dry ice or an indication that the net weight is 2.5 kg (5.5 pounds) or less.

(d) Carbon dioxide, solid (dry ice), when used to refrigerate materials being shipped for diagnostic or treatment purposes (*e.g.*, frozen medical specimens), is excepted from the shipping paper and certification requirements of this subchapter if the requirements of paragraphs (a) and (c)(2) of this section are met and the package is marked "Carbon dioxide, solid" or "Dry ice" and is marked with an indication that the material being refrigerated is being transported for diagnostic or treatment purposes.

[73 FR 4718, Jan. 28, 2008]

§ 173.218 Fish meal or fish scrap.

(a) Except as provided in Column (7) of the HMT in §172.101 of this subchapter, fish meal or fish scrap, containing at least 6%, but not more than 12% water, is authorized for transportation by vessel only when packaged as follows:

- (1) Burlap (jute) bag;
- (2) Multi-wall paper bag;
- (3) Polyethylene-lined burlap or paper bag;
- (4) Cargo tank;
- (5) Portable tank;
- (6) Rail car; or

(7) Freight container.

(b) [Reserved]

(c) When fish scrap or fish meal is offered for transportation by vessel in bulk in freight containers, the fish meal must contain at least 100 ppm of anti-oxident (ethoxyquin) at the time of shipment.

[Amdt. 173-224, 55 FR 52643, Dec. 21, 1990, as amended at 68 FR 45034, July 31, 2003]

§ 173.219 Life-saving appliances.

(a) A life-saving appliance, self-inflating or non-self-inflating, containing small quantities of hazardous materials that are required as part of the life-saving appliance must conform to the requirements of this section. Packagings must conform to the general packaging requirements of subpart B of this part but need not conform to the requirements of part 178 of this subchapter. The appliances must be packed, so that they cannot be accidentally activated and, except for life vests, the hazardous materials must be in inner packagings packed so as to prevent shifting within the outer packaging. The hazardous materials must be an integral part of the appliance and in quantities that do not exceed those appropriate for the actual appliance when in use.

(b) Life saving appliances may contain:

(1) Division 2.2 compressed or liquefied gases must be packaged in cylinders in accordance with the requirements of this subchapter;

(2) Signal devices (Class 1), which may include smoke and illumination signal flares;

(3) Electric storage batteries and lithium batteries (life-saving appliances containing lithium batteries must be packed in accordance with §173.185 and Special Provisions A54 and A101 as applicable.);

(4) First aid or repair kits conforming to the applicable material and quantity limitations of §173.161 of this subchapter;

(5) Strike-anywhere matches;

(6) For self-inflating life saving appliances only, cartridges power device of Division 1.4S, for purposes of the self-inflating mechanism provided that the quantity of explosives per appliance does not exceed 3.2 g; or

§ 173.220

49 CFR Ch. I (10–1–14 Edition)

(7) Limited quantities of other hazardous materials.

(c) Hazardous materials in life saving appliances must be packaged as follows:

(1) Division 2.2 compressed or liquefied gases must be packaged in cylinders in accordance with the requirements of this subchapter;

(2) Signal devices (Class 1) must be in packagings that prevent them from being inadvertently activated;

(3) Strike-anywhere matches must be cushioned to prevent movement or friction in a metal or composition receptacle with a screw-type closure in a manner that prevents them from being inadvertently activated;

(4) Limited quantities of other hazardous materials must be packaged in accordance with the requirements of this subchapter; and

(5) Life-saving appliances containing no hazardous materials other than cylinders of Division 2.2 compressed or liquefied gases with no subsidiary risk, with a capacity not exceeding 120 mL, installed solely for the purpose of activating the appliance, are not subject to the provisions of this subchapter provided they are overpacked in rigid outer packagings with a maximum gross mass of 40 kg. For transportation by aircraft, such appliances must be transported as cargo and may not be carried onboard an aircraft by passengers or crewmembers in carry-on baggage, checked baggage, or on their person unless specifically excepted by §175.10.

[69 FR 76158, Dec. 20, 2004, as amended at 72 FR 44950, Aug. 9, 2007; 73 FR 57006, Oct. 1, 2008; 78 FR 1089, Jan. 7, 2013; 79 FR 46039, Aug. 6, 2014]

§ 173.220 Internal combustion engines, self-propelled vehicles, mechanical equipment containing internal combustion engines, battery-powered equipment or machinery, fuel cell-powered equipment or machinery.

(a) *Applicability.* An internal combustion engine, self-propelled vehicle, mechanized equipment containing an internal combustion engine, a battery-powered vehicle or equipment, or a fuel cell-powered vehicle or equipment, or any combination thereof, is subject to the requirements of this subchapter

when transported as cargo on a transport vehicle, vessel, or aircraft if—

(1) The engine contains a liquid or gaseous fuel. An engine may be considered as not containing fuel when the engine components and any fuel lines have been completely drained, sufficiently cleaned of residue, and purged of vapors to remove any potential hazard and the engine when held in any orientation will not release any liquid fuel;

(2) The fuel tank contains a liquid or gaseous fuel. A fuel tank may be considered as not containing fuel when the fuel tank and the fuel lines have been completely drained, sufficiently cleaned of residue, and purged of vapors to remove any potential hazard;

(3) It is equipped with a wet battery (including a non-spillable battery), a sodium battery or a lithium battery; or

(4) Except as provided in paragraph (f)(1) of this section, it contains other hazardous materials subject to the requirements of this subchapter.

(b) *Requirements.* Unless otherwise excepted in paragraph (b)(4) of this section, vehicles, engines, and equipment are subject to the following requirements:

(1) *Flammable liquid fuel.* A fuel tank containing a flammable liquid fuel must be drained and securely closed, except that up to 500 mL (17 ounces) of residual fuel may remain in the tank, engine components, or fuel lines provided they are securely closed to prevent leakage of fuel during transportation. Self-propelled vehicles containing diesel fuel are excepted from the requirement to drain the fuel tanks, provided that sufficient ullage space has been left inside the tank to allow fuel expansion without leakage, and the tank caps are securely closed.

(2) *Flammable liquefied or compressed gas fuel.* (i) For transportation by motor vehicle, rail car or vessel, fuel tanks and fuel systems containing flammable liquefied or compressed gas fuel must be securely closed. For transportation by vessel, the requirements of §§176.78(k) and 176.905 of this subchapter apply.

(ii) For transportation by aircraft:

(A) Flammable gas-powered vehicles, machines, equipment or cylinders containing the flammable gas must be

completely emptied of flammable gas. Lines from vessels to gas regulators, and gas regulators themselves, must also be drained of all traces of flammable gas. To ensure that these conditions are met, gas shut-off valves must be left open and connections of lines to gas regulators must be left disconnected upon delivery of the vehicle to the operator. Shut-off valves must be closed and lines reconnected at gas regulators before loading the vehicle aboard the aircraft; or alternatively;

(B) Flammable gas powered vehicles, machines or equipment, which have cylinders (fuel tanks) that are equipped with electrically operated valves, may be transported under the following conditions:

(1) The valves must be in the closed position and in the case of electrically operated valves, power to those valves must be disconnected;

(2) After closing the valves, the vehicle, equipment or machinery must be operated until it stops from lack of fuel before being loaded aboard the aircraft;

(3) In no part of the closed system shall the pressure exceed 5% of the maximum allowable working pressure of the system or 290 psig (2000 kPa), whichever is less; and

(4) There must not be any residual liquefied gas in the system, including the fuel tank.

(3) *Truck bodies or trailers on flat cars—flammable liquid or gas powered.* Truck bodies or trailers with automatic heating or refrigerating equipment of the flammable liquid type may be shipped with fuel tanks filled and equipment operating or inoperative, when used for the transportation of other freight and loaded on flat cars as part of a joint rail and highway movement, provided the equipment and fuel supply conform to the requirements of §177.834(1) of this subchapter.

(4) *Modal exceptions.* Quantities of flammable liquid fuel greater than 500 mL (17 ounces) may remain in the fuel tank in self-propelled vehicles and mechanical equipment only under the following conditions:

(i) For transportation by motor vehicle or rail car, the fuel tanks must be securely closed.

(ii) For transportation by vessel, the shipment must conform to §176.905 of this subchapter.

(iii) For transportation by aircraft, when carried in aircraft designed or modified for vehicle ferry operations when all the following conditions must be met:

(A) Authorization for this type operation has been given by the appropriate authority in the government of the country in which the aircraft is registered;

(B) Each vehicle is secured in an upright position;

(C) Each fuel tank is filled in a manner and only to a degree that will preclude spillage of fuel during loading, unloading, and transportation; and

(D) Each area or compartment in which a self-propelled vehicle is being transported is suitably ventilated to prevent the accumulation of fuel vapors.

(c) *Battery-powered or installed.* Batteries must be securely installed, and wet batteries must be fastened in an upright position. Batteries must be protected against a dangerous evolution of heat, short circuits, and damage to terminals in conformance with §173.159(a) and leakage; or must be removed and packaged separately under §173.159. Battery-powered vehicles, machinery or equipment including battery-powered wheelchairs and mobility aids are not subject to any other requirements of this subchapter except §173.21 of this subchapter when transported by rail, highway or vessel.

(d) *Lithium batteries.* Except as provided in §172.102, special provision A101, of this subchapter, vehicles, engines, and machinery powered by lithium metal batteries, that are transported with these batteries installed, are forbidden aboard passenger-carrying aircraft. Lithium batteries contained in vehicles, engines, or mechanical equipment must be securely fastened in the battery holder of the vehicle, engine, or mechanical equipment, and be protected in such a manner as to prevent damage and short circuits (e.g., by the use of non-conductive caps that cover the terminals entirely). Except for vehicles transported by highway, rail, or vessel with prototype or

§ 173.221

49 CFR Ch. I (10–1–14 Edition)

low production lithium batteries securely installed, each lithium battery must be of a type that has successfully passed each test in the UN Manual of Tests and Criteria, as specified in §173.185, unless approved by the Associate Administrator.

(e) *Fuel cells.* A fuel cell must be secured and protected in a manner to prevent damage to the fuel cell. Equipment (other than vehicles, engines or mechanical equipment) such as consumer electronic devices containing fuel cells (fuel cell cartridges) must be described as “Fuel cell cartridges contained in equipment” and transported in accordance with §173.230 of this subchapter.

(f) *Other hazardous materials.* (1) Items containing hazardous materials, such as fire extinguishers, compressed gas accumulators, safety devices, and other hazardous materials that are integral components of the motor vehicle, engine, or mechanical equipment, and that are necessary for the operation of the vehicle, engine, or mechanical equipment, or for the safety of its operator or passengers, must be securely installed in the motor vehicle, engine, or mechanical equipment. Such items are not otherwise subject to the requirements of this subchapter. Equipment (other than vehicles, engines, or mechanical equipment), such as consumer electronic devices containing lithium batteries, must be described as “Lithium metal batteries contained in equipment” or “Lithium ion batteries contained in equipment,” as appropriate, and transported in accordance with §173.185 of this subchapter, and applicable special provisions. Equipment (other than vehicles, engines, or mechanical equipment), such as consumer electronic devices containing fuel cells (fuel cell cartridges), must be described as “Fuel cell cartridges contained in equipment” and transported in accordance with §173.230 of this subchapter.

(2) Other hazardous materials must be packaged and transported in accordance with the requirements of this subchapter.

(g) *Additional requirements for internal combustion engines and vehicles with certain electronic equipment when transported by aircraft or vessel.* When an in-

ternal combustion engine that is not installed in a vehicle or equipment is offered for transportation by aircraft or vessel, all fuel, coolant or hydraulic systems remaining in the engine must be drained as far as practicable, and all disconnected fluid pipes that previously contained fluid must be sealed with leak-proof caps that are positively retained. When offered for transportation by aircraft, vehicles equipped with theft-protection devices, installed radio communications equipment or navigational systems must have such devices, equipment or systems disabled.

(h) *Exceptions.* Except as provided in paragraph (f)(2) of this section, shipments made under the provisions of this section—

(1) Are not subject to any other requirements of this subchapter for transportation by motor vehicle or rail car; and

(2) Are not subject to the requirements of subparts D, E and F (marking, labeling and placarding, respectively) of part 172 of this subchapter or §172.604 of this subchapter (emergency response telephone number) for transportation by vessel or aircraft. For transportation by aircraft, the provisions of §173.159(b)(2) of this part as applicable, the provisions of §173.230(f), as applicable, other applicable requirements of this subchapter, including shipping papers, emergency response information, notification of pilot-in-command, general packaging requirements, and the requirements specified in §173.27 of this subchapter must be met. For transportation by vessel, additional exceptions are specified in §176.905 of this subchapter.

[76 FR 3377, Jan. 19, 2011, as amended at 78 FR 1089, Jan. 7, 2013; 78 FR 60754, Oct. 2, 2013; 79 FR 46039, Aug. 6, 2014]

§ 173.221 Polymeric beads, expandable and Plastic molding compound.

(a) Non-bulk shipments of Polymeric beads (or granules), expandable *evolving flammable vapor* and Plastic molding compound *in dough, sheet or extruded rope form, evolving flammable vapor* must be packed in: metal (4A, 4B, or 4N), wooden (4C1 or 4C2), plywood (4D), fiberboard (4G), reconstituted wood (4F), plastic (4H1 or 4H2) boxes, plywood

drums (1D) or fiber drums (1G) with sealed inner plastic liners; in vapor tight metal or plastic drums (1A1, 1A2, 1B1, 1B2, 1N1, 1N2, 1H1 or 1H2); in vapor tight metal or plastic jerricans (3A1, 3A2, 3B1, 3B2, 3H1, or 3H2); or packed in non-specification packagings when transported in dedicated vehicles or freight containers. The packagings need not conform to the requirements for package testing in part 178 of this subchapter, but must be capable of containing any evolving gases from the contents during normal conditions of transportation.

(b) Bulk shipments of Polymeric beads (or granules), expandable, *evolving flammable vapor* or Plastic molding compounds *in dough, sheet or extruded rope, evolving flammable vapor* may be packed in non-specification bulk packagings. Except for transportation by highway and rail, bulk packagings must be capable of containing any gases evolving from the contents during normal conditions of transportation.

(c) For transportation by vessel, the provisions of § 176.907 must be met.

[64 FR 10779, Mar. 5, 1999, as amended at 78 FR 1089, Jan. 7, 2013]

§ 173.222 Dangerous goods in equipment, machinery or apparatus.

Hazardous materials in machinery or apparatus are excepted from the specification packaging requirements of this subchapter when packaged according to this section. Hazardous materials in machinery or apparatus must be packaged in strong outer packagings, unless the receptacles containing the hazardous materials are afforded adequate protection by the construction of the machinery or apparatus. Each package must conform to the packaging requirements of subpart B of this part, except for the requirements in §§ 173.24(a)(1) and 173.27(e), and the following requirements:

(a) If the machinery or apparatus contains more than one hazardous material, the materials must not be capable of reacting dangerously together.

(b) The nature of the containment must be as follows—

(1) Damage to the receptacles containing the hazardous materials during transport is unlikely. However, in the

event of damage to the receptacles containing the hazardous materials, no leakage of the hazardous materials from the machinery or apparatus is possible. A leakproof liner may be used to satisfy this requirement.

(2) Receptacles containing hazardous materials must be secured and cushioned so as to prevent their breakage or leakage and so as to control their movement within the machinery or apparatus during normal conditions of transportation. Cushioning material must not react dangerously with the content of the receptacles. Any leakage of the contents must not substantially impair the protective properties of the cushioning material.

(3) Receptacles for gases, their contents and filling densities must conform to the applicable requirements of this subchapter, unless otherwise approved by the Associate Administrator.

(c) The total net quantity of hazardous materials contained in one item of machinery or apparatus must not exceed the following:

(1) 1 kg (2.2 pounds) in the case of solids;

(2) 0.5 L (0.1 gallons) in the case of liquids;

(3) 0.5 kg (1.1 pounds) in the case of Division 2.2 gases. For transportation by aircraft, Division 2.2 gases with subsidiary risks and refrigerated liquefied gases are not authorized; and

(4) A total quantity of not more than the aggregate of that permitted in paragraphs (c)(1) through (c)(3) of this section, for each category of material in the package, when a package contains hazardous materials in two or more of the categories in paragraphs (c)(1) through (c)(3) of this section.

(d) Except for transportation by aircraft, when a package contains hazardous materials in two or more of the categories listed in paragraphs (c)(1) through (c)(3) of this section the total quantity required by § 172.202(c) of this subchapter to be entered on the shipping paper must be either the aggregate quantity, or the estimated quantity, of all hazardous materials, expressed as net mass.

[64 FR 10779, Mar. 5, 1999, as amended at 64 FR 44428, Aug. 16, 1999; 66 FR 45379, Aug. 28, 2001; 70 FR 56098, Sept. 23, 2005; 71 FR 78633, Dec. 29, 2006; 74 FR 2259, Jan. 14, 2009]

§ 173.223 Packagings for certain flammable solids.

(a) Packagings for “Musk xylene,” “5-tert-Butyl-2,4,6-trinitro-m-xylene,” “Azodicarbonamide,” or “Isosorbide-5-mononitrate,” when offered for transportation or transported by rail, highway, or vessel, must conform to the general packaging requirements of subpart B of part 173, and to the requirements of part 178 of this subchapter at the Packing Group III performance level and may only be transported in the following packagings:

(1) Fiberboard box (4G) with a single inner plastic bag, and a maximum net mass of not more than 50 kg (110 lbs).

(2) Fiberboard box (4G) or fiber drum (1G), with a plastic inner packaging not exceeding 5 kg (11 lbs), and a maximum net mass of not more than 25 kg (55 lbs).

(3) Fiber drum (1G), and a maximum net mass of not more than 50 kg (110 lbs), that may be fitted with a coating or lining.

(b) [Reserved]

[Doc. No. 2002–13658, 68 FR 45035, July 31, 2003; 75 FR 5394, Feb. 2, 2010]

§ 173.224 Packaging and control and emergency temperatures for self-reactive materials.

(a) *General.* When the § 172.101 table of this subchapter specifies that a Division 4.1 material be packaged in accordance with this section, only packagings which conform to the provisions of this section may be used. Each packaging must conform to the general packaging requirements of subpart B of this part and the applicable requirements of part 178 of this subchapter. Non-bulk packagings must meet Packing Group II performance levels. To avoid unnecessary confinement, metallic non-bulk packagings meeting Packing Group I are not authorized. Self-reactive materials which require temperature control are subject to the provisions of § 173.21(f). Packagings required to bear a Class 1 subsidiary label must conform to §§ 173.60 through 173.62.

(b) *Self-Reactive Materials Table.* The Self-Reactive Materials Table speci-

fies, by technical name, those self-reactive materials that are authorized for transportation and not subject to the approval provisions of § 173.124(a)(2)(iii). A self-reactive material identified by technical name in the following table is authorized for transportation only if it conforms to all applicable provisions of the table. The column headings of the Self-Reactive Materials Table are as follows:

(1) *Technical name.* Column 1 specifies the technical name.

(2) *ID number.* Column 2 specifies the identification number which is used to identify the proper shipping name in the § 172.101 table.

(3) *Concentration of self-reactive material.* Column 3 specifies the concentration (percent) limitations, if any, in mixtures or solutions for the self-reactive material. Limitations are given as minimums, maximums, or a range, as appropriate. A range includes the lower and upper limits (i.e., “53–100” means from, and including, 53 percent to, and including 100 percent).

(4) *Packing method.* Column 4 specifies the highest packing method which is authorized for the self-reactive material. A packing method corresponding to a smaller package size may be used, but a packing method corresponding to a larger package size may not be used. The Table of Packing Methods in § 173.225(d) defines the packing methods. Bulk packagings for Type F self-reactive substances are authorized by § 173.225(f) for IBCs and § 173.225(h) for bulk packagings other than IBCs. Additional bulk packagings are authorized if approved by the Associate Administrator.

(5) *Control temperature.* Column 5 specifies the control temperature in °C. Temperatures are specified only when temperature controls are required (see § 173.21(f)).

(6) *Emergency temperature.* Column 6 specifies the emergency temperature in °C. Temperatures are specified only when temperature controls are required (see § 173.21(f)).

(7) *Notes.* Column 7 specifies other applicable provisions, as set forth in notes following the table.

SELF-REACTIVE MATERIALS TABLE

Self-reactive substance (1)	Identifi- cation No. (2)	Concentration— (%) (3)	Packing method (4)	Control tem- perature—(°C) (5)	Emergency temperature (6)	Notes (7)
Acetone-pyrogallol copolymer 2-diazo-1-naphthol-5-sulphonate.	3228	100	OP8			
Azodicarbonamide formulation type B, temperature controlled.	3232	<100	OP5	1
Azodicarbonamide formulation type C	3224	<100	OP6			
Azodicarbonamide formulation type C, temperature controlled.	3234	<100	OP6	1
Azodicarbonamide formulation type D	3226	<100	OP7			
Azodicarbonamide formulation type D, temperature controlled.	3236	<100	OP7	1
2,2'-Azodi(2,4-dimethyl-4-methoxyvaleronitrile).	3236	100	OP7	-5	+5.	
2,2'-Azodi(2,4-dimethylvaleronitrile)	3236	100	OP7	+10	+15.	
2,2'-Azodi(ethyl 2-methylpropionate)	3235	100	OP7	+20	+25.	
1,1-Azodi(hexahydrobenzotrile)	3226	100	OP7			
2,2-Azodi(isobutyronitrile)	3234	100	OP6	+40	+45.	
2,2'-Azodi(isobutyronitrile) as a water based paste.	3224	≤50	OP6			
2,2-Azodi(2-methylbutyronitrile)	3236	100	OP7	+35	+40.	
Benzene-1,3-disulphonylhydrazide, as a paste.	3226	52	OP7			
Benzene sulphohydrazide	3226	100	OP7			
4-(Benzyl(ethyl)amino)-3-ethoxybenzenediazonium zinc chloride.	3226	100	OP7			
4-(Benzyl(methyl)amino)-3-ethoxybenzenediazonium zinc chloride.	3236	100	OP7	+40	+45.	
3-Chloro-4-diethylaminobenzenediazonium zinc chloride.	3226	100	OP7			
2-Diazo-1-Naphthol sulphonic acid ester mixture.	3226	<100	OP7	4
2-Diazo-1-Naphthol-4-sulphonyl chloride	3222	100	OP5			
2-Diazo-1-Naphthol-5-sulphonyl chloride	3222	100	OP5			
2,5-Dibutoxy-4-(4-morpholinyl)-Benzene-diazonium, tetrachlorozincate (2:1).	3228	100	OP8			
2,5-Diethoxy-4-morpholinobenzenediazonium zinc chloride.	3236	67-100	OP7	+35	+40.	
2,5-Diethoxy-4-morpholinobenzenediazonium zinc chloride.	3236	66	OP7	+40	+45.	
2,5-Diethoxy-4-morpholinobenzenediazonium tetrafluoroborate.	3236	100	OP7	+30	+35.	
2,5-Diethoxy-4-(phenylsulphonyl)benzenediazonium zinc chloride.	3236	67	OP7	+40	+45.	
2,5-Diethoxy-4-(4-morpholinyl)-benzenediazonium sulphate.	3226	100	OP7			
Diethylene glycol bis(allyl carbonate) + Diisopropylperoxydicarbonate.	3237	≥88+≤12	OP8	-10	0.	
2,5-Dimethoxy-4-(4-methylphenylsulphonyl)benzenediazonium zinc chloride.	3236	79	OP7	+40	+45.	
4-Dimethylamino-6-(2-dimethylaminoethoxy)toluene-2-diazonium zinc chloride.	3236	100	OP7	+40	+45.	
4-(Dimethylamino)-benzenediazonium trichlorozincate (-1).	3228	100	OP8			
N,N'-Dinitroso-N, N'-dimethyl-terephthalamide, as a paste.	3224	72	OP6			
N,N'-Dinitrosopentamethylenetetramine ..	3224	82	OP6	2
Diphenyloxide-4,4'-disulphonylhydrazide	3226	100	OP7			
Diphenyloxide-4,4'-disulphonylhydrazide	3226	100	OP7			
4-Dipropylaminobenzenediazonium zinc chloride.	3226	100	OP7			

SELF-REACTIVE MATERIALS TABLE—Continued

Self-reactive substance (1)	Identifi- cation No. (2)	Concentration— (%) (3)	Packing method (4)	Control tem- perature—(°C) (5)	Emergency temperature (6)	Notes (7)
2-(N,N-Ethoxycarbonylphenylamino)-3-methoxy-4-(N-methyl-N-cyclohexylamino)benzenediazonium zinc chloride.	3236	63–92	OP7	+40	+45.	
2-(N,N-Ethoxycarbonylphenylamino)-3-methoxy-4-(N-methyl-N-cyclohexylamino)benzenediazonium zinc chloride.	3236	62	OP7	+35	+40.	
N-Formyl-2-(nitromethylene)-1,3-perhydrothiazine.	3236	100	OP7	+45	+50.	
2-(2-Hydroxyethoxy)-1-(pyrrolidin-1-yl)benzene-4-diazonium zinc chloride.	3236	100	OP7	+45	+50.	
3-(2-Hydroxyethoxy)-4-(pyrrolidin-1-yl)benzenediazonium zinc chloride.	3236	100	OP7	+40	+45.	
2-(N,N-Methylaminoethylcarbonyl)-4-(3,4-dimethyl-phenylsulphonyl)benzene diazonium zinc chloride.	3236	96	OP7	+45	+50.	
4-Methylbenzenesulphonylhydrazide	3226	100	OP7			
3-Methyl-4-(pyrrolidin-1-yl)benzenediazonium tetrafluoroborate.	3234	95	OP6	+45	+50.	
4-Nitrosophenol	3236	100	OP7	+35	+40.	
Self-reactive liquid, sample	3223	OP2	3
Self-reactive liquid, sample, temperature control.	3233	OP2	3
Self-reactive solid, sample	3224	OP2	3
Self-reactive solid, sample, temperature control.	3234	OP2	3
Sodium 2-diazo-1-naphthol-4-sulphonate	3226	100	OP7			
Sodium 2-diazo-1-naphthol-5-sulphonate	3226	100	OP7			
Tetramine palladium (II) nitrate	3234	100	OP6	+30	+35.	

NOTES: 1. The emergency and control temperatures must be determined in accordance with § 173.21(f).
 2. With a compatible diluent having a boiling point of not less than 150 °C.
 3. Samples may only be offered for transportation under the provisions of paragraph (c)(3) of this section.
 4. This entry applies to mixtures of esters of 2-diazo-1-naphthol-4-sulphonic acid and 2-diazo-1-naphthol-5-sulphonic acid.

(c) *New self-reactive materials, formulations and samples.* (1) Except as provided for samples in paragraph (c)(3) of this section, no person may offer, accept for transportation, or transport a self-reactive material which is not identified by technical name in the Self-Reactive Materials Table of this section, or a formulation of one or more self-reactive materials which are identified by technical name in the table, unless the self-reactive material is assigned a generic type and shipping description and is approved by the Associate Administrator under the provisions of § 173.124(a)(2)(iii).

(2) Except as provided by an approval issued under § 173.124(a)(2)(iii), intermediate bulk and bulk packagings are not authorized.

(3) *Samples.* Samples of new self-reactive materials or new formulations of self-reactive materials identified in the Self-Reactive Materials Table in paragraph (b) of this section, for which

complete test data are not available, and which are to be transported for further testing or product evaluation, may be assigned an appropriate shipping description for Self-reactive materials Type C, packaged and offered for transportation under the following conditions:

(i) Data available to the person offering the material for transportation must indicate that the sample would pose a level of hazard no greater than that of a self-reactive material Type B and that the control temperature, if any, is sufficiently low to prevent any dangerous decomposition and sufficiently high to prevent any dangerous phase separation;

(ii) The sample must be packaged in accordance with packing method OP2;

(iii) Packages of the self-reactive material may be offered for transportation and transported in a quantity not to exceed 10 kg (22 pounds) per transport vehicle; and

(iv) One of the following shipping descriptions must be assigned:

(A) Self-reactive, liquid, type C, 4.1, UN3223.

(B) Self-reactive, solid, type C, 4.1, UN3224.

(C) Self-reactive, liquid, type C, temperature controlled, 4.1, UN3233.

(D) Self-reactive, solid, type C, temperature controlled, 4.1, UN3234.

[Amdt. 173-241, 59 FR 67511, Dec. 29, 1994, as amended by Amdt. 173-242, 60 FR 26806, May 18, 1995; Amdt. 173-246, 60 FR 49110, Sept. 21, 1995; Amdt. 173-256, 61 FR 51338, Oct. 1, 1996; Amdt. 173-261, 62 FR 24734, 24735, May 6, 1997; 62 FR 45702, Aug. 28, 1997; 64 FR 10779, Mar. 5, 1999; 65 FR 58630, Sept. 29, 2000; 66 FR 33431, June 21, 2001; 66 FR 45379, Aug. 28, 2001; 68 FR 45035, July 31, 2003; 69 FR 76159, Dec. 20, 2004; 71 FR 78633, Dec. 29, 2006]

§ 173.225 Packaging requirements and other provisions for organic peroxides.

(a) *General.* When the §172.101 table specifies that an organic peroxide must be packaged under this section, the organic peroxide must be packaged and offered for transportation in accordance with the provisions of this section. Each packaging must conform to the general requirements of subpart B of part 173 and to the applicable requirements of part 178 of this subchapter. Non-bulk packagings must meet Packing Group II performance levels. To avoid unnecessary confinement, metallic non-bulk packagings meeting Packing Group I are not authorized. No used material, other than production residues or regrind from the same production process, may be used in plastic packagings. Organic peroxides that require temperature control are subject to the provisions of §173.21(f). When an IBC or bulk packaging is authorized and meets the requirements of paragraph (f) or (h) of this section, respectively, lower control temperatures than those specified for non-bulk packaging may be required. An organic peroxide not identified in paragraph (c), (e), or (g) of this section by technical name, or not assigned to a generic type in accordance with the provisions in paragraph (b)(3) of this section, must conform to the provisions of paragraph (c) of §173.128.

(b) *New organic peroxides, formulations and samples.* (1) Except as provided for

samples in paragraph (b)(2) of this section, no person may offer for transportation an organic peroxide that is not identified by technical name in the Organic Peroxides Table, Organic Peroxide IBC Table, or the Organic Peroxide Portable Tank Table of this section, or a formulation of one or more organic peroxides that are identified by technical name in one of those tables, unless the organic peroxide is assigned a generic type and shipping description and is approved by the Associate Administrator under the provisions of §173.128(d) of this subchapter.

(2) *Samples.* Samples of new organic peroxides or new formulations of organic peroxides identified in the Organic Peroxides Table in paragraph (c) of this section, for which complete test data are not available, and that are to be transported for further testing or product evaluation, may be assigned an appropriate shipping description for organic peroxide Type C, packaged and offered for transportation, under the following conditions:

(i) Data available to the person offering the material for transportation must indicate that the sample would pose a level of hazard no greater than that of an organic peroxide Type B and that the control temperature, if any, is sufficiently low to prevent any dangerous decomposition and sufficiently high to prevent any dangerous phase separation;

(ii) The sample must be packaged in accordance with packing method OP2, for a liquid or solid, respectively;

(iii) Packages of the organic peroxide may be offered for transportation and transported in a quantity not to exceed 10 kg (22 pounds) per transport vehicle; and

(iv) One of the following shipping descriptions must be assigned:

(A) Organic peroxide Type C, liquid, 5.2, UN 3103;

(B) Organic peroxide Type C, solid, 5.2, UN 3104;

(C) Organic peroxide Type C, liquid, temperature controlled, 5.2, UN 3113; or

(D) Organic peroxide Type C, solid, temperature controlled, 5.2, UN 3114.

(3) *Mixtures.* Mixtures of organic peroxides individually identified in the Organic Peroxides Table in paragraph (c) of this section may be classified as the

same type of organic peroxide as that of the most dangerous component and be transported under the conditions for transportation given for this type. If the stable components form a thermally less stable mixture, the SADT of the mixture must be determined and the new control and emergency temperature derived under the provisions of § 173.21(f).

(c) *Organic peroxides table.* The following Organic Peroxides Table specifies by technical name those organic peroxides that are authorized for transportation and not subject to the approval provisions of § 173.128 of this part. An organic peroxide identified by technical name in the following table is authorized for transportation only if it conforms to all applicable provisions of the table. The column headings of the Organic Peroxides Table are as follows:

(1) *Technical name.* The first column specifies the technical name.

(2) *ID number.* The second column specifies the identification (ID) number which is used to identify the proper shipping name in the § 172.101 table. The word “EXEMPT” appearing in the column denotes that the material is not regulated as an organic peroxide.

(3) *Concentration of organic peroxide.* The third column specifies concentration (mass percent) limitations, if any, in mixtures or solutions for the organic peroxide. Limitations are given as minimums, maximums, or a range, as appropriate. A range includes the lower and upper limits (*i.e.*, “53–100” means from, and including, 53% to, and including 100%). See introductory paragraph of § 172.203(k) of this subchapter for additional description requirements for an organic peroxide that may qualify for more than one generic listing, depending on its concentration.

(4) *Concentration of diluents.* The fourth column specifies the type and concentration (mass percent) of diluent or inert solid, when required. Other types and concentrations of diluents may be used if approved by the Associate Administrator.

(i) The required mass percent of “Diluent type A” is specified in column

4a. A diluent type A is an organic liquid that does not detrimentally affect the thermal stability or increase the hazard of the organic peroxide and with a boiling point not less than 150 °C at atmospheric pressure. Type A diluents may be used for desensitizing all organic peroxides.

(ii) The required mass percent of “Diluent type B” is specified in column 4b. A diluent type B is an organic liquid which is compatible with the organic peroxide and which has a boiling point, at atmospheric pressure, of less than 150 °C (302 °F) but at least 60 °C (140 °F), and a flash point greater than 5 °C (41 °F). Type B diluents may be used for desensitizing all organic peroxides, when specified in the organic peroxide tables, provided that the boiling point is at least 60 °C (140 °F) above the SADT of the peroxide in a 50 kg (110 lbs) package. A type A diluent may be used to replace a type B diluent in equal concentration.

(iii) The required mass percent of “Inert solid” is specified in column 4c. An inert solid is a solid that does not detrimentally affect the thermal stability or hazard of the organic peroxide.

(5) *Concentration of water.* Column 5 specifies, in mass percent, the minimum amount of water, if any, which must be in formulation.

(6) *Packing method.* Column 6 specifies the highest packing method (largest packaging capacity) authorized for the organic peroxide. Lower numbered packing methods (smaller packaging capacities) are also authorized. For example, if OP3 is specified, then OP2 and OP1 are also authorized. The Table of Packing Methods in paragraph (d) of this section defines the non-bulk packing methods.

(7) *Temperatures.* Column 7a specifies the control temperature. Column 7b specifies the emergency temperature. Temperatures are specified only when temperature controls are required. (See § 173.21(f)).

(8) *Notes.* Column 8 specifies other applicable provisions, as set forth in notes following the table.

ORGANIC PEROXIDE TABLE

Technical name (1)	ID number (2)	Concentration (mass %) (3)	Diluent (mass %)			Water (mass %) (5)	Packing method (6)	Temperature (°C)		Notes (8)
			A (4a)	B (4b)	I (4c)			Control (7a)	Emergency (7b)	
Acetyl acetone peroxide	UN3105 ..	≤42	≥48	≥8	OP7	2
Acetyl acetone peroxide [as a paste].	UN3106 ..	≤32	OP7	21
Acetyl cyclohexanesulfonyl peroxide.	UN3112 ..	≤82	≥12	OP4	-10	0	
Acetyl cyclohexanesulfonyl peroxide.	UN3115 ..	≤32	≥68	OP7	-10	0	
tert-Amyl hydroperoxide	UN3107 ..	≤88	≥6	≥6	OP8	
tert-Amyl peroxyacetate	UN3105 ..	≤62	≥38	OP7	
tert-Amyl peroxybenzoate.	UN3103 ..	≤100	OP5	
tert-Amyl peroxy-2-ethylhexanoate.	UN3115 ..	≤100	OP7	+20	+25	
tert-Amyl peroxy-2-ethylhexyl carbonate.	UN3105 ..	≤100	OP7	
tert-Amyl peroxy isopropyl carbonate.	UN3103 ..	≤77	≥23	OP5	
tert-Amyl peroxyneodecanoate.	UN3115 ..	≤77	≥23	OP7	0	+10	
tert-Amyl peroxyneodecanoate.	3119	≤47	≥53	OP8	0	+10	
tert-Amyl peroxyvalerate	UN3113 ..	≤77	≥23	OP5	+10	+15	
tert-Amyl peroxyvalerate	3119	≤32	≥68	OP8	+10	+15	
tert-Amyl peroxy-3,5,5-trimethylhexanoate.	3105	≤100	OP7	
tert-Butyl cumyl peroxide	UN3107 ..	>42-100	OP8	9
tert-Butyl cumyl peroxide	UN3108 ..	≤52	≥48	OP8	9
n-Butyl-4,4-di-(tert-butylperoxy)valerate.	UN3103 ..	>52-100	OP5	
n-Butyl-4,4-di-(tert-butylperoxy)valerate.	UN3108 ..	≤52	≥48	OP8	
tert-Butyl hydroperoxide	UN3103 ..	>79-90	≥10	OP5	13
tert-Butyl hydroperoxide	UN3105 ..	≤80	≥20	OP7	4, 13
tert-Butyl hydroperoxide	UN3107 ..	≤79	>14	OP8	13, 16
tert-Butyl hydroperoxide	UN3109 ..	≤72	≥28	OP8	13
tert-Butyl hydroperoxide [and] Di-tert-butylperoxide.	UN3103 ..	<82+>9	≥7	OP5	13
tert-Butyl monoperoxymaleate.	UN3102 ..	>52-100	OP5	
tert-Butyl monoperoxymaleate.	UN3103 ..	≤52	≥48	OP6	
tert-Butyl monoperoxymaleate.	UN3108 ..	≤52	≥48	OP8	
tert-Butyl monoperoxymaleate [as a paste].	UN3108 ..	≤52	OP8	
tert-Butyl peroxyacetate	UN3101 ..	>52-77	≥23	OP5	
tert-Butyl peroxyacetate	UN3103 ..	>32-52	≥48	OP6	
tert-Butyl peroxyacetate	UN3109 ..	≤32	≥68	OP8	
tert-Butyl peroxybenzoate.	UN3103 ..	>77-100	OP5	
tert-Butyl peroxybenzoate.	UN3105 ..	>52-77	≥23	OP7	1
tert-Butyl peroxybenzoate.	UN3106 ..	≤52	≥48	OP7	
tert-Butyl peroxybenzoate.	3109	≤32	≥68	OP8	
tert-Butyl peroxybutyl fumarate.	UN3105 ..	≤52	≥48	OP7	
tert-Butyl peroxycrotonate.	UN3105 ..	≤77	≥23	OP7	
tert-Butyl peroxydiethylacetate.	UN3113 ..	≤100	OP5	+20	+25	

ORGANIC PEROXIDE TABLE—Continued

Technical name (1)	ID number (2)	Concentration (mass %) (3)	Diluent (mass %)			Water (mass %) (5)	Packing method (6)	Temperature (°C)		Notes (8)
			A (4a)	B (4b)	I (4c)			Control (7a)	Emergency (7b)	
tert-Butyl peroxy-2-ethylhexanoate.	UN3113 ..	>52–100	OP6	+20 ..	+25.	
tert-Butyl peroxy-2-ethylhexanoate.	UN3117 ..	>32–52	≥48	OP8	+30 ..	+35.	
tert-Butyl peroxy-2-ethylhexanoate.	UN3118 ..	≤52	≥48	OP8	+20 ..	+25.	
tert-Butyl peroxy-2-ethylhexanoate.	UN3119 ..	≤32	≥68	OP8	+40 ..	+45.	
tert-Butyl peroxy-2-ethylhexanoate [and] 2,2-di-(tert-Butylperoxy)butane.	UN3106 ..	≤12+≤14	≥14	≥60	OP7.			
tert-Butyl peroxy-2-ethylhexanoate [and] 2,2-di-(tert-Butylperoxy)butane.	UN3115 ..	≤31+≤36	≥33	OP7	+35 ..	+40.	
tert-Butyl peroxy-2-ethylhexylcarbonate.	UN3105 ..	≤100	OP7.			
tert-Butyl peroxyisobutyrate.	UN3111 ..	>52–77	≥23	OP5	+15 ..	+20.	
tert-Butyl peroxyisobutyrate.	UN3115 ..	≤52	≥48	OP7	+15 ..	+20.	
tert-Butylperoxy isopropylcarbonate.	UN3103 ..	≤77	≥23	OP5.			
1-(2-tert-Butylperoxy isopropyl)-3-isopropenylbenzene.	UN3105 ..	≤77	≥23	OP7.			
1-(2-tert-Butylperoxy isopropyl)-3-isopropenylbenzene.	UN3108 ..	≤42	≥58	OP8.			
tert-Butyl peroxy-2-methylbenzoate.	UN3103 ..	≤100	OP5.			
tert-Butyl peroxyneodecanoate.	UN3115 ..	>77–100	OP7	– 5 ...	+5.	
tert-Butyl peroxyneodecanoate.	UN3115 ..	≤77	≥23	OP7	0	+10.	
tert-Butyl peroxyneodecanoate [as a stable dispersion in water].	UN3119 ..	≤52	OP8	0	+10.	
tert-Butyl peroxyneodecanoate [as a stable dispersion in water (frozen)].	UN3118 ..	≤42	OP8	0	+10.	
tert-Butyl peroxyneodecanoate.	UN3119 ..	≤32	≥68	OP8	0	+10.	
tert-Butyl peroxyneohexanoate.	UN3115 ..	≤77	≥23	OP7	0	+10.	
tert-Butyl peroxyneohexanoate [as a stable dispersion in water].	UN3117 ..	≤42	OP8	0	+10.	
tert-Butyl peroxy-pivalate	UN3113 ..	>67–77 ...	≥23	OP5	0	+10.	
tert-Butyl peroxy-pivalate	UN3115 ..	>27–67	≥33	OP7	0	+10.	
tert-Butyl peroxy-pivalate	UN3119 ..	≤27	≥73	OP8	+30 ..	+35.	
tert-Butylperoxy stearylcarbonate.	UN3106 ..	≤100	OP7.			
tert-Butyl peroxy-3,5,5-trimethylhexanoate.	UN3105 ..	>32–100	OP7.			
tert-Butyl peroxy-3,5,5-trimethylhexanoate.	3106	≤42	≥58	OP7.			
tert-Butyl peroxy-3,5,5-trimethylhexanoate.	UN3109 ..	≤32	≥68	OP8.			
3-Chloroperoxybenzoic acid.	UN3102 ..	>57–86	≥14	OP1.			

ORGANIC PEROXIDE TABLE—Continued

Technical name (1)	ID number (2)	Concentration (mass %) (3)	Diluent (mass %)			Water (mass %) (5)	Packing method (6)	Temperature (°C)		Notes (8)
			A (4a)	B (4b)	I (4c)			Control (7a)	Emergency (7b)	
3-Chloroperoxybenzoic acid.	UN3106 ..	≤57	≥3 ...	≥40 ...	OP7.			
3-Chloroperoxybenzoic acid.	UN3106 ..	≤77	≥6 ...	≥17 ...	OP7.			
Cumyl hydroperoxide	UN3107 ..	>90–98 ...	≤10	OP8	13
Cumyl hydroperoxide	UN3109 ..	≤90	≥10	OP8	13, 15
Cumyl peroxyneodecanoate.	3115	≤87	≥13	OP7	–10	0.	
Cumyl peroxyneodecanoate.	UN3115 ..	≤77	≥23	OP7	–10	0.	
Cumyl peroxyneodecanoate [as a stable dispersion in water].	UN3119 ..	≤52	OP8	–10	0.	
Cumyl peroxyneohexanoate.	UN3115 ..	≤77	≥23	OP7	–10	0.	
Cumyl peroxyneopivalate	UN3115 ..	≤77	≥23	OP7	–5 ...	+5.	
Cyclohexanone peroxide(s).	UN3104 ..	≤91	≥9	OP6	13
Cyclohexanone peroxide(s).	UN3105 ..	≤72	≥28	OP7	5
Cyclohexanone peroxide(s) [as a paste].	UN3106 ..	≤72	OP7	5, 21
Cyclohexanone peroxide(s).	Exempt ...	≤32	>68	Exempt	29
Diacetone alcohol peroxides.	UN3115 ..	≤57	≥26	≥8	OP7	+40 ..	+45 ...	5
Diacetyl peroxide	UN3115 ..	≤27	≥73	OP7	+20 ..	+25 ...	8,13
Di-tert-amyl peroxide	UN3107 ..	≤100	OP8.	
([3R- (3R, 5aS, 6S, 8aS, 9R, 10R, 12S, 12aR**)]-Decahydro-10-methoxy-3, 6, 9-trimethyl-3, 12-epoxy-12H-pyrano [4, 3- j]-1, 2-benzodioxepin).	UN3106 ..	≤100	OP7	
2,2-Di-(tert-amylperoxy)-butane.	3105	≤57	≥43	OP7.	
1,1-Di-(tert-amylperoxy)cyclohexane.	UN3103 ..	≤82	≥18	OP6.	
Dibenzoyl peroxide	UN3102 ..	>51–100	≤48	OP2	3
Dibenzoyl peroxide	UN3102 ..	>77–94	≥6	OP4	3
Dibenzoyl peroxide	UN3104 ..	≤77	≥23 ...	OP6.	
Dibenzoyl peroxide	UN3106 ..	≤62	≥28 ...	≥10 ...	OP7.	
Dibenzoyl peroxide [as a paste].	UN3106 ..	>52–62	OP7	21
Dibenzoyl peroxide	UN3106 ..	>35–52	≥48	OP7.	
Dibenzoyl peroxide	UN3107 ..	>36–42 ...	≥18	≤40 ...	OP8.	
Dibenzoyl peroxide [as a paste].	UN3108 ..	≤56.5	≥15 ...	OP8.	
Dibenzoyl peroxide [as a paste].	UN3108 ..	≤52	OP8	21
Dibenzoyl peroxide [as a stable dispersion in water].	UN3109 ..	≤42	OP8.	
Dibenzoyl peroxide	Exempt ...	≤35	≥65	Exempt	29
Di-(4-tert-butylcyclohexyl)peroxydicarbonate.	UN3114 ..	≤100	OP6	+30 ..	+35.	
Di-(4-tert-butylcyclohexyl)peroxydicarbonate [as a stable dispersion in water].	UN3119 ..	≤42	OP8	+30 ..	+35.	
Di-tert-butyl peroxide	UN3107 ..	>52–100	OP8.	
Di-tert-butyl peroxide	UN3109 ..	≤52	≥48	OP8	24

ORGANIC PEROXIDE TABLE—Continued

Technical name (1)	ID number (2)	Concentration (mass %) (3)	Diluent (mass %)			Water (mass %) (5)	Packing method (6)	Temperature (°C)		Notes (8)
			A	B	I			Control (7a)	Emergency (7b)	
			(4a)	(4b)	(4c)					
Di-tert-butyl peroxyazelaate.	UN3105 ..	≤52	≥48	OP7.			
2,2-Di-(tert-butylperoxy)butane.	UN3103 ..	≤52	≥48	OP6.			
1,6-Di-(tert-butylperoxycarbonyloxy)hexane.	UN3103 ..	≤72	≥28	OP5.			
1,1-Di-(tert-butylperoxy)cyclohexane.	UN3101 ..	>80–100	OP5.			
1,1-Di-(tert-butylperoxy)cyclohexane.	UN3103 ..	>52–80 ...	≥20	OP5.			
1,1-Di-(tert-butylperoxy)-cyclohexane.	3103	≤72	≥28	OP5	30
1,1-Di-(tert-butylperoxy)cyclohexane.	UN3105 ..	>42–52 ...	≥48	OP7.			
1,1-Di-(tert-butylperoxy)cyclohexane.	UN3106 ..	≤42	≥13	≥45	OP7.			
1,1-Di-(tert-butylperoxy)cyclohexane.	UN3107 ..	≤27	≥25	OP8	22
1,1-Di-(tert-butylperoxy)cyclohexane.	UN3109 ..	≤42	≥58	OP8.			
1,1-Di-(tert-Butylperoxy)cyclohexane.	3109	≤37	≥63	OP8.			
1,1-Di-(tert-butylperoxy)cyclohexane.	UN3109 ..	≤25	≥25	≥50	OP8.			
1,1-Di-(tert-butylperoxy)cyclohexane.	UN3109 ..	≤13	≥13	≥74	OP8.			
Di-n-butyl peroxydicarbonate.	UN3115 ..	>27–52	≥48	OP7	– 15	– 5.	
Di-n-butyl peroxydicarbonate.	UN3117 ..	≤27	≥73	OP8	– 10	0.	
Di-n-butyl peroxydicarbonate [as a stable dispersion in water (frozen)].	UN3118 ..	≤42	OP8	– 15	– 5.	
Di-sec-butyl peroxydicarbonate.	UN3113 ..	>52–100	OP4	– 20	– 10 ..	6
Di-sec-butyl peroxydicarbonate.	UN3115 ..	≤52	≥48	OP7	– 15	– 5.	
Di-(tert-butylperoxyisopropyl)benzene(s).	UN3106 ..	>42–100	≤57	OP7	1, 9
Di-(tert-butylperoxyisopropyl)benzene(s).	Exempt ...	≤42	≥58	Exempt.			
Di-(tert-butylperoxy)phthalate.	UN3105 ..	>42–52 ...	≥48	OP7.			
Di-(tert-butylperoxy)phthalate [as a paste].	UN3106 ..	≤52	OP7	21
Di-(tert-butylperoxy)phthalate.	UN3107 ..	≤42	≥58	OP8.			
2,2-Di-(tert-butylperoxy)propane.	UN3105 ..	≤52	≥48	OP7.			
2,2-Di-(tert-butylperoxy)propane.	UN3106 ..	≤42	≥13	≥45	OP7.			

ORGANIC PEROXIDE TABLE—Continued

Technical name (1)	ID number (2)	Concentration (mass %) (3)	Diluent (mass %)			Water (mass %) (5)	Packing method (6)	Temperature (°C)		Notes (8)
			A (4a)	B (4b)	I (4c)			Control (7a)	Emergency (7b)	
1,1-Di-(tert-butylperoxy)-3,3,5-trimethylcyclohexane.	UN3101 ..	>90–100	OP5.			
1,1-Di-(tert-butylperoxy)-3,3,5-trimethylcyclohexane.	UN3103 ..	>57–90	≥10	OP5.			
1,1-Di-(tert-butylperoxy)-3,3,5-trimethylcyclohexane.	UN3103 ..	≤77	≥23	OP5.			
1,1-Di-(tert-butylperoxy)-3,3,5-trimethylcyclohexane.	UN3103 ..	≤90	≥10	OP5	30
1,1-Di-(tert-butylperoxy)-3,3,5-trimethylcyclohexane.	UN3110 ..	≤57	≥43	OP8.			
1,1-Di-(tert-butylperoxy)-3,3,5-trimethylcyclohexane.	UN3107 ..	≤57	≥43	OP8.			
1,1-Di-(tert-butylperoxy)-3,3,5-trimethylcyclohexane.	UN3107 ..	≤32	≥26	≥42	OP8.			
Dicetyl peroxydicarbonate.	UN3116 ..	≤100	OP7	+30	+35.	
Dicetyl peroxydicarbonate [as a stable dispersion in water].	UN3119 ..	≤42	OP8	+30	+35.	
Di-4-chlorobenzoyl peroxide.	UN3102 ..	≤77	≥23	OP5.			
Di-4-chlorobenzoyl peroxide.	Exempt	≤32	≥68	Exempt			29
Di-2,4-dichlorobenzoyl peroxide [as a paste].	UN3118 ..	≤52	OP8	+20	+25.		
Di-4-chlorobenzoyl peroxide [as a paste].	UN3106 ..	≤52	OP7			21
Dicumyl peroxide	UN3110 ..	>52–100	≤48	OP8			9
Dicumyl peroxide	Exempt	≤52	≥48	Exempt			29
Dicyclohexyl peroxydicarbonate.	UN3112 ..	>91–100	OP3	+10	+15.	
Dicyclohexyl peroxydicarbonate.	UN3114 ..	≤91	≥9	OP5	+10	+15.	
Dicyclohexyl peroxydicarbonate [as a stable dispersion in water].	UN3119 ..	≤42	OP8	+15	+20.	
Didecanoyl peroxide	UN3114 ..	≤100	OP6	+30	+35.	
2,2-Di-(4,4-di(tert-butylperoxy)cyclohexyl)propane.	UN3106 ..	≤42	≥58	OP7.			
2,2-Di-(4,4-di(tert-butylperoxy)cyclohexyl)propane.	UN3107 ..	≤22	≥78	OP8.			
Di-2,4-dichlorobenzoyl peroxide.	UN3102 ..	≤77	≥23	OP5.			
Di-2,4-dichlorobenzoyl peroxide [as a paste with silicone oil].	UN3106 ..	≤52	OP7.			
Di-(2-ethoxyethyl) peroxydicarbonate.	UN3115 ..	≤52	≥48	OP7	-10	0.	
Di-(2-ethylhexyl) peroxydicarbonate.	UN3113 ..	>77–100	OP5	-20	-10.	
Di-(2-ethylhexyl) peroxydicarbonate.	UN3115 ..	≤77	≥23	OP7	-15	-5.	

ORGANIC PEROXIDE TABLE—Continued

Technical name (1)	ID number (2)	Concentration (mass %) (3)	Diluent (mass %)			Water (mass %) (5)	Packing method (6)	Temperature (°C)		Notes (8)
			A (4a)	B (4b)	I (4c)			Control (7a)	Emergency (7b)	
Di-(2-ethylhexyl) peroxydicarbonate [as a stable dispersion in water].	3119	≤62	OP8	-15	-5.	
Di-(2-ethylhexyl) peroxydicarbonate [as a stable dispersion in water].	UN3119 ..	≤52	OP8	-15	-5.	
Di-(2-ethylhexyl) peroxydicarbonate [as a stable dispersion in water (frozen)].	UN3120 ..	≤52	OP8	-15	-5.	
2,2-Dihydroperoxypropane.	UN3102 ..	≤27	≥73	OP5.			
Di-(1-hydroxycyclohexyl)peroxide.	UN3106 ..	≤100	OP7.			
Diisobutyl peroxide	UN3111 ..	>32–52	≥48	OP5	-20	-10.	
Diisobutyl peroxide	UN3115 ..	≤32	≥68	OP7	-20	-10.	
Diisopropylbenzene dihydroperoxide.	UN3106 ..	≤82	≥5	≥5	OP7			17
Diisopropyl peroxydicarbonate.	UN3112 ..	>52–100	OP2	-15	-5.	
Diisopropyl peroxydicarbonate.	UN3115 ..	≤52	≥48	OP7	-20	-10.	
Diisopropyl peroxydicarbonate.	UN3115 ..	≤32	≥68	OP7	-15	-5.	
Dilauroyl peroxide	UN3106 ..	≤100	OP7.			
Dilauroyl peroxide [as a stable dispersion in water].	UN3109 ..	≤42	OP8.			
Di-(3-methoxybutyl) peroxydicarbonate.	UN3115 ..	≤52	≥48	OP7	-5	+5.	
Di-(2-methylbenzoyl)peroxide.	UN3112 ..	≤87	≥13 ...	OP5	+30	+35.	
Di-(4-methylbenzoyl)peroxide [as a paste with silicone oil].	UN3106 ..	≤52	OP7.			
Di-(3-methylbenzoyl) peroxide + Benzoyl (3-methylbenzoyl) peroxide + Dibenzoyl peroxide.	UN3115 ..	≤20+	≥58	OP7	+35	+40.	
2,5-Dimethyl-2,5-di-(benzoylperoxy)hexane.	UN3102 ..	>82–100	OP5.			
2,5-Dimethyl-2,5-di-(benzoylperoxy)hexane.	UN3106 ..	≤82	≥18	OP7.			
2,5-Dimethyl-2,5-di-(benzoylperoxy)hexane.	UN3104 ..	≤82	≥18 ...	OP5.			
2,5-Dimethyl-2,5-di-(tert-butylperoxy)hexane.	UN3103 ..	>90–100	OP5.			
2,5-Dimethyl-2,5-di-(tert-butylperoxy)hexane.	UN3105 ..	>52–90	≥10	OP7.			
2,5-Dimethyl-2,5-di-(tert-butylperoxy)hexane.	UN3108 ..	≤77	≥23	OP8.			
2,5-Dimethyl-2,5-di-(tert-butylperoxy)hexane.	UN3109 ..	≤52	≥48	OP8.			
2,5-Dimethyl-2,5-di-(tert-butylperoxy)hexane [as a paste].	UN3108 ..	≤47	OP8.			

ORGANIC PEROXIDE TABLE—Continued

Technical name (1)	ID number (2)	Concentration (mass %) (3)	Diluent (mass %)			Water (mass %) (5)	Packing method (6)	Temperature (°C)		Notes (8)
			A (4a)	B (4b)	I (4c)			Control (7a)	Emergency (7b)	
2,5-Dimethyl-2,5-di-(tert-butylperoxy)hexyne-3.	UN3101 ..	>86–100	OP5.			
2,5-Dimethyl-2,5-di-(tert-butylperoxy)hexyne-3.	UN3103 ..	>52–86	≥14	OP5.			
2,5-Dimethyl-2,5-di-(tert-butylperoxy)hexyne-3.	UN3106 ..	≤52	≥48	OP7.			
2,5-Dimethyl-2,5-di-(2-ethylhexanoylperoxy)hexane.	UN3113 ..	≤100	OP5	+20	+25.	
2,5-Dimethyl-2,5-dihydroperoxyhexane.	UN3104 ..	≤82	≥18	OP6.			
2,5-Dimethyl-2,5-di-(3,5,5-trimethylhexanoylperoxy)hexane.	UN3105 ..	≤77	≥23	OP7.			
1,1-Dimethyl-3-hydroxybutylperoxyne-oheptanoate.	UN3117 ..	≤52	≥48	OP8	0	+10.	
Dimyristyl peroxydicarbonate.	UN3116 ..	≤100	OP7	+20	+25.	
Dimyristyl peroxydicarbonate [as a stable dispersion in water].	UN3119 ..	≤42	OP8	+20	+25.	
Di-(2-neodecanoylperoxyisopropyl)benzene.	UN3115 ..	≤52	≥48	OP7	–10	0.	
Di-(2-neodecanoylperoxyisopropyl) benzene, as stable dispersion in water.	3119 ..	≤42	OP8	–15	–5.	
Di-n-nonanoyl peroxide ..	UN3116 ..	≤100	OP7	0	+10.	
Di-n-octanoyl peroxide ...	UN3114 ..	≤100	OP5	+10	+15.	
Di-(2-phenoxyethyl)peroxydicarbonate.	UN3102 ..	>85–100	OP5.			
Di-(2-phenoxyethyl)peroxydicarbonate.	UN3106 ..	≤85	≥15	OP7.			
Dipropionyl peroxide	UN3117 ..	≤27	≥73	OP8	+15	+20.	
Di-n-propyl peroxydicarbonate.	UN3113 ..	≤100	OP3	–25	–15.	
Di-n-propyl peroxydicarbonate.	UN3113 ..	≤77	≥23	OP5	–20	–10.	
Disuccinic acid peroxide	UN3102 ..	>72–100	OP4	18
Disuccinic acid peroxide	UN3116 ..	≤72	≥28	OP7	+10	+15.	
Di-(3,5,5-trimethylhexanoyl) peroxide.	UN3115 ..	>52–82	≥18	OP7	0	+10.	
Di-(3,5,5-trimethylhexanoyl)peroxide [as a stable dispersion in water].	UN3119 ..	≤52	OP8	+10	+15.	
Di-(3,5,5-trimethylhexanoyl)peroxide.	UN3119 ..	≤38	≥62	OP8	+20	+25.	
Ethyl 3,3-di-(tert-amyperoxy)butyrate.	UN3105 ..	≤67	≥33	OP7.			
Ethyl 3,3-di-(tert-butylperoxy)butyrate.	UN3103 ..	>77–100	OP5.			
Ethyl 3,3-di-(tert-butylperoxy)butyrate.	UN3105 ..	≤77	≥23	OP7.			
Ethyl 3,3-di-(tert-butylperoxy)butyrate.	UN3106 ..	≤52	≥48	OP7.			

ORGANIC PEROXIDE TABLE—Continued

Technical name (1)	ID number (2)	Concentration (mass %) (3)	Diluent (mass %)			Water (mass %) (5)	Packing method (6)	Temperature (°C)		Notes (8)
			A (4a)	B (4b)	I (4c)			Control (7a)	Emergency (7b)	
1-(2-ethylhexanoylperoxy)-1,3-Dimethylbutyl peroxy-pivalate.	UN3115 ..	≤52	≥45	≥10	OP7	-20	-10.	
tert-Hexyl peroxyneodecanoate.	UN3115 ..	≤71	≥29	OP7	0	+10.	
tert-Hexyl peroxy-pivalate	UN3115 ..	≤72	≥28	OP7	+10 ..	+15.	
3-Hydroxy-1,1-dimethylbutyl peroxyneodecanoate.	3115	≤77	≥23	OP7	-5 ...	+5.	
3-Hydroxy-1,1-dimethylbutyl peroxyneodecanoate [as a stable dispersion in water].	3119	≤52	OP8	-5 ...	+5.	
3-Hydroxy-1,1-dimethylbutyl peroxyneodecanoate.	3117	≤52	≥48	OP8	-5 ...	+5.	
Isopropyl sec-butyl peroxydicarbonat +Di-sec-butyl peroxydicarbonate+Di-isopropyl peroxydicarbonate.	UN3111 ..	≤52+≤28 +≤22	OP5	-20	-10.	
Isopropyl sec-butyl peroxydicarbonate+Di-sec-butyl peroxydicarbonate+Di-isopropyl peroxydicarbonate.	UN3115 ..	≤32+≤15 -18	≥38	OP7	-20	-10.	
Isopropylcumyl hydroperoxide.	UN3109 ..	≤72	≥28	OP8	13
p-Menthyl hydroperoxide	UN3105 ..	>72–100	OP7	13
p-Menthyl hydroperoxide	UN3109 ..	≤72	≥28	OP8.	
Methylcyclohexanone peroxide(s).	UN3115 ..	≤67	≥33	OP7	+35 ..	+40.	
Methyl ethyl ketone peroxide(s).	UN3101 ..	≤52	≥48	OP5	5, 13
Methyl ethyl ketone peroxide(s).	UN3105 ..	≤45	≥55	OP7	5
Methyl ethyl ketone peroxide(s).	UN3107 ..	≤40	≥60	OP8	7
Methyl isobutyl ketone peroxide(s).	UN3105 ..	≤62	≥19	OP7	5, 23
Methyl isopropyl ketone peroxide(s).	3109	(See remark 31).	≥70	OP8	31
Organic peroxide, liquid, sample.	UN3103	OP2	12
Organic peroxide, liquid, sample, temperature controlled.	UN3113	OP2	12
Organic peroxide, solid, sample.	UN3104	OP2	12
Organic peroxide, solid, sample, temperature controlled.	UN3114	OP2	12
3,3,5,7,7-Pentamethyl-1,2,4-Trioxepane.	3107	≤100	OP8.	
Peroxyacetic acid, type D, stabilized.	UN3105 ..	≤43	OP7	13, 20
Peroxyacetic acid, type E, stabilized.	UN3107 ..	≤43	OP8	13, 20
Peroxyacetic acid, type F, stabilized.	UN3109 ..	≤43	OP8	13, 20, 28

ORGANIC PEROXIDE TABLE—Continued

Technical name (1)	ID number (2)	Concentration (mass %) (3)	Diluent (mass %)			Water (mass %) (5)	Packing method (6)	Temperature (°C)		Notes (8)
			A (4a)	B (4b)	I (4c)			Control (7a)	Emergency (7b)	
Peroxyacetic acid or peracetic acid [with not more than 7% hydrogen peroxide].	UN3107 ..	≤36	≥15 ...	OP8	13, 20, 28
Peroxyacetic acid or peracetic acid [with not more than 20% hydrogen peroxide].	Exempt ...	≤6	≥60 ...	Exempt	28
Peroxyacetic acid or peracetic acid [with not more than 26% hydrogen peroxide].	UN3109 ..	≤17	OP8	13, 20, 28
Peroxy lauric acid	UN3118 ..	≤100	OP8	+35 ..	+40.	13
Pinanyl hydroperoxide ...	UN3105 ..	>56–100	OP7	
Pinanyl hydroperoxide ...	UN3109 ..	≤56	≥44	OP8.	
Polyether poly-tert-butylperoxycarbonate.	UN3107 ..	≤52	≥48	OP8.	
Tetrahydronaphthyl hydroperoxide.	UN3106 ..	≤100	OP7.	
1,1,3,3-Tetramethylbutyl hydroperoxide.	UN3105 ..	≤100	OP7.	26
1,1,3,3-Tetramethylbutyl peroxy-2-ethylhexanoate.	UN3115 ..	≤100	OP7	+15 ..	+20.	
1,1,3,3-Tetramethylbutyl peroxyneodecanoate.	UN3115 ..	≤72	≥28	OP7	-5	+5.	
1,1,3,3-Tetramethylbutyl peroxyneodecanoate [as a stable dispersion in water].	UN3119 ..	≤52	OP8	-5 ...	+5.	
1,1,3,3-tetramethylbutyl peroxy-pivalate.	UN3115 ..	≤77	≥23	OP7	0	+10.	
3, 6, 9-Triethyl-3, 6, 9-trimethyl-1, 4, 7-triperoxonane.	UN3110 ..	≤17	≥18	≥65 ...	OP8	26
3,6,9-Triethyl-3,6,9-trimethyl-1,4,7-triperoxonane.	UN3105 ..	≤42	≥58	OP7	
Di-(3, 5, 5-trimethylhexanoyl) peroxide.	UN3119 ..	>38–52 ...	≥48	OP8	+10 ..	+15.	

NOTES

1. For domestic shipments, OP8 is authorized.
2. Available oxygen must be <4.7%.
3. For concentrations <80% OP5 is allowed. For concentrations of at least 80% but <85%, OP4 is allowed. For concentrations of at least 85%, maximum package size is OP2.
4. The diluent may be replaced by di-tert-butyl peroxide.
5. Available oxygen must be ≤9% with or without water.
6. For domestic shipments, OP5 is authorized.
7. Available oxygen must be ≤8.2% with or without water.
8. Only non-metallic packagings are authorized.

9. For domestic shipments this material maybe transported under the provisions of paragraph (h)(3)(xii) of this section.
10. [Reserved]
11. [Reserved]
12. Samples may only be offered for transportation under the provisions of paragraph (b)(2) of this section.
13. "Corrosive" subsidiary risk label is required.
14. [Reserved]
15. No "Corrosive" subsidiary risk label is required for concentrations below 80%.
16. With <6% di-tert-butyl peroxide.
17. With ≤8% 1-isopropylhydroperoxy-4-isopropylhydroxybenzene.
18. Addition of water to this organic peroxide will decrease its thermal stability.
19. [Reserved]

§ 173.225

49 CFR Ch. I (10–1–14 Edition)

- 20. Mixtures with hydrogen peroxide, water and acid(s).
- 21. With diluent type A, with or without water.
- 22. With ≥36% diluent type A by mass, and in addition ethylbenzene.
- 23. With ≥19% diluent type A by mass, and in addition methyl isobutyl ketone.
- 24. Diluent type B with boiling point >100 C.
- 25. No “Corrosive” subsidiary risk label is required for concentrations below 56%.
- 26. Available oxygen must be ≤7.6%.
- 27. Formulations derived from distillation of peroxyacetic acid originating from peroxyacetic acid in a concentration of not more than 41% with water, total active oxygen less than or equal to 9.5% (peroxyacetic acid plus hydrogen peroxide).
- 28. For the purposes of this section, the names “Peroxyacetic acid” and “Peracetic acid” are synonymous.
- 29. Not subject to the requirements of this subchapter for Division 5.2.
- 30. Diluent type B with boiling point >130 °C (266 °F).
- 31. Available oxygen ≤6.7%.

(d) *Packing Method Table*. Packagings for organic peroxides and self-reactive substances are listed in the Maximum Quantity per Packing Method Table.

The packing methods are designated OP1 to OP8. The quantities specified for each packing method represent the maximum that is authorized.

- (1) The following types of packagings are authorized:
 - (i) Drums: 1A1, 1A2, 1B1, 1B2, 1D, 1G, 1H1, 1H2;
 - (ii) Jerricans: 3A1, 3A2, 3B1, 3B2, 3H1, 3H2;
 - (iii) Boxes: 4C1, 4C2, 4D, 4F, 4G, 4H1, 4H2, 4A, 4B; or
 - (iv) Composite packagings with a plastic inner receptacle: 6HA1, 6HA2, 6HB1, 6HB2, 6HC, 6HD1, 6HD2, 6HG1, 6HG2, 6HH1, 6HH2.
- (2) Metal packaging (including inner packagings of combination packagings and outer packagings of combination or composite packagings) are used only for packing methods OP7 and OP8.
- (3) In combination packagings, glass receptacles are used only as inner packagings with a maximum content of 0.5 kg for solids or 0.5 L for liquids.
- (4) The maximum quantity per packaging or package for Packing Methods OP1–OP8 must be as follows:

MAXIMUM QUANTITY PER PACKAGING/PACKAGE
[For Packing Methods OP1 to OP8]

Maximum quantity	Packing Method							
	OP1	OP2	OP3	OP4 ¹	OP5	OP6	OP7	OP8
Solids and combination packagings (liquid and solid) (kg)	0.5	0.5/10	5	5	25	50	50	² 400
Liquids (L)	0.5		5		30	60	60	³ 225

¹ If two values are given, the first applies to the maximum net mass per inner packaging and the second to the maximum net mass of the complete package.
² 60 kg for jerricans/200 kg for boxes and, for solids, 400 kg in combination packagings with outer packagings comprising boxes (4C1, 4C2, 4D, 4F, 4G, 4H1, and 4H2) and with inner packagings of plastics or fiber with a maximum net mass of 25 kg.
³ 60 L for jerricans.

(e) *Organic Peroxide IBC Table*. The following Organic Peroxide IBC Table specifies, by technical name, those organic peroxides that are authorized for transportation in certain IBCs and not

subject to the approval provisions of §173.128 of this part. Additional requirements for authorized IBCs are found in paragraph (f) of this section.

ORGANIC PEROXIDE IBC TABLE

UN No.	Organic peroxide	Type of IBC	Maximum quantity (litres)	Control temperature	Emergency temperature
3109	ORGANIC PEROXIDE, TYPE F, LIQUID.				
	tert-Butyl hydroperoxide, not more than 72% with water.	31A	1250		
	tert-Butyl peroxyacetate, not more than 32% in diluent type A.	31A	1250		
		31HA1	1000		

ORGANIC PEROXIDE IBC TABLE—Continued

UN No.	Organic peroxide	Type of IBC	Maximum quantity (litres)	Control temperature	Emergency temperature
	tert-Butyl peroxybenzoate, not more than 32% in diluent type A.	31A	1250		
	tert-Butyl peroxy-3,5,5-trimethylhexanoate, not more than 37% in diluent type A.	31A	1250		
	Cumyl hydroperoxide, not more than 90% in diluent type A.	31HA1	1000		
	Dibenzoyl peroxide, not more than 42% as a stable dispersion.	31HA1	1250		
	Di-tert-butyl peroxide, not more than 52% in diluent type B.	31H1	1000		
	1,1-Di-(tert-Butylperoxy) cyclohexane, not more than 37% in diluent type A.	31A	1250		
	1,1-Di-(tert-butylperoxy) cyclohexane, not more than 42% in diluent type A.	31H1	1000		
	Dicumyl peroxide, less than or equal to 100%.	31A	1250		
	Dilauroyl peroxide, not more than 42%, stable dispersion, in water.	31HA1	1000		
	Isopropyl cumyl hydroperoxide, not more than 72% in diluent type A.	31HA1	1000		
	p-Menthyl hydroperoxide, not more than 72% in diluent type A.	31HA1	1250		
	Peroxyacetic acid, stabilized, not more than 17%.	31A	1500		
		31H1	1500		
		31H2	1500		
		31HA1	1500		
	Peroxyacetic acid, with not more than 26% hydrogen peroxide.	31A	1500		
	Peroxyacetic acid, type F, stabilized.	31HA1	1500		
		31A	1500		
3110	ORGANIC PEROXIDE TYPE F, SOLID.	31HA1	1500		
	Dicumyl peroxide, less than or equal to 100%.	31A	2000		
		31H1			
3119	ORGANIC PEROXIDE, TYPE F, LIQUID, TEMPERATURE CONTROLLED.	31HA1			
	tert-Amyl peroxyvalate, not more than 32% in diluent type A.	31A	1250	+10 °C	+15 °C
	tert-Butyl peroxy-2-ethylhexanoate, not more than 32% in diluent type B.	31HA1	1000	+30 °C	+35 °C
		31A	1250	+30 °C	+35 °C
	tert-Butyl peroxyneodecanoate, not more than 32% in diluent type A.	31A	1250	0 °C	+10 °C
	tert-Butyl peroxyneodecanoate, not more than 52%, stable dispersion, in water.	31A	1250	-5 °C	+5 °C
	tert-Butyl peroxyvalate, not more than 27% in diluent type B.	31HA1	1000	+10 °C	+15 °C
		31A	1250	+10 °C	+15 °C

ORGANIC PEROXIDE IBC TABLE—Continued

UN No.	Organic peroxide	Type of IBC	Maximum quantity (litres)	Control temperature	Emergency temperature
	Di-(4-tert-butylcyclohexyl) peroxydicarbonate, not more than 42%, stable dispersion, in water.	31HA1	1000	+30 °C	+35 °C
	Dicetyl peroxydicarbonate, not more than 42%, stable dispersion, in water.	31HA1	1000	+30 °C	+35 °C
	Dicyclohexylperoxydicarbonate, not more than 42% as a stable dispersion, in water.	31A	1250	+10 °C	+15 °C
	Di-(2-ethylhexyl) peroxydicarbonate, not more than 62%, stable dispersion, in water.	31A	1250	–20 °C	–10 °C
	Diisobutyl peroxide, not more than 28% as a stable dispersion in water.	31HA1	1000	–20 °C	–10 °C
	Diisobutyl peroxide, not more than 42% as a stable dispersion in water.	31A	1250	–20 °C	–10 °C
		31HA1	1000	–25 °C	–15 °C
	Dimyristyl peroxydicarbonate, not more than 42%, stable dispersion, in water.	31A	1250	–25 °C	–15 °C
		31HA1	1000	+15 °C	+20 °C
	Di-(2-neodecanoylperoxyisopropyl) benzene, not more than 42%, stable dispersion, in water.	31A	1250	–15 °C	–5 °C
	Di-(3,5,5-trimethylhexanoyl) peroxide, not more than 52% in diluent type A.	31HA1	1000	+10 °C	+15 °C
		31A	1250	+10 °C	+15 °C
	Di-(3,5,5-trimethylhexanoyl) peroxide, not more than 52%, stable dispersion, in water.	31A	1250	+10 °C	+15 °C
		31A	1250	+10 °C	+15 °C
	3-Hydroxy-1,1-dimethylbutyl peroxy-neodecanoate, not more than 52%, stable dispersion, in water.	31A	1250	–15 °C	–5 °C
	1,1,3,3-Tetramethylbutyl peroxyneodecanoate, not more than 52%, stable dispersion, in water.	31A	1250	–5 °C	+5 °C
		31HA1	1000	–5 °C	+5 °C

(f) *IBCs*. IBCs are authorized subject to the conditions and limitations of this section if the IBC type is authorized according to paragraph (e) of this section, as applicable, and the IBC conforms to the requirements in subpart O of part 178 of this subchapter at the Packing Group II performance level. Type F organic peroxides or self-reactive substances are not authorized for transportation in IBCs other than those specified, unless approved by the Associate Administrator.

(1) IBCs shall be provided with a device to allow venting during transportation. The inlet to the pressure relief

device shall be sited in the vapor space of the IBC under maximum filling conditions during transportation.

(2) To prevent explosive rupture of metal IBCs or composite IBCs with a complete metal casing, the emergency-relief devices shall be designed to vent all the decomposition products and vapors evolved during self-accelerating decomposition or during a period of not less than one hour of complete fire-engulfment as calculated by the formula in paragraph (h)(3)(v) of this section. The control and emergency temperatures specified in the Organic Peroxide

Pipeline and Haz. Matls. Safety Admin., DOT

§ 173.225

IBC Table are based on a non-insulated IBC.

(g) *Organic Peroxide Portable Tank Table*. The following Organic Peroxide Portable Tank Table provides certain portable tank requirements and identifies, by technical name, those organic peroxides that are authorized for trans-

portation in the bulk packagings listed in paragraph (h). Organic peroxides listed in this table, provided they meet the specific packaging requirements found in paragraph (h), are not subject to the approval provisions of §173.128 of this part.

ORGANIC PEROXIDE PORTABLE TANK TABLE

UN No.	Hazardous material	Minimum test pressure (bar)	Minimum shell thickness (mm-reference steel) See. . .	Bottom opening requirements See. . .	Pressure-relief requirements See. . .	Filling limits	Control temperature	Emergency temperature
3109	ORGANIC PEROXIDE, TYPE F, LIQUID. tert-Butyl hydroperoxide, not more than 72% with water. *Provided that steps have been taken to achieve the safety equivalence of 65% tert-Butyl hydroperoxide and 35% water. Cumyl hydro-peroxide, not more than 90% in diluent type A. Di-tert-butyl peroxide, not more than 32% in diluent type A. Dicumyl peroxide, less than or equal to 100% in diluent type B.	4	§ 178.274(d)(2)	§ 178.275(d)(3)	§ 178.275(g)(1)	Not more than 90% at 59 °F (15 °C)		
		4	§ 178.274(d)(2)	§ 178.275(d)(3)	§ 178.275(g)(1)	Not more than 90% at 59 °F (15 °C)		
		4	§ 178.274(d)(2)	§ 178.275(d)(3)	§ 178.275(g)(1)	Not more than 90% at 59 °F (15 °C)		
		4	§ 178.274(d)(2)	§ 178.275(d)(3)	§ 178.275(g)(1)	Not more than 90% at 59 °F (15 °C)		
	Isopropyl cumyl hydro-peroxide, not more than 72% in diluent type A.	4	§ 178.274(d)(2)	§ 178.275(d)(3)	§ 178.275(g)(1)	Not more than 90% at 59 °F (15 °C)		
	p-Menthyl hydro-peroxide, not more than 72% in diluent type A.	4	§ 178.274(d)(2)	§ 178.275(d)(3)	§ 178.275(g)(1)	Not more than 90% at 59 °F (15 °C)		
3110	Pinanyl hydro-peroxide, not more than 56% in diluent type A. ORGANIC PEROXIDE, TYPE F, SOLID. Dicumyl peroxide less than or equal to 100% with inert solids. *Maximum quantity per portable tank 2,000 kg.	4	§ 178.274(d)(2)	§ 178.275(d)(3)	§ 178.275(g)(1)	Not more than 90% at 59 °F (15 °C)		
3119	ORGANIC PEROXIDE, TYPE F, LIQUID. TEMPERATURE CONTROLLED. tert-Amyl peroxyneodecanoate, not more than 47% in diluent type A. tert-Butyl peroxyacetate, not more than 32% in diluent type B. tert-Butyl peroxy-2-ethylhexanoate, not more than 32% in diluent B.	4	§ 178.274(d)(2)	§ 178.275(d)(3)	§ 178.275(g)(1)	Not more than 90% at 59 °F (15 °C)	– 10 °C	– 5 °C.
		4	§ 178.274(d)(2)	§ 178.275(d)(3)	§ 178.275(g)(1)	Not more than 90% at 59 °F (15 °C)	+30 °C	+35 °C
		4	§ 178.274(d)(2)	§ 178.275(d)(3)	§ 178.275(g)(1)	Not more than 90% at 59 °F (15 °C)	+15 °C	+20 °C

<p>tert-Butylperoxyvalate, not more than 27% in diluent type B.</p>	<p>4</p>	<p>§ 178.274(d)(2)</p>	<p>§ 178.275(d)(3)</p>	<p>§ 178.275(g)(1)</p>	<p>Not more than 90% at 59 °F (15 °C)</p>	<p>+5 °C</p>	<p>+10 °C</p>
<p>tert-Butyl peroxy-3,5,5-trimethylhexanoate, not more than 32% in diluent type B.</p>	<p>4</p>	<p>§ 178.274(d)(2)</p>	<p>§ 178.275(d)(3)</p>	<p>§ 178.275(g)(1)</p>	<p>Not more than 90% at 59 °F (15 °C)</p>	<p>+35 °C</p>	<p>+40 °C</p>
<p>Di-(3,5,5-trimethylhexanoyl) peroxide, not more than 38% in diluent type A or type B.</p>	<p>4</p>	<p>§ 178.274 (d)(2)</p>	<p>§ 178.275 (d)(3)</p>	<p>§ 178.275 (g)(1)</p>	<p>Not more than 90% at 59 °F (15 °C)</p>	<p>0 °C</p>	<p>+5 °C.</p>
<p>Peroxyacetic acid, distilled, stabilized, not more than 41%.</p>	<p>4</p>	<p>§ 178.274(d)(2)</p>	<p>§ 178.275(d)(3)</p>	<p>§ 178.275(g)(1)</p>	<p>Not more than 90% at 59 °F (15 °C)</p>	<p>+30 °C</p>	<p>+35 °C</p>

(h) *Bulk packagings other than IBCs.* The following bulk packagings are authorized, subject to the conditions and limitations of this section, if the organic peroxide is listed in the Organic Peroxide Portable Tank Table and bulk packagings are authorized, or if the organic peroxide is specifically authorized for transport in a bulk packaging by this paragraph (h), and the bulk packaging conforms to the requirements of this subchapter:

(1) *Rail cars.* Class DOT 103, 104, 105, 109, 111, 112, 114, 115, or 120 fusion-weld tank car tanks are authorized. DOT 103W, 111A60F1 and 111A60W1 tank car tanks must have bottom outlets effectively sealed from inside. Gauging devices are required on DOT 103W tank car tanks. Riveted tank car tanks are not authorized.

(2) *Cargo tanks.* Specification MC 307, MC 310, MC 311, MC 312, DOT 407, and DOT 412 cargo tank motor vehicles with a tank design pressure of at least 172 kPa (25 psig) are authorized.

(3) *Portable tanks.* The following requirements apply to portable tanks intended for the transport of organic peroxides or self-reactive substances. DOT 51, 57, IM 101 portable tanks, and UN portable tanks that conform to the requirements of paragraph (g) of this section, are authorized. Type F organic peroxide or self-reactive substance formulations other than those indicated in the Organic Peroxide Portable Tank Table may be transported in portable tanks if approved by the Associate Administrator. The following conditions also apply:

(i) The portable tank must be designed for a test pressure of at least 0.4 MPa (4 bar).

(ii) The portable tank must be fitted with temperature-sensing devices.

(iii) The portable tank must be fitted with pressure relief devices and emergency-relief devices. Vacuum-relief devices may also be used. Pressure relief devices must operate at pressures determined according to both the properties of the hazardous material and the construction characteristics of the portable tank. Fusible elements are not allowed in the shell.

(iv) The pressure relief devices must consist of reclosing devices fitted to prevent significant build-up within the

portable tank of the decomposition products and vapors released at a temperature of 50 °C (122 °F). The capacity and start-to-discharge pressure of the relief devices must be in accordance with the applicable requirements of this subchapter specified for the portable tank. The pressure relief devices must not allow liquid to escape in the event the portable tank is overturned in a loaded condition.

(v)(A) The emergency-relief devices may be of the reclosing or frangible types, or a combination of the two, designed to vent all the decomposition products and vapors evolved during a period of not less than one hour of complete fire engulfment as calculated by the following formula:

$$q = 70961 F A^{0.82}$$

Where:

q = heat absorption (W)

A = wetted area (m²)

F = insulation factor (–)

(B) Insulation factor (F) in the formula in paragraph (h)(3)(v)(A) of this section equals 1 for non-insulated vessels and for insulated vessels F is calculated using the following formula:

$$F = \frac{U(923 - T_{PO})}{47032}$$

Where:

U = K/L = heat transfer coefficient of the insulation (W·m⁻²·K⁻¹); where K = heat conductivity of insulation layer (W·m⁻¹·K⁻¹), and L = thickness of insulation layer (m).

T_{PO} = temperature of material at relieving conditions (K).

(vi) The start-to-discharge pressure of emergency-relief devices must be higher than that specified for the pressure relief devices in paragraph (h)(3)(iv) of this section. The emergency-relief devices must be sized and designed in such a way that the maximum pressure in the shell never exceeds the test pressure of the portable tank.

NOTE TO PARAGRAPH (h)(3)(vi): An example of a method to determine the size of emergency-relief devices is given in Appendix 5 of the UN Manual of Tests and Criteria (IBR, see §171.7 of this subchapter). A second example of a test method for venting sizing is given in the American Institute of Chemical

Engineers Process Safety Progress Journal, June 2002 issue (Vol. 21, No. 2) (Informational materials not requiring incorporation by reference, see §171.7(b)).

(vii) For insulated portable tanks, the capacity and setting of emergency-relief devices must be determined assuming a loss of insulation from 1% of the surface area.

(viii) Vacuum-relief devices and reclosing devices on portable tanks used for flammable hazardous materials must be provided with flame arresters. Any reduction of the relief capacity caused by the flame arrester must be taken into account and the appropriate relief capacity must be provided.

(ix) Service equipment such as devices and external piping must be designed and constructed so that no hazardous material remains in them after filling the portable tank.

(x) Portable tanks may be either insulated or protected by a sun-shield. If the SADT of the hazardous material in the portable tank is 55 °C (131 °F) or less, the portable tank must be completely insulated. The outer surface must be finished in white or bright metal.

(xi) The degree of filling must not exceed 90% at 15 °C (59 °F).

(xii) DOT 57 metal portable tanks are authorized only for those materials or mixtures of two or more materials that are provided with a reference to Note 9 in Column 8 of the Organic Peroxide Table, found in paragraph (c) of this section. DOT 57 portable tanks must conform to the venting requirements of paragraph (f) of this section. These portable tanks are not subject to any other requirements of paragraph (h) of this section.

(4) For tertiary butyl hydroperoxide (TBHP), each tank car, cargo tank or portable tank must contain 7.6 cm (3.0 inches) low density polyethylene (PE) saddles having a melt index of at least 0.2 grams per 10 minutes (for example see, ASTM D1238, condition E) as part of the lading, with a ratio of PE to TBHP over a range of 0.008 to 0.012 by mass. Alternatively, plastic or metal containers equipped with fusible plugs having a melting point between 69 °C (156 °F) and 71 °C (160 °F) and filled with a sufficient quantity of water to dilute the TBHP to 65% or less by mass may

be used. The PE saddles must be visually inspected after each trip and, at a minimum, once every 12 months, and replaced when discoloration, fracture, severe deformation, or other indication of change is noted.

[69 FR 76159, Dec. 20, 2004, as amended at 70 FR 34398, June 14, 2005; 72 FR 55693, Oct. 1, 2007; 74 FR 2260, Jan. 14, 2009; 78 FR 1089, Jan. 7, 2013; 78 FR 65482, Oct. 31, 2013]

§ 173.226 Materials poisonous by inhalation, Division 6.1, Packing Group I, Hazard Zone A.

Division 6.1, Packing Group I, Zone A poisonous by inhalation (see §173.133) must be packed in non-bulk packagings in accordance with the following paragraphs:

(a) In seamless specification or UN cylinders conforming to the requirements of §173.40.

(b) In 1A1, 1B1, 1H1, 1N1, or 6HA1 drums further packed in a 1A2 or 1H2 drum. Both inner and outer drums must conform to the performance test requirements of subpart M of part 178 of this subchapter at the Packing Group I performance level. The outer drums may be tested either as a package intended to contain inner packagings (combination package) or as a single packaging intended to contain solids or liquids at a mass corresponding to the mass of the assembled packaging system. All outer drums, even those tested to contain inner packaging or as single packagings for solids, must withstand a hydrostatic test pressure of 100 kPa (15 psig). The outer drum must have a minimum thickness of 1.35 mm (0.053 inch) for a 1A2 outer drum or 6.3 mm (0.248 inch) for a 1H2 outer drum. In addition, the inner drum must—

(1) Be capable of satisfactorily withstanding the hydrostatic pressure test in §178.605 of this subchapter at a test pressure of 300 kPa (45 psig);

(2) Satisfactorily withstand the leakproofness test in §178.604 of this subchapter using an internal air pressure of at least twice the vapor pressure at 55 °C (131 °F) of the material to be packaged;

(3) Have screw-type closures that are—

§ 173.226

49 CFR Ch. I (10–1–14 Edition)

(i) Closed and tightened to a torque prescribed by the closure manufacturer, using a properly calibrated device that is capable of measuring torque;

(ii) Physically held in place by any means capable of preventing back-off or loosening of the closure by impact or vibration during transportation; and

(iii) Provided with a cap seal that is properly applied in accordance with the cap seal manufacturer's recommendations and is capable of withstanding an internal pressure of at least 100 kPa (15 psig).

(4) Have a minimum thickness as follows:

(i) For a 1A1 or 1N1 drum, 1.3 mm (0.051 inch);

(ii) For a 1B1 drum, 3.9 mm (0.154 inch);

(iii) For a 1H1 drum, 3.16 mm (0.124 inch); and

(iv) For a 6HA1 drum, the plastic inner container shall be 1.58 mm (0.0622 inch) and the outer steel drum shall be 0.96 mm (0.0378 inch).

(5) Be isolated from the outer drum by a shock-mitigating, non-reactive material, which completely surrounds the inner packaging on all sides.

(c) In combination packagings, consisting of an inner packaging system and an outer packaging, as follows:

(1) Outer packagings:

- Steel drum: 1A2
- Aluminum drum: 1B2
- Metal drum, other than steel or aluminum: 1N2
- Plywood drum: 1D
- Fiber drum: 1G
- Plastic drum: 1H2
- Steel box: 4A
- Aluminum box: 4B
- Natural wood box: 4C1 or 4C2
- Plywood box: 4D
- Reconstituted wood box: 4F
- Fiberboard box: 4G
- Expanded plastic box: 4H1
- Solid plastic box: 4H2
- Metal box other than steel or aluminum: 4N

(2) Inner packaging system. The inner packaging system consists of two packagings:

(i) an impact-resistant receptacle of glass, earthenware, plastic or metal securely cushioned with a non-reactive, absorbent material, and

(A) Capacity of each inner receptacle may not exceed 4 L (1 gallon).

(B) An inner receptacle that has a closure must have a closure which is physically held in place by any means capable of preventing back-off or loosening of the closure by impact or vibration during transportation.

(ii) Packed within a leak-tight packaging of metal or plastic.

(iii) This combination packaging in turn is packed within the outer packaging.

(3) Additional requirements:

(i) The total amount of liquid contained in the outer packaging must not exceed 16 L (4 gallons).

(ii) The inner packaging system must conform to the performance test requirements of subpart M of part 178 of this subchapter, at the Packaging Group I performance level when subjected to the following tests:

(A) § 178.603—Drop Test

(B) § 178.604—Leakproofness Test

(C) § 178.605—Hydrostatic Pressure Test

(iii) The inner packaging system must meet the above tests without the benefit of the outer packaging.

(iv) The leakproofness and hydrostatic pressure test may be conducted on either the inner receptacle or the outer packaging of the inner packaging system.

(v) The outer package must conform to the performance test requirements of subpart M of part 178 of this subchapter, at the Packaging Group I performance level as applicable for the type of package being used.

(d) If approved by the Associate Administrator, 1A1, 1B1, 1H1, 1N1, 6HA1 or 6HH1 drums described in paragraph (b) of this section may be used without being further packed in a 1A2 or 1H2 drum if the shipper loads the material, palletizes the drums, blocks and braces the drums within the transport vehicle and seals the transport vehicle used. Drums may not be stacked (double decked) within the transport vehicle. Shipments must be from one origin to one destination only without any intermediate pickup or delivery.

(e) Prior to reuse, all authorized inner drums must be leakproofness tested and marked in accordance with § 173.28 using a minimum test pressure

as indicated in paragraph (b)(2) of this section.

[69 FR 76172, Dec. 20, 2004, as amended at 71 FR 33881, June 12, 2006; 74 FR 2263, Jan. 14, 2009; 78 FR 1090, Jan. 7, 2013]

§ 173.227 Materials poisonous by inhalation, Division 6.1, Packing Group I, Hazard Zone B.

(a) In packagings as authorized in § 173.226 and seamless and welded specification cylinders or UN seamless cylinders conforming to the requirements of § 173.40.

(b) 1A1, 1B1, 1H1, 1N1, 6HA1, or 6HH1 drums further packed in a 1A2 or 1H2 drum. Both the inner and outer drums must conform to the performance test requirements of subpart M of part 178 of this subchapter at the Packing Group I performance level. Both the inner and outer drums must conform to the performance test requirements of subpart M of part 178 of this subchapter at the Packing Group I performance level. The outer drums may be tested either as a package intended to contain inner packagings (combination package) or as a single packaging intended to contain solids or liquids at a mass corresponding to the mass of the assembled packaging system. The outer drum must have a minimum thickness of 1.35 mm (0.053 inches) for a 1A2 outer drum or 6.30 mm (0.248 inches) for a 1H2 outer drum. Outer 1A2 and 1H2 drums must withstand a hydrostatic test pressure of 100 kPa (15 psig). Capacity of the inner drum may not exceed 220 liters. In addition, the inner drum must conform to all of the following requirements:

(1) Satisfactorily withstand the leakproofness test in § 178.604 of this subchapter using an internal air pressure of at least two times the vapor pressure at 55 °C (131 °F) of the material to be packaged;

(2) Have screw closures that are—

(i) Closed and tightened to a torque prescribed by the closure manufacturer, using a properly calibrated device that is capable of measuring torque;

(ii) Physically held in place by any means capable of preventing back-off or loosening of the closure by impact or vibration during transportation; and

(iii) Provided with a cap seal that is properly applied in accordance with the cap seal manufacturer's recommendations and is capable of withstanding an internal pressure of at least 100 kPa (15 psig).

(3) Have a minimum thickness as follows:

(i) For a 1A1 drum, 0.69 mm (0.027 inch);

(ii) For a 1B1 drum, 2.79 mm (0.110 inch);

(iii) For a 1H1 drum, 1.14 mm (0.045 inch); or

(iv) For a 6HA1 drum, the plastic inner container shall be 1.58 mm (0.0625 inch), the outer steel drum shall be 0.70 mm (0.027 inch).

(4) Be isolated from the outer drum by a shock-mitigating, non-reactive material which completely surrounds the inner packaging on all sides.

(5) Prior to reuse, all authorized inner drums must be leakproofness tested and marked in accordance with § 173.28 using a minimum test pressure as indicated in paragraph (b)(1) of this section.

(c) 1A1, 1B1, 1H1, 1N1, 6HA1 or 6HH1 drums described in paragraph (b) of this section may be used without being further packed in a 1A2 or 1H2 drum if the shipper loads the material, blocks and braces the drums within the transport vehicle and seals the transport vehicle used. Drums may not be stacked (double decked) within the transport vehicle. Shipments must be from one origin to one destination only without any intermediate pickup or delivery.

[70 FR 34398, June 14, 2005, as amended at 71 FR 33881, June 12, 2006; 73 FR 57006, Oct. 1, 2008]

§ 173.228 Bromine pentafluoride or bromine trifluoride.

(a) Bromine pentafluoride and bromine trifluoride are authorized in packagings as follows:

(1) Specification 3A150, 3AA150, 3B240, 3BN150, 4B240, 4BA240, 4BW240, and 3E1800 cylinders.

(2) UN cylinders as specified in part 178 of this subchapter, except acetylene cylinders and non-refillable cylinders, with a minimum test pressure of 10 bar and a minimum outage of 8 percent by volume. The use of UN tubes and MEGCs is not authorized.

§ 173.229

(3) The use of a pressure relief device is not authorized.

(b) A material in Hazard Zone A must be transported in a seamless specification cylinder conforming to the requirements of §173.40. However, a welded cylinder filled before October 1, 2002, in accordance with the requirements of this subchapter in effect at the time of filling, may be transported for reprocessing or disposal of the cylinder's contents until December 31, 2003. No cylinder may be equipped with a pressure relief device.

[67 FR 51643, Aug. 8, 2002, as amended at 67 FR 61289, Sept. 30, 2002; 68 FR 24660, May 8, 2003, as amended at 71 FR 33881, June 12, 2006]

§ 173.229 Chloric acid solution or chlorine dioxide hydrate, frozen.

When the §172.101 table specifies that a hazardous material be packaged in accordance with this section, only 4G fiberboard boxes, with inner packagings of polyethylene or other suitable material, are authorized. Fiberboard boxes must be reinforced and insulated and sufficient dry ice must be used to maintain the hydrate or acid in a frozen state during transportation. Each packaging must conform to the general packaging requirements of subpart B of part 173, and to the requirements of part 178 of this subchapter at the Packing Group I performance level. Transportation is authorized only by private or contract carrier by motor vehicle.

§ 173.230 Fuel cell cartridges containing hazardous material.

(a) *Requirements for Fuel Cell Cartridges.* Fuel cell cartridges, including when contained in or packed with equipment, must be designed and constructed to prevent fuel leakage under normal conditions of transportation. Fuel cell cartridge design types using liquids as fuels must pass an internal pressure test at a gauge pressure of 100 kPa (15 psig) without leakage. Except for fuel cell cartridges containing hydrogen in metal hydride which must be in conformance with paragraph (d) of this section, each fuel cell cartridge design type including when contained in or packed with equipment, must pass a 1.2 meter (3.9 feet) drop test onto an unyielding surface in the orientation

49 CFR Ch. I (10–1–14 Edition)

most likely to result in the failure of the containment system with no loss of contents. Fuel cell cartridges installed in or integral to a fuel cell system are regarded as contained in equipment. Fuel cell cartridges containing a Division 2.1, Division 4.3 or Class 8 material must meet the following additional requirements.

(b) A fuel cell cartridge designed to contain a Division 4.3 or a Class 8 material may contain an activator provided it is fitted with two independent means of preventing unintended mixing with the fuel during transport.

(c) Each fuel cell cartridge designed to contain a liquefied flammable gas must:

(1) Be capable of withstanding, without leakage or bursting, a pressure of at least two times the equilibrium pressure of the contents at 55 °C (131 °F);

(2) Contain no more than 200 mL of liquefied flammable gas with a vapor pressure not exceeding 1,000 kPa (150 psig) at 55 °C (131 °F); and

(3) Pass the hot water bath test prescribed in accordance with §173.306(a)(3)(v).

(d) Each fuel cell cartridge designed to contain hydrogen in a metal hydride must conform to the following:

(1) Each fuel cell cartridge must have a water capacity less than or equal to 120 mL (4 fluid ounces).

(2) Each fuel cell cartridge must be a design type that has been subjected, without leakage or bursting, a pressure of at least two times the design pressure of the cartridge at 55 °C (131 °F) or 200 kPa (30 psig) more than the design pressure of the cartridge at 55 °C (131 °F), whichever is greater. The pressure at which the test is conducted is referred to as the "minimum shell burst pressure." The pressure within the fuel cell cartridge must not exceed 5 MPa (725 psig) at 55 °C (131 °F).

(3) Each fuel cell cartridge must be filled in accordance with the procedure provided by the manufacturer. The manufacturer must provide the following information with each fuel cell cartridge:

(i) Inspection procedures to be carried out before initial filling and before refilling of the fuel cell cartridge;

(ii) Safety precautions and potential hazards to be aware of;

(iii) A method of determining when the rated capacity has been achieved;

(iv) Minimum and maximum pressure range;

(v) Minimum and maximum temperature range; and

(vi) Any other requirements to be met for initial filling and refilling including the type of equipment to be used.

(4) Each fuel cell cartridge must be permanently marked with the following information:

(i) The rated charging pressure in megapascals (MPa);

(ii) The manufacturer's serial number of the fuel cell cartridges or unique identification number; and

(iii) The expiration date based on the maximum service life (yyyy/mm).

(5) *Design type tests:* Each fuel cell cartridge design type must be subjected to and pass the following tests (this includes cartridges integral to a fuel cell):

(i) *Drop test.* A 1.8 m (5.9 feet) drop test onto an unyielding surface must be performed. There must be no leakage. Leakage must be determined using a soap bubble solution or other equivalent means on all possible leak locations, when the fuel cell cartridge is charged to its rated charging pressure. The fuel cell cartridge must then be hydrostatically pressurized to destruction. The burst pressure must be greater than 85% of the minimum shell burst pressure. The drop must be performed in the following four different orientations:

(A) Vertically, on the end containing the shut-off valve assembly;

(B) Vertically, on the end opposite to the shut-off valve assembly;

(C) Horizontally, onto a steel apex with a diameter of 3.8 cm (9.7 in), with the steel apex in the upward position; and

(D) At a 45° angle on the end containing the shut-off valve assembly.

(ii) *Fire test.* A fuel cell cartridge filled to rated capacity (with hydrogen) must be subjected to a fire engulfment test. The cartridge design (including design types with an integral vent feature) is deemed to pass the fire test if:

(A) The internal pressure vents to zero gauge pressure without the rupture of the cartridge; or

(B) The cartridge withstands the fire for a minimum of 20 minutes without rupture.

(iii) *Hydrogen cycling test.* A fuel cell cartridge must be subjected to a hydrogen cycling test to ensure that the design stress limits are not exceeded during use. The fuel cell cartridge must be cycled from not more than 5% rated hydrogen capacity to not less than 95% rated hydrogen capacity and back to not more than 5% rated hydrogen capacity. The rated charging pressure must be used for charging and temperatures must be within the operating temperature range. The cycling must be continued for at least 100 cycles. Following the cycling test the fuel cell cartridge must be charged and the water volume displaced by the cartridge must be measured. The cartridge design is deemed to pass the test if the water volume displaced by the cycled cartridge does not exceed the water volume displaced by an uncycled cartridge charged to 95% rated capacity and pressurized to 75% of its minimum shell burst pressure.

(6) *Production leak test.* Each fuel cell cartridge must be tested for leaks at 15 °C ±5 °C (59 °F ±9 °F) while pressurized to its rated charging pressure. There must be no leakage. Leakage must be determined using a soap bubble solution or other equivalent means on all possible leak locations.

(e) The following packagings are authorized provided the general packaging requirements subpart B of part 173 of this subchapter are met:

(1) For fuel cell cartridges, rigid packagings conforming to the requirements of part 178 of this subchapter at the packing group II performance level; and

(2) Strong outer packagings for fuel cell cartridges contained in equipment or packed with equipment. Large equipment containing fuel cell cartridges may be transported unpackaged if the equipment provides an equivalent level of protection.

(i) Fuel cell cartridges packed with equipment must be packed with cushioning material or divider(s) or inner

packagings so that the fuel cell cartridges are protected against damage that may be caused by the shifting or placement of the equipment and cartridges within the packaging.

(ii) For fuel cell cartridges contained in equipment, the entire fuel cell system must be protected against short circuits and unintentional activation. The equipment must be securely cushioned in the outer packaging.

(f) For transportation by aircraft, the following additional provisions apply:

(1) The package must comply with the applicable provisions of §173.27 of this subchapter;

(2) For fuel cell cartridges contained in equipment, fuel cell systems must not charge batteries during transport;

(3) For transportation aboard passenger aircraft, for fuel cell cartridges contained in equipment, each fuel cell system and fuel cell cartridge must conform to IEC 62282-6-100 and IEC 62282-6-100 Amend. 1 (IBR, see §171.7 of this subchapter) or a standard approved by the Associate Administrator;

(4) When packed with equipment, fuel cell cartridges must be packed in an intermediate packaging along with the equipment they are capable of powering, and the intermediate packagings packed in a strong outer packaging. The maximum number of fuel cell cartridges in the intermediate packaging may not be more than the number required to power the equipment, plus two spares;

(5) Large robust articles containing fuel cells may be transported unpackaged when approved by the Associate Administrator; and

(6) The mass of a fuel cell cartridge containing a Division 4.3 or Class 8 materials must be not more than 1 kg (2.2 lbs).

(7) Fuel cell cartridges intended for transportation in carry-on baggage on board passenger aircraft must comply with paragraphs (a), (b), (c), (d) in this section and the applicable provisions prescribed in §175.10 of this subchapter.

(g) *Limited quantities.* Limited quantities of hazardous materials contained in fuel cell cartridges are excepted from the labeling requirements, unless the cartridges are offered for transportation or transported by aircraft, and from the placarding and specification

packaging requirements of this subchapter when packaged according to this section. Each package must conform to the packaging requirements of subpart B of this part and may not exceed 30 kg (66 pounds) gross weight. Except as authorized in paragraph (h) of this section, a package containing a limited quantity of fuel cell cartridges must be marked as specified in §172.315 of this subchapter and, for transportation by highway or rail, is not subject to the shipping paper requirements of subpart C of part 172 of this subchapter, unless the material meets the definition of a hazardous substance, hazardous waste, or marine pollutant, and are eligible for the exceptions provided in §173.156 of part. For transportation by highway, rail and vessel, the following combination packagings are authorized:

(1) For flammable liquids, in fuel cell cartridges containing not more than 1.0 L (0.3 gallon) per cartridge, packed in strong outer packaging.

(2) For water-reactive substances (Division 4.3 Dangerous when wet material), in fuel cell cartridges containing not more than 0.5 L (16.9 fluid ounces) for liquids or not over 0.5 kg (1.1 pound) for solids per cartridge, packed in strong outer packaging.

(3) For corrosive materials, in fuel cell cartridges containing not more than 1.0 L (0.3 gallon) for liquids or not more than 1.0 kg (2.2 pounds) for solids per cartridge, packed in strong outer packaging.

(4) For liquefied (compressed) flammable gas, in fuel cell cartridges not over 120 mL (4 fluid ounces) net capacity per cartridge, packed in strong outer packaging.

(5) For hydrogen in metal hydride, in fuel cell cartridges not over 120 mL (4 fluid ounces) net capacity per cartridge, packed in strong outer packaging.

(6) For transportation by aircraft, the following combination packagings are authorized:

(i) For flammable liquids, in fuel cell cartridges containing not more than 0.5 L (16.9 fluid ounces) per cartridge, packed in strong outer packaging. Additionally, each package may contain no more than 2.5 kg (net mass) of fuel cell cartridges.

(ii) For water-reactive substances (Division 4.3 Dangerous when wet material), in fuel cell cartridges containing not more than 200 g (0.4 pounds) of solid fuel per cartridge, packed in strong outer packaging. Additionally, each package may contain no more than 2.5 kg (net mass) of fuel cell cartridges.

(iii) For corrosive materials, in fuel cell cartridges containing not more than 200 mL (6.7 fluid ounces) for liquids or not more than 200 g (0.4 pounds) for solids per cartridge packed in strong outer packaging. Additionally, each package may contain no more than 2.5 kg (net mass) of fuel cell cartridges.

(iv) For liquefied (compressed) flammable gas, in fuel cell cartridges not over 120 mL (4 fluid ounces) net capacity per cartridge, packed in strong outer packaging. Additionally, each package may contain no more than 0.5 kg (net mass) of fuel cell cartridges.

(v) For hydrogen in metal hydride, in fuel cell cartridges not over 120 mL (4 fluid ounces) net capacity per cartridge, packed in strong outer packaging. Additionally, each package may contain no more than 0.5 kg (net mass) of fuel cell cartridges.

(h) *Consumer commodities.* Until December 31, 2020, for other than transportation by aircraft, a limited quantity that conforms to the provisions of paragraph (g) of this section and is also a “consumer commodity” as defined in §171.8 of this subchapter, may be renamed “Consumer commodity” and reclassified as ORM–D. In addition to the exceptions provided by paragraph (g) of this section, shipments of ORM–D materials are not subject to the shipping paper requirements of subpart C of part 172 of this subchapter, unless the materials meet the definition of a hazardous substance, hazardous waste, marine pollutant, or are offered for transportation by aircraft, and are eligible for the exceptions provided in §173.156 of this part.

[74 FR 2263, Jan. 14, 2009, as amended at 75 FR 73, Jan. 4, 2010; 76 FR 3379, Jan. 19, 2011; 78 FR 1090, 1115, Jan. 7, 2013; 78 FR 65485, Oct. 31, 2013]

Subpart F—Bulk Packaging for Hazardous Materials Other Than Class 1 and Class 7

§173.240 Bulk packaging for certain low hazard solid materials.

When §172.101 of this subchapter specifies that a hazardous material be packaged under this section, only the following bulk packagings are authorized, subject to the requirements of subparts A and B of part 173 of this subchapter and the special provisions specified in column 7 of the §172.101 table.

(a) *Rail cars:* Class DOT 103, 104, 105, 109, 111, 112, 114, 115, or 120 tank car tanks; Class 106 or 110 multi-unit tank car tanks; and metal non-DOT specification, sift-proof tank car tanks and sift-proof closed cars.

(b) *Motor vehicles:* Specification MC 300, MC 301, MC 302, MC 303, MC 304, MC 305, MC 306, MC 307, MC 310, MC 311, MC 312, MC 330, MC 331, DOT 406, DOT 407, and DOT 412 cargo tank motor vehicles; non-DOT specification, sift-proof cargo tank motor vehicles; and sift-proof closed vehicles.

(c) *Portable tanks and closed bulk bins.* DOT 51, 56, 57 and 60 portable tanks; IMO type 1, 2 and 5, and IM 101 and IM 102 portable tanks; UN portable tanks; marine portable tanks conforming to 46 CFR part 64; and sift-proof non-DOT Specification portable tanks and closed bulk bins are authorized.

(d) *IBCs.* IBCs are authorized subject to the conditions and limitations of this section provided the IBC type is authorized according to the IBC packaging code specified for the specific hazardous material in Column (7) of the §172.101 Table of this subchapter and the IBC conforms to the requirements in subpart O of part 178 of this subchapter at the Packing Group performance level as specified in Column (5) of the §172.101 Table of this subchapter for the material being transported.

(1) IBCs may not be used for the following hazardous materials:

(i) Packing Group I liquids; and
(ii) Packing Group I solids that may become liquid during transportation.

(2) The following IBCs may not be used for Packing Group II and III solids that may become liquid during transportation:

§ 173.241

49 CFR Ch. I (10–1–14 Edition)

- (i) Wooden: 11C, 11D and 11F;
- (ii) Fiberboard: 11G;
- (iii) Flexible: 13H1, 13H2, 13H3, 13H4, 13H5, 13L1, 13L2, 13L3, 13L4, 13M1 and 13M2; and
- (iv) Composite: 11HZ2 and 21HZ2.

(e) *Large Packagings.* Large Packagings are authorized subject to the conditions and limitations of this section provided the Large Packaging type is authorized according to the IBC packaging code specified for the specific hazardous material in Column (7) of the §172.101 Table of this subchapter and the Large Packaging conforms to the requirements in subpart Q of part 178 of this subchapter at the Packing Group performance level as specified in Column (5) of the §172.101 Table for the material being transported.

(1) Except as specifically authorized in this subchapter, Large Packagings may not be used for Packing Group I or II hazardous materials.

(2) Large Packagings with paper or fiberboard inner receptacles may not be used for solids that may become liquid in transportation.

(f) *Flexible Bulk Containers.* Flexible Bulk Containers are authorized subject to the conditions and limitations of this section provided the use of a Flexible Bulk Container is authorized by the inclusion of bulk packaging code B120 in Column (7) of the §172.101 Hazardous Materials Table of this subchapter and the Flexible Bulk Container conforms to the requirements in subpart S of part 178 of this subchapter. Flexible Bulk Containers may not be used for Packing Group I or II hazardous materials.

[Amdt. 173–224, 55 FR 52663, Dec. 21, 1990, as amended at 56 FR 66274, Dec. 20, 1991; Amdt. 173–238, 59 FR 38067, July 26, 1994; Amdt. 173–252, 61 FR 28676, June 5, 1996; 66 FR 33435, June 21, 2001; 78 FR 1091, Jan. 7, 2013]

§ 173.241 Bulk packagings for certain low hazard liquid and solid materials.

When §172.101 of this subchapter specifies that a hazardous material be packaged under this section, only the following bulk packagings are authorized, subject to the requirements of subparts A and B of part 173 of this subchapter and the special provisions specified in column 7 of the §172.101 table.

(a) *Rail cars:* Class DOT 103, 104, 105, 109, 111, 112, 114, 115, or 120 tank car tanks; Class 106 or 110 multi-unit tank car tanks and AAR Class 203W, 206W, and 211W tank car tanks.

(b) *Cargo tanks:* DOT specification MC 300, MC 301, MC 302, MC 303, MC 304, MC 305, MC 306, MC 307, MC 310, MC 311, MC 312, MC 330, MC 331, DOT 406, DOT 407, and DOT 412 cargo tank motor vehicles; and non-DOT specification cargo tank motor vehicles suitable for transport of liquids.

(c) *Portable tanks.* DOT Specification 51, 56, 57 and 60 portable tanks; IMO type 1, 2 and 5, and IM 101 and IM 102 portable tanks; UN portable tanks; marine portable tanks conforming to 46 CFR part 64; and non-DOT Specification portable tanks suitable for transport of liquids are authorized. For transportation by vessel, also see §176.340 of this subchapter. For transportation of combustible liquids by vessel, additional requirements are specified in §176.340 of this subchapter.

(d) *IBCs.* IBCs are authorized subject to the conditions and limitations of this section provided the IBC type is authorized according to the IBC packaging code specified for the specific hazardous material in Column (7) of the §172.101 Table of this subchapter and the IBC conforms to the requirements in subpart O of part 178 of this subchapter at the Packing Group performance level as specified in Column (5) of the §172.101 Table for the material being transported.

(1) IBCs may not be used for the following hazardous materials:

- (i) Packing Group I liquids; and
- (ii) Packing Group I solids that may become liquid during transportation.

(2) The following IBCs may not be used for Packing Group II and III solids that may become liquid during transportation:

- (i) Wooden: 11C, 11D and 11F;
- (ii) Fiberboard: 11G;
- (iii) Flexible: 13H1, 13H2, 13H3, 13H4, 13H5, 13L1, 13L2, 13L3, 13L4, 13M1 and 13M2; and
- (iv) Composite: 11HZ2 and 21HZ2.

(e) *Large Packagings.* Large Packagings are authorized subject to the conditions and limitations of this section provided the Large Packaging type is authorized according to the IBC

packaging code specified for the specific hazardous material in Column (7) of the §172.101 Table of this subchapter and the Large Packaging conforms to the requirements in subpart Q of part 178 of this subchapter at the Packing Group performance level as specified in Column (5) of the §172.101 Table for the material being transported.

(1) Except as specifically authorized in this subchapter, Large Packagings may not be used for Packing Group I or II hazardous materials.

(2) Large Packagings with paper or fiberboard inner receptacles may not be used for solids that may become liquid in transportation.

[Amdt. 173-224, 55 FR 52663, Dec. 21, 1990, as amended at 56 FR 66275, Dec. 20, 1991; Amdt. 173-238, 59 FR 38067, July 26, 1994; Amdt. 173-252, 61 FR 28676, June 5, 1996; 66 FR 33435, June 21, 2001; 68 FR 57632, Oct. 6, 2003; 70 FR 34075, June 13, 2005; 75 FR 5394, Feb. 2, 2010]

§ 173.242 Bulk packagings for certain medium hazard liquids and solids, including solids with dual hazards.

When §172.101 of this subchapter specifies that a hazardous material be packaged under this section, only the following bulk packagings are authorized, subject to the requirements of subparts A and B of part 173 of this subchapter and the special provisions specified in column 7 of the §172.101 table.

(a) *Rail cars*: Class DOT 103, 104, 105, 109, 111, 112, 114, 115, or 120 tank car tanks; Class 106 or 110 multi-unit tank car tanks and AAR Class 206W tank car tanks.

(b) *Cargo tanks*: Specification MC 300, MC 301, MC 302, MC 303, MC 304, MC 305, MC 306, MC 307, MC 310, MC 311, MC 312, MC 330, MC 331, DOT 406, DOT 407, and DOT 412 cargo tank motor vehicles; and non-DOT specification cargo tank motor vehicles when in compliance with §173.5a(c). Cargo tanks used to transport Class 3, Packing Group I or II, or Packing Group III with a flash point of less than 38 °C (100 °F); Class 6, Packing Group I or II; and Class 8, Packing Group I or II materials must conform to the following special requirements:

(1) Pressure relief system: Except as provided by §173.33(d), each cargo tank must be equipped with a pressure relief system meeting the requirements of

§178.346-3 or §178.347-4 of this subchapter. However, pressure relief devices on MC 310, MC 311 and MC 312 cargo tanks must meet the requirements for a Specification MC 307 cargo tank (except for Class 8, Packing Group I and II). Pressure relief devices on MC 330 and MC 331 cargo tanks must meet the requirement in §178.337-9 of this subchapter.

(2) Bottom outlets: DOT 406, DOT 407 and DOT 412 must be equipped with stop-valves meeting the requirements of §178.345-11 of this subchapter; MC 304, MC 307, MC 310, MC 311, and MC 312 cargo tanks must be equipped with stop-valves capable of being remotely closed within 30 seconds of actuation by manual or mechanic means and (except for Class 8, Packing Group I and II) by a closure activated at a temperature not over 121 °C (250 °F); MC 330 and MC 331 cargo tanks must be equipped with internal self-closing stop-valves meeting the requirements in §178.337-11 of this subchapter.

(c) *Portable tanks*. DOT Specification 51, 56, 57 and 60 portable tanks; Specification IM 101, IM 102, and UN portable tanks when a T Code is specified in Column (7) of the §172.101 Hazardous Materials Table for a specific hazardous material; and marine portable tanks conforming to 46 CFR part 64 are authorized. DOT Specification 57 portable tanks used for the transport by vessel of Class 3, Packaging Group II materials must conform to the following:

(1) *Minimum design pressure*. Each tank must have a minimum design pressure of 62 kPa (9 psig);

(2) *Pressure relief devices*. Each tank must be equipped with at least one pressure relief device, such as a spring-loaded valve or fusible plug, conforming to the following:

(i) Each pressure relief device must communicate with the vapor space of the tank when the tank is in a normal transportation attitude. Shutoff valves may not be installed between the tank opening and any pressure relief device. Pressure relief devices must be mounted, shielded, or drained to prevent the accumulation of any material that could impair the operation or discharge capability of the device;

§ 173.242

49 CFR Ch. I (10–1–14 Edition)

(ii) Frangible devices are not authorized;

(iii) No pressure relief device may open at less than 34.4 kPa (5 psig);

(iv) If a fusible device is used for relieving pressure, the device must have a minimum area of 1.25 square inches. The device must function at a temperature between 104 °C. and 149 °C. (220 °F. and 300 °F.) and at a pressure less than the design test pressure of the tank, unless this latter function is accomplished by a separate device; and

(v) No relief device may be used which would release flammable vapors under normal conditions of transportation (temperature up to and including 54 °C. (130 °F.)); and

(3) *Venting capacity.* The minimum venting capacity for pressure activated vents must be 6,000 cubic feet of free air per hour (measured at 101.3 kPa (14.7 psi) and 15.6 °C. (60 °F.)) at not more than 34.4 kPa (5 psi). The total emergency venting capacity (cu. ft./hr.) of each portable tank must be at least that determined from the following table:

Total surface area square feet ^{1 2}	Cubic feet free air per hour
20	15,800
30	23,700
40	31,600
50	39,500
60	47,400
70	55,300
80	63,300
90	71,200
100	79,100
120	94,900
140	110,700
160	126,500

¹ Interpolate for intermediate sizes.
² Surface area excludes area of legs.

(4) Unless provided by §173.32(h)(3), an IM 101, 102 or UN portable tank with a bottom outlet and used to transport a liquid hazardous material that is a Class 3, PG I or II, or PG III with a flash point of less than 38 °C (100 °F); Division 5.1 PG I or II; or Division 6.1, PG I or II, must have internal valves conforming to §178.275(d)(3) of this subchapter.

(d) *IBCs.* IBCs are authorized subject to the conditions and limitations of this section provided the IBC type is authorized according to the IBC packaging code specified for the specific hazardous material in Column (7) of the §172.101 Table of this subchapter

and the IBC conforms to the requirements in subpart O of part 178 of this subchapter at the Packing Group performance level as specified in Column (5) of the §172.101 Table of this subchapter for the material being transported.

(1) IBCs may not be used for the following hazardous materials:

(i) Packing Group I liquids; and

(ii) Packing Group I solids that may become liquid during transportation.

(2) The following IBCs may not be used for Packing Group II and III solids that may become liquid during transportation:

(i) Wooden: 11C, 11D and 11F;

(ii) Fiberboard: 11G;

(iii) Flexible: 13H1, 13H2, 13H3, 13H4, 13H5, 13L1, 13L2, 13L3, 13L4, 13M1 and 13M2; and

(iv) Composite: 11HZ2 and 21HZ2.

(e) *Large Packagings.* Large Packagings are authorized subject to the conditions and limitations of this section provided the Large Packaging type is authorized according to the IBC packaging code specified for the specific hazardous material in Column (7) of the §172.101 Table of this subchapter and the Large Packaging conforms to the requirements in subpart Q of part 178 of this subchapter at the Packing Group performance level as specified in Column (5) of the §172.101 Table for the material being transported.

(1) Except as specifically authorized in this subchapter, Large Packagings may not be used for Packing Group I or II hazardous materials.

(2) Large Packagings with paper or fiberboard inner receptacles may not be used for solids that may become liquid in transportation.

[Amdt. 173–224, 55 FR 52663, Dec. 21, 1990, as amended at 56 FR 66275, Dec. 20, 1991; Amdt. 173–238, 59 FR 38067, July 26, 1994; Amdt. 173–243, 60 FR 40038, Aug. 4, 1995; Amdt. 173–246, 60 FR 49110, Sept. 21, 1995; Amdt. 173–252, 61 FR 28676, June 5, 1996; 62 FR 51560, Oct. 1, 1997; 65 FR 50461, Aug. 18, 2000; 66 FR 33435, June 21, 2001; 67 FR 15743, Apr. 3, 2002; 68 FR 32413, May 30, 2003; 75 FR 5395, Feb. 2, 2010; 76 FR 5492, Feb. 1, 2011]

§ 173.243 Bulk packaging for certain high hazard liquids and dual hazard materials which pose a moderate hazard.

When §172.101 of this subchapter specifies that a hazardous material be packaged under this section, only the following bulk packagings are authorized, subject to the requirements of subparts A and B of part 173 of this subchapter and the special provisions specified in column 7 of the §172.101 table.

(a) *Rail cars*: Class DOT 103, 104, 105, 109, 111, 112, 114, 115, or 120 fusion-welded tank car tanks; and Class 106 or 110 multi-unit tank car tanks.

(b) *Cargo tanks*. Specification MC 304, MC 307, MC 330, MC 331 cargo tank motor vehicles; and MC 310, MC 311, MC 312, DOT 407, and DOT 412 cargo tank motor vehicles with tank design pressure of at least 172.4 kPa (25 psig). Cargo tanks used to transport Class 3 or Division 6.1 materials, or Class 8, Packing Group I or II materials must conform to the following special requirements:

(1) Pressure relief system: Except as provided by §173.33(d), each cargo tank must be equipped with a pressure relief system meeting the requirements of §178.346-3 or 178.347-4 of this subchapter. However, pressure relief devices on MC 310, MC 311 and MC 312 cargo tanks must meet the requirements for a Specification MC 307 cargo tank (except for Class 8, Packing Group I and II). Pressure relief devices on MC 330 and MC 331 cargo tanks must meet the requirement in §178.337-9 of this subchapter.

(2) Bottom outlets: DOT 407 and DOT 412 cargo tanks must be equipped with stop-valves meeting the requirements of §178.345-11 of this subchapter; MC 304, MC 307, MC 310, MC 311, and MC 312 cargo tanks must be equipped with stop-valves capable of being remotely closed within 30 seconds of actuation by manual or mechanic means and (except for Class 8, Packing Group I and II) by a closure activated at a temperature not over 121 °C (250 °F); MC 330 and MC 331 cargo tanks must be equipped with internal self-closing stop-valves meeting the requirements in §178.337-11 of this subchapter.

(c) *Portable tanks*. DOT Specification 51 and 60 portable tanks; UN portable

tanks and IM 101 and IM 102 portable tanks when a T code is specified in Column (7) of the §172.101 Table of this subchapter for a specific hazardous material; and marine portable tanks conforming to 46 CFR part 64 with design pressure of at least 172.4 kPa (25 psig) are authorized. Unless provided by §173.32(h)(3), an IM 101, 102 or UN portable tank, with a bottom outlet, used to transport a liquid hazardous material that is a Class 3, PG I or II, or PG III with a flash point of less than 38 °C (100 °F); Division 5.1, PG I or II; or Division 6.1, PG I or II, must have internal valves conforming to §178.275(d)(3) of this subchapter.

(d) *IBCs*. IBCs are authorized subject to the conditions and limitations of this section provided the IBC type is authorized according to the IBC packaging code specified for the specific hazardous material in Column (7) of the §172.101 Table of this subchapter and the IBC conforms to the requirements in subpart O of part 178 of this subchapter at the Packing Group performance level as specified in Column (5) of the §172.101 Table of this subchapter for the material being transported.

(1) IBCs may not be used for the following hazardous materials:

(i) Packing Group I liquids; and
(ii) Packing Group I solids that may become liquid during transportation.

(2) The following IBCs may not be used for Packing Group II and III solids that may become liquid during transportation:

(i) Wooden: 11C, 11D and 11F;
(ii) Fiberboard: 11G;
(iii) Flexible: 13H1, 13H2, 13H3, 13H4, 13H5, 13L1, 13L2, 13L3, 13L4, 13M1 and 13M2; and
(iv) Composite: 11HZ2 and 21HZ2.

(e) A dual hazard material may be packaged in accordance with §173.242 if:

(1) The subsidiary hazard is Class 3 with a flash point greater than 38 °C (100 °F); or

(2) The subsidiary hazard is Division 6.1, Packing Group III; or

§ 173.244

(3) The subsidiary hazard is Class 8, Packaging Group, III.

[Amdt. 173-224, 55 FR 52663, Dec. 21, 1990, as amended at 56 FR 66275, Dec. 20, 1991; Amdt. 173-138, 59 FR 49134, Sept. 26, 1994; Amdt. 173-238, 59 FR 38068, July 26, 1994; Amdt. 173-243, 60 FR 40038, Aug. 4, 1995; Amdt. 173-246, 60 FR 49110, Sept. 21, 1995; Amdt. 173-252, 61 FR 28676, June 5, 1996; 62 FR 51560, Oct. 1, 1997; 64 FR 10780, Mar. 5, 1999; 66 FR 33435, June 21, 2001; 67 FR 15743, Apr. 3, 2002; 68 FR 32413, May 30, 2003]

§ 173.244 Bulk packaging for certain pyrophoric liquids (Division 4.2), dangerous when wet (Division 4.3) materials, and poisonous liquids with inhalation hazards (Division 6.1).

When §172.101 of this subchapter specifies that a hazardous material be packaged under this section, only the following bulk packagings are authorized, subject to the requirements of subparts A and B of part 173 of this subchapter and the special provisions specified in column 7 of the §172.101 table.

(a) *Rail cars:* (1) Class DOT 105, 109, 112, 114, or 120 fusion-welded tank car tanks; and Class 106 or 110 multi-unit tank car tanks. For tank car tanks built prior to March 16, 2009, the following conditions apply:

(i) Division 6.1 Hazard Zone A materials must be transported in tank cars having a test pressure of 34.47 Bar (500 psig) or greater and conform to Classes 105J, 106 or 110.

(ii) Division 6.1 Hazard Zone B materials must be transported in tank cars having a test pressure of 20.68 Bar (300 psig) or greater and conform to Classes 105S, 106, 110, 112J, 114J or 120S.

(iii) Hydrogen fluoride, anhydrous must be transported in tank cars having a test pressure of 20.68 Bar (300 psig) or greater and conform to Classes 105, 112, 114 or 120.

(2) For materials poisonous by inhalation, single unit tank cars tanks built prior to March 16, 2009 and approved by the Tank Car Committee for transportation of the specified material. Except as provided in §173.244(a)(3), tank cars built on or after March 16, 2009 used for the transportation of the PIH materials listed below, must meet the applicable authorized tank car specification listed in the following table:

49 CFR Ch. I (10-1-14 Edition)

Proper shipping name	Authorized tank car specification
Acetone cyanohydrin, stabilized (Note 1)	105J5001 112J5001
Acrolein (Note 1)	105J6001
Allyl Alcohol	105J5001 112J5001
Bromine	105J5001
Chloropicrin	105J5001 112J5001
Chlorosulfonic acid	105J5001 112J5001
Dimethyl sulfate	105J5001 112J5001
Ethyl chloroformate	105J5001 112J5001
Hexachlorocyclopentadiene	105J5001 112J5001
Hydrocyanic acid, aqueous solution <i>or</i> Hydrogen cyanide, aqueous solution <i>with not more than 20% hydrogen cyanide (Note 2)</i>	105J5001 112J5001
Hydrogen cyanide, stabilized (Note 2)	105J6001
Hydrogen fluoride, anhydrous	105J5001 112J5001
Poison inhalation hazard, Zone A materials not specifically identified in this table	105J6001
Poison inhalation hazard, Zone B materials not specifically identified in this table	105J5001 112J5001
Phosphorus trichloride	105J5001 112J5001
Sulfur trioxide, stabilized	105J5001 112J5001
Sulfuric acid, fuming	105J5001 112J5001
Titanium tetrachloride	105J5001 112J5001

Note 1: Each tank car must have a reclosing pressure relief device having a start-to-discharge pressure of 10.34 Bar (150 psig). Restenciling to a lower test pressure is not authorized.

Note 2: Each tank car must have a reclosing pressure relief device having a start-to-discharge pressure of 15.51 Bar (225 psig). Restenciling to a lower test pressure is not authorized.

(3) As an alternative to the authorized tank car specification listed in the table in paragraph (a)(2) of this section, a car of the same authorized tank car specification but of the next lower test pressure, as prescribed in column 5 of the table at §179.101-1 of this subchapter, may be used provided that both of the following conditions are met:

(i) The difference between the alternative and the required minimum plate thicknesses, based on the calculation prescribed in §179.100-6 of this subchapter, must be added to the alternative tank car jacket and head shield. When the jacket and head shield are made from steel with a minimum tensile strength from 70,000 p.s.i. to 80,000 p.s.i., but the required minimum plate thickness calculation is based on steel with a minimum tensile strength of 81,000 p.s.i., the thickness to be added

to the jacket and head shield must be increased by a factor of 1.157. Forming allowances for heads are not required to be considered when calculating thickness differences.

(ii) The tank car jacket and head shield are manufactured from carbon steel plate as prescribed in § 179.100-7(a) of this subchapter.

(b) *Cargo tanks*: Specifications MC 330 and MC 331 cargo tank motor vehicles and, except for Division 4.2 materials, MC 312 and DOT 412 cargo tank motor vehicles.

(c) *Portable tanks*: DOT 51 portable tanks and UN portable tanks that meet the requirements of this subchapter, when a T code is specified in Column (7) of the § 172.101 Table of this subchapter for the specific hazardous material, are authorized. Additionally, a DOT 51 or UN portable tank used for Division 6.1 liquids, Hazard Zone A or B, must be certified and stamped to the ASME Code as specified in § 178.273(b)(6) of this subchapter.

[Amdt. 173-224, 55 FR 52663, Dec. 21, 1990, as amended at 56 FR 66275, Dec. 20, 1991; 57 FR 45463, Oct. 1, 1992; Amdt. 173-252, 61 FR 28676, June 5, 1996; 68 FR 45037, July 31, 2003; 72 FR 55693, Oct. 1, 2007; 74 FR 1799, Jan. 13, 2009]

§ 173.245 Bulk packaging for extremely hazardous materials such as poisonous gases (Division 2.3).

When § 172.101 of this subchapter specifies that a hazardous material be packaged under this section, only the following bulk packagings are authorized, subject to the requirements of subparts A and B of part 173 of this subchapter and the special provisions specified in column 7 of the § 172.101 table.

(a) Tank car tanks and multi-unit tank car tanks, when approved by the Associate Administrator.

(b) Cargo tank motor vehicles and portable tanks, when approved by the Associate Administrator.

[Amdt. 173-224, 55 FR 52663, Dec. 21, 1990, as amended at 56 FR 66275, Dec. 20, 1991; 66 FR 45379, Aug. 28, 2001]

§ 173.247 Bulk packaging for certain elevated temperature materials.

When § 172.101 of this subchapter specifies that a hazardous material be packaged under this section, only the following bulk packagings are author-

ized, subject to the requirements of subparts A and B of part 173 of this subchapter and the special provisions in column 7 of the § 172.101 table. On or after October 1, 1993, authorized packagings must meet all requirements in paragraph (g) of this section, unless otherwise excepted.

(a) *Rail cars*: Class DOT 103, 104, 105, 109, 111, 112, 114, 115, or 120 tank car tanks; Class DOT 106, 110 multi-unit tank car tanks; AAR Class 203W, 206W, 211W tank car tanks; and non-DOT specification tank car tanks equivalent in structural design and accident damage resistance to specification packagings.

(b) *Cargo tanks*: Specification MC 300, MC 301, MC 302, MC 303, MC 304, MC 305, MC 306, MC 307, MC 310, MC 311, MC 312, MC 330, MC 331 cargo tank motor vehicles; DOT 406, DOT 407, DOT 412 cargo tank motor vehicles; and non-DOT specification cargo tank motor vehicles equivalent in structural design and accident damage resistance to specification packagings. A non-DOT specification cargo tank motor vehicle constructed of carbon steel which is in elevated temperature material service is excepted from § 178.345-7(d)(5) of this subchapter.

(c) *Portable tanks*. DOT Specification 51, 56, 57 and 60 portable tanks; IM 101 and IM 102 portable tanks; UN portable tanks; marine portable tanks conforming to 46 CFR part 64; metal IBCs and non-specification portable tanks equivalent in structural design and accident damage resistance to specification packagings are authorized.

(d) *Crucibles*: Nonspecification crucibles designed and constructed such that the stress in the packaging does not exceed one fourth (0.25) of the ultimate strength of the packaging material at any temperature within the design temperature range. Stress is determined under a load equal to the sum of the static or working pressure in combination with the loads developed from accelerations and decelerations incident to normal transportation. For highway transportation, these forces are assumed to be "1.7g" vertical, "0.75g" longitudinal, and "0.4g" transverse, in reference to the axes of the transport vehicle. Each accelerative or

decelerative load may be considered separately.

(e) *Kettles*: A kettle, for the purpose of this section, is a bulk packaging (portable tank or cargo tank) having a capacity not greater than 5678 L (1500 gallons) with an integral heating apparatus used for melting various bituminous products such as asphalt. Kettles used for the transport of asphalt or bitumen are subject to the following requirements:

(1) *Low stability kettles*. Kettles with a ratio of track-width to fully loaded center of gravity (CG) height less than 2.5 must meet all requirements of paragraph (g) of this section (track-width is the distance measured between the outer edge of the kettle tires; CG height is measured perpendicular from the road surface).

(2) *High stability kettles*. (i) Kettles with a total capacity of less than 2650 L (700 gallons) and a ratio of track-width to fully loaded CG height of 2.5 or more are excepted from all requirements of paragraph (g)(2) of this section and the rollover protection requirements of paragraph (g)(6) of this section, if closures meet the requirements of paragraph (e)(2)(iii) of this section.

(ii) Kettles with a total capacity of 2650 L (700 gallons) or more and a ratio of track-width to fully loaded CG height of 2.5 or more are excepted from the “substantially leak tight” requirements of paragraph (g)(2) of this section and the rollover protection requirements of paragraph (g)(6) of this section if closures meet the requirements of paragraph (e)(2)(iii) of this section.

(iii) Closures must be securely closed during transportation. Closures also must be designed to prevent opening and the expulsion of lading in a rollover accident.

(f) *Other bulk packagings*: Bulk packagings, other than those specified in paragraphs (a) through (e) of this section, which are used for the transport of elevated temperature materials, must conform to all requirements of paragraph (g) of this section on or after October 1, 1993.

(g) *General requirements*. Bulk packagings authorized or used for transport of elevated temperature materials

must conform to the following requirements:

(1) *Pressure and vacuum control equipment*. When pressure or vacuum control equipment is required on a packaging authorized in this section, such equipment must be of a self-reclosing design, must prevent package rupture or collapse due to pressure, must prevent significant release of lading due to packaging overturn or splashing or surging during normal transport conditions, and may be external to the packaging.

(i) Pressure control equipment is not required if pressure in the packaging would increase less than 10 percent as a result of heating the lading from the lowest design operating temperature to a temperature likely to be encountered if the packaging were engulfed in a fire. When pressure control equipment is required, it must prevent rupture of the packaging from heating, including fire engulfment.

(ii) Vacuum control equipment is not required if the packaging is designed to withstand an external pressure of 100 kPa (14.5 psig) or if pressure in the packaging would decrease less than 10 percent as a result of the lading cooling from the highest design operating temperature to the lowest temperature incurred in transport. When vacuum control equipment is required, it must prevent collapse of the packaging from a cooling-induced pressure differential.

(iii) When the regulations require a reclosing pressure relief device, the lading must not render the devices inoperable (i.e. from clogging, freezing, or fouling). If the lading affects the proper operation of the device, the packaging must have:

(A) A safety relief device incorporating a frangible disc or a permanent opening, each having a maximum effective area of 22 cm² (3.4 in.²), for transportation by highway;

(B) For transportation of asphalt by highway, a safety relief device incorporating a frangible disc or a permanent opening, each having a maximum effective area of 48 cm² (7.4 in.²); or

(C) For transportation by rail, a non-reclosing pressure relief device incorporating a rupture disc conforming to the requirements of §179.15 of this subchapter.

(iv) Reclosing pressure relief devices, rupture discs or permanent openings must not allow the release of lading during normal transportation conditions (i.e., due to splashing or surging).

(2) *Closures.* All openings, except permanent vent openings authorized in paragraph (g)(1)(iii) of this section, must be securely closed during transportation. Packagings must be substantially leak-tight so as not to allow any more than dripping or trickling of a non-continuous flow when overturned. Closures must be designed and constructed to withstand, without exceeding the yield strength of the packaging, twice the static loading produced by the lading in any packaging orientation and at all operating temperatures.

(3) *Strength.* Each packaging must be designed and constructed to withstand, without exceeding the yield strength of the packaging, twice the static loading produced by the lading in any orientation and at all operating temperatures.

(4) *Compatibility.* The packaging and lading must be compatible over the entire operating temperature range.

(5) *Markings.* In addition to any other markings required by this subchapter, each packaging must be durably marked in a place readily accessible for inspection in characters at least 4.8 mm (3/16 inch) with the manufacturer's name, date of manufacture, design temperature range, and maximum product weight (or "load limit" for tank cars) or volumetric capacity.

(6) *Accident damage protection.* For transportation by highway, external loading and unloading valves and closures must be protected from impact damage resulting from collision or overturn. Spraying equipment and the road oil application portion of a packaging are excepted from this requirement.

(7) *New construction.* Specification packagings that are being manufactured for the transport of elevated temperature materials must be authorized for current construction.

(h) *Exceptions—(1) General.* Packagings manufactured for elevated temperature materials service prior to October 1, 1993, which are not in full compliance with the requirements in paragraph (g) of this section, may continue

in service if they meet the applicable requirements of subparts A and B of this part and meet the closure requirements in paragraph (g)(2) of this section by March 30, 1995.

(2) *Kettles.* Kettles in service prior to October 1, 1993, which are used to transport asphalt or bitumen, are excepted from specific provisions of this section as follows:

(i) Kettles with a total capacity of less than 2650 L (700 gallons), which are not in full compliance with the requirements of paragraph (g) of this section, may continue in elevated temperature material service if they meet the applicable requirements of subparts A and B of this part and if, after March 30, 1995, closures are secured during transport to resist opening in an overturn.

(ii) Kettles with a total capacity of 2650 L (700 gallons) or more, which are not in full compliance with the requirements of paragraph (g) of this section, may continue in elevated temperature material service if they meet the applicable requirements of subparts A and B of this part and if, after March 30, 1995, closures are secured during transport to resist opening in an overturn and no opening exceeds 46 cm² (7.1 in²).

(3) *Molten metals and molten glass.* This section does not apply to packagings used for transportation of molten metals and molten glass by rail when movement is restricted to operating speeds less than 15 miles per hour. (See §172.203(g)(3) of this subchapter for shipping paper requirements.)

(4) *Solid elevated temperature materials.* A material which meets the definition of a solid elevated temperature material is excepted from all requirements of this subchapter except §172.325 of this subchapter.

[Amdt. 173-227, 58 FR 3349, Jan. 8, 1993, as amended by Amdt. 173-234, 58 FR 51532, Oct. 1, 1993; 173-237, 59 FR 28493, June 2, 1994; 62 FR 51560, Oct. 1, 1997; 63 FR 52849, Oct. 1, 1998; 65 FR 50461, Aug. 18, 2000; 66 FR 33436, June 21, 2001; 66 FR 45382, Aug. 28, 2001; 67 FR 61013, Sept. 27, 2002]

§ 173.249 Bromine.

When §172.101 of this subchapter specifies that a hazardous material be

§ 173.300

packaged under this section, only the following bulk packagings are authorized, subject to the requirements of subparts A and B of part 173 of this subchapter and the special provisions specified in column 7 of the §172.101 table.

(a) Class DOT 105A300W or 105A500W tank cars. Class 105A500W tank cars may be equipped with manway cover plates, pressure relief valves, vent valves, and loading/unloading valves that are required on Class 105A-300W tank cars. Tank cars must conform to the requirements in paragraphs (a) through (g) of this section.

(b) Specification MC 310, MC 311, MC 312 or DOT 412 cargo tank motor vehicles conforming with paragraphs (d) through (f) of this section. Except when transported as a residue, the total quantity in one tank may not be less than 88 percent or more than 96 percent of the volume of the tank. Cargo tanks in bromine service built prior to August 31, 1991, may continue in service under the requirements contained in §173.252(a)(4) of this part in effect on September 30, 1991.

(c) UN portable tanks conforming to tank code T22 (see §172.102 of this subchapter) or specification IM 101 portable tanks conforming with paragraphs (d) through (f) of this section. Except when transported as a residue, the total quantity in one tank may not be less than 88% nor more than 92% of the volume of the tank.

(d) The tank must be made from nickel-clad or lead-lined steel plate. Nickel cladding or lead lining must be on the inside of the tank. Nickel cladding must comprise at least 20 percent of the required minimum total thickness. Nickel cladding must conform to ASTM B 162 (IBR, see §171.7 of this subchapter). Lead lining must be at least 4.763 mm (0.188 inch) thick. All tank equipment and appurtenances in contact with the lading must be lined or made from metal not subject to deterioration by contact with lading.

(e) Maximum filling density is 300 percent of the tank's water capacity. Minimum filling density is 287 percent of the tank's water capacity. Maximum water capacity is 9,253 kg (20,400 pounds) for DOT 105A300W tank cars. Maximum quantity of lading in DOT 105A300W tank cars is 27,216 kg (60,000

49 CFR Ch. I (10-1-14 Edition)

pounds). Maximum water capacity is 16,964 kg (37,400 pounds) for DOT 105A500W tank cars and DOT 105A500W tank cars equipped as described in paragraph (a) of this section. Maximum quantity of lading in DOT 105A500W tank cars is 49,895 kg (110,000 pounds).

(f) Tank shell and head thickness for cargo tank motor vehicles and portable tanks must be at least 9.5 mm (0.375 inch) excluding lead lining.

(g) Except as provided in §173.244(a)(3), tank cars built on or after March 16, 2009 and used for the transportation of bromine must meet the applicable authorized tank car specification listed in the table in §173.244(a)(2).

[Amdt. 173-224, 55 FR 52663, Dec. 21, 1990, as amended at 56 FR 66275, Dec. 20, 1991; 68 FR 75745, Dec. 31, 2003; 69 FR 76174, Dec. 20, 2004; 74 FR 1800, Jan. 13, 2009; 75 FR 5395, Feb. 2, 2010]

Subpart G—Gases; Preparation and Packaging

§ 173.300 [Reserved]

§ 173.301 General requirements for shipment of compressed gases and other hazardous materials in cylinders, UN pressure receptacles and spherical pressure vessels.

(a) *General qualifications for use of cylinders.* Unless otherwise stated, as used in this section, the term "cylinder" includes a UN pressure receptacle. As used in this subpart, filled or charged means an introduction or presence of a hazardous material in a cylinder. A cylinder filled with a Class 2 hazardous material (gas) and offered for transportation must meet the requirements in this section and §§173.301a through 173.305, as applicable.

(1) Compressed gases must be in UN pressure receptacles built in accordance with the UN standards or in metal cylinders and containers built in accordance with the DOT and ICC specifications and part 178 of this subchapter in effect at the time of manufacture, and requalified and marked as prescribed in subpart C in part 180 of this subchapter, if applicable. The DOT and ICC specifications authorized for use are as follows:

	Packagings
2P	4AA480
2Q	4B
ICC-3 ¹	4B240ET
3A	4BA
3AA	4BW
3AL	4D
3AX	4DA
3A480X	4DS
3AAX	4E
3B	4L
3BN	8
3E	8AL
3HT	39
3T	

(2) A cylinder must be filled in accordance with this part. Before each filling of a cylinder, the person filling the cylinder must visually inspect the outside of the cylinder. A cylinder that has a crack or leak, is bulged, has a defective valve or a leaking or defective pressure relief device, or bears evidence of physical abuse, fire or heat damage, or detrimental rusting or corrosion, may not be filled and offered for transportation. A cylinder may be repaired and requalified only as prescribed in subpart C of part 180 of this subchapter.

(3) Pressure relief devices must be tested for leaks before a filled cylinder is shipped from the cylinder filling plant. It is expressly forbidden to repair a leaking fusible plug device where the leak is through the fusible metal or between the fusible metal and the opening in the plug body, except by removal and replacement of the pressure relief device.

(4) A cylinder that previously contained a Class 8 material must be requalified in accordance with §180.205(e) of this subchapter.

(5) When a cylinder with a marked pressure limit is prescribed, another cylinder made under the same specification but with a higher marked pressure limit is authorized. For example, a cylinder marked "DOT-4B500" may be used when "DOT-4B300" is specified.

(6) No person may fill a cylinder overdue for periodic requalification with a hazardous material and then offer it for transportation. The prohibition against offering a cylinder for transportation that is overdue for periodic requalification does not apply to a

cylinder filled prior to the requalification due date.

(7) A cylinder with an authorized service life may not be offered for transportation in commerce after its authorized service life has expired. However, a cylinder in transportation or a cylinder filled prior to the expiration of its authorized service life may be transported for reprocessing or disposal of the cylinder's contents. After emptying, the cylinder must be condemned in accordance with §180.205 of this subchapter.

(8) The pressure of the hazardous material at 55 °C (131 °F) may not exceed $\frac{3}{4}$ of the service pressure of the cylinder. Sufficient outage must be provided so the cylinder will not be liquid full at 55 °C (131 °F).

(9) Specification 2P, 2Q, 3E, 3HT, spherical 4BA, 4D, 4DA, 4DS, and 39 cylinders must be packed in strong non-bulk outer packagings. The outside of the combination packaging must be marked with an indication that the inner packagings conform to the prescribed specifications.

(10) Any person who installs a valve into an aluminum cylinder in oxygen service must verify the valve and the cylinder have the same thread type.

(b) *Cylinder markings.* Required markings on a cylinder must be legible and must meet the applicable requirements of subpart C of part 180 of this subchapter. Additional information may be marked on the cylinder provided it does not affect the required markings prescribed in the applicable cylinder specification.

(c) *Toxic gases and mixtures.* Cylinders containing toxic gases and toxic gas mixtures meeting the criteria of Division 2.3 Hazard Zone A or B must conform to the requirements of §173.40 and CGA S-1.1 (compliance with paragraph 9.1.1.1 is not required) (IBR; see §171.7 of this subchapter) and CGA S-7 (IBR; see §171.7 of this subchapter). A DOT 39 cylinder, UN non-refillable cylinder, or a UN composite cylinder certified to ISO-11119-3 may not be used for a toxic gas or toxic gas mixture meeting the criteria for Division 2.3, Hazard Zone A or B.

(d) *Gases capable of combining chemically.* A filled cylinder may not contain

¹Use of existing cylinders is authorized. New construction is not authorized.

any gas or material capable of combining chemically with the cylinder's contents or with the cylinder's material of construction, so as to endanger the cylinder's serviceability.

(e) *Ownership of cylinder.* A cylinder filled with a hazardous material may not be offered for transportation unless it was filled by the owner of the cylinder or with the owner's consent.

(f) *Pressure relief device systems.* (1) Except as provided in paragraphs (f)(5) and (6) of this section, and §171.23(a)(5) of this subchapter, a cylinder filled with a gas and offered for transportation must be equipped with one or more pressure relief devices sized and selected as to type, location, and quantity, and tested in accordance with CGA S-1.1 (compliance with paragraph 9.1.1.1 is not required) and CGA S-7. The pressure relief device must be capable of preventing rupture of the normally filled cylinder when subjected to a fire test conducted in accordance with CGA C-14 (IBR, see §171.7 of this subchapter), or, in the case of an acetylene cylinder, CGA C-12 (IBR, see §171.7 of this subchapter).

(2) A pressure relief device, when installed, must be in communication with the vapor space of a cylinder containing a Division 2.1 (flammable gas) material.

(3) For a specification 3, 3A, 3AA, 3AL, 3AX, 3AXX, 3B, 3BN, or 3T cylinder filled with gases in other than Division 2.2 (except oxygen and oxidizing gases transported by aircraft, see §§173.302(f) and 173.304(f)), beginning with the first requalification due after December 31, 2003, the burst pressure of a CG-1, CG-4, or CG-5 pressure relief device must be at test pressure with a tolerance of plus zero to minus 10%. An additional 5% tolerance is allowed when a combined rupture disk is placed inside a holder. This requirement does not apply if a CG-2, CG-3, or CG-9 thermally activated relief device or a CG-7 reclosing pressure valve is used on the cylinder.

(4) A pressure relief device is required on a DOT 39 cylinder regardless of cylinder size or filled pressure. A DOT 39 cylinder used for liquefied Division 2.1 materials must be equipped with a metal pressure relief device. Fusible pressure relief devices are not author-

ized on a DOT 39 cylinder containing a liquefied gas.

(5) A pressure relief device is not required on—

(i) A cylinder 305 mm (12 inches) or less in length, exclusive of neck, and 114 mm (4.5 inches) or less in outside diameter, except when the cylinder is filled with a liquefied gas for which this part requires a service pressure of 1800 psig or higher or a nonliquefied gas to a pressure of 1800 psig or higher at 21 °C (70 °F);

(ii) A cylinder with a water capacity of less than 454 kg (1000 lbs) filled with a nonliquefied gas to a pressure of 300 psig or less at 21 °C (70 °F), except for a DOT 39 cylinder or a cylinder used for acetylene in solution; or

(iii) A cylinder containing a Class 3 or a Class 8 material without pressurization, unless otherwise specified for the hazardous material.

(iv) A UN pressure receptacle transported in accordance with paragraph (k) or (l) or this section.

(6) A pressure relief device is prohibited on a cylinder filled with a Division 2.3 or 6.1 material in Hazard Zone A.

(g) *Manifolding cylinders in transportation.* (1) Cylinder manifolding is authorized only under conditions prescribed in this paragraph (g). Manifolled cylinders must be supported and held together as a unit by structurally adequate means. Except for Division 2.2 materials, each cylinder must be equipped with an individual shutoff valve that must be tightly closed while in transit. Manifold branch lines must be sufficiently flexible to prevent damage to the valves that otherwise might result from the use of rigid branch lines. Each cylinder must be individually equipped with a pressure relief device as required in paragraph (f) of this section, except that pressure relief devices on manifolled horizontal cylinders that are mounted on a motor vehicle or framework may be selected as to type, location, and quantity according to the lowest marked pressure limit of an individual cylinder in the manifolled unit. The pressure relief devices selected for the manifolled unit must have been tested in accordance with CGA S-1.1 and CGA S-7. Pressure relief

devices on manifolded horizontal cylinders filled with a compressed gas must be arranged to discharge unobstructed to the open air. In addition, for Division 2.1 (flammable gas) material, the pressure relief devices (PRDs) must be arranged to discharge upward to prevent any escaping gas from contacting personnel or any adjacent cylinders. Valves and pressure relief devices on manifolded cylinders filled with a compressed gas must be protected from damage by framing, a cabinet or other method. Manifolding is authorized for cylinders containing the following gases:

(i) Nonliquefied (permanent) compressed gases authorized by §173.302.

(ii) Liquefied compressed gases authorized by §173.304. Each manifolded cylinder containing a liquefied compressed gas must be separately filled and means must be provided to ensure no interchange of cylinder contents can occur during transportation.

(iii) Acetylene as authorized by §173.303.

(2) For the checking of tare weights or replacing solvent, the cylinder must be removed from the manifold. This requirement is not intended to prohibit filling acetylene cylinders while manifolded.

(h) *Cylinder valve protection.* UN pressure receptacles must meet the valve protection requirements in §173.301b(c). A DOT specification cylinder used to transport a hazardous material must meet the requirements specified in this paragraph (h).

(1) The following specification cylinders are not subject to the cylinder valve protection requirements in this paragraph (h):

(i) A cylinder containing only a Division 2.2 material without a Division 5.1 subsidiary hazard;

(ii) A cylinder containing a Class 8 liquid corrosive only to metal;

(iii) A cylinder with a water capacity of 4.8 liters (293 in³) or less containing oxygen, compressed;

(iv) A cylinder containing oxygen, refrigerated liquid (cryogenic liquid);

(v) A Medical E cylinder with a water capacity of 4.9 liters (300 in³) or less;

(vi) A fire extinguisher; or

(vii) A "B" style cylinder with a capacity of 40 ft³ (1.13 m³) or an "MC"

style cylinder with a capacity of 10 ft³ (0.28m³) containing acetylene.

(2) For cylinders manufactured before October 1, 2007, a cylinder must have its valves protected by one of the following methods:

(i) By equipping the cylinder with securely attached metal caps of sufficient strength to protect valves from damage during transportation;

(ii) By boxing or crating the cylinders so as to protect valves from damage during transportation;

(iii) By constructing the cylinder so that the valve is recessed into the cylinder or otherwise protected to the extent that it will not be subjected to a blow when the container is dropped onto a flat surface; or

(iv) By loading the cylinders in an upright position and securely bracing the cylinders in rail cars or motor vehicles, when loaded by the consignor and unloaded by the consignee.

(3) For cylinders manufactured on or after October 1, 2007, each cylinder valve assembly must be of sufficient strength or protected such that no leakage occurs when a cylinder with the valve installed is dropped 1.8 m (6 ft.) or more onto a non-yielding surface, such as concrete or steel, impacting the valve assembly or protection device at an orientation most likely to cause damage. The cylinder valve assembly protection may be provided by any method meeting the performance requirement in this paragraph (h)(3). Examples include:

(i) Equipping the cylinder with a securely attached metal cap.

(ii) Packaging the cylinder in a box, crate, or other strong outer packaging conforming to the requirements of §173.25.

(iii) Constructing the cylinder such that the valve is recessed into the cylinder or otherwise protected.

(i) *Cylinders mounted in motor vehicles or in frames.* (1) MEGCs must conform to the requirements in §173.312. DOT specification cylinders mounted on motor vehicles or in frames must conform to the requirements specified in this paragraph (i).

(2) Seamless DOT specification cylinders longer than 2 m (6.5 feet) are authorized for transportation only when

§ 173.301a

49 CFR Ch. I (10–1–14 Edition)

horizontally mounted on a motor vehicle or in an ISO framework or other framework of equivalent structural integrity in accordance with CGA TB-25 (IBR, see §171.7 of this subchapter). The pressure relief device must be arranged to discharge unobstructed to the open air. In addition, for Division 2.1 (flammable gas) material, the pressure relief devices must be arranged to discharge upward to prevent any escaping gas from contacting personnel or any adjacent cylinders.

(3) Cylinders may not be transported by rail in container on freight car (COFC) or trailer on flat car (TOFC) service except under conditions approved by the Associate Administrator for Safety, Federal Railroad Administration.

(j) *Non-specification cylinders in domestic use.* Except as provided in §§171.12(a) and 171.23(a) of this subchapter, a filled cylinder manufactured to other than a DOT specification or a UN standard in accordance with part 178 of this subchapter, or a DOT exemption or special permit cylinder or a cylinder used as a fire extinguisher in conformance with §173.309(a), may not be transported to, from, or within the United States.

(k) *Metal attachments.* Metal attachments to cylinders must have rounded or chamfered corners, or be otherwise protected, so as to prevent the likelihood of causing puncture or damage to other hazardous materials packages. This requirement applies to anything temporarily or permanently attached to the cylinder, such as metal skids.

(l) *Cylinders made of aluminum alloy 6351-T6.* A DOT 3AL cylinder manufactured of aluminum alloy 6351-T6 may not be filled and offered for transportation or transported with pyrophoric gases. The use of UN cylinders manufactured of aluminum alloy 6351-T6 is prohibited.

[67 FR 51643, Aug. 8, 2002]

EDITORIAL NOTE: For FEDERAL REGISTER citations affecting § 173.301, see the List of CFR Sections Affected, which appears in the Finding Aids section of the printed volume and at www.fdsys.gov.

§ 173.301a Additional general requirements for shipment of specification cylinders.

(a) *General.* The requirements in this section are in addition to the requirements in §173.301 and apply to the shipment of gases in specification cylinders.

(b) *Authorized cylinders not marked with a service pressure.* For authorized cylinders not marked with a service pressure, the service pressure is designated as follows:

Specification marking	Service Pressure psig
3	1800
3E	1800
8	250

(c) *Cylinder pressure at 21 °C (70 °F).* The pressure in a cylinder at 21 °C (70 °F) may not exceed the service pressure for which the cylinder is marked or designated, except as provided in §173.302a(b). For certain liquefied gases, the pressure at 21 °C (70 °F) must be lower than the marked service pressure to avoid having a pressure at a temperature of 55 °C (131 °F) that is greater than permitted.

(d) *Cylinder pressure at 55 °C (131 °F).* The pressure in a cylinder at 55 °C (131 °F) may not exceed ¾ times the service pressure, except:

(1) For a cylinder filled with acetylene, liquefied nitrous oxide, or carbon dioxide.

(2) For a cylinder filled in accordance with §173.302a(b), the pressure in the cylinder at 55 °C (131 °F) may not exceed ¾ times the filling pressure.

(3) The pressure at 55 °C (131 °F) of Hazard Zone A and Hazard Zone B materials may not exceed the service pressure of the cylinder. Sufficient outage must be provided so that the cylinder will not be liquid full at 55 °C (131 °F).

(e) *Grandfather clause.* A cylinder in domestic use prior to the date on which the specification for the cylinder was first made effective may be used if the cylinder has been properly tested and

otherwise conforms to the requirements applicable to the gas with which it is charged.

[67 FR 51645, Aug. 8, 2002, as amended at 67 FR 61289, Sept. 30, 2002; 68 FR 24661, May 8, 2003; 76 FR 56317, Sept. 13, 2011]

§ 173.301b Additional general requirements for shipment of UN pressure receptacles.

(a) *General.* The requirements of this section are in addition to the requirements in § 173.301 and apply to the shipment of gases in UN pressure receptacles. A UN pressure receptacle, including closures, must conform to the design, construction, inspection and testing requirements specified in parts 178 and 180 of this subchapter, as applicable. Bundles of cylinders must conform to the requirements in § 178.70(e) of this subchapter.

(1) A UN pressure receptacle may not be filled and offered for transportation when damaged to such an extent that the integrity of the UN pressure receptacle or its service equipment may be affected. Prior to filling, the service equipment must be examined and found to be in good working condition (see § 178.70(d) of this subchapter). In addition, the required markings must be legible on the pressure receptacle.

(2) The gases or gas mixtures must be compatible with the UN pressure receptacle and valve materials as prescribed for metallic materials in ISO 11114-1 (IBR, see § 171.7 of this subchapter) and for non-metallic materials in ISO 11114-2 (IBR, see § 171.7 of this subchapter).

(3) A refillable UN pressure receptacle may not be filled with a gas or gas mixture different from that previously contained in the UN pressure receptacle unless the necessary operations for change of gas service have been performed in accordance with ISO 11621 (IBR, see § 171.7 of this subchapter).

(4) When a strong outer packaging is prescribed, for example as provided by paragraph (c)(2)(vi) or (d)(1) of this section, the UN pressure receptacles must be protected to prevent movement. Unless otherwise specified in this part, more than one UN pressure receptacle may be enclosed in the strong outer packaging.

(b) *Individual shut-off valves and pressure relief devices.* Except for Division 2.2 permanent gases, each UN pressure receptacle must be equipped with an individual shutoff valve that must be tightly closed while in transit. Each UN pressure receptacle must be individually equipped with a pressure relief device as prescribed by § 173.301(f), except that pressure relief devices on bundles of cylinders or manifolded horizontal cylinders must have a set-to-discharge pressure that is based on the lowest marked pressure of any cylinder in the bundle or manifolded unit.

(c) *Pressure receptacle valve requirements.* (1) When the use of a valve is prescribed, the valve must conform to the requirements in ISO 10297 (IBR, see § 171.7 of this subchapter).

(2) A UN pressure receptacle must have its valves protected from damage that could cause inadvertent release of the contents of the UN pressure receptacle by one of the following methods:

(i) By constructing the pressure receptacle so that the valves are recessed inside the neck of the UN pressure receptacle and protected by a threaded plug or cap;

(ii) By equipping the UN pressure receptacle with a valve cap conforming to the requirements in ISO 11117 and Technical Corrigendum 1 (IBR, see § 171.7 of this subchapter). The cap must have vent-holes of sufficient cross-sectional area to evacuate the gas if leakage occurs at the valve;

(iii) By protecting the valves by shrouds or guards conforming to the requirements in ISO 11117 (IBR; see § 171.7 of this subchapter). For metal hydride storage systems, by protecting the valves in accordance with the requirements in ISO 16111 (IBR; see § 171.7 of this subchapter).

(iv) By using valves designed and constructed with sufficient inherent strength to withstand damage in accordance with Annex B of ISO 10297;

(v) By enclosing the UN pressure receptacles in frames, e.g., bundles of cylinders; or

(vi) By packing the UN pressure receptacles in a strong outer package, such as a box or crate, capable of meeting the drop test specified in § 178.603 of this subchapter at the Packing Group I performance level.

(d) *Non-refillable UN pressure receptacles.* (1) When the use of a valve is prescribed, the valve must conform to the requirements in ISO 13340 (IBR, see § 171.7 of this subchapter);

(2) The receptacles must be transported as an inner package of a combination package;

(3) The receptacle must have a water capacity not exceeding 1.25 L when used for a flammable or toxic gas or 50 liters for receptacles used to contain chemical under pressure; and

(4) The receptacle is prohibited for Hazard Zone A material.

(e) *Pyrophoric gases.* A UN pressure receptacle must have valve outlets equipped with gas-tight plugs or caps when used for pyrophoric or flammable mixtures of gases containing more than 1% pyrophoric compounds. When UN pressure receptacles are manifolded in a bundle, each of the pressure receptacles must be equipped with an individual valve that must be closed while in transportation, and the outlet of the manifold valve must be equipped with a pressure retaining gas-tight plug or cap. Gas-tight plugs or caps must have threads that match those of the valve outlets.

(f) *Hydrogen bearing gases.* A steel UN pressure receptacle bearing an “H” mark must be used for hydrogen bearing gases or other embrittling gases that have the potential of causing hydrogen embrittlement.

(g) *Composite cylinders in underwater use.* A composite cylinder certified to ISO-11119-2 or ISO-11119-3 may not be used for underwater applications unless the cylinder is manufactured in accordance with the requirements for underwater use and is marked “UW” as prescribed in § 178.71(o)(17) of this subchapter.

[71 FR 33882, June 12, 2006, as amended at 71 FR 54395, Sept. 14, 2006; 76 FR 3380, Jan. 19, 2011; 78 FR 1091, Jan. 7, 2013; 78 FR 65485, Oct. 31, 2013]

§ 173.302 Filling of cylinders with non-liquefied (permanent) compressed gases.

(a) *General requirements.* A cylinder filled with a non-liquefied compressed gas (except gas in solution) must be offered for transportation in accordance with the requirements of this section

and § 173.301. In addition, a DOT specification cylinder must meet the requirements in §§ 173.301a, 173.302a and 173.305, as applicable. UN pressure receptacles must meet the requirements in §§ 173.301b and 173.302b, as applicable. Where more than one section applies to a cylinder, the most restrictive requirements must be followed.

(b) *Aluminum cylinders in oxygen service.* Each aluminum cylinder filled with oxygen must meet all of the following conditions:

(1) Metallic portions of a valve that may come into contact with the oxygen in the cylinder must be constructed of brass or stainless steel.

(2) Except for UN cylinders, each cylinder opening must be configured with straight threads only.

(3) Each UN pressure receptacle must be cleaned in accordance with the requirements of ISO 11621 (IBR, see § 171.7 of this subchapter). Each DOT cylinder must be cleaned in accordance with the requirements of GSA Federal Specification RR-C-901D, paragraphs 3.3.1 and 3.3.2 (IBR, see § 171.7 of this subchapter). Cleaning agents equivalent to those specified in Federal Specification RR-C-901D may be used provided they do not react with oxygen. One cylinder selected at random from a group of 200 or fewer and cleaned at the same time must be tested for oil contamination in accordance with Federal Specification RR-C-901D, paragraph 4.3.2, and meet the specified standard of cleanliness.

(4) The pressure in each cylinder may not exceed 3000 psig at 21 °C (70 °F).

(c) Notwithstanding the provisions of § 173.24(b)(1) and paragraph (f) of this section, an authorized cylinder containing oxygen continuously fed to tanks containing live fish may be offered for transportation and transported.

(d) Shipment of Division 2.1 materials in aluminum cylinders is authorized for transportation only by motor vehicle, rail car, or cargo-only aircraft.

(e) *DOT 3AL cylinders manufactured of 6351-T6 aluminum alloy.* Suitable safeguards should be provided to protect personnel and facilities should failure occur while filling cylinders manufactured of aluminum alloy 6351-T6 used in self-contained underwater breathing apparatus (SCUBA), self-contained

breathing apparatus (SCBA) or oxygen service. The cylinder filler should allow only those individuals essential to the filling process to be in the vicinity of the cylinder during the filling process.

(f) *Compressed oxygen and oxidizing gases by aircraft.* A cylinder containing oxygen, compressed; compressed gas, oxidizing, n.o.s.; or nitrogen trifluoride is authorized for transportation by aircraft only when it meets the following requirements:

(1) Only DOT specification 3A, 3AA, 3AL, 3E, 3HT, and 39 cylinders, and UN pressure receptacles ISO 9809-1, ISO 9809-2, ISO 9809-3 and ISO 7866 cylinders are authorized.

(2) Cylinders must be equipped with a pressure relief device in accordance with §173.301(f) and, for DOT 39 cylinders offered for transportation after October 1, 2008, for the other DOT specification cylinders with the first re-qualification due after October 1, 2008, or for the UN pressure receptacles prior to initial use:

(i) The rated burst pressure of a rupture disc for DOT 3A, 3AA, 3AL, 3E, and 39 cylinders, and UN pressure receptacles ISO 9809-1, ISO 9809-2, ISO 9809-3 and ISO 7866 cylinders must be 100% of the cylinder minimum test pressure with a tolerance of plus zero to minus 10%; and

(ii) The rated burst pressure of a rupture disc for a DOT 3HT cylinder must be 90% of the cylinder minimum test pressure with a tolerance of plus zero to minus 10%.

(3) The cylinder must be placed in a rigid outer packaging that—

(i) Conforms to the requirements of either part 178, subparts L and M of this subchapter at the Packing Group I or II performance level or the performance criteria in Air Transport Association (ATA) Specification No. 300 for a Category I Shipping Container;

(ii) Is capable of passing, as demonstrated by design testing, the Flame Penetration Resistance Test in appendix E to part 178 of this subchapter; and

(iii) Prior to each shipment, passes a visual inspection that verifies that all features of the packaging are in good condition, including all latches, hinges, seams, and other features, and that the packaging is free from perforations,

cracks, dents, or other abrasions that may negatively affect the flame penetration resistance and thermal resistance characteristics of the packaging.

(4) The cylinder and the outer packaging must be capable of passing, as demonstrated by design testing, the Thermal Resistance Test specified in appendix D to part 178 of this subchapter.

(5) The cylinder and the outer packaging must both be marked and labeled in accordance with part 172, subparts D and E of this subchapter. The additional marking “DOT31FP,” is allowed to indicate that the cylinder and the outer packaging are capable of passing, as demonstrated by design testing, the Thermal Resistance Test specified in appendix D to part 178 of this subchapter.

(6) A cylinder of compressed oxygen that has been furnished by an aircraft operator to a passenger in accordance with 14 CFR §121.574, §125.219, or §135.91 is excepted from the outer packaging requirements of paragraph (f)(3) of this section.

[67 FR 51646, Aug. 8, 2002, as amended at 67 FR 61289, Sept. 30, 2002; 68 FR 75745, Dec. 31, 2003; 71 FR 33883; June 12, 2006; 71 FR 51127, Aug. 29, 2006; 72 FR 55098, Sept. 28, 2007; 76 FR 56317, Sept. 13, 2011]

§ 173.302a Additional requirements for shipment of nonliquefied (permanent) compressed gases in specification cylinders.

(a) *Detailed filling requirements.* Nonliquefied compressed gases (except gas in solution) for which filling requirements are not specifically prescribed in §173.304a must be shipped subject to the requirements in this section and §§173.301, 173.301a, 173.302, and 173.305 in specification cylinders, as follows:

(1) DOT 3, 3A, 3AA, 3AL, 3B, 3E, 4B, 4BA and 4BW cylinders.

(2) DOT 3HT cylinders. These cylinders are authorized for aircraft use only and only for nonflammable gases. They have a maximum service life of 24 years from the date of manufacture. The cylinders must be equipped with frangible disc type pressure relief devices that meet the requirements of §173.301(f). Each frangible disc must

§ 173.302a

49 CFR Ch. I (10–1–14 Edition)

have a rated bursting pressure not exceeding 90 percent of the minimum required test pressure of the cylinder. Discs with fusible metal backing are not permitted. Specification 3HT cylinders may be offered for transportation only when packaged in accordance with §173.301(a)(9).

(3) DOT 39 DOT 39 cylinders. When the cylinder is filled with a Division 2.1 material, the internal volume of the cylinder may not exceed 1.23 L (75 in³) or 50 L (3050 in³) for chemical under pressure.

(4) DOT 3AX, 3AAX, and 3T cylinders are authorized for Division 2.1 and 2.2 materials and for carbon monoxide. DOT 3T cylinders are not authorized for hydrogen. When used in methane service, the methane must be a non-liquefied gas with a minimum purity of 98.0 percent methane and commercially free of corroding components.

(5) Aluminum cylinders manufactured in conformance with specifications DOT 39 and 3AL are authorized for oxygen only under the conditions specified in §173.302(b).

(b) *Special filling limits for DOT 3A, 3AX, 3AA, 3AAX, and 3T cylinders.* A DOT 3A, 3AX, 3AA, 3AAX, and 3T cylinder may be filled with a compressed gas, other than a liquefied, dissolved, Division 2.1, or Division 2.3 gas, to a pressure 10 percent in excess of its marked service pressure, provided:

(1) The cylinder is equipped with a frangible disc pressure relief device (without fusible metal backing) having a bursting pressure not exceeding the minimum prescribed test pressure.

(2) The cylinder's elastic expansion was determined at the time of the last test or retest by the water jacket method.

(3) Either the average wall stress or the maximum wall stress does not exceed the wall stress limitation shown in the following table:

Type of steel	Average wall stress limitation	Maximum wall stress limitation
I. Plain carbon steels over 0.35 carbon and medium manganese steels	53,000	58,000
II. Steels of analysis and heat treatment specified in spec. 3AA	67,000	73,000
III. Steels of analysis and heat treatment specified in spec. DOT-3T	87,000	94,000

Type of steel	Average wall stress limitation	Maximum wall stress limitation
IV. Plain carbon steels less than 0.35 carbon made prior to 1920	45,000	48,000

(i)(A) The average wall stress must be computed from the elastic expansion data using the following formula:

$$S = 1.7EE / KV - 0.4P$$

Where:

- S = wall stress, pounds per square inch;
- EE = elastic expansion (total less permanent) in cubic centimeters;
- K = factor $\times 10^{-7}$ experimentally determined for the particular type of cylinder being tested or derived in accordance with CGA C-5 (IBR, see §171.7 of this subchapter);
- V = internal volume in cubic centimeter (1 cubic inch = 16.387 cubic centimeters);
- P = test pressure, pounds per square inch.

(B) The formula in paragraph (b)(3)(i)(A) of this section is derived from the formula in paragraph (b)(3)(ii) of this section and the following:

$$EE = (PKVD^2) / (D^2 - d^2)$$

(ii) The maximum wall stress must be computed from the formula:

$$S = (P(1.3D^2 + 0.4d^2)) / (D^2 - d^2)$$

Where:

- S = wall stress, pounds per square inch;
- P = test pressure, pounds per square inch;
- D = outside diameter, inches;
- d = D-2t, where t=minimum wall thickness determined by a suitable method.

(iii) Compliance with average wall stress limitation may be determined by computing the elastic expansion rejection limit in accordance with CGA C-5, by reference to data tabulated in CGA C-5, or by the manufacturer's marked elastic expansion rejection limit (REE) on the cylinder.

(4) An external and internal visual examination made at the time of test or retest shows the cylinder to be free from excessive corrosion, pitting, or dangerous defects.

(5) A plus sign (+) is added following the test date marking on the cylinder to indicate compliance with paragraphs (b) (2), (b)(3), and (b)(4) of this section.

(c) *Carbon monoxide.* Carbon monoxide must be offered in a DOT 3, 3A,

3AX, 3AA, 3AAX, 3AL, 3E, or 3T cylinder having a minimum service pressure of 1800 psig. The pressure in a steel cylinder may not exceed 1000 psig at 21 °C (70 °F), except that if the gas is dry and sulfur free, the cylinder may be filled to $\frac{5}{6}$ of the cylinder's service pressure or 2000 psig, whichever is less. A DOT 3AL cylinder may be filled to its marked service pressure. A DOT 3AL cylinder is authorized only when transported by motor vehicle, rail car, or cargo-only aircraft.

(d) *Diborane and diborane mixtures.* Diborane and diborane mixed with compatible compressed gas must be offered in a DOT 3AL1800 or 3AA1800 cylinder. The maximum filling density of the diborane may not exceed 7 percent. Diborane mixed with compatible compressed gas may not have a pressure exceeding the service pressure of the cylinder if complete decomposition of the diborane occurs. Cylinder valve assemblies must be protected in accordance with §173.301(h).

(e) *Fluorine.* Fluorine must be shipped in specification 3A1000, 3AA1000, or 3BN400 cylinders without pressure relief devices and equipped with valve protection cap. The cylinder may not be charged to over 400 psig at 21 °C (70 °F) and may not contain over 2.7 kg (6 lbs) of gas.

[67 FR 51646, Aug. 8, 2002, as amended at 68 FR 75745, Dec. 31, 2003; 70 FR 34075, June 13, 2005; 71 FR 54395, Sept. 14, 2006; 72 FR 4455, Jan. 31, 2007; 72 FR 55098, Sept. 28, 2007; 78 FR 1091, Jan. 7, 2013]

§ 173.302b Additional requirements for shipment of non-liquefied (permanent) compressed gases in UN pressure receptacles.

(a) *General.* A cylinder filled with a non-liquefied gas must be offered for transportation in UN pressure receptacles subject to the requirements in this section and §173.302. In addition, the requirements in §§173.301 and 173.301b must be met.

(b) *UN pressure receptacles filling limits.* A UN pressure receptacle is authorized for the transportation of non-liquefied compressed gases as specified in this section. Except where filling limits are specifically prescribed in this section, the working pressure of a UN pressure receptacle may not exceed $\frac{2}{3}$

of the test pressure of the receptacle. Alternatively, the filling limits specified for non-liquefied gases in Table 1 of P200 of the UN Recommendations (IBR, see §171.7 of this subchapter) are authorized. In no case may the internal pressure at 65 °C (149 °F) exceed the test pressure.

(c) *Fluorine, compressed, UN 1045 and Oxygen difluoride, compressed, UN 2190.* Fluorine, compressed and Oxygen difluoride, compressed must be packaged in a UN pressure receptacle with a minimum test pressure of 200 bar and a maximum working pressure not to exceed 30 bar. A UN pressure receptacle made of aluminum alloy is not authorized. The maximum quantity of gas authorized in each UN pressure receptacle is 5 kg.

(d) *Diborane and diborane mixtures, UN 1911.* Diborane and diborane mixtures must be packaged in a UN pressure receptacle with a minimum test pressure of 250 bar and a maximum filling ratio dependent on the test pressure not to exceed 0.07. Filling should be further limited so that if complete decomposition of diborane occurs, the pressure of diborane or diborane mixtures will not exceed the working pressure of the cylinder. The use of UN tubes and MEGCs is not authorized.

(e) *Carbon monoxide, compressed UN 1016.* Carbon monoxide, compressed is authorized in UN pressure receptacles. The settled pressure in a steel pressure receptacle containing carbon monoxide may not exceed $\frac{1}{3}$ of the pressure receptacle's test pressure at 65 °C (149 °F) except, if the gas is dry and sulfur-free, the settled pressure may not exceed $\frac{1}{2}$ of the marked test pressure.

[71 FR 33883, June 12, 2006]

§ 173.303 Charging of cylinders with compressed gas in solution (acetylene).

(a) *Cylinder, filler and solvent requirements.* (Refer to applicable parts of Specification 8 and 8AL). Acetylene gas must be shipped in Specification 8 or 8AL cylinders (§178.59 or §178.60 of this subchapter). The cylinders shall consist of metal shells filled with a porous material, and this material must be charged with a suitable solvent. The cylinders containing the porous material and solvent shall be successfully

§ 173.304

tested in accordance with CGA C-12 (IBR, see §171.7 of this subchapter). Representative samples of cylinders charged with acetylene must be successfully tested in accordance with CGA C-12.

(b) *Filling limits.* For DOT specification cylinders, the pressure in the cylinder containing acetylene gas may not exceed 250 psig at 70 °F. If cylinders are marked for a lower allowable charging pressure at 70 °F., that pressure must not be exceeded. For UN cylinders, the pressure in the cylinder may not exceed the limits specified in §173.304b(b)(2).

(c) *Data requirements on filler and solvent.* Cylinders containing acetylene gas must not be shipped unless they were charged by or with the consent of the owner, and by a person, firm, or company having possession of complete information as to the nature of the porous filling, the kind and quantity of solvent in the cylinders, and the meaning of such markings on the cylinders as are prescribed by the Department's regulations and specifications applying to containers for the transportation of acetylene gas.

(d) *Verification of container pressure.* (1) Each day, the pressure in a container representative of that day's compression must be checked by the charging plant after the container has cooled to a settled temperature and a record of this test kept for at least 30 days.

(e) *Prefill requirements.* Before each filling of an acetylene cylinder, the person filling the cylinder must visually inspect the outside of the cylinder in accordance with the prefill requirements contained in CGA C-13, Section 3 (IBR, see §171.7 of this subchapter).

(f) *UN cylinders.* (1) UN cylinders and bundles of cylinders are authorized for the transport of acetylene gas as specified in this section. Each UN acetylene cylinder must conform to ISO 3807-2 (IBR, see §171.7 of this subchapter), have a homogeneous monolithic porous mass filler and be charged with acetone or a suitable solvent as specified in the standard. UN acetylene cylinders must have a minimum test pressure of 52 bar and may be filled up to the pressure limits specified in ISO 3807-2. The use

49 CFR Ch. I (10-1-14 Edition)

of UN tubes and MEGCs is not authorized.

(2) UN cylinders equipped with pressure relief devices or that are manifolded together must be transported upright.

[29 FR 18743, Dec. 29, 1964. Redesignated at 32 FR 5606, Apr. 5, 1967]

EDITORIAL NOTE: For FEDERAL REGISTER citations affecting §173.303, see the List of CFR Sections Affected, which appears in the Finding Aids section of the printed volume and at www.fdsys.gov.

§ 173.304 Filling of cylinders with liquefied compressed gases.

(a) *General requirements.* A cylinder filled with a liquefied compressed gas (except gas in solution) must be offered for transportation in accordance with the requirements of this section and the general requirements in §173.301. In addition, a DOT specification cylinder must meet the requirement in §§173.301a, 173.304a, and 173.305, as applicable. UN pressure receptacles must be shipped in accordance with the requirements in 173.301b and 173.304b, as applicable.

(1) A DOT 3AL cylinder may not be used for any material with a primary or subsidiary hazard of Class 8.

(2) Shipments of Division 2.1 materials in aluminum cylinders are authorized only when transported by motor vehicle, rail car, or cargo-only aircraft.

(b) *Filling limits.* Except for carbon dioxide; 1,1-Difluoroethylene (R-1132A); nitrous oxide; and vinyl fluoride, inhibited, the liquid portion of a liquefied gas may not completely fill the packaging at any temperature up to and including 55 °C (131 °F). The liquid portion of vinyl fluoride, inhibited, may completely fill the cylinder at 55 °C (131 °F) provided the pressure at the critical temperature does not exceed 1.25 times the service pressure of the cylinder.

(c) *Mixture of compressed gas and other material.* A mixture of compressed gas must be shipped in accordance with §173.305.

(d) *Refrigerant and dispersant gases.* Nontoxic and nonflammable refrigerant or dispersant gases must be offered for transportation in cylinders prescribed in §173.304a, or in DOT 2P

and 2Q containers (§§ 178.33, 178.33a of this subchapter). DOT 2P and 2Q containers must be packaged in a strong wooden or fiberboard box of such design as to protect valves from damage or accidental functioning under conditions incident to transportation. Pressure in the inside metal containers may not exceed 87 psia at 21 °C (70 °F). Each completed metal container filled for shipment must be heated until its contents reach a minimum temperature of 55 °C (131 °F) without evidence of leakage, distortion, or other defect. Each outside package must be plainly marked "INSIDE CONTAINERS COMPLY WITH PRESCRIBED SPECIFICATIONS".

(e) *Engine starting fluid.* Engine starting fluid containing a flammable compressed gas or gases must be shipped in a cylinder as prescribed in §173.304a or as follows:

(1) Inside non-refillable metal containers having a capacity not greater than 500 mL (32 in³). The containers must be packaged in strong, tight outer packagings. The pressure in the container may not exceed 145 psia at 54 °C (130 °F). If the pressure exceeds 145 psia at 54 °C (130 °F), a DOT 2P container must be used. In either case, the metal container must be capable of withstanding, without bursting, a pressure of 1.5 times the pressure of the contents at 54 °C (130 °F). The liquid content of the material and gas may not completely fill the container at 54 °C (130 °F). Each container filled for shipment must have been heated until its contents reach a minimum temperature of 54 °C (130 °F), without evidence of leakage, distortion, or other defect. Each outside shipping container must be plainly marked, "INSIDE CONTAINERS COMPLY WITH PRESCRIBED SPECIFICATIONS".

(2) [Reserved]

(f) *Oxidizing gases by aircraft.* A cylinder containing carbon dioxide and oxygen mixture, compressed; liquefied gas, oxidizing, n.o.s.; or nitrous oxide is authorized for transportation by aircraft only when it meets the following requirements:

(1) Only DOT specification 3A, 3AA, 3AL, 3E, 3HT, and 39 cylinders, and UN pressure receptacles ISO 9809-1, ISO

9809-2, ISO 9809-3 and ISO 7866 cylinders are authorized.

(2) Cylinders must be equipped with a pressure relief device in accordance with §173.301(f) and, for DOT 39 cylinders offered for transportation after October 1, 2008, for the other DOT specification cylinders with the first re-qualification due after October 1, 2008, or for the UN pressure receptacles prior to initial use:

(i) The rated burst pressure of a rupture disc for DOT 3A, 3AA, 3AL, 3E and 39 cylinders, and UN pressure receptacles ISO 9809-1, ISO 9809-2, ISO 9809-3 and ISO 7866 cylinders must be 100% of the cylinder minimum test pressure with a tolerance of plus zero to minus 10%; and

(ii) The rated burst pressure of a rupture disc for a DOT 3HT cylinder must be 90% of the cylinder minimum test pressure with a tolerance of plus zero to minus 10%.

(3) The cylinder must be placed in a rigid outer packaging that—

(i) Conforms to the requirements of either part 178, subparts L and M, of this subchapter at the Packing Group I or II performance level, or the performance criteria in Air Transport Association (ATA) Specification No. 300 for a Category I Shipping Container;

(ii) Is capable of passing, as demonstrated by design testing, the Flame Penetration Resistance Test in appendix E to part 178 of this subchapter; and

(iii) Prior to each shipment, passes a visual inspection that verifies that all features of the packaging are in good condition, including all latches, hinges, seams, and other features, and the packaging is free from perforations, cracks, dents, or other abrasions that may negatively affect the flame penetration resistance and thermal resistance characteristics of the container.

(4) The cylinder and the outer packaging must be capable of passing, as demonstrated by design testing, the Thermal Resistance Test specified in appendix D to part 178 of this subchapter.

(5) The cylinder and the outer packaging must both be marked and labeled in accordance with part 172, subparts D and E of this subchapter. The additional marking "DOT31FP," is allowed to indicate that the cylinder and the

§ 173.304a

49 CFR Ch. I (10–1–14 Edition)

outer packaging are capable of passing, as demonstrated by design testing, the Thermal Resistance Test specified in appendix D to part 178 of this subchapter.

(6) A cylinder of compressed oxygen that has been furnished by an aircraft operator to a passenger in accordance with 14 CFR 121.574, 125.219, or 135.91 is excepted from the outer packaging requirements of paragraph (f)(3) of this section.

[67 FR 51647, Aug. 8, 2002, as amended at 68 FR 24661, May 8, 2003; 71 FR 33883, June 12, 2006; 72 FR 55098, Sept. 28, 2007; 74 FR 53188, Oct. 16, 2009; 76 FR 56317, Sept. 13, 2011; 78 FR 60754, Oct. 2, 2013]

§ 173.304a Additional requirements for shipment of liquefied compressed gases in specification cylinders.

(a) *Detailed filling requirements.* Liquefied gases (except gas in solution) must be offered for transportation, subject to the requirements in this section and §§173.301 and 173.304, in specification cylinders, as follows:

(1) DOT 3, 3A, 3AA, 3AL, 3B, 3BN, 3E, 4B, 4BA, 4B240ET, 4BW, 4E, 39, except that no DOT 4E or 39 packaging may be filled and shipped with a mixture containing a pyrophoric liquid, carbon bisulfide (disulfide), ethyl chloride, ethylene oxide, nickel carbonyl, spirits of nitroglycerin, or toxic material (Division 6.1 or 2.3), unless specifically authorized in this part.

(2) For the gases named, the following requirements apply (for cryogenic liquids, see §173.316):

Kind of gas	Maximum permitted filling density (percent) (see Note 1)	Packaging marked as shown in this column or of the same type with higher service pressure must be used, except as provided in §§ 173.301(i), 173.301a(e), and 180.205(a) (see notes following table)
Anhydrous ammonia	54	DOT-3A480; DOT-3AA480; DOT-3A480X; DOT-4AA480; DOT-3; DOT-3E1800; DOT-3AL480.
Bromotrifluoromethane (R-13B1 or H-1301)	124	DOT-3A400; DOT-3AA400; DOT-3B400; DOT-4AA480; DOT-4B400; DOT-4BA400; DOT-4BW400; DOT-3E1800; DOT-39; DOT-3AL400.
Carbon dioxide (see Notes 4, 7, and 8)	68	DOT-3A1800; DOT-3AX1800; DOT-3AA1800; DOT-3AAX1800; DOT-3; DOT-3E1800; DOT-3T1800; DOT-3HT2000; DOT-39; DOT-3AL1800.
Carbon dioxide, refrigerated liquid (see paragraph (e) of this section).	DOT-4L.
Chlorine (see Note 2)	125	DOT-3A480; DOT-3AA480; DOT-3; DOT-3BN480; DOT-3E1800.
Chlorodifluoroethane or 1-Chloro-1, 1-difluoroethane (R-142b).	100	DOT-3A150; DOT-3AA150; DOT-3B150; DOT-4B150; DOT-4BA225; DOT-4BW225; DOT-3E1800; DOT-39; DOT-3AL150.
Chlorodifluoromethane (R-22) (see Note 8)	105	DOT-3A240; DOT-3AA240; DOT-3B240; DOT-4B240; DOT-4BA240; DOT-4BW240; DOT-4B240ET; DOT-4E240; DOT-39; DOT-3E1800; DOT-3AL240.
Chloropentafluoroethane (R-115)	110	DOT-3A225; DOT-3AA225; DOT-3B225; DOT-4BA225; DOT-4B225; DOT-4BW225; DOT-3E1800; DOT-39; DOT-3AL225.
Chlorotrifluoromethane (R-13) (see Note 8)	100	DOT-3A1800; DOT-3AA1800; DOT-3; DOT-3E1800; DOT-39; DOT-3AL1800.
Cyclopropane (see Note 8)	55	DOT-3A225; DOT-3A480X; DOT-3AA225; DOT-3B225; DOT-4AA480; DOT-4B225; DOT-4BA225; DOT-4BW225; DOT-4B240ET; DOT-3; DOT-3E1800; DOT-39; DOT-3AL225.
Dichlorodifluoromethane (R-12) (see Note 8)	119	DOT-3A225; DOT-3AA225; DOT-3B225; DOT-4B225; DOT-4BA225; DOT-4BW225; DOT-4B240ET; DOT-4E225; DOT-39; DOT-3E1800; DOT-3AL225.
Dichlorodifluoromethane and difluoroethane mixture (constant boiling mixture) (R-500) (see Note 8).	Not liquid full at 131 °F	DOT-3A240; DOT-3AA240; DOT-3B240; DOT-3E1800; DOT-4B240; DOT-4BA240; DOT-4BW240; DOT-4E240; DOT-39.
1,1-Difluoroethane (R-152a) (see note 8)	79	DOT-3A150; DOT-3AA150; DOT-3B150; DOT-4B150; DOT-4BA225; DOT-4BW225; DOT-3E1800; DOT-3AL150.

Pipeline and Haz. Matls. Safety Admin., DOT

§ 173.304a

Kind of gas	Maximum permitted filling density (percent) (see Note 1)	Packaging marked as shown in this column or of the same type with higher service pressure must be used, except as provided in §§ 173.301(l), 173.301a(e), and 180.205(a) (see notes following table)
1,1-Difluoroethylene (R-1132A)	73	DOT-3A2200; DOT-3AA2200; DOT-3AX2200; DOT-3AAX2200; DOT-3T2200; DOT-39.
Dimethylamine, anhydrous	59	DOT-3A150; DOT-3AA150; DOT-3B150; DOT-4B150; DOT-4BA225; DOT-4BW225; ICC-3E1800.
Ethane (see Note 8)	35.8	DOT-3A1800; DOT-3AX1800; DOT-3AA1800; DOT-3AAX1800; DOT-3; DOT-3E1800; DOT-3T1800; DOT-39; DOT-3AL1800.
Ethane (see Note 8)	36.8	DOT-3A2000; DOT-3AX2000; DOT-3AA2000; DOT-3AAX2000; DOT-3T2000; DOT-39; DOT-3AL2000.
Ethylene (see Note 8)	31.0	DOT-3A1800; DOT-3AX1800; DOT-3AA1800; DOT-3AAX1800; DOT-3; DOT-3E1800; DOT-3T1800; DOT-39; DOT-3AL1800.
Ethylene (see Note 8)	32.5	DOT-3A2000; DOT-3AX2000; DOT-3AA2000; DOT-3AAX2000; DOT-3T2000; DOT-39; DOT-3AL2000.
Ethylene (see Note 8)	35.5	DOT-3A2400; DOT-3AX2400; DOT-3AA2400; DOT-3AAX2400; DOT-3T2400; DOT-39; DOT-3AL2400.
Hydrogen chloride, anhydrous	65	DOT-3A1800; DOT-3AA1800; DOT-3AX1800; DOT-3AAX1800; DOT-3; DOT-3T1800; DOT-3E1800.
Hydrogen sulfide (see Notes 10 and 14)	62.5	DOT-3A; DOT-3AA; DOT-3B; DOT-4A; DOT-4B; DOT-4BA; DOT-4BW; DOT-3E1800; DOT-3AL.
Insecticide, gases liquefied (see Notes 8 and 12)	Not liquid full at 131 °F	DOT-3A300; DOT-3AA300; DOT-3B300; DOT-4B300; DOT-4BA300; DOT-4BW300; DOT-3E1800.
Liquefied nonflammable gases, other than classified flammable, corrosive, toxic & mixtures or solution thereof filled w/nitrogen, carbon dioxide, or air (see Notes 7 and 8)..	Not liquid full at 131 °F	Specification packaging authorized in paragraph (a)(1) of this section and DOT-3HT; DOT 4D; DOT-4DA; DOT-4DS.
Methyl acetylene-propadiene, mixtures, stabilized; (see Note 5)..	Not liquid at 131 °F	DOT-4B240 without brazed seams; DOT-4BA240 without brazed seams; DOT-3A240; DOT-3AA240; DOT-3B240; DOT-3E1800; DOT-4BW240; DOT-4E240; DOT-4B240ET; DOT-3AL240.
Methyl chloride	84	DOT-3A225; DOT-3AA225; DOT-3B225; DOT-4B225; DOT-4BA225; DOT-4BW225; DOT-3; DOT-3E1800; DOT-4B240ET. Cylinders complying with DOT-3A150; DOT-3B150; and DOT-4B150 manufactured prior to Dec. 7, 1936 are also authorized.
Methyl mercaptan	80	DOT-3A240; DOT-3AA240; DOT-3B240; DOT-4B240; DOT-4B240ET; DOT-3E1800; DOT-4BA240; DOT-4BW240.
Nitrosyl chloride	110	DOT-3BN400 only.
Nitrous oxide (see Notes 7, 8, and 11)	68	DOT-3A1800; DOT-3AX1800; DOT-3AA1800; DOT-3AAX1800; DOT-3; DOT-3E1800; DOT-3T1800; DOT-3HT2000; DOT-39; DOT-3AL1800.
Nitrous oxide, refrigerated liquid (see paragraph (e) of this section.)	DOT-4L.
Refrigerant gas, n.o.s. or Dispersant gas, n.o.s. (see Notes 8 and 13).	Not liquid full at 130 °F	DOT-3A240; DOT-3AA240; DOT-3B240; DOT-3E1800; DOT-4B240; DOT-4BA240; DOT-4BW240; DOT-4E240; DOT-39; DOT-3AL240.
Sulfur dioxide (see note 8)	125	DOT-3A225; DOT-3AA225; DOT-3B225; DOT-4B225; DOT-4BA225; DOT-4BW225; DOT-4B240ET; DOT-3; DOT-39; DOT-3E1800; DOT-3AL225.
Sulfur hexafluoride	120	DOT-3A1000; DOT-3AA1000; DOT-AAX2400; DOT-3; DOT-3AL1000; DOT-3E1800; DOT-3T1800.
Sulfuryl fluoride	106	DOT-3A480; DOT-3AA480; DOT-3E1800; DOT-4B480; DOT-4BA480; DOT-4BW480.
Tetrafluoroethylene, stabilized	90	DOT-3A1200; DOT-3AA1200; DOT-3E1800.
Trifluorochloroethylene, stabilized	115	DOT-3A300; DOT-3AA300; DOT-3B300; DOT-4B300; DOT-4BA300; DOT-4BW300; DOT-3E1800.

Kind of gas	Maximum permitted filling density (percent) (see Note 1)	Packaging marked as shown in this column or of the same type with higher service pressure must be used, except as provided in §§ 173.301(l), 173.301a(e), and 180.205(a) (see notes following table)
Trimethylamine, anhydrous	57	DOT-3A150; DOT-3AA150; DOT-3B150; DOT-4B150; DOT-4BA225; DOT-4BW225; DOT-3E1800.
Vinyl chloride (see Note 5)	84	DOT-4B150 without brazed seams; DOT-4BA225 without brazed seams; DOT-4BW225; DOT-3A150; DOT-3AA150; DOT-3E1800; DOT-3AL150.
Vinyl fluoride, stabilized	62	DOT-3A1800; DOT-3AA1800; DOT-3E1800; DOT-3AL1800.
Vinyl methyl ether, stabilized(see Note 5)	68	DOT-4B150, without brazed seams; DOT-4BA225 without brazed seams; DOT-4BW225; DOT-3A150; DOT-3AA150; DOT-3B1800; DOT-3E1800.

NOTE 1: "Filling density" means the percent ratio of the weight of gas in a packaging to the weight of water that the container will hold at 16 °C (60 °F). (1 lb of water=27.737 in³ at 60 °F.)

NOTE 2: Cylinders purchased after Oct. 1, 1944, for the transportation of chlorine must contain no aperture other than that provided in the neck of the cylinder for attachment of a valve equipped with an approved pressure relief device. Cylinders purchased after Nov. 1, 1935, and filled with chlorine may not contain over 68.04 kg (150 lb) of gas.

NOTE 3: [Reserved]

NOTE 4: Special carbon dioxide mining devices containing a heating element and filled with not over 2.72 kg (6 lb) of carbon dioxide may be filled to a density of not over 85 percent, provided the cylinder is made of steel with a calculated bursting pressure in excess of 39000 psig, fitted with a frangible disc that will operate at not over 57 percent of that pressure, and is able to withstand a drop of 10 feet when striking crosswise on a steel rail while under a pressure of at least 3000 psig. Such devices must be shipped in strong boxes or must be wrapped in heavy burlap and bound by 12-gauge wire with the wire completely covered by friction tape. Wrapping must be applied so as not to interfere with the functioning of the frangible disc pressure relief device. Shipments must be described as "liquefied carbon dioxide gas (mining device)" and marked, labeled, and certified as prescribed for liquefied carbon dioxide.

NOTE 5: All parts of valve and pressure relief devices in contact with contents of cylinders must be of a metal or other material, suitably treated if necessary, that will not cause formation of any acetylides.

NOTE 6: [Reserved]

NOTE 7: Specification 3HT cylinders for aircraft use only, having a maximum service life of 24 years. Authorized only for non-flammable gases. Cylinders must be equipped with pressure relief devices of the frangible disc type that meet the requirements of § 173.301(f). Each frangible disc must have a rated bursting pressure that does not exceed 90 percent of the minimum required test pressure of the cylinder. Discs with fusible metal backing are not permitted. Cylinders may be offered for transportation only when packaged in accordance with § 173.301(a)(9).

NOTE 8: See § 173.301(a)(9).

NOTE 9: [Reserved]

NOTE 10: Each valve outlet must be sealed by a threaded cap or a threaded solid plug.

NOTE 11: Must meet the valve and cleaning requirements in § 173.302(b).

NOTE 12: For an insecticide gas that is nontoxic and nonflammable, see § 173.305(c).

NOTE 13: For a refrigerant or dispersant gas that is nontoxic and nonflammable, see § 173.304(d).

NOTE 14: The use of DOT specification cylinder with a marked service pressure of 480 psi is authorized until December 31, 2003.

(b) [Reserved]

(c) *Verification of content in cylinder.*

Except as noted in paragraph (d)(4) of this section, the amount of liquefied gas filled into a cylinder must be by weight or, when the gas is lower in pressure than required for liquefaction, a pressure-temperature chart for the specific gas may be used to ensure that the service pressure at 55 °C (131 °F) will not exceed ¾ of the service pressure at 21 °C (70 °F). The weight of liquefied gas filled into the cylinder also must be checked, after disconnecting the cylinder from the filling line, by the use of an accurate scale.

(d) Requirements for liquefied petroleum gas. (1) Filling density limits are as follows:

Minimum specific gravity of liquid material at 60 °F	Maximum the filling density in percent of the water-weight capacity of the cylinder
0.271 to 0.289	26
0.290 to 0.306	27
0.307 to 0.322	28
0.323 to 0.338	29
0.339 to 0.354	30
0.355 to 0.371	31
0.372 to 0.398	32
0.399 to 0.425	33
0.426 to 0.440	34
0.441 to 0.452	35
0.453 to 0.462	36
0.463 to 0.472	37
0.473 to 0.480	38
0.481 to 0.488	39
0.489 to 0.495	40
0.496 to 0.503	41
0.504 to 0.510	42
0.511 to 0.519	43
0.520 to 0.527	44
0.528 to 0.536	45
0.537 to 0.544	46
0.545 to 0.552	47
0.553 to 0.560	48
0.561 to 0.568	49
0.569 to 0.576	50

Minimum specific gravity of liquid material at 60 °F	Maximum the filling density in percent of the water-weight capacity of the cylinder
0.577 to 0.584	51
0.585 to 0.592	52
0.593 to 0.600	53
0.601 to 0.608	54
0.609 to 0.617	55
0.618 to 0.626	56
0.627 to 0.634	57

(2) Subject to §173.301a(d), any filling density percentage prescribed in this section is authorized to be increased by a factor of 2 for liquefied petroleum gas in DOT 3 cylinders or in DOT 3A cyl-

inders marked for 1800 psig, or higher, service pressure.

(3) Liquefied petroleum gas must be shipped in specification cylinders as follows:

(i) DOT 3, 3A, 3AA, 3B, 3E, 3AL, 4B, 4BA, 4B240ET, 4BW, 4E, or 39 cylinders. Shipments of flammable gases in DOT 3AL cylinders are authorized only when transported by motor vehicle, rail car, or cargo-only aircraft.

(ii) Additional containers may be used within the limits of quantity and pressure as follows:

Type of container	Maximum capacity (cubic inches)	Maximum filling pressure (psig)
DOT-2P or DOT-2Q (see Note 1)	31.83	45 psig at 70 °F and 105 psig at 130 °F (see Note 2).
DOT-2P or DOT-2Q (see Note 1)	31.83	35 psig at 70 °F and 100 psig at 130 °F.

NOTE 1: Containers must be packed in strong wooden or fiber boxes of such design as to protect valves from damage or accidental functioning under conditions normally incident to transportation. Each completed container filled for shipment must have been heated until its contents reach a temperature of 54 °C (130 °F), without evidence of leakage, distortion, or other defect. Each outside shipping container must be plainly marked "INSIDE CONTAINERS COMPLY WITH PRESCRIBED SPECIFICATIONS".

NOTE 2: A container must be equipped with a pressure relief device that will prevent rupture of the container and dangerous projection of a closing device when exposed to fire.

(4) *Verification of content.* A cylinder with a water capacity of 90.72 kg (200 lb) or more and for use with a liquefied petroleum gas with a specific gravity of 0.504 or greater at 16 °C (60 °F) may have the quantity of its contents determined by using a fixed length dip tube gauging device. The length of the dip tube must be such that when a liquefied petroleum gas, with a specific volume of 0.03051 cu. ft./lb. at a temperature of 40 °F, is filled into the container, the liquid just reaches the bottom of the tube. The weight of this liquid may not exceed 42 percent of the water capacity of the container, which must be stamped on the cylinder. The length of the dip tube, expressed in inches carried out to one decimal place and prefixed with the letters "DT", must be stamped on the container and on the exterior of removable type dip tube. For the purpose of this requirement, the marked length must be expressed as the distance measured along the axis of a straight tube from the top of the boss through which the tube is inserted to the proper level of the liquid in the container. The length of each dip tube must be checked when installed by weighing each container after filling except when installed in

groups of substantially identical containers, in which case one of each 25 containers must be weighed. The quantity of liquefied gas in each container must be checked by means of the dip tube after disconnecting from the filling line. The outlet from the dip tube may not be larger than 0.1016 centimeters (0.040 inch; No. 54 drill bit size orifice). A container representative of each day's filling at each filling plant must have its contents checked by weighing after disconnecting from the filling line.

(e) *Carbon dioxide, refrigerated liquid or nitrous oxide, refrigerated liquid.* (1) The following provisions apply to carbon dioxide, refrigerated liquid, and nitrous oxide, refrigerated liquid:

(i) DOT 4L cylinders conforming to the provisions of this paragraph are authorized.

(ii) Each cylinder must be protected with at least one pressure relief device and at least one frangible disc conforming to §173.301(f) and paragraph (a)(2) of this section. The relieving capacity of the pressure relief device system must be equal to or greater than that calculated by the applicable formula in paragraph 5.8.3 of CGA S-1.1 (IBR, see §171.7 of this subchapter).

§ 173.304b

49 CFR Ch. I (10–1–14 Edition)

(iii) The temperature and pressure of the gas at the time the shipment is offered for transportation may not exceed –18 °C (0 °F) and 290 psig for carbon dioxide and –15.6 °C (+4 °F) and 290

psig for nitrous oxide. Maximum time in transit may not exceed 120 hours.

(2) The following pressure relief device settings, design service temperatures and filling densities apply:

Pressure relief device setting maximum start—to discharge gauge pressure in psig	Maximum permitted filling density (percent by weight)	
	Carbon dioxide, refrigerated liquid	Nitrous oxide, refrigerated liquid
105 psig	108	104
170 psig	105	101
230 psig	104	99
295 psig	102	97
360 psig	100	95
450 psig	98	83
540 psig	92	87
625 psig	86	80
Design service temperature °C (°F)	–196 °C (–320 °F)	–196 °C (–320 °F)

[67 FR 51647, Aug. 8, 2002, as amended at 68 FR 24661, May 8, 2003; 68 FR 57632, Oct. 6, 2003; 68 FR 75742, Dec. 31, 2003; 70 FR 34076, June 13, 2005; 72 FR 4456, Jan. 31, 2007; 72 FR 55098, Sept. 28, 2007; 73 FR 4719, Jan. 28, 2008]

EDITORIAL NOTE: At 70 FR 34076, June 13, 2005, §173.304a was amended in the table in paragraph (a)(2) by removing the phrase “DOT-4A480” from the entry “Hydrogen sulfide”; however, the amendment could not be incorporated because that phrase does not exist in the entry.

§ 173.304b Additional requirements for shipment of liquefied compressed gases in UN pressure receptacles.

(a) *General.* Liquefied gases and gas mixtures must be offered for transportation in UN pressure receptacles subject to the requirements in this section and §173.304. In addition, the general requirements applicable to UN pressure receptacles in §§173.301 and 173.301b must be met.

(b) *UN pressure receptacle filling limits.* A UN pressure receptacle is authorized for the transportation of liquefied compressed gases and gas mixtures as specified in this section. When a liquefied compressed gas or gas mixture is transported in a UN pressure receptacle, the filling ratio may not exceed the maximum filling ratio prescribed in this section and the applicable ISO standard. Compliance with the filling limits may be determined by referencing the numerical values and data in Table 2 of P200 of the UN Recommendations (IBR, see §171.7 of this subchapter). Alternatively, the maximum allowable filling limits may be determined as follows:

(1) For high pressure liquefied gases, in no case may the filling ratio of the settled pressure at 65 °C (149 °F) exceed

the test pressure of the UN pressure receptacle.

(2) For low pressure liquefied gases, the filling factor (maximum mass of contents per liter of water capacity) must be less than or equal to 95 percent of the liquid phase at 50 °C. In addition, the UN pressure receptacle may not be liquid full at 60 °C. The test pressure of the pressure receptacle must be equal to or greater than the vapor pressure of the liquid at 65 °C.

(3) For high pressure liquefied gases or gas mixtures, the maximum filling ratio may be determined using the formulas in (3)(b) of P200 of the UN Recommendations.

(4) For low pressure liquefied gases or gas mixtures, the maximum filling ratio may be determined using the formulas in (3)(c) of P200 of the UN Recommendations.

(c) Tetrafluoroethylene, stabilized, UN1081 must be packaged in a pressure receptacle with a minimum test pressure of 200 bar and a working pressure not exceeding 5 bar.

(d) Fertilizer ammoniating solution with free ammonia, UN1043 is not authorized in UN tubes or MEGCs.

[74 FR 2265, Jan. 14, 2009]

§ 173.305 Charging of cylinders with a mixture of compressed gas and other material.

(a) *Detailed requirements.* A mixture of a compressed gas and any other material must be shipped as a compressed gas if the mixture is a compressed gas as designated in §173.115 and when not in violation of §173.301(a).

(b) *Filling limits.* (See §173.301.) For mixtures, the liquid portion of the liquefied compressed gas at 131 °F. plus any additional liquid or solid must not completely fill the container.

(c) *Nonpoisonous and nonflammable mixtures.* Mixtures containing compressed gas or gases including insecticides, which mixtures are nonpoisonous and nonflammable under this part must be shipped in cylinders as prescribed in §173.304(a) or as follows:

(1) Specification 2P (§173.33 of this subchapter). Inside metal containers equipped with safety relief devices of a type examined by the Bureau of Explosives and approved by the Associate Administrator, and packed in strong wooden or fiber boxes of such design as to protect valves from damage or accidental functioning under conditions incident to transportation. Pressure in the container may not exceed 85 psia at 70 °F. Each completed metal container filled for shipment must be heated until content reaches a minimum temperature of 130 °F., without evidence of leakage, distortion or other defect. Each outside shipping container must be plainly marked "INSIDE CONTAINERS COMPLY WITH PRESCRIBED SPECIFICATIONS."

(2) [Reserved]

(d) *Poisonous mixtures.* A mixture containing any poisonous material (Division 6.1 or 2.3) in such proportions that the mixture would be classed as poisonous under §173.115 or §173.132 must be shipped in packagings as authorized for these poisonous materials.

[29 FR 18743, Dec. 29, 1964. Redesignated at 32 FR 5606, Apr. 5, 1967, and amended by Amdt. 173-70, 38 FR 5309, Feb. 27, 1973, Amdt. 173-94, 41 FR 16079, Apr. 15, 1976; 45 FR 32697, May 19, 1980; Amdt. 173-224, 56 FR 66275, 66279, Dec. 20, 1991; 66 FR 45379, Aug. 28, 2001; 67 FR 61013, Sept. 27, 2002; 67 FR 51651, Aug. 8, 2002; 68 FR 24662, May 8, 2003]

§ 173.306 Limited quantities of compressed gases.

(a) Limited quantities of compressed gases for which exceptions are permitted as noted by reference to this section in §172.101 of this subchapter are excepted from labeling, except when offered for transportation or transported by air, and, unless required as a condition of the exception, specification packaging requirements of this subchapter when packaged in accordance with the following paragraphs. For transportation by aircraft, the package must conform to the applicable requirements of §173.27 of this subchapter and only packages of hazardous materials authorized aboard passenger-carrying aircraft may be transported as a limited quantity. In addition, shipments are not subject to subpart F (Placarding) of part 172 of this subchapter, to part 174 of this subchapter except §174.24, and to part 177 of this subchapter except §177.817. Each package may not exceed 30 kg (66 pounds) gross weight.

(1) When in containers of not more than 4 fluid ounces capacity (7.22 cubic inches or less) except cigarette lighters. Additional exceptions for certain compressed gases in limited quantities and the ORM-D hazard class are provided in paragraph (i) of this section.

(2) When in metal containers filled with a material that is not classed as a hazardous material to not more than 90 percent of capacity at 70 °F. and then charged with nonflammable, nonliquefied gas. Each container must be tested to three times the pressure at 70 °F. and, when refilled, be retested to three times the pressure of the gas at 70 °F. Also, one of the following conditions must be met:

(i) Container is not over 0.95 L (1 quart) capacity and charged to not more than 11.17 bar (482.63 kPa, 170 psig) at 21 °C (70 °F), and must be packed in a strong outer packaging, or

(ii) Container is not over 30 gallons capacity and charged to not more than 75 psig at 70 °F.

(3) When in a metal container for the sole purpose of expelling a nonpoisonous (other than a Division 6.1 Packing Group III material) liquid, paste or powder, provided all of the following

§ 173.306

49 CFR Ch. I (10–1–14 Edition)

conditions are met. Additional exceptions for certain compressed gases in limited quantities and the ORM-D hazard class are provided in paragraph (i) of this section.

(i) Capacity must not exceed 1 L (61.0 cubic inches).

(ii) Pressure in the container must not exceed 180 psig at 130 °F. If the pressure exceeds 140 psig at 130 °F., but does not exceed 160 psig at 130 °F., a specification DOT 2P (§178.33 of this subchapter) inside metal container must be used; if the pressure exceeds 160 psig at 130 °F., a specification DOT 2Q (§178.33a of this subchapter) inside metal container must be used. In any event, the metal container must be capable of withstanding without bursting a pressure of one and one-half times the equilibrium pressure of the content at 130 °F.

(iii) Liquid content of the material and gas must not completely fill the container at 130 °F.

(iv) The container must be packed in strong outside packagings.

(v) Each container, after it is filled, must be subjected to a test performed in a hot water bath; the temperature of the bath and the duration of the test must be such that the internal pressure reaches that which would be reached at 55 °C (131 °F) (50 °C (122 °F) if the liquid phase does not exceed 95% of the capacity of the container at 50 °C (122 °F)). If the contents are sensitive to heat, the temperature of the bath must be set at between 20 °C (68 °F) and 30 °C (86 °F) but, in addition, one container in 2,000 must be tested at the higher temperature. No leakage or permanent deformation of a container may occur.

(vi) Each outside packaging must be marked "INSIDE CONTAINERS COMPLY WITH PRESCRIBED REGULATIONS."

(4) Gas samples must be transported under the following conditions:

(i) A gas sample may only be transported as non-pressurized gas when its pressure corresponding to ambient atmospheric pressure in the container is not more than 105 kPa absolute (15.22 psia).

(ii) Non-pressurized gases, toxic (or toxic and flammable) must be packed in hermetically sealed glass or metal inner packagings of not more than one

L (0.3 gallons) overpacked in a strong outer packaging.

(iii) Non-pressurized gases, flammable must be packed in hermetically sealed glass or metal inner packagings of not more than 5 L (1.3 gallons) and overpacked in a strong outer packaging.

(5) For limited quantities of Division 2.2 gases with no subsidiary risk, when in a plastic container for the sole purpose of expelling a liquid, paste or powder, provided all of the following conditions are met. Additional exceptions for certain compressed gases in limited quantities and the ORM-D hazard class are provided in paragraph (i) of this section.

(i) Capacity must not exceed 1 L (61.0 cubic inches).

(ii) Pressure in the container must not exceed 160 psig at 130 °F. If the pressure in the container is less than 140 psig at 130 °F, a non-DOT specification container may be used. If the pressure in the container exceeds 140 psig at 130 °F but does not exceed 160 psig at 130 °F, the container must conform to specification DOT 2S. All non-DOT specification and specification DOT 2S containers must be capable of withstanding, without bursting, a pressure of one and one-half times the equilibrium pressure of the contents at 130 °F.

(iii) Liquid content of the material and gas must not completely fill the container at 130 °F.

(iv) The container must be packed in strong outside packagings.

(v) Except as provided in paragraph (a)(5)(vi) of this section, each container must be subjected to a test performed in a hot water bath; the temperature of the bath and the duration of the test must be such that the internal pressure reaches that which would be reached at 55 °C (131 °F) or 50 °C (122 °F) if the liquid phase does not exceed 95% of the capacity of the container at 50 °C (122 °F). If the contents are sensitive to heat, or if the container is made of plastic material which softens at this test temperature, the temperature of the bath must be set at between 20 °C (68 °F) and 30 °C (86 °F) but, in addition, one container in 2,000 must be tested at the higher temperature. No leakage or permanent deformation of a container

may occur except that a plastic container may be deformed through softening provided that it does not leak.

(vi) As an alternative to the hot water bath test in paragraph (a)(5)(v) of this section, testing may be performed as follows:

(A) *Pressure and leak testing before filling.* Each empty container must be subjected to a pressure equal to or in excess of the maximum expected in the filled containers at 55 °C (131 °F) (or 50 °C (122 °F) if the liquid phase does not exceed 95 percent of the capacity of the container at 50 °C (122 °F). This must be at least two-thirds of the design pressure of the container. If any container shows evidence of leakage at a rate equal to or greater than 3.3×10^{-2} mbar L/s at the test pressure, distortion or other defect, it must be rejected; and

(B) *Testing after filling.* Prior to filling, the filler must ensure that the crimping equipment is set appropriately and the specified propellant is used before filling the container. Once filled, each container must be weighed and leak tested. The leak detection equipment must be sufficiently sensitive to detect at least a leak rate of 2.0×10^{-3} mbar L/s at 20 °C (68 °F). Any filled container which shows evidence of leakage, deformation, or excessive weight must be rejected.

(vi) Each outside packaging must be marked "INSIDE CONTAINERS COMPLY WITH PRESCRIBED REGULATIONS."

(b) *Exceptions for foodstuffs, soap, biologicals, electronic tubes, and audible fire alarm systems.* Limited quantities of compressed gases (except Division 2.3 gases) for which exceptions are provided as indicated by reference to this section in §172.101 of this subchapter, when accordance with one of the following paragraphs, are excepted from labeling, except when offered for transportation or transported by aircraft, and the specification packaging requirements of this subchapter. For transportation by aircraft, the package must conform to the applicable requirements of §173.27 of this subchapter and only packages of hazardous materials authorized aboard passenger-carrying aircraft may be transported as a limited quantity. In addition, ship-

ments are not subject to subpart F (Placarding) of part 172 of this subchapter, to part 174 of this subchapter, except §174.24, and to part 177 of this subchapter, except §177.817. Additional exceptions for certain compressed gases in limited quantities and the ORM-D hazard class are provided in paragraph (i) of this section.

(1) Foodstuffs or soaps in a nonrefillable metal or plastic container not exceeding 1 L (61.0 cubic inches), with soluble or emulsified compressed gas, provided the pressure in the container does not exceed 140 psig at 130 °F. Plastic containers must only contain Division 2.2 non-flammable soluble or emulsified compressed gas. The metal or plastic container must be capable of withstanding, without bursting, a pressure of one and one-half times the equilibrium pressure of the contents at 130 °F.

(i) Containers must be packed in strong outside packagings.

(ii) Liquid content of the material and the gas must not completely fill the container at 130 °F.

(iii) Each outside packaging must be marked "INSIDE CONTAINERS COMPLY WITH PRESCRIBED REGULATIONS."

(2) Cream in refillable metal or plastic containers with soluble or emulsified compressed gas. Plastic containers must only contain Division 2.2 non-flammable soluble or emulsified compressed gas. Containers must be of such design that they will hold pressure without permanent deformation up to 375 psig and must be equipped with a device designed so as to release pressure without bursting of the container or dangerous projection of its parts at higher pressures. This exception applies to shipments offered for transportation by refrigerated motor vehicles only.

(3) Nonrefillable metal or plastic containers charged with a Division 6.1 Packing Group III or nonflammable solution containing biological products or a medical preparation which could be deteriorated by heat, and compressed gas or gases. Plastic containers must only contain 2.2 non-flammable soluble or emulsified compressed gas. The capacity of each container may not exceed 35 cubic inches (19.3 fluid

ounces). The pressure in the container may not exceed 140 psig at 130 °F, and the liquid content of the product and gas must not completely fill the containers at 130 °F. One completed container out of each lot of 500 or less, filled for shipment, must be heated, until the pressure in the container is equivalent to equilibrium pressure of the contents at 130 °F. There must be no evidence of leakage, distortion, or other defect. The container must be packed in strong outside packagings.

(4) Electronic tubes, each having a volume of not more than 30 cubic inches and charged with gas to a pressure of not more than 35 psig and packed in strong outside packagings.

(5) Audible fire alarm systems powered by a compressed gas contained in an inside metal container when shipped under the following conditions:

(i) Each inside container must have contents which are not flammable, poisonous, or corrosive as defined under this part,

(ii) Each inside container may not have a capacity exceeding 35 cubic inches (19.3 fluid ounces),

(iii) Each inside container may not have a pressure exceeding 70 psig at 70 °F. and the liquid portion of the gas may not completely fill the inside container at 130 °F., and

(iv) Each nonrefillable inside container must be designed and fabricated with a burst pressure of not less than four times its charged pressure at 130 °F. Each refillable inside container must be designed and fabricated with a burst pressure of not less than five times its charged pressure at 130 °F.

(c)–(d) [Reserved]

(e) *Refrigerating machines.* (1) New (unused) refrigerating machines or components thereof are excepted from the specification packaging requirements of this part if they meet the following conditions. In addition, shipments are not subject to subpart F of part 172 of this subchapter, to part 174 of this subchapter except §174.24 and to part 177 of this subchapter except §177.817.

(i) Each pressure vessel may not contain more than 5,000 pounds of Group A1 refrigerant as classified in ANSI/ASHRAE Standard 15 or not more than

50 pounds of refrigerant other than Group A1.

(ii) Machines or components having two or more charged vessels may not contain an aggregate of more than 2,000 pounds of Group I refrigerant or more than 100 pounds of refrigerant other than Group I.

(iii) Each pressure vessel must be equipped with a safety device meeting the requirements of ANSI/ASHRAE 15 (IBR, see §171.7 of this subchapter).

(iv) Each pressure vessel must be equipped with a shut-off valve at each opening except openings used for safety devices and with no other connection. These valves must be closed prior to and during transportation.

(v) Pressure vessels must be manufactured, inspected and tested in accordance with ANSI/ASHRAE 15, or when over 6 inches internal diameter, in accordance with Section VIII of the ASME Code (IBR, see §171.7 of this subchapter).

(vi) All parts subject to refrigerant pressure during shipment must be tested in accordance with ANSI/ASHRAE 15.

(vii) The liquid portion of the refrigerant, if any, may not completely fill any pressure vessel at 130 °F.

(viii) The amount of refrigerant, if liquefied, may not exceed the filling density prescribed in §173.304.

(f) *Accumulators (Articles, pressurized pneumatic or hydraulic containing non-flammable gas).* The following applies to accumulators, which are hydraulic accumulators containing nonliquefied, nonflammable gas, and nonflammable liquids or pneumatic accumulators containing nonliquefied, nonflammable gas, fabricated from materials which will not fragment upon rupture.

(1) Accumulators installed in motor vehicles, construction equipment, and assembled machinery and designed and fabricated with a burst pressure of not less than five times their charged pressure at 70 °F., when shipped, are not subject to the requirements of this subchapter.

(2) Accumulators charged with limited quantities of compressed gas to not more than 200 p.s.i.g. at 70 °F. are excepted from labeling (except when offered for transportation by air) and the specification packaging requirements

of this subchapter when shipped under the following conditions. In addition, shipments are not subject to subpart F of part 172 of this subchapter, to part 174 of this subchapter except §174.24 and to part 177 of this subchapter except §177.817.

(i) Each accumulator must be shipped as an inside packaging,

(ii) Each accumulator may not have a gas space exceeding 2,500 cubic inches under stored pressure, and

(iii) Each accumulator must be tested, without evidence of failure or damage, to at least three times its charged pressure of 70 °F., but not less than 120 p.s.i. before initial shipment and before each refilling and reshipment.

(3) Accumulators with a charging pressure exceeding 200 p.s.i.g. at 70 °F. are excepted from labeling (except when offered for transportation by air) and the specification packaging requirements of this subchapter when shipped under the following conditions:

(i) Each accumulator must be in compliance with the requirements stated in paragraph (f)(2), (i), (ii), and (iii) of this section, and

(ii) Each accumulator must be designed and fabricated with a burst pressure of not less than five times its charged pressure at 70 °F. when shipped.

(4) Accumulators intended to function as shock absorbers, struts, gas springs, pneumatic springs or other impact or energy-absorbing devices are not subject to the requirements of this subchapter provided each:

(i) Has a gas space capacity not exceeding 1.6 L and a charge pressure not exceeding 280 bar, where the product of the capacity expressed in liters and charge pressure expressed in bars does not exceed 80 (for example, 0.5 L gas space and 160 bar charge pressure);

(ii) Has a minimum burst pressure of 4 times the charge pressure at 20 °C for products not exceeding 0.5 L gas space capacity and 5 times the charge pressure for products greater than 0.5 L gas space capacity;

(iii) Design type has been subjected to a fire test demonstrating that the article relieves its pressure by means of a fire degradable seal or other pressure relief device, such that the article

will not fragment and that the article does not rocket; and

(iv) Accumulators must be manufactured under a written quality assurance program which monitors parameters controlling burst strength, burst mode and performance in a fire situation as specified in paragraphs (f)(4)(i) through (f)(4)(iii) of this section. A copy of the quality assurance program must be maintained at each facility at which the accumulators are manufactured.

(5) Accumulators not conforming to the provisions of paragraphs (f)(1) through (f) (4) of this section, may only be transported subject to the approval of the Associate Administrator.

(g) *Water pump system tank.* Water pump system tanks charged with compressed air or limited quantities of nitrogen to not over 40 psig for single-trip shipment to installation sites are excepted from labeling (transportation by air not authorized) and the specification packaging requirements of this subchapter when shipped under the following conditions. In addition, shipments are not subject to subpart F of this subchapter, to part 174 of this subchapter except §174.24 and part 177 except §177.817.

(1) The tank must be of steel, welded with heads concave to pressure, having a rated water capacity not exceeding 120 gallons and with outside diameter not exceeding 24 inches. Safety relief devices not required.

(2) The tank must be pneumatically tested to 100 psig. Test pressure must be permanently marked on the tank.

(3) The stress at prescribed pressure must not exceed 20,000 psi using formula:

$$S = Pd / 2t$$

where:

S = wall stress in psi;

P = prescribed pressure for the tank of at least 3 times charged pressure at 70 °F or 100 psig, whichever is greater;

d = inside diameter in inches;

t = minimum wall thickness, in inches.

(4) The burst pressure must be at least 6 times the charge pressure at 70 °F.

(5) Each tank must be overpacked in a strong outer packaging in accordance with §173.301(h).

(h) *Lighter refills.* (1) Lighter refills (see §171.8 of this subchapter) must not contain an ignition element but must contain a release device. Lighter refills offered for transportation under this section may not exceed 4 fluid ounces capacity (7.22 cubic inches) or contain more than 65 grams of a Division 2.1 fuel. For transportation by highway or rail, lighter refills must be tightly packed and secured against movement in strong outer packagings. For transportation by aircraft or vessel, lighter refills must be tightly packed and secured against movement in any rigid specification outer packaging authorized in subpart L of part 178 of this subchapter at the Packing Group II performance level.

(2) *Exceptions.* (i) For other than transportation by aircraft, exceptions for certain compressed gases in limited quantities and the ORM–D hazard class are provided in paragraph (i) of this section.

(ii) For highway transportation, when no more than 1,500 lighter refills covered by this paragraph are transported in one motor vehicle, the requirements of subparts C through H of part 172, and part 177 of this subchapter do not apply. Lighter refills covered under this paragraph must be packaged in rigid, strong outer packagings meeting the general packaging requirements of subpart B of this part. Outer packagings must be plainly and durably marked on two opposing sides or ends with the words “LIGHTER REFILLS” and the number of devices contained therein in letters measuring at least 20 mm (0.79 in) in height. No person may offer for transportation or transport the lighter refills or prepare the lighter refills for shipment unless that person has been specifically informed of the requirements of this section.

(i) *Limited quantities.* (1) A limited quantity that conforms to the provisions of paragraph (a)(1), (a)(3), (a)(5), (b) or, except for transportation by aircraft, paragraph (h) of this section is excepted from labeling requirements, unless the material is offered for transportation or transported by aircraft, and the specification packaging requirements of this subchapter when packaged in combination packagings

according to this paragraph. Packages must be marked in accordance with §172.315(a) or (b), as appropriate, or as authorized in paragraph (i)(2) of this section. Unless otherwise specified in paragraph (i)(2) of this section, packages of limited quantities intended for transportation by aircraft must conform to the applicable requirements (*e.g.*, authorized materials, inner packaging quantity limits and closure securement) of §173.27 of this part. A limited quantity package that conforms to the provisions of this section is not subject to the shipping paper requirements of subpart C of part 172 of this subchapter, unless the material meets the definition of a hazardous substance, hazardous waste, marine pollutant, or is offered for transportation and transported by aircraft or vessel, and is eligible for the exceptions provided in §173.156 of this part. Outside packagings conforming to this paragraph are not required to be marked “INSIDE CONTAINERS COMPLY WITH PRESCRIBED REGULATIONS.” In addition, packages of limited quantities are not subject to subpart F (Placarding) of part 172 of this subchapter. Each package must conform to the packaging requirements of subpart B of this part and may not exceed 30 kg (66 pounds) gross weight.

(2) *Consumer commodities.* Until December 31, 2020, a limited quantity package containing a “consumer commodity” as defined in §171.8 of this subchapter may be renamed “Consumer commodity” and reclassified as ORM–D or, until December 31, 2012, as ORM–D–AIR material and offered for transportation and transported in accordance with the applicable provisions of this subchapter in effect on October 1, 2010.

(j) *Aerosols and receptacles small, containing gas with a capacity of less than 50 mL.* Aerosols, as defined in §171.8 of this subchapter, and receptacles, small, containing gas, with a capacity not exceeding 50 mL (1.7 fluid oz.) and with a pressure not exceeding 970 kPa (141 psig) at 55 °C (131 °F), containing no hazardous materials other than a Division 2.2 gas, are not subject to the requirements of this subchapter except that for transport by aircraft, such aerosols and receptacles must be transported as cargo and may not be carried

onboard an aircraft by passengers or crewmembers in carry-on baggage, checked baggage, or on their person unless specifically excepted by §175.10. The pressure limit may be increased to 2,000 kPa (290 psig) at 55 °C (131 °F) provided the aerosols are transported in outer packages that conform to the packaging requirements of Subpart B of this part. This paragraph (j) does not apply to a self-defense spray (e.g., pepper spray).

(k) *Aerosols for recycling or disposal.* Aerosols, as defined in §171.8 of this subchapter, containing a limited quantity which conforms to the provisions of paragraph (a)(3), (a)(5), (b)(1), (b)(2), or (b)(3) of this section are not subject to the 30 kg (66 pounds) gross weight limitation when transported by motor vehicle for purposes of recycling or disposal under the following conditions:

(1) The strong outer packaging and its contents must not exceed a gross weight of 500 kg (1,100 pounds);

(2) Each aerosol container must be secured with a cap to protect the valve stem or the valve stem must be removed; and

(3) The packaging must be offered for transportation or transported by—

(i) Private or contract motor carrier; or

(ii) Common carrier in a motor vehicle under exclusive use for such service.

(1) For additional exceptions, see §173.307.

[Amdt. 173-94, 41 FR 16079, Apr. 15, 1976]

EDITORIAL NOTE: For FEDERAL REGISTER citations affecting §173.306, see the List of CFR Sections Affected, which appears in the Finding Aids section of the printed volume and at www.fdsys.gov.

§ 173.307 Exceptions for compressed gases.

(a) The following materials are not subject to the requirements of this subchapter:

(1) Carbonated beverages.

(2) Tires when inflated to pressures not greater than their rated inflation pressures. For transportation by air, tires and tire assemblies must meet the conditions in §175.8(b)(4) of this subchapter.

(3) Balls used for sports.

(4) Refrigerating machines, including dehumidifiers and air conditioners, and components thereof, such as precharged tubing containing:

(i) 12 kg (25 pounds) or less of a non-flammable, non-toxic gas;

(ii) 12 L (3 gallons) or less of ammonia solution (UN2672);

(iii) Except when offered or transported by air, 12 kg (25 pounds) or less of a flammable, non-toxic gas;

(iv) Except when offered or transported by air or vessel, 20 kg (44 pounds) or less of a Group A1 refrigerant specified in ANSI/ASHRAE Standard 15 (IBR, see §171.7 of this subchapter); or

(v) 100 g (4 ounces) or less of a flammable, non-toxic liquefied gas.

(5) Manufactured articles or apparatuses, each containing not more than 100 mg (0.0035 ounce) of inert gas and packaged so that the quantity of inert gas per package does not exceed 1 g (0.35 ounce).

(6) Light bulbs, provided they are packaged so that the projectile effects of any rupture of the bulb will be contained within the package.

(b) [Reserved]

[Amdt. 173-94, 41 FR 16081, Apr. 15, 1976, as amended by Amdt. 173-135, 45 FR 13090, Feb. 28, 1980; 65 FR 50462, Aug. 18, 2000; 68 FR 45038, July 31, 2003; 68 FR 75745, Dec. 31, 2003; 69 FR 76174, Dec. 20, 2004; 71 FR 14604, Mar. 22, 2006; 74 FR 2266, Jan. 14, 2009; 76 FR 3380, Jan. 19, 2011]

§ 173.308 Lighters.

(a) *General requirements.* No person may offer for transportation or transport a lighter (see §171.8 of this subchapter) containing a Division 2.1 (flammable gas) material except under the following conditions:

(1) The lighter must contain a fuel reservoir not exceeding 4 fluid ounces capacity (7.22 cubic inches), and must contain not more than 10 grams (0.35 ounce) of flammable gas.

(2) The maximum filling density may not exceed 85 percent of the volumetric capacity of each fluid reservoir at 15 °C (59 °F).

(3) Each lighter design, including closures, must be capable of withstanding, without leakage or rupture, an internal

pressure of at least two times the pressure of the flammable gas at 55 °C (131 °F).

(4) Each appropriate lighter design must be examined and successfully tested by a person or agency (authorized testing agency) who is authorized by the Associate Administrator to perform such examination and testing under the provisions of subpart E of part 107 of this chapter and who—

(i) Has the equipment necessary to perform the testing required to the level of accuracy required;

(ii) Is able to demonstrate, upon request, the knowledge of the testing procedures and requirements of the HMR relative to lighters;

(iii) Does not manufacture or market lighters, is not financially dependent or owned in whole or in part, by any entity that manufactures or markets lighters;

(iv) Is a resident of the United States; and

(v) Performs all examination and testing in accordance with the requirements of paragraph (b)(3) and (4) of this section.

(5) The Associate Administrator will assign an identification code to each person who is authorized to examine and test lighters. This identification code must be incorporated into a unique test report identifier for each successfully tested lighter design.

(b) *Examination and testing of lighter design types*—(1) *Lighter design type definition.* A new lighter design is one that has never been examined and tested or one that differs from a previous design in any manner that may affect the escape (leakage) of gas. Lighter characteristics that may affect the escape of gas include changes in materials of construction, ignition mechanism, burner valve design, wall thickness, sealing materials, and type of fuel (e.g., vapor pressure differences).

(2) *Lighter samples submitted for examination and testing.* Samples of a new lighter design are excepted from the requirements of (a)(4) and (d) of this section and may be offered for transportation and transported under the following conditions:

(i) The samples must be transported only to an authorized testing agency;

(ii) No more than 12 lighters may be packaged in a single outer packaging;

(iii) Inner packagings must conform to the requirements of paragraph (c)(1) of this section. For transportation by aircraft, intermediate or outer packagings must meet the pressure differential requirements of §173.27(c) of this part;

(iv) The outer packaging must conform to the requirements of subpart M of part 178 of this subchapter at the Packing Group I performance level and to the requirements of §173.24 of this subpart;

(v) The word “sample” must appear on the shipping paper as part of the proper shipping name or in association with the basic description; and

(vi) In addition to other required markings and labels, the package must be marked “SAMPLE FOR EXAMINATION AND TESTING.”

(vii) All other applicable requirements of this subchapter must be met.

(3) *Examination and testing of sample lighters by an authorized testing agency.* Each sample lighter must be examined for conformance with paragraph (a) of this section by a person authorized by the Associate Administrator. In addition, lighters must be subjected to the following leakage test:

(i) A minimum of six lighters must be examined and tested at one time. Store the lighters in a desiccator for 24 hours. After drying, weigh each lighter on an analytical balance capable of accurately measuring to within $\frac{1}{10}$ of a milligram (0.0001 grams).

(ii) After weighing, place the lighters together in an explosion-proof, controlled-temperature laboratory oven capable of maintaining 38 ± 1 °C (100 ± 2 °F) for 96 continuous hours (4 days). At the end of 96 hours, remove the lighters from the oven and place them in the same desiccator and allow the lighters to cool to ambient temperature.

(iii) After cooling, weigh each lighter and determine the net weight differences for each lighter tested (subtract the mass after oven exposure from the original mass before oven exposure).

(iv) Weight losses must be assessed to determine the quantity of gas that leaked from the lighters and from the weight change as a result of absorbed

moisture. If the net weight has increased, the test facility must run the required test using six empty lighters in parallel with the six filled lighters. The parallel tests are conducted to determine the weight of moisture absorbed in the plastic in order to determine the weight loss of the lighters from gas leakage.

(v) If the net weight loss for any one of the six lighters exceeds 20 milligrams (0.020 grams), the design must be rejected.

(vi) Lighters manufactured to a rejected lighter design may not be offered for transportation or transported in commerce unless approved in writing by the Associate Administrator.

(4) *Recordkeeping requirements.* (i) Following the examination of each new lighter design, the person or agency that conducted the examination and test must prepare a test report and make that test report available to the manufacturer. At a minimum, the test report must contain the following information:

(A) Name and address of test facility;

(B) Name and address of applicant;

(C) A test report identifier, that is, the authorized person or agency identifier code immediately followed by an alpha/numeric identifier of four or more characters assigned to the specific lighter design by the authorized person or agency (e.g., "LAA****," where, "LAA" is the identification code assigned to the authorized person or agency by the Associate Administrator and "****" is replaced with the unique test report identifier assigned to the specific lighter design by the authorized person or agency);

(D) Manufacturer of the lighter. For a foreign manufacturer, the U.S. agent or importer must be identified;

(E) Description of the lighter design type (e.g., model, dimensions, ignition mechanism, reservoir capacity, lot/batch number) in sufficient detail to ensure conformance with paragraph (b)(4)(iii) of this section; and

(F) A certification by the authorized testing agency that the lighter design conforms to paragraph (a) of this section and passes or does not pass the required leakage test in paragraph (b) of this section.

(ii) For as long as any lighter design is in production and for at least three years thereafter, a copy of each lighter's test report must be maintained by the authorized testing agency that performed the examination and testing and the manufacturer of the design. For a foreign manufacturer, each test report must be maintained in accordance with this paragraph by the foreign manufacturer's U.S. agent or importer.

(iii) Test reports must be traceable to a specific lighter design and must be made available to a representative of the Department upon request.

(5) *Transitional provisions.* Until January 1, 2012, approval numbers issued by the Associate Administrator prior to January 1, 2007 may continue to be marked on packages and annotated on shipping papers, where applicable. After that time, previously issued approvals (i.e., T-***) will no longer be valid and each lighter design currently in production must be re-examined and tested under the provisions of this section.

(c) *Packaging requirements*—(1) *Inner containment.* Lighters must be placed in an inner packaging that is designed to prevent movement of the lighters and inadvertent ignition or leakage. The ignition device and gas control lever of each lighter must be designed, or securely sealed, taped, or otherwise fastened or packaged to protect against accidental functioning or leakage of the contents during transport. If lighters are packed vertically in a plastic tray, a plastic, fiberboard or paperboard partition must be used to prevent friction between the ignition device and the inner packaging.

(2) *Outer packaging.* Lighters and their inner packagings must be tightly packed and secured against movement in any rigid specification outer packaging authorized in subpart L of part 178 of this subchapter at the Packing Group II performance level.

(d) *Shipping paper and marking requirements.* (1) In addition to the requirements of subpart C of part 172, shipping papers must be annotated with the lighter design test report identifier (see paragraph (b)(4)(i)(C) of this section) traceable to the test report assigned to the lighters or, if applicable, the previously issued approval

§ 173.309

49 CFR Ch. I (10–1–14 Edition)

number (*i.e.*, T***), in association with the basic description.

(2) In addition to the requirements of subpart D of part 172, a lighter design test report identifier (see paragraph (b)(4)(i)(C) of this section) or, if applicable, the previously issued approval number (*i.e.*, T***), must be marked on a package containing lighters.

(3) For transportation by vessel in a closed transport vehicle or a closed freight container, the following warning must be affixed to the access doors:

WARNING—MAY CONTAIN EXPLOSIVE MIXTURES WITH AIR—KEEP IGNITION SOURCES AWAY WHEN OPENING

The warning must be on a contrasting background and must be in letters measuring at least 12.7 mm (0.5 inch) in height.

(e) *Exceptions*—(1) *Common or contract carriage*. For highway transportation by common or contract carrier, when no more than 1,500 lighters covered by this section are transported in one motor vehicle, the requirements of subparts C through H of part 172, and part 177 of this subchapter do not apply. Lighters transported in accordance with this paragraph are also excepted from the specification packaging, shipping paper, and marking requirements specified in §173.308(c) and (d). Inner packagings must conform to paragraph (c)(1) of this section. Lighters must be further packaged in rigid, strong outer packagings meeting the general packaging requirements of subpart B of part 173. Outer packagings must be plainly and durably marked, on two opposing sides or ends, with the word “LIGHTERS” and the number of devices contained therein in letters measuring at least 20 mm (0.79 in) in height. In addition, the package must include the test report identifier for each lighter design as specified in paragraph (b)(4)(i)(C) of this section or, if applicable, the previously issued approval number (*i.e.*, T***). The test report identifier or approval number must be durable, legible, in English, and located in, attached to, or marked directly on the package. No person may offer for transportation or transport the lighters or prepare the lighters for shipment unless that person has been specifically

informed of the requirements of this section.

(2) *Private carriage*. For highway transportation by a private carrier, lighters that have been examined and successfully tested in accordance with this section are not subject to any other requirements of this subchapter under the following conditions:

(i) No person may offer for transportation or transport the lighters or prepare the lighters for shipment unless that person has been specifically informed of the requirements of this section;

(ii) Lighters must be placed in an inner packaging that is designed to prevent accidental activation of the ignition device or valve, release of gas, and movement of the lighters (*e.g.*, tray, blister pack, etc.);

(iii) Inner packagings must be placed in a securely closed rigid outer packaging that limits movement of the inner packagings and protects them from damage;

(iv) The outer package may contain not more than 300 lighters;

(v) A transport vehicle may carry not more than 1,500 lighters at any one time;

(vi) The lighters may not be placed in an outer packaging with other hazardous materials; and

(vii) Outer packagings must be plainly and durably marked with the words “LIGHTERS, excepted quantity.”

[71 FR 3427, Jan. 23, 2006, as amended at 73 FR 57006, Oct. 1, 2008]

§ 173.309 Fire extinguishers.

(a) Specification 3A, 3AA, 3E, 3AL, 4B, 4BA, 4B240ET or 4BW (§§178.36, 178.37, 178.42, 178.46, 178.50, 178.51, 178.55 and 178.61 of this subchapter) cylinders are authorized for manufacture and use as fire extinguishers under the following conditions:

(1) Extinguishing agents must be nonflammable, non-poisonous, non-corrosive, and commercially free from corroding components;

(2) Each fire extinguisher must be charged with a nonflammable, non-poisonous, dry gas that has a dew-point at or below minus 46.7 °C (minus 52 °F) at 101 kPa (1 atmosphere) and is free of corroding components, to not more

than the service pressure of the cylinder;

(3) A fire extinguisher may not contain more than 30% carbon dioxide by volume or any other corrosive extinguishing agent; and

(4) Each fire extinguisher must be protected externally by suitable corrosion-resisting coating.

(5) Specification 3E and 4BA cylinders must be packed in strong non-bulk outer packagings. The outside of the combination packaging must be marked with an indication that the inner packagings conform to the prescribed specifications.

(b) Specification 2P or 2Q (§§178.33 and 178.33a of this subchapter) inner non-refillable metal packagings are authorized as fire extinguishers subject to the following conditions:

(1) Extinguishing agents must be nonflammable, non-poisonous, and non-corrosive as defined in this subchapter;

(2) The liquid portion of the gas plus any additional liquid or solid may not completely fill the packaging at 55 °C (130 °F);

(3) Pressure in the packaging must not exceed 1250 kPa (181 psig) at 55 °C (130 °F). If the pressure exceeds 920 kPa (141 psig) at 55 °C (130 °F), but does not exceed 1100 kPa (160 psig) at 55 °C (130 °F), a specification DOT 2P inner metal packaging must be used; if the pressure exceeds 1100 kPa (160 psig) at 55 °C (130 °F), a specification DOT 2Q inner metal packaging must be used. The metal packaging must be capable of withstanding, without bursting, a pressure of one and one-half times the equilibrium pressure of the contents at 55 °C (130 °F);

(4) Each completed inner packaging filled for shipment must have been heated until the pressure in the container is equivalent to the equilibrium pressure of the contents at 55 °C (130 °F) without evidence of leakage, distortion, or other defect; and

(5) Specification 2P and 2Q cylinders must be packed in strong non-bulk outer packagings. The outside of the combination packaging must be marked with an indication that the inner packagings conform to the prescribed specifications.

(c) Non-specification cylinders are authorized as fire extinguishers subject to the following conditions:

(1) Extinguishing agents must be nonflammable, non-poisonous, and non-corrosive as defined in this subchapter;

(2) The internal volume of each cylinder may not exceed 18 L (1,100 cubic inches). For fire extinguishers not exceeding 900 mL (55 cubic inches) capacity, the liquid portion of the gas plus any additional liquid or solid must not completely fill the container at 55 °C (130 °F). Fire extinguishers exceeding 900 mL (55 cubic inches) capacity may not contain any liquefied compressed gas;

(3) Each fire extinguisher manufactured on and after January 1, 1976, must be designed and fabricated with a burst pressure of not less than six times its charged pressure at 21 °C (70 °F) when shipped;

(4) Each fire extinguisher must be tested, without evidence of failure or damage, to at least three times its charged pressure at 21 °C (70 °F) but not less than 825 kPa (120 psig) before initial shipment, and must be marked to indicate the year of the test (within 90 days of the actual date of the original test) and with the words "MEETS DOT REQUIREMENTS." This marking is considered a certification that the fire extinguisher is manufactured in accordance with the requirements of this section. The words "This extinguisher meets all requirements of 49 CFR 173.306" may be displayed on fire extinguishers manufactured prior to January 1, 1976;

(5) Each non-specification fire extinguisher must be packaged as an inner packaging within a combination outer packaging. Examples of acceptable outer packagings for non-specification fire extinguishers include large cartons, racks, cages or other suitable enclosures; and

(6) For any subsequent shipment, each fire extinguisher must be in compliance with the retest requirements of the Occupational Safety and Health Administration Regulations of the Department of Labor, 29 CFR 1910.157.

(d) Limited quantities: Fire extinguishers otherwise conforming to paragraph (a), (b), or (c) of this section and are charged with a limited quantity of

§ 173.310

compressed gas to not more than 1660 kPa (241 psig) at 21 °C (70 °F) are excepted from shipping papers (except when offered for transportation by aircraft or vessel), labeling (except when offered for transportation by aircraft), placarding, the specification packaging requirements of this subchapter, and are eligible for the exceptions provided in §173.156 when offered for transportation in accordance with this paragraph (d). Limited quantity shipments conforming to this paragraph are not subject to parts 174 and 177 of this subchapter when transported by highway or rail. In addition, limited quantity packages of fire extinguishers are subject to the following conditions, as applicable:

(1) Extinguishing agents must be nonflammable, non-poisonous, and non-corrosive as defined in this subchapter; and

(2) Packages must be marked as specified for limited quantities in §172.315 of this subchapter.

[78 FR 1116, Jan. 7, 2013]

§ 173.310 Exceptions for radiation detectors.

Radiation detectors, radiation sensors, electron tube devices, or ionization chambers, herein referred to as "radiation detectors," that contain only Division 2.2 gases, are excepted from the specification packaging in this subchapter and, except when transported by air, from labeling and placarding requirements of this subchapter when designed, packaged, and transported as follows:

(a) Radiation detectors must be single-trip, hermetically sealed, welded metal inside containers that will not fragment upon impact.

(b) Radiation detectors must not have a design pressure exceeding 4.83 MPa (700 psig) and a capacity exceeding 355 fluid ounces (641 cubic inches). They must be designed and fabricated with a burst pressure of not less than three times the design pressure if the radiation detector is equipped with a pressure relief device, and not less than four times the design pressure if the detector is not equipped with a pressure relief device.

(c) Radiation detectors must be shipped in a strong outer packaging ca-

49 CFR Ch. I (10–1–14 Edition)

pable of withstanding a drop test of at least 1.2 meters (4 feet) without breakage of the radiation detector or rupture of the outer packaging. If the radiation detector is shipped as part of other equipment, the equipment must be packaged in strong outer packaging or the equipment itself must provide an equivalent level of protection.

(d) Emergency response information accompanying each shipment and available from each emergency response telephone number for radiation detectors must identify those receptacles that are not fitted with a pressure relief device and provide appropriate guidance for exposure to fire.

[75 FR 27215, May 14, 2010]

§ 173.311 Metal hydride storage systems.

The following packing instruction is applicable to transportable UN Metal hydride storage systems (UN3468) with pressure receptacles not exceeding 150 liters (40 gallons) in water capacity and having a maximum developed pressure not exceeding 25 MPa. Metal hydride storage systems must be designed, constructed, initially inspected and tested in accordance with ISO 16111 (IBR, see §171.7 of this subchapter) as authorized under §178.71(m) of this subchapter. Steel pressure receptacles or composite pressure receptacles with steel liners must be marked in accordance with §173.301b(f) of this part which specifies that a steel UN pressure receptacle bearing an "H" mark must be used for hydrogen bearing gases or other gases that may cause hydrogen embrittlement. Requalification intervals must be no more than every five years as specified in §180.207 of this subchapter in accordance with the requalification procedures prescribed in ISO 16111.

[76 FR 3381, Jan. 19, 2011, as amended at 76 FR 82178, Dec. 30, 2011]

§ 173.312 Requirements for shipment of MEGCs.

(a) *General requirements.* (1) Unless otherwise specified, a MEGC is authorized for the shipment of liquefied and non-liquefied compressed gases. Each pressure receptacle contained in a MEGC must meet the requirements in

§§ 173.301, 173.301b, 173.302b and 173.304b, as applicable.

(2) The MEGC must conform to the design, construction, inspection and testing requirements prescribed in § 178.75 of this subchapter.

(3) No person may offer or accept a hazardous material for transportation in a MEGC that is damaged to such an extent that the integrity of the pressure receptacles or the MEGC's structural or service equipment may be affected.

(4) No person may fill or offer for transportation a pressure receptacle in a MEGC if the pressure receptacle or the MEGC is due for periodic requalification, as prescribed in subpart C to part 180 of this subchapter. However, this restriction does not preclude transportation of pressure receptacles filled and offered for transportation prior to the requalification due date.

(5) Prior to filling and offering a MEGC for transportation, the MEGC's structural and service equipment must be visually inspected. Any unsafe condition must be corrected before the MEGC is offered for transportation. All required markings must be legible.

(6) Except for Division 2.2 permanent gases, each pressure receptacle must be equipped with an individual shutoff valve that must be tightly closed while in transit. For Division 2.1, Division 2.2 liquefied gases and 2.3 gases, the manifold must be designed so that each pressure receptacle can be filled separately and be kept isolated by a valve capable of being closed during transit. For Division 2.1 gases, the pressure receptacles must be isolated by a valve into assemblies of not more than 3,000 L.

(b) *Filling.* (1) A MEGC may not be filled to a pressure greater than the lowest marked working pressure of any pressure receptacle. A MEGC may not be filled above its marked maximum permissible gross mass.

(2) After each filling, the shipper must verify the leakproofness of the

closures and equipment. Each fill opening must be closed by a cap or plug.

(c) *Damage protection.* During transportation, a MEGC must be protected against damage to the pressure receptacles and service equipment resulting from lateral and longitudinal impact and overturning as prescribed in § 178.75 of this subchapter.

[71 FR 33884, June 12, 2006]

§ 173.313 UN Portable Tank Table for Liquefied Compressed Gases and Chemical Under Pressure.

The UN Portable Tank Table for Liquefied Compressed Gases and chemical under pressure is referenced in § 172.102(c)(7)(iii) of this subchapter for portable tanks that are used to transport liquefied compressed gases and chemicals under pressure. The table applies to each liquefied compressed gas and chemical under pressure that are identified with Special Provision T50 in Column (7) of the § 172.101 Hazardous Materials Table. In addition to providing the UN identification number and proper shipping name, the table provides maximum allowable working pressures, bottom opening requirements, pressure relief device requirements, and degree of filling requirements for liquefied compressed gas and chemical under pressure permitted for transportation in a T50 portable tank. In the minimum test pressure column, "small" means a portable tank with a diameter of 1.5 meters or less when measured at the widest part of the shell, "sunshield" means a portable tank with a shield covering at least the upper third of the shell, "bare" means no sunshield or insulation is provided, and "insulated" means a complete cladding of sufficient thickness of insulating material necessary to provide a minimum conductance of not more than 0.67 w/m²/k. In the pressure relief requirements column, the word "Normal" denotes that a frangible disc as specified in § 178.276(e)(3) of this subchapter is not required.

§ 173.313

49 CFR Ch. I (10–1–14 Edition)

UN PORTABLE TANK TABLE FOR LIQUEFIED COMPRESSED GASES AND CHEMICALS UNDER PRESSURE

UN No.	Non-refrigerated liquefied compressed gases	Minimum design pressure (bar) small; bare; sunshield; insulated	Openings below liquid level	Pressure relief requirements (See § 178.276(e))	Maximum filling density (kg/l)
1005	Ammonia, anhydrous	29.0 25.7 22.0 19.7 38.0	Allowed	§ 178.276(e)(3)	0.53
1009	Bromotrifluoromethane or Refrigerant gas R 13B1.	34.0 30.0 27.5	Allowed	Normal	1.13
1010	Butadienes, stabilized	7.5 7.0 7.0 7.0	Allowed	Normal	0.55
1011	Butane	7.0 7.0 7.0	Allowed	Normal	0.51
1012	Butylene	7.0 8.0 7.0 7.0	Allowed	Normal	0.53
1017	Chlorine	19.0 17.0 15.0 13.5 26.0	Not Allowed	§ 178.276(e)(3)	1.25
1018	Chlorodifluoromethane or Refrigerant gas R 22.	24.0 21.0 19.0 23.0	Allowed	Normal	1.03
1020	Chloropentafluoroethane or Refrigerant gas R 115.	20.0 18.0 16.0 10.3	Allowed	Normal	1.06
1021	1-Chloro-1,2,2,2-tetrafluoroethane or Refrigerant gas R 124.	9.8 7.9 7.0	Allowed	Normal	1.2
1027	Cyclopropane	18.0 16.0 14.5 13.0 16.0	Allowed	Normal	0.53
1028	Dichlorodifluoromethane or Refrigerant gas R 12.	15.0 13.0 11.5 7.0	Allowed	Normal	1.15
1029	Dichlorofluoromethane or Refrigerant gas R 21.	7.0 7.0 7.0 16.0	Allowed	Normal	1.23
1030	1,1-Difluoroethane or Refrigerant gas R 152a.	14.0 12.4 11.0	Allowed	Normal	0.79
1032	Dimethylamine, anhydrous	7.0 7.0 7.0	Allowed	Normal	0.59
1033	Dimethyl ether	15.5 13.8 12.0 10.6 7.0 7.0	Allowed	Normal	0.58
1036	Ethylamine	7.0	Allowed	Normal	0.61

UN PORTABLE TANK TABLE FOR LIQUEFIED COMPRESSED GASES AND CHEMICALS UNDER PRESSURE—Continued

UN No.	Non-refrigerated liquefied compressed gases	Minimum design pressure (bar) small; bare; sunshield; insulated	Openings below liquid level	Pressure relief requirements (See § 178.276(e))	Maximum filling density (kg/l)
1037	Ethyl chloride	7.0 7.0 7.0 7.0 7.0	Allowed	Normal	0.8
1040	Ethylene oxide with nitrogen up to a total pressure of 1MPa (10 bar) at 50 °C.	Only authorized in 10 bar insulated portable tanks—	Not Allowed	§ 178.276(e)(3)	0.78
1041	Ethylene oxide and carbon dioxide mixture with more than 9% but not more than 87% ethylene oxide.	See MAWP definition in § 178.276(a)	Allowed	Normal	See § 173.32(f)
1055	Isobutylene	8.1 7.0 7.0 7.0	Allowed	Normal	0.52
1060	Methyl acetylene and propadiene mixture, stabilized.	28.0	Allowed	Normal	0.43
1061	Methylamine, anhydrous	24.5 22.0 20.0 10.8 9.6 7.8 7.0	Allowed	Normal	0.58
1062	Methyl bromide	7.0 7.0 7.0 7.0	Not Allowed	§ 178.276(e)(3)	1.51
1063	Methyl chloride or Refrigerant gas R 40	14.5 12.7 11.3 10.0	Allowed	Normal	0.81
1064	Methyl mercaptan	7.0 7.0 7.0 7.0	Not Allowed	§ 178.276(e)(3)	0.78
1067	Dinitrogen tetroxide	7.0 7.0 7.0 7.0	Not Allowed	§ 178.276(e)(3)	1.3
1075	Petroleum gas, liquefied	See MAWP definition in § 178.276(a)	Allowed	Normal	See § 173.32(f)
1077	Propylene	28.0 24.5 22.0 20.0	Allowed	Normal	0.43
1078	Refrigerant gas, n.o.s.	See MAWP definition in § 178.276(a)	Allowed	Normal	See § 173.32(f)
1079	Sulphur dioxide	11.6 10.3 8.5 7.6 17.0	Not Allowed	§ 178.276(e)(3)	1.23
1082	Trifluorochloroethylene, stabilized or Refrigerant gas R 1113.	15.0 13.1 11.6	Not Allowed	§ 178.276(e)(3)	1.13
1083	Trimethylamine, anhydrous	7.0 7.0 7.0 7.0	Allowed	Normal	0.56
1085	Vinyl bromide, stabilized	7.0 7.0 7.0	Allowed	Normal	1.37

UN PORTABLE TANK TABLE FOR LIQUEFIED COMPRESSED GASES AND CHEMICALS UNDER PRESSURE—Continued

UN No.	Non-refrigerated liquefied compressed gases	Minimum design pressure (bar) small; bare; sunshield; insulated	Openings below liquid level	Pressure relief requirements (See § 178.276(e))	Maximum filling density (kg/l)
1086	Vinyl chloride, stabilized	7.0 7.0 10.6 9.3 8.0 7.0	Allowed	Normal	0.81
1087	Vinyl methyl ether, stabilized	7.0 7.0 7.0 7.0	Allowed	Normal	0.67
1581	Chloropicrin and methyl bromide mixture.	7.0	Not Allowed	§ 178.276(e)(3)	1.51
1582	Chloropicrin and methyl chloride mixture.	7.0 7.0 7.0 19.2	Not Allowed	§ 178.276(e)(3)	0.81
1858	Hexafluoropropylene compressed or Refrigerant gas R 1216.	16.9 15.1 13.1 19.2	Allowed	Normal	1.11
1912	Methyl chloride and methylene chloride mixture.	16.9 15.1 13.1 15.2	Allowed	Normal	0.081
NA, 1954	Insecticide gases, <i>flammable</i> , n.o.s.	13.0 11.6 10.1 See MAWP definition in § 178.276(a)	Allowed	Normal	§ 173.32(f)
1958	1,2-Dichloro-1,1,2,2-tetrafluoroethane or Refrigerant gas R 114.	7.0 7.0 7.0	Allowed	Normal	1.3
1965	Hydrocarbon gas, mixture liquefied, n.o.s.	7.0 See MAWP definition in 178.276(a)	Allowed	Normal	See § 173.32(f)
1969	Isobutane	8.5 7.5 7.0 7.0	Allowed	Normal	0.49
1973	Chlorodifluoromethane and chloropentafluoroethane mixture with fixed boiling point, with approximately 49% chlorodifluoromethane or Refrigerant gas R 502.	28.3	Allowed	Normal	1.05
1974	Chlorodifluorobromomethane or Refrigerant gas R 12B1.	25.3 22.8 20.3 7.4	Allowed	Normal	1.61
1976	Octafluorocyclobutane or Refrigerant gas RC 318.	7.0 7.0 7.0 8.8	Allowed	Normal	1.34
1978	Propane	7.8 7.0 7.0 22.5 20.4 18.0 16.5	Allowed	Normal	0.42

UN PORTABLE TANK TABLE FOR LIQUEFIED COMPRESSED GASES AND CHEMICALS UNDER PRESSURE—Continued

UN No.	Non-refrigerated liquefied compressed gases	Minimum design pressure (bar) small; bare; sunshield; insulated	Openings below liquid level	Pressure relief requirements (See § 178.276(e))	Maximum filling density (kg/l)
1983	1-Chloro-2,2,2-trifluoroethane or Refrigerant gas R 133a.	7.0 7.0 7.0 7.0	Allowed	Normal	1.18
2035	1,1,1-Trifluoroethane compressed or Refrigerant gas R 143a.	31.0 27.5 24.2 21.8	Allowed	Normal	0.76
2424	Octafluoropropane or Refrigerant gas R 218.	23.1 20.8 18.6 16.6	Allowed	Normal	1.07
2517	1-Chloro-1,1-difluoroethane or Refrigerant gas R 142b.	8.9 7.8 7.0 7.0	Allowed	Normal	0.99
2602	Dichlorodifluoromethane and difluoroethane azeotropic mixture with approximately 74% dichlorodifluoromethane or Refrigerant gas R 500.	20.0 18.0 16.0 14.5	Allowed	Normal	1.01
3057	Trifluoroacetyl chloride	14.6 12.9 11.3 9.9	Not allowed	§ 178.276(e)(3)	1.17
3070	Ethylene oxide and dichlorodifluoromethane mixture with not more than 12.5% ethylene oxide.	14.0 12.0 11.0 9.0	Allowed	§ 178.276(e)(3)	1.09
3153	Perfluoro (methyl vinyl ether)	14.3 13.4 11.2 10.2	Allowed	Normal	1.14
3159	1,1,1,2-Tetrafluoroethane or Refrigerant gas R 134a.	17.7 15.7 13.8 12.1	Allowed	Normal	1.04
3161	Liquefied gas, flammable, n.o.s.	See MAWP definition in § 178.276(a)	Allowed	Normal	§ 173.32(f)
3163	Liquefied gas, n.o.s.	See MAWP definition in § 178.276(a)	Allowed	Normal	§ 173.32(f)
3220	Pentafluoroethane or Refrigerant gas R 125.	34.4 30.8 27.5 24.5	Allowed	0.87	
3252	Difluoromethane or Refrigerant gas R 32.	43.0 39.0 34.4 30.5	Normal Allowed	Normal	0.78
3296	Heptafluoropropane or Refrigerant gas R 227.	16.0 14.0 12.5 11.0	Allowed	Normal	1.2

§ 173.314

49 CFR Ch. I (10–1–14 Edition)

UN PORTABLE TANK TABLE FOR LIQUEFIED COMPRESSED GASES AND CHEMICALS UNDER PRESSURE—Continued

UN No.	Non-refrigerated liquefied compressed gases	Minimum design pressure (bar) small; bare; sunshield; insulated	Openings below liquid level	Pressure relief requirements (See § 178.276(e))	Maximum filling density (kg/l)
3297	Ethylene oxide and chlorotetrafluoroethane mixture, with not more than 8.8% ethylene oxide.	8.1	Allowed	Normal	1.16
		7.0			
		7.0			
		7.0			
3298	Ethylene oxide and pentafluoroethane mixture, with not more than 7.9% ethylene oxide.	25.9	Allowed	Normal	1.02
		23.4			
		20.9			
		18.6			
3299	Ethylene oxide and tetrafluoroethane mixture, with not more than 5.6% ethylene oxide.	16.7	Allowed	Normal	1.03
		14.7			
		12.9			
		11.2			
3318	Ammonia solution, relative density less than 0.880 at 15 °C in water, with more than 50% ammonia.	See MAWP definition in § 178.276(a)	Allowed	§ 178.276(e)(3)	§ 173.32(f)
3337	Refrigerant gas R 404A	31.6	Allowed	Normal	0.84
		28.3			
		25.3			
		22.5			
3338	Refrigerant gas R 407A	31.3	Allowed	Normal	0.95
		28.1			
		25.1			
		22.4			
3339	Refrigerant gas R 407B	33.0	Allowed	Normal	0.95
		29.6			
		26.5			
		23.6			
3340	Refrigerant gas R 407C	29.9	Allowed	Normal	0.95
		26.8			
		23.9			
		21.3			
3500	Chemical under pressure, n.o.s	See MAWP definition in § 178.276(a)	Allowed	§ 178.276(e)(3)	See TP4 in § 172.102(c)
3501	Chemical under pressure, flammable, n.o.s.	See MAWP definition in § 178.276(a)	Allowed	§ 178.276(e)(3)	See TP4 in § 172.102(c)
3502	Chemical under pressure, toxic, n.o.s ...	See MAWP definition in § 178.276(a)	Allowed	§ 178.276(e)(3)	See TP4 in § 172.102(c)
3503	Chemical under pressure, corrosive, n.o.s.	See MAWP definition in § 178.276(a)	Allowed	§ 178.276(e)(3)	See TP4 in § 172.102(c)
3504	Chemical under pressure, flammable, toxic, n.o.s.	See MAWP definition in § 178.276(a)	Allowed	§ 178.276(e)(3)	See TP4 in § 172.102(c)
3505	Chemical under pressure, flammable, corrosive, n.o.s.	See MAWP definition in § 178.276(a)	Allowed	§ 178.276(e)(3)	See TP4 in § 172.102(c)

[69 FR 76174, Dec. 20, 2004, as amended at 70 FR 34399, June 14, 2005; 78 FR 1091, Jan. 7, 2013]

§ 173.314 Compressed gases in tank cars and multi-unit tank cars.

(a) *Definitions.* For definitions of compressed gases, see § 173.115.

(b) *General requirements.* (1) Tank car tanks containing compressed gases

must not be shipped unless they were loaded by or with the consent of the owner thereof.

(2) Tank car tanks must not contain gases capable of combining chemically and must not be loaded with any gas which combines chemically with the gas previously loaded therein, until all residue has been removed and interior of tank thoroughly cleaned.

(3) For tanks of the DOT-106A and 110A class, the tanks must be placed in position and attached to car structure by the shipper.

(4) Wherever the word "approved" is used in this part of the regulations, it means approval by the Association of American Railroads Committee on Tank Cars as prescribed in §179.3 of this subchapter.

(5) Each tank car used for the transportation of anhydrous ammonia or

any material that meets the criteria of Division 2.1 or 2.3 must have gaskets for manway cover plates and for mounting of fittings designed (for temperature, application, media, pressure, and size) to create a positive seal so that, under conditions normally incident to transportation, there will not be an identifiable release of the material to the environment. The use of sealants to install gaskets is prohibited.

(c) *Authorized gases, filling limits for tank cars.* A compressed gas in a tank car or a multi-unit tank car must be offered for transportation in accordance with §173.31 and this section. The gases listed below must be loaded and offered for transportation in accordance with the following table:

Proper shipping name	Outage and filling limits (see note 1)	Authorized tank car class (see note 11)	Authorized tank car specification (see note 12)
Ammonia, anhydrous, or ammonia solutions >50 percent ammonia.	Notes 2, 10	105, 112, 114, 120	105J5001, 112J5001
Ammonia solutions with >35 percent, but ≤50 percent ammonia by mass.	Note 3	106.	
Argon, compressed	Note 3	105, 109, 112, 114, 120.	
Boron trichloride	Note 4	107.	
Carbon dioxide, refrigerated liquid	Note 3	105, 106.	
Chlorine	Note 5	105.	
Chlorine trifluoride	Note 6	105	105J6001
Chlorine pentafluoride	125	106.	
Dimethyl ether	Note 3	106, 110.	
Dimethylamine, anhydrous	Note 3	106, 110.	
Dinitrogen tetroxide, inhibited	Note 3	105, 106, 110, 112, 114, 120.	105J5001
Division 2.1 materials not specifically identified in this table.	Notes 9, 10	105, 106, 110, 112, 114, 120.	
Division 2.2 materials not specifically identified in this table.	Note 3	105, 106, 109, 110, 112, 114, 120.	
Division 2.3 Zone A materials not specifically identified in this table.	None	See §173.245.	105J6001
Division 2.3 Zone B materials not specifically identified in this table.	Note 3	105, 106, 110, 112, 114, 120.	105J6001
Division 2.3 Zone C materials not specifically identified in this table.	Note 3	105, 106, 110, 112, 114, 120.	105J5001
Division 2.3 Zone D materials not specifically identified in this table.	Note 3	105, 106, 109, 110, 112, 114, 120.	105J5001, 112J5001
Ethylamine	Note 3	105, 106, 110, 112, 114, 120.	
Helium, compressed	Note 4	107.	
Hydrogen	Note 4	107.	
Hydrogen chloride, refrigerated liquid	Note 7	105	105J6001, 112S6001
Hydrogen sulfide	Note 3	105, 106, 110, 112, 114, 120.	105J6001
Hydrogen sulfide, liquefied	68	106.	
Methyl bromide	Note 3	105, 106	105J5001
Methyl chloride	Note 3	105, 106, 112.	
Methyl mercaptan	Note 3	105, 106	105J5001
Methylamine, anhydrous	Note 3	105, 106, 112.	
Nitrogen, compressed	Note 4	107.	
Nitrosyl chloride	124	105	105J5001
	110	106.	
Nitrous oxide, refrigerated liquid	Note 5	105.	

Proper shipping name	Outage and filling limits (see note 1)	Authorized tank car class (see note 11)	Authorized tank car specification (see note 12)
Oxygen, compressed	Note 4	107.	
Phosgene	Note 3	106.	
Sulfur dioxide, liquefied	125	105, 106, 110	105J5001
Sulfuryl fluoride	120	105.	
Vinyl fluoride, stabilized	Note 8	105.	

- NOTES: 1. The percent filling density for liquefied gases is hereby defined as the percent ratio of the mass of gas in the tank to the mass of water that the tank will hold. For determining the water capacity of the tank in kilograms, the mass of 1 L of water at 15.5 °C in air is 1 kg. (the mass of one gallon of water at 60 °F in air is 8.32828 pounds).
2. The liquefied gas must be loaded so that the outage is at least two percent of the total capacity of the tank at the reference temperature of 46 °C (115 °F) for a noninsulated tank; 43 °C (110 °F) for a tank having a thermal protection system incorporating a metal jacket that provides an overall thermal conductance at 15.5 °C (60 °F) of no more than 10.22 kilojoules per hour per square meter per degree Celsius (0.5 Btu per hour per square foot per degree F) temperature differential; and 41 °C (105 °F) for an insulated tank having an insulation system incorporating a metal jacket that provides an overall thermal conductance at 15.5 °C (60 °F) of no more than 1.5333 kilojoules per hour per square meter per degree Celsius (0.075 Btu per hour per square foot per degree F) temperature differential.
3. The requirements of § 173.24b(a) apply.
4. The gas pressure at 54.44 °C (130 °F) in any non-insulated tank car may not exceed 7/10 of the marked test pressure, except that a tank may be charged with helium to a pressure 10 percent in excess of the marked maximum gas pressure at 54.44 °C (130 °F) of each tank.
5. The liquid portion of the gas at -17.77 °C (0 °F) must not completely fill the tank.
6. The maximum permitted filling density is 125 percent. The quantity of chlorine loaded into a single unit-tank car may not be loaded in excess of the normal lading weights nor in excess of 81.65 Mg (90 tons).
7. 89 percent maximum to 80.1 percent minimum at a test pressure of 6.2 Bar (90 psig).
8. 59.6 percent maximum to 53.6 percent minimum at a test pressure of 7.2 Bar (105 psig).
9. For a liquefied petroleum gas, the liquefied gas must be loaded so that the outage is at least one percent of the total capacity of the tank at the reference temperature of 46 °C (115 °F) for a noninsulated tank; 43 °C (110 °F) for a tank having a thermal protection system incorporating a metal jacket that provides an overall thermal conductance at 15.5 °C (60 °F) of no more than 10.22 kilojoules per hour per square meter per degree Celsius (0.5 Btu per hour per square foot per degree F) temperature differential; and 41 °C (105 °F) for an insulated tank having an insulation system incorporating a metal jacket that provides an overall thermal conductance at 15.5 °C (60 °F) of no more than 1.5333 kilojoules per hour per square meter per degree Celsius (0.075 Btu per hour per square foot per degree F) temperature differential.
10. For liquefied petroleum gas and anhydrous ammonia, during the months of November through March (winter), the following reference temperatures may be used: 38 °C (100 °F) for a noninsulated tank; 32 °C (90 °F) for a tank having a thermal protection system incorporating a metal jacket that provides an overall thermal conductance at 15.5 °C (60 °F) of no more than 10.22 kilojoules per hour per square meter per degree Celsius (0.5 Btu per hour per square foot per degree F) temperature differential; and 29 °C (85 °F) for an insulated tank having an insulation system incorporating a metal jacket and insulation that provides an overall thermal conductance at 15.5 °C (60 °F) of no more than 1.5333 kilojoules per hour per square meter per degree Celsius (0.075 Btu per hour per square foot per degree F) temperature differential. The winter reference temperatures may only be used for a tank car shipped directly to a consumer for unloading and not stored in transit. The offeror of the tank must inform each customer that the tank car was filled based on winter reference temperatures. The tank must be unloaded as soon as possible after March in order to retain the specified outage and to prevent a release of hazardous material which might occur due to the tank car becoming liquid full at higher temperatures.
11. For materials poisonous by inhalation, the single unit tank car tanks authorized are only those cars approved by the Tank Car Committee for transportation of the specified material and built prior to March 16, 2009.
12. Except as provided by paragraph (d) of this section, for materials poisonous by inhalation, fusion-welded tank car tanks built on or after March 16, 2009 used for the transportation of the PIH materials noted, must meet the applicable authorized tank car specification and must be equipped with a head shield as prescribed in § 179.16(c)(1).

(d) *Alternative tank car tanks for materials poisonous by inhalation.* (1) As an alternative to the authorized tank car specification noted in the column 4 of the table in paragraph (c) of this section, a car of the same authorized tank car specification but of the next lower test pressure, as prescribed in column 5 of the table at §179.101–1, may be used provided both of the following conditions are met:

(i) The difference between the alternative and the required minimum plate thicknesses, based on the calculation prescribed in §179.100–6 of this subchapter, is added to the alternative tank car jacket and head shield. When the jacket and head shield are made from any authorized steel with a minimum tensile strength from 70,000 p.s.i. to 80,000 p.s.i., but the required min-

imum plate thickness calculation is based on steel with a minimum tensile strength of 81,000 p.s.i., the thickness to be added to the jacket and head shield must be increased by a factor of 1.157. Forming allowances for heads are not required to be considered when calculating thickness differences as prescribed in this paragraph.

(ii) The tank car jacket and head shield must be manufactured from carbon steel plate as prescribed in §179.100–7(a) of this subchapter.

(e) *Verification of content.* (1) The amount of liquefied gas loaded into each tank may be determined either by measurement or calculation of the weight, except that DOT specification tank car tanks authorized for the transportation of anhydrous ammonia and ammonia solution may have the

amount of liquefied gas loaded into the tank car measured by a metering device in conformance with paragraph (e)(2) of this section.

(2) *Metering device.* (i) Tank cars loaded with anhydrous ammonia or ammonia solution through the use of a metering device in conformance with this section are not required to be weighed, but must have their outage measured with a magnetic gauging device to determine that the tank car is properly loaded in conformance with this paragraph. Written procedures for loading a tank car using a metering device must be developed and made available at each location where such loading takes place. Certification in writing of the inspection and completion of these loading and/or unloading procedures must be maintained for each tank car and maintained in accordance with the recordkeeping requirements in paragraph (e)(2)(iii) of this section, and all necessary records must be completed. At a minimum, these procedures will specify:

(A) The tank car must be offered for transportation in conformance with all applicable government regulations.

(B) Any defects found when the tank car is examined before shipping must be recorded, and the tank must not be loaded until the repairs to eliminate each defect are completed.

(C) The tank car must be allowed to sit undisturbed for at least 10 minutes after loading to allow material within the tank to settle. After this has occurred a final check for leaks must be conducted prior to offering the tank car for transportation.

(ii) One out of every 10 tank cars loaded by the use of the metering device must be gauged utilizing the fixed gauging equipment on the tank car to verify by calculation the amount of anhydrous ammonia or ammonia solution contained in the tank car.

(iii) *Recordkeeping.* The following information must be maintained and be made available to any representative of the DOT upon request for each tank car loaded with the use of a metering device:

- (A) Date loaded,
- (B) Date shipped,
- (C) Tank car reporting marks,
- (D) DOT Specification,

(E) Tank car stenciled shell capacity (gallons/liters),

(F) Tank car stenciled tare weight (pounds/kilograms),

(G) Outage or innage table number,

(H) Water capacity of tank in pounds and/or kilograms,

(I) Maximum permitted filling density (see §173.314),

(J) Specific gravity of anhydrous ammonia or ammonia solution at the reference temperature,

(K) Tank car outage (inches/meters, gallons/liters),

(L) Gallons/liters of liquid ammonia in tank car,

(M) Quantity of vapor ammonia in tank car (gallons/liters), and

(N) Total calculated ammonia (liquid & vapor) in tank car (pounds/kilograms).

(f) [Reserved]

(g) Special requirements for hydrogen chloride, refrigerated liquid, and vinyl fluoride, stabilized.

(1) The shipper shall notify the Federal Railroad Administration whenever a tank car is not received by the consignee within 20 days from the date of shipment. Notification to the Federal Railroad Administration may be made by e-mail to Hmassist@fra.dot.gov or telephone call to (202) 493-6229.

(2) A tank car containing hydrogen chloride, refrigerated liquid must have the auxiliary valve on the pressure relief device closed during transportation.

(3) See §179.102-17 of this subchapter for additional requirements.

(4) Tank cars containing hydrogen chloride, refrigerated liquid, must be unloaded to such an extent that any residue remaining in the tank at a reference temperature of 32 °C (90 °F) will not actuate the reclosing pressure relief device.

(h)-(i) [Reserved]

(j) *Special requirements for materials having a primary or secondary Division 2.1 (flammable gas) hazard.* For single unit tank cars, interior pipes of loading and unloading valves, sampling devices, and gauging devices with an opening for the passage of the lading exceeding 1.52 mm (0.060 inch) diameter must be equipped with excess flow

valves. For single unit tank cars constructed before January 1, 1972, gauging devices must conform to this paragraph by no later than July 1, 2006. The protective housing cover must be provided with an opening, with a weather-proof cover, above each pressure relief valve that is concentric with the discharge of the pressure relief valve and that has an area at least equal to the valve outlet area. Class DOT 109 tank cars and tank cars manufactured from aluminum or nickel plate are not authorized.

(k) *Special requirements for chlorine.*

(1) Tank cars built after September 30, 1991, must have an insulation system consisting of 5.08 cm (2 inches) glass fiber placed over 5.08 cm (2 inches) of ceramic fiber. Tank cars must have excess flow valves on the interior pipes of liquid discharge valves. Tank cars constructed to a DOT 105A500W specification may be marked as a DOT 105A300W specification with the size and type of reclosing pressure relief valves required by the marked specification.

(2) DOT105J500W tank cars may be used as authorized packagings, as prescribed in this subchapter for transporting “Chlorine, 2.3 (8), UN 1017, Poison Inhalation Hazard, Zone B, RQ,” if the tank cars meet all DOT specification requirements, and the tank cars are equipped with combination safety relief valves with a start-to-discharge pressure of 360 psi, rather than the 356 psi. The start-to-discharge pressure setting must be marked on the pressure relief device in conformance with applicable provisions of the AAR Specification for Tank Cars (IBR, see §171.7 of this subchapter).

(l) *Special requirements for hydrogen sulphide.* Each multi-unit tank car must be equipped with adequate pressure relief devices of the fusible plug type having a yield temperature not over 76.66 °C (170 °F.), and not less than 69.44 °C (157 °F.). Each device must be resistant to extrusion of the fusible alloy and leak tight at 55 °C (130 °F.). A threaded solid plug must seal each valve outlet. In addition, a metal cover must protect all valves.

(m) *Special requirements for nitrosyl chloride.* Single unit tank cars and their associated service equipment, such as venting, loading and unloading

valves, and reclosing pressure relief valves, must be made of metal or clad with a material that is not subject to rapid deterioration by the lading. Multi-unit tank car tanks must be nickel-clad and have reclosing pressure relief devices incorporating a fusible plug having a yield temperature of 79.44 °C (175 °F.). Reclosing pressure relief devices must be vapor tight at 54.44 °C (130 °F.).

(n) *Special requirements for hydrogen.* Each tank car must be equipped with one or more pressure relief devices. The discharge outlet for each pressure relief device must be connected to a manifold having a non-obstructed discharge area of at least 1.5 times the total discharge area of the pressure relief devices connected to the manifold. All manifolds must be connected to a single common header having a non-obstructed discharge pointing upward and extending above the top of the car. The header and the header outlet must each have a non-obstructed discharge area at least equal to the total discharge area of the manifolds connected to the header. The header outlet must be equipped with an ignition device that will instantly ignite any hydrogen discharged through the pressure relief device.

(o) *Special requirements for carbon dioxide, refrigerated liquid and nitrous oxide, refrigerated liquid.* Each tank car must have an insulation system so that the thermal conductance is not more than 0.613 kilojoules per hour, per square meter, per degree Celsius (0.03 B.t.u. per square foot per hour, per degree Fahrenheit) temperature differential. Each tank car must be equipped with one reclosing pressure relief valve having a start-to-discharge pressure not to exceed 75 percent of the tank test pressure and one non-reclosing pressure relief valve having a rupture disc design to burst at a pressure less than the tank test pressure. The discharge capacity of each pressure relief device must be sufficient to prevent building up of pressure in the tank in excess of 82.5 percent of the test pressure of the tank. Tanks must be equipped with two regulating valves set to open at a pressure not to exceed 24.1 Bar (350 psi) on DOT 105A500W tanks and at a pressure not to exceed

27.6 Bar (400 psi) on DOT 105A600W tanks. Each regulating valve and pressure relief device must have its final discharge piped to the outside of the protective housing.

[Amdt. 173-224, 55 FR 52665, Dec. 21, 1990]

EDITORIAL NOTE: For FEDERAL REGISTER citations affecting § 173.314, see the List of CFR Sections Affected, which appears in the Finding Aids section of the printed volume and at www.fdsys.gov.

§ 173.315 Compressed gases in cargo tanks and portable tanks.

(a) Liquefied compressed gases that are transported in UN portable tanks, DOT specification portable tanks, or cargo tanks must be prepared in ac-

cordance with this section, §173.32, §173.33 and subpart E or subpart G of part 180 of this subchapter, as applicable. For cryogenic liquid in cargo tanks, see §173.318. For marking requirements for portable tanks and cargo tanks, see §172.326 and §172.328 of this subchapter, as applicable.

(1) *UN portable tanks:* UN portable tanks must be loaded and offered for transportation in accordance with portable tank provision T50 in §172.102 of this subchapter.

(2) *Cargo tanks and DOT specification portable tanks:* Cargo tanks and DOT specification portable tanks must be loaded and offered for transportation in accordance with the following table:

Kind of gas	Maximum permitted filling density		Specification container required	
	Percent by weight (see Note 1)	Percent by volume (see par. (f) of this section)	Type (see Note 2)	Minimum design pressure (psig)
Ammonia, anhydrous or Ammonia solutions with greater than 50 percent ammonia (see Notes 14 and 17).	56	82, See Note 5	DOT-51, MC-330, MC-331; See Notes 12, 17 and 27.	265; See Note 17.
Ammonia solutions with more than 35 percent but not more than 50 percent ammonia.	See par. (c) of this section.	See Note 7	DOT-51, MC-330, MC-331; see Note 12.	100; See par. (c) of this section.
Bromotrifluoromethane (R-13B1 or H-1301); (See Note 9).	133	See Note 7	DOT-51, MC-330, MC-331.	365.
Butadiene, stabilized	See par. (b) of this section.	See par. (b) of this section.	DOT-51, MC-330, MC-331.	100.
Carbon dioxide, refrigerated liquid	See par. (c)(1) of this section.	95do	200; see Note 3.
Chlorine	125	See Note 7	DOT-51, MC-330, MC-331.	225; See Notes 4 and 8.
Chlorodifluoroethane (R-142b) (1-Chloro 1,1-difluoroethane); (See Note 9).	100	See Note 7	DOT-51, MC-330, MC-331.	100.
Chlorodifluoromethane (R-22); (See Note 9).	105	See Note 7	DOT-51, MC-330, MC-331.	250.
Chloropentafluoroethane (R-115); (See Note 9).	See par. (c) of this section.	See Note 7	DOT-51, MC-330, MC-331.	See par. (c) of this section.
Chlorotrifluoromethane (R-13); (See Note 9).	See par. (c) of this section.	See Note 7	DOT-51, MC-330, MC-331.	See par. (c) of this section.
Dichlorodifluoromethane (R-12); (See Note 9).	119	See Note 7	DOT-51, MC-330, MC-331.	150.
Difluoroethane (R-152a); (See Note 9)	79	See Note 7	DOT-51, MC-330, MC-331.	150.
Dimethyl ether (see Note 16)	59dodo	200.
Dimethylamine, anhydrous	59	See Note 7	DOT-51, MC-330, MC-331.	150.
Division 2.1, materials not specifically provided for in this table.	See par. (c) of this section.	See Note 7	DOT-51, MC-330, MC-331.	See Note 18.
Division 2.2, materials not specifically provided for in this table.	See par. (c) of this section.	See Note 7	DOT-51, MC-330, MC-331.	See Note 19.
Division 2.3, Hazard Zone A, materials not specifically provided for in this table.	See par. (c) of this section.	See Note 7	DOT-51, MC-330, MC-331; See Note 23.	See Note 20.
Division 2.3, Hazard Zone B, materials not specifically provided for in this table.	See par. (c) of this section.	See Note 7	DOT-51, MC-330, MC-331; See Note 23.	See Note 20.
Division 2.3, Hazard Zone C, materials not specifically provided for in this table.	See par. (c) of this section.	See Note 7	DOT-51, MC-330, MC-331; See Note 24.	See Note 21.

Kind of gas	Maximum permitted filling density		Specification container required	
	Percent by weight (see Note 1)	Percent by volume (see par. (f) of this section)	Type (see Note 2)	Minimum design pressure (psig)
Division 2.3, Hazard Zone D, materials not specifically provided for in this table.	See par. (c) of this section.	See Note 7	DOT-51, MC-330, MC-331; See Note 25.	See Note 22.
Ethane, refrigerated liquid	See par. (c) of this section.	MC-331, MC-338	100; see Note 11.
Ethane-propane mixture, refrigerated liquid.	See par. (c) of this section.	MC-331, MC-338	275; see Note 11.
Hexafluoropropylene	110	See Note 7	DOT-51, MC-330, MC-331.	250.
Hydrogen chloride, refrigerated liquid	103.0	See Note 7	MC-331, MC-338	100; see Note 11.
	91.6dodo	300; see Note 11.
	86.7dodo	450; see Note 11.
Liquefied petroleum gas (see Note 15)	See par. (b) of this section.	See par. (b) of this section.	DOT-51, MC-330, MC-331; See Note 26.	See par. (c) of this section.
Methylacetylene-propadiene, stabilized (see Note 13).	53	90	DOT 51, MC 330, MC 331.	200.
Methylamine, anhydrous	60	See Note 7	DOT-51, MC-330, MC-331..	
Methyl chloride	84	88.5do	150.
Methyl chloride (optional portable tank 2,000 pounds water capacity, fusible plug).do	See Note 6	DOT-51	225.
Methyl mercaptan	80	90	DOT-51, MC-330, MC-331; See Note 23.	100.
Nitrous oxide, refrigerated liquid	See par. (c)(1) of this section.	95	DOT-51, MC-330, MC-331.	200; See Note 3.
Refrigerant gas, n.o.s. or Dispersant gas, n.o.s. (See Note 9).	See par. (c) of this section.	See Note 7	DOT-51, MC-330, MC-331.	See par. (c) of this section.
Sulfur dioxide (tanks not over 1,200 gallons water capacity).	125	87.5	DOT-51, MC-330, MC-331; See Note 24.	150; See Note 4.
Sulfur dioxide (tanks over 1,200 gallons water capacity).	125	87.5	DOT-51, MC-330, MC-331; See Note 24.	125; See Note 4.
Sulfur dioxide (optional portable tank 1,000–2,000 pounds water capacity, fusible plug).	125	See Note 6	DOT-51; See Note 24.	225.
Trimethylamine, anhydrous	57	See Note 7	DOT-51, MC-330, MC-331.	150.
Vinyl chloride	84 (see Note 13)	See Note 7	MC-330, MC-331	150.
Vinyl fluoride, stabilized	66dodo	250; see Note 11.
Vinyl methyl ether	68	See Notes 7 and 13.do	100.

NOTE 1: Maximum filling density for liquefied gases is hereby defined as the percent ratio of the weight of gas in the tank to the weight of water that the tank will hold. For determining the water capacity of the tank in pounds, the weight of a gallon (231 cubic inches) of water at 60 °F. in air shall be 8.32828 pounds.

NOTE 2: See § 173.32 for authority to use other portable tanks and for manifolding cargo tanks, see paragraph (q) of this section. Specifications MC 330 cargo tanks may be painted as specified for MC 331 cargo tanks.

NOTE 3: If cargo tanks and portable tank containers for carbon dioxide, refrigerated liquid, and nitrous oxide, refrigerated liquid, are designed to conform to the requirements in Section VIII of the ASME Code for low temperature operation (IBR, see § 171.7 of this subchapter), the design pressure may be reduced to 100 psig or the controlled pressure, whichever is greater.

NOTE 4: Material must be steel. Packagings must have a corrosion allowance of 20 percent or 0.10 inch, whichever is less, added to the metal thickness. The minimum wall thickness for chlorine packagings is 0.300 inch for stainless steel or 0.625 inch for carbon steel, including corrosion allowance.

NOTE 5: Unlagged cargo tanks and portable tank containers for liquid anhydrous ammonia may be filled to 87.5 percent by volume provided the temperature of the anhydrous ammonia being loaded into such tanks is determined to be not lower than 30 °F. or provided the filling of such tanks is stopped at the first indication of frost or ice formation on the outside surface of the tank and is not resumed until such frost or ice has disappeared.

NOTE 6: Tanks equipped with fusible plugs must be filled by weight.

NOTE 7: Tanks must be filled by weight.

NOTE 8: Chlorine packagings may be shipped only if the contents are to be unloaded at one unloading point.

NOTE 9: This gas may be transported in authorized cargo tanks and portable tanks marked "DISPERSANT GAS," or "REFRIGERANT GAS."

NOTE 10: [Reserved]

NOTE 11: MC-330, MC-331 and MC-338 cargo tanks must be insulated. Cargo tanks must meet all the following requirements. Each tank must have a design service temperature of minus 100 °F., or no warmer than the boiling point at one atmosphere of the hazardous material to be shipped therein, whichever is colder, and must conform to the low-temperature requirements in Section VIII of the ASME Code. When the normal travel time is 24 hours or less, the tank's holding time as loaded must be at least twice the normal travel time. When the normal travel time exceeds 24 hours, the tank's holding time as loaded must be at least 24 hours greater than the normal travel time. The holding time is the elapsed time from loading until venting occurs under equilibrium conditions. The cargo tank must have an outer jacket made of steel when the cargo tank is used to transport a flammable gas.

NOTE 12: No aluminum, copper, silver, zinc or an alloy of any of these metals shall be used in packaging construction where it comes into contact with the lading.

NOTE 13: All parts of valves and safety devices in contact with contents of tank must be of a metal or other material suitably treated if necessary, which will not cause formation of any acetylides.

NOTE 14: Specifications MC 330 and MC 331 cargo tanks constructed of other than quenched and tempered steel "(NQT)" are authorized for all grades of anhydrous ammonia. Specifications MC 330 and MC 331 cargo tanks constructed of quenched and tempered steel "(QT)" (see marking requirements of § 172.328(c) of this subchapter) are authorized for anhydrous ammonia having a minimum water content of 0.2 percent by weight. Any tank being placed in anhydrous ammonia service or a tank which has been in other service or has been opened for inspection, test, or repair, must be cleaned of the previous product and must be purged of air before loading. See § 172.203(h) of this subchapter for special shipping paper requirements.

NOTE 15: Specifications MC 330 and MC 331 cargo tanks constructed of other than quenched and tempered steel (NQT) are authorized for all grades of liquefied petroleum gases. Only grades of liquefied petroleum gases determined to be "noncorrosive" are authorized in Specification MC 330 and MC 331 cargo tanks constructed of quenched and tempered steel (QT). "Noncorrosive" means the corrosiveness of the gas does not exceed the limitations for classification 1 of the ASTM Copper Strip Classifications when tested in accordance with ASTM D 1838, "Copper Strip Corrosion by Liquefied Petroleum (LP) Gases" (IBR, see § 171.7 of this subchapter). (For (QT) and (NQT) marking requirements, see § 172.328(c) of this subchapter. For special shipping paper requirements, see § 172.203(h) of this subchapter.)

NOTE 16: Openings, inlets, and outlets on MC 330 and MC 331 cargo tanks must conform to § 178.337-8(a) of this subchapter. MC 330 and MC 331 cargo tanks must be equipped with emergency discharge control equipment as specified in § 178.337-11(a) of this subchapter.

NOTE 17: A Specification MC-330 or MC-331 cargo tank or a nonspecification cargo tank meeting, and marked in conformance with, the edition of the ASME Code in effect when it was fabricated, may be used for the transportation of anhydrous ammonia if it:

- (1) Has a minimum design pressure not lower than 250 psig;
- (2) Was manufactured in conformance with the ASME Code prior to January 1, 1981, according to its ASME name plate and manufacturer's data report;
- (3) Is painted white or aluminum;
- (4) Complies with Note 12 of this paragraph;
- (5) Has been inspected and tested in accordance with subpart E of part 180 of this subchapter as specified for MC 331 cargo tanks.
- (6) Was used to transport anhydrous ammonia prior to January 1, 1981;
- (7) Is operated exclusively in intrastate commerce (including its operation by a motor carrier otherwise engaged in interstate commerce) in a state where its operation was permitted by the laws of that State (not including the incorporation of this subchapter) prior to January 1, 1981; and
- (8) Is operated in conformance with all other requirements of this subchapter.

NOTE 18: The minimum packaging design pressure must not be less than the vapor pressure at the reference temperature of the lading plus one percent or 173.4 kPa (25 psig), whichever is less.

NOTE 19: The minimum packaging design pressure must not be less than the vapor pressure at the reference temperature of the lading.

NOTE 20: The minimum packaging design pressure must not be less than 1.5 times the vapor pressure of the lading at 46 °C (115 °F).

NOTE 21: The minimum packaging design pressure must not be less than 1.3 times the vapor pressure of the lading at 46 °C (115 °F).

NOTE 22: The minimum packaging design pressure must not be less than 1.1 times the vapor pressure of the lading at 46 °C (115 °F).

NOTE 23: Packagings must be made of stainless steel except that steel other than stainless steel may be used in accordance with the provisions of § 173.24b(b) of this part. Thickness of stainless steel for shell and heads must be the greater of 7.62 mm (0.300 inch) or the thickness required for the packaging at its minimum design pressure.

NOTE 24: Packagings must be made of stainless steel except that steel other than stainless steel may be used in accordance with the provisions of § 173.24b(b) of this part. Thickness of stainless steel for shell and heads must be the greater of 6.35 mm (0.250 inch) or the thickness required for the packaging at its minimum design pressure. For sulphur dioxide, this Note does not apply until October 1, 1994.

NOTE 25: Packagings must be made of stainless steel except that steel other than stainless steel may be used in accordance with the provisions of § 173.24b(b) of this part. Thickness for shell and heads must be as calculated for the packaging at its minimum design pressure.

NOTE 26: Non-specification cargo tanks may be used for the transportation of liquefied petroleum gas, subject to the conditions prescribed in paragraph (k) of this section.

NOTE 27: Non-specification cargo tanks may be used for transportation of Ammonia, anhydrous and ammonia solutions with greater than 50% ammonia, subject to the conditions prescribed in paragraph (m) of this section.

(b) Maximum permitted filling densities for cargo and portable tank containers for transportation of butadiene, stabilized, and liquefied petroleum gas are as follows:

Maximum specific gravity of the liquid material at 60 °F.	Maximum permitted filling density in percent of the water-weight capacity of the tanks (percent) See Note 1		Maximum permitted filling density in percent of the water-weight capacity of the tanks (percent) See Note 1	
	1200 gallons or less	Over 1200 gallons	1200 gallons or less	Over 1200 gallons
0.473 to 0.480	38	41	44	47
0.481 to 0.488	39	42	45	48
0.489 to 0.495	40	43	46	49
0.496 to 0.503	41	44	47	50
0.504 to 0.510	42	45	48	51
0.511 to 0.519	43	46	49	52
			50	53
			51	54
			52	55
			53	56
			54	57
			55	58
			56	59

§ 173.315

49 CFR Ch. I (10–1–14 Edition)

Maximum specific gravity of the liquid material at 60 °F.	Maximum permitted filling density in percent of the water-weight capacity of the tanks (percent) See Note 1	
	1200 gallons or less	Over 1200 gallons
0.627 and over	57	60

NOTE 1: Filling is permitted by volume provided the same filling density is used as permitted by weight, except when using fixed length dip tube or other fixed maximum liquid level indicators (paragraph (f) of this section), in which case the maximum permitted filling density shall not exceed 97 percent of the maximum permitted filling density by weight contained in the table.

(1) *Odorization.* All liquefied petroleum gas shall be effectively odorized as required in Note 2 of this paragraph to indicate positively, by a distinctive odor, the presence of gas down to a concentration in air of not over one-fifth the lower limit of combustibility provided, however, that odorization is not required if harmful in the use or further processing of the liquefied petroleum gas, or if odorization will serve no useful purpose as a warning agent in such use or further processing.

NOTE 1: The lower limits of combustibility of the more commonly used liquefied petroleum gases are: Propane, 2.15 percent; butane, 1.55 percent. These figures represent volumetric percentages of gas-air mixtures in each case.

NOTE 2: The use of 1.0 pound of ethyl mercaptan, 1.0 pound of thiophane, or 1.4 pounds of amyl mercaptan per 10,000 gallons of liquefied petroleum gas shall be considered sufficient to meet the requirements of §173.315(b)(1). This note does not exclude the use of any other odorant in sufficient quantity to meet the requirements of §173.315(b)(1).

(c) Except as otherwise provided, the loading of a liquefied gas into a cargo tank or portable tank shall be determined by weight or by a suitable liquid level gauging device. The vapor pressure (psig) at 115 °F. must not exceed the design pressure of the cargo tank or portable tank container. The outage and filling limits for liquefied gases must be as prescribed in §173.24b of this part, except that this requirement does not apply to:

(1) *A tank containing carbon dioxide, refrigerated liquid or nitrous oxide, refrigerated liquid.* Such tank is required to be equipped with suitable pressure control valves and may not be filled to a

level exceeding 95 percent of the volumetric capacity of the tank.

(2) *A tank containing ethane, refrigerated liquid; ethane-propane mixture, refrigerated liquid; or hydrogen chloride, refrigerated liquid.* Such tank must be filled to allow at least two percent outage below the inlet of the pressure relief valve or pressure control valve under conditions of incipient opening, with the tank in a level attitude.

(d) If the loading of cargo tanks and portable tank containers with liquefied gases is to be determined by weight, the gross weight shall be checked after the filling line is disconnected in each instance. The gross weight shall be calculated from the tank capacity and tare weight set forth on the metal plate required by the specification, and the maximum filling density permitted for the material being loaded into the tank as set forth in the table, paragraph (a) of this section.

(e) If the loading of cargo tanks and portable tank containers with liquefied gases is to be determined by adjustable liquid level device, each tank and each compartment thereof shall have a thermometer well, so that the internal liquid temperature can easily be determined, and the amount of liquid in the tank shall be corrected to a 60 °F. basis. Liquid levels shall not exceed a level corresponding to the maximum filling density permitted for the material being loaded into the tank as set forth in the table in paragraph (a) of this section.

(f) When the loading of cargo tanks and portable tank containers with liquefied gases is determined only by fixed length dip tube or other fixed maximum liquid level indicator, the device shall be arranged to function at a level not to exceed the maximum permitted volume prescribed by the table, paragraph (a) of this section. Loading shall be stopped when the device functions.

(g) Containers, the liquid level of which has been determined by means of a fixed length dip tube gauging device, shall not be acceptable for stowage as cargo on vessels in commerce subject to the jurisdiction of the United States Coast Guard. Nothing contained in this section shall be so construed as to prohibit the transportation on car floats

or car ferries of motor vehicles laden with containers nor cargo tanks the liquid level of either of which has been determined by means of fixed length dip tube devices.

(h) Each cargo tank and portable tank, except a tank filled by weight, must be equipped with one or more of the gauging devices described in the following table which indicate accurately the maximum permitted liquid level. Additional gauging devices may be installed but may not be used as primary controls for filling of cargo tanks and portable tanks. Gauge glasses are not permitted on any cargo tank or portable tank. Primary gauging devices used on cargo tanks of less than 3500 gallons water capacity are exempt from the longitudinal location requirements specified in paragraphs (h)(2) and (3) of this section provided: The tank length does not exceed three times the tank diameter; and the cargo tank is unloaded within 24 hours after each filling of the tank.

Kind of gas	Gaging device permitted for filling purposes
Anhydrous ammonia	Rotary tube; adjustable slip tube; fixed length dip tube.
Anhydrous dimethylamine	None.
Anhydrous monomethylamine	Do.
Anhydrous trimethylamine	Do.
Aqua ammonia solution containing anhydrous ammonia.	Rotary tube; adjustable slip tube; fixed length dip tube.
Butadiene, stabilized	Do.
Carbon dioxide, refrigerated liquid	Do.
Chlorine	None.
Dichlorodifluoromethane	Do.
Difluoroethane	Do.
Difluoromonochloroethane	Do.
Dimethyl ether	Do.
Ethane, refrigerated liquid	Rotary tube; adjustable slip tube; fixed length dip tube.
Ethane-propane mixture, refrigerated liquid.	Do.
Hexafluoropropylene	None.
Hydrogen chloride, refrigerated liquid.	Do.
Liquefied petroleum gases	Rotary tube; adjustable slip tube; fixed length dip tube.
Methyl chloride	Fixed length dip tube.
Methyl mercaptan	Rotary tube; adjustable slip tube; fixed length dip tube.
Monochlorodifluoromethane	None.
Nitrous oxide, refrigerated liquid ..	Rotary tube; adjustable slip tube; fixed length dip tube.
Methylacetylenepropadiene, stabilized.	Do.
Refrigerant gas, n.o.s. or Dispersant gas, n.o.s.	None.

Kind of gas	Gaging device permitted for filling purposes
Sulfur dioxide	Fixed length dip tube.
Vinyl chloride	None.
Vinyl fluoride, inhibited	Do.

(1) The design pressure of the liquid level gauging devices shall be at least equal to the design pressure of the tank.

(2) If the primary gauging device is adjustable, it must be capable of adjustment so that the end of the tube will be in the location specified in paragraph (h)(3) of this section for at least one of the loadings to be transported, at the filling level corresponding to an average loading temperature. Exterior means must be provided to indicate this adjustment. The gauging device must be legibly and permanently marked in increments not exceeding 20 Fahrenheit degrees (or not exceeding 25 p.s.i.g. on tanks for carbon dioxide, refrigerated liquid or nitrous oxide, refrigerated liquid), to indicate the maximum levels to which the tank may be filled with liquid at temperatures above 20 °F. However, if it is not practicable to so mark the gauging device, this information must be legibly and permanently marked on a plate affixed to the tank adjacent to the gauging device.

(3) A dip tube gauging device consists of a pipe or tube with a valve at its outer end with its intake limited by an orifice not larger than 0.060 inch in diameter. If a fixed length dip tube is used, the intake must be located midway of the tank both longitudinally and laterally and at maximum permitted filling level. In tanks for liquefied petroleum gases, the intake must be located at the level reached by the lading when the tank is loaded to maximum filling density at 40 °F.

(4) Except on a tank used exclusively for the transportation of carbon dioxide, refrigerated liquid or nitrous oxide, refrigerated liquid, each opening for a pressure gauge must be restricted at or inside the tank by an orifice no larger than 0.060 inch in diameter. For carbon dioxide, refrigerated liquid or nitrous oxide, refrigerated liquid service, the pressure gauge need only be used during the filling operation.

(i) Each tank must be provided with one or more pressure relief devices

§ 173.315

49 CFR Ch. I (10–1–14 Edition)

which, unless otherwise specified in this part, must be of the spring-loaded type. Each valve must be arranged to discharge upward and unobstructed to the outside of the protective housing to prevent any impingement of escaping gas upon the tank. For each chlorine tank the protective housing must be in compliance with the requirements set forth in the applicable specification.

(1) The safety relief valves on each tank must meet the following conditions:

(i) The total relieving capacity, as determined by the flow formulas contained in Section 5 of CGA S-1.2 (IBR, see §171.7 of this subchapter), must be sufficient to prevent a maximum pressure in the tank of more than 120 percent of the design pressure;

(ii) The flow capacity rating, testing and marking must be in accordance with Sections 5, 6 and 7 of CGA Pamphlet S-1.2.

(iii) For an insulated tank, the required relieving capacity of the relief devices must be the same as for an uninsulated tank, unless the insulation will remain in place and will be effective under fire conditions. In this case, except for UN portable tanks, each insulated tank must be covered by a sheet metal jacket of not less than 16 gauge thickness. For UN portable tanks where the relieving capacity of the valves has been reduced on the basis of the insulation system, the insulation system must remain effective at all temperatures less than 649 °C (1200.2 °F) and be jacketed with a material having a melting point of 700 °C (1292.0 °F) or greater.

(iv) An MC 330 cargo tank that has relief valves sized by Fetterly's formula dated November 27, 1928, may be continued in service.

(2) Each safety relief valve must be arranged to minimize the possibility of tampering. If the pressure setting or adjustment is external to the valve, the safety relief valve must be provided with means for sealing the adjustment and it must be sealed.

(3) Each safety relief valve on a portable tank, other than a UN portable tank, must be set to start-to-discharge at pressure no higher than 110% of the tank design pressure and no lower than the design pressure specified in para-

graph (a) of this section for the gas transported. For UN portable tanks used for liquefied compressed gases and constructed in accordance with the requirements of §178.276 of this subchapter, the pressure relief device(s) must conform to §178.276(e) of this subchapter.

(4) Except for UN portable tanks, each safety relief valve must be plainly and permanently marked with the pressure in p.s.i.g. at which it is set to discharge, with the actual rate of discharge of the device in cubic feet per minute of the gas or of air at 60 °F (15.6 °C) and 14.7 p.s.i.a., and with the manufacturer's name or trade name and catalog number. The start-to-discharge valve marking must be visible after the valve is installed. The rated discharge capacity of the device must be determined at a pressure of 120% of the design pressure of the tank. For UN portable tanks, each pressure relief device must be clearly and permanently marked as specified in §178.274(f)(1) of this subchapter.

(5) Each safety relief valve must have direct communication with the vapor space in the tank.

(6) Each connection to a safety relief valve must be of sufficient size to provide the required rate of discharge through the safety relief valve.

(7) [Reserved]

(8) Each pressure relief valve outlet must be provided with a protective device to prevent the entrance and accumulation of dirt and water. This device must not impede flow through the valve. Pressure relief devices must be designed to prevent the entry of foreign matter, the leakage of liquid and the development of any dangerous excess pressure.

(9) On tanks for carbon dioxide, refrigerated liquid or nitrous oxide, refrigerated liquid each safety relief device must be installed and located so that the cooling effect of the contents will not prevent the effective operation of the device. In addition to the required safety relief valves, these tanks may be equipped with one or more pressure controlling devices.

(10) Each tank for carbon dioxide, refrigerated liquid also may be equipped with one or more non-reclosing pressure relief devices set to function at a

pressure not over two times nor less than 1.5 times the design pressure of the tank.

(11) Each portion of connected liquid piping or hose that can be closed at both ends must be provided with a safety relief valve without an intervening shut-off valve to prevent excessive hydrostatic pressure that could burst the piping or hose.

(12) Subject to conditions of paragraph (a) of this section for the methyl chloride and sulfur dioxide optional portable tanks, one or more fusible plugs examined by the Bureau of Explosives and approved by the Associate Administrator may be used on these tanks in place of safety relief valves of the spring-loaded type. The fusible plug or plugs must be in accordance with CGA Pamphlet S-1.2, to prevent a pressure rise in the tank of more than 120 percent of the design pressure. If the tank is over 30 inches long, each end must have the total specified safety discharge area.

(13) A safety relief valve on a chlorine cargo tank must conform to one of the following standards of The Chlorine Institute, Inc.: Type 1 ½ JQ225, Dwg. H51970 (IBR, see §171.7 of this subchapter); or Type 1 ½ JQ225, Dwg. H50155 (IBR, see §171.7 of this subchapter).

(j) *Consumer storage containers.* (1) Storage containers for liquefied petroleum gas or propane charged to five percent of their capacity or less and intended for permanent installation on consumer premises may be shipped by private motor carrier under the following conditions:

(i) Each container must be constructed in compliance with the requirements in Section VIII of the ASME Code (IBR, see §171.7 of this subchapter) and must be marked to indicate compliance in the manner specified by the respective Code. Containers built in compliance with earlier editions starting with 1943 are authorized.

(ii) Each container must be equipped with safety devices in compliance with the requirements for safety devices on containers as specified in NFPA 58, Liquefied Petroleum Gas Code (IBR, see §171.7 of this subchapter).

(iii) The containers must be braced or otherwise secured on the vehicle to

prevent relative motion while in transit. Valves or other fittings must be adequately protected against damage during transportation. (See §177.834(a) of this subchapter).

(2) Storage containers with a water capacity not exceeding 500 gallons charged with liquefied petroleum gas to more than five percent of their capacity and intended for permanent installation on consumer premises may be transported by private motor carrier one-way only from the consumer's premises to the container owner's nearest facility under the following conditions:

(i) Each container must be constructed in compliance with the requirements in Section VIII of the ASME Code and must be marked to indicate compliance in the manner specified by the respective Code.

(ii) Maximum permitted filling density may not exceed that specified in paragraph (b) of this section.

(iii) Prior to loading on a motor vehicle, the container must be inspected by a trained and qualified person for leaks, corroded or abraded areas, dents, distortions, weld defects, or other condition that may render the container unsafe for transportation. A record of the inspection must be legibly signed and dated by the person performing the inspection and retained by the container owner for two years. The signature on the inspection record represents a certification that the container has been inspected and has no defects that would render it unsafe for transportation under the HMR. The record of inspection must include the date of inspection, the inspector's contact information (such as a telephone number), the container's serial number and container size (water capacity), estimated amount of hazardous material, and the origin and destination of shipment.

(iv) Only one storage container may be transported on a motor vehicle.

(v) For loading on a motor vehicle, the container must be lifted by slings, which must be completely wrapped around the container. Lifting lugs may not be used. The slings must be rated to a weight sufficient to accommodate the container and its lading and shall comply with ASME B30.9 on slings used

§ 173.315

49 CFR Ch. I (10–1–14 Edition)

for lifting purposes, and must be visually inspected prior to each use. A sling showing evidence of tears, fraying, or other signs of excessive wear may not be used.

(vi) The storage container must be secured on a motor vehicle so that the container is completely within the envelope of the vehicle and does not extend beyond the vehicle frame.

(vii) The storage container must be placed on the vehicle in a manner, such as in a cradle, which ensures that no weight is placed on the supporting legs during transportation.

(viii) The storage container must be secured against movement during transportation. Bracing must conform with the requirements of paragraph (j)(1)(iii) of this section and §177.834(a) of this subchapter and with Section 6–5.2 of NFPA 58, Liquefied Petroleum Gas Code. Straps or chains used as tie-downs must be rated to exceed the maximum load to be transported and conform to the requirements in §§393.100 through 393.106 of this title.

(ix) Tow trailers used to transport storage containers in accordance with this paragraph (j)(2) must provide rear end protection that conforms to requirements in §393.86 of this title.

(3) Storage containers of less than 1,042 pounds water capacity (125 gallons) may be shipped when charged with liquefied petroleum gas in compliance with DOT filling density.

(k) A nonspecification cargo tank meeting, and marked in conformance with, the edition of Section VIII of the ASME Code in effect when it was fabricated may be used for the transportation of liquefied petroleum gas provided it meets all of the following conditions:

(1) It must have a minimum design pressure no lower than 250 psig.

(2) It must have a capacity of 13,247.5 L (3,500 water gallons) or less.

(3) It must have been manufactured in conformance with Section VIII of the ASME Code prior to January 1, 1981, according to its ASME name plate and manufacturer's data report.

(4) It must conform to the applicable provisions of NFPA 58, except to the extent that provisions in NFPA 58 are inconsistent with requirements in parts 178 and 180 of this subchapter.

(5) It must be inspected, tested, and equipped in accordance with subpart E of part 180 of this subchapter as specified for MC 331 cargo tank motor vehicles.

(6) Except as provided in this paragraph (k), it must be operated exclusively in intrastate commerce, including its operation by a motor carrier otherwise engaged in interstate commerce, in a state where its operation was permitted by law (not including the incorporation of this subchapter) prior to January 1, 1981. A cargo tank motor vehicle operating under authority of this section may cross state lines to travel to and from a qualified assembly, repair, maintenance, or requalification facility. The cargo tank need not be cleaned and purged, but it may not contain liquefied petroleum gas in excess of five percent of the water capacity of the cargo tank. If the vehicle engine is supplied fuel from the cargo tank, enough fuel in excess of five percent of the cargo tank's water capacity may be carried for the trip to or from the facility.

(7) It must have been used to transport liquefied petroleum gas prior to January 1, 1981.

(8) It must be operated in conformance with all other requirements of this subchapter.

(1) Anhydrous ammonia must not be offered for transportation or transported in specification MC 330 and MC 331 cargo tanks constructed of quenched and tempered ("QT") steel except as provided in this paragraph.

(1) The ammonia must have a minimum water content of 0.2 percent by weight. Any addition of water must be made using steam condensate, deionized, or distilled water.

(2) Except as otherwise provided in this paragraph, each person offering for transportation or transporting anhydrous ammonia shall perform a periodic analysis for prescribed water content in the ammonia. The analysis must be performed:

(i) From a sample of the ammonia in storage taken at least once every 7 days, or each time ammonia is added to the storage tanks, whichever is less frequent; or

(ii) At the time the cargo tanks are loaded, then a sample of the ammonia

taken from at least one loaded cargo tank out of each 10 loads, or from one cargo tank every 24 hours, whichever is less frequent; or

(iii) At the same frequency as described in paragraph (1)(2)(ii) of this section, from a sample taken from the loading line to the cargo tank.

(3) If water is added at the time of loading:

(i) The sample for analysis must be taken from a point in the loading line between the water injection equipment and the cargo tank; and

(ii) Positive provisions must be made to assure water injection equipment is operating.

(4) If water injection equipment becomes inoperative, suitable corrective maintenance must be performed after which a sample from the first loaded cargo tank must be analyzed for prescribed water content.

(5) The analysis method for water content must be as prescribed in CGA G-2.2, "Tentative Standard Method for Determining Minimum of 0.2 percent water in Anhydrous Ammonia," (IBR, see §171.7 of this subchapter).

(6) Records indicating the results of the analysis taken, as required by this paragraph, must be retained for 2 years and must be open to inspection by a representative of the Department.

(7) Each person receiving anhydrous ammonia containing 0.2 per cent water by weight may offer for transportation or transport that ammonia without performing the prescribed analysis for water content provided:

(i) The ammonia received was certified as containing 0.2 percent water as prescribed in §§172.203(h)(1)(i) and 177.817(a) of this subchapter; and

(ii) The amount of water in the ammonia has not been reduced by any means.

(m) *General.* (1) A cargo tank that is commonly known as a nurse tank and considered an implement of husbandry transporting anhydrous ammonia and operated by a private motor carrier exclusively for agricultural purposes is excepted from the specification requirements of part 178 of this subchapter if it:

(i) Has a minimum design pressure of 250 psig, meets the requirements of the edition of Section VIII of the ASME

Code in effect at the time it was manufactured, and is marked with a valid ASME plate.

(ii) Is equipped with pressure relief valves meeting the requirements of CGA Standard S-1.2 (IBR, see §171.7 of this subchapter);

(iii) Is painted white or aluminum;

(iv) Has a capacity of 3,000 gallons or less;

(v) Is loaded to a filling density no greater than 56 percent;

(vi) Is securely mounted on a farm wagon or meets paragraph (m)(3) of this section; and

(vii) Is in conformance with the requirements of part 172 of this subchapter except that shipping papers are not required; and it need not be marked or placarded on one end if that end contains valves, fittings, regulators or gauges when those appurtenances prevent the markings and placard from being properly placed and visible.

(2) *Nurse tanks with missing or illegible ASME plates.* Nurse tanks with missing or illegible ASME plates may continue to be operated provided they conform to the following requirements:

(i) Each nurse tank must undergo an external visual inspection and testing in accordance with §180.407(d) of this subchapter.

(ii) Each nurse tank must be thickness tested in accordance with §180.407(i) of this subchapter. A nurse tank with a capacity of less than 1,500 gallons must have a minimum head thickness of 0.203 inch and a minimum shell thickness of 0.239 inch. A nurse tank with a capacity of 1,500 gallons or more must have a minimum thickness of 0.250 inch. Any nurse tank with a thickness test reading of less than that specified in this paragraph at any point must be removed from hazardous materials service.

(iii) Each nurse tank must be pressure tested in accordance with §180.407(g) of this subchapter. The minimum test pressure is 375 psig. Pneumatic testing is not authorized.

(iv) Each nurse tank must be inspected and tested by a person meeting the requirements of §180.409(d) of this subchapter. Furthermore, each nurse tank must have the tests performed at

§ 173.315

49 CFR Ch. I (10–1–14 Edition)

least once every five years after the completion of the initial tests.

(v) After each nurse tank has successfully passed the visual, thickness, and pressure tests, welded repairs on the tank are prohibited.

(vi) After the nurse tank has successfully passed the visual, thickness, and pressure tests, it must be marked in accordance with § 180.415(b), and permanently marked near the test and inspection markings with a unique owner's identification number in letters and numbers at least ½ inch in height and width.

(vii) Each nurse tank owner must maintain a copy of the test inspection report prepared by the inspector. The test report must contain the results of the test and meet the requirements in § 180.417(b) and be made available to a DOT representative upon request.

(3) *Field truck mounted tanks.* A non-DOT specification cargo tank (nurse tank) securely mounted on a field truck is authorized under the following conditions:

(i) The tank is in conformance with all the requirements of paragraph (m)(1) of this section, except that the requirement in paragraph (m)(1)(vi) does not apply;

(ii) The tank is inspected and tested in accordance with subpart E of part 180 of this subchapter as specified for an MC 331 cargo tank;

(iii) The tank is restricted to rural roads in areas within 50 miles of the fertilizer distribution point where the nurse tank is loaded; and

(iv) For the purposes of this section, a field truck means a vehicle on which a nurse tank is mounted that is designed to withstand off-road driving on hilly terrain. Specifically, the vehicle must be outfitted with stiffer suspension (for example, additional springs or airbags) than would be necessary for a comparable on-road vehicle, a rear axle ratio that provides greater low end torque, and a braking system and tires designed to ensure stability in hilly terrain. The field truck must have low annual over-the-road mileage and be used exclusively for agricultural purposes.

(n) *Emergency discharge control for cargo tank motor vehicles in liquefied compressed gas service—(1) Required emergency discharge control equipment.* Each cargo tank motor vehicle in liquefied compressed gas service must have an emergency discharge control capability as specified in the following table:

§ 173.315(n)(1)(*)	Material	Delivery service	Required emergency discharge control capability
(i)	Division 2.2 materials with no subsidiary hazard, excluding anhydrous ammonia.	All	None.
(ii)	Division 2.3 materials	All	Paragraph (n)(2) of this section.
(iii)	Division 2.2 materials with a subsidiary hazard, Division 2.1 materials, and anhydrous ammonia.	Other than metered delivery service.	Paragraph (n)(2) of this section.
(iv)	Division 2.2 materials with a subsidiary hazard, Division 2.1 materials, and anhydrous ammonia in a cargo tank motor vehicle with a capacity of 13,247.5 L (3,500 water gallons) or less.	Metered delivery service	Paragraph (n)(3) of this section.
(v)	Division 2.2 materials with a subsidiary hazard, Division 2.1 materials, and anhydrous ammonia in a cargo tank motor vehicle with a capacity greater than 13,247.5 L (3,500 water gallons).	Metered delivery service	Paragraph (n)(3) of this section, and, for obstructed view deliveries where permitted by § 177.840(p) of this subchapter, paragraph (n)(2) or (n)(4) of this section.

§ 173.315(n)(1)(*)	Material	Delivery service	Required emergency discharge control capability
(vi)	Division 2.2 materials with a subsidiary hazard, Division 2.1 materials, and anhydrous ammonia in a cargo tank with a capacity of greater than 13,247.5 L (3,500 water gallons).	Both metered delivery and other than metered delivery service.	Paragraph (n)(2) of this section, provided the system operates for both metered and other than metered deliveries; otherwise, paragraphs (n)(2) and (n)(3) of this section.

(2) *Cargo tank motor vehicles in other than metered delivery service.* A cargo tank motor vehicle in other than metered delivery service must have a means to automatically shut off the flow of product without the need for human intervention within 20 seconds of an unintentional release caused by a complete separation of a liquid delivery hose (passive shut-down capability).

(i) Designed flow of product through a bypass in the valve is acceptable when authorized by this subchapter.

(ii) The design for the means to automatically shut off product flow must be certified by a Design Certifying Engineer. The certification must consider any specifications of the original component manufacturer and must explain how the passive means to shut off the flow of product operates. It must also outline the parameters (e.g., temperature, pressure, types of product) within which the passive means to shut off the flow of product is designed to operate. All components of the discharge system that are integral to the design must be included in the certification. A copy of the design certification must be provided to the owner of the cargo tank motor vehicle on which the equipment will be installed.

(iii) Installation must be performed under the supervision of a Registered Inspector unless the equipment is installed and removed as part of regular operation (e.g., a hose). The Registered Inspector must certify that the equipment is installed and tested, if it is possible to do so without damaging the equipment, in accordance with the Design Certifying Engineer's certification. The Registered Inspector must provide the certification to the owner of the cargo tank motor vehicle.

(3) *Cargo tank motor vehicles in metered delivery service.* When required by the table in paragraph (n)(1) of this section,

a cargo tank motor vehicle must have an off-truck remote means to close the internal self-closing stop valve and shut off all motive and auxiliary power equipment upon activation by a qualified person attending the unloading of the cargo tank motor vehicle (off-truck remote shut-off). It must function reliably at a distance of 45.72 m (150 feet). The off-truck remote shut-off activation device must not be capable of reopening the internal self-closing stop valve after emergency activation.

(i) The emergency discharge control equipment must be installed under the supervision of a Registered Inspector. Each wireless transmitter/receiver must be tested to demonstrate that it will close the internal self-closing stop valve and shut off all motive and auxiliary power equipment at a distance of 91.44 m (300 feet) under optimum conditions. Emergency discharge control equipment that does not employ a wireless transmitter/receiver must be tested to demonstrate its functioning at the maximum length of the delivery hose.

(ii) The Registered Inspector must certify that the remote control equipment is installed in accordance with the original component manufacturer's specifications and is tested in accordance with paragraph (n)(3)(i) of this section. The Registered Inspector must provide the owner of the cargo tank motor vehicle with this certification.

(4) *Query systems.* When a transmitter/receiver system is used to satisfy the requirements of paragraph (n)(1)(v) of this section, it must close the internal self-closing stop valve and shut off all motive and auxiliary power equipment unless the qualified person attending the unloading operation prevents it from doing so at least once

§ 173.316

49 CFR Ch. I (10–1–14 Edition)

every five minutes. Testing and certification must be as specified in paragraph (n)(3) of this section.

(5) *Compliance dates.* (i) Each specification MC 331 cargo tank motor vehicle with a certificate of construction issued two or more years after July 1, 1999, must have an appropriate emergency discharge control capability as specified in this paragraph (n).

(ii) No MC 330, MC 331, or nonspecification cargo tank motor vehicle authorized under paragraph (k) of this section may be operated unless it has an appropriate emergency discharge control capability as specified in this paragraph (n) no later than the date of its first scheduled pressure retest required after July 1, 2001. No MC 330, MC 331 or nonspecification cargo tank motor vehicle authorized under paragraph (k) of this section may be operated after July 1, 2006, unless it has been equipped with emergency discharge control equipment as specified in this paragraph (n).

(iii) No MC 330 or MC 331 cargo tank motor vehicle with a capacity over 13,247 L (3,500 gallons) used in metered delivery service may be operated unless it has an appropriate discharge control capability as specified in this paragraph (n) no later than July 1, 2003, or the date of its first scheduled pressure retest required after July 1, 2001, whichever is earlier.

(o) *Chlorine cargo tank motor vehicles.* Each cargo tank motor vehicle used for the transportation of chlorine must meet the requirements in the following:

(1) Any hose, piping, or tubing used for loading or unloading that is mounted or carried on the motor vehicle may not be attached to any valve and must be capped at all ends to prevent the entry of moisture, except at the time of loading or unloading. Except at the time of loading and unloading, the pipe connection of each angle valve must be closed with a screw plug which is chained or otherwise fastened to prevent misplacement.

(2) Each chlorine cargo tank motor vehicle angle valve must be tested to be leak free at not less than 225 psig using dry air or inert gas before installation and thereafter every 2 years when performing the required periodic

retest in §180.407(c) of this subchapter. Prior to each loading, the cargo tank motor vehicle must be inspected and the angle valves and gasketed joints must be examined and tested at a pressure of not less than 50 psig to determine that they are not leaking and are in proper condition for transportation. Any leaks must be corrected before the cargo tank motor vehicle is offered for transportation.

(3) Excess flow valves on the cargo tank motor vehicle must meet the requirements of paragraph (n) of this section.

(p) *Fusible elements.* Each MC 330, MC 331, or nonspecification cargo tank authorized under paragraph (k) of this section must have a thermal means of closure for each internal self-closing stop valve as specified in §178.337–8(a)(4) of this subchapter.

(q) Manifolding is authorized for cargo tanks containing anhydrous ammonia provided each individual cargo tank is equipped with a pressure relief device or valves and gauging devices as required by paragraphs (h) and (i) of this section. Each valve must be tightly closed while the cargo tank is in transit. Each cargo tank must be filled separately.

[29 FR 18743, Dec. 29, 1964. Redesignated at 32 FR 5606, Apr. 5, 1967]

EDITORIAL NOTE: For FEDERAL REGISTER citations affecting §173.315, see the List of CFR Sections Affected, which appears in the Finding Aids section of the printed volume and at www.fdsys.gov.

§ 173.316 Cryogenic liquids in cylinders.

(a) *General requirements.* (1) A cylinder may not be loaded with a cryogenic liquid colder than the design service temperature of the packaging.

(2) A cylinder may not be loaded with any material which may combine chemically with any residue in the packaging to produce an unsafe condition.

(3) The jacket covering the insulation on a cylinder used to transport any flammable cryogenic liquid must be made of steel.

(4) A valve or fitting made of aluminum with internal rubbing or abrading aluminum parts that may come in contact with oxygen in the cryogenic

liquid form may not be installed on any cylinder used to transport oxygen, cryogenic liquid unless the parts are anodized in accordance with ASTM Standard B 580 (IBR, see §171.7 of this subchapter).

(5) An aluminum valve, pipe or fitting may not be installed on any cylinder used to transport any flammable cryogenic liquid.

(6) Each cylinder must be provided with one or more pressure relief devices, which must be installed and maintained in compliance with the requirements of this subchapter.

(7) Each pressure relief device must be installed and located so that the cooling effect of the contents during venting will not prevent effective operation of the device.

(8) All pressure relief device inlets must under maximum filling conditions be situated in the vapor space of the closed cryogenic receptacle and the devices must be arranged to ensure that the escaping vapor is discharged unobstructed.

(9) The maximum weight of the contents in a cylinder with a design serv-

ice temperature colder than -320 °F. may not exceed the design weight marked on the cylinder (see §178.35 of this subchapter).

(b) *Pressure control systems.* Each cylinder containing a cryogenic liquid must have a pressure control system that conforms to §173.301(f) and is designed and installed so that it will prevent the cylinder from becoming liquid full.

(c) *Specification cylinder requirements and filling limits.* Specification DOT-4L cylinders (§178.57 of this subchapter) are authorized for the transportation of cryogenic liquids when carried in the vertical position as follows:

(1) For purposes of this section, "filling density," except for hydrogen, is defined as the percent ratio of the weight of lading in the packaging to the weight of water that the packaging will hold at 60 °F. (1 lb. of water = 27.737 cubic inches at 60 °F.).

(2) The cryogenic liquids of argon, nitrogen, oxygen, helium and neon must be loaded and shipped in accordance with the following table:

Pressure control valve setting (maximum start-to-discharge pressure psig)	Maximum permitted filling density (percent by weight)					
	Air	Argon	Nitrogen	Oxygen	Helium	Neon
45	82.5	133	76	108	12.5	109
75	80.3	130	74	105	12.5	104
105	78.4	127	72	103	12.5	100
170	76.2	122	70	100	12.5	92
230	75.1	119	69	98	12.5	85
295	73.3	115	68	96	12.5	77
360	70.7	113	65	93	12.5	
450	65.9	111	61	91	12.5	
540	62.9	107	58	88	12.5	
625	60.1	104	55	86	12.5	
Design service temperature (°F.)	-320	-320	-320	-320	-452	-411

(3) Hydrogen (minimum 95 percent parahydrogen) must be loaded and shipped as follows:

Column 1	Column 2
Design service temperature	Minus 423 °F. or colder.
Maximum permitted filling density, based on cylinder capacity at minus 423 °F (see Note 1).	6.7 percent.
The pressure control valve must be designed and set to limit the pressure in the cylinder to not more than.	17 psig.

NOTE 1: The filling density for hydrogen, cryogenic liquid is defined as the percent ratio of the weight of lading in a packaging

to the weight of water that the packaging will hold at minus 423 °F. The volume of the packaging at minus 423 °F is determined in cubic inches. The volume is converted to pounds of water (1 lb. of water = 27.737 cubic inches).

(i) Each cylinder must be constructed, insulated and maintained so that during transportation the total rate of venting shall not exceed 30 SCF of hydrogen per hour.

(ii) In addition to the marking requirements in §178.35 of this subchapter, the total rate of venting in SCF per hour (SCFH) shall be marked

§ 173.318

49 CFR Ch. I (10–1–14 Edition)

on the top head or valve protection band in letters at least one-half inch high as follows: “VENT RATE**SCFH” (with the asterisks replaced by the number representing the total rate of venting, in SCF per hour).

(iii) Carriage by highway is subject to the conditions specified in § 177.840(a) of this subchapter.

(d) *Mixtures of cryogenic liquid.* Where charging requirements are not specifically prescribed in paragraph (c) of this section, the cryogenic liquid must be shipped in packagings and under conditions approved by the Associate Administrator.

[Amdt. 173–166, 48 FR 27695, June 16, 1983, as amended by Amdt. 173–166, 49 FR 24314, June 12, 1984; Amdt. 173–180, 49 FR 42735, Oct. 24, 1984; Amdt. 173–201, 52 FR 13041, Apr. 20, 1987; Amdt. 173–250, 61 FR 25942, May 23, 1996; Amdt. 173–261, 62 FR 24741, May 6, 1997; 66 FR 45379, Aug. 28, 2001; 67 FR 16013, Sept. 27, 2002; 68 FR 75742, Dec. 31, 2003; 69 FR 54046, Sept. 7, 2004; 78 FR 1092, Jan. 7, 2013]

§ 173.318 Cryogenic liquids in cargo tanks.

(a) *General requirements.* (1) A cargo tank may not be loaded with a cryogenic liquid colder than the design service temperature of the packaging.

(2) A cargo tank may not be loaded with any material that may combine chemically with any residue in the packaging to produce an unsafe condition (see § 178.338–15).

(3) The jacket covering the insulation on a tank used to transport a cryogenic liquid must be made of steel if the cryogenic liquid:

(i) Is to be transported by vessel (see § 176.76(g) of this subchapter); or

(ii) Is oxygen or a flammable material.

(4) A valve or fitting made of aluminum with internal rubbing or abrading aluminum parts that may come in contact with oxygen in the cryogenic liquid form may not be installed on any cargo tank used to transport oxygen, cryogenic liquid unless the parts are anodized in accordance with ASTM Standard B 580 (IBR, see § 171.7 of this subchapter).

(5) An aluminum valve, pipe or fitting, external to the jacket that retains lading during transportation may not be installed on any cargo tank used

to transport oxygen, cryogenic liquid or any flammable cryogenic liquid.

(6) A cargo tank used to transport oxygen, cryogenic liquid must be provided with a manhole (see § 178.338–6 of this subchapter).

(b) *Pressure relief systems and pressure control valves—*(1) *Types of pressure relief systems—*(i) *Tanks in oxygen and flammable cryogenic liquid service.* Except as otherwise provided in this paragraph, each tank in oxygen and flammable cryogenic liquid service must be protected by two independent pressure relief systems which are not connected in series, namely:

(A) A primary system of one or more pressure relief valves; and

(B) A secondary system of one or more frangible discs or pressure relief valves. For a tank in carbon monoxide service, the secondary system must be pressure relief valves only.

(ii) *Tanks in helium and atmospheric gas (except oxygen) cryogenic liquid service.* For a tank used in helium and atmospheric gas (except oxygen) cryogenic liquid service, the tank must be protected by at least one pressure relief system consisting of:

(A) One or more pressure relief valves; or

(B) A combination of one or more pressure relief valves and one or more frangible discs.

(2) *Capacities of pressure relief systems—*(i) *Tanks in oxygen or flammable cryogenic liquid service.* For tanks in oxygen or flammable cryogenic liquid service, the primary system and the secondary system of pressure relief devices must each have a flow capacity equal to or greater than that calculated by the applicable formula in paragraph 5.3.2 or paragraph 5.3.3 of CGA S–1.2 (IBR, see § 171.7 of this subchapter). In addition:

(A) The primary pressure relief system must have a total flow capacity at a pressure not exceeding 120 percent of the tank’s design pressure.

(B) The secondary pressure relief system must have a total flow capacity at a pressure not exceeding 150 percent of the tank’s design pressure.

(C) The flow capacity and rating must be verified and marked by the manufacturer of the device in accordance with CGA Pamphlet S–1.2.

(ii) *Tanks in helium and atmospheric gas (except oxygen) cryogenic liquid service.* For tanks in helium and atmospheric gas (except oxygen) cryogenic liquid service, the pressure relief system must have a flow capacity equal to or greater than that calculated by the applicable formula in paragraphs 5.3.2 or 5.3.3 of CGA Pamphlet S-1.2. If the pressure relief system consists of a combination of pressure relief valves and frangible discs, the pressure relief valves must have a total venting capacity equal to or greater than that calculated by the applicable formula in paragraph 4.1.10.1.1 of CGA Pamphlet S-1.2. The pressure relief system must have this total flow capacity at a pressure not exceeding 150 percent of the tank's design pressure. The flow capacity and rating must be verified and marked by the manufacturer of the device in accordance with CGA Pamphlet S-1.2.

(3) *Type and construction of pressure relief devices.* (i) Each pressure relief device must be designed and constructed for a pressure equal to or exceeding the tank's design pressure at the coldest temperature reasonably expected to be encountered.

(ii) Pressure relief devices must be either spring-loaded pressure relief valves or frangible discs. Pressure relief valves must be of a type that automatically open and close at predetermined pressures.

(4) *Setting of pressure relief devices.* (i) On a tank used in oxygen or flammable cryogenic liquid service, the pressure relief devices must perform as follows.

(A) Each pressure relief valve in the primary relief system must be set-to-discharge at a pressure no higher than 110 percent of the tank's design pressure.

(B) Each pressure relief device in the secondary pressure relief system must be designed to commence functioning at a pressure no lower than 130 percent and no higher than 150 percent of the tank's design pressure.

(ii) On a tank used in helium and atmospheric gas (except oxygen) cryogenic liquid service, the pressure relief devices in the pressure relief system must be designed to commence functioning at no higher than 150 percent of the tank's design pressure.

(5) *Optional pressure relief devices and pressure control valves.* In addition to the required pressure relief devices, a cargo tank in cryogenic liquid (except carbon monoxide) service may be equipped with one or both of the following:

(i) One or more pressure control valves set at a pressure below the tank's design pressure.

(ii) One or more frangible discs set to function at a pressure not less than one and one-half times or more than two times the tank's design pressure.

(6) *Maximum filling rate.* (i) For a tank used in oxygen and flammable cryogenic liquid service, the maximum rate at which the tank is filled must not exceed the liquid flow capacity of the primary pressure relief system rated at a pressure not exceeding 120 percent of the tank's design pressure.

(ii) On a tank used in helium and atmospheric gas (except oxygen) cryogenic liquid service, the maximum rate at which the tank is filled must not exceed the liquid flow capacity of the pressure relief valves rated at 150 percent of the tank's design pressure.

(7) *Arrangement and location of pressure relief devices.* (i) The discharge from any pressure relief system must be directed upward and be unobstructed to the outside of the protective housing in such a manner as to prevent impingement of gas upon the jacket or any structural part of the vehicle.

(ii) Each pressure relief valve must be arranged or protected to prevent the accumulation of foreign material between the relief valve and the atmospheric discharge opening in any relief piping. The arrangement must not impede flow through the device.

(iii) Each pressure relief valve must be designed and located to minimize the possibility of tampering. If the pressure setting or adjustment is external to the valve, the valve adjustment must be sealed.

(iv) Each pressure relief device must have direct communication with the vapor space of the tank at the midlength of the top centerline.

(v) Each pressure relief device must be installed and located so that the cooling effect of the contents during

§ 173.318

venting will not prevent the effective operation of the device.

(vi) All pressure relief device inlets must under maximum filling conditions be situated in the vapor space of the closed cryogenic receptacle and the devices must be arranged to ensure that the escaping vapor is discharged unobstructed.

(8) *Connections.* (i) Each connection to a pressure relief device must be of sufficient size to allow the required rate of discharge through the pressure relief device. The inlet connection must be not less than one-half inch nominal pipe size.

(ii) A shut-off valve may be installed in a pressure relief system only when the required relief capacity is provided at all times.

(9) *Pressure relief devices for piping hose and vacuum-insulated jackets.* (i) Each portion of connected liquid piping or hose that can be closed at both ends must be provided with either a hydrostatic pressure relief valve without an intervening shut-off valve, or a check valve permitting flow from the pipe or hose into the tank. If used, the relief valve must be located so as to prevent its discharge from impinging on the tank, piping, or operating personnel.

(ii) On a vacuum-insulated cargo tank the jacket must be protected by a suitable relief device to release internal pressure. The discharge area of this device must be at least 0.00024 square inch per pound of water capacity of the tank. This relief device must function at a pressure not exceeding the internal design pressure of the jacket, calculated in accordance with Section VIII of the ASME Code (IBR, see §171.7 of this subchapter), or 25 psig, whichever is less.

(10) *Tank inlet, outlet, pressure relief device and pressure control valve markings.* (i) Each tank inlet and outlet, except pressure relief devices and pressure control valves, must be permanently marked to indicate whether it communicates with "vapor" or "liquid" when the tank is filled to the maximum permitted filling density.

(ii) Each pressure relief valve must be plainly and permanently marked with the pressure, in psig, at which it is set-to-discharge, the discharge rate of the device in SCF per minute

49 CFR Ch. I (10-1-14 Edition)

(SCFM) of free air, and the manufacturer's name or trade name and catalog number. The marked set-to-discharge pressure valve must be visible with the valve in its installed position. The rated discharge capacity of the device must be determined at a pressure of 120 percent of the design pressure of the tank.

(iii) Each pressure control valve must be plainly and permanently marked with the pressure, in psig, at which it is set-to-discharge.

(c) *Weight of lading requirements.* The weight of a cryogenic liquid in the tank must be determined by weighing or by the use of a liquid level gauging device authorized in §178.338-14(a) of this subchapter, and may not exceed the lesser of:

(1) The weight of lading in the tank, based on the water capacity stamped on the nameplate (§178.338-18(a)(4) of this subchapter) and the appropriate maximum permitted filling density specified in paragraph (f) of this section; or

(2) The maximum weight of lading for which the cargo tank was designed, as marked on the specification plate (see §178.338-18(b) of this subchapter).

(d) *Outage.* Except for a cargo tank containing helium, cryogenic liquid, a cargo tank offered for transportation must have an outage of at least two percent below the inlet of the pressure relief device or pressure control valve, under conditions of incipient opening, with the tank in a level attitude.

(e) *Temperature.* A flammable cryogenic liquid in a cargo tank at the start of travel must be at a temperature sufficiently cold that the pressure setting of the pressure control valve or the required pressure relief valve, whichever is lower, will not be reached in less time than the marked rated holding time for the cryogenic liquid (see paragraph (g)(3) of this section and §178.338-9(b) of this subchapter).

(f) *Specification MC-338 (§178.338 of this subchapter) cargo tanks* are authorized for the shipment of the following cryogenic liquids subject to the following additional requirements:

(1) For purposes of this section, "filling density" is defined as the percent ratio of the weight of lading in the tank to the weight of water that the

Pipeline and Haz. Matls. Safety Admin., DOT

§ 173.318

tank will hold at the design service temperature (one pound of water=27.737 cubic inches at 60 °F., or one gallon of water = 231 cubic inches at 60 °F. and weighs 8.32828 pounds).

(2) Air, argon, helium, nitrogen, and oxygen, cryogenic liquids must be loaded and shipped in accordance with the following table:

PRESSURE CONTROL VALVE SETTING OR RELIEF VALVE SETTING

Maximum set-to-discharge pressure (psig)	Maximum permitted filling density (percent by weight)				
	Air	Argon	Helium	Nitrogen	Oxygen
26			12.5		
30	80.3	129	12.5	74	105
40	79.2		12.5		
50	78.0		12.5		
55	77.3	125	12.5	71	102
60	76.9		12.5		
80	75.3		12.5		
85	75.1	121	12.5		99
100	73.0		12.5		
105	73.7		12.5	67	
120	72.2		12.5		
140	71.4		12.5		
145	70.9	115	12.5	64	94
180	68.3		12.5		
200	67.3	110	12.5	61	91
250	63.3	106	12.5	57	87
275	62.3	105	12.5	56	86
325	59.4	101		53	83
Design service temperature.	-320 °F	-320 °F	-452 °F	-320 °F	-320 °F

(3) Carbon monoxide, hydrogen (minimum 95 percent para-hydrogen), ethylene, and methane or natural gas, cryo-

genic liquids must be loaded and shipped in accordance with the following table:

PRESSURE CONTROL VALVE SETTING OR RELIEF VALVE SETTING

Maximum set-to-discharge pressure (psig)	Maximum permitted filling density (percent by weight)			
	Carbon monoxide	Ethylene	Hydrogen	Methane or natural gas
13			6.6	
15	75.0		6.6	40.5
17	74.0		6.6	
20		53.5		40.0
25	73.0			
30	72.0	52.7	6.3	39.1
35				
40		52.0		38.6
45	71.5			
50		51.4	6.0	38.2
55				
60		50.8		
70		50.2	5.7	37.5
90		49.2		
95				
100		48.4	5.4	36.6
115		48.2		
125			5.0	
150			4.5	
175	62.5	45.8		
285	56.0			
Design service temperature.	-320 °F	-155 °F	-423 °F	-260 °F

(4) *Mixtures of cryogenic liquid.* Where charging requirements are not specifically prescribed in this paragraph (f), the cryogenic liquid must be shipped in packagings and under conditions approved by the Associate Administrator.

(g) *One-way travel time; marking.* The jacket of a cargo tank to be used to transport a flammable cryogenic liquid must be marked on its right side near the front, in letters and numbers at least two inches high, “One-Way-Travel-Time ___ hrs.”, with the blank filled in with a number indicating the one-way travel time (OWTT), in hours, of the cargo tank for the flammable cryogenic liquid to be transported. A cargo tank that is partially unloaded at one or more locations must have additional marking “One-Way-Travel-Time ___ hrs. ___ psig to ___ psig at ___ percent filling density,” with the second blank filled in with the pressure existing after partial unloading and the third blank filled in with the set-to-discharge pressure of the control valve or pressure relief valve, and the fourth blank with the filling density following partial unloading. Multiple OWTT markings for different pressure levels are permitted. The abbreviation “OWTT” may be used in place of the words “One-way-travel-time” in the marking required by this paragraph.

(1) OWTT is based on the marked rated holding time (MRHT) of the cargo tank for the cryogenic liquid to be transported in the cargo tank. If the MRHT for the flammable cryogenic liquid is not displayed on or adjacent to the specification plate, this MRHT may be derived.

(2) The MRHT is converted to OWTT, in hours, as follows:

(i) For a tank with an MRHT of 72 hours or less,

$$\text{OWTT} = (\text{MRHT} - 24) / 2$$

(ii) For a tank with an MRHT greater than 72 hours,

$$\text{OWTT} = \text{MRHT} - 48$$

(3) Each cargo tank motor vehicle used to transport a flammable cryogenic liquid must be examined after each shipment to determine its actual holding time. The record required by §177.840(h) of this subchapter may be used for this determination. If the ex-

amination indicates that the actual holding time of the cargo tank, after adjustment to reflect an average ambient temperature of 85 °F, is less than 90 percent of the marked rated holding time (MRHT) for the cryogenic liquid marked on the specification plate or adjacent thereto (see §178.338–18(b) of this subchapter), the tank may not be refilled with any flammable cryogenic liquid until it is restored to its marked rated holding time value or it is re-marked with the actual marked rated holding time determined by this examination. If the name of the flammable cryogenic liquid that was transported and its marked rated holding time is not displayed on or adjacent to the specification plate, this requirement may be met by deriving the MRHT of the cargo tank for that flammable cryogenic liquid and comparing that derived MRHT with the actual holding time after adjustment.

[Amdt. 173–166, 48 FR 27696, June 16, 1983]

EDITORIAL NOTE: For FEDERAL REGISTER citations affecting §173.318, see the List of CFR Sections Affected, which appears in the Finding Aids section of the printed volume and at www.fdsys.gov.

§173.319 Cryogenic liquids in tank cars.

(a) *General requirements.* (1) A tank car containing a flammable cryogenic liquid may not be shipped unless it was loaded by, or with the consent of, the owner of the tank car.

(2) The amount of flammable cryogenic liquid loaded into a tank car must be determined, either by direct measurement or by calculation based on weight, to verify that the tank has not been filled to a level in excess of the limits specified in paragraph (d)(2) of this section. The weight of any flammable cryogenic liquid loaded, except hydrogen, must be checked by use of scales after disconnecting the loading line.

(3) The shipper must notify the Federal Railroad Administration whenever a tank car containing any flammable cryogenic liquid is not received by the consignee within 20 days from the date of shipment. Notification to the Federal Railroad Administration may be made by email to HMassist@dot.gov or telephone call to (202) 493–6245.

(4) A tank car may not be loaded with any flammable cryogenic liquid:

(i) That may combine chemically with any residue in the tank to produce an unsafe condition,

(ii) That is colder than the design service temperature of the tank,

(iii) If the average daily pressure rise in the tank exceeded 3 psig during the prior shipment,

(iv) Unless it is marked with the name of contents, in accordance with §172.330 of this subchapter.

(b) When a tank car containing a flammable cryogenic liquid is offered for transportation:

(1) At least 0.5 percent outage must be provided below the inlet of the pressure relief or pressure control valve at the start-to-discharge pressure setting of the valve, with the tank car in a level attitude, and

(2) The absolute pressure in the annular space must be less than 75 microns of mercury.

(c) *Temperature.* A flammable cryogenic liquid must be loaded into a tank car at such a temperature that the average daily pressure rise during transportation will not exceed 3 psig (see paragraph (a)(4)(iii) of this section).

(d) A Class DOT-113 tank car is authorized for the shipment of the following cryogenic liquids subject to the following additional requirements:

(1) For purposes of this section, "filling density" is defined as the percent ratio of the weight of lading in the tank to the weight of water that the tank will hold at the design service temperature (one pound of water = 27.737 cubic inches at 60 °F., or one gallon of water = 231 cubic inches at 60 °F. and weighs 8.32828 pounds).

(2) *Ethylene, and hydrogen (minimum 95 percent parahydrogen), cryogenic liquids* must be loaded and shipped in accordance with the following table:

PRESSURE CONTROL VALVE SETTING OR RELIEF VALVE SETTING

Maximum start-to-discharge pressure (psig)	Maximum permitted filling density (percent by weight)			
	Ethylene	Ethylene	Ethylene	Hydrogen
17	6.60.
45	52.8.
75	51.1	51.1.
Maximum pressure when offered for transportation.	10 psig	10 psig	20 psig.
Design service temperature	Minus 260 °F	Minus 260 °F	Minus 155 °F	Minus 423 °F.
Specification (see § 180.507(b)(3) of this subchapter).	113D60W	113C120W	113D120W	113A175W.
	113C60W			113A60W.

(e) *Special requirements for class DOT 113 tank cars*—(1) A class DOT-113 tank car need not be periodically pressure tested; however, each shipment must be monitored to determine the average daily pressure rise in the tank car. If the average daily pressure rise during any shipment exceeds 0.2 Bar (3 psig) per day, the tank must be tested for thermal integrity prior to any subsequent shipment.

(2) *Thermal integrity test.* When required by paragraph (e)(1) of this section, either of the following thermal integrity tests may be used:

(i) *Pressure rise test.* The pressure rise in the tank may not exceed 0.34 Bar (5 psig) in 24 hours. When the pressure rise test is performed, the absolute pressure in the annular space of the

loaded tank car may not exceed 75 microns of mercury at the beginning of the test and may not increase more than 25 microns during the 24-hour period; or

(ii) *Calculated heat transfer rate test.* The insulation system must be performance tested as prescribed in §179.400-4 of this subchapter. When the calculated heat transfer rate test is performed, the absolute pressure in the annular space of the loaded tank car may not exceed 75 microns of mercury at the beginning of the test and may not increase more than 25 microns during the 24-hour period. The calculated heat transfer rate in 24 hours may not exceed:

(A) 120 percent of the appropriate standard heat transfer rate specified in

§ 173.320

§179.401-1 of this subchapter, for DOT-113A60W and DOT-113C120W tank cars;

(B) 122.808 joules (0.1164 Btu/day/lb.) of inner tank car water capacity, for DOT-113A175W tank cars;

(C) 345.215 joules (0.3272 Btu/day/lb.) of inner tank car water capacity, for DOT-113C60W and 113D60W tank cars; or

(D) 500.09 joules (0.4740 Btu/day/lb.) of inner tank car water capacity, for DOT-113D120W tank cars.

(3) A tank car that fails a test prescribed in paragraph (e)(2) of this section must be removed from hazardous materials service. A tank car removed from hazardous materials service because it failed a test prescribed in paragraph (e)(2) of this section may not be used to transport a hazardous material unless the tank car conforms to all applicable requirements of this subchapter.

(4) Each rupture disc must be replaced every 12 months, and the replacement date must be marked on the car near the pressure relief valve information.

(5) Pressure relief valves and alternate pressure relief valves must be tested every five years. The start-to-discharge pressure and vapor tight pressure requirements for the pressure relief valves must be as specified in §179.401-1 of this subchapter. The alternate pressure relief device values specified in §179.401-1 of this subchapter for a DOT-113C120W tank car apply to a DOT-113D120W tank car.

(49 U.S.C. 1803, 1804, 1808; 49 CFR 1.53, app. A to part 1)

[Amdt. 173-166, 48 FR 27698, June 16, 1983, as amended by Amdt. 173-245, Sept. 21, 1995; 65 FR 58630, Sept. 29, 2000; 66 FR 45184, 45379, 45383, Aug. 28, 2001; 70 FR 34076, June 13, 2005]

§ 173.320 Cryogenic liquids; exceptions.

(a) Atmospheric gases and helium, cryogenic liquids, in Dewar flasks, insulated cylinders, insulated portable tanks, insulated cargo tanks, and insulated tank cars, designed and constructed so that the pressure in such packagings will not exceed 25.3 psig under ambient temperature conditions during transportation are not subject to the requirements of this subchapter when transported by motor vehicle or

49 CFR Ch. I (10-1-14 Edition)

railcar except as specified in paragraphs (a)(1), (a)(2), and (a)(3) of this section.

(1) Sections 171.15 and 171.16 of this subchapter pertaining to the reporting of incidents, not including a release that is the result of venting through a pressure control valve, or the neck of the Dewar flask.

(2) Subparts A, B, C, D, G and H of part 172, (§§174.24 for rail and 177.817 for highway) and in addition, part 172 in its entirety for oxygen.

(3) Subparts A and B of part 173, and §§174.1 and 177.800, 177.804, and 177.823 of this subchapter.

(b) The requirements of this subchapter do not apply to atmospheric gases and helium:

(1) During loading and unloading operations (pressure rises may exceed 25.3 psig); or

(2) When used in operation of a process system; such as a refrigeration system (pressure may exceed 25.3 psig).

(c) For transportation aboard aircraft, see the ICAO Technical Instructions (IBR, see §171.7 of this subchapter), Packing Instruction 202 and the packaging specifications in part 6, chapter 5.

[Amdt. 173-201, 52 FR 13043, Apr. 20, 1987, as amended at 62 FR 51561, Oct. 1, 1997; 66 FR 33436, June 21, 2001; 67 FR 61014, Sept. 27, 2002; 68 FR 48570, Aug. 14, 2003; 68 FR 75746, Dec. 31, 2003]

§ 173.321 Ethylamine.

Ethylamine must be packaged as follows:

(a) In 1A1 drums which meet Packing Group I performance level requirements.

(b) In specification cylinders as prescribed for any compressed gas except acetylene.

[Amdt. 173-224, 55 FR 52667, Dec. 21, 1990]

§ 173.322 Ethyl chloride.

Ethyl chloride must be packaged in any of the following single or combination non-bulk packagings which meet Packing Group I performance level requirements:

(a) In 4C1, 4C2, 4D or 4F wooden boxes with glass, earthenware, or metal inner receptacles not over 500 g (17.6 ounces) capacity each;

(b) In 4G fiberboard boxes with glass, earthenware, or metal inner receptacles not over 500 g (17.6 ounces) capacity each. Outer packagings may not exceed 30 kg (66 pounds) gross weight;

(c) In 1A1 drums of not over 100 L (26 gallons) capacity each; or

(d) In specification cylinders as prescribed for any compressed gas except acetylene. Cylinders made of aluminum alloy are not authorized.

(e) In capsules under the following conditions:

(1) The mass of gas must not exceed 150 g (5.30 ounces) per capsule;

(2) The capsule must be free of faults liable to impair its strength;

(3) The leakproofness integrity of the closure must be maintained by a secondary means (*e.g.*, cap, crown, seal, binding, *etc.*) capable of preventing any leakage of the closure while in transportation; and

(4) The capsules must be placed in a strong outer packaging suitable for the contents and may not exceed a gross mass of 75 kg (165 pounds).

[Amdt. 173-224, 55 FR 52667, Dec. 21, 1990, as amended at 74 FR 2266, Jan. 14, 2009; 76 FR 3381, Jan. 19, 2011]

§ 173.323 Ethylene oxide.

(a) For packaging ethylene oxide in non-bulk packagings, silver mercury or any of its alloys or copper may not be used in any part of a packaging, valve, or other packaging appurtenance if that part, during normal conditions of transportation, may come in contact with ethylene oxide liquid or vapor. Copper alloys may be used only where gas mixtures do not contain free acetylene at any concentration that will form copper acetylene. All packaging and gaskets must be constructed of materials which are compatible with ethylene oxide and do not lower the auto-ignition temperature of ethylene oxide.

(b) Ethylene oxide must be packaged in one of the following:

(1) In hermetically sealed glass or metal inner packagings suitably cushioned in an outer package authorized by §173.201(b). The maximum quantity permitted in any glass inner packaging is 100 g (3.5 ounces), and the maximum quantity permitted in any metal inner packaging is 340 g (12 ounces). After

filling, each inner packaging shall be determined to be leak-tight by placing the inner packaging in a hot water bath at a temperature, and for a period of time, sufficient to ensure that an internal pressure equal to the vapor pressure of ethylene oxide at 55 °C is achieved. The total quantity in any outer packaging shall not exceed 100 g (3.5 ounces), and the total quantity in any outer packaging containing only metal inner packagings shall not exceed 2.5 kg (5.5 pounds). Each completed package must be capable of passing all Packing Group I performance tests.

(2) In specification cylinders or UN pressure receptacles, as authorized for any compressed gas except acetylene. Pressurizing valves and insulation are required for cylinders over 4 L (1 gallon) capacity. Eductor tubes must be provided for cylinders over 19 L (5 gallons) capacity. Cylinders must be seamless or welded steel (not brazed) with a nominal capacity of no more than 115 L (30 gallons) and may not be liquid full below 82 °C (180 °F). Before each refilling, each cylinder must be tested for leakage at no less than 103.4 kPa (15 psig) pressure. In addition, each cylinder must be equipped with a fusible type relief device with yield temperature of 69 °C to 77 °C (157 °F to 170 °F). The capacity of the relief device and the effectiveness of the insulation must be such that the charged cylinder will not explode when tested by the method described in CGA Pamphlet C-14 or other equivalent method.

(3) In 1A1 steel drums of no more than 231 L (61 gallons) and meeting Packing Group I performance standards. The drum must be lagged of all welded construction with the inner shell having a minimum thickness of 1.7 mm (0.068 inches) and the outer shell having a minimum thickness of 2.4 mm (0.095 inches). Drums must be capable of withstanding a hydrostatic test pressure of 690 kPa (100 psig). Lagging must be of sufficient thickness so that the drum, when filled with ethylene oxide and equipped with the required pressure relief device, will not rupture when exposed to fire. The drum may not be liquid full below 85 °C (185 °F), and must be marked "THIS END

UP” on the top head. Before each refilling, each drum must be tested for leakage at no less than 103 kPa (15 psig) pressure. Each drum must be equipped with a fusible type relief device with yield temperature of 69 °C to 77 °C (157 °F to 170 °F), and the capacity of the relief device must be such that the filled drum is capable of passing, without rupture, the test method described in CGA Pamphlet C-14 or other equivalent method.

(c) When §172.101 of this subchapter specifies that a hazardous material be packaged under this section, only the following bulk packagings are authorized, subject to the requirements of subparts A and B of this part, the special provisions specified in column 7 of the §172.101 table, and paragraphs (d) through (j) of this section:

(1) *Tank cars.* Class DOT 105 tank cars:

(i) Each tank car built before March 16, 2009 must have a tank test pressure of at least 20.7 Bar (300 psig); and

(ii) Except as provided in §173.314(d), tank cars built on or after March 16, 2009 used for the transportation of ethylene oxide must meet the applicable authorized tank car specification listed in the table in §173.314(c).

(2) *Cargo tanks.* Specification MC 330 and MC 331 cargo tank motor vehicles.

(3) *Portable tanks.* DOT 51 portable tanks.

(d) The pressure relief devices must be set to function at 517 kPa (75 psig). Portable tanks fitted with non-reclosing devices made and in use prior to December 31, 1987, may continue to be used in ethylene oxide service.

(e) In determining outage, consideration must be given to the lading temperature and solubility of inert gas padding in ethylene oxide as well as the partial pressure exerted by the gas padding.

(f) Each tank, loaded or empty, must be padded with dry nitrogen or other suitable inert gas of sufficient quantity to render the vapor space of the tank nonflammable up to 41 °C (105 °F). The gas used for padding must be free of impurities which may cause the ethylene oxide to polymerize, decompose or undergo other violent chemical reaction.

(g) Copper, silver, mercury, magnesium or their alloys may not be used in any part of the tank or appurtenances that are normally in contact with the lading.

(h) Neoprene, natural rubber and asbestos gaskets are prohibited. All packing and gaskets must be made of materials which do not react with or lower the autoignition temperature of the lading.

(i) Each tank must be insulated with cork (at least 10 cm (4 inches) thick), or mineral wool, fiberglass or other suitable insulation material of sufficient thickness so that the thermal conductance at 16 °C (60 °F) is not more than 0.075 Btu per hour per square foot per degree F. temperature differential. Portable tanks made and in use prior to December 31, 1987 equipped with fusible plugs instead of a pressure relief valve or rupture disc, must have sufficient insulation so that the tank as filled for shipment will not rupture in a fire. The insulation on portable tanks or cargo tank motor vehicles must be protected with a steel jacket at least 2.54 mm (0.100 inch) thick, or as required by the specification.

(j) Tank car tanks built after December 30, 1971 must be equipped with a thermometer well.

[Amdt. 173–224, 55 FR 52667, Dec. 21, 1990, as amended at 56 FR 66279, Dec. 20, 1991; Amdt. 173–236, 58 FR 50237, Sept. 24, 1993; Amdt. 173–234, 58 FR 51532, Oct. 1, 1993; Amdt. 173–145, 60 FR 49076, Sept. 21, 1995; 66 FR 45380, 45383, Aug. 28, 2001; 68 FR 75746, Dec. 31, 2003; 69 FR 76178, Dec. 20, 2004; 71 FR 33884, June 12, 2006; 74 FR 1801, Jan. 13, 2009]

§ 173.334 Organic phosphates mixed with compressed gas.

Hexaethyl tetraphosphate, parathion, tetraethyl dithio pyrophosphate, tetraethyl pyrophosphate, or other Division 6.1 organic phosphates (including a compound or mixture), may be mixed with a non-flammable compressed gas. This mixture may not contain more than 20 percent by weight of organic phosphate and must be packaged in DOT 3A240, 3AA240, 3B240, 4B240, 4BA240, 4BW240 or UN cylinders meeting all of the following requirements:

(a) Each cylinder may be filled with not more than 5 kg (11.0 lb) of the mixture, to a maximum filling density of

not more than 80 percent of the water capacity.

(b) No cylinder may be equipped with an education tube or a fusible plug.

(c) No cylinder may be equipped with any valve unless the valve is a type approved by the Associate Administrator.

(d) Cylinders must be overpacked in a box, crate, or other strong outer packaging conforming to the requirements of §173.25 and arranged to protect each valve or other closing device from damage. Except as provided in paragraph (e) of this section, no more than four cylinders may be packed in a strong outer packaging. Each strong outer packaging with its closing device protection must be sufficiently strong to protect all parts of each cylinder from deformation or leakage if the completed package is dropped 1.8 m (6 feet) onto a non-yielding surface, such as concrete or steel, impacting at the packaging's weakest point.

(e) Cylinders may be packed in strong wooden boxes with valves or other closing devices protected from damage, with not more than twelve cylinders in one outside wooden box. An outer fiberboard box may be used when not more than four such cylinders are to be shipped in one packaging. Valves must be adequately protected. Box and valve protection must be of sufficient strength to protect all parts of inner packagings and valves from deformation or breakage resulting from a drop of at least 1.8 m (6 feet) onto a non-yielding surface, such as concrete or steel, impacting at the weakest point.

[67 FR 51651, Aug. 8, 2002, as amended at 71 FR 54395, Sept. 14, 2006; 75 FR 5395, Feb. 2, 2010]

§ 173.335 Chemical under pressure n.o.s.

(a) *General requirements.* A cylinder filled with a chemical under pressure must be offered for transportation in accordance with the requirements of this section and §172.301. In addition, a DOT specification cylinder must meet the requirements in §§173.301a, 173.302, 173.302a, and 173.305, as applicable. UN pressure receptacles must meet the requirements in §§173.301b and 173.302b, as applicable. Where more than one section applies to a cylinder, the most re-

strictive requirements must be followed.

(b) *Filling limits.* Cylinders must be filled so that at 50 °C (122 °F) the non-gaseous phase does not exceed 95% of their water capacity and they are not completely filled at 60 °C (140 °F). When filled, the internal pressure at 65 °C (149 °F) must not exceed the test pressure of the cylinder. The vapor pressures and volumetric expansion of all substances in the cylinders must be taken into account.

(c) *Minimum service pressure.* The minimum service pressure must be in accordance with the design specifications of part 178 of this subchapter for the propellant. In any case the minimum test pressure must not be less than 20 bar.

(d) *Periodic inspection.* The maximum requalification test period for cylinders transporting chemical under pressure n.o.s. is 5 years.

[78 FR 1092, Jan. 7, 2013]

§ 173.336 Nitrogen dioxide, liquefied, or dinitrogen tetroxide, liquefied.

(a) Nitrogen dioxide, liquefied, or dinitrogen tetroxide, liquefied, must be packaged in specification or UN cylinders as prescribed in §173.192, except valves are not authorized. UN tubes and MEGCs are not authorized for use. Cylinders must be equipped with a stainless steel valve and valve seat that will not deteriorate in contact with nitrogen dioxide. Each valve opening must be closed by a solid metal plug with tapered thread properly luted to prevent leakage. Transportation in DOT 3AL cylinders is authorized only by highway and rail.

(b) Each UN pressure receptacle must be cleaned in accordance with the requirements of ISO 11621 (IBR, see §171.7 of this subchapter). Each DOT specification cylinder must be cleaned according to the requirements of GSA Federal Specification RR-C-901D, paragraphs 3.3.1 and 3.3.2 (IBR, see §171.7 of this subchapter). Cleaning agents equivalent to those specified in RR-C-901D may be used; however, any cleaning agent must not be capable of reacting with oxygen. One cylinder selected at random from a group of 200 or fewer and cleaned at the same time must be

§ 173.337

tested for oil contamination in accordance with Specification RR-C-901D, paragraph 4.3.2 (IBR, see §171.7 of this subchapter) and meet the standard of cleanliness specified therein.

[71 FR 33885, June 12, 2006]

§ 173.337 Nitric oxide.

(a) Nitric oxide must be packaged in cylinders conforming to the requirements of §173.40 and as follows:

(1) *DOT specification cylinder.* In a DOT 3A1800, 3AA1800, 3E1800, or 3AL1800 cylinder. A DOT specification cylinder must be charged to a pressure of not more than 5,170 kPa (750 psi) at 21 °C (70 °F). Transportation of nitric oxide in a DOT 3AL is cylinder is authorized only by highway and rail.

(2) *UN cylinder.* In a UN cylinder with a minimum test pressure of 200 bar. The maximum working pressure of the cylinder must not exceed 50 bar. The pressure in the cylinder at 65 °C (149 °F) may not exceed the test pressure. The use of UN tubes and MEGCs is not authorized.

(3) *Valves.* Cylinders must be equipped with a stainless steel valve and valve seat that will not deteriorate in contact with nitric oxide. Cylinders or valves may not be equipped with pressure relief devices of any type.

(b) Each UN cylinder must be cleaned in accordance with the requirements of ISO 11621 (IBR, see §171.7 of this subchapter). Each DOT specification cylinder must be cleaned in compliance with the requirements of GSA Federal Specification RR-C-901D, paragraphs 3.3.1 and 3.3.2 (IBR, see §171.7 of this subchapter). Cleaning agents equivalent to those specified in Federal Specification RR-C-901D may be used; however, any cleaning agent must not be capable of reacting with oxygen. One cylinder selected at random from a group of 200 or fewer and cleaned at the same time must be tested for oil contamination in accordance with Federal Specification RR-C-901D paragraph 4.3.2 and meet the standard of cleanliness specified therein.

[71 FR 33885, June 12, 2006]

§ 173.338 Tungsten hexafluoride.

(a) Tungsten hexafluoride must be packaged in specification 3A, 3AA,

49 CFR Ch. I (10–1–14 Edition)

3BN, or 3E (§§ 178.36, 178.37, 178.39, 178.42 of this subchapter) cylinders. Cylinders must be equipped with a valve protection cap or be packed in a strong outer packaging meeting the provisions of §173.40. Outlets of any valves must be capped or plugged. As an alternative, the cylinder opening may be closed by the use of a metal plug. Specification 3E cylinders must be shipped in an overpack that meets the provisions of §173.40.

(b) In place of the volumetric expansion test, DOT 3BN cylinders used in exclusive service may be given a complete external visual inspection in conformance with part 180, subpart C, of this subchapter, at the time such periodic requalification becomes due. Cylinders that undergo a complete external visual inspection, in place of the volumetric expansion test, must be condemned if removed from tungsten hexafluoride service.

[74 FR 16143, Apr. 9, 2009, as amended at 75 FR 5395, Feb. 2, 2010]

§ 173.340 Tear gas devices.

(a) Packagings for tear gas devices must be approved prior to initial transportation by the Associate Administrator.

(b) Tear gas devices may not be assembled with, or packed in the same packaging with, mechanically- or manually-operated firing, igniting, bursting, or other functioning elements unless of a type and design which has been approved by the Associate Administrator.

(c) Tear gas grenades, tear gas candles, and similar devices must be packaged in one of the following packagings conforming to the requirements of part 178 of this subchapter at the Packing Group II performance level:

(1) In UN 4A, 4B, or 4N metal boxes or UN 4C1, 4C2, 4D, or 4F metal-strapped wooden boxes. Functioning elements not assembled in grenades or devices must be in a separate compartment of these boxes, or in inner or separate outer boxes, UN 4C1, 4C2, 4D, or 4F, and must be packed and cushioned so that they may not come in contact with each other or with the walls of the box during transportation. Not more than 50 tear gas devices and 50 functioning elements must be packed in one box,

and the gross weight of the outer box may not exceed 35 kg (77 pounds).

(2) In UN 1A2, 1B2, 1N2 or 1H2 drums. Functioning elements must be packed in a separate inner packaging or compartment. Not more than 24 tear gas devices and 24 functioning elements must be packed in one outer drum, and the gross weight of the drum may not exceed 35 kg (77 pounds).

(3) In a UN 4G fiberboard box with inside tear gas devices meeting Specifications 2P or 2Q. Each inside packaging must be placed in fiberboard tubes fitted with metal ends or a fiber box with suitable padding. Not more than 30 inner packagings must be packed in one outer box, and the gross weight of the outer box may not exceed 16 kg (35 pounds).

(4) In other packagings of a type or design which has been approved by the Associate Administrator.

(d) Tear gas devices may be shipped completely assembled when offered by or consigned to the U.S. Department of Defense, provided the functioning elements are packed so that they cannot accidentally function. Outer packagings must be UN 4A, 4B, or 4N metal boxes or UN 4C1, 4C2, 4D, or 4F metal-straped wooden boxes.

[Amdt. 173-224, 55 FR 52669, Dec. 21, 1990, as amended 66 FR 45379, Aug. 28, 2001; 78 FR 1092, Jan. 7, 2013]

Subpart H [Reserved]

Subpart I—Class 7 (Radioactive) Materials

SOURCE: Amdt. 173-244, 60 FR 50307, Sept. 28, 1995, unless otherwise noted.

§ 173.401 Scope.

(a) This subpart sets forth requirements for the packaging and transportation of Class 7 (radioactive) materials by offerors and carriers subject to this subchapter. The requirements prescribed in this subpart are in addition to, not in place of, other requirements set forth in this subchapter for Class 7 (radioactive) materials and those of the Nuclear Regulatory Commission in 10 CFR part 71.

(b) This subpart does not apply to:

(1) Class 7 (radioactive) materials produced, used, transported, or stored within an establishment other than during the course of transportation, including storage in transportation.

(2) Class 7 (radioactive) materials that have been implanted or incorporated into, and are still in, a person or live animal for diagnosis or treatment.

(3) Class 7 (radioactive) material that is an integral part of the means of transport.

(4) Natural material and ores containing naturally occurring radionuclides which are either in their natural state, or which have only been processed for purposes other than for extraction of the radionuclides, and which are not intended to be processed for the use of these radionuclides, provided the activity concentration of the material does not exceed 10 times the exempt material activity concentration values specified in §173.436, or determined in accordance with the requirements of §173.433.

(5) Non-radioactive solid objects with radioactive substances present on any surfaces in quantities not exceeding the threshold limits set forth in the definition of contamination in §173.403.

[Amdt. 173-244, 60 FR 50307, Sept. 28, 1995, as amended at 69 FR 3670, Jan. 26, 2004; 79 FR 40610, July 11, 2014]

§ 173.403 Definitions.

For purposes of this subpart—

*A*₁ means the maximum activity of special form Class 7 (radioactive) material permitted in a Type A package. This value is either listed in §173.435 or may be derived in accordance with the procedures prescribed in §173.433.

*A*₂ means the maximum activity of Class 7 (radioactive) material, other than special form material, LSA material, and SCO, permitted in a Type A package. This value is either listed in §173.435 or may be derived in accordance with the procedures prescribed in §173.433.

Class 7 (radioactive) material See the definition of *Radioactive material* in this section.

Closed transport vehicle means a transport vehicle or conveyance equipped

with a securely attached exterior enclosure that during normal transportation restricts the access of unauthorized persons to the cargo space containing the Class 7 (radioactive) materials. The enclosure may be either temporary or permanent, and in the case of packaged materials may be of the “see-through” type, and must limit access from top, sides, and bottom.

Consignment means a package or group of packages or load of radioactive material offered by a person for transport in the same shipment.

Containment system means the assembly of components of the packaging intended to retain the Class 7 (radioactive) material during transport.

Contamination means the presence of a radioactive substance on a surface in quantities in excess of 0.4 Bq/cm² for beta and gamma emitters and low toxicity alpha emitters or 0.04 Bq/cm² for all other alpha emitters. There are two categories of contamination:

(1) Fixed contamination means contamination that cannot be removed from a surface during normal conditions of transport.

(2) Non-fixed contamination means contamination that can be removed from a surface during normal conditions of transport.

Conveyance means:

(1) For transport by public highway or rail: any transport vehicle or large freight container;

(2) For transport by water: any vessel, or any hold, compartment, or defined deck area of a vessel including any transport vehicle on board the vessel; and

(3) For transport by aircraft, any aircraft.

Criticality Safety Index (CSI) means a number (rounded up to the next tenth) which is used to provide control over the accumulation of packages, overpacks or freight containers containing fissile material. The CSI for a package containing fissile material is determined in accordance with the instructions provided in 10 CFR 71.22, 71.23, and 71.59. The CSI for an overpack, freight container, consignment or conveyance containing fissile material packages is the arithmetic sum of the criticality safety indices of all the fissile material packages contained

within the overpack, freight container, consignment or conveyance.

Design means the description of a special form Class 7 (radioactive) material, a package, packaging, or LSA-III, that enables those items to be fully identified. The description may include specifications, engineering drawings, reports showing compliance with regulatory requirements, and other relevant documentation.

Deuterium means, for the purposes of § 173.453, deuterium and any deuterium compound, including heavy water, in which the ratio of deuterium atoms to hydrogen atoms exceeds 1:5000.

Exclusive use means sole use by a single consignor of a conveyance for which all initial, intermediate, and final loading and unloading are carried out in accordance with the direction of the consignor or consignee. The consignor and the carrier must ensure that any loading or unloading is performed by personnel having radiological training and resources appropriate for safe handling of the consignment. The consignor must provide to the initial carrier specific written instructions for maintenance of exclusive use shipment controls, including the vehicle survey requirement of § 173.443 (c) as applicable, and include these instructions with the shipping paper information provided to the carrier by the consignor.

Exemption value means either an exempt material activity concentration or an exempt consignment activity limit listed in the table in § 173.436, or determined according to the procedures described in § 173.433, and used to determine whether a given physically radioactive material is sufficiently radioactive to be subject to the HMR (see definition of radioactive material). An exemption value is different from an exemption, as specified under the definition for special permit in § 171.8 of this subchapter.

Fissile material means plutonium-239, plutonium-241, uranium-233, uranium-235, or any combination of these radionuclides. Fissile material means the fissile nuclides themselves, not material containing fissile nuclides, but does not include: Unirradiated natural uranium or depleted uranium; and natural uranium or depleted uranium that has been irradiated in thermal reactors

only. Certain exceptions for fissile materials are provided in §173.453.

Freight container means a reusable container having a volume of 1.81 cubic meters (64 cubic feet) or more, designed and constructed to permit it being lifted with its contents intact and intended primarily for containment of packages in unit form during transportation. A "small freight container" is one which has either one outer dimension less than 1.5 m (4.9 feet) or an internal volume of not more than 3.0 cubic meters (106 cubic feet). All other freight containers are designated as "large freight containers."

Graphite means, for the purposes of §173.453, graphite with a boron equivalent content less than 5 parts per million and density greater than 1.5 grams per cubic centimeter.

Highway route controlled quantity means a quantity within a single package which exceeds:

(1) 3,000 times the A_1 value of the radionuclides as specified in §173.435 for special form Class 7 (radioactive) material;

(2) 3,000 times the A_2 value of the radionuclides as specified in §173.435 for normal form Class 7 (radioactive) material; or

(3) 1,000 TBq (27,000 Ci), whichever is least.

Limited quantity of Class 7 (radioactive) material means a quantity of Class 7 (radioactive) material not exceeding the material's package limits specified in §173.425 and conforming with requirements specified in §173.421.

Low Specific Activity (LSA) material means Class 7 (radioactive) material with limited specific activity which is not fissile material or is excepted under §173.453, and which satisfies the descriptions and limits set forth below. Shielding material surrounding the LSA material may not be considered in determining the estimated average specific activity of the LSA material. LSA material must be in one of three groups:

(1) LSA-I:

(i) Uranium and thorium ores, concentrates of uranium and thorium ores, and other ores containing naturally occurring radionuclides which are intended to be processed for the use of these radionuclides; or

(ii) Natural uranium, depleted uranium, natural thorium or their compounds or mixtures, provided they are unirradiated and in solid or liquid form; or

(iii) Radioactive material for which the A_2 value is unlimited; or

(iv) Other radioactive material in which the activity is distributed throughout and the estimated average specific activity does not exceed 30 times the values for activity concentration specified in §173.436 or calculated in accordance with §173.433, or 30 times the default values listed in Table 8 of §173.433.

(2) LSA-II:

(i) Water with tritium concentration up to 0.8 TBq/L (20.0 Ci/L); or

(ii) Other radioactive material in which the activity is distributed throughout and the average specific activity does not exceed 10^{-4} A_2/g for solids and gases, and 10^{-5} A_2/g for liquids.

(3) LSA-III. Solids (*e.g.*, consolidated wastes, activated materials), excluding powders, that meet the requirements of §173.468 and in which:

(i) The radioactive material is distributed throughout a solid or a collection of solid objects, or is essentially uniformly distributed in a solid compact binding agent (such as concrete, bitumen, ceramic, etc.);

(ii) The radioactive material is relatively insoluble, or it is intrinsically contained in a relatively insoluble material, so that, even under loss of packaging, the loss of Class 7 (radioactive) material per package by leaching when placed in water for seven days would not exceed 0.1 A_2 ; and

(iii) The estimated average specific activity of the solid, excluding any shielding material, does not exceed 2×10^{-3} A_2/g .

Low toxicity alpha emitters means natural uranium; depleted uranium; natural thorium; uranium-235 or uranium-238; thorium-232; thorium-228 and thorium-230 when contained in ores or physical and chemical concentrates; and alpha emitters with a half-life of less than 10 days.

Maximum normal operating pressure means the maximum gauge pressure that would develop in a containment system during a period of one year, in the absence of venting or cooling,

under the heat conditions specified in 10 CFR 71.71(c)(1).

Multilateral approval means approval of a package design or shipment by the relevant Competent Authority of the country of origin and of each country through or into which the package or shipment is to be transported. This definition does not include approval from a country over which Class 7 (radioactive) materials are carried in aircraft, if there is no scheduled stop in that country.

Natural thorium means thorium with the naturally occurring distribution of thorium isotopes (essentially 100 percent by weight of thorium-232).

Normal form Class 7 (radioactive) material means Class 7 (radioactive) which has not been demonstrated to qualify as “special form Class 7 (radioactive) material.”

Package means the packaging together with its radioactive contents as presented for transport.

(1) “Excepted package” means a packaging together with its excepted Class 7 (radioactive) materials as specified in §§ 173.421–173.426 and 173.428.

(2) “Industrial package” means a packaging that, together with its low specific activity (LSA) material or surface contaminated object (SCO) contents, meets the requirements of §§ 173.410 and 173.411. Industrial packages are categorized in § 173.411 as either:

(i) “Industrial package Type 1 (Type IP-1);

(ii) “Industrial package Type 2 (Type IP-2); or

(iii) “Industrial package Type 3 (Type IP-3).

(3) “Type A package” means a packaging that, together with its radioactive contents limited to A₁ or A₂ as appropriate, meets the requirements of §§ 173.410 and 173.412 and is designed to retain the integrity of containment and shielding required by this part under normal conditions of transport as demonstrated by the tests set forth in § 173.465 or § 173.466, as appropriate. A Type A package does not require Competent Authority approval.

(4) “Type B package” means a packaging designed to transport greater than an A₁ or A₂ quantity of radioactive material that, together with its

radioactive contents, is designed to retain the integrity of containment and shielding required by this part when subjected to the normal conditions of transport and hypothetical accident test conditions set forth in 10 CFR part 71.

(i) “Type B(U) package” means a Type B packaging that, together with its radioactive contents, for international shipments requires unilateral approval only of the package design and of any stowage provisions that may be necessary for heat dissipation.

(ii) “Type B(M) package” means a Type B packaging, together with its radioactive contents, that for international shipments requires multilateral approval of the package design, and may require approval of the conditions of shipment. Type B(M) packages are those Type B package designs which have a maximum normal operating pressure of more than 700 kPa/cm² (100 lb/in²) gauge or a relief device which would allow the release of Class 7 (radioactive) material to the environment under the hypothetical accident conditions specified in 10 CFR part 71.

(5) “Fissile material package” means a packaging, together with its fissile material contents, which meets the requirements for fissile material packages described in subpart E of 10 CFR 71. A fissile material package may be a Type AF package, a Type B(U)F package, or a Type B(M)F package.

Packaging means, for Class 7 (radioactive) materials, the assembly of components necessary to ensure compliance with the packaging requirements of this subpart. It may consist of one or more receptacles, absorbent materials, spacing structures, thermal insulation, radiation shielding, service equipment for filling, emptying, venting and pressure relief, and devices for cooling or absorbing mechanical shocks. The conveyance, tie-down system, and auxiliary equipment may sometimes be designated as part of the packaging.

Quality assurance means a systematic program of controls and inspections applied by each person involved in the transport of radioactive material which provides confidence that a standard of safety prescribed in this subchapter is achieved in practice.

Radiation level means the radiation dose-equivalent rate expressed in millisieverts per hour or mSv/h (millirem/hour or mrem/h). It consists of the sum of the dose-equivalent rates from all types of ionizing radiation present including alpha, beta, gamma, and neutron radiation. Neutron flux densities may be used to determine neutron radiation levels according to Table 1:

TABLE 1—NEUTRON FLUENCE RATES TO BE RE-GARDED AS EQUIVALENT TO A RADIATION LEVEL OF 0.01 mSv/h (1mrem/h)¹

Energy of neutron	Flux density equivalent to 0.01 mSv/h (1 mrem/h) neutrons per square centimeter per second (n/cm ² /s) ¹
Thermal (2.5 10E-8) MeV	272.0
1 keV	272.0
10 keV	281.0
100 keV	47.0
500 keV	11.0
1 MeV	7.5
5 MeV	6.4
10 MeV	6.7

¹ Flux densities equivalent for energies between those listed in this table may be obtained by linear interpolation.

Radioactive contents means a Class 7 (radioactive) material, together with any contaminated or activated solids, liquids and gases within the packaging.

Radioactive instrument or article means any manufactured instrument or article such as an instrument, clock, electronic tube or apparatus, or similar instrument or article having Class 7 (radioactive) material in gaseous or non-dispersible solid form as a component part.

Radioactive material means any material containing radionuclides where both the activity concentration and the total activity in the consignment exceed the values specified in the table in §173.436 or values derived according to the instructions in §173.433.

Special form Class 7 (radioactive) material means either an indispersible solid radioactive material or a sealed capsule containing radioactive material which satisfies the following conditions:

- (1) It is either a single solid piece or a sealed capsule containing radioactive

material that can be opened only by destroying the capsule;

- (2) The piece or capsule has at least one dimension not less than 5 mm (0.2 in); and

(3) It satisfies the test requirements of §173.469. Special form encapsulations designed in accordance with the requirements of §173.389(g) in effect on June 30, 1983 (see 49 CFR part 173, revised as of October 1, 1982), and constructed prior to July 1, 1985 and special form encapsulations designed in accordance with the requirements of §173.403 in effect on March 31, 1996 (see 49 CFR part 173, revised as of October 1, 1995), and constructed prior to April 1, 1997, may continue to be used. Any other special form encapsulation must meet the requirements of this paragraph (3).

Specific activity of a radionuclide means the activity of the radionuclide per unit mass of that nuclide. The specific activity of a material in which the radionuclide is essentially uniformly distributed is the activity per unit mass of the material.

Surface Contaminated Object (SCO) means a solid object which is not itself radioactive but which has radioactive material distributed on its surface. SCO exists in two phases:

- (1) SCO-I: A solid object on which:
 - (i) The non-fixed contamination on the accessible surface averaged over 300 cm² (or the area of the surface if less than 300 cm²) does not exceed 4 Bq/cm² (10⁻⁴ microcurie/cm²) for beta and gamma and low toxicity alpha emitters, or 0.4 Bq/cm² (10⁻⁵ microcurie/cm²) for all other alpha emitters;
 - (ii) The fixed contamination on the accessible surface averaged over 300 cm² (or the area of the surface if less than 300 cm²) does not exceed 4 × 10⁴ Bq/cm² (1.0 microcurie/cm²) for beta and gamma and low toxicity alpha emitters, or 4 × 10³ Bq/cm² (0.1 microcurie/cm²) for all other alpha emitters; and
 - (iii) The non-fixed contamination plus the fixed contamination on the inaccessible surface averaged over 300 cm² (or the area of the surface if less than 300 cm²) does not exceed 4 × 10⁴ Bq/cm² (1 microcurie/cm²) for beta and gamma and low toxicity alpha

§ 173.410

49 CFR Ch. I (10–1–14 Edition)

emitters, or 4×10^3 Bq/cm² (0.1 microcurie/cm²) for all other alpha emitters.

(2) SCO-II: A solid object on which the limits for SCO-I are exceeded and on which:

(i) The non-fixed contamination on the accessible surface averaged over 300 cm² (or the area of the surface if less than 300 cm²) does not exceed 400 Bq/cm² (10^{-2} microcurie/cm²) for beta and gamma and low toxicity alpha emitters, or 40 Bq/cm² (10^{-3} microcurie/cm²) for all other alpha emitters;

(ii) The fixed contamination on the accessible surface averaged over 300 cm² (or the area of the surface if less than 300 cm²) does not exceed 8×10^5 Bq/cm² (20 microcurie/cm²) for beta and gamma and low toxicity alpha emitters, or 8×10^4 Bq/cm² (2 microcuries/cm²) for all other alpha emitters; and

(iii) The non-fixed contamination plus the fixed contamination on the inaccessible surface averaged over 300 cm² (or the area of the surface if less than 300 cm²) does not exceed 8×10^5 Bq/cm² (20 microcuries/cm²) for beta and gamma and low toxicity alpha emitters, or 8×10^4 Bq/cm² (2 microcuries/cm²) for all other alpha emitters.

Transport index (TI) means the dimensionless number (rounded up to the next tenth) placed on the label of a package, to designate the degree of control to be exercised by the carrier during transportation. The transport index is determined by multiplying the maximum radiation level in millisieverts (mSv) per hour at 1 m (3.3 ft) from the external surface of the package by 100 (equivalent to the maximum radiation level in millirem per hour at 1 m (3.3 ft)).

Type A quantity means a quantity of Class 7 (radioactive) material, the aggregate radioactivity which does not exceed A_1 for special form Class 7 (radioactive) material or A_2 for normal form Class 7 (radioactive) material, where A_1 and A_2 values are given in §173.435 or are determined in accordance with §173.433.

Type B quantity means a quantity of material greater than a Type A quantity.

Unilateral approval means approval of a package design solely by the Competent Authority of the country of origin of the design.

Unirradiated thorium means thorium containing not more than 10^{-7} grams uranium-233 per gram of thorium-232.

Unirradiated uranium means uranium containing not more than 2×10^3 Bq of plutonium per gram of uranium-235, not more than 9×10^6 Bq of fission products per gram of uranium-235 and not more than 5×10^{-3} g of uranium-236 per gram of uranium-235.

Uranium—natural, depleted or enriched means the following:

(1)(i) “Natural uranium” means uranium (which may be chemically separated) containing the naturally occurring distribution of uranium isotopes (approximately 99.28% uranium-238 and 0.72% uranium-235 by mass).

(ii) “Depleted uranium” means uranium containing a lesser mass percentage of uranium-235 than in natural uranium.

(iii) “Enriched uranium” means uranium containing a greater mass percentage of uranium-235 than 0.72%.

(2) For each of these definitions, a very small mass percentage of uranium-234 may be present.

[69 FR 3670, Jan. 26, 2004; 69 FR 55116, Sept. 13, 2004; 69 FR 58843, Oct. 1, 2004; 70 FR 56098, Sept. 23, 2005; 70 FR 73165, Dec. 9, 2005; 79 FR 40610, July 11, 2014]

§ 173.410 General design requirements.

In addition to the requirements of subparts A and B of this part, each package used for the shipment of Class 7 (radioactive) materials must be designed so that—

(a) The package can be easily handled and properly secured in or on a conveyance during transport.

(b) Each lifting attachment that is a structural part of the package must be designed with a minimum safety factor of three against yielding when used to lift the package in the intended manner, and it must be designed so that failure of any lifting attachment under excessive load would not impair the ability of the package to meet other requirements of this subpart. Any other structural part of the package which could be used to lift the package

must be capable of being rendered inoperable for lifting the package during transport or must be designed with strength equivalent to that required for lifting attachments.

(c) The external surface, as far as practicable, will be free from protruding features and will be easily decontaminated.

(d) The outer layer of packaging will avoid, as far as practicable, pockets or crevices where water might collect.

(e) Each feature that is added to the package will not reduce the safety of the package.

(f) The package will be capable of withstanding the effects of any acceleration, vibration or vibration resonance that may arise under normal conditions of transport without any deterioration in the effectiveness of the closing devices on the various receptacles or in the integrity of the package as a whole and without loosening or unintentionally releasing the nuts, bolts, or other securing devices even after repeated use (see §§ 173.24, 173.24a, and 173.24b).

(g) The materials of construction of the packaging and any components or structure will be physically and chemically compatible with each other and with the package contents. The behavior of the packaging and the package contents under irradiation will be taken into account.

(h) All valves through which the package contents could escape will be protected against unauthorized operation.

(i) For transport by air—

(1) The temperature of the accessible surfaces of the package will not exceed 50 °C (122 °F) at an ambient temperature of 38 °C (100 °F) with no account taken for insulation;

(2) The integrity of containment will not be impaired if the package is exposed to ambient temperatures ranging from -40 °C (-40 °F) to +55 °C (131 °F); and

(3) A package containing liquid contents must be capable of withstanding, without leakage, an internal pressure that produces a pressure differential of

not less than the maximum normal operating pressure plus 95 kPa (13.8 psi).

[Amdt. 173-244, 60 FR 50307, Sept. 28, 1995, as amended by Amdt. 173-244, 61 FR 20750, May 8, 1996; 64 FR 51919, Sept. 27, 1999; 79 FR 40611, July 11, 2014]

§ 173.411 Industrial packages.

(a) *General.* Each industrial package must comply with the requirements of this section which specifies package tests, and record retention applicable to Industrial Package Type 1 (Type IP-1), Industrial Package Type 2 (Type IP-2), and Industrial Package Type 3 (Type IP-3).

(b) *Industrial package certification and tests.* (1) Each Type IP-1 package must meet the general design requirements prescribed in § 173.410.

(2) Each Type IP-2 package must meet the general design requirements prescribed in § 173.410 and when subjected to the tests specified in § 173.465(c) and (d) or evaluated against these tests by any of the methods authorized by § 173.461(a), must prevent:

(i) Loss or dispersal of the radioactive contents; and

(ii) A significant increase in the radiation levels recorded or calculated at the external surfaces for the condition before the test.

(3) Each Type IP-3 package must meet the requirements for Type IP-1 and Type IP-2 packages, and must meet the requirements specified in § 173.412(a) through (j).

(4) A portable tank may be used as a Type IP-2 or Type IP-3 package provided that:

(i) It meets the requirements for Type IP-1 packages specified in paragraph (b)(1);

(ii) It meets the requirements prescribed in Chapter 6.7 of the United Nations Recommendations on the Transport of Dangerous Goods, (IBR, see § 171.7 of this subchapter), “Requirements for the Design, Construction, Inspection and Testing of Portable Tanks and Multiple-Element Gas Containers (MEGCs),” or other requirements at least equivalent to those standards;

(iii) It is capable of withstanding a test pressure of 265 kPa (38.4 psia); and

(iv) It is designed so that any additional shielding which is provided must be capable of withstanding the static

§ 173.412

49 CFR Ch. I (10–1–14 Edition)

and dynamic stresses resulting from handling and routine conditions of transport and of preventing more than a 20% increase in the maximum radiation level at any external surface of the portable tanks.

(5) A cargo tank or a tank car may be used as Type IP–2 or Type IP–3 package for transporting LSA–I and LSA–II liquids and gases as prescribed in Table 6 of § 173.427, provided that:

(i) It meets the requirements for a Type IP–1 package specified in paragraph (b)(1);

(ii) It is capable of withstanding a test pressure of 265 kPa (38.4 psia); and

(iii) It is designed so that any additional shielding which is provided must be capable of withstanding the static and dynamic stresses resulting from handling and routine conditions of transport and of preventing more than a 20% increase in the maximum radiation level at any external surface of the tanks.

(6) A freight container may be used as Type IP–2 or Type IP–3 packages provided:

(i) The radioactive contents are restricted to solid materials;

(ii) It meets the requirements for a Type IP–1 packages specified in paragraph (b)(1); and

(iii) It meets the standards prescribed in the International Organization for Standardization document ISO 1496-1: “Series 1 Freight Containers—Specifications and Testing—Part 1: General Cargo Containers; excluding dimensions and ratings (IBR, *see* § 171.7 of this subchapter). It must be designed such that if subjected to the tests prescribed in that document and the accelerations occurring during routine conditions of transport it would prevent:

(A) Loss or dispersal of the radioactive contents; and

(B) More than a 20% increase in the maximum radiation level at any external surface of the freight containers.

(7) A metal intermediate bulk containers may be used as a Type IP–2 or Type IP–3 package, provided:

(i) It meets the requirements for a Type IP–1 package specified in paragraph (b)(1); and

(ii) It meets the requirements prescribed in Chapter 6.5 of the United Nations Recommendations on the Trans-

port of Dangerous Goods, (IBR, *see* § 171.7 of this subchapter), “Requirements for the Construction and Testing of Intermediate Bulk Containers,” for Packing Group I or II, and if subjected to the tests prescribed in that document, but with the drop test conducted in the most damaging orientation, it would prevent:

(A) Loss or dispersal of the radioactive contents; and

(B) More than a 20% increase in the maximum radiation level at any external surface of the intermediate bulk container.

(c) Except for Type IP–1 packages, each offeror of an industrial package must maintain on file for at least two years after the offeror’s latest shipment, and must provide to the Associate Administrator on request, complete documentation of tests and an engineering evaluation or comparative data showing that the construction methods, package design, and materials of construction comply with that specification.

[79 FR 40611, July 11, 2014]

§ 173.412 Additional design requirements for Type A packages.

In addition to meeting the general design requirements prescribed in § 173.410, each Type A packaging must be designed so that—

(a) The outside of the packaging incorporates a feature, such as a seal, that is not readily breakable, and that, while intact, is evidence that the package has not been opened. In the case of packages shipped in closed transport vehicles in exclusive use, the cargo compartment, instead of the individual packages, may be sealed.

(b) The smallest external dimension of the package is not less than 10 cm (4 inches).

(c) Containment and shielding is maintained during transportation and storage in a temperature range of –40 °C (–40 °F) to 70 °C (158 °F). Special attention shall be given to liquid contents and to the potential degradation of the packaging materials within the temperature range.

(d) The packaging must include a containment system securely closed by a positive fastening device that cannot

be opened unintentionally or by pressure that may arise within the package during normal transport. Special form Class 7 (radioactive) material, as demonstrated in accordance with §173.469, may be considered as a component of the containment system. If the containment system forms a separate unit of the package, it must be securely closed by a positive fastening device that is independent of any other part of the package.

(e) For each component of the containment system account is taken, where applicable, of radiolytic decomposition of materials and the generation of gas by chemical reaction and radiolysis.

(f) The containment system will retain its radioactive contents under the reduction of ambient pressure to 60 kPa (8.7 psia).

(g) Each valve, other than a pressure relief device, is provided with an enclosure to retain any leakage.

(h) Any radiation shield that encloses a component of the packaging specified as part of the containment system will prevent the unintentional escape of that component from the shield.

(i) Failure of any tie-down attachment that is a structural part of the packaging, under both normal and accident conditions, must not impair the ability of the package to meet other requirements of this subpart.

(j) When evaluated against the performance requirements of this section and the tests specified in §173.465 or using any of the methods authorized by §173.461(a), the packaging will prevent—

(1) Loss or dispersal of the radioactive contents; and

(2) A significant increase in the radiation levels recorded or calculated at the external surfaces for the condition before the test.

(k) Each packaging designed for liquids will—

(1) Be designed to provide for ullage to accommodate variations in temperature of the contents, dynamic effects and filling dynamics;

(2) Meet the conditions prescribed in paragraph (j) of this section when subjected to the tests specified in §173.466 or evaluated against these tests by any

of the methods authorized by §173.461(a); and

(3) Either—

(i) Have sufficient suitable absorbent material to absorb twice the volume of the liquid contents. The absorbent material must be compatible with the package contents and suitably positioned to contact the liquid in the event of leakage; or

(ii) Have a containment system composed of primary inner and secondary outer containment components designed to enclose the liquid contents completely and ensure retention of the liquid within the secondary outer component in the event that the primary inner component leaks.

(l) Each package designed for gases, other than tritium not exceeding 40 TBq (1080Ci) or noble gases not exceeding the A₂ value appropriate for the noble gas, will be able to prevent loss or dispersal of contents when the package is subjected to the tests prescribed in §173.466 or evaluated against these tests by any of the methods authorized by §173.461(a).

[Amdt. 173-244, 60 FR 50307, Sept. 28, 1995, as amended by 66 FR 45379, Aug. 28, 2001; 68 FR 57633, Oct. 6, 2003; 79 FR 40612, July 11, 2014]

§173.413 Requirements for Type B packages.

Except as provided in §173.416, each Type B(U) or Type B(M) package must be designed and constructed to meet the applicable requirements specified in 10 CFR part 71.

§ 173.415 Authorized Type A packages.

The following packages are authorized for shipment if they do not contain quantities exceeding A₁ or A₂ as appropriate:

(a) DOT Specification 7A (see §178.350 of this subchapter) Type A general packaging. Until January 1, 2017 each offeror of a Specification 7A package must maintain on file for at least one year after the latest shipment, and shall provide to DOT on request, complete documentation of tests and an engineering evaluation or comparative data showing that the construction methods, packaging design, and materials of construction comply with that specification. After January 1, 2017

§ 173.416

each offeror of a Specification 7A package must maintain on file for at least two years after the offeror's latest shipment, and shall provide to DOT on request, one of the following:

(1) A description of the package showing materials of construction, dimensions, weight, closure and closure materials (including gaskets, tape, etc.) of each item of the containment system, shielding and packing materials used in normal transportation, and the following:

(i) If the packaging is subjected to the physical tests of §173.465, and if applicable, §173.466, documentation of testing, including date, place of test, signature of testers, a detailed description of each test performed including equipment used, and the damage to each item of the containment system resulting from the tests, or

(ii) For any other demonstration of compliance with tests authorized in §173.461, a detailed analysis which shows that, for the contents being shipped, the package meets the pertinent design and performance requirements for a DOT 7A Type A specification package.

(2) If the offeror has obtained the packaging from another person who meets the definition of "packaging manufacturer" in §178.350(c) of this subchapter, a certification from the packaging manufacturer that the package meets all the requirements of §178.350 for the radioactive contents presented for transport and a copy of documents maintained by the packaging manufacturer that meet the requirements of paragraph (a)(1) of this section.

(b) Any other Type A packaging that also meets the applicable standards for fissile materials in 10 CFR part 71 and is used in accordance with §173.471.

(c) Any Type B(U) or Type B(M) packaging authorized pursuant to §173.416.

(d) Any foreign-made packaging that meets the standards in "IAEA Regulations for the Safe Transport of Radioactive Material No. TS-R-1" (IBR, see §171.7 of this subchapter) and bears the marking "Type A". Such packagings may be used for domestic and export shipments of Class 7 (radioactive) materials provided the offeror obtains the

49 CFR Ch. I (10–1–14 Edition)

applicable documentation of tests and engineering evaluations and maintains the documentation on file in accordance with paragraph (a) of this section. These packagings must conform with requirements of the country of origin (as indicated by the packaging marking) and the IAEA regulations applicable to Type A packagings.

[Amdt. 173-244, 60 FR 50307, Sept. 28, 1995, as amended at 67 FR 61014, Sept. 27, 2002; 68 FR 75742, Dec. 31, 2003; 69 FR 3673, Jan. 26, 2004; 69 FR 55117, Sept. 13, 2004; 79 FR 40612, July 11, 2014]

§ 173.416 Authorized Type B packages.

Each of the following packages is authorized for shipment of quantities exceeding A₁ or A₂, as appropriate:

(a) Any Type B(U) or Type B(M) packaging that meets the applicable requirements of 10 CFR part 71 and that has been approved by the U.S. Nuclear Regulatory Commission may be shipped pursuant to §173.471.

(b) Any Type B(U) or B(M) packaging that meets the applicable requirements in "IAEA Regulations for the Safe Transport of Radioactive Material, No. TS-R-1" (IBR, see §171.7 of this subchapter) and for which the foreign Competent Authority Certificate has been revalidated by DOT pursuant to §173.473. These packagings are authorized only for export and import shipments.

(c) A package approved by the U.S. Nuclear Regulatory Commission under a special package authorization granted in accordance with 10 CFR 71.41(d) provided it is offered only for domestic transportation in accordance with the requirements in §173.471(b) and (c).

[69 FR 3673, Jan. 26, 2004, as amended at 79 FR 40612, July 11, 2014]

§ 173.417 Authorized fissile materials packages.

(a) Except as provided in §173.453, fissile materials containing not more than A₁ or A₂ as appropriate, must be packaged in one of the following packagings:

(1)(i) Any packaging listed in §173.415, limited to the Class 7 (radioactive) materials specified in 10 CFR part 71, subpart C;

(ii) Any Type AF, Type B(U)F, or Type B(M)F packaging that meets the

applicable standards for fissile material packages in 10 CFR part 71; or

(iii) Any Type AF, Type B(U)F, or Type B(M)F packaging that meets the applicable requirements for fissile material packages in Section VI of the International Atomic Energy Agency "Regulations for the Safe Transport of Radioactive Material, No. TS-R-1 (IBR, see §171.7 of this subchapter)," and for which the foreign Competent Authority certificate has been revalidated by the U.S. Competent Authority, in accordance with §173.473. These packages

are authorized only for export and import shipments.

(2) A residual "heel" of enriched solid uranium hexafluoride may be transported without a protective overpack in any metal cylinder that meets both the requirements of §173.415 and §178.350 of this subchapter for Specification 7A Type A packaging, and the requirements of §173.420 for packagings containing greater than 0.1 kg of uranium hexafluoride. Any such shipment must be made in accordance with Table 2, as follows:

TABLE 2—ALLOWABLE CONTENT OF URANIUM HEXAFLUORIDE (UF₆ "HEEL" IN A SPECIFICATION 7A CYLINDER)

Maximum cylinder diameter		Cylinder volume		Maximum Uranium 235-enrichment (weight) percent	Maximum "Heel" weight per cylinder			
Centimeters	Inches	Liters	Cubic feet		UF ₆		Uranium-235	
					kg	lb	kg	lb
12.7	5	8.8	0.311	100.0	0.045	0.1	0.031	0.07
20.3	8	39.0	1.359	12.5	0.227	0.5	0.019	0.04
30.5	12	68.0	2.410	5.0	0.454	1.0	0.015	0.03
76.0	30	725.0	25.64	5.0	11.3	25.0	0.383	0.84
122.0	48	3,084.0	¹ 108.9	4.5	22.7	50.0	0.690	1.52
122.0	48	4,041.0	² 142.7	4.5	22.7	50.0	0.690	1.52

¹ 10 ton.
² 14 ton

(b) Fissile Class 7 (radioactive) materials with radioactive content exceeding A₁ or A₂ must be packaged in one of the following packagings:

(1) Type B(U), or Type B(M) packaging that meets the standards for packaging of fissile materials in 10 CFR part 71, and is approved by the U.S. Nuclear Regulatory Commission and used in accordance with §173.471;

(2) Type B(U) or Type B(M) packaging that also meets the applicable requirements for fissile material packaging in Section VI of the International Atomic Energy Agency "Regulations for the Safe Transport of Radioactive Material, No. TS-R-1," and for which the foreign Competent Authority certificate has been revalidated by the U.S. Competent Authority in accordance with §173.473. These packagings are authorized only for import and export shipments; or

(c) A package approved by the U.S. Nuclear Regulatory Commission under a special package authorization granted in accordance with 10 CFR 71.41(d) provided it is offered only for domestic

transportation in accordance with the requirements in §173.471(b) and (c).

[69 FR 3673, Jan. 26, 2004; 69 FR 55118, Sept. 13, 2004, as amended at 79 FR 40612, July 11, 2014]

§ 173.418 Authorized packages—pyrophoric Class 7 (radioactive) materials.

Pyrophoric Class 7 (radioactive) materials, as referenced in the §172.101 table of this subchapter, in quantities not exceeding A₂ per package must be transported in DOT Specification 7A packagings constructed of materials that will not react with, nor be decomposed by, the contents. Contents of the package must be—

(a) In solid form and must not be fissile unless excepted by §173.453;

(b) Contained in sealed and corrosion resistant receptacles with positive closures (friction or slip-fit covers or stoppers are not authorized);

(c) Free of water and contaminants that would increase the reactivity of the material; and

(d) Inerted to prevent self-ignition during transport by either—

§ 173.419

49 CFR Ch. I (10–1–14 Edition)

(1) Mixing with large volumes of inerting materials, such as graphite, dry sand, or other suitable inerting material, or blended into a matrix of hardened concrete; or

(2) Filling the innermost receptacle with an appropriate inert gas or liquid.

(e) Pyrophoric Class 7 (radioactive) materials transported by aircraft must be packaged in Type B packages.

[Amdt. 173-244, 60 FR 50307, Sept. 28, 1995, as amended at 68 FR 45038, July 31, 2003; 70 FR 56098, Sept. 23, 2005]

§ 173.419 Authorized packages—oxidizing Class 7 (radioactive) materials.

(a) An oxidizing Class 7 (radioactive) material, as referenced in the §172.101 table of this subchapter, is authorized in quantities not exceeding an A₂ per package, in a DOT Specification 7A package provided that—

(1) The contents are:

(i) Not fissile;

(ii) Packed in inside packagings of glass, metal or compatible plastic; and

(iii) Cushioned with a material that will not react with the contents; and

(2) The outside packaging is made of wood, metal, or plastic.

(b) The package must be capable of meeting the applicable test requirements of §173.465 without leakage of contents.

(c) For shipment by air, the maximum quantity in any package may not exceed 11.3 kg (25 pounds).

[Amdt. 173-244, 60 FR 50307, Sept. 28, 1995, as amended at 66 FR 45380, Aug. 28, 2001]

§ 173.420 Uranium hexafluoride (fissile, fissile excepted and non-fissile).

(a) In addition to any other applicable requirements of this subchapter, quantities greater than 0.1 kg of fissile, fissile excepted or non-fissile uranium hexafluoride must be offered for transportation as follows:

(1) Before initial filling and during periodic inspection and test, packagings must be cleaned in accordance with American National Standard N14.1 (IBR, see §171.7 of this subchapter).

(2) Packagings must be designed, fabricated, inspected, tested and marked in accordance with—

(i) American National Standard N14.1 in effect at the time the packaging was manufactured;

(ii) [Reserved]

(iii) Section VIII of the ASME Code (IBR, see §171.7 of this subchapter), provided the packaging—

(A) Was manufactured on or before June 30, 1987;

(B) Conforms to the edition of the ASME Code in effect at the time the packaging was manufactured;

(C) Is used within its original design limitations; and

(D) Has shell and head thicknesses that have not decreased below the minimum value specified in the following table:

Packaging model	Minimum thickness, millimeters (inches)
1S, 2S	1.58 (0.062)
5A, 5B, 8A	3.17 (0.125)
12A, 12B	4.76 (0.187)
30B	7.93 (0.312)
48A, F, X, and Y	12.70 (0.500)
48T, O, OM, OM Allied, HX, H, and G ...	6.35 (0.250)

(3) Each package shall be designed so that it will:

(i) Withstand a hydraulic test at an internal pressure of at least 1.4 MPa (200 psig) without leakage;

(ii) Withstand the test specified in §173.465(c) without loss or dispersal of the uranium hexafluoride; and

(iii) Withstand the test specified in 10 CFR 71.73(c)(4) without rupture of the containment system.

(4) Uranium hexafluoride must be in solid form.

(5) The volume of solid uranium hexafluoride, except solid depleted uranium hexafluoride, at 20 °C (68 °F) may not exceed 61% of the certified volumetric capacity of the packaging. The volume of solid depleted uranium hexafluoride at 20 °C (68 °F) may not exceed 62% of the certified volumetric capacity of the packaging.

(6) The pressure in the package at 20 °C (68 °F) must be less than 101.3 kPa (14.7 psia).

(b) Each packaging for uranium hexafluoride must be periodically inspected, tested, marked and otherwise conform with the American National Standard N14.1.

(c) Each repair to a packaging for uranium hexafluoride must be performed in accordance with the American National Standard N14.1.

(d) Non-fissile uranium hexafluoride, in quantities of less than 0.1 kg, may be shipped in packaging that meets §§ 173.24, 173.24a, and 173.410.

(e) For a package containing 0.1 kg or more of UF₆, the proper shipping name and UN number “Radioactive material, uranium hexafluoride, UN 2978” must be used for the transportation of non-fissile or fissile-excepted uranium hexafluoride and the proper shipping name and UN number “Radioactive material, uranium hexafluoride, fissile, UN 2977” must be used for the transport of fissile uranium hexafluoride.

[69 FR 3675, Jan. 26, 2004; 69 FR 55118, Sept. 13, 2004, as amended at 79 FR 40612, July 11, 2014]

§ 173.421 Excepted packages for limited quantities of Class 7 (radioactive) materials.

A Class 7 (radioactive) material with an activity per package which does not exceed the limited quantity package limits specified in Table 4 in § 173.425, and its packaging, are excepted from requirements in this subchapter for specification packaging, marking (except for the UN identification number marking requirement described in § 173.422(a)), labeling, and if not a hazardous substance or hazardous waste, shipping papers, and the requirements of this subpart if:

(a) Each package meets the general design requirements of § 173.410;

(b) The radiation level at any point on the external surface of the package does not exceed 0.005 mSv/h (0.5 mrem/h);

(c) The non-fixed contamination on the external surface of the package does not exceed the limits specified in § 173.443(a);

(d) The outside of the inner packaging or, if there is no inner packaging, the outside of the packaging itself bears the marking “Radioactive;”

(e) The package does not contain fissile material unless excepted by § 173.453; and

(f) The material is otherwise prepared for shipment as specified in accordance with § 173.422.

[79 FR 40613, July 11, 2014]

§ 173.422 Additional requirements for excepted packages containing Class 7 (radioactive) materials.

An excepted package of Class 7 (radioactive) material that is prepared for shipment under the provisions of § 173.421, § 173.424, § 173.426, or § 173.428, or a small quantity of another hazard class transported by highway or rail (as defined in § 173.4) which also meets the requirements of one of these sections, is not subject to any additional requirements of this subchapter, except for the following:

(a) The outside of each package must be marked with:

(1) The UN identification number for the material preceded by the letters UN, as shown in column (4) of the Hazardous Materials Table in § 172.101 of this subchapter; and

(2) The letters “RQ” on a non-bulk packaging containing a hazardous substance.

(b) Sections 171.15 and 171.16 of this subchapter, pertaining to the reporting of incidents;

(c) Sections 174.750, 175.700(b), and 176.710 of this subchapter (depending on the mode of transportation), pertaining to the reporting of decontamination;

(d) The training requirements of subpart H of part 172 of this subchapter; and

(e) For a material that meets the definition of a hazardous substance or a hazardous waste, the shipping paper requirements of subpart C of part 172 of this subchapter, except that such shipments are not subject to shipping paper requirements applicable to Class 7 (radioactive) materials in §§ 172.202(a)(5), 172.202(a)(6), 172.203(d) and 172.204(c)(4).

[69 FR 3675, Jan. 26, 2004, as amended at 79 FR 40613, July 11, 2014]

§ 173.423 Requirements for multiple hazard limited quantity Class 7 (radioactive) materials.

(a) Except as provided in § 173.4, when a limited quantity radioactive material meets the definition of another hazard class or division, it must be—

(1) Classed for the additional hazard;

§ 173.424

49 CFR Ch. I (10–1–14 Edition)

(2) Packaged to conform with the requirements specified in §173.421(a)(1) through (a)(5) or §173.424(a) through (g), as appropriate; and

(3) Offered for transportation in accordance with the requirements applicable to the hazard for which it is classed.

(b) A limited quantity Class 7 (radioactive) material which is classed other than Class 7 in accordance with this subchapter is excepted from the requirements of §§173.422(a), 172.203(d), and 172.204(c)(4) of this subchapter if the entry “Limited quantity radioactive material” appears on the shipping paper in association with the basic description.

§ 173.424 Excepted packages for radioactive instruments and articles.

A radioactive instrument or article and its packaging are excepted from requirements in this subchapter for specification packaging, labeling, marking (except for the UN identification number marking requirement described in §173.422(a)), and if not a hazardous substance or hazardous waste, shipping papers and the requirements of this subpart if:

(a) Each package meets the general design requirements of §173.410;

(b) The activity of the instrument or article does not exceed the relevant limit listed in Table 4 in §173.425;

(c) The total activity per package does not exceed the relevant limit listed in Table 4 in §173.425;

(d) The radiation level at 10 cm (4 in) from any point on the external surface of any unpackaged instrument or article does not exceed 0.1 mSv/hour (10 mrem/hour);

(e) The active material is completely enclosed by non-active components (a device performing the sole function of containing radioactive material shall not be considered to be an instrument or manufactured article);

(f) The radiation level at any point on the external surface of a package bearing the article or instrument does not exceed 0.005 mSv/hour (0.5 mrem/hour), or, for exclusive use domestic shipments, 0.02 mSv/hour (2 mrem/hour);

(g) The nonfixed (removable) radioactive surface contamination on the external surface of the package does not exceed the limits specified in §173.443(a);

(h) Except as provided in §173.426, the package does not contain more than 15 g of uranium-235; and

(i) The package is otherwise prepared for shipment as specified in §173.422.

[69 FR 3675, Jan. 26, 2004]

§ 173.425 Table of activity limits—excepted quantities and articles.

The limits applicable to instruments, articles, and limited quantities subject to exceptions under §§173.421 and 173.424 are set forth in table 4 as follows:

TABLE 4—ACTIVITY LIMITS FOR LIMITED QUANTITIES, INSTRUMENTS, AND ARTICLES

Nature of contents	Instruments and articles		Limited quantity package limits ¹
	Limits for each instrument or article ¹	Package limits ¹	
Solids:			
Special form	$10^{-2} A_1$	A_1	$10^{-3} A_1$
Normal form	$10^{-2} A_2$	A_2	$10^{-3} A_2$
Liquids:			
Tritiated water:			
<0.0037 TBq/L (0.1 Ci/L)			37 TBq (1,000 Ci)
0.0037 TBq to 0.037 TBq/L (0.1 Ci to 1.0 Ci/L)			3.7 TBq (100 Ci)
>0.037 TBq/L (1.0 Ci/L)			0.037 TBq (1.0 Ci)
Other Liquids	$10^{-3} A_2$	$10^{-1} A_2$	$10^{-4} A_2$
Gases:			
Tritium ²	$2 \times 10^{-2} A_2$	$2 \times 10^{-1} A_2$	$2 \times 10^{-2} A_2$
Special form	$10^{-3} A_1$	$10^{-2} A_1$	$10^{-3} A_1$
Normal form	$10^{-3} A_2$	$10^{-2} A_2$	$10^{-3} A_2$

¹ For mixtures of radionuclides see §173.433(d).

² These values also apply to tritium in activated luminous paint and tritium adsorbed on solid carriers.

[Amdt. 173-244, 60 FR 50307, Sept. 28, 1995, as amended by Amdt. 173-244, 61 FR 20751, May 8, 1996; 63 FR 52849, Oct. 1, 1998; 65 FR 58630, Sept. 29, 2000; 66 FR 45383, Aug. 28, 2001; 69 FR 3676, Jan. 26, 2004]

§ 173.426 Excepted packages for articles containing natural uranium or thorium.

A manufactured article in which the sole Class 7 (radioactive) material content is natural uranium, unirradiated depleted uranium or natural thorium, and its packaging, are excepted from the requirements in this subchapter for specification packaging, labeling, marking (except for the UN identification number marking requirement described in § 173.422(a)), and if not a hazardous substance or hazardous waste, shipping papers and the requirements of this subpart if:

- (a) Each package meets the general design requirements of § 173.410;
- (b) The outer surface of the uranium or thorium is enclosed in an inactive sheath made of metal or other durable protective material;
- (c) The conditions specified in § 173.421(a) (2), (3) and (4) are met; and
- (d) The article is otherwise prepared for shipment as specified in § 173.422.

[Amdt. 173-244, 60 FR 50307, Sept. 28, 1995, as amended by Amdt. 173-244, 61 FR 20752, May 8, 1996; 69 FR 3676, Jan. 26, 2004]

§ 173.427 Transport requirements for low specific activity (LSA) Class 7 (radioactive) material and surface contaminated objects (SCO).

(a) In addition to other applicable requirements specified in this subchapter, LSA material and SCO must be transported in accordance with the following conditions:

- (1) The external dose rate may not exceed an external radiation level of 10 mSv/h (1 rem/h) at 3 m (10 feet) from the unshielded material;
- (2) The quantity of LSA material and SCO transported in any single conveyance may not exceed the limits specified in Table 5;
- (3) LSA material and SCO that are or contain fissile material must conform to the applicable requirements of § 173.453;
- (4) Packaged and unpackaged Class 7 (radioactive) materials must conform

to the contamination control limits specified in § 173.443;

(5) External radiation levels may not exceed those specified in § 173.441; and

(6) For LSA material and SCO consigned as exclusive use:

(i) Shipments must be loaded by the consignor and unloaded by the consignee from the conveyance or freight container in which originally loaded;

(ii) There may be no loose radioactive material in the conveyance; however, when the conveyance is the packaging, there may not be any leakage of radioactive material from the conveyance;

(iii) Packaged and unpackaged Class 7 (radioactive) material must be braced so as to prevent shifting of lading under conditions normally incident to transportation;

(iv) Specific instructions for maintenance of exclusive use shipment controls shall be provided by the offeror to the carrier. Such instructions must be included with the shipping paper information;

(v) The shipment must be placarded in accordance with subpart F of part 172 of this subchapter;

(vi) For domestic transportation only, packaged and unpackaged Class 7 (radioactive) material containing less than an A₂ quantity are excepted from the marking and labeling requirements of this subchapter, other than the subsidiary hazard labeling required in § 172.402(d). However, the exterior of each package or unpackaged Class 7 (radioactive) material must be stenciled or otherwise marked "RADIOACTIVE—LSA" or "RADIOACTIVE—SCO", as appropriate, and packages or unpackaged Class 7 (radioactive) material that contain a hazardous substance must be stenciled or otherwise marked with the letters "RQ" in association with the description in this paragraph (a)(6)(vi); and

(vii) Transportation by aircraft is prohibited except when transported in an industrial package in accordance with Table 6 of this section, or in an authorized Type A or Type B package.

§ 173.427

49 CFR Ch. I (10–1–14 Edition)

(b) Except as provided in paragraph (c) or (d) of this section, LSA material and SCO must be packaged as follows:

(1) In an industrial package (Type IP-1, Type IP-2 or Type IP-3; §173.411), subject to the limitations of Table 6;

(2) In a DOT Specification 7A (§178.350 of this subchapter) Type A package;

(3) In any Type B(U) or B(M) packaging authorized pursuant to §173.416;

(4) For domestic transportation of an exclusive use shipment that is less than an A₂ quantity, in a packaging which meets the requirements of §173.410; or

(5) In portable tanks, cargo tanks and tank cars, as provided in §173.411(b)(4) and (5), respectively.

(c) LSA-I material and SCO-I may be transported unpackaged under the following conditions:

(1) All unpackaged material, other than ores containing only naturally occurring radionuclides, must be transported in such a manner that under routine conditions of transport there will be no escape of the radioactive

contents from the conveyance nor will there be any loss of shielding;

(2) Each conveyance must be under exclusive use, except when only transporting SCO-I on which the contamination on the accessible and the inaccessible surfaces is not greater than 4.0 Bq/cm² for beta and gamma emitters and low toxicity alpha emitters and 0.4 Bq/cm² for all other alpha emitters;

(3) For SCO-I where it is reasonable to suspect that non-fixed contamination may exist on inaccessible surfaces in excess of the values specified in paragraph (c)(2) of this section, measures shall be taken to ensure that the radioactive material is not released into the conveyance or to the environment; and

(4) The highway or rail conveyance must be placarded in accordance with subpart F of part 172 of this subchapter.

(d) LSA material and SCO that exceed the packaging limits in this section must be packaged in accordance with 10 CFR part 71.

(e) Tables 5 and 6 are as follows:

TABLE 5—CONVEYANCE ACTIVITY LIMITS FOR LSA MATERIAL AND SCO

Nature of material	Activity limit for conveyances other than by inland waterway	Activity limit for hold or compartment of an inland waterway conveyance
1. LSA-I	No limit	No limit.
2. LSA-II and LSA-III; Non-combustible solids	No limit	100 A ₂ .
3. LSA-II and LSA-III; Combustible solids and all liquids and gases.	100 A ₂	10 A ₂ .
4. SCO	100 A ₂	10 A ₂ .

TABLE 6—INDUSTRIAL PACKAGE INTEGRITY REQUIREMENTS FOR LSA MATERIAL AND SCO

Contents	Industrial packaging type	
	Exclusive use shipment	Non exclusive use shipment
1. LSA-I:		
Solid	Type IP-1	Type IP-1.
Liquid	Type IP-1	Type IP-2.
2. LSA-II:		
Solid	Type IP-2	Type IP-2.
Liquid and gas	Type IP-2	Type IP-3.
3. LSA-III	Type IP-2	Type IP-3.
4. SCO-I	Type IP-1	Type IP-1.
5. SCO-II	Type IP-2	Type IP-2.

[79 FR 40613, July 11, 2014]

§ 173.428 Empty Class 7 (radioactive) materials packaging.

A packaging which previously contained Class 7 (radioactive) materials and has been emptied of contents as far as practical, is excepted from the shipping paper and marking (except for the UN identification number marking requirement described in §173.422(a)) requirements of this subchapter, provided that—

(a) The packaging meets the requirements of §173.421(a) (2), (3), and (5) of this subpart;

(b) The packaging is in unimpaired condition and is securely closed so that there will be no leakage of Class 7 (radioactive) material under conditions normally incident to transportation;

(c) The outer surface of any uranium or thorium in its structure is covered with an inactive sheath made of metal or some other substantial material;

(d) Internal contamination does not exceed 100 times the limits in §173.443(a);

(e) Any labels previously applied in conformance with subpart E of part 172 of this subchapter are removed, obliterated, or covered and the “Empty” label prescribed in §172.450 of this subchapter is affixed to the packaging; and

(f) The packaging is prepared for shipment as specified in §173.422.

[Amdt. 173-244, 60 FR 50307, Sept. 28, 1995, as amended by Amdt. 173-244, 61 FR 20752, May 8, 1996; 64 FR 51919, Sept. 27, 1999; 69 FR 3677, Jan. 26, 2004]

§ 173.431 Activity limits for Type A and Type B packages.

(a) Except for LSA material and SCO, a Type A package may not contain a quantity of Class 7 (radioactive) materials greater than A_1 for special form Class 7 (radioactive) material or A_2 for normal form Class 7 (radioactive) material as listed in §173.435, or, for Class 7 (radioactive) materials not listed in §173.435, as determined in accordance with §173.433.

(b) The limits on activity contained in a Type B(U) or Type B(M) package are those prescribed in §§173.416 and 173.417, or in the applicable approval

certificate under §173.471, §173.472 or §173.473.

[Amdt. 173-244, 60 FR 50307, Sept. 28, 1995, as amended at 69 FR 3677, Jan. 26, 2004]

§ 173.433 Requirements for determining basic radionuclide values, and for the listing of radionuclides on shipping papers and labels.

(a) For individual radionuclides listed in the table in §173.435 and §173.436:

(1) A_1 and A_2 values are given in the table in §173.435; and

(2) Activity concentration exemption values and consignment activity exemption values are given in the table in §173.436.

(b) For individual radionuclides which are not listed in the tables in §173.435 or §173.436 or for which no relevant data are available:

(1) the radionuclide values in Tables 7 or 8 of this section may be used; or

(2) other basic radionuclide values may be used provided they are first approved by the Associate Administrator or, for international transport, multilateral approval is obtained from the pertinent Competent Authorities.

(c) In calculating A_1 and A_2 values for approval in accordance with paragraph (b)(2) of this section:

(1) It is permissible to use an A_2 value calculated using a dose coefficient for the appropriate lung absorption type, as recommended by the International Commission on Radiological Protection, if the chemical forms of each radionuclide under both normal and accident conditions of transport are taken into consideration.

(2) A single radioactive decay chain in which the radionuclides are present in their naturally-occurring proportions, and in which no daughter nuclide has a half life either longer than 10 days or longer than that of the parent nuclide, will be considered as a single radionuclide, and the activity to be taken into account and the A_1 or A_2 value to be applied will be those corresponding to the parent nuclide of that chain. Otherwise, the parent and daughter nuclides will be considered as a mixture of different nuclides.

(d) Mixtures of radionuclides whose identities and respective activities are known must conform to the following conditions:

§ 173.433

(1) For special form Class 7 (radioactive) material, the activity which may be transported in a Type A package must satisfy:

$$\sum_i \frac{B(i)}{A_1(i)} \leq 1$$

Where:

B(i) is the activity of radionuclide i in special form; and

A₁(i) is the A₁ value for radionuclide i.

(2) For normal form Class 7 (radioactive) material, the activity which may be transported in a Type A package must satisfy:

$$\sum_j \frac{C(j)}{A_2(j)} \leq 1$$

Where:

C(j) is the activity of radionuclide j in normal form; and

A₂(j) is the A₂ value for radionuclide j.

(3) If the package contains both special and normal form Class 7 (radioactive) material, the activity which may be transported in a Type A package must satisfy:

$$\sum_i \frac{B(i)}{A_1(i)} + \sum_j \frac{C(j)}{A_2(j)} \leq 1$$

Where:

f(i) is the fraction of activity concentration of nuclide i in the mixture; and [A](i) is the activity concentration for exempt material containing nuclide i.

$$\text{Exempt activity concentration limit for mixture} = \frac{1}{\sum_i \frac{f(i)}{[A](i)}}$$

$$\text{Exempt consignment activity limit for mixture} = \frac{1}{\sum_i \frac{f(i)}{A(i)}}$$

Where:

f(i) is the fraction of activity of nuclide i in the mixture; and

49 CFR Ch. I (10–1–14 Edition)

Where:

The symbols are defined as in paragraphs (d)(1) and (d)(2) of this section.

(4) Alternatively, the A₁ value for a mixture of special form material may be determined as follows:

$$A_1 \text{ for mixture} = \frac{1}{\sum_i \frac{f(i)}{A_1(i)}}$$

Where:

f(i) is the fraction of activity for radionuclide i in the mixture; and

A₁(i) is the appropriate A₁ value for radionuclide i.

(5) Alternatively, the A₂ value for mixtures of normal form material may be determined as follows:

$$A_2 \text{ for mixture} = \frac{1}{\sum_i \frac{f(i)}{A_2(i)}}$$

Where:

f(i) is the fraction of activity for normal form radionuclide i in the mixture; and

A₂(i) is the appropriate A₂ value for radionuclide i.

(6) The exempt activity concentration for mixtures of nuclides may be determined as follows:

(7) The activity limit for an exempt consignment for mixtures of nuclides may be determined as follows:

A(i) is the activity limit for exempt consignments for nuclide i.

(e) When the identity of each nuclide is known but the individual activities of some of the radionuclides are not known, the radionuclides may be grouped and the lowest A₁ or A₂ value, as appropriate, for the radionuclides in each group may be used in applying the formulas in paragraphs (d)(1) through (d)(5) of this section. Groups may be based on the total alpha activity and the total beta/gamma activity when these are known, using the lowest A₁ or A₂ values for the alpha emitters or beta/gamma emitters, respectively.

(f) When the identity of each nuclide is known but the individual activities of some of the radionuclides are not known, the radionuclides may be grouped and the lowest [A] (activity concentration for exempt material) or A (activity limit for exempt consignment) value, as appropriate, for the radionuclides in each group may be used in applying the formulas in paragraphs (d)(6) and (d)(7) of this section. Groups may be based on the total alpha activity and the total beta/gamma ac-

tivity when these are known, using the lowest [A] or A values for the alpha emitters or beta/gamma emitters, respectively.

(g) *Shipping papers and labeling.* For mixtures of radionuclides, the radionuclides (n) that must be shown on shipping papers and labels in accordance with §§172.203 and 172.403 of this subchapter, respectively, must be determined on the basis of the following formula:

$$\sum_{i=1}^n \frac{a_{(i)}}{A_{(i)}} \geq 0.95 \sum_{i=1}^{n+m} \frac{a_{(i)}}{A_{(i)}}$$

Where:

n + m represents all the radionuclides in the mixture;

m are the radionuclides that do not need to be considered;

a_(i) is the activity of radionuclide i in the mixture; and

A_(i) is the A₁ or A₂ value, as appropriate for radionuclide i.

(h) Tables 7 and 8 are as follows:

TABLE 7—GENERAL VALUES FOR A₁ AND A₂

Radioactive contents	A ₁		A ₂	
	(TBq)	(Ci)	(TBq)	(Ci)
1. Only beta or gamma emitting nuclides are known to be present	1 × 10 ⁻¹	2.7 × 10 ⁰	2 × 10 ⁻²	5.4 × 10 ⁻¹
2. Alpha emitting nuclides, but no beta, gamma, or neutron emitters, are known to be present ¹	2 × 10 ⁻¹	5.4 × 10 ⁰	9 × 10 ⁻⁵	2.4 × 10 ⁻³
3. Neutron emitting nuclides are known to be present or no relevant data are available	1 × 10 ⁻³	2.7 × 10 ⁻²	9 × 10 ⁻⁵	2.4 × 10 ⁻³

¹ If beta or gamma emitting nuclides are also known to be present, the A₁ value of 0.1 TBq (2.7 Ci) should be used.

TABLE 8—GENERAL EXEMPTION VALUES

Radioactive contents	Activity concentration for exempt material		Activity limits for exempt consignments	
	(Bq/g)	(Ci/g)	(Bq)	(Ci)
1. Only beta or gamma emitting nuclides are known to be present	1 × 10 ¹	2.7 × 10 ⁻¹⁰	1 × 10 ⁴	2.7 × 10 ⁻⁷
2. Alpha emitting nuclides, but no neutron emitters, are known to be present	1 × 10 ⁻¹	2.7 × 10 ⁻¹²	1 × 10 ³	2.7 × 10 ⁻⁸
3. Neutron emitting nuclides are known to be present or no relevant data are available	1 × 10 ⁻¹	2.7 × 10 ⁻¹²	1 × 10 ³	2.7 × 10 ⁻⁸

[69 FR 3677, Jan. 26, 2004; 69 FR 55119, Sept. 13, 2004, as amended at 79 FR 40614, July 11, 2014]

§ 173.434 Activity-mass relationships for uranium and natural thorium.

The table of activity-mass relationships for uranium and natural thorium are as follows:

Thorium and uranium enrichment ¹ (Wt% ²³⁵ U present)	Specific activity			
	TBq/gram	Grams/Tbq	Ci/gram	Grams/Ci
0.45 (depleted)	1.9×10 ⁻⁸	5.4×10 ⁷	5.0×10 ⁻⁷	2.0×10 ⁶
0.72 (natural)	2.6×10 ⁻⁸	3.8×10 ⁷	7.1×10 ⁻⁷	1.4×10 ⁶
1.0	2.8×10 ⁻⁸	3.6×10 ⁷	7.6×10 ⁻⁷	1.3×10 ⁶
1.5	3.7×10 ⁻⁸	2.7×10 ⁷	1.0×10 ⁻⁶	1.0×10 ⁶
5.0	1.0×10 ⁻⁷	1.0×10 ⁷	2.7×10 ⁻⁶	3.7×10 ⁵
10.0	1.8×10 ⁻⁷	5.6×10 ⁶	4.8×10 ⁻⁶	2.1×10 ⁵
20.0	3.7×10 ⁻⁷	2.7×10 ⁶	1.0×10 ⁻⁵	1.0×10 ⁵
35.0	7.4×10 ⁻⁷	1.4×10 ⁶	2.0×10 ⁻⁵	5.0×10 ⁴
50.0	9.3×10 ⁻⁷	1.1×10 ⁶	2.5×10 ⁻⁵	4.0×10 ⁴
90.0	2.1×10 ⁻⁶	4.7×10 ⁵	5.8×10 ⁻⁵	1.7×10 ⁴
93.0	2.6×10 ⁻⁶	3.9×10 ⁵	7.0×10 ⁻⁵	1.4×10 ⁴
95.0	3.4×10 ⁻⁶	3.0×10 ⁵	9.1×10 ⁻⁵	1.1×10 ⁴
Natural thorium	8.1×10 ⁻⁹	1.2×10 ⁸	2.2×10 ⁻⁷	4.6×10 ⁶

¹ The figures for uranium include representative values for the activity of uranium-234 which is concentrated during the enrichment process. The activity for thorium includes the equilibrium concentration of thorium-228.

[Amdt. 173–244, 60 FR 50307, Sept. 28, 1995, as amended by 63 FR 52849, Oct. 1, 1998]

§ 173.435 Table of A₁ and A₂ values for radionuclides.

The table of A₁ and A₂ values for radionuclides is as follows:

Symbol of radionuclide	Element and atomic number	A ₁ (TBq)	A ₁ (Ci) ^b	A ₂ (TBq)	A ₂ (Ci) ^b	Specific activity	
						(TBq/g)	(Ci/g)
Ac-225 (a)	Actinium (89)	8.0×10 ⁻¹	2.2×10 ¹	6.0×10 ⁻³	1.6×10 ⁻¹	2.1×10 ³	5.8×10 ⁴
Ac-227 (a)	9.0×10 ⁻¹	2.4×10 ¹	9.0×10 ⁻⁵	2.4×10 ⁻³	2.7	7.2×10 ¹
Ac-228	6.0×10 ⁻¹	1.6×10 ¹	5.0×10 ⁻¹	1.4×10 ¹	8.4×10 ⁴	2.2×10 ⁶
Ag-105	Silver (47)	2.0	5.4×10 ¹	2.0	5.4×10 ¹	1.1×10 ³	3.0×10 ⁴
Ag-108m (a)	7.0×10 ⁻¹	1.9×10 ¹	7.0×10 ⁻¹	1.9×10 ¹	9.7×10 ⁻¹	2.6×10 ¹
Ag-110m (a)	4.0×10 ⁻¹	1.1×10 ¹	4.0×10 ⁻¹	1.1×10 ¹	1.8×10 ²	4.7×10 ³
Ag-111	2.0	5.4×10 ¹	6.0×10 ⁻¹	1.6×10 ¹	5.8×10 ³	1.6×10 ⁵
Al-26	Aluminum (13)	1.0×10 ⁻¹	2.7	1.0×10 ⁻¹	2.7	7.0×10 ⁻⁴	1.9×10 ⁻²
Am-241	Americium (95)	1.0×10 ¹	2.7×10 ²	1.0×10 ⁻³	2.7×10 ⁻²	1.3×10 ⁻¹	3.4
Am-242m (a)	1.0×10 ¹	2.7×10 ²	1.0×10 ⁻³	2.7×10 ⁻²	3.6×10 ⁻¹	1.0×10 ¹
Am-243 (a)	5.0	1.4×10 ²	1.0×10 ⁻³	2.7×10 ⁻²	7.4×10 ⁻³	2.0×10 ⁻¹
Ar-37	Argon (18)	4.0×10 ¹	1.1×10 ³	4.0×10 ¹	1.1×10 ³	3.7×10 ³	9.9×10 ⁴
Ar-39	4.0×10 ¹	1.1×10 ³	2.0×10 ¹	5.4×10 ²	1.3	3.4×10 ¹
Ar-41	3.0×10 ⁻¹	8.1	3.0×10 ⁻¹	8.1	1.5×10 ⁶	4.2×10 ⁷
As-72	Arsenic (33)	3.0×10 ⁻¹	8.1	3.0×10 ⁻¹	8.1	6.2×10 ⁴	1.7×10 ⁶
As-73	4.0×10 ¹	1.1×10 ³	4.0×10 ¹	1.1×10 ³	8.2×10 ²	2.2×10 ⁴
As-74	1.0	2.7×10 ¹	9.0×10 ⁻¹	2.4×10 ¹	3.7×10 ³	9.9×10 ⁴
As-76	3.0×10 ⁻¹	8.1	3.0×10 ⁻¹	8.1	5.8×10 ⁴	1.6×10 ⁶
As-77	2.0×10 ¹	5.4×10 ²	7.0×10 ⁻¹	1.9×10 ¹	3.9×10 ⁴	1.0×10 ⁶
At-211 (a)	Astatine (85)	2.0×10 ¹	5.4×10 ²	5.0×10 ⁻¹	1.4×10 ¹	7.6×10 ⁴	2.1×10 ⁶
Au-193	Gold (79)	7.0	1.9×10 ²	2.0	5.4×10 ¹	3.4×10 ⁴	9.2×10 ⁵
Au-194	1.0	2.7×10 ¹	1.0	2.7×10 ¹	1.5×10 ⁴	4.1×10 ⁵
Au-195	1.0×10 ¹	2.7×10 ²	6.0	1.6×10 ²	1.4×10 ²	3.7×10 ³
Au-198	1.0	2.7×10 ¹	6.0×10 ⁻¹	1.6×10 ¹	9.0×10 ³	2.4×10 ⁵
Au-199	1.0×10 ¹	2.7×10 ²	6.0×10 ⁻¹	1.6×10 ¹	7.7×10 ³	2.1×10 ⁵
Ba-131 (a)	Barium (56)	2.0	5.4×10 ¹	2.0	5.4×10 ¹	3.1×10 ³	8.4×10 ⁴
Ba-133	3.0	8.1×10 ¹	3.0	8.1×10 ¹	9.4	2.6×10 ²
Ba-133m	2.0×10 ¹	5.4×10 ²	6.0×10 ⁻¹	1.6×10 ¹	2.2×10 ⁴	6.1×10 ⁵
Ba-140 (a)	5.0×10 ⁻¹	1.4×10 ¹	3.0×10 ⁻¹	8.1	2.7×10 ³	7.3×10 ⁴
Be-7	Beryllium (4)	2.0×10 ¹	5.4×10 ²	2.0×10 ¹	5.4×10 ²	1.3×10 ⁴	3.5×10 ⁵
Be-10	4.0×10 ¹	1.1×10 ³	6.0×10 ⁻¹	1.6×10 ¹	8.3×10 ⁻⁴	2.2×10 ⁻²
Bi-205	Bismuth (83)	7.0×10 ⁻¹	1.9×10 ¹	7.0×10 ⁻¹	1.9×10 ¹	1.5×10 ³	4.2×10 ⁴
Bi-206	3.0×10 ⁻¹	8.1	3.0×10 ⁻¹	8.1	3.8×10 ³	1.0×10 ⁵
Bi-207	7.0×10 ⁻¹	1.9×10 ¹	7.0×10 ⁻¹	1.9×10 ¹	1.9	5.2×10 ¹
Bi-210	1.0	2.7×10 ¹	6.0×10 ⁻¹	1.6×10 ¹	4.6×10 ³	1.2×10 ⁵
Bi-210m (a)	6.0×10 ⁻¹	1.6×10 ¹	2.0×10 ⁻²	5.4×10 ⁻¹	2.1×10 ⁻⁵	5.7×10 ⁻⁴
Bi-212 (a)	7.0×10 ⁻¹	1.9×10 ¹	6.0×10 ⁻¹	1.6×10 ¹	5.4×10 ⁵	1.5×10 ⁷
Bk-247	Berkelium (97)	8.0	2.2×10 ²	8.0×10 ⁻⁴	2.2×10 ⁻²	3.8×10 ⁻²	1.0
Bk-249 (a)	4.0×10 ¹	1.1×10 ³	3.0×10 ⁻¹	8.1	6.1×10 ¹	1.6×10 ³
Br-76	Bromine (35)	4.0×10 ⁻¹	1.1×10 ¹	4.0×10 ⁻¹	1.1×10 ¹	9.4×10 ⁴	2.5×10 ⁶
Br-77	3.0	8.1×10 ¹	3.0	8.1×10 ¹	2.6×10 ⁴	7.1×10 ⁵
Br-82	4.0×10 ⁻¹	1.1×10 ¹	4.0×10 ⁻¹	1.1×10 ¹	4.0×10 ⁴	1.1×10 ⁶
C-11	Carbon (6)	1.0	2.7×10 ¹	6.0×10 ⁻¹	1.6×10 ¹	3.1×10 ⁷	8.4×10 ⁸
C-14	4.0×10 ¹	1.1×10 ³	3.0	8.1×10 ¹	1.6×10 ⁻¹	4.5
Ca-41	Calcium (20)	Unlimited	Unlimited	Unlimited	Unlimited	3.1×10 ⁻³	8.5×10 ⁻²
Ca-45	4.0×10 ¹	1.1×10 ³	1.0	2.7×10 ¹	6.6×10 ²	1.8×10 ⁴

Symbol of radionuclide	Element and atomic number	A ₁ (TBq)	A ₁ (Ci) ^b	A ₂ (TBq)	A ₂ (Ci) ^b	Specific activity	
						(TBq/g)	(Ci/g)
Ca-47 (a)		3.0	8.1×10 ¹	3.0×10 ⁻¹	8.1	2.3×10 ⁴	6.1×10 ⁵
Cd-109	Cadmium (48)	3.0×10 ¹	8.1×10 ²	2.0	5.4×10 ¹	9.6×10 ¹	2.6×10 ³
Cd-113m		4.0×10 ¹	1.1×10 ³	5.0×10 ⁻¹	1.4×10 ¹	8.3	2.2×10 ²
Cd-115 (a)		3.0	8.1×10 ¹	4.0×10 ⁻¹	1.1×10 ¹	1.9×10 ⁴	5.1×10 ⁵
Cd-115m		5.0×10 ⁻¹	1.4×10 ¹	5.0×10 ⁻¹	1.4×10 ¹	9.4×10 ²	2.5×10 ⁴
Ce-139	Cerium (58)	7.0	1.9×10 ²	2.0	5.4×10 ¹	2.5×10 ²	6.8×10 ³
Ce-141		2.0×10 ¹	5.4×10 ²	6.0×10 ⁻¹	1.6×10 ¹	1.1×10 ³	2.8×10 ⁴
Ce-143		9.0×10 ⁻¹	2.4×10 ¹	6.0×10 ⁻¹	1.6×10 ¹	2.5×10 ⁴	6.6×10 ⁵
Ce-144 (a)		2.0×10 ⁻¹	5.4	2.0×10 ⁻¹	5.4	1.2×10 ²	3.2×10 ³
Cf-248	Californium (98)	4.0×10 ¹	1.1×10 ³	6.0×10 ⁻³	1.6×10 ⁻¹	5.8×10 ¹	1.6×10 ³
Cf-249		3.0	8.1×10 ¹	8.0×10 ⁻⁴	2.2×10 ⁻²	1.5×10 ⁻¹	4.1
Cf-250		2.0×10 ¹	5.4×10 ²	2.0×10 ⁻³	5.4×10 ⁻²	4.0	1.1×10 ²
Cf-251		7.0	1.9×10 ²	7.0×10 ⁻⁴	1.9×10 ⁻²	5.9×10 ⁻²	1.6
Cf-252		1×10 ⁻¹	2.7	3.0×10 ⁻³	8.1×10 ⁻²	2.0×10 ¹	5.4×10 ²
Cf-253 (a)		4.0×10 ¹	1.1×10 ³	4.0×10 ⁻²	1.1	1.1×10 ³	2.9×10 ⁴
Cf-254		1.0×10 ⁻³	2.7×10 ⁻²	1.0×10 ⁻³	2.7×10 ⁻²	3.1×10 ²	8.5×10 ³
Cl-36	Chlorine (17)	1.0×10 ¹	2.7×10 ²	6.0×10 ⁻¹	1.6×10 ¹	1.2×10 ⁻³	3.3×10 ⁻²
Cl-38		2.0×10 ⁻¹	5.4	2.0×10 ⁻¹	5.4	4.9×10 ⁶	1.3×10 ⁸
Cm-240	Curium (96)	4.0×10 ¹	1.1×10 ³	2.0×10 ⁻²	5.4×10 ⁻¹	7.5×10 ²	2.0×10 ⁴
Cm-241		2.0	5.4×10 ¹	1.0	2.7×10 ¹	6.1×10 ²	1.7×10 ⁴
Cm-242		4.0×10 ¹	1.1×10 ³	1.0×10 ⁻²	2.7×10 ⁻¹	1.2×10 ²	3.3×10 ³
Cm-243		9.0	2.4×10 ²	1.0×10 ⁻³	2.7×10 ⁻²	1.9	5.2×10 ¹
Cm-244		2.0×10 ¹	5.4×10 ²	2.0×10 ⁻³	5.4×10 ⁻²	3.0	8.1×10 ¹
Cm-245		9.0	2.4×10 ²	9.0×10 ⁻⁴	2.4×10 ⁻²	6.4×10 ⁻³	1.7×10 ⁻¹
Cm-246		9.0	2.4×10 ²	9.0×10 ⁻⁴	2.4×10 ⁻²	1.1×10 ⁻²	3.1×10 ⁻¹
Cm-247 (a)		3.0	8.1×10 ¹	1.0×10 ⁻³	2.7×10 ⁻²	3.4×10 ⁻⁶	9.3×10 ⁻⁵
Cm-248		2.0×10 ⁻²	5.4×10 ⁻¹	3.0×10 ⁻⁴	8.1×10 ⁻³	1.6×10 ⁻⁴	4.2×10 ⁻³
Co-55	Cobalt (27)	5.0×10 ⁻¹	1.4×10 ¹	5.0×10 ⁻¹	1.4×10 ¹	1.1×10 ⁵	3.1×10 ⁶
Co-56		3.0×10 ⁻¹	8.1	3.0×10 ⁻¹	8.1	1.1×10 ³	3.0×10 ⁴
Co-57		1.0×10 ¹	2.7×10 ²	1.0×10 ¹	2.7×10 ²	3.1×10 ²	8.4×10 ³
Co-58		1.0	2.7×10 ¹	1.0	2.7×10 ¹	1.2×10 ³	3.2×10 ⁴
Co-58m		4.0×10 ¹	1.1×10 ³	4.0×10 ¹	1.1×10 ³	2.2×10 ⁵	5.9×10 ⁶
Co-60		4.0×10 ⁻¹	1.1×10 ¹	4.0×10 ⁻¹	1.1×10 ¹	4.2×10 ¹	1.1×10 ³
Cr-51	Chromium (24)	3.0×10 ¹	8.1×10 ²	3.0×10 ¹	8.1×10 ²	3.4×10 ³	9.2×10 ⁴
Cs-129	Cesium (55)	4.0	1.1×10 ²	4.0	1.1×10 ²	2.8×10 ⁴	7.6×10 ⁵
Cs-131		3.0×10 ¹	8.1×10 ²	3.0×10 ¹	8.1×10 ²	3.8×10 ³	1.0×10 ⁵
Cs-132		1.0	2.7×10 ¹	1.0	2.7×10 ¹	5.7×10 ³	1.5×10 ⁵
Cs-134		7.0×10 ⁻¹	1.9×10 ¹	7.0×10 ⁻¹	1.9×10 ¹	4.8×10 ¹	1.3×10 ³
Cs-134m		4.0×10 ¹	1.1×10 ³	6.0×10 ⁻¹	1.6×10 ¹	3.0×10 ⁵	8.0×10 ⁶
Cs-135		4.0×10 ¹	1.1×10 ³	1.0	2.7×10 ¹	4.3×10 ⁻⁵	1.2×10 ⁻³
Cs-136		5.0×10 ⁻¹	1.4×10 ¹	5.0×10 ⁻¹	1.4×10 ¹	2.7×10 ³	7.3×10 ⁴
Cs-137 (a)		2.0	5.4×10 ¹	6.0×10 ⁻¹	1.6×10 ¹	3.2	8.7×10 ¹
Cu-64	Copper (29)	6.0	1.6×10 ²	1.0	2.7×10 ¹	1.4×10 ⁵	3.9×10 ⁶
Cu-67		1.0×10 ¹	2.7×10 ²	7.0×10 ⁻¹	1.9×10 ¹	2.8×10 ⁴	7.6×10 ⁵
Dy-159	Dysprosium (66)	2.0×10 ¹	5.4×10 ²	2.0×10 ¹	5.4×10 ²	2.1×10 ²	5.7×10 ³
Dy-165		9.0×10 ⁻¹	2.4×10 ¹	6.0×10 ⁻¹	1.6×10 ¹	3.0×10 ⁵	8.2×10 ⁶
Dy-166 (a)		9.0×10 ⁻¹	2.4×10 ¹	3.0×10 ⁻¹	8.1	8.6×10 ³	2.3×10 ⁵
Er-169	Erbium (68)	4.0×10 ¹	1.1×10 ³	1.0	2.7×10 ¹	3.1×10 ³	8.3×10 ⁴
Er-171		8.0×10 ⁻¹	2.2×10 ¹	5.0×10 ⁻¹	1.4×10 ¹	9.0×10 ⁴	2.4×10 ⁶
Eu-147	Europium (63)	2.0	5.4×10 ¹	2.0	5.4×10 ¹	1.4×10 ³	3.7×10 ⁴
Eu-148		5.0×10 ⁻¹	1.4×10 ¹	5.0×10 ⁻¹	1.4×10 ¹	6.0×10 ²	1.6×10 ⁴
Eu-149		2.0×10 ¹	5.4×10 ²	2.0×10 ¹	5.4×10 ²	3.5×10 ²	9.4×10 ³
Eu-150 (short lived)		2.0	5.4×10 ¹	7.0×10 ⁻¹	1.9×10 ¹	6.1×10 ⁴	1.6×10 ⁶
Eu-150 (long lived)		7.0×10 ⁻¹	1.9×10 ¹	7.0×10 ⁻¹	1.9×10 ¹	6.1×10 ⁴	1.6×10 ⁶
Eu-152		1.0	2.7×10 ¹	1.0	2.7×10 ¹	6.5	1.8×10 ²
Eu-152m		8.0×10 ⁻¹	2.2×10 ¹	8.0×10 ⁻¹	2.2×10 ¹	8.2×10 ⁴	2.2×10 ⁶
Eu-154		9.0×10 ⁻¹	2.4×10 ¹	6.0×10 ⁻¹	1.6×10 ¹	9.8	2.6×10 ²
Eu-155		2.0×10 ¹	5.4×10 ²	3.0	8.1×10 ¹	1.8×10 ¹	4.9×10 ²
Eu-156		7.0×10 ⁻¹	1.9×10 ¹	7.0×10 ⁻¹	1.9×10 ¹	2.0×10 ³	5.5×10 ⁴
F-18	Fluorine (9)	1.0	2.7×10 ¹	6.0×10 ⁻¹	1.6×10 ¹	3.5×10 ⁶	9.5×10 ⁷
Fe-52 (a)	Iron (26)	3.0×10 ⁻¹	8.1	3.0×10 ⁻¹	8.1	2.7×10 ⁵	7.3×10 ⁶
Fe-55		4.0×10 ¹	1.1×10 ³	4.0×10 ¹	1.1×10 ³	8.8×10 ¹	2.4×10 ³
Fe-59		9.0×10 ⁻¹	2.4×10 ¹	9.0×10 ⁻¹	2.4×10 ¹	1.8×10 ³	5.0×10 ⁴
Fe-60 (a)		4.0×10 ¹	1.1×10 ³	2.0×10 ⁻¹	5.4	7.4×10 ⁻⁴	2.0×10 ⁻²
Ga-67	Gallium (31)	7.0	1.9×10 ²	3.0	8.1×10 ¹	2.2×10 ⁴	6.0×10 ⁵
Ga-68		5.0×10 ⁻¹	1.4×10 ¹	5.0×10 ⁻¹	1.4×10 ¹	1.5×10 ⁶	4.1×10 ⁷
Ga-72		4.0×10 ⁻¹	1.1×10 ¹	4.0×10 ⁻¹	1.1×10 ¹	1.1×10 ⁵	3.1×10 ⁶
Gd-146 (a)	Gadolinium (64)	5.0×10 ⁻¹	1.4×10 ¹	5.0×10 ⁻¹	1.4×10 ¹	6.9×10 ²	1.9×10 ⁴
Gd-148		2.0×10 ¹	5.4×10 ²	2.0×10 ⁻³	5.4×10 ⁻²	1.2	3.2×10 ¹
Gd-153		1.0×10 ¹	2.7×10 ²	9.0	2.4×10 ²	1.3×10 ²	3.5×10 ³
Gd-159		3.0	8.1×10 ¹	6.0×10 ⁻¹	1.6×10 ¹	3.9×10 ⁴	1.1×10 ⁶
Ge-68 (a)	Germanium (32)	5.0×10 ⁻¹	1.4×10 ¹	5.0×10 ⁻¹	1.4×10 ¹	2.6×10 ²	7.1×10 ³

Symbol of radionuclide	Element and atomic number	A ₁ (TBq)	A ₁ (Ci) ^b	A ₂ (TBq)	A ₂ (Ci) ^b	Specific activity	
						(TBq/g)	(Ci/g)
Ge-71		4.0×10 ¹	1.1×10 ³	4.0×10 ¹	1.1×10 ³	5.8×10 ³	1.6×10 ⁵
Ge-77		3.0×10 ⁻¹	8.1	3.0×10 ⁻¹	8.1	1.3×10 ⁵	3.6×10 ⁶
Hf-172 (a)	Hafnium (72)	6.0×10 ⁻¹	1.6×10 ¹	6.0×10 ⁻¹	1.6×10 ¹	4.1×10 ¹	1.1×10 ³
Hf-175		3.0	8.1×10 ¹	3.0	8.1×10 ¹	3.9×10 ²	1.1×10 ⁴
Hf-181		2.0	5.4×10 ¹	5.0×10 ⁻¹	1.4×10 ¹	6.3×10 ²	1.7×10 ⁴
Hf-182		Unlimited	Unlimited	Unlimited	Unlimited	8.1×10 ⁻⁶	2.2×10 ⁻⁴
Hg-194 (a)	Mercury (80)	1.0	2.7×10 ¹	1.0	2.7×10 ¹	1.3×10 ⁻¹	3.5
Hg-195m (a)		3.0	8.1×10 ¹	7.0×10 ⁻¹	1.9×10 ¹	1.5×10 ⁴	4.0×10 ⁵
Hg-197		2.0×10 ¹	5.4×10 ²	1.0×10 ¹	2.7×10 ²	9.2×10 ³	2.5×10 ⁵
Hg-197m		1.0×10 ¹	2.7×10 ²	4.0×10 ⁻¹	1.1×10 ¹	2.5×10 ⁴	6.7×10 ⁵
Hg-203		5.0	1.4×10 ²	1.0	2.7×10 ¹	5.1×10 ²	1.4×10 ⁴
Ho-166	Holmium (67)	4.0×10 ⁻¹	1.1×10 ¹	4.0×10 ⁻¹	1.1×10 ¹	2.6×10 ⁴	7.0×10 ⁵
Ho-166m		6.0×10 ⁻¹	1.6×10 ¹	5.0×10 ⁻¹	1.4×10 ¹	6.6×10 ⁻²	1.8
I-123	Iodine (53)	6.0	1.6×10 ²	3.0	8.1×10 ¹	7.1×10 ⁴	1.9×10 ⁶
I-124		1.0	2.7×10 ¹	1.0	2.7×10 ¹	9.3×10 ³	2.5×10 ⁵
I-125		2.0×10 ¹	5.4×10 ²	3.0	8.1×10 ¹	6.4×10 ²	1.7×10 ⁴
I-126		2.0	5.4×10 ¹	1.0	2.7×10 ¹	2.9×10 ³	8.0×10 ⁴
I-129		Unlimited	Unlimited	Unlimited	Unlimited	6.5×10 ⁻⁶	1.8×10 ⁻⁴
I-131		3.0	8.1×10 ¹	7.0×10 ⁻¹	1.9×10 ¹	4.6×10 ³	1.2×10 ⁵
I-132		4.0×10 ⁻¹	1.1×10 ¹	4.0×10 ⁻¹	1.1×10 ¹	3.8×10 ⁵	1.0×10 ⁷
I-133		7.0×10 ⁻¹	1.9×10 ¹	6.0×10 ⁻¹	1.6×10 ¹	4.2×10 ⁴	1.1×10 ⁶
I-134		3.0×10 ⁻¹	8.1	3.0×10 ⁻¹	8.1	9.9×10 ⁵	2.7×10 ⁷
I-135 (a)		6.0×10 ⁻¹	1.6×10 ¹	6.0×10 ⁻¹	1.6×10 ¹	1.3×10 ⁵	3.5×10 ⁶
In-111	Indium (49)	3.0	8.1×10 ¹	3.0	8.1×10 ¹	1.5×10 ⁴	4.2×10 ⁵
In-113m		4.0	1.1×10 ²	2.0	5.4×10 ¹	6.2×10 ⁵	1.7×10 ⁷
In-114m (a)		1.0×10 ¹	2.7×10 ²	5.0×10 ⁻¹	1.4×10 ¹	8.6×10 ²	2.3×10 ⁴
In-115m		7.0	1.9×10 ²	1.0	2.7×10 ¹	2.2×10 ⁵	6.1×10 ⁶
Ir-189 (a)	Iridium (77)	1.0×10 ¹	2.7×10 ²	1.0×10 ¹	2.7×10 ²	1.9×10 ³	5.2×10 ⁴
Ir-190		7.0×10 ⁻¹	1.9×10 ¹	7.0×10 ⁻¹	1.9×10 ¹	2.3×10 ³	6.2×10 ⁴
Ir-192 (c)		1.0	2.7×10 ¹	6.0×10 ⁻¹	1.6×10 ¹	3.4×10 ²	9.2×10 ³
Ir-194		3.0×10 ⁻¹	8.1	3.0×10 ⁻¹	8.1	3.1×10 ⁴	8.4×10 ⁵
K-40	Potassium (19)	9.0×10 ⁻¹	2.4×10 ¹	9.0×10 ⁻¹	2.4×10 ¹	2.4×10 ⁻⁷	6.4×10 ⁻⁶
K-42		2.0×10 ⁻¹	5.4	2.0×10 ⁻¹	5.4	2.2×10 ⁵	6.0×10 ⁶
K-43		7.0×10 ⁻¹	1.9×10 ¹	6.0×10 ⁻¹	1.6×10 ¹	1.2×10 ⁵	3.3×10 ⁶
Kr-79	Krypton (36)	4.0×10 ⁰	1.1×10 ²	2.0×10 ⁰	5.4×10 ¹	4.2×10 ⁴	1.1×10 ⁶
Kr-81	Krypton (36)	4.0×10 ¹	1.1×10 ³	4.0×10 ¹	1.1×10 ³	7.8×10 ⁻⁴	2.1×10 ⁻²
Kr-85		1.0×10 ¹	2.7×10 ²	1.0×10 ¹	2.7×10 ²	1.5×10 ¹	3.9×10 ²
Kr-85m		8.0	2.2×10 ²	3.0	8.1×10 ¹	3.0×10 ⁵	8.2×10 ⁶
Kr-87		2.0×10 ⁻¹	5.4	2.0×10 ⁻¹	5.4	1.0×10 ⁶	2.8×10 ⁷
La-137	Lanthanum (57)	3.0×10 ¹	8.1×10 ²	6.0	1.6×10 ²	1.6×10 ⁻³	4.4×10 ⁻²
La-140		4.0×10 ⁻¹	1.1×10 ¹	4.0×10 ⁻¹	1.1×10 ¹	2.1×10 ⁴	5.6×10 ⁵
Lu-172	Lutetium (71)	6.0×10 ⁻¹	1.6×10 ¹	6.0×10 ⁻¹	1.6×10 ¹	4.2×10 ³	1.1×10 ⁵
Lu-173		8.0	2.2×10 ²	8.0	2.2×10 ²	5.6×10 ¹	1.5×10 ³
Lu-174		9.0	2.4×10 ²	9.0	2.4×10 ²	2.3×10 ¹	6.2×10 ²
Lu-174m		2.0×10 ¹	5.4×10 ²	1.0×10 ¹	2.7×10 ²	2.0×10 ²	5.3×10 ³
Lu-177		3.0×10 ¹	8.1×10 ²	7.0×10 ⁻¹	1.9×10 ¹	4.1×10 ³	1.1×10 ⁵
Mg-28 (a)	Magnesium (12)	3.0×10 ⁻¹	8.1	3.0×10 ⁻¹	8.1	2.0×10 ⁵	5.4×10 ⁶
Mn-52	Manganese (25)	3.0×10 ⁻¹	8.1	3.0×10 ⁻¹	8.1	1.6×10 ⁴	4.4×10 ⁵
Mn-53		Unlimited	Unlimited	Unlimited	Unlimited	6.8×10 ⁻⁵	1.8×10 ⁻³
Mn-54		1.0	2.7×10 ¹	1.0	2.7×10 ¹	2.9×10 ²	7.7×10 ³
Mn-56		3.0×10 ⁻¹	8.1	3.0×10 ⁻¹	8.1	8.0×10 ⁵	2.2×10 ⁷
Mo-93	Molybdenum (42)	4.0×10 ¹	1.1×10 ³	2.0×10 ¹	5.4×10 ²	4.1×10 ⁻²	1.1
Mo-99(a)(i)		1.0	2.7×10 ¹	6.0×10 ⁻¹	1.6×10 ¹	1.6×10 ⁴	4.8×10 ⁵
N-13	Nitrogen (7)	9.0×10 ⁻¹	2.4×10 ¹	6.0×10 ⁻¹	1.6×10 ¹	5.4×10 ⁷	1.5×10 ⁹
Na-22	Sodium (11)	5.0×10 ⁻¹	1.4×10 ¹	5.0×10 ⁻¹	1.4×10 ¹	2.3×10 ²	6.3×10 ³
Na-24		2.0×10 ⁻¹	5.4	2.0×10 ⁻¹	5.4	3.2×10 ⁵	8.7×10 ⁶
Nb-93m	Niobium (41)	4.0×10 ¹	1.1×10 ³	3.0×10 ¹	8.1×10 ²	8.8	2.4×10 ²
Nb-94		7.0×10 ⁻¹	1.9×10 ¹	7.0×10 ⁻¹	1.9×10 ¹	6.9×10 ⁻³	1.9×10 ⁻¹
Nb-95		1.0	2.7×10 ¹	1.0	2.7×10 ¹	1.5×10 ³	3.9×10 ⁴
Nb-97		9.0×10 ⁻¹	2.4×10 ¹	6.0×10 ⁻¹	1.6×10 ¹	9.9×10 ⁵	2.7×10 ⁷
Nd-147	Neodymium (60)	6.0	1.6×10 ²	6.0×10 ⁻¹	1.6×10 ¹	3.0×10 ³	8.1×10 ⁴
Nd-149		6.0×10 ⁻¹	1.6×10 ¹	5.0×10 ⁻¹	1.4×10 ¹	4.5×10 ⁵	1.2×10 ⁷
Ni-59	Nickel (28)	Unlimited	Unlimited	Unlimited	Unlimited	3.0×10 ⁻³	8.0×10 ⁻²
Ni-63		4.0×10 ¹	1.1×10 ³	3.0×10 ¹	8.1×10 ²	2.1	5.7×10 ⁻¹
Ni-65		4.0×10 ⁻¹	1.1×10 ¹	4.0×10 ⁻¹	1.1×10 ¹	7.1×10 ⁵	1.9×10 ⁷
Np-235	Neptunium (93)	4.0×10 ¹	1.1×10 ³	4.0×10 ¹	1.1×10 ³	5.2×10 ¹	1.4×10 ³
Np-236 (short-lived)		2.0×10 ¹	5.4×10 ²	2.0	5.4×10 ¹	4.7×10 ⁻⁴	1.3×10 ⁻²
Np-236 (long-lived)		9.0×10 ⁰	2.4×10 ²	2.0×10 ⁻²	5.4×10 ⁻¹	4.7×10 ⁻⁴	1.3×10 ⁻²
Np-237		2.0×10 ¹	5.4×10 ²	2.0×10 ⁻³	5.4×10 ⁻²	2.6×10 ⁻⁵	7.1×10 ⁻⁴
Np-239		7.0	1.9×10 ²	4.0×10 ⁻¹	1.1×10 ¹	8.6×10 ³	2.3×10 ⁵
Os-185	Osmium (76)	1.0	2.7×10 ¹	1.0	2.7×10 ¹	2.8×10 ²	7.5×10 ³
Os-191		1.0×10 ¹	2.7×10 ²	2.0	5.4×10 ¹	1.6×10 ³	4.4×10 ⁴

Symbol of radionuclide	Element and atomic number	A ₁ (TBq)	A ₁ (Ci) ^b	A ₂ (TBq)	A ₂ (Ci) ^b	Specific activity	
						(TBq/g)	(Ci/g)
Os-191m		4.0×10 ¹	1.1×10 ³	3.0×10 ¹	8.1×10 ²	4.6×10 ⁴	1.3×10 ⁶
Os-193		2.0	5.4×10 ¹	6.0×10 ⁻¹	1.6×10 ¹	2.0×10 ⁴	5.3×10 ⁵
Os-194 (a)		3.0×10 ⁻¹	8.1	3.0×10 ⁻¹	8.1	1.1×10 ¹	3.1×10 ²
P-32	Phosphorus (15)	5.0×10 ⁻¹	1.4×10 ¹	5.0×10 ⁻¹	1.4×10 ¹	1.1×10 ⁴	2.9×10 ⁵
P-33		4.0×10 ¹	1.1×10 ³	1.0	2.7×10 ¹	5.8×10 ³	1.6×10 ⁵
Pa-230 (a)	Protactinium (91)	2.0	5.4×10 ¹	7.0×10 ⁻²	1.9	1.2×10 ³	3.3×10 ⁴
Pa-231		4.0	1.1×10 ²	4.0×10 ⁻⁴	1.1×10 ⁻²	1.7×10 ⁻³	4.7×10 ⁻²
Pa-233		5.0	1.4×10 ²	7.0×10 ⁻¹	1.9×10 ¹	7.7×10 ²	2.1×10 ⁴
Pb-201	Lead (82)	1.0	2.7×10 ¹	1.0	2.7×10 ¹	6.2×10 ⁴	1.7×10 ⁶
Pb-202		4.0×10 ¹	1.1×10 ³	2.0×10 ¹	5.4×10 ²	1.2×10 ⁻⁴	3.4×10 ⁻³
Pb-203		4.0	1.1×10 ²	3.0	8.1×10 ¹	1.1×10 ⁴	3.0×10 ⁵
Pb-205		Unlimited	Unlimited	Unlimited	Unlimited	4.5×10 ⁻⁶	1.2×10 ⁻⁴
Pb-210 (a)		1.0	2.7×10 ¹	5.0×10 ⁻²	1.4	2.8	7.6×10 ¹
Pb-212 (a)		7.0×10 ⁻¹	1.9×10 ¹	2.0×10 ⁻¹	5.4	5.1×10 ⁴	1.4×10 ⁶
Pd-103 (a)	Palladium (46)	4.0×10 ¹	1.1×10 ³	4.0×10 ¹	1.1×10 ³	2.8×10 ³	7.5×10 ⁴
Pd-107		Unlimited	Unlimited	Unlimited	Unlimited	1.9×10 ⁻⁵	5.1×10 ⁻⁴
Pd-109		2.0	5.4×10 ¹	5.0×10 ⁻¹	1.4×10 ¹	7.9×10 ⁴	2.1×10 ⁶
Pm-143	Promethium (61)	3.0	8.1×10 ¹	3.0	8.1×10 ¹	1.3×10 ²	3.4×10 ³
Pm-144		7.0×10 ⁻¹	1.9×10 ¹	7.0×10 ⁻¹	1.9×10 ¹	9.2×10 ¹	2.5×10 ³
Pm-145		3.0×10 ¹	8.1×10 ²	1.0×10 ¹	2.7×10 ²	5.2	1.4×10 ²
Pm-147		4.0×10 ¹	1.1×10 ³	2.0	5.4×10 ¹	3.4×10 ¹	9.3×10 ²
Pm-148m (a)		8.0×10 ⁻¹	2.2×10 ¹	7.0×10 ⁻¹	1.9×10 ¹	7.9×10 ²	2.1×10 ⁴
Pm-149		2.0	5.4×10 ¹	6.0×10 ⁻¹	1.6×10 ¹	1.5×10 ⁴	4.0×10 ⁵
Pm-151		2.0	5.4×10 ¹	6.0×10 ⁻¹	1.6×10 ¹	2.7×10 ⁴	7.3×10 ⁵
Po-210	Polonium (84)	4.0×10 ¹	1.1×10 ³	2.0×10 ⁻²	5.4×10 ⁻¹	1.7×10 ²	4.5×10 ³
Pr-142	Praseodymium (59)	4.0×10 ⁻¹	1.1×10 ¹	4.0×10 ⁻¹	1.1×10 ¹	4.3×10 ⁴	1.2×10 ⁶
Pr-143		3.0	8.1×10 ¹	6.0×10 ⁻¹	1.6×10 ¹	2.5×10 ³	6.7×10 ⁴
Pt-188 (a)	Platinum (78)	1.0	2.7×10 ¹	8.0×10 ⁻¹	2.2×10 ¹	2.5×10 ³	6.8×10 ⁴
Pt-191		4.0	1.1×10 ²	3.0	8.1×10 ¹	8.7×10 ³	2.4×10 ⁵
Pt-193		4.0×10 ¹	1.1×10 ³	4.0×10 ¹	1.1×10 ³	1.4	3.7×10 ¹
Pt-193m		4.0×10 ¹	1.1×10 ³	5.0×10 ⁻¹	1.4×10 ¹	5.8×10 ³	1.6×10 ⁵
Pt-195m		1.0×10 ¹	2.7×10 ²	5.0×10 ⁻¹	1.4×10 ¹	6.2×10 ³	1.7×10 ⁵
Pt-197		2.0×10 ¹	5.4×10 ²	6.0×10 ⁻¹	1.6×10 ¹	3.2×10 ⁴	8.7×10 ⁵
Pt-197m		1.0×10 ¹	2.7×10 ²	6.0×10 ⁻¹	1.6×10 ¹	3.7×10 ⁵	1.0×10 ⁷
Pu-236	Plutonium (94)	3.0×10 ¹	8.1×10 ²	3.0×10 ⁻³	8.1×10 ⁻²	2.0×10 ¹	5.3×10 ²
Pu-237		2.0×10 ¹	5.4×10 ²	2.0×10 ¹	5.4×10 ²	4.5×10 ²	1.2×10 ⁴
Pu-238		1.0×10 ¹	2.7×10 ²	1.0×10 ⁻³	2.7×10 ⁻²	6.3×10 ⁻¹	1.7×10 ¹
Pu-239		1.0×10 ¹	2.7×10 ²	1.0×10 ⁻³	2.7×10 ⁻²	2.3×10 ⁻³	6.2×10 ⁻²
Pu-240		1.0×10 ¹	2.7×10 ²	1.0×10 ⁻³	2.7×10 ⁻²	8.4×10 ⁻³	2.3×10 ⁻¹
Pu-241 (a)		4.0×10 ¹	1.1×10 ³	6.0×10 ⁻²	1.6	3.8	1.0×10 ²
Pu-242		1.0×10 ¹	2.7×10 ²	1.0×10 ⁻³	2.7×10 ⁻²	1.5×10 ⁻⁴	3.9×10 ⁻³
Pu-244 (a)		4.0×10 ⁻¹	1.1×10 ¹	1.0×10 ⁻³	2.7×10 ⁻²	6.7×10 ⁻⁷	1.8×10 ⁻⁵
Ra-223 (a)	Radium (88)	4.0×10 ⁻¹	1.1×10 ¹	7.0×10 ⁻³	1.9×10 ⁻¹	1.9×10 ³	5.1×10 ⁴
Ra-224 (a)		4.0×10 ⁻¹	1.1×10 ¹	2.0×10 ⁻²	5.4×10 ⁻¹	5.9×10 ³	1.6×10 ⁵
Ra-225 (a)		2.0×10 ⁻¹	5.4	4.0×10 ⁻³	1.1×10 ⁻¹	1.5×10 ³	3.9×10 ⁴
Ra-226 (a)		2.0×10 ⁻¹	5.4	3.0×10 ⁻³	8.1×10 ⁻²	3.7×10 ⁻²	1.0
Ra-228 (a)		6.0×10 ⁻¹	1.6×10 ¹	2.0×10 ⁻²	5.4×10 ⁻¹	1.0×10 ¹	2.7×10 ²
Rb-81	Rubidium (37)	2.0	5.4×10 ¹	8.0×10 ⁻¹	2.2×10 ¹	3.1×10 ⁵	8.4×10 ⁶
Rb-83 (a)		2.0	5.4×10 ¹	2.0	5.4×10 ¹	6.8×10 ²	1.8×10 ⁴
Rb-84		1.0	2.7×10 ¹	1.0	2.7×10 ¹	1.8×10 ³	4.7×10 ⁴
Rb-86		5.0×10 ⁻¹	1.4×10 ¹	5.0×10 ⁻¹	1.4×10 ¹	3.0×10 ³	8.1×10 ⁴
Rb-87		Unlimited	Unlimited	Unlimited	Unlimited	3.2×10 ⁻⁹	8.6×10 ⁻⁸
Rb(nat)		Unlimited	Unlimited	Unlimited	Unlimited	6.7×10 ⁶	1.8×10 ⁸
Re-184	Rhenium (75)	1.0	2.7×10 ¹	1.0	2.7×10 ¹	6.9×10 ²	1.9×10 ⁴
Re-184m		3.0	8.1×10 ¹	1.0	2.7×10 ¹	1.6×10 ²	4.3×10 ³
Re-186		2.0	5.4×10 ¹	6.0×10 ⁻¹	1.6×10 ¹	6.9×10 ³	1.9×10 ⁵
Re-187		Unlimited	Unlimited	Unlimited	Unlimited	1.4×10 ⁻⁹	3.8×10 ⁻⁸
Re-188		4.0×10 ⁻¹	1.1×10 ¹	4.0×10 ⁻¹	1.1×10 ¹	3.6×10 ⁴	9.8×10 ⁵
Re-189 (a)		3.0	8.1×10 ¹	6.0×10 ⁻¹	1.6×10 ¹	2.5×10 ⁴	6.8×10 ⁵
Re(nat)		Unlimited	Unlimited	Unlimited	Unlimited	0.0	2.4×10 ⁻⁸
Rh-99	Rhodium (45)	2.0	5.4×10 ¹	2.0	5.4×10 ¹	3.0×10 ³	8.2×10 ⁴
Rh-101		4.0	1.1×10 ²	3.0	8.1×10 ¹	4.1×10 ¹	1.1×10 ³
Rh-102		5.0×10 ⁻¹	1.4×10 ¹	5.0×10 ⁻¹	1.4×10 ¹	4.5×10 ¹	1.2×10 ³
Rh-102m		2.0	5.4×10 ¹	2.0	5.4×10 ¹	2.3×10 ²	6.2×10 ³
Rh-103m		4.0×10 ¹	1.1×10 ³	4.0×10 ¹	1.1×10 ³	1.2×10 ⁶	3.3×10 ⁷
Rh-105		1.0×10 ¹	2.7×10 ²	8.0×10 ⁻¹	2.2×10 ¹	3.1×10 ⁴	8.4×10 ⁵
Rn-222 (a)	Radon (86)	3.0×10 ⁻¹	8.1	4.0×10 ⁻³	1.1×10 ⁻¹	5.7×10 ³	1.5×10 ⁵
Ru-97	Ruthenium (44)	5.0	1.4×10 ²	5.0	1.4×10 ²	1.7×10 ⁴	4.6×10 ⁵
Ru-103 (a)		2.0	5.4×10 ¹	2.0	5.4×10 ¹	1.2×10 ³	3.2×10 ⁴
Ru-105		1.0	2.7×10 ¹	6.0×10 ⁻¹	1.6×10 ¹	2.5×10 ⁵	6.7×10 ⁶
Ru-106 (a)		2.0×10 ⁻¹	5.4	2.0×10 ⁻¹	5.4	1.2×10 ²	3.3×10 ³
S-35	Sulphur (16)	4.0×10 ¹	1.1×10 ³	3.0	8.1×10 ¹	1.6×10 ³	4.3×10 ⁴

Symbol of radionuclide	Element and atomic number	A ₁ (TBq)	A ₁ (Ci) ^b	A ₂ (TBq)	A ₂ (Ci) ^b	Specific activity	
						(TBq/g)	(Ci/g)
Sb-122	Antimony (51)	4.0×10 ⁻¹	1.1×10 ¹	4.0×10 ⁻¹	1.1×10 ¹	1.5×10 ⁴	4.0×10 ⁵
Sb-124	6.0×10 ⁻¹	1.6×10 ¹	6.0×10 ⁻¹	1.6×10 ¹	6.5×10 ²	1.7×10 ⁴
Sb-125	2.0	5.4×10 ¹	1.0	2.7×10 ¹	3.9×10 ¹	1.0×10 ³
Sb-126	4.0×10 ⁻¹	1.1×10 ¹	4.0×10 ⁻¹	1.1×10 ¹	3.1×10 ³	8.4×10 ⁴
Sc-44	Scandium (21)	5.0×10 ⁻¹	1.4×10 ¹	5.0×10 ⁻¹	1.4×10 ¹	6.7×10 ⁵	1.8×10 ⁷
Sc-46	5.0×10 ⁻¹	1.4×10 ¹	5.0×10 ⁻¹	1.4×10 ¹	1.3×10 ³	3.4×10 ⁴
Sc-47	1.0×10 ¹	2.7×10 ²	7.0×10 ⁻¹	1.9×10 ¹	3.1×10 ⁴	8.3×10 ⁵
Sc-48	3.0×10 ⁻¹	8.1	3.0×10 ⁻¹	8.1	5.5×10 ⁴	1.5×10 ⁶
Se-75	Selenium (34)	3.0	8.1×10 ¹	3.0	8.1×10 ¹	5.4×10 ²	1.5×10 ⁴
Se-79	4.0×10 ¹	1.1×10 ³	2.0	5.4×10 ¹	2.6×10 ⁻³	7.0×10 ⁻²
Si-31	Silicon (14)	6.0×10 ⁻¹	1.6×10 ¹	6.0×10 ⁻¹	1.6×10 ¹	1.4×10 ⁶	3.9×10 ⁷
Si-32	4.0×10 ¹	1.1×10 ³	5.0×10 ⁻¹	1.4×10 ¹	3.9	1.1×10 ²
Sm-145	Samarium (62)	1.0×10 ¹	2.7×10 ²	1.0×10 ¹	2.7×10 ²	9.8×10 ¹	2.6×10 ³
Sm-147	Unlimited	Unlimited	Unlimited	Unlimited	8.5 × 10 ⁻¹⁰	2.3 × 10 ⁻⁸
Sm-151	4.0×10 ¹	1.1×10 ³	1.0×10 ¹	2.7×10 ²	9.7×10 ⁻¹	2.6×10 ¹
Sm-153	9.0	2.4×10 ²	6.0×10 ⁻¹	1.6×10 ¹	1.6×10 ⁴	4.4×10 ⁵
Sn-113 (a)	Tin (50)	4.0	1.1×10 ²	2.0	5.4×10 ¹	3.7×10 ²	1.0×10 ⁴
Sn-117m	7.0	1.9×10 ²	4.0×10 ⁻¹	1.1×10 ¹	3.0×10 ³	8.2×10 ⁴
Sn-119m	4.0×10 ¹	1.1×10 ³	3.0×10 ¹	8.1×10 ²	1.4×10 ²	3.7×10 ³
Sn-121m (a)	4.0×10 ¹	1.1×10 ³	9.0×10 ⁻¹	2.4×10 ¹	2.0	5.4×10 ¹
Sn-123	8.0×10 ⁻¹	2.2×10 ¹	6.0×10 ⁻¹	1.6×10 ¹	3.0×10 ²	8.2×10 ³
Sn-125	4.0×10 ⁻¹	1.1×10 ¹	4.0×10 ⁻¹	1.1×10 ¹	4.0×10 ³	1.1×10 ⁵
Sn-126 (a)	6.0×10 ⁻¹	1.6×10 ¹	4.0×10 ⁻¹	1.1×10 ¹	1.0×10 ⁻³	2.8×10 ⁻²
Sr-82 (a)	Strontium (38)	2.0×10 ⁻¹	5.4	2.0×10 ⁻¹	5.4	2.3×10 ³	6.2×10 ⁴
Sr-85	2.0	5.4×10 ¹	2.0	5.4×10 ¹	8.8×10 ²	2.4×10 ⁴
Sr-85m	5.0	1.4×10 ²	5.0	1.4×10 ²	1.2×10 ⁶	3.3×10 ⁷
Sr-87m	3.0	8.1×10 ¹	3.0	8.1×10 ¹	4.8×10 ⁵	1.3×10 ⁷
Sr-89	6.0×10 ⁻¹	1.6×10 ¹	6.0×10 ⁻¹	1.6×10 ¹	1.1×10 ³	2.9×10 ⁴
Sr-90 (a)	3.0×10 ⁻¹	8.1	3.0×10 ⁻¹	8.1	5.1	1.4×10 ²
Sr-91 (a)	3.0×10 ⁻¹	8.1	3.0×10 ⁻¹	8.1	1.3×10 ⁵	3.6×10 ⁶
Sr-92 (a)	1.0	2.7×10 ¹	3.0×10 ⁻¹	8.1	4.7×10 ⁵	1.3×10 ⁷
T(H-3)	Tritium (1)	4.0×10 ¹	1.1×10 ³	4.0×10 ¹	1.1×10 ³	3.6×10 ²	9.7×10 ³
Ta-178 (long-lived)	Tantalum (73)	1.0	2.7×10 ¹	8.0×10 ⁻¹	2.2×10 ¹	4.2×10 ⁶	1.1×10 ⁸
Ta-179	3.0×10 ¹	8.1×10 ²	3.0×10 ¹	8.1×10 ²	4.1×10 ¹	1.1×10 ³
Ta-182	9.0×10 ⁻¹	2.4×10 ¹	5.0×10 ⁻¹	1.4×10 ¹	2.3×10 ²	6.2×10 ³
Tb-157	Terbium (65)	4.0×10 ¹	1.1×10 ³	4.0×10 ¹	1.1×10 ³	5.6×10 ⁻¹	1.5×10 ¹
Tb-158	1.0	2.7×10 ¹	1.0	2.7×10 ¹	5.6×10 ⁻¹	1.5×10 ¹
Tb-160	1.0	2.7×10 ¹	6.0×10 ⁻¹	1.6×10 ¹	4.2×10 ²	1.1×10 ⁴
Tc-95m (a)	Technetium (43)	2.0	5.4×10 ¹	2.0	5.4×10 ¹	8.3×10 ²	2.2×10 ⁴
Tc-96	4.0×10 ⁻¹	1.1×10 ¹	4.0×10 ⁻¹	1.1×10 ¹	1.2×10 ⁴	3.2×10 ⁵
Tc-96m (a)	4.0×10 ⁻¹	1.1×10 ¹	4.0×10 ⁻¹	1.1×10 ¹	1.4×10 ⁶	3.8×10 ⁷
Tc-97	Unlimited	Unlimited	Unlimited	Unlimited	5.2×10 ⁻⁵	1.4×10 ⁻³
Tc-97m	4.0×10 ¹	1.1×10 ³	1.0	2.7×10 ¹	5.6×10 ²	1.5×10 ⁴
Tc-98	8.0×10 ⁻¹	2.2×10 ¹	7.0×10 ⁻¹	1.9×10 ¹	3.2×10 ⁻⁵	8.7×10 ⁻⁴
Tc-99	4.0×10 ¹	1.1×10 ³	9.0×10 ⁻¹	2.4×10 ¹	6.3×10 ⁻⁴	1.7×10 ⁻²
Tc-99m	1.0×10 ¹	2.7×10 ²	4.0	1.1×10 ²	1.9×10 ⁵	5.3×10 ⁶
Te-121	Tellurium (52)	2.0	5.4×10 ¹	2.0	5.4×10 ¹	2.4×10 ³	6.4×10 ⁴
Te-121m	5.0	1.4×10 ²	3.0	8.1×10 ¹	2.6×10 ²	7.0×10 ³
Te-123m	8.0	2.2×10 ²	1.0	2.7×10 ¹	3.3×10 ²	8.9×10 ³
Te-125m	2.0×10 ¹	5.4×10 ²	9.0×10 ⁻¹	2.4×10 ¹	6.7×10 ²	1.8×10 ⁴
Te-127	2.0×10 ¹	5.4×10 ²	7.0×10 ⁻¹	1.9×10 ¹	9.8×10 ⁴	2.6×10 ⁶
Te-127m (a)	2.0×10 ¹	5.4×10 ²	5.0×10 ⁻¹	1.4×10 ¹	3.5×10 ²	9.4×10 ³
Te-129	7.0×10 ⁻¹	1.9×10 ¹	6.0×10 ⁻¹	1.6×10 ¹	7.7×10 ⁵	2.1×10 ⁷
Te-129m (a)	8.0×10 ⁻¹	2.2×10 ¹	4.0×10 ⁻¹	1.1×10 ¹	1.1×10 ³	3.0×10 ⁴
Te-131m (a)	7.0×10 ⁻¹	1.9×10 ¹	5.0×10 ⁻¹	1.4×10 ¹	3.0×10 ⁴	8.0×10 ⁵
Te-132 (a)	5.0×10 ⁻¹	1.4×10 ¹	4.0×10 ⁻¹	1.1×10 ¹	1.1×10 ⁴	3.0×10 ⁵
Th-227	Thorium (90)	1.0×10 ¹	2.7×10 ²	5.0×10 ⁻³	1.4×10 ⁻¹	1.1×10 ³	3.1×10 ⁴
Th-228 (a)	5.0×10 ⁻¹	1.4×10 ¹	1.0×10 ⁻³	2.7×10 ⁻²	3.0×10 ¹	8.2×10 ²
Th-229	5.0	1.4×10 ²	5.0×10 ⁻⁴	1.4×10 ⁻²	7.9×10 ⁻³	2.1×10 ⁻¹
Th-230	1.0×10 ¹	2.7×10 ²	1.0×10 ⁻³	2.7×10 ⁻²	7.6×10 ⁻⁴	2.1×10 ⁻²
Th-231	4.0×10 ¹	1.1×10 ³	2.0×10 ⁻²	5.4×10 ⁻¹	2.0×10 ⁴	5.3×10 ⁵
Th-232	Unlimited	Unlimited	Unlimited	Unlimited	4.0×10 ⁻⁹	1.1×10 ⁻⁷
Th-234 (a)	3.0×10 ⁻¹	8.1	3.0×10 ⁻¹	8.1	8.6×10 ²	2.3×10 ⁴
Th(nat)	Unlimited	Unlimited	Unlimited	Unlimited	8.1×10 ⁻⁹	2.2×10 ⁻⁷
Ti-44 (a)	Titanium (22)	5.0×10 ⁻¹	1.4×10 ¹	4.0×10 ⁻¹	1.1×10 ¹	6.4	1.7×10 ²
Tl-200	Thallium (81)	9.0×10 ⁻¹	2.4×10 ¹	9.0×10 ⁻¹	2.4×10 ¹	2.2×10 ⁴	6.0×10 ⁵
Tl-201	1.0×10 ¹	2.7×10 ²	4.0	1.1×10 ²	7.9×10 ³	2.1×10 ⁵
Tl-202	2.0	5.4×10 ¹	2.0	5.4×10 ¹	2.0×10 ³	5.3×10 ⁴
Tl-204	1.0×10 ¹	2.7×10 ²	7.0×10 ⁻¹	1.9×10 ¹	1.7×10 ¹	4.6×10 ²
Tm-167	Thulium (69)	7.0	1.9×10 ²	8.0×10 ⁻¹	2.2×10 ¹	3.1×10 ³	8.5×10 ⁴
Tm-170	3.0	8.1×10 ¹	6.0×10 ⁻¹	1.6×10 ¹	2.2×10 ²	6.0×10 ³
Tm-171	4.0×10 ¹	1.1×10 ³	4.0×10 ¹	1.1×10 ³	4.0×10 ¹	1.1×10 ³

Symbol of radionuclide	Element and atomic number	A ₁ (TBq)	A ₁ (Ci) ^b	A ₂ (TBq)	A ₂ (Ci) ^b	Specific activity	
						(TBq/g)	(Ci/g)
U-230 (fast lung absorption) (a)(d).	Uranium (92)	4.0×10 ¹	1.1×10 ³	1.0×10 ⁻¹	2.7	1.0×10 ³	2.7×10 ⁴
U-230 (medium lung absorption) (a)(e).		4.0×10 ¹	1.1×10 ³	4.0×10 ⁻³	1.1×10 ⁻¹	1.0×10 ³	2.7×10 ⁴
U-230 (slow lung absorption) (a)(f).		3.0×10 ¹	8.1×10 ²	3.0×10 ⁻³	8.1×10 ⁻²	1.0×10 ³	2.7×10 ⁴
U-232 (fast lung absorption) (d).		4.0×10 ¹	1.1×10 ³	1.0×10 ⁻²	2.7×10 ⁻¹	8.3×10 ⁻¹	2.2×10 ¹
U-232 (medium lung absorption) (e).		4.0×10 ¹	1.1×10 ³	7.0×10 ⁻³	1.9×10 ⁻¹	8.3×10 ⁻¹	2.2×10 ¹
U-232 (slow lung absorption) (f).		1.0×10 ¹	2.7×10 ²	1.0×10 ⁻³	2.7×10 ⁻²	8.3×10 ⁻¹	2.2×10 ¹
U-233 (fast lung absorption) (d).		4.0×10 ¹	1.1×10 ³	9.0×10 ⁻²	2.4	3.6×10 ⁻⁴	9.7×10 ⁻³
U-233 (medium lung absorption) (e).		4.0×10 ¹	1.1×10 ³	2.0×10 ⁻²	5.4×10 ⁻¹	3.6×10 ⁻⁴	9.7×10 ⁻³
U-233 (slow lung absorption) (f).		4.0×10 ¹	1.1×10 ³	6.0×10 ⁻³	1.6×10 ⁻¹	3.6×10 ⁻⁴	9.7×10 ⁻³
U-234 (fast lung absorption) (d).		4.0×10 ¹	1.1×10 ³	9.0×10 ⁻²	2.4	2.3×10 ⁻⁴	6.2×10 ⁻³
U-234 (medium lung absorption) (e).		4.0×10 ¹	1.1×10 ³	2.0×10 ⁻²	5.4×10 ⁻¹	2.3×10 ⁻⁴	6.2×10 ⁻³
U-234 (slow lung absorption) (f).		4.0×10 ¹	1.1×10 ³	6.0×10 ⁻³	1.6×10 ⁻¹	2.3×10 ⁻⁴	6.2×10 ⁻³
U-235 (all lung absorption types) (a),(d),(e),(f).		Unlimited	Unlimited	Unlimited	Unlimited	8.0×10 ⁻⁸	2.2×10 ⁻⁶
U-236 (fast lung absorption) (d).		Unlimited	Unlimited	Unlimited	Unlimited	2.4×10 ⁻⁶	6.5×10 ⁻⁵
U-236 (medium lung absorption) (e).		4.0×10 ¹	1.1×10 ³	2.0×10 ⁻²	5.4×10 ⁻¹	2.4×10 ⁻⁶	6.5×10 ⁻⁵
U-236 (slow lung absorption) (f).		4.0×10 ¹	1.1×10 ³	6.0×10 ⁻³	1.6×10 ⁻¹	2.4×10 ⁻⁶	6.5×10 ⁻⁵
U-238 (all lung absorption types) (d),(e),(f).		Unlimited	Unlimited	Unlimited	Unlimited	1.2×10 ⁻⁸	3.4×10 ⁻⁷
U (nat)		Unlimited	Unlimited	Unlimited	Unlimited	2.6×10 ⁻⁸	7.1×10 ⁻⁷
U (enriched to 20% or less)(g).		Unlimited	Unlimited	Unlimited	Unlimited	see § 173.434	see § 173.434
U (dep)		Unlimited	Unlimited	Unlimited	Unlimited	see § 173.434	see § 173.434
V-48	Vanadium (23)	4.0×10 ⁻¹	1.1×10 ¹	4.0×10 ⁻¹	1.1×10 ¹	6.3×10 ³	1.7×10 ⁵
V-49		4.0×10 ¹	1.1×10 ³	4.0×10 ¹	1.1×10 ³	3.0×10 ²	8.1×10 ³
W-178 (a)	Tungsten (74)	9.0	2.4×10 ²	5.0	1.4×10 ²	1.3×10 ³	3.4×10 ⁴
W-181		3.0×10 ¹	8.1×10 ²	3.0×10 ¹	8.1×10 ²	2.2×10 ²	6.0×10 ³
W-185		4.0×10 ¹	1.1×10 ³	8.0×10 ⁻¹	2.2×10 ¹	3.5×10 ²	9.4×10 ³
W-187		2.0	5.4×10 ¹	6.0×10 ⁻¹	1.6×10 ¹	2.6×10 ⁴	7.0×10 ⁵
W-188 (a)		4.0×10 ⁻¹	1.1×10 ¹	3.0×10 ⁻¹	8.1	3.7×10 ²	1.0×10 ⁴
Xe-122 (a)	Xenon (54)	4.0×10 ⁻¹	1.1×10 ¹	4.0×10 ⁻¹	1.1×10 ¹	4.8×10 ⁴	1.3×10 ⁶
Xe-123		2.0	5.4×10 ¹	7.0×10 ⁻¹	1.9×10 ¹	4.4×10 ⁵	1.2×10 ⁷
Xe-127		4.0	1.1×10 ²	2.0	5.4×10 ¹	1.0×10 ³	2.8×10 ⁴
Xe-131m		4.0×10 ¹	1.1×10 ³	4.0×10 ¹	1.1×10 ³	3.1×10 ³	8.4×10 ⁴
Xe-133		2.0×10 ¹	5.4×10 ²	1.0×10 ¹	2.7×10 ²	6.9×10 ³	1.9×10 ⁵
Xe-135		3.0	8.1×10 ¹	2.0	5.4×10 ¹	9.5×10 ⁴	2.6×10 ⁶
Y-87 (a)	Yttrium (39)	1.0	2.7×10 ¹	1.0	2.7×10 ¹	1.7×10 ⁴	4.5×10 ⁵
Y-88		4.0×10 ⁻¹	1.1×10 ¹	4.0×10 ⁻¹	1.1×10 ¹	5.2×10 ²	1.4×10 ⁴
Y-90		3.0×10 ⁻¹	8.1	3.0×10 ⁻¹	8.1	2.0×10 ⁴	5.4×10 ⁵
Y-91		6.0×10 ⁻¹	1.6×10 ¹	6.0×10 ⁻¹	1.6×10 ¹	9.1×10 ²	2.5×10 ⁴
Y-91m		2.0	5.4×10 ¹	2.0	5.4×10 ¹	1.5×10 ⁶	4.2×10 ⁷
Y-92		2.0×10 ⁻¹	5.4	2.0×10 ⁻¹	5.4	3.6×10 ⁵	9.6×10 ⁶
Y-93		3.0×10 ⁻¹	8.1	3.0×10 ⁻¹	8.1	1.2×10 ⁵	3.3×10 ⁶
Yb-169	Ytterbium (70)	4.0	1.1×10 ²	1.0	2.7×10 ¹	8.9×10 ²	2.4×10 ⁴
Yb-175		3.0×10 ¹	8.1×10 ²	9.0×10 ⁻¹	2.4×10 ¹	6.6×10 ³	1.8×10 ⁵
Zn-65	Zinc (30)	2.0	5.4×10 ¹	2.0	5.4×10 ¹	3.0×10 ²	8.2×10 ³
Zn-69		3.0	8.1×10 ¹	6.0×10 ⁻¹	1.6×10 ¹	1.8×10 ⁶	4.9×10 ⁷
Zn-69m (a)		3.0	8.1×10 ¹	6.0×10 ⁻¹	1.6×10 ¹	1.2×10 ⁵	3.3×10 ⁶
Zr-88	Zirconium (40)	3.0	8.1×10 ¹	3.0	8.1×10 ¹	6.6×10 ²	1.8×10 ⁴
Zr-93		Unlimited	Unlimited	Unlimited	Unlimited	9.3×10 ⁻⁵	2.5×10 ⁻³
Zr-95 (a)		2.0	5.4×10 ¹	8.0×10 ⁻¹	2.2×10 ¹	7.9×10 ²	2.1×10 ⁴
Zr-97 (a)		4.0×10 ⁻¹	1.1×10 ¹	4.0×10 ⁻¹	1.1×10 ¹	7.1×10 ⁴	1.9×10 ⁶

^a A₁ and/or A₂ values for these parent radionuclides include contributions from daughter nuclides with half-lives less than 10 days as listed in footnote (a) to Table 2 in the "IAEA Regulations for the Safe Transport of Radioactive Material, No. TS-R-1" (IBR, see § 171.7 of this subchapter).

§ 173.436

49 CFR Ch. I (10–1–14 Edition)

- ^bThe values of A_1 and A_2 in curies (Ci) are approximate and for information only; the regulatory standard units are Terabecquerels (TBq), (see § 171.10).
- ^cThe activity of Ir-192 in special form may be determined from a measurement of the rate of decay or a measurement of the radiation level at a prescribed distance from the source.
- ^dThese values apply only to compounds of uranium that take the chemical form of UF_6 , UO_2F_2 and $UO_2(NO_3)_2$ in both normal and accident conditions of transport.
- ^eThese values apply only to compounds of uranium that take the chemical form of UO_3 , UF_4 , UCl_4 and hexavalent compounds in both normal and accident conditions of transport.
- ^fThese values apply to all compounds of uranium other than those specified in notes (d) and (e) of this table.
- ^gThese values apply to unirradiated uranium only.
- ^h[Reserved]
- ⁱ $A_2 = 0.74$ TBq (20 Ci) for Mo-99 for domestic use.

[69 FR 3678, Jan. 26, 2004; 69 FR 55119, Sept. 13, 2004, as amended at 71 FR 54395, Sept. 14, 2006; 77 FR 60942, Oct. 5, 2012; 79 FR 40615, July 11, 2014]

§ 173.436 Exempt material activity concentrations and exempt consignment activity limits for radionuclides.

The Table of Exempt material activity concentrations and exempt consignment activity limits for radionuclides is as follows:

Symbol of radionuclide	Element and atomic number	Activity concentration for exempt material (Bq/g)	Activity concentration for exempt material (Ci/g)	Activity limit for exempt consignment (Bq)	Activity limit for exempt consignment (Ci)
Ac-225	Actinium (89)	1.0×10^1	2.7×10^{-10}	1.0×10^4	2.7×10^{-7}
Ac-227		1.0×10^{-1}	2.7×10^{-12}	1.0×10^3	2.7×10^{-8}
Ac-228		1.0×10^1	2.7×10^{-10}	1.0×10^6	2.7×10^{-5}
Ag-105	Silver (47)	1.0×10^2	2.7×10^{-9}	1.0×10^6	2.7×10^{-5}
Ag-108m (b)		1.0×10^1	2.7×10^{-10}	1.0×10^6	2.7×10^{-5}
Ag-110m		1.0×10^1	2.7×10^{-10}	1.0×10^6	2.7×10^{-5}
Ag-111		1.0×10^3	2.7×10^{-8}	1.0×10^6	2.7×10^{-5}
Al-26	Aluminum (13)	1.0×10^1	2.7×10^{-10}	1.0×10^5	2.7×10^{-6}
Am-241	Americium (95)	1.0	2.7×10^{-11}	1.0×10^4	2.7×10^{-7}
Am-242m (b)		1.0	2.7×10^{-11}	1.0×10^4	2.7×10^{-7}
Am-243 (b)		1.0	2.7×10^{-11}	1.0×10^3	2.7×10^{-8}
Ar-37	Argon (18)	1.0×10^6	2.7×10^{-5}	1.0×10^8	2.7×10^{-3}
Ar-39		1.0×10^7	2.7×10^{-4}	1.0×10^4	2.7×10^{-7}
Ar-41		1.0×10^2	2.7×10^{-9}	1.0×10^9	2.7×10^{-2}
As-72	Arsenic (33)	1.0×10^1	2.7×10^{-10}	1.0×10^5	2.7×10^{-6}
As-73		1.0×10^3	2.7×10^{-8}	1.0×10^7	2.7×10^{-4}
As-74		1.0×10^1	2.7×10^{-10}	1.0×10^6	2.7×10^{-5}
As-76		1.0×10^2	2.7×10^{-9}	1.0×10^5	2.7×10^{-6}
As-77		1.0×10^3	2.7×10^{-8}	1.0×10^6	2.7×10^{-5}
At-211	Astatine (85)	1.0×10^3	2.7×10^{-8}	1.0×10^7	2.7×10^{-4}
Au-193	Gold (79)	1.0×10^2	2.7×10^{-9}	1.0×10^7	2.7×10^{-4}
Au-194		1.0×10^1	2.7×10^{-10}	1.0×10^6	2.7×10^{-5}
Au-195		1.0×10^2	2.7×10^{-9}	1.0×10^7	2.7×10^{-4}
Au-198		1.0×10^2	2.7×10^{-9}	1.0×10^6	2.7×10^{-5}
Au-199		1.0×10^2	2.7×10^{-9}	1.0×10^6	2.7×10^{-5}
Ba-131	Barium (56)	1.0×10^2	2.7×10^{-9}	1.0×10^6	2.7×10^{-5}
Ba-133		1.0×10^2	2.7×10^{-9}	1.0×10^6	2.7×10^{-5}
Ba-133m		1.0×10^2	2.7×10^{-9}	1.0×10^6	2.7×10^{-5}
Ba-140 (b)		1.0×10^1	2.7×10^{-10}	1.0×10^5	2.7×10^{-6}
Be-7	Beryllium (4)	1.0×10^3	2.7×10^{-8}	1.0×10^7	2.7×10^{-4}
Be-10		1.0×10^4	2.7×10^{-7}	1.0×10^6	2.7×10^{-5}
Bi-205	Bismuth (83)	1.0×10^1	2.7×10^{-10}	1.0×10^6	2.7×10^{-5}
Bi-206		1.0×10^1	2.7×10^{-10}	1.0×10^5	2.7×10^{-6}
Bi-207		1.0×10^1	2.7×10^{-10}	1.0×10^6	2.7×10^{-5}
Bi-210		1.0×10^3	2.7×10^{-8}	1.0×10^6	2.7×10^{-5}
Bi-210m		1.0×10^1	2.7×10^{-10}	1.0×10^5	2.7×10^{-6}
Bi-212 (b)		1.0×10^1	2.7×10^{-10}	1.0×10^5	2.7×10^{-6}
Bk-247	Berkelium (97)	1.0	2.7×10^{-11}	1.0×10^4	2.7×10^{-7}
Bk-249		1.0×10^3	2.7×10^{-8}	1.0×10^6	2.7×10^{-5}
Br-76	Bromine (35)	1.0×10^1	2.7×10^{-10}	1.0×10^5	2.7×10^{-6}
Br-77		1.0×10^2	2.7×10^{-9}	1.0×10^6	2.7×10^{-5}
Br-82		1.0×10^1	2.7×10^{-10}	1.0×10^6	2.7×10^{-5}
C-11	Carbon (6)	1.0×10^1	2.7×10^{-10}	1.0×10^6	2.7×10^{-5}
C-14		1.0×10^4	2.7×10^{-7}	1.0×10^7	2.7×10^{-4}
Ca-41	Calcium (20)	1.0×10^5	2.7×10^{-6}	1.0×10^7	2.7×10^{-4}
Ca-45		1.0×10^4	2.7×10^{-7}	1.0×10^7	2.7×10^{-4}
Ca-47		1.0×10^1	2.7×10^{-10}	1.0×10^6	2.7×10^{-5}
Cd-109	Cadmium (48)	1.0×10^4	2.7×10^{-7}	1.0×10^6	2.7×10^{-5}
Cd-113m		1.0×10^3	2.7×10^{-8}	1.0×10^6	2.7×10^{-5}
Cd-115		1.0×10^2	2.7×10^{-9}	1.0×10^6	2.7×10^{-5}

Symbol of radionuclide	Element and atomic number	Activity concentration for exempt material (Bq/g)	Activity concentration for exempt material (Ci/g)	Activity limit for exempt consignment (Bq)	Activity limit for exempt consignment (Ci)	
Cd-115m		1.0x10 ³	2.7x10 ⁻⁸	1.0x10 ⁶	2.7x10 ⁻⁵	
Ce-139	Cerium (58)	1.0x10 ²	2.7x10 ⁻⁹	1.0x10 ⁶	2.7x10 ⁻⁵	
Ce-141		1.0x10 ²	2.7x10 ⁻⁹	1.0x10 ⁷	2.7x10 ⁻⁴	
Ce-143		1.0x10 ²	2.7x10 ⁻⁹	1.0x10 ⁶	2.7x10 ⁻⁵	
Ce-144 (b)		1.0x10 ²	2.7x10 ⁻⁹	1.0x10 ⁵	2.7x10 ⁻⁶	
Cf-248	Californium (98)	1.0x10 ¹	2.7x10 ⁻¹⁰	1.0x10 ⁴	2.7x10 ⁻⁷	
Cf-249		1.0	2.7x10 ⁻¹¹	1.0x10 ³	2.7x10 ⁻⁸	
Cf-250		1.0x10 ¹	2.7x10 ⁻¹⁰	1.0x10 ⁴	2.7x10 ⁻⁷	
Cf-251		1.0	2.7x10 ⁻¹¹	1.0x10 ³	2.7x10 ⁻⁸	
Cf-252		1.0x10 ¹	2.7x10 ⁻¹⁰	1.0x10 ⁴	2.7x10 ⁻⁷	
Cf-253		1.0x10 ²	2.7x10 ⁻⁹	1.0x10 ⁵	2.7x10 ⁻⁶	
Cf-254		1.0	2.7x10 ⁻¹¹	1.0x10 ³	2.7x10 ⁻⁸	
Cl-36		Chlorine (17)	1.0x10 ⁴	2.7x10 ⁻⁷	1.0x10 ⁶	2.7x10 ⁻⁵
Cl-38			1.0x10 ¹	2.7x10 ⁻¹⁰	1.0x10 ⁵	2.7x10 ⁻⁶
Cm-240		Curium (96)	1.0x10 ²	2.7x10 ⁻⁹	1.0x10 ⁵	2.7x10 ⁻⁶
Cm-241	1.0x10 ²		2.7x10 ⁻⁹	1.0x10 ⁶	2.7x10 ⁻⁵	
Cm-242	1.0x10 ²		2.7x10 ⁻⁹	1.0x10 ⁵	2.7x10 ⁻⁶	
Cm-243	1.0		2.7x10 ⁻¹¹	1.0x10 ⁴	2.7x10 ⁻⁷	
Cm-244	1.0x10 ¹		2.7x10 ⁻¹⁰	1.0x10 ⁴	2.7x10 ⁻⁷	
Cm-245	1.0		2.7x10 ⁻¹¹	1.0x10 ³	2.7x10 ⁻⁸	
Cm-246	1.0		2.7x10 ⁻¹¹	1.0x10 ³	2.7x10 ⁻⁸	
Cm-247	1.0		2.7x10 ⁻¹¹	1.0x10 ⁴	2.7x10 ⁻⁷	
Cm-248	1.0	2.7x10 ⁻¹¹	1.0x10 ³	2.7x10 ⁻⁸		
Co-55	Cobalt (27)	1.0x10 ¹	2.7x10 ⁻¹⁰	1.0x10 ⁶	2.7x10 ⁻⁵	
Co-56		1.0x10 ¹	2.7x10 ⁻¹⁰	1.0x10 ⁵	2.7x10 ⁻⁶	
Co-57		1.0x10 ²	2.7x10 ⁻⁹	1.0x10 ⁶	2.7x10 ⁻⁵	
Co-58		1.0x10 ¹	2.7x10 ⁻¹⁰	1.0x10 ⁶	2.7x10 ⁻⁵	
Co-58m		1.0x10 ⁴	2.7x10 ⁻⁷	1.0x10 ⁷	2.7x10 ⁻⁴	
Co-60		1.0x10 ¹	2.7x10 ⁻¹⁰	1.0x10 ⁵	2.7x10 ⁻⁶	
Cr-51	Chromium (24)	1.0x10 ³	2.7x10 ⁻⁸	1.0x10 ⁷	2.7x10 ⁻⁴	
Cs-129		Cesium (55)	1.0x10 ²	2.7x10 ⁻⁹	1.0x10 ⁵	2.7x10 ⁻⁶
Cs-131	1.0x10 ³		2.7x10 ⁻⁸	1.0x10 ⁶	2.7x10 ⁻⁵	
Cs-132	1.0x10 ¹		2.7x10 ⁻¹⁰	1.0x10 ⁵	2.7x10 ⁻⁶	
Cs-134	1.0x10 ¹		2.7x10 ⁻¹⁰	1.0x10 ⁴	2.7x10 ⁻⁷	
Cs-134m	1.0x10 ³		2.7x10 ⁻⁸	1.0x10 ⁵	2.7x10 ⁻⁶	
Cs-135	1.0x10 ⁴		2.7x10 ⁻⁷	1.0x10 ⁷	2.7x10 ⁻⁴	
Cs-136	1.0x10 ¹		2.7x10 ⁻¹⁰	1.0x10 ⁵	2.7x10 ⁻⁶	
Cs-137 (b)	1.0x10 ¹		2.7x10 ⁻¹⁰	1.0x10 ⁴	2.7x10 ⁻⁷	
Cu-64	Copper (29)		1.0x10 ²	2.7x10 ⁻⁹	1.0x10 ⁶	2.7x10 ⁻⁵
Cu-67			1.0x10 ²	2.7x10 ⁻⁹	1.0x10 ⁶	2.7x10 ⁻⁵
Dy-159	Dysprosium (66)		1.0x10 ³	2.7x10 ⁻⁸	1.0x10 ⁷	2.7x10 ⁻⁴
Dy-165			1.0x10 ³	2.7x10 ⁻⁸	1.0x10 ⁶	2.7x10 ⁻⁵
Dy-166			1.0x10 ³	2.7x10 ⁻⁸	1.0x10 ⁶	2.7x10 ⁻⁵
Er-169	Erbium (68)		1.0x10 ⁴	2.7x10 ⁻⁷	1.0x10 ⁷	2.7x10 ⁻⁴
Er-171		1.0x10 ²	2.7x10 ⁻⁹	1.0x10 ⁶	2.7x10 ⁻⁵	
Eu-147	Europium (63)	1.0x10 ²	2.7x10 ⁻⁹	1.0x10 ⁶	2.7x10 ⁻⁵	
Eu-148		1.0x10 ¹	2.7x10 ⁻¹⁰	1.0x10 ⁶	2.7x10 ⁻⁵	
Eu-149		1.0x10 ²	2.7x10 ⁻⁹	1.0x10 ⁷	2.7x10 ⁻⁴	
Eu-150 (short lived)		1.0x10 ³	2.7x10 ⁻⁸	1.0x10 ⁶	2.7x10 ⁻⁵	
Eu-150 (long lived)		1.0x10 ¹	2.7x10 ⁻¹⁰	1.0x10 ⁶	2.7x10 ⁻⁵	
Eu-152		1.0x10 ¹	2.7x10 ⁻¹⁰	1.0x10 ⁶	2.7x10 ⁻⁵	
Eu-152m		1.0x10 ²	2.7x10 ⁻⁹	1.0x10 ⁶	2.7x10 ⁻⁵	
Eu-154		1.0x10 ¹	2.7x10 ⁻¹⁰	1.0x10 ⁶	2.7x10 ⁻⁵	
Eu-155		1.0x10 ²	2.7x10 ⁻⁹	1.0x10 ⁷	2.7x10 ⁻⁴	
Eu-156		1.0x10 ¹	2.7x10 ⁻¹⁰	1.0x10 ⁶	2.7x10 ⁻⁵	
F-18	Fluorine (9)	1.0x10 ¹	2.7x10 ⁻¹⁰	1.0x10 ⁶	2.7x10 ⁻⁵	
Fe-52	Iron (26)	1.0x10 ¹	2.7x10 ⁻¹⁰	1.0x10 ⁶	2.7x10 ⁻⁵	
Fe-55		1.0x10 ⁴	2.7x10 ⁻⁷	1.0x10 ⁶	2.7x10 ⁻⁵	
Fe-59		1.0x10 ¹	2.7x10 ⁻¹⁰	1.0x10 ⁶	2.7x10 ⁻⁵	
Fe-60		1.0x10 ²	2.7x10 ⁻⁹	1.0x10 ⁵	2.7x10 ⁻⁶	
Ga-67	Gallium (31)	1.0x10 ²	2.7x10 ⁻⁹	1.0x10 ⁶	2.7x10 ⁻⁵	
Ga-68		1.0x10 ¹	2.7x10 ⁻¹⁰	1.0x10 ⁵	2.7x10 ⁻⁶	
Ga-72		1.0x10 ¹	2.7x10 ⁻¹⁰	1.0x10 ⁵	2.7x10 ⁻⁶	
Gd-146	Gadolinium (64)	1.0x10 ¹	2.7x10 ⁻¹⁰	1.0x10 ⁶	2.7x10 ⁻⁵	
Gd-148		1.0x10 ¹	2.7x10 ⁻¹⁰	1.0x10 ⁴	2.7x10 ⁻⁷	
Gd-153		1.0x10 ²	2.7x10 ⁻⁹	1.0x10 ⁷	2.7x10 ⁻⁴	
Gd-159		1.0x10 ³	2.7x10 ⁻⁸	1.0x10 ⁶	2.7x10 ⁻⁵	
Ge-68		Germanium (32)	1.0x10 ¹	2.7x10 ⁻¹⁰	1.0x10 ⁵	2.7x10 ⁻⁶
Ge-71	1.0x10 ⁴		2.7x10 ⁻⁷	1.0x10 ⁸	2.7x10 ⁻³	
Ge-77	1.0x10 ¹		2.7x10 ⁻¹⁰	1.0x10 ⁵	2.7x10 ⁻⁶	
Hf-172	Hafnium (72)		1.0x10 ¹	2.7x10 ⁻¹⁰	1.0x10 ⁶	2.7x10 ⁻⁵

Symbol of radionuclide	Element and atomic number	Activity concentration for exempt material (Bq/g)	Activity concentration for exempt material (Ci/g)	Activity limit for exempt consignment (Bq)	Activity limit for exempt consignment (Ci)
Hf-175	1.0×10 ²	2.7×10 ⁻⁹	1.0×10 ⁶	2.7×10 ⁻⁵
Hf-181	1.0×10 ¹	2.7×10 ⁻¹⁰	1.0×10 ⁶	2.7×10 ⁻⁵
Hf-182	1.0×10 ²	2.7×10 ⁻⁹	1.0×10 ⁶	2.7×10 ⁻⁵
Hg-194	Mercury (80)	1.0×10 ¹	2.7×10 ⁻¹⁰	1.0×10 ⁶	2.7×10 ⁻⁵
Hg-195m	1.0×10 ²	2.7×10 ⁻⁹	1.0×10 ⁶	2.7×10 ⁻⁵
Hg-197	1.0×10 ²	2.7×10 ⁻⁹	1.0×10 ⁷	2.7×10 ⁻⁴
Hg-197m	1.0×10 ²	2.7×10 ⁻⁹	1.0×10 ⁶	2.7×10 ⁻⁵
Hg-203	1.0×10 ²	2.7×10 ⁻⁹	1.0×10 ⁵	2.7×10 ⁻⁶
Ho-166	Holmium (67)	1.0×10 ³	2.7×10 ⁻⁸	1.0×10 ⁵	2.7×10 ⁻⁶
Ho-166m	1.0×10 ¹	2.7×10 ⁻¹⁰	1.0×10 ⁶	2.7×10 ⁻⁵
I-123	Iodine (53)	1.0×10 ²	2.7×10 ⁻⁹	1.0×10 ⁷	2.7×10 ⁻⁴
I-124	1.0×10 ¹	2.7×10 ⁻¹⁰	1.0×10 ⁶	2.7×10 ⁻⁵
I-125	1.0×10 ³	2.7×10 ⁻⁸	1.0×10 ⁶	2.7×10 ⁻⁵
I-126	1.0×10 ²	2.7×10 ⁻⁹	1.0×10 ⁶	2.7×10 ⁻⁵
I-129	1.0×10 ²	2.7×10 ⁻⁹	1.0×10 ⁵	2.7×10 ⁻⁶
I-131	1.0×10 ²	2.7×10 ⁻⁹	1.0×10 ⁶	2.7×10 ⁻⁵
I-132	1.0×10 ¹	2.7×10 ⁻¹⁰	1.0×10 ⁵	2.7×10 ⁻⁶
I-133	1.0×10 ¹	2.7×10 ⁻¹⁰	1.0×10 ⁶	2.7×10 ⁻⁵
I-134	1.0×10 ¹	2.7×10 ⁻¹⁰	1.0×10 ⁵	2.7×10 ⁻⁶
I-135	1.0×10 ¹	2.7×10 ⁻¹⁰	1.0×10 ⁶	2.7×10 ⁻⁵
In-111	Indium (49)	1.0×10 ²	2.7×10 ⁻⁹	1.0×10 ⁶	2.7×10 ⁻⁵
In-113m	1.0×10 ²	2.7×10 ⁻⁹	1.0×10 ⁶	2.7×10 ⁻⁵
In-114m	1.0×10 ²	2.7×10 ⁻⁹	1.0×10 ⁶	2.7×10 ⁻⁵
In-115m	1.0×10 ²	2.7×10 ⁻⁹	1.0×10 ⁶	2.7×10 ⁻⁵
Ir-189	Iridium (77)	1.0×10 ²	2.7×10 ⁻⁹	1.0×10 ⁷	2.7×10 ⁻⁴
Ir-190	1.0×10 ¹	2.7×10 ⁻¹⁰	1.0×10 ⁶	2.7×10 ⁻⁵
Ir-192	1.0×10 ¹	2.7×10 ⁻¹⁰	1.0×10 ⁴	2.7×10 ⁻⁷
Ir-194	1.0×10 ²	2.7×10 ⁻⁹	1.0×10 ⁵	2.7×10 ⁻⁶
K-40	Potassium (19)	1.0×10 ²	2.7×10 ⁻⁹	1.0×10 ⁶	2.7×10 ⁻⁵
K-42	1.0×10 ²	2.7×10 ⁻⁹	1.0×10 ⁶	2.7×10 ⁻⁵
K-43	1.0×10 ¹	2.7×10 ⁻¹⁰	1.0×10 ⁶	2.7×10 ⁻⁵
Kr-79	Krypton (36)	1.0×10 ³	2.7×10 ⁻⁸	1.0×10 ⁵	2.7×10 ⁻⁶
Kr-81	Krypton (36)	1.0×10 ⁴	2.7×10 ⁻⁷	1.0×10 ⁷	2.7×10 ⁻⁴
Kr-85	1.0×10 ⁵	2.7×10 ⁻⁶	1.0×10 ⁴	2.7×10 ⁻⁷
Kr-85m	1.0×10 ³	2.7×10 ⁻⁸	1.0×10 ¹⁰	2.7×10 ⁻¹
Kr-87	1.0×10 ²	2.7×10 ⁻⁹	1.0×10 ⁹	2.7×10 ⁻²
La-137	Lanthanum (57)	1.0×10 ³	2.7×10 ⁻⁸	1.0×10 ⁷	2.7×10 ⁻⁴
La-140	1.0×10 ¹	2.7×10 ⁻¹⁰	1.0×10 ⁵	2.7×10 ⁻⁶
Lu-172	Lutetium (71)	1.0×10 ¹	2.7×10 ⁻¹⁰	1.0×10 ⁶	2.7×10 ⁻⁵
Lu-173	1.0×10 ²	2.7×10 ⁻⁹	1.0×10 ⁷	2.7×10 ⁻⁴
Lu-174	1.0×10 ²	2.7×10 ⁻⁹	1.0×10 ⁷	2.7×10 ⁻⁴
Lu-174m	1.0×10 ²	2.7×10 ⁻⁹	1.0×10 ⁷	2.7×10 ⁻⁴
Lu-177	1.0×10 ³	2.7×10 ⁻⁸	1.0×10 ⁷	2.7×10 ⁻⁴
Mg-28	Magnesium (12)	1.0×10 ¹	2.7×10 ⁻¹⁰	1.0×10 ⁵	2.7×10 ⁻⁶
Mn-52	Manganese (25)	1.0×10 ¹	2.7×10 ⁻¹⁰	1.0×10 ⁵	2.7×10 ⁻⁶
Mn-53	1.0×10 ⁴	2.7×10 ⁻⁷	1.0×10 ⁹	2.7×10 ⁻²
Mn-54	1.0×10 ¹	2.7×10 ⁻¹⁰	1.0×10 ⁶	2.7×10 ⁻⁵
Mn-56	1.0×10 ¹	2.7×10 ⁻¹⁰	1.0×10 ⁵	2.7×10 ⁻⁶
Mo-93	Molybdenum (42)	1.0×10 ³	2.7×10 ⁻⁸	1.0×10 ⁸	2.7×10 ⁻³
Mo-99	1.0×10 ²	2.7×10 ⁻⁹	1.0×10 ⁶	2.7×10 ⁻⁵
N-13	Nitrogen (7)	1.0×10 ²	2.7×10 ⁻⁹	1.0×10 ⁹	2.7×10 ⁻²
Na-22	Sodium (11)	1.0×10 ¹	2.7×10 ⁻¹⁰	1.0×10 ⁶	2.7×10 ⁻⁵
Na-24	1.0×10 ¹	2.7×10 ⁻¹⁰	1.0×10 ⁵	2.7×10 ⁻⁶
Nb-93m	Niobium (41)	1.0×10 ⁴	2.7×10 ⁻⁷	1.0×10 ⁷	2.7×10 ⁻⁴
Nb-94	1.0×10 ¹	2.7×10 ⁻¹⁰	1.0×10 ⁶	2.7×10 ⁻⁵
Nb-95	1.0×10 ¹	2.7×10 ⁻¹⁰	1.0×10 ⁶	2.7×10 ⁻⁵
Nb-97	1.0×10 ¹	2.7×10 ⁻¹⁰	1.0×10 ⁶	2.7×10 ⁻⁵
Nd-147	Neodymium (60)	1.0×10 ²	2.7×10 ⁻⁹	1.0×10 ⁶	2.7×10 ⁻⁵
Nd-149	1.0×10 ²	2.7×10 ⁻⁹	1.0×10 ⁶	2.7×10 ⁻⁵
Ni-59	Nickel (28)	1.0×10 ⁴	2.7×10 ⁻⁷	1.0×10 ⁸	2.7×10 ⁻³
Ni-63	1.0×10 ⁵	2.7×10 ⁻⁶	1.0×10 ⁸	2.7×10 ⁻³
Ni-65	1.0×10 ¹	2.7×10 ⁻¹⁰	1.0×10 ⁶	2.7×10 ⁻⁵
Np-235	Neptunium (93)	1.0×10 ³	2.7×10 ⁻⁸	1.0×10 ⁷	2.7×10 ⁻⁴
Np-236 (short-lived)	1.0×10 ³	2.7×10 ⁻⁸	1.0×10 ⁷	2.7×10 ⁻⁴
Np-236 (long-lived)	1.0×10 ²	2.7×10 ⁻⁹	1.0×10 ⁵	2.7×10 ⁻⁶
Np-237 (b)	1.0	2.7×10 ⁻¹¹	1.0×10 ³	2.7×10 ⁻⁸
Np-239	1.0×10 ²	2.7×10 ⁻⁹	1.0×10 ⁷	2.7×10 ⁻⁴
Os-185	Osmium (76)	1.0×10 ¹	2.7×10 ⁻¹⁰	1.0×10 ⁶	2.7×10 ⁻⁵
Os-191	1.0×10 ²	2.7×10 ⁻⁹	1.0×10 ⁷	2.7×10 ⁻⁴
Os-191m	1.0×10 ³	2.7×10 ⁻⁸	1.0×10 ⁷	2.7×10 ⁻⁴
Os-193	1.0×10 ²	2.7×10 ⁻⁹	1.0×10 ⁶	2.7×10 ⁻⁵

Symbol of radionuclide	Element and atomic number	Activity concentration for exempt material (Bq/g)	Activity concentration for exempt material (Ci/g)	Activity limit for exempt consignment (Bq)	Activity limit for exempt consignment (Ci)
Os-194	1.0x10 ²	2.7x10 ⁻⁹	1.0x10 ⁵	2.7x10 ⁻⁶
P-32	Phosphorus (15)	1.0x10 ³	2.7x10 ⁻⁸	1.0x10 ⁵	2.7x10 ⁻⁶
P-33	1.0x10 ⁵	2.7x10 ⁻⁶	1.0x10 ⁸	2.7x10 ⁻³
Pa-230	Protactinium (91)	1.0x10 ¹	2.7x10 ⁻¹⁰	1.0x10 ⁶	2.7x10 ⁻⁵
Pa-231	1.0	2.7x10 ⁻¹¹	1.0x10 ³	2.7x10 ⁻⁸
Pa-233	1.0x10 ²	2.7x10 ⁻⁹	1.0x10 ⁷	2.7x10 ⁻⁴
Pb-201	Lead (82)	1.0x10 ¹	2.7x10 ⁻¹⁰	1.0x10 ⁶	2.7x10 ⁻⁵
Pb-202	1.0x10 ³	2.7x10 ⁻⁸	1.0x10 ⁶	2.7x10 ⁻⁵
Pb-203	1.0x10 ²	2.7x10 ⁻⁹	1.0x10 ⁶	2.7x10 ⁻⁵
Pb-205	1.0x10 ⁴	2.7x10 ⁻⁷	1.0x10 ⁷	2.7x10 ⁻⁴
Pb-210 (b)	1.0x10 ¹	2.7x10 ⁻¹⁰	1.0x10 ⁴	2.7x10 ⁻⁷
Pb-212 (b)	1.0x10 ¹	2.7x10 ⁻¹⁰	1.0x10 ⁵	2.7x10 ⁻⁶
Pd-103	Palladium (46)	1.0x10 ³	2.7x10 ⁻⁸	1.0x10 ⁸	2.7x10 ⁻³
Pd-107	1.0x10 ⁵	2.7x10 ⁻⁶	1.0x10 ⁸	2.7x10 ⁻³
Pd-109	1.0x10 ³	2.7x10 ⁻⁸	1.0x10 ⁶	2.7x10 ⁻⁵
Pm-143	Promethium (61)	1.0x10 ²	2.7x10 ⁻⁹	1.0x10 ⁶	2.7x10 ⁻⁵
Pm-144	1.0x10 ¹	2.7x10 ⁻¹⁰	1.0x10 ⁶	2.7x10 ⁻⁵
Pm-145	1.0x10 ³	2.7x10 ⁻⁸	1.0x10 ⁷	2.7x10 ⁻⁴
Pm-147	1.0x10 ⁴	2.7x10 ⁻⁷	1.0x10 ⁷	2.7x10 ⁻⁴
Pm-148m	1.0x10 ¹	2.7x10 ⁻¹⁰	1.0x10 ⁶	2.7x10 ⁻⁵
Pm-149	1.0x10 ³	2.7x10 ⁻⁸	1.0x10 ⁶	2.7x10 ⁻⁵
Pm-151	1.0x10 ²	2.7x10 ⁻⁹	1.0x10 ⁶	2.7x10 ⁻⁵
Po-210	Polonium (84)	1.0x10 ¹	2.7x10 ⁻¹⁰	1.0x10 ⁴	2.7x10 ⁻⁷
Pr-142	Praseodymium (59)	1.0x10 ²	2.7x10 ⁻⁹	1.0x10 ⁵	2.7x10 ⁻⁶
Pr-143	1.0x10 ⁴	2.7x10 ⁻⁷	1.0x10 ⁶	2.7x10 ⁻⁵
Pt-188	Platinum (78)	1.0x10 ¹	2.7x10 ⁻¹⁰	1.0x10 ⁶	2.7x10 ⁻⁵
Pt-191	1.0x10 ²	2.7x10 ⁻⁹	1.0x10 ⁶	2.7x10 ⁻⁵
Pt-193	1.0x10 ⁴	2.7x10 ⁻⁷	1.0x10 ⁷	2.7x10 ⁻⁴
Pt-193m	1.0x10 ³	2.7x10 ⁻⁸	1.0x10 ⁷	2.7x10 ⁻⁴
Pt-195m	1.0x10 ²	2.7x10 ⁻⁹	1.0x10 ⁶	2.7x10 ⁻⁵
Pt-197	1.0x10 ³	2.7x10 ⁻⁸	1.0x10 ⁶	2.7x10 ⁻⁵
Pt-197m	1.0x10 ²	2.7x10 ⁻⁹	1.0x10 ⁶	2.7x10 ⁻⁵
Pu-236	Plutonium (94)	1.0x10 ¹	2.7x10 ⁻¹⁰	1.0x10 ⁴	2.7x10 ⁻⁷
Pu-237	1.0x10 ³	2.7x10 ⁻⁸	1.0x10 ⁷	2.7x10 ⁻⁴
Pu-238	1.0	2.7x10 ⁻¹¹	1.0x10 ⁴	2.7x10 ⁻⁷
Pu-239	1.0	2.7x10 ⁻¹¹	1.0x10 ⁴	2.7x10 ⁻⁷
Pu-240	1.0	2.7x10 ⁻¹¹	1.0x10 ³	2.7x10 ⁻⁸
Pu-241	1.0x10 ²	2.7x10 ⁻⁹	1.0x10 ⁵	2.7x10 ⁻⁶
Pu-242	1.0	2.7x10 ⁻¹¹	1.0x10 ⁴	2.7x10 ⁻⁷
Pu-244	1.0	2.7x10 ⁻¹¹	1.0x10 ⁴	2.7x10 ⁻⁷
Ra-223 (b)	Radium (88)	1.0x10 ²	2.7x10 ⁻⁹	1.0x10 ⁵	2.7x10 ⁻⁶
Ra-224 (b)	1.0x10 ¹	2.7x10 ⁻¹⁰	1.0x10 ⁵	2.7x10 ⁻⁶
Ra-225	1.0x10 ²	2.7x10 ⁻⁹	1.0x10 ⁵	2.7x10 ⁻⁶
Ra-226 (b)	1.0x10 ¹	2.7x10 ⁻¹⁰	1.0x10 ⁴	2.7x10 ⁻⁷
Ra-228 (b)	1.0x10 ¹	2.7x10 ⁻¹⁰	1.0x10 ⁵	2.7x10 ⁻⁶
Rb-81	Rubidium (37)	1.0x10 ¹	2.7x10 ⁻¹⁰	1.0x10 ⁶	2.7x10 ⁻⁵
Rb-83	1.0x10 ²	2.7x10 ⁻⁹	1.0x10 ⁶	2.7x10 ⁻⁵
Rb-84	1.0x10 ¹	2.7x10 ⁻¹⁰	1.0x10 ⁶	2.7x10 ⁻⁵
Rb-86	1.0x10 ²	2.7x10 ⁻⁹	1.0x10 ⁵	2.7x10 ⁻⁶
Rb-87	1.0x10 ⁴	2.7x10 ⁻⁷	1.0x10 ⁷	2.7x10 ⁻⁴
Rb(mat)	1.0x10 ⁴	2.7x10 ⁻⁷	1.0x10 ⁷	2.7x10 ⁻⁴
Re-184	Rhenium (75)	1.0x10 ¹	2.7x10 ⁻¹⁰	1.0x10 ⁶	2.7x10 ⁻⁵
Re-184m	1.0x10 ²	2.7x10 ⁻⁹	1.0x10 ⁶	2.7x10 ⁻⁵
Re-186	1.0x10 ³	2.7x10 ⁻⁸	1.0x10 ⁶	2.7x10 ⁻⁵
Re-187	1.0x10 ⁶	2.7x10 ⁻⁵	1.0x10 ⁹	2.7x10 ⁻²
Re-188	1.0x10 ²	2.7x10 ⁻⁹	1.0x10 ⁵	2.7x10 ⁻⁶
Re-189	1.0x10 ²	2.7x10 ⁻⁹	1.0x10 ⁶	2.7x10 ⁻⁵
Re(mat)	1.0x10 ⁶	2.7x10 ⁻⁵	1.0x10 ⁹	2.7x10 ⁻²
Rh-99	Rhodium (45)	1.0x10 ¹	2.7x10 ⁻¹⁰	1.0x10 ⁶	2.7x10 ⁻⁵
Rh-101	1.0x10 ²	2.7x10 ⁻⁹	1.0x10 ⁷	2.7x10 ⁻⁴
Rh-102	1.0x10 ¹	2.7x10 ⁻¹⁰	1.0x10 ⁶	2.7x10 ⁻⁵
Rh-102m	1.0x10 ²	2.7x10 ⁻⁹	1.0x10 ⁶	2.7x10 ⁻⁵
Rh-103m	1.0x10 ⁴	2.7x10 ⁻⁷	1.0x10 ⁸	2.7x10 ⁻³
Rh-105	1.0x10 ²	2.7x10 ⁻⁹	1.0x10 ⁷	2.7x10 ⁻⁴
Rn-222 (b)	Radon (86)	1.0x10 ¹	2.7x10 ⁻¹⁰	1.0x10 ⁸	2.7x10 ⁻³
Ru-97	Ruthenium (44)	1.0x10 ²	2.7x10 ⁻⁹	1.0x10 ⁷	2.7x10 ⁻⁴
Ru-103	1.0x10 ²	2.7x10 ⁻⁹	1.0x10 ⁶	2.7x10 ⁻⁵
Ru-105	1.0x10 ¹	2.7x10 ⁻¹⁰	1.0x10 ⁶	2.7x10 ⁻⁵
Ru-106 (b)	1.0x10 ²	2.7x10 ⁻⁹	1.0x10 ⁵	2.7x10 ⁻⁶
S-35	Sulphur (16)	1.0x10 ⁵	2.7x10 ⁻⁶	1.0x10 ⁸	2.7x10 ⁻³
Sb-122	Antimony (51)	1.0x10 ²	2.7x10 ⁻⁹	1.0x10 ⁴	2.7x10 ⁻⁷

Symbol of radionuclide	Element and atomic number	Activity concentration for exempt material (Bq/g)	Activity concentration for exempt material (Ci/g)	Activity limit for exempt consignment (Bq)	Activity limit for exempt consignment (Ci)
Sb-124		1.0x10 ¹	2.7x10 ⁻¹⁰	1.0x10 ⁶	2.7x10 ⁻⁵
Sb-125		1.0x10 ²	2.7x10 ⁻⁹	1.0x10 ⁶	2.7x10 ⁻⁵
Sb-126		1.0x10 ¹	2.7x10 ⁻¹⁰	1.0x10 ⁵	2.7x10 ⁻⁶
Sc-44	Scandium (21)	1.0x10 ¹	2.7x10 ⁻¹⁰	1.0x10 ⁵	2.7x10 ⁻⁶
Sc-46		1.0x10 ¹	2.7x10 ⁻¹⁰	1.0x10 ⁶	2.7x10 ⁻⁵
Sc-47		1.0x10 ²	2.7x10 ⁻⁹	1.0x10 ⁶	2.7x10 ⁻⁵
Sc-48		1.0x10 ¹	2.7x10 ⁻¹⁰	1.0x10 ⁵	2.7x10 ⁻⁶
Se-75	Selenium (34)	1.0x10 ²	2.7x10 ⁻⁹	1.0x10 ⁶	2.7x10 ⁻⁵
Se-79		1.0x10 ⁴	2.7x10 ⁻⁷	1.0x10 ⁷	2.7x10 ⁻⁴
Si-31	Silicon (14)	1.0x10 ³	2.7x10 ⁻⁸	1.0x10 ⁶	2.7x10 ⁻⁵
Si-32		1.0x10 ³	2.7x10 ⁻⁸	1.0x10 ⁶	2.7x10 ⁻⁵
Sm-145	Samarium (62)	1.0x10 ²	2.7x10 ⁻⁹	1.0x10 ⁷	2.7x10 ⁻⁴
Sm-147		1.0x10 ¹	2.7x10 ⁻¹⁰	1.0x10 ⁴	2.7x10 ⁻⁷
Sm-151		1.0x10 ⁴	2.7x10 ⁻⁷	1.0x10 ⁸	2.7x10 ⁻³
Sm-153		1.0x10 ²	2.7x10 ⁻⁹	1.0x10 ⁶	2.7x10 ⁻⁵
Sn-113	Tin (50)	1.0x10 ³	2.7x10 ⁻⁸	1.0x10 ⁷	2.7x10 ⁻⁴
Sn-117m		1.0x10 ²	2.7x10 ⁻⁹	1.0x10 ⁶	2.7x10 ⁻⁵
Sn-119m		1.0x10 ³	2.7x10 ⁻⁸	1.0x10 ⁷	2.7x10 ⁻⁴
Sn-121m		1.0x10 ³	2.7x10 ⁻⁸	1.0x10 ⁷	2.7x10 ⁻⁴
Sn-123		1.0x10 ³	2.7x10 ⁻⁸	1.0x10 ⁶	2.7x10 ⁻⁵
Sn-125		1.0x10 ²	2.7x10 ⁻⁹	1.0x10 ⁵	2.7x10 ⁻⁶
Sn-126		1.0x10 ¹	2.7x10 ⁻¹⁰	1.0x10 ⁵	2.7x10 ⁻⁶
Sr-82	Strontium (38)	1.0x10 ¹	2.7x10 ⁻¹⁰	1.0x10 ⁵	2.7x10 ⁻⁶
Sr-85		1.0x10 ²	2.7x10 ⁻⁹	1.0x10 ⁶	2.7x10 ⁻⁵
Sr-85m		1.0x10 ²	2.7x10 ⁻⁹	1.0x10 ⁷	2.7x10 ⁻⁴
Sr-87m		1.0x10 ²	2.7x10 ⁻⁹	1.0x10 ⁶	2.7x10 ⁻⁵
Sr-89		1.0x10 ³	2.7x10 ⁻⁸	1.0x10 ⁶	2.7x10 ⁻⁵
Sr-90 (b)		1.0x10 ²	2.7x10 ⁻⁹	1.0x10 ⁴	2.7x10 ⁻⁷
Sr-91		1.0x10 ¹	2.7x10 ⁻¹⁰	1.0x10 ⁵	2.7x10 ⁻⁶
Sr-92		1.0x10 ¹	2.7x10 ⁻¹⁰	1.0x10 ⁶	2.7x10 ⁻⁵
T(H-3)	Tritium (1)	1.0x10 ⁶	2.7x10 ⁻⁵	1.0x10 ⁹	2.7x10 ⁻²
Ta-178 (long-lived)	Tantalum (73)	1.0x10 ¹	2.7x10 ⁻¹⁰	1.0x10 ⁶	2.7x10 ⁻⁵
Ta-179		1.0x10 ³	2.7x10 ⁻⁸	1.0x10 ⁷	2.7x10 ⁻⁴
Ta-182		1.0x10 ¹	2.7x10 ⁻¹⁰	1.0x10 ⁴	2.7x10 ⁻⁷
Tb-157	Terbium (65)	1.0x10 ⁴	2.7x10 ⁻⁷	1.0x10 ⁷	2.7x10 ⁻⁴
Tb-158		1.0x10 ¹	2.7x10 ⁻¹⁰	1.0x10 ⁶	2.7x10 ⁻⁵
Tb-160		1.0x10 ¹	2.7x10 ⁻¹⁰	1.0x10 ⁶	2.7x10 ⁻⁵
Tc-95m	Technetium (43)	1.0x10 ¹	2.7x10 ⁻¹⁰	1.0x10 ⁶	2.7x10 ⁻⁵
Tc-96		1.0x10 ¹	2.7x10 ⁻¹⁰	1.0x10 ⁶	2.7x10 ⁻⁵
Tc-96m		1.0x10 ³	2.7x10 ⁻⁸	1.0x10 ⁷	2.7x10 ⁻⁴
Tc-97		1.0x10 ³	2.7x10 ⁻⁸	1.0x10 ⁸	2.7x10 ⁻³
Tc-97m		1.0x10 ³	2.7x10 ⁻⁸	1.0x10 ⁷	2.7x10 ⁻⁴
Tc-98		1.0x10 ¹	2.7x10 ⁻¹⁰	1.0x10 ⁶	2.7x10 ⁻⁵
Tc-99		1.0x10 ⁴	2.7x10 ⁻⁷	1.0x10 ⁷	2.7x10 ⁻⁴
Tc-99m		1.0x10 ²	2.7x10 ⁻⁹	1.0x10 ⁷	2.7x10 ⁻⁴
Te-121	Tellurium (52)	1.0x10 ¹	2.7x10 ⁻¹⁰	1.0x10 ⁶	2.7x10 ⁻⁵
Te-121m		1.0x10 ²	2.7x10 ⁻⁹	1.0x10 ⁶	2.7x10 ⁻⁵
Te-123m		1.0x10 ²	2.7x10 ⁻⁹	1.0x10 ⁷	2.7x10 ⁻⁴
Te-125m		1.0x10 ³	2.7x10 ⁻⁸	1.0x10 ⁷	2.7x10 ⁻⁴
Te-127		1.0x10 ³	2.7x10 ⁻⁸	1.0x10 ⁶	2.7x10 ⁻⁵
Te-127m		1.0x10 ³	2.7x10 ⁻⁸	1.0x10 ⁷	2.7x10 ⁻⁴
Te-129		1.0x10 ²	2.7x10 ⁻⁹	1.0x10 ⁶	2.7x10 ⁻⁵
Te-129m		1.0x10 ³	2.7x10 ⁻⁸	1.0x10 ⁶	2.7x10 ⁻⁵
Te-131m		1.0x10 ¹	2.7x10 ⁻¹⁰	1.0x10 ⁶	2.7x10 ⁻⁵
Te-132		1.0x10 ²	2.7x10 ⁻⁹	1.0x10 ⁷	2.7x10 ⁻⁴
Th-227	Thorium (90)	1.0x10 ¹	2.7x10 ⁻¹⁰	1.0x10 ⁴	2.7x10 ⁻⁷
Th-228 (b)		1.0	2.7x10 ⁻¹¹	1.0x10 ⁴	2.7x10 ⁻⁷
Th-229 (b)		1.0	2.7x10 ⁻¹¹	1.0x10 ³	2.7x10 ⁻⁸
Th-230		1.0	2.7x10 ⁻¹¹	1.0x10 ⁴	2.7x10 ⁻⁷
Th-231		1.0x10 ³	2.7x10 ⁻⁸	1.0x10 ⁷	2.7x10 ⁻⁴
Th-232		1.0x10 ¹	2.7x10 ⁻¹⁰	1.0x10 ⁴	2.7x10 ⁻⁷
Th-234 (b)		1.0x10 ³	2.7x10 ⁻⁸	1.0x10 ⁵	2.7x10 ⁻⁶
Th (nat) (b)		1.0	2.7x10 ⁻¹¹	1.0x10 ³	2.7x10 ⁻⁸
Ti-44	Titanium (22)	1.0x10 ¹	2.7x10 ⁻¹⁰	1.0x10 ⁵	2.7x10 ⁻⁶
Tl-200	Thallium (81)	1.0x10 ¹	2.7x10 ⁻¹⁰	1.0x10 ⁶	2.7x10 ⁻⁵
Tl-201		1.0x10 ²	2.7x10 ⁻⁹	1.0x10 ⁶	2.7x10 ⁻⁵
Tl-202		1.0x10 ²	2.7x10 ⁻⁹	1.0x10 ⁶	2.7x10 ⁻⁵
Tl-204		1.0x10 ⁴	2.7x10 ⁻⁷	1.0x10 ⁴	2.7x10 ⁻⁷
Tm-167	Thulium (69)	1.0x10 ²	2.7x10 ⁻⁹	1.0x10 ⁶	2.7x10 ⁻⁵
Tm-170		1.0x10 ³	2.7x10 ⁻⁸	1.0x10 ⁶	2.7x10 ⁻⁵
Tm-171		1.0x10 ⁴	2.7x10 ⁻⁷	1.0x10 ⁸	2.7x10 ⁻³

Symbol of radionuclide	Element and atomic number	Activity concentration for exempt material (Bq/g)	Activity concentration for exempt material (Ci/g)	Activity limit for exempt consignment (Bq)	Activity limit for exempt consignment (Ci)
U-230 (fast lung absorption) (b),(d)	Uranium (92)	1.0x10 ¹	2.7x10 ⁻¹⁰	1.0x10 ⁵	2.7x10 ⁻⁶
U-230 (medium lung absorption) (e)	1.0x10 ¹	2.7x10 ⁻¹⁰	1.0x10 ⁴	2.7x10 ⁻⁷
U-230 (slow lung absorption) (f)	1.0x10 ¹	2.7x10 ⁻¹⁰	1.0x10 ⁴	2.7x10 ⁻⁷
U-232 (fast lung absorption) (b),(d)	1.0	2.7x10 ⁻¹¹	1.0x10 ³	2.7x10 ⁻⁸
U-232 (medium lung absorption) (e)	1.0x10 ¹	2.7x10 ⁻¹⁰	1.0x10 ⁴	2.7x10 ⁻⁷
U-232 (slow lung absorption) (f)	1.0x10 ¹	2.7x10 ⁻¹⁰	1.0x10 ⁴	2.7x10 ⁻⁷
U-233 (fast lung absorption) (d)	1.0x10 ¹	2.7x10 ⁻¹⁰	1.0x10 ⁴	2.7x10 ⁻⁷
U-233 (medium lung absorption) (e)	1.0x10 ²	2.7x10 ⁻⁹	1.0x10 ⁵	2.7x10 ⁻⁶
U-233 (slow lung absorption) (f)	1.0x10 ¹	2.7x10 ⁻¹⁰	1.0x10 ⁵	2.7x10 ⁻⁶
U-234 (fast lung absorption) (d)	1.0x10 ¹	2.7x10 ⁻¹⁰	1.0x10 ⁴	2.7x10 ⁻⁷
U-234 (medium lung absorption) (e)	1.0x10 ²	2.7x10 ⁻⁹	1.0x10 ⁵	2.7x10 ⁻⁶
U-234 (slow lung absorption) (f)	1.0x10 ¹	2.7x10 ⁻¹⁰	1.0x10 ⁵	2.7x10 ⁻⁶
U-235 (all lung absorption types) (b),(d),(e),(f).	1.0x10 ¹	2.7x10 ⁻¹⁰	1.0x10 ⁴	2.7x10 ⁻⁷
U-236 (fast lung absorption) (d)	1.0x10 ¹	2.7x10 ⁻¹⁰	1.0x10 ⁴	2.7x10 ⁻⁷
U-236 (medium lung absorption) (e)	1.0x10 ²	2.7x10 ⁻⁹	1.0x10 ⁵	2.7x10 ⁻⁶
U-236 (slow lung absorption) (f)	1.0x10 ¹	2.7x10 ⁻¹⁰	1.0x10 ⁴	2.7x10 ⁻⁷
U-238 (all lung absorption types) (b),(d),(e),(f).	1.0x10 ¹	2.7x10 ⁻¹⁰	1.0x10 ⁴	2.7x10 ⁻⁷
U (nat) (b)	1.0	2.7x10 ⁻¹¹	1.0x10 ³	2.7x10 ⁻⁸
U (enriched to 20% or less)(g)	1.0	2.7x10 ⁻¹¹	1.0x10 ³	2.7x10 ⁻⁸
U (dep)	1.0	2.7x10 ⁻¹¹	1.0x10 ³	2.7x10 ⁻⁸
V-48	Vanadium (23)	1.0x10 ¹	2.7x10 ⁻¹⁰	1.0x10 ⁵	2.7x10 ⁻⁶
V-49	1.0x10 ⁴	2.7x10 ⁻⁷	1.0x10 ⁷	2.7x10 ⁻⁴
W-178	Tungsten (74)	1.0x10 ¹	2.7x10 ⁻¹⁰	1.0x10 ⁶	2.7x10 ⁻⁵
W-181	1.0x10 ³	2.7x10 ⁻⁸	1.0x10 ⁷	2.7x10 ⁻⁴
W-185	1.0x10 ⁴	2.7x10 ⁻⁷	1.0x10 ⁷	2.7x10 ⁻⁴
W-187	1.0x10 ²	2.7x10 ⁻⁹	1.0x10 ⁶	2.7x10 ⁻⁵
W-188	1.0x10 ²	2.7x10 ⁻⁹	1.0x10 ⁵	2.7x10 ⁻⁶
Xe-122	Xenon (54)	1.0x10 ²	2.7x10 ⁻⁹	1.0x10 ⁹	2.7x10 ⁻²
Xe-123	1.0x10 ²	2.7x10 ⁻⁹	1.0x10 ⁹	2.7x10 ⁻²
Xe-127	1.0x10 ³	2.7x10 ⁻⁸	1.0x10 ⁵	2.7x10 ⁻⁶
Xe-131m	1.0x10 ⁴	2.7x10 ⁻⁷	1.0x10 ⁴	2.7x10 ⁻⁷
Xe-133	1.0x10 ³	2.7x10 ⁻⁸	1.0x10 ⁴	2.7x10 ⁻⁷
Xe-135	1.0x10 ³	2.7x10 ⁻⁸	1.0x10 ¹⁰	2.7x10 ⁻¹
Y-87	Yttrium (39)	1.0x10 ¹	2.7x10 ⁻¹⁰	1.0x10 ⁶	2.7x10 ⁻⁵
Y-88	1.0x10 ¹	2.7x10 ⁻¹⁰	1.0x10 ⁶	2.7x10 ⁻⁵
Y-90	1.0x10 ³	2.7x10 ⁻⁸	1.0x10 ⁵	2.7x10 ⁻⁶
Y-91	1.0x10 ³	2.7x10 ⁻⁸	1.0x10 ⁶	2.7x10 ⁻⁵
Y-91m	1.0x10 ²	2.7x10 ⁻⁹	1.0x10 ⁶	2.7x10 ⁻⁵
Y-92	1.0x10 ²	2.7x10 ⁻⁹	1.0x10 ⁵	2.7x10 ⁻⁶
Y-93	1.0x10 ²	2.7x10 ⁻⁹	1.0x10 ⁵	2.7x10 ⁻⁶
Yb-169	Ytterbium (70)	1.0x10 ²	2.7x10 ⁻⁹	1.0x10 ⁷	2.7x10 ⁻⁴
Yb-175	1.0x10 ³	2.7x10 ⁻⁸	1.0x10 ⁷	2.7x10 ⁻⁴
Zn-65	Zinc (30)	1.0x10 ¹	2.7x10 ⁻¹⁰	1.0x10 ⁶	2.7x10 ⁻⁵
Zn-69	1.0x10 ⁴	2.7x10 ⁻⁷	1.0x10 ⁶	2.7x10 ⁻⁵
Zn-69m	1.0x10 ²	2.7x10 ⁻⁹	1.0x10 ⁶	2.7x10 ⁻⁵
Zr-88	Zirconium (40)	1.0x10 ²	2.7x10 ⁻⁹	1.0x10 ⁶	2.7x10 ⁻⁵
Zr-93 (b)	1.0x10 ³	2.7x10 ⁻⁸	1.0x10 ⁷	2.7x10 ⁻⁴
Zr-95	1.0x10 ¹	2.7x10 ⁻¹⁰	1.0x10 ⁶	2.7x10 ⁻⁵
Zr-97 (b)	1.0x10 ¹	2.7x10 ⁻¹⁰	1.0x10 ⁵	2.7x10 ⁻⁶

^a [Reserved]

^b Parent nuclides and their progeny included in secular equilibrium are listed as follows:

- Sr-90 Y-90
- Zr-93 Nb-93m
- Zr-97 Nb-97
- Ru-106 Rh-106
- Ag-108m Ag-108
- Cs-137 Ba-137m
- Ce-144 Pr-144
- Ba-140 La-140
- Bi-212 Tl-208 (0.36), Po-212 (0.64)
- Pb-210 Bi-210, Po-210
- Pb-212 Bi-212, Tl-208 (0.36), Po-212 (0.64)
- Rn-222 Po-218, Pb-214, Bi-214, Po-214
- Ra-223 Rn-219, Po-215, Pb-211, Bi-211, Tl-207
- Ra-224 Rn-220, Po-216, Pb-212, Bi-212, Tl-208 (0.36), Po-212 (0.64)
- Ra-226 Rn-222, Po-218, Pb-214, Bi-214, Bi-214, Po-214, Pb-210, Bi-210, Po-210
- Ra-228 Ac-228
- Th-228 Ra-224, Rn-220, Po-216, Pb-212, Bi-212, Tl-208 (0.36), Po-212(0.64)
- Th-229 Ra-225, Ac-225, Fr-221, At-217, Bi-213, Po-213, Pb-209
- Th-nat Ra-228, Ac-228, Th-228, Ra-224, Rn-220, Po-216, Pb-212, Bi-212, Tl-208 (0.36), Po-212 (0.64)
- Th-234 Pa-234m

U-230	Th-226	Ra-222	Rn-218	Po-214
U-232	Th-228	Ra-224	Rn-220	Po-216, Pb-212, Bi-212, Tl-208 (0.36), Po-212 (0.64)
U-235	Th-231			
U-238	Th-234	Pa-234m		
U-nat	Th-234	Pa-234m	U-234	Th-230, Ra-226, Rn-222, Po-218, Pb-214, Bi-214, Po-214, Pb-210, Bi-210, Po-210
Np-237	Pa-233			
Am-242m	Am-242			
Am-243	Np-239			
c [Reserved]				

^d These values apply only to compounds of uranium that take the chemical form of UF₆, UO₂F₂ and UO₂(NO₃)₂ in both normal and accident conditions of transport.

^e These values apply only to compounds of uranium that take the chemical form of UO₃, UF₄, UCl₄ and hexavalent compounds in both normal and accident conditions of transport.

^f These values apply to all compounds of uranium other than those specified in notes (d) and (e) of this table.

^g These values apply to unirradiated uranium only.

[69 FR 3685, Jan. 26, 2004, as amended at 79 FR 40615, July 11, 2014]

§ 173.441 Radiation level limitations and exclusive use provisions.

(a) Except as provided in paragraph (b) of this section, each package of Class 7 (radioactive) materials offered for transportation must be designed and prepared for shipment, so that under conditions normally incident to transportation, the radiation level does not exceed 2 mSv/hour (200 mrem/hour) at any point on the external surface of the package, and the transport index does not exceed 10.

(b) A package which exceeds the radiation level limits specified in paragraph (a) of this section must be transported by exclusive use shipment, and the radiation levels for such shipment may not exceed the following during transportation:

(1) 2 mSv/h (200 mrem/h) on the external surface of the package unless the following conditions are met, in which case the limit is 10 mSv/h (1000 mrem/h):

(i) The shipment is made in a closed transport vehicle;

(ii) The package is secured within the vehicle so that its position remains fixed during transportation; and

(iii) There are no loading or unloading operations between the beginning and end of the transportation;

(2) 2 mSv/h (200 mrem/h) at any point on the outer surfaces of the vehicle, including the top and underside of the vehicle; or in the case of a flat-bed style vehicle, at any point on the vertical planes projected from the outer edges of the vehicle, on the upper surface of the load or enclosure if used, and on the lower external surface of the vehicle;

(3) 0.1 mSv/h (10 mrem/h) at any point 2 m (6.6 feet) from the outer lateral

surfaces of the vehicle (excluding the top and underside of the vehicle); or in the case of a flat-bed style vehicle, at any point 2 m (6.6 feet) from the vertical planes projected by the outer edges of the vehicle (excluding the top and underside of the vehicle); and

(4) 0.02 mSv/h (2mrem/h) in any normally occupied space, except that this provision does not apply to carriers if they operate under the provisions of a State or federally regulated radiation protection program and if personnel under their control who are in such an occupied space wear radiation dosimetry devices.

(c) For shipments made under the provisions of paragraph (b) of this section, the offeror shall provide specific written instructions for maintenance of the exclusive use shipment controls to the carrier. The instructions must be included with the shipping paper information. The instructions must be sufficient so that, when followed, they will cause the carrier to avoid actions that will unnecessarily delay delivery or unnecessarily result in increased radiation levels or radiation exposures to transport workers or members of the general public.

(d) Conveyance limits on the sum of package transport indices are as follows:

(1) Except for shipments by cargo aircraft only or by seagoing vessel, the sum of transport indices for a non-exclusive use shipment may not exceed 50.

(2) Where a consignment is transported under exclusive use, there is no limit on the sum of the transport indices aboard a single conveyance. The conditions of paragraphs (b)(2), (b)(3), (b)(4) and (c) must be met.

(3) Provisions for shipments of Class 7 (radioactive) materials by air are described in §§175.700–175.705 of this subchapter.

(4) Provisions for shipment of Class 7 (radioactive) materials by vessel are described in §§176.700–176.720 of this subchapter.

(e) A package exceeding the maximum surface radiation level or maximum transport index prescribed in paragraph (a) of this section may not be transported by aircraft.

[Amdt. 173–244, 60 FR 50307, Sept. 28, 1995, as amended at 63 FR 48568, Sept. 10, 1998; 66 FR 45380, Aug. 28, 2001; 69 FR 3691, Jan. 26, 2004]

§ 173.442 Thermal limitations.

A package of Class 7 (radioactive) material must be designed, constructed, and loaded so that—

(a) The heat generated within the package by the radioactive contents will not, during conditions normally incident to transport, affect the integrity of the package; and

(b) The temperature of the accessible external surfaces of the loaded package will not, assuming still air in the shade at an ambient temperature of 38 °C (100 °F), exceed either—

(1) 50 °C (122 °F) in other than an exclusive use shipment; or

(2) 85 °C (185 °F) in an exclusive use shipment.

§ 173.443 Contamination control.

(a) The level of non-fixed contamination must be kept as low as reasonably achievable on the external surfaces of each package, conveyance, freight container, and overpack offered for transport, and the internal surfaces of each conveyance, freight container, and overpack in which inner packages or

receptacles of Class 7 (radioactive) materials are offered for transport.

(1) Excluding the interior surfaces of the containment system of packages and the internal surfaces of a conveyance, freight container, tank, or intermediate bulk container dedicated to the transport of unpackaged radioactive material in accordance with §173.427(c) and remaining under that specific exclusive use, the level of non-fixed contamination may not exceed the limits set forth in Table 9 and must be determined by either:

(i) Wiping an area of 300 cm² of the surface concerned with an absorbent material, using moderate pressure, and measuring the activity on the wiping material. Sufficient measurements must be taken in the most appropriate locations to yield a representative assessment of the non-fixed contamination levels. The amount of radioactivity measured on any single wiping material, divided by the surface area wiped and divided by the efficiency of the wipe procedure (the fraction of non-fixed contamination transferred from the surface to the absorbent material), may not exceed the limits set forth in Table 9 at any time during transport. For this purpose the actual wipe efficiency may be used, or the wipe efficiency may be assumed to be 0.10; or

(ii) Alternatively, the level of non-fixed contamination may be determined by using other methods of equal or greater efficiency.

(2) A conveyance used for non-exclusive use shipments is not required to be surveyed unless there is reason to suspect that it may exhibit contamination.

Table 9 is as follows:

TABLE 9—NON-FIXED EXTERNAL RADIOACTIVE CONTAMINATION LIMITS FOR PACKAGES

Contaminant	Maximum permissible limits		
	Bq/cm ²	uCi/cm ²	dpm/cm ²
1. Beta and gamma emitters and low toxicity alpha emitters	4	10 ⁻⁴	240
2. All other alpha emitting radionuclides	0.4	10 ⁻⁵	24

(b) In the case of packages transported as exclusive use shipments by rail or public highway only, except as provided in paragraph (d) of this sec-

tion, at any time during transport the non-fixed contamination on the external surface of any package, as well as on the associated accessible internal

surfaces of any conveyance, overpack, or freight container, may not exceed ten times the levels prescribed in paragraph (a) of this section. The levels at the beginning of transport may not exceed the levels prescribed in paragraph (a) of this section.

(c) Except as provided in paragraphs (a) and (d) of this section, each conveyance, overpack, freight container, tank, or intermediate bulk container used for transporting Class 7 (radioactive) materials as an exclusive use shipment that utilizes the provisions of paragraph (b) of this section, § 173.427(b)(4), or § 173.427(c) must be surveyed with appropriate radiation detection instruments after each exclusive use transport. Except as provided in paragraphs (a) and (d) of this section, these items may not be returned to Class 7 (radioactive) materials exclusive use transport service, and then only for a subsequent exclusive use shipment utilizing one of the above cited provisions, unless the radiation dose rate at each accessible surface is 0.005 mSv per hour (0.5 mrem per hour) or less, and there is no significant non-fixed surface contamination as specified in paragraph (a) of this section. The requirements of this paragraph do not address return to service of items outside of the above cited provisions.

(d) Paragraphs (b) and (c) of this section do not apply to any closed transport vehicle used solely for the exclusive use transportation by highway or rail of Class 7 (radioactive) material with contamination levels that do not exceed ten times the levels prescribed in paragraph (a) of this section if—

(1) A survey of the interior surfaces of the empty vehicle shows that the radiation dose rate at any point does not exceed 0.1 mSv/h (10 mrem/h) at the surface or 0.02 mSv/h (2 mrem/h) at 1 m (3.3 feet) from the surface;

(2) Each vehicle is marked (e.g. stenciled) with the words “For Radioactive Materials Use Only” in letters at least 76 millimeters (3 inches) high in a conspicuous place on both sides of the exterior of the vehicle; and

(3) Each vehicle is kept closed except for loading or unloading; and

(4) Each vehicle is placarded in accordance with subpart F of part 172 of this subchapter.

(e) If it is evident that a package of radioactive material, or conveyance carrying unpackaged radioactive material, is leaking, or if it is suspected that the package, or conveyance carrying unpackaged material, may have leaked, access to the package or conveyance must be restricted and, as soon as possible, the extent of contamination and the resultant radiation level of the package or conveyance must be assessed. The scope of the assessment must include, as applicable, the package, the conveyance, the adjacent loading and unloading areas, and, if necessary, all other material which has been carried in the conveyance. When necessary, additional steps for the protection of persons, property, and the environment must be taken to overcome and minimize the consequences of such leakage. Packages, and conveyances carrying unpackaged material, which are leaking radioactive contents in excess of limits for normal conditions of transport may be removed to an interim location under supervision, but must not be forwarded until repaired or reconditioned and decontaminated, or as approved by the Associate Administrator.

[79 FR 40616, July 11, 2014]

§ 173.447 Storage incident to transportation—general requirements.

The following requirements apply to temporary storage during the course of transportation but not to Nuclear Regulatory Commission or Agreement State-licensed facilities or U.S. Government-owned or contracted facilities.

(a) The number of packages and overpacks bearing FISSILE labels stored in any one storage area, such as a transit area, terminal building, storeroom, waterfront pier, or assembly yard, must be limited so that the total sum of the criticality safety indices in any individual group of such packages and overpacks does not exceed 50. Groups of such packages and overpacks must be stored so as to maintain a spacing of at least 6 m (20 feet) from all other groups of such packages and overpacks.

(b) Storage requirements for Class 7 (radioactive) material transported in

vessels are described in subpart M of part 176 of this subchapter.

[Amdt. 173-244, 60 FR 50307, Sept. 28, 1995, as amended by 66 FR 45380, Aug. 28, 2001; 69 FR 3691, Jan. 26, 2004]

§ 173.448 General transportation requirements.

(a) Each shipment of Class 7 (radioactive) materials must be secured to prevent shifting during normal transportation conditions.

(b) Except as provided in §§ 174.81, 176.83, and 177.848 of this subchapter, or as otherwise required by the Competent Authority in the applicable certificate, a package or overpack of Class 7 (radioactive) materials may be carried among packaged general cargo without special stowage provisions, if—

(1) The heat output in watts does not exceed 0.1 times the minimum package dimension in centimeters; or

(2) The average surface heat flux of the package or overpack does not exceed 15 watts per square meter and the immediately surrounding cargo is not in sacks or bags or otherwise in a form that would seriously impede air circulation for heat removal.

(c) Packages or overpacks bearing labels prescribed in § 172.403 of this subchapter may not be carried in compartments occupied by passengers, except in those compartments exclusively reserved for couriers accompanying those packages.

(d) Mixing of different kinds of packages that include fissile packages is authorized only in accordance with § 173.459.

(e) No person shall offer for transportation or transport aboard a passenger-carrying aircraft any single package or overpack with a transport index greater than 3.0.

(f) No person shall offer for transportation or transport aboard a passenger-carrying aircraft any Class 7 (radioactive) material unless that material is intended for use in, or incident to, research, medical diagnosis or treatment.

(g) If an overpack is used to consolidate individual packages or to enclose a single package of Class 7 (radioactive) materials, the package(s) must comply with the packaging, marking, and labeling requirements of this subchapter, and:

(1) The overpack must be labeled as prescribed in § 172.403(h) of this subchapter;

(2) The overpack must be marked as prescribed in subpart D of part 172 of this subchapter and § 173.25(a); and

(3) The transport index of the overpack may not exceed 3.0 for passenger-carrying aircraft shipments, or 10.0 for cargo-aircraft shipments.

[69 FR 3691, Jan. 26, 2004]

§ 173.453 Fissile materials—exceptions.

Fissile materials meeting the requirements of at least one of the paragraphs (a) through (f) of this section are excepted from the requirements of this subpart for fissile materials, including the requirements of §§ 173.457 and 173.459, but are subject to all other requirements of this subpart, except as noted.

(a) An individual package containing 2 grams or less of fissile material.

(b) An individual or bulk packaging containing 15 grams or less of fissile material provided the package has at least 200 grams of solid nonfissile material for every gram of fissile material. Lead, beryllium, graphite, and hydrogenous material enriched in deuterium may be present in the package but must not be included in determining the required mass for solid nonfissile material.

(c) Low concentrations of solid fissile material commingled with solid nonfissile material, provide that:

(1) There is at least 2000 grams of nonfissile material for every gram of fissile material, and

(2) There is no more than 180 grams of fissile material distributed within 360 kg of contiguous nonfissile material. Lead, beryllium, graphite, and hydrogenous material enriched in deuterium may be present in the package but must not be included in determining the required mass of solid nonfissile material.

(d) Uranium enriched in uranium-235 to a maximum of 1 percent by weight, and with total plutonium and uranium-233 content of up to 1 percent of the mass of uranium-235, provided that the mass of any beryllium, graphite, and hydrogenous material enriched in deuterium constitute less than 5 percent of the uranium mass.

§ 173.457

(e) Liquid solutions of uranyl nitrate enriched in uranium-235 to a maximum of 2 percent by mass, with a total plutonium and uranium-233 content not exceeding 0.002 percent of the mass of uranium, and with a minimum nitrogen to uranium atomic ratio (N/U) of 2. The material must be contained in at least a DOT Type A package.

(f) Packages containing, individually, a total plutonium mass of not more than 1000 grams, of which not more than 20 percent by mass may consist of plutonium-239, plutonium-241, or any combination of these radionuclides.

[69 FR 3692, Jan. 26, 2004]

§ 173.457 Transportation of fissile material packages—specific requirements.

(a) Packages containing fissile radioactive material which are not excepted under § 173.453 must be assigned by the offeror, in accordance with their definitions in § 173.403, a criticality safety index (CSI) and a transport index (TI).

(b) Fissile material packages and conveyances transporting fissile material packages must satisfy the radiation level restrictions of § 173.441.

(c) Except for consignments under exclusive use, the CSI of any package or overpack may not exceed 50. A fissile material package with CSI greater than 50 must be transported by exclusive use.

(d) For non-exclusive use shipments of fissile material packages, except on vessels, the total sum of CSI's in a freight container or on a conveyance may not exceed 50.

(e) For exclusive use shipments of fissile material packages, except on vessels, the total sum of CSI's in a freight container or on a conveyance may not exceed 100.

(f) Exclusive use shipments of fissile material packages must satisfy the radiation level and administrative requirements of § 173.441(b).

(g) The number of packages, overpacks and freight containers containing fissile material stored in transit in any one storage area must be so limited that the total sum of the CSI's in any group of packages, overpacks or freight containers does not exceed 50. Groups of packages shall be stored so as to maintain a spacing of at least 6 m

49 CFR Ch. I (10–1–14 Edition)

(20 ft) between the closest surfaces of any two groups.

(h) Provisions for shipment by vessel of Class 7 (radioactive) material packages, including fissile material packages by vessel are described in §§ 176.700–176.720 of this subchapter.

[69 FR 3692, Jan. 26, 2004]

§ 173.459 Mixing of fissile material packages with non-fissile or fissile-excepted material packages.

Mixing of fissile material packages with other types of Class 7 (radioactive) materials in any conveyance or storage location is authorized only if the TI of any single package does not exceed 10, the CSI of any single package does not exceed 50, and the provisions of §§ 173.441 and 173.457 are satisfied.

[69 FR 3692, Jan. 26, 2004]

§ 173.461 Demonstration of compliance with tests.

(a) Compliance with the design requirements in § 173.412 and the test requirements in §§ 173.465 through 173.469 must be shown by any of the methods prescribed in this paragraph, or by a combination of these methods appropriate for the particular feature being evaluated:

(1) Performance of tests with prototypes or samples of the specimens representing LSA-III, special form Class 7 (radioactive) material, or packaging, in which case the contents of the packaging for the test must simulate as closely as practicable the expected range of physical properties of the radioactive contents or packaging to be tested, must be prepared as normally presented for transport. The use of non-radioactive substitute contents is encouraged provided that the results of the testing take into account the radioactive characteristics of the contents for which the package is being tested;

(2) Reference to a previous, satisfactory demonstration of compliance of a sufficiently similar nature;

(3) Performance of tests with models of appropriate scale incorporating those features that are significant with respect to the item under investigation, when engineering experience has

shown results of those tests to be suitable for design purposes. When a scale model is used, the need for adjusting certain test parameters, such as the penetrator diameter or the compressive load, must be taken into account; or

(4) Calculations or reasoned evaluation, using reliable and conservative procedures and parameters.

(b) With respect to the initial conditions for the tests under §§173.465 through 173.469, except for the water immersion tests, compliance must be based upon the assumption that the package is in equilibrium at an ambient temperature of 38 °C (100 °F).

[Amdt. 173-244, 60 FR 50307, Sept. 28, 1995, as amended by 63 FR 52850, Oct. 1, 1998]

§ 173.462 Preparation of specimens for testing.

(a) Each specimen (i.e., sample, prototype or scale model) must be examined before testing to identify and record faults or damage, including:

- (1) Divergence from the specifications or drawings;
- (2) Defects in construction;
- (3) Corrosion or other deterioration; and
- (4) Distortion of features.

(b) Any deviation found under paragraph (a) of this section from the specified design must be corrected or appropriately taken into account in the subsequent evaluation.

(c) The containment system of the packaging must be clearly specified.

(d) The external features of the specimen must be clearly identified so that reference may be made to any part of it.

§ 173.465 Type A packaging tests.

(a) The packaging, with contents, must be capable of withstanding the water spray, free drop, stacking and penetration tests prescribed in this section. One prototype may be used for all tests if the requirements of paragraph (b) of this section are met. The tests are successful if the requirements of §173.412(j) are met.

(b) *Water spray test.* The water spray test must precede each test or test sequence prescribed in this section. The water spray test must simulate exposure to rainfall of approximately 5 cm

(2 inches) per hour for at least one hour. The time interval between the end of the water spray test and the beginning of the next test must be such that the water has soaked in to the maximum extent without appreciable drying of the exterior of the specimen. In the absence of evidence to the contrary, this interval may be assumed to be two hours if the water spray is applied from four different directions simultaneously. However, no time interval may elapse if the water spray is applied from each of the four directions consecutively.

(c) *Free drop test.* The specimen must drop onto the target so as to suffer maximum damage to the safety features being tested, and:

(1) The height of the drop measured from the lowest point of the specimen to the upper surface of the target may not be less than the distance specified in table 10, for the applicable package mass. The target must be as specified in §173.465(c)(5). Table 10 is as follows:

TABLE 10—FREE DROP DISTANCE FOR TESTING PACKAGES TO NORMAL CONDITIONS OF TRANSPORT

Package mass	Free drop distance	
	Meters	(Feet)
<Mass 5000 (11,000)	1.2	(4)
5,000 (11,000) Mass to 10,000 (22,000)	0.9	(3)
10,000 (22,000) Mass to 15,000 (33,000)	0.6	(2)
>15,000 (33,000) Mass	0.3	(1)

(2) For packages containing fissile material, the free drop test specified in paragraph (c)(1) of this section must be preceded by a free drop from a height of 0.3 m (1 foot) on each corner, or in the case of cylindrical packages, onto each of the quarters of each rim.

(3) For fiberboard or wood rectangular packages with a mass of 50 kg (110 pounds) or less, a separate specimen must be subjected to a free drop onto each corner from a height of 0.3 m (1 foot).

(4) For cylindrical fiberboard packages with a mass of 100 kg (220 pounds) or less, a separate specimen must be subjected to a free drop onto each of the quarters of each rim from a height of 0.3 m (1 foot).

(5) The target for the free drop test must be a flat, horizontal surface of

§ 173.466

such mass and rigidity that any increase in its resistance to displacement or deformation upon impact by the specimen would not significantly increase the damage to the specimen.

(d) *Stacking test.* (1) The specimen must be subjected for a period of at least 24 hours to a compressive load equivalent to the greater of the following:

(i) A total weight equal to five times the maximum weight of the package; or

(ii) The equivalent of 13 kilopascals (1.9 psi) multiplied by the vertically projected area of the package.

(2) The compressive load must be applied uniformly to two opposite sides of the specimen, one of which must be the base on which the package would normally rest.

(e) *Penetration test.* For the penetration test, the specimen must be placed on a rigid, flat, horizontal surface that will not move significantly while the test is being performed.

(1) A bar of 3.2 cm (1.25 inches) in diameter with a hemispherical end and a mass of 6 kg (13.2 pounds) must be dropped and directed to fall with its longitudinal axis vertical, onto the center of the weakest part of the specimen, so that, if it penetrates far enough, it will hit the containment system. The bar may not be significantly deformed by the test; and

(2) The height of the drop of the bar measured from its lower end to the intended point of impact on the upper surface of the specimen must be 1 m (3.3 feet) or greater.

[Amdt. 173-244, 60 FR 50307, Sept. 28, 1995, as amended by Amdt. 173-244, 61 FR 20753, May 8, 1996; 66 FR 45380, Aug. 28, 2001; 69 FR 3692, Jan. 26, 2004; 70 FR 56099, Sept. 23, 2005; 79 FR 40617, July 11, 2014]

§ 173.466 Additional tests for Type A packagings designed for liquids and gases.

(a) In addition to the tests prescribed in § 173.465, Type A packagings designed for liquids and gases must be capable of withstanding the following tests in this section. The tests are successful if the requirements of § 173.412(k) are met.

49 CFR Ch. I (10-1-14 Edition)

(b) [Reserved]

[Amdt. 173-244, 60 FR 50307, Sept. 28, 1995, as amended at 66 FR 45380, Aug. 28, 2001; 79 FR 40617, July 11, 2014]

§ 173.467 Tests for demonstrating the ability of Type B and fissile materials packagings to withstand accident conditions in transportation.

Each Type B packaging or packaging for fissile material must meet the test requirements prescribed in 10 CFR part 71 for ability to withstand accident conditions in transportation.

§ 173.468 Test for LSA-III material.

(a) LSA-III Class 7 (radioactive) material must meet the test requirement of paragraph (b) of this section. Any differences between the material to be transported and the test material must be taken into account in determining whether the test requirements have been met.

(b) *Test method.* (1) The specimen representing no less than the entire contents of the package must be immersed for 7 days in water at ambient temperature.

(2) The volume of water to be used in the test must be sufficient to ensure that at the end of the test period the free volume of the unabsorbed and unreacted water remaining will be at least 10% of the volume of the specimen itself.

(3) The water must have an initial pH of 6-8 and a maximum conductivity of 10 micromho/cm at 20 °C (68 °F).

(4) The total activity of the free volume of water must be measured following the 7 day immersion test and must not exceed 0.1 A₂.

§ 173.469 Tests for special form Class 7 (radioactive) materials.

(a) Special form Class 7 (radioactive) materials must meet the test requirements of paragraph (b) of this section. Each solid Class 7 (radioactive) material or capsule specimen to be tested must be manufactured or fabricated so that it is representative of the actual solid material or capsule that will be transported with the proposed radioactive content duplicated as closely as practicable. Any differences between the material to be transported and the test material, such as the use of non-

radioactive contents, must be taken into account in determining whether the test requirements have been met. The following additional conditions apply:

(1) A different specimen may be used for each of the tests;

(2) The specimen may not break or shatter when subjected to the impact, percussion, or bending tests;

(3) The specimen may not melt or disperse when subjected to the heat test; and

(4) After each test, leaktightness or indispersibility of the specimen must be determined by—

(i) A method no less sensitive than the leaching assessment prescribed in paragraph (c) of this section. For a capsule resistant to corrosion by water, and which has an internal void volume greater than 0.1 milliliter, an alternative to the leaching assessment is a demonstration of leaktightness of 10^{-4} torr-l/s (1.3×10^{-4} atm-cm³/s) based on air at 25 °C (77 °F) and one atmosphere differential pressure for solid radioactive content, or 10^{-6} torr-l/s (1.3×10^{-6} atm-cm³/s) for liquid or gaseous radioactive content; or

(ii) A specimen that comprises or simulates Class 7 (radioactive) material contained in a sealed capsule need not be subjected to the leaching assessment specified in paragraph (c) of this section provided it is alternatively subjected to any of the volumetric leakage assessment tests prescribed in the International Organization for Standardization document ISO 9978-1992(E): "Radiation protection—Sealed radioactive sources—Leakage test methods" (IBR, see § 171.7 of this subchapter).

(b) *Test methods*—(1) *Impact Test*. The specimen must fall onto the target from a height of 9 m (30 feet) or greater. The target must be as specified in § 173.465(c)(5).

(2) *Percussion Test*. (i) The specimen must be placed on a sheet of lead that is supported by a smooth solid surface, and struck by the flat face of a steel billet so as to produce an impact equivalent to that resulting from a free drop of 1.4 kg (3 pounds) through 1 m (3.3 feet).

(ii) The flat face of the billet must be 2.5 cm (1 inch) in diameter with the

edge rounded off to a radius of 3 mm \pm 0.3 mm (0.12 inch \pm 0.012 inch).

(iii) The lead must be of hardness number 3.5 to 4.5 on the Vickers scale and thickness not more than 25 mm (1 inch), and must cover an area greater than that covered by the specimen.

(iv) A fresh surface of lead must be used for each impact.

(v) The billet must strike the specimen so as to cause maximum damage.

(3) *Bending test*. (i) This test applies only to long, slender sources with a length of 10 cm (4 inches) or greater and a length to width ratio of 10 or greater.

(ii) The specimen must be rigidly clamped in a horizontal position so that one half of its length protrudes from the face of the clamp.

(iii) The orientation of the specimen must be such that the specimen will suffer maximum damage when its free end is struck by the flat face of a steel billet.

(iv) The billet must strike the specimen so as to produce an impact equivalent to that resulting from a free vertical drop of 1.4 kg (3 pounds) through 1 m (3.3 feet).

(v) The flat face of the billet must be 2.5 cm (1 inch) in diameter with the edges rounded off to a radius of 3 mm \pm 0.3 mm (.12 inch \pm 0.012 inch).

(4) *Heat test*. The specimen must be heated in air to a temperature of not less than 800 °C (1475 °F), held at that temperature for a period of 10 minutes, and then allowed to cool.

(c) *Leaching assessment methods*. (1) For indispersible solid material—

(i) The specimen shall be immersed for seven days in water at ambient temperature. The volume of water to be used in the test shall be sufficient to ensure that at the end of the seven day test period the free volume of the unabsorbed and unreacted water remaining shall be at least 10% of the volume of the solid test sample itself. The water shall have an initial pH of 6–8 and a maximum conductivity of 1 mS/m (10 micromho/cm) at 20 °C (68 °F).

(ii) The water with specimen must then be heated to a temperature of 50 °C \pm 5° (122 °F \pm 9°) and maintained at this temperature for four hours.

(iii) The activity of the water must then be determined.

(iv) The specimen shall then be kept for at least seven days in still air at not less than 30 °C (86 °F) and relative humidity not less than 90%.

(v) The specimen must then be immersed in water under the same conditions as in paragraph (c)(1)(i) of this section, and the water with specimen must be heated to 50 C ±5° (122 °F ±9°) and maintained at that temperature for four hours.

(vi) The activity of the water must then be determined. The activities determined in paragraph (c)(1)(iii) of this section and this paragraph, (c)(1)(vi), may not exceed 2 kilobecquerels (0.05 microcurie).

(2) For encapsulated material—

(i) The specimen shall be immersed in water at ambient temperature. The water shall have an initial pH of 6–8 and a maximum conductivity of 1 mS/m (10 micromho/cm) at 20 °C (68 °F).

(ii) The water and specimen must be heated to a temperature of 50 °C ±5° (122 °F ±9°) and maintained at this temperature for four hours.

(iii) The activity of the water must then be determined.

(iv) The specimen shall then be kept for at least seven days in still air at not less than 30 °C (86 °F) and relative humidity not less than 90%.

(v) The process in paragraphs (c)(2)(i), (c)(2)(ii), and (c)(2)(iii) of this section must be repeated.

(vi) The activity determined in paragraph (c)(2)(iii) of this section may not exceed 2 kilobecquerels (0.05 microcurie).

(d) A specimen that comprises or simulates Class 7 (radioactive) material contained in a sealed capsule need not be subjected to—

(1) The impact test and the percussion test of this section provided that the mass of the special form material is—

(i) Less than 200 g and it is alternatively subjected to the Class 4 impact test prescribed in ISO 2919 (IBR, see §171.7 of this subchapter), or

(ii) Less than 500 g and it is alternatively subjected to the Class 5 impact test prescribed in ISO 2919 (IBR, see §171.7 of this subchapter); and

(2) The heat test of this section, provided the specimen is alternatively subjected to the Class 6 temperature

test specified in the International Organization for Standardization document ISO 2919 (IBR, see §171.7 of this subchapter).

(e) Special form materials that were successfully tested prior to October 1, 2014 in accordance with the requirements of paragraph (d) of this section in effect prior to October 1, 2014 may continue to be offered for transportation and transported without additional testing under this section.

[Amdt. 173–244, 60 FR 50307, Sept. 28, 1995, as amended at 63 FR 37461, July 10, 1998; 64 FR 51919, Sept. 27, 1999; 66 FR 45184, 45380, 45381, Aug. 28, 2001; 68 FR 75742, 75747, Dec. 31, 2003; 69 FR 3692, Jan. 26, 2004; 79 FR 40617, July 11, 2014]

§ 173.471 Requirements for U.S. Nuclear Regulatory Commission approved packages.

In addition to the applicable requirements of the U.S. Nuclear Regulatory Commission (NRC) and other requirements of this subchapter, any offeror of a Type B(U), Type B(M), or fissile material package that has been approved by the NRC in accordance with 10 CFR part 71 must also comply with the following requirements:

(a) The offeror shall be registered with the USNRC as a party to the packaging approval, and make the shipment in compliance with the terms of the packaging approval;

(b) The outside of each package must be durably and legibly marked with the package identification marking indicated in the USNRC packaging approval;

(c) Each shipping paper related to the shipment of the package must bear the package identification marking indicated in the USNRC packaging approval;

(d) Before export shipment of the package, the offeror shall obtain a U.S. Competent Authority Certificate for that package design, or if one has already been issued, the offeror shall register in writing (including a description of the quality assurance program required by 10 CFR part 71) with the U.S. Competent Authority as a user of the certificate. (NOTE: The person who originally applies for a U.S. Competent Authority Certificate will be registered

automatically.) The registration request must be sent to the Associate Administrator for Hazardous Materials Safety (PHH-23), Department of Transportation, East Building, 1200 New Jersey Avenue, SE., Washington DC 20590-0001. Alternatively, the application with any attached supporting documentation in an appropriate format may be submitted by facsimile (fax) to (202) 366-3753 or (202) 366-3650, or by electronic mail (e-mail) to "ramcert@dot.gov." Upon registration, the offeror will be furnished with a copy of the certificate. The offeror shall then submit a copy of the U.S. Competent Authority Certificate applying to that package design to the national competent authority of each country into or through which the package will be transported, unless the offeror has documentary evidence that a copy has already been furnished; and

(e) Each request for a U.S. Competent Authority Certificate as required by the IAEA regulations must be submitted in writing to the Associate Administrator. The request must be in triplicate and include copies of the applicable USNRC packaging approval, USNRC Quality Assurance Program approval number, and a reproducible 22 cm × 30 cm (8.5" × 11") drawing showing the make-up of the package. The request and accompanying documentation must be sent to the Associate Administrator for Hazardous Materials Safety (PHH-23), Department of Transportation, East Building, 1200 New Jersey Avenue, SE., Washington DC 20590-0001. Alternatively, the application with any attached supporting documentation in an appropriate format may be submitted by facsimile (fax) to (202) 366-3753 or (202) 366-3650, or by electronic mail (e-mail) to "ramcert@dot.gov." Each request is considered in the order in which it is received. To allow sufficient time for consideration, requests must be received at least 90 days before the requested effective date.

[Amdt. 173-244, 60 FR 50307, Sept. 28, 1995, as amended at 66 FR 45379, Aug. 28, 2001; 67 FR 61014, Sept. 27, 2002; 69 FR 3693, Jan. 26, 2004; 70 FR 56099, Sept. 23, 2005; 72 FR 55693, Oct. 1, 2007]

§ 173.472 Requirements for exporting DOT Specification Type B and fissile packages.

(a) Any offeror who exports a DOT Specification Type B or fissile material package authorized by §173.416 or §173.417 shall comply with paragraphs (b) through (f) of this section.

(b) The shipment must be made in accordance with the conditions of the U.S. Certificate of Competent Authority.

(c) The outside of each package must be durably and legibly marked with the package identification marking indicated in the U.S. Competent Authority Certificate.

(d) Each shipping paper related to the shipment of the package must bear the package identification marking indicated in the U.S. Competent Authority Certificate.

(e) Before export of the package, the offeror shall obtain a U.S. Competent Authority Certificate for that package design, or if one has already been issued, the offeror shall register in writing (including a description of the quality assurance program required by 10 CFR part 71, subpart H, or 49 CFR 173.474 and 173.475) with the U.S. Competent Authority as a user of the certificate. Upon registration, the offeror will be furnished with a copy of the certificate. The offeror shall then submit a copy of the U.S. Competent Authority Certificate applying to that package design to the national competent authority of each country into or through which the package will be transported, unless the offeror has documentary evidence that a copy has already been furnished.

(f) Each request for a U.S. Competent Authority Certificate as required by the IAEA regulations must be submitted in writing to the Associate Administrator. The request must be in triplicate and must include a description of the quality assurance program required by 10 CFR part 71, subpart H, or 49 CFR 173.474 and 173.475, and a reproducible 22 cm × 30 cm (8.5" × 11") drawing showing the make-up of the package. A copy of the USNRC quality assurance program approval will satisfy the requirement for describing the

§ 173.473

quality assurance program. The request and accompanying documentation may be sent by mail or other delivery service. Alternatively, the request with any attached supporting documentation submitted in an appropriate format may be sent by facsimile (fax) to (202) 366-3753 or (202) 366-3650, or by electronic mail (e-mail) to “ramcert@dot.gov.” Each request is considered in the order in which it is received. To allow sufficient time for consideration, requests must be received at least 90 days before the requested effective date.

[Amdt. 173-244, 60 FR 50307, Sept. 28, 1995, as amended at 66 FR 45379, Aug. 28, 2001; 67 FR 61014, Sept. 27, 2002]

§ 173.473 Requirements for foreign-made packages.

In addition to other applicable requirements of this subchapter, each offeror of a foreign-made Type B(U), Type B(M), Type C, Type CF, Type H(U), Type H(M), or fissile material package for which a Competent Authority Certificate is required by IAEA’s “Regulations for the Safe Transport of Radioactive Material, No. TS-R-1,” (IBR, see §171.7 of this subchapter) shall also comply with the following requirements:

(a) Prior to the shipment of such a package of Class 7 (radioactive) materials into or from the U.S., the offeror shall—

(1) Have the foreign competent authority certificate revalidated by the U.S. Competent Authority, unless this has been done previously. Each request for revalidation must be in triplicate, contain all the information required by Section VIII of the IAEA regulations in “IAEA Regulations for the Safe Transport of Radioactive Material, No. TS-R-1” (IBR, see §171.7 of this subchapter), and include a copy in English of the foreign competent authority certificate. The request and accompanying documentation must be sent to the Associate Administrator for Hazardous Materials Safety (PHH-23), Department of Transportation, East Building, 1200 New Jersey Avenue SE., Washington, DC 20590-0001. Alternatively, the request with any attached supporting documentation submitted in an appropriate format may be sent by facsimile

49 CFR Ch. I (10-1-14 Edition)

(fax) to (202) 366-3753 or (202) 366-3650, or by electronic mail to “ramcert@dot.gov.” Each request is considered in the order in which it is received. To allow sufficient time for consideration, requests must be received at least 90 days before the requested effective date;

(2) Register in writing with the U.S. Competent Authority as a user of the package covered by the foreign competent authority certificate and its U.S. revalidation. Alternatively, the registration request with any attached supporting documentation submitted in an appropriate format may be sent by facsimile (fax) to (202) 366-3753 or (202) 366-3650, or by electronic mail (e-mail) to “ramcert@dot.gov.” If the offeror is requesting the revalidation, registration is automatic; and

(3) Supply to the carrier, upon request, the applicable competent authority certificates. However, the competent authority certificates are not required to accompany the packages to which they apply.

(b) The outside of each package must be durably and legibly marked with the competent authority identification marking indicated on the Competent Authority Certificate and revalidation.

(c) Each shipping paper for a shipment of Class 7 (radioactive) materials must bear a notation of the package identification marking indicated on the competent authority certificate or revalidation.

(d) All requirements of the foreign competent authority certificate and the U.S. Competent Authority revalidation must be fulfilled.

[Amdt. 173-244, 60 FR 50307, Sept. 28, 1995, as amended at 66 FR 45379, Aug. 28, 2001; 67 FR 16015, Sept. 27, 2002; 68 FR 75742, 75747, Dec. 31, 2003; 69 FR 3693, Jan. 26, 2004; 79 FR 40617, July 11, 2014]

§ 173.474 Quality control for construction of packaging.

Prior to the first use of any packaging for the shipment of Class 7 (radioactive) material, the offeror shall determine that—

(a) The packaging meets the quality of design and construction requirements as specified in this subchapter; and

(b) The effectiveness of the shielding, containment and, when required, the heat transfer characteristics of the package, are within the limits specified for the package design.

§ 173.475 Quality control requirements prior to each shipment of Class 7 (radioactive) materials.

Before each shipment of any Class 7 (radioactive) materials package, the offeror must ensure, by examination or appropriate tests, that—

(a) The packaging is proper for the contents to be shipped;

(b) The packaging is in unimpaired physical condition, except for superficial marks;

(c) Each closure device of the packaging, including any required gasket, is properly installed, secured, and free of defects;

(d) For fissile material, each moderator and neutron absorber, if required, is present and in proper condition;

(e) Each special instruction for filling, closing, and preparation of the packaging for shipment has been followed;

(f) Each closure, valve, or other opening of the containment system through which the radioactive content might escape is properly closed and sealed;

(g) Each packaging containing liquid in excess of an A₂ quantity and intended for air shipment has been tested to show that it will not leak under an ambient atmospheric pressure of not more than 25 kPa, absolute (3.6 psia). The test must be conducted on the entire containment system, or on any receptacle or vessel within the containment system, to determine compliance with this requirement;

(h) The internal pressure of the containment system will not exceed the design pressure during transportation; and

(i) External radiation and contamination levels are within the allowable limits specified in this subchapter.

§ 173.476 Approval of special form Class 7 (radioactive) materials.

(a) Each offeror of special form Class 7 (radioactive) materials must maintain on file for at least two years after the offeror's latest shipment, and provide to the Associate Administrator on

request, a complete safety analysis, including documentation of any tests, demonstrating that the special form material meets the requirements of § 173.469. An IAEA Certificate of Competent Authority issued for the special form material may be used to satisfy this requirement.

(b) Prior to the first export shipment of a special form Class 7 (radioactive) material from the United States, each offeror shall obtain a U.S. Competent Authority Certificate for the specific material. For special form material manufactured outside the United States, an IAEA Certificate of Competent Authority from the country of origin may be used to meet this requirement.

(c) Each request for a U.S. Competent Authority Certificate as required by the IAEA regulations must be submitted in writing, in triplicate, by mail or other delivery service to the Associate Administrator. Alternatively, the request with any attached supporting documentation submitted in an appropriate format may be sent by facsimile (fax) to (202) 366-3753 or (202) 366-3650, or by electronic mail (e-mail) to "ramcert@dot.gov.". Each request is considered in the order in which it is received. To allow sufficient time for consideration, requests must be received at least 90 days before the requested effective date. Each petition for a U.S. Competent Authority Certificate must include the following information:

(1) A detailed description of the material, or if a capsule, a detailed description of the contents. Particular reference must be made to both physical and chemical states;

(2) A detailed statement of the capsule design and dimensions, including complete engineering drawings [22cm × 30cm (8½ inches × 11 inches)] and schedules of material, and methods of construction;

(3) A statement of the tests that have been made and their results; or evidence based on calculative methods to show that the material is able to pass the tests; or other evidence that the special form Class 7 (radioactive) material complies with § 173.469;

(4) For the original request for a Competent Authority Certificate, evidence of a quality assurance program based on international, national or other standards, for the design, manufacture, testing, documentation, use, maintenance and inspection, as appropriate, of all special form material offered for transport by the requester; and

(5) A description of any proposed pre-shipment actions, such as leak testing, for use in the consignment of special form radioactive material for transport.

(d) Paragraphs (a) and (b) of this section do not apply in those cases where A_1 equals A_2 and the material is not required to be described on the shipping papers as “Radioactive Material, Type A Package, Special Form” or as “Radioactive Material, Type A Package, Special Form, Fissile.”

[Amdt. 173–244, 60 FR 50307, Sept. 28, 1995, as amended at 66 FR 45379, Aug. 28, 2001; 67 FR 61015, Sept. 27, 2002; 69 FR 3693, Jan. 26, 2004; 78 FR 60754, Oct. 2, 2013; 79 FR 40617, July 11, 2014]

§ 173.477 Approval of packagings containing greater than 0.1 kg of non-fissile or fissile-excepted uranium hexafluoride.

(a) Each offeror of a package containing more than 0.1 kg of uranium hexafluoride must maintain on file for at least two years after the offeror’s latest shipment, and provide to the Associate Administrator on request, a complete safety analysis, including documentation of any tests, demonstrating that the package meets the requirements of § 173.420. An IAEA Certificate of Competent Authority issued for the design of the packaging containing greater than 0.1 kg of non-fissile or fissile-exempted uranium hexafluoride may be used to satisfy this requirement.

(b) Prior to the first export shipment of a package containing greater than 0.1 kg of uranium hexafluoride from the United States, each offeror shall obtain a U.S. Competent Authority Certificate for the packaging design. For packagings manufactured outside the United States, each offeror shall comply with § 173.473.

(c) Each request for a U.S. Competent Authority Certificate as required by the IAEA regulations must be submitted in writing, in triplicate, by mail or other delivery service to the Associate Administrator. Alternatively, the request with any attached supporting documentation submitted in an appropriate format may be sent by facsimile (fax) to (202) 366–3753 or (202) 366–3650, or by electronic mail (e-mail) to *ramcert@dot.gov*. Each request is considered in the order in which it is received. To allow sufficient time for consideration, requests must be received at least 90 days before the requested effective date. Each request for a U.S. Competent Authority Certificate must include the following information:

(1) A safety analysis report which, at a minimum, provides a detailed description of the packaging and contents; a description of the manufacturing process used for the packaging; and details of the tests conducted and copy of their results, evidence based on calculative methods to show that the package is able to pass the tests, or other evidence that the package complies with § 173.420; and

(2) For the original request for a Competent Authority Certificate, evidence of a quality assurance program.

[69 FR 3693, Jan. 26, 2004, as amended at 79 FR 40617, July 11, 2014]

Subparts J–O [Reserved]

APPENDIX A TO PART 173 [RESERVED]

APPENDIX B TO PART 173—PROCEDURE FOR TESTING CHEMICAL COMPATIBILITY AND RATE OF PERMEATION IN PLASTIC PACKAGING AND RECEPTACLES

1. The purpose of this procedure is to determine the chemical compatibility and permeability of liquid hazardous materials packaged in plastic packaging and receptacles. Alternatives for this procedure are permitted as specified in § 173.24(e)(3)(iii) of this subchapter.

2. Compatibility and rate of permeation are determined by subjecting full size plastic containers (or smaller containers as permitted in paragraph 4 of this appendix) and hazardous material lading to one of the following combinations of time and temperature:

a. Test Method 1: 180 days at a temperature no lower than 18 °C. (64 °F.)

b. Test Method 2: 28 days at a temperature no lower than 50 °C. (122 °F.)

c. Test Method 3: 14 days at a temperature no lower than 60 °C. (140 °F.)

3. Regardless of which test method is used, at least three sample containers shall be tested for each combination of hazardous material and size and design of container. Fill containers to rated capacity with the specific hazardous material (at the concentration to be transported) and close as for shipment. For the first and last 24 hours of storage under the selected test method, place the containers with closures downward, except that containers fitted with a vent are so placed on each occasion for five minutes only.

4. For testing under Test Method 2 or 3 in those instances where it is not practicable to use full size containers, smaller containers may be used. The small container shall be manufactured by the same process as the larger container (for example, using the same method of molding and processing temperatures) and be made of identical resins, pigments and additives.

5. Determine filled container weight or net weight of contents both before and after storage under the selected test method. Rate of permeation is determined from loss of hazardous materials contents, during the conduct of the test, expressed as a percentage of the original weight.

6. After storage under the selected test method, the container shall be drained, rinsed, filled to rated capacity with water and, with filled container at ambient temperature, dropped from a height determined in accordance with §178.603(e) of this subchapter onto a rigid non-resilient, flat and horizontal surface.

7. Each of the following constitute test failure:

a. Visible evidence of permanent deformation due to vapor pressure build-up or collapse of walls, deterioration, swelling, crazing, cracking, excessive corrosion, oxidization, embrittlement, leakage, rupture or other defects likely to cause premature failure or a hazardous condition.

b. For materials meeting the definition of a poison according to this subchapter, a rate of permeation in excess of 0.5% determined over the test period. For all other hazardous materials, a rate of permeation in excess of 2.0% determined over the test period.

[Amdt. 173-176, 49 FR 24691, June 14, 1984, as amended by Amdt. 173-224, 55 FR 52670 Dec. 21, 1990; 56 FR 66279, Dec. 20, 1991; Amdt. 173-234, 58 FR 51533, Oct. 1, 1993; 66 FR 45379, Aug. 28, 2001]

APPENDIX C TO PART 173—PROCEDURE FOR BASE-LEVEL VIBRATION TESTING

Base-level vibration testing shall be conducted as follows:

1. Three sample packagings, selected at random, must be filled and closed as for shipment. A non-hazardous material may be used in place of the hazardous material if it has essentially the same physical characteristics.

2. The three packages must be placed on a vibrating platform that has a vertical double-amplitude (peak-to-peak displacement) of one inch. The packages should be constrained horizontally to prevent them from falling off the platform, but must be left free to move vertically, bounce and rotate.

3. The test must be performed continuously for one hour at a frequency that causes each package to be raised from the vibrating platform to such a degree that a piece of material of approximately 1.6 mm (0.063 inch) thickness (such as steel strapping or paperboard) can be passed between the bottom of any package and the platform.

4. Immediately following the period of vibration, each package shall be removed from the platform, turned on its side and observed for any evidence of leakage.

5. Rupture or leakage from any of the packages constitutes failure of the test.

[Amdt. 173-224, 55 FR 52671, Dec. 21, 1990]

APPENDIX D TO PART 173—TEST METHODS FOR DYNAMITE (EXPLOSIVE, BLASTING, TYPE A)

1. TEST METHOD D-1—LEAKAGE TEST

A wooden stick, 114 mm (4.5 inches) long and 4.8 mm (0.2 inch) inch in diameter, with a sharpened end is used to punch 5 holes in one end of the wrapper of a dynamite cartridge. A cork stopper is placed on the bottom of a glass volumetric cylinder. The dynamite cartridge is placed, perforated end down, resting on the cork stopper in the cylinder. The entire assembly is placed in an oven at 38 °C (100 °F) for 48 hours and then examined visually for evidence of leakage.

2. TEST METHOD D-2—*Centrifugal Exudation Test*

The test apparatus consists of a glass tube, 135 mm (5.3 inches) long and one inch in diameter, with both ends open, and is assembled in the following manner:

(a) Close the bottom with a plastic plug of diameter equal to the inner diameter of the glass tube;

(b) Place a small amount of absorbent cotton on top of the plug;

(c) Place a plastic disk that matches the inner diameter to the glass tube and has seven small perforations on top of the cotton; and

(d) Place 10 g (0.35 ounce) of the dynamite sample on top of the disk.

The assembled glass tube is then placed in a hand-operated centrifuge and spun for one minute at 600 rpm (revolutions per minute). The dynamite sample is then removed from the glass tube and weighed to determine the percent of weight loss.

3. TEST METHOD D-3—*Compression Exudation Test*

The entire apparatus for this test is shown in Figure 1 of this appendix. The test is conducted using the following procedures:

(a) A glass tube, 135 mm (5.3 inches) long and one inch in diameter, is held on a wooden base;

(b) A small amount of absorbent cotton is placed into the bottom of the glass tube;

(c) Ten g (0.35 ounce) of dynamite sample are placed on top of the cotton in the glass tube;

(d) A small amount of absorbent cotton is placed on top of the dynamite sample;

(e) A plastic disk that matches the inner diameter of the glass tube and has seven small perforations is placed on top of the cotton;

(f) A plastic plug matching the inner diameter of the glass tube is then placed on top of the disk;

(g) The glass tube assembly is placed under the compression rod, and compression is applied by means of the weight on the metal lever rod. The sample is compressed for one minute; and

(h) The dynamite sample is then removed from the glass tube and weighed to determine the percent of weight loss.

**FIGURE 1
COMPRESSION APPARATUS**

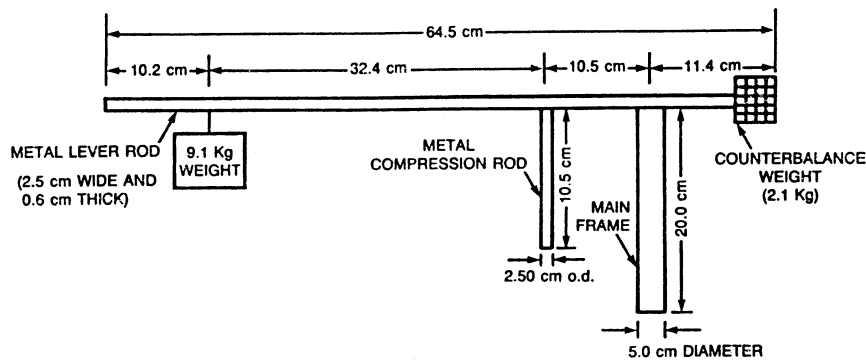

BILLING CODE 4910-60-C

[Amdt. 173-224, 55 FR 52671, Dec. 21, 1990, as amended by Amdt. 173-234, 58 FR 51533, Oct. 1, 1993]

APPENDIXES E-G TO PART 173
[RESERVED]

APPENDIX H TO PART 173—METHOD OF TESTING FOR SUSTAINED COMBUSTIBILITY

1. METHOD

The method describes a procedure for determining if the material when heated under the test conditions and exposed to an exter-

nal source of flame applied in a standard manner sustains combustion.

2. PRINCIPLE OF THE METHOD

A metal block with a concave depression (test portion well) is heated to a specified temperature. A specified volume of the material under test is transferred to the well, and its ability to sustain combustion is

noted after application and subsequent removal of a standard flame under specified conditions.

3. APPARATUS

A combustibility tester consisting of a block of aluminum alloy or other corrosion-resistant metal of high thermal conductivity is used. The block has a concave well and a pocket drilled to take a thermometer. A small gas jet assembly on a swivel is attached to the block. The handle and gas inlet for the gas jet may be fitted at any convenient angle to the gas jet. A suitable apparatus is shown in Figure 32.5.2.1 of the UN Manual of Test and Criteria (IBR, see (171.7 of this subchapter), and the essential dimensions are given in Figures 32.5.2.1 and 32.5.2.2 of the UN Manual and Tests and Criteria. The following equipment is needed:

(a) *Gauge*, for checking that the height of the center of the gas jet above the top of the test portion well is 2.2 mm (see Figure 32.5.2.1);

(b) *Thermometer*, mercury in glass, for horizontal operation, with a sensitivity not less than 1 mm/°C, or other measuring device of equivalent sensitivity permitting reading at 0.5 °C intervals. When in position in the block, the thermometer bulb must be surrounded with thermally conducting thermoplastic compound;

(c) *Hotplate*, fitted with a temperature-control device. (Other types of apparatus with suitable temperature-control facilities may be employed to heat the metal block);

(d) *Stopwatch*, or other suitable timing device;

(e) *Syringe*, capable of delivering 2 mL to an accuracy of ±0.1 mL; and

(f) *Fuel source*, butane test fuel.

4. SAMPLING

The sample must be representative of the material to be tested and must be supplied and kept in a tightly closed container prior to test. Because of the possibility of loss of volatile constituents, the sample must receive only the minimum treatment necessary to ensure its homogeneity. After removing each test portion, the sample container must be immediately closed tightly to ensure that no volatile components escape from the container; if this closure is incomplete, an entirely new sample must be taken.

5. PROCEDURE

Carry out the determination in triplicate.

WARNING—Do not carry out the test in a small confined area (for example a glove box) because of the hazard of explosions.

(a) It is essential that the apparatus be set up in a completely draft-free area (see warning) and in the absence of strong light to facilitate observation of flash, flame, etc.

(b) Place the metal block on the hotplate or heat the metal block by other suitable means so that its temperature, as indicated by the thermometer placed in the metal block, is maintained at the specified temperature within a tolerance of ±1 °C. For the appropriate test temperature, see paragraph 5.(h) of this appendix. Correct this temperature for the difference in barometric pressure from the standard atmospheric pressure (101.3 kPa) by raising the test temperature for a higher pressure or lowering the test temperature for a lower pressure by 1.0 °C for each 4 kPa difference. Ensure that the top of the metal block is exactly horizontal. Use the gauge to check that the jet is 2.2 mm above the top of the well when in the test position.

(c) Light the butane test fuel with the jet away from the test position (i.e. in the “off” position, away from the well). Adjust the size of the flame so that it is 8 mm to 9 mm high and approximately 5 mm wide.

(d) Using the syringe, take from the sample container at least 2 mL of the sample and rapidly transfer a test portion of 2 mL ±0.1 mL to the well of the combustibility tester and immediately start the timing device.

(e) After a heating time of 60 seconds (s), by which time the test portion is deemed to have reached its equilibrium temperature, and if the test fluid has not ignited, swing the test flame into the test position over the edge of the pool of liquid. Maintain it in this position for 15 s and then return it to the “off” position while observing the behavior of the test portion. The test flame must remain lighted throughout the test.

(f) For each test observe and record:

(i) whether there is ignition and sustained combustion or flashing, or neither, of the test portion before the test flame is moved into the test position;

(ii) whether the test portion ignites while the test flame is in the test position, and, if so, how long combustion is sustained after the test flame is returned to the “off” position.

(g) If sustained combustion interpreted in accordance with paragraph 6. of this appendix is not found, repeat the complete procedure with new test portions, but with a heating time of 30 s.

(h) If sustained combustion interpreted in accordance with paragraph 6. of this appendix is not found at a test temperature of 60 °C (140 °F), repeat the complete procedure with new test portions, but at a test temperature of 75 °C (167 °F). In the case of a material which has a flash point above 60 °C (140 °F) and below 93 °C (200 °F), if sustained combustion interpreted in accordance with paragraph 6. of this appendix is not found at a test temperature of 5 °C (9 °F) above its flash point, repeat the complete procedure with new test portions, but at a test temperature of 20 °C (36 °F) above its flash point.

6. INTERPRETATION OF OBSERVATIONS

The material must be assessed either as not sustaining combustion or as sustaining combustion. Sustained combustion must be reported at either of the heating times if one of the following occurs with either of the test portions:

(a) When the test flame is in the “off” position, the test portion ignites and sustains combustion;

(b) The test portion ignites while the test flame is in the test position for 15 s, and sustains combustion for more than 15 s after the test flame has been returned to the “off” position.

NOTE TO PARAGRAPH 6 OF THIS APPENDIX: Intermittent flashing may not be interpreted as sustained combustion. Normally, at the end of 15 s, the combustion has either clearly ceased or continues. In cases of doubt, the material must be deemed to sustain combustion.

[Amdt. 173–241, 59 FR 67517, Dec. 29, 1994, as amended by Amdt. 173–255, 61 FR 50627, Sept. 26, 1996; 66 FR 45381, Aug. 28, 2001; 68 FR 75747, Dec. 31, 2003; 69 FR 76179, Dec. 20, 2004; 71 FR 78634, Dec. 29, 2006]

PART 174—CARRIAGE BY RAIL**Subpart A—General Requirements**

Sec.

- 174.1 Purpose and scope.
- 174.2 Limitation on actions by states, local governments, and Indian tribes.
- 174.3 Unacceptable hazardous materials shipments.
- 174.5 Carrier’s materials and supplies.
- 174.9 Safety and security inspection and acceptance.
- 174.14 Movements to be expedited.
- 174.16 Removal and disposition of hazardous materials at destination.
- 174.20 Local or carrier restrictions.

Subpart B—General Operating Requirements

- 174.24 Shipping papers.
- 174.26 Notice to train crews.
- 174.50 Nonconforming or leaking packages.

Subpart C—General Handling and Loading Requirements

- 174.55 General requirements.
- 174.57 Cleaning cars.
- 174.59 Marking and placarding of rail cars.
- 174.61 Transport vehicles and freight containers on flat cars.
- 174.63 Portable tanks, IM portable tanks, IBCs, Large Packagings, cargo tanks, and multi-unit tank car tanks.
- 174.67 Tank car unloading.

- 174.81 Segregation of hazardous materials.

Subpart D—Handling of Placarded Rail Cars, Transport Vehicles and Freight Containers

- 174.82 General requirements for the handling of placarded rail cars, transport vehicles, freight containers, and bulk packagings.
- 174.83 Switching placarded rail cars, transport vehicles, freight containers, and bulk packagings.
- 174.84 Position in train of loaded placarded rail cars, transport vehicles, freight containers or bulk packagings when accompanied by guards or technical escorts.
- 174.85 Position in train of placarded cars, transport vehicles, freight containers, and bulk packagings.
- 174.86 Maximum allowable operating speed.

Subpart E—Class I (Explosive) Materials

- 174.101 Loading Class 1 (explosive) materials.
- 174.102 Forbidden mixed loading and storage.
- 174.103 Disposition of damaged or astray shipments.
- 174.104 Division 1.1 or 1.2 (explosive) materials; car selection, preparation, inspection, and certification.
- 174.105 Routing shipments, Division 1.1 or 1.2 (explosive) materials.
- 174.106 “Order-Notify” or “C.O.D.” shipments, Division 1.1 or 1.2 (explosive) materials.
- 174.110 Car magazine.
- 174.112 Loading Division 1.3 and Division 1.2 (explosive) materials (Also see §174.101).
- 174.114 Record to be made of change of seals on “Cars loaded with Division 1.1 or 1.2 (explosive) materials”.
- 174.115 Loading Division 1.4 (explosive) materials.

Subpart F—Detailed Requirements for Class 2 (Gases) Materials

- 174.200 Special handling requirements.
- 174.201 Class 2 (gases) material cylinders.
- 174.204 Tank car delivery of gases, including cryogenic liquids.
- 174.290 Materials extremely poisonous by inhalation shipped by, for, or to the Department of Defense.

Subpart G—Detailed Requirements for Class 3 (Flammable Liquid) Materials

- 174.300 Special handling requirements.
- 174.304 Class 3 (flammable liquid) materials in tank cars.

Subparts H–I [Reserved]

**Subpart J—Detailed Requirements for
Division 6.1 (Poisonous) Materials**

174.600 Special handling requirements for materials extremely poisonous by inhalation.

174.615 Cleaning cars.

174.680 Division 6.1 (poisonous) materials with foodstuffs.

**Subpart K—Detailed Requirements for
Class 7 (Radioactive) Materials**

174.700 Special handling requirements for Class 7 (radioactive) materials.

174.715 Cleanliness of transport vehicles after use.

174.750 Incidents involving leakage.

AUTHORITY: 49 U.S.C. 5101–5128; 49 CFR 1.81 and 1.97.

Subpart A—General Requirements

§ 174.1 Purpose and scope.

This part prescribes requirements in addition to those contained in parts 171, 172, 173, and 179 of this subchapter, to be observed with respect to the transportation of hazardous materials in or on rail cars.

[Amdt. 174–26, 41 FR 16092, Apr. 15, 1976, as amended by Amdt. 174–26A, 41 FR 40685, Sept. 20, 1976; Amdt. 174–74, 58 FR 51533, Oct. 1, 1993]

§ 174.2 Limitation on actions by states, local governments, and Indian tribes.

Sections 5125 and 20106 of Title 49, United States Code, limit the authority of states, political subdivisions of states, and Indian tribes to impose requirements on the transportation of hazardous materials in commerce. A state, local, or Indian tribe requirement on the transportation of hazardous materials by rail may be preempted under either 49 U.S.C. 5125 or 20106, or both.

(a) Section 171.1(f) of this subchapter describes the circumstances under which 49 U.S.C. 5125 preempts a requirement of a state, political subdivision of a state, or Indian tribe.

(b) Under the Federal Railroad Safety Act (49 U.S.C. 20106), administered by the Federal Railroad Administration (*see* 49 CFR parts 200 through 244), laws, regulations and orders related to railroad safety, including security, shall be nationally uniform to the ex-

tent practicable. A state may adopt, or continue in force, a law, regulation, or order covering the same subject matter as a DOT regulation or order applicable to railroad safety and security (including the requirements in this subpart) only when an additional or more stringent state law, regulation, or order is necessary to eliminate or reduce an essentially local safety or security hazard; is not incompatible with a law, regulation, or order of the United States Government; and does not unreasonably burden interstate commerce.

[74 FR 1801, Jan. 13, 2009]

§ 174.3 Unacceptable hazardous materials shipments.

No person may accept for transportation or transport by rail any shipment of hazardous material that is not in conformance with the requirements of this subchapter.

[Amdt. 174–83, 61 FR 28677, June 5, 1996]

§ 174.5 Carrier's materials and supplies.

This subchapter applies to the transportation of a carrier's materials and supplies moving by rail, except that the shipper's certification is not required when these materials and supplies are being transported by the carrier who owns them. The requirements of this subchapter do not apply to railway torpedoes or fusees when carried in engines or rail cars. Railway torpedoes must be in closed metal boxes when not in use.

[Amdt. 174–26B, 41 FR 57071, Dec. 30, 1976]

§ 174.9 Safety and security inspection and acceptance.

(a) At each location where a hazardous material is accepted for transportation or placed in a train, the carrier must inspect each rail car containing the hazardous material, at ground level, for required markings, labels, placards, securement of closures, and leakage. These inspections may be performed in conjunction with inspections required under parts 215 and 232 of this title.

(b) For each rail car containing an amount of hazardous material requiring placarding in accordance with

§ 174.14

§172.504 of this subchapter, the carrier must visually inspect the rail car at ground level for signs of tampering, including closures and seals, for suspicious items or items that do not belong, and for other signs that the security of the car may have been compromised, including the presence of an improvised explosive device. As used in this section, an improvised explosive device is a device fabricated in an improvised manner incorporating explosives or destructive, lethal, noxious, pyrotechnic, or incendiary chemicals in its design, and generally includes a power supply, a switch or timer, and a detonator or initiator. The carrier should be particularly attentive to signs that security may have been compromised on rail cars transporting materials covered by §172.820 of this subchapter, rail carload quantities of ammonium nitrate or ammonium nitrate mixtures in solid form, or hazardous materials of interest based on current threat information.

(c) If a rail car does not conform to the safety and security requirements of this subchapter, the carrier may not forward or transport the rail car until the deficiencies are corrected or the car is approved for movement in accordance with §174.50.

(d) Where an indication of tampering or suspicious item is found, a carrier must take appropriate action to ensure the security of the rail car and its contents have not been compromised before accepting the rail car for further movement. If the carrier determines that the security of the rail car has been compromised, the carrier must take action, in conformance with its existing security plan (see subpart I of part 172 of this subchapter) to address the security issues before forwarding the rail car for further movement.

[73 FR 20773, Apr. 16, 2008]

§ 174.14 Movements to be expedited.

(a) A carrier must forward each shipment of hazardous materials promptly and within 48 hours (Saturdays, Sundays, and holidays excluded), after acceptance at the originating point or receipt at any yard, transfer station, or interchange point, except that where biweekly or weekly service only is performed, a shipment of hazardous mate-

49 CFR Ch. I (10–1–14 Edition)

rials must be forwarded on the first available train.

(b) A tank car loaded with any Division 2.1 (flammable gas), Division 2.3 (poisonous gas) or Class 3 (flammable liquid) material, may not be received and held at any point, subject to forwarding orders, so as to defeat the purpose of this section or of §174.204 of this subchapter.

[Amdt. 174-26, 41 FR 16092, Apr. 15, 1976, as amended by Amdt. 174-68, 55 FR 52677, Dec. 21, 1990]

§ 174.16 Removal and disposition of hazardous materials at destination.

(a) *Delivery at non-agency stations.* A shipment of Class 1 (explosive) materials may not be unloaded at non-agency stations unless the consignee is there to receive it or unless properly locked and secure storage facilities are provided at that point for its protection. If delivery cannot be so made, the shipment must be taken to next or nearest agency station for delivery.

(b) *Delivery at agency stations.* A carrier shall require the consignee of each shipment of hazardous materials to remove the shipment from carrier's property within 48 hours (exclusive of Saturdays, Sundays, and holidays) after notice of arrival has been sent or given. If not so removed, the carrier shall immediately dispose of the shipments as follows:

(1) *Division 1.1 or 1.2 (explosive) materials:* If safe storage is available, by storage at the owner's expense; if safe storage is not available, by return to the shipper, sale, or destruction under supervision of a competent person; or if safety requires, by destruction under supervision of a competent person.

(2) *Hazardous materials, except Division 1.1 or 1.2 (explosive) materials, in carload shipments:* By storage on the carrier's property; by storage on other than the carrier's property, if safe storage on the carrier's property is not available; or by sale at expiration of 15 calendar days after notice of arrival has been sent or given to the consignee, provided the consignor has been notified of the non-delivery at the expiration of a 48-hour period and orders for disposition have not been received.

(3) *Hazardous materials, except Division 1.1 or 1.2 (Class A explosive) materials, in*

less-than-carload shipments: By return to the shipper if notice of non-delivery was requested and given the consignor as prescribed by the carrier's tariff, and orders for return to shipper have been received; by storage on the carrier's property; by storage on other than the carrier's property, if safe storage on carrier's property is not available; or by sale at expiration of 15 calendar days after notice of arrival has been sent or given to the consignee, provided the consignor has been notified of non-delivery at expiration of a 48-hour period and orders for disposition have not been received.

[Amdt. 174-26, 41 FR 16092, Apr. 15, 1976, as amended by Amdt. 174-68, 55 FR 52677, Dec. 21, 1990; 66 FR 45383, Aug. 28, 2001]

§ 174.20 Local or carrier restrictions.

(a) When local conditions make the acceptance, transportation, or delivery of hazardous materials unusually hazardous, local restrictions may be imposed by the carrier.

(b) Each carrier must report to the Bureau of Explosives for publication the full information as to any restrictions which it imposes against the acceptance, delivery, or transportation of hazardous materials, over any portion of its lines under this section.

[Amdt. 174-26, 41 FR 16092, Apr. 15, 1976]

Subpart B—General Operating Requirements

§ 174.24 Shipping papers.

(a) A person may not accept a hazardous material for transportation or transport a hazardous material by rail unless that person receives a shipping paper prepared in accordance with part 172 of this subchapter, unless the material is excepted from shipping paper requirements under this subchapter. Only an initial carrier within the United States must receive and retain a copy of the shipper's certification as required by § 172.204 of this subchapter. This section does not apply to a material that is excepted from shipping paper requirements by this subchapter.

(b) Each person receiving a shipping paper required by this section must retain a copy or an electronic image thereof, that is accessible at or

through its principal place of business and must make the shipping paper available, upon request, to an authorized official of a Federal, State, or local government agency at reasonable times and locations. For a hazardous waste, each shipping paper copy must be retained for three years after the material is accepted by the initial carrier. For all other hazardous materials, each shipping paper copy must be retained for one year after the material is accepted by the initial carrier. Each shipping paper copy must include the date of acceptance by the initial carrier. The date on the shipping paper may be the date a shipper notifies the rail carrier that a shipment is ready for transportation, as indicated on the waybill or bill of lading, as an alternative to the date the shipment is picked up, or accepted, by the carrier.

[67 FR 46128, July 12, 2002, as amended at 67 FR 66574, Nov. 1, 2002; 70 FR 73165, Dec. 9, 2005]

§ 174.26 Notice to train crews.

(a) The train crew must have a document that reflects the current position in the train of each rail car containing a hazardous material. The train crew must update the document to indicate changes in the placement of a rail car within the train. For example, the train crew may update the document by handwriting on it or by appending or attaching another document to it.

(b) A member of the crew of a train transporting a hazardous material must have a copy of a document for the hazardous material being transported showing the information required by part 172 of this subchapter, including the requirements in § 172.604(b) applicable to emergency response information.

[Amdt. 174-84, 62 FR 1236, Jan. 8, 1997, as amended at 74 FR 53423, Oct. 19, 2009]

§ 174.50 Nonconforming or leaking packages.

A leaking non-bulk package may not be forwarded until repaired, reconditioned, or overpacked in accordance with § 173.3 of this subchapter. Except as otherwise provided in this section, a bulk packaging that no longer conforms to this subchapter may not be forwarded by rail unless repaired or approved for movement by the Associate

§ 174.55

Administrator for Safety, Federal Railroad Administration. Notification and approval must be in writing, or through telephonic or electronic means, with subsequent written confirmation provided within two weeks. For the applicable address and telephone number, see §107.117(d)(4) of this chapter. A leaking bulk package containing a hazardous material may be moved without repair or approval only so far as necessary to reduce or to eliminate an immediate threat or harm to human health or to the environment when it is determined its movement would provide greater safety than allowing the package to remain in place. In the case of a liquid leak, measures must be taken to prevent the spread of liquid.

[65 FR 50462, Aug. 18, 2000]

Subpart C—General Handling and Loading Requirements

§ 174.55 General requirements.

(a) Each package containing a hazardous material being transported by rail in a freight container or transport vehicle must be loaded so that it cannot fall or slide and must be safeguarded in such a manner that other freight cannot fall onto or slide into it under conditions normally incident to transportation. When this protection cannot be provided by using other freight, it must be provided by blocking and bracing. For examples of blocking and bracing in freight containers and transport vehicles, see Bureau of Explosives Pamphlet No. 6 and the Intermodal Loading Guide for Products in Closed Trailers and Containers (IBR, see §171.7 of this subchapter).

(b) Each package containing a hazardous material bearing package orientation markings prescribed in §172.312 of this subchapter must be loaded within a transport vehicle or freight container to remain in the correct position indicated by those markings during transportation.

(c) The doors of a freight container or transport vehicle may not be used to secure a load that includes a package containing a hazardous material unless the doors meet the design strength requirements of Specification M-930 (for

49 CFR Ch. I (10–1–14 Edition)

freight containers) and M-931 (for trailers) in the AAR's specification for "Specially Equipped Freight Car and Intermodal Equipment" (IBR, see §171.7 of this subchapter) and the load is also within the limits of the design strength requirements for the doors.

[Amdt. 174-83, 61 FR 28677, June 5, 1996, as amended at 68 FR 75747, Dec. 31, 2003; 76 FR 43530, July 20, 2011]

§ 174.57 Cleaning cars.

All hazardous material which has leaked from a package in any rail car or on other railroad property must be carefully removed.

§ 174.59 Marking and placarding of rail cars.

No person may transport a rail car carrying hazardous materials unless it is marked and placarded as required by this subchapter. Placards and car certificates lost in transit must be replaced at the next inspection point, and those not required must be removed at the next terminal where the train is classified. For Canadian shipments, required placards lost in transit, must be replaced either by those required by part 172 of this subchapter or by those authorized under §171.12.

[74 FR 53189, Oct. 16, 2009]

§ 174.61 Transport vehicles and freight containers on flat cars.

(a) A transport vehicle, freight container, or package containing a hazardous material must be designed and loaded so that it will not become damaged to an extent that would affect its integrity under conditions normally incident to transportation. Each unit must be secured on a flatcar so that it cannot permanently change position during transit. Packages of hazardous materials contained therein must be loaded and braced as provided by §§174.101, 174.112, 174.115 and 174.55. Placards must be applied when prescribed by part 172 of this subchapter and part 174.

(b) Except as specified in §173.21, a truck body, trailer, or freight container equipped with heating or refrigerating equipment which has fuel or any article classed as a hazardous material may be loaded and transported

on a flat car as part of a joint rail high-way movement. The heating or refrigerating equipment is considered to be a part of the truck body or trailer and is not subject to any other requirements of this subchapter. The truck body, trailer, or freight container must be secured on the flatcar so that it cannot change position during transit.

[Amdt. 174-26, 41 FR 16092, Apr. 15, 1976, as amended by Amdt. 174-26A, 41 FR 40685, Sept. 20, 1976; Amdt. 174-38, 45 FR 32698, May 19, 1980; Amdt. 174-39, 45 FR 81572, Dec. 11, 1980; Amdt. 174-59, 51 FR 5974, Feb. 18, 1986; Amdt. 174-68, 57 FR 45464, Oct. 1, 1992; Amdt. 174-79, 59 FR 64744, Dec. 15, 1994]

§ 174.63 Portable tanks, IM portable tanks, IBCs, Large Packagings, cargo tanks, and multi-unit tank car tanks.

(a) A carrier may not transport a bulk packaging (*e.g.*, portable tank, IM portable tank, IBC, Large Packaging, cargo tank, or multi-unit tank car tank) containing a hazardous material in container-on-flatcar (COFC) or trailer-on-flatcar (TOFC) service except as authorized by this section or unless approved for transportation by the Associate Administrator for Safety, FRA.

(b) A bulk packaging containing a hazardous material (including IM 101 and IM 102 when appropriate according to dimensions and weight distribution) may be transported inside a fully closed transport vehicle or fully closed freight container provided it is properly secured with a restraint system that will prevent it from changing position, sliding into other packages, or contacting the side or end walls (including doors) under conditions normally incident to transportation.

(c) When not transported in conformance with and subject to paragraph (b) of this section, a bulk packaging may be transported in COFC service or TOFC service subject to the following conditions as applicable:

(1) The bulk packaging contains a material packaged in accordance with § 173.240, 173.241, 173.242, or 173.243 of this subchapter;

(2) The tank and flatcar must comply with the applicable requirements of the HMR concerning their specification.

(3) For TOFC service, the trailer chassis conforms to requirements in paragraphs 3, 4, 5, and 6 of AAR Speci-

fication M-943, "Container Chassis For TOFC Service" of the AAR specification for "Specially Equipped Freight Car and Intermodal Equipment" (IBR, see § 171.7 of this subchapter);

(4) For COFC service, the container support and securement systems conform to requirements in Specification M-952, "Intermodal Container Support and Securement Systems for Freight Cars", of the AAR specification for "Specially Equipped Freight Car and Intermodal Equipment" (IBR, see § 171.7 of this subchapter);

(5) If transported in a well car—

(i) The tank is not in a double-stacked configuration (*i.e.*, no freight container or portable tank is placed above or below the tank); and

(ii) The tank is transported in the well with its outlet valve facing outward towards the end of the well and away from any adjacent tank or container; and

(6) All securement fittings shall be fully engaged and in the locked position, provided; however, if the tank is transported in a well car, it must be loaded into a well appropriate for the length of the container and any void filling device present must be secured in its designed appropriate position.

(d) An approval in effect on February 28, 1991 for the transportation of portable tanks or IM portable tanks in TOFC or COFC service expires on the date stated in the approval letter or June 15, 1995, whichever is later.

(e) A carrier may not transport a cargo tank or multi-unit tank car tank containing a hazardous material in TOFC or COFC service unless approved for such service by the Associate Administrator for Safety, FRA. However, in the event of an accident or incident, no such approval is necessary for the transportation of a cargo tank containing a hazardous material in TOFC service under the following condition(s):

(1) There is an emergency need for the cargo tank in order to mitigate the consequences of an incident; and

(2) Movement of the cargo tank is limited to transportation necessary for emergency purposes.

[Amdt. 174–79, 59 FR 64744, Dec. 15, 1994, as amended by 66 FR 45383, Aug. 28, 2001; 68 FR 75747, Dec. 31, 2003; 75 FR 5395, Feb. 2, 2010; 77 FR 37985, June 25, 2012]

§ 174.67 Tank car unloading.

For transloading operations, the following rules must be observed:

(a) *General requirements.* (1) Unloading operations must be performed by hazmat employees properly instructed in unloading hazardous materials and made responsible for compliance with this section.

(2) Each hazmat employee who is responsible for unloading must apply the handbrake and block at least one wheel to prevent movement in any direction. If multiple tank cars are coupled together, sufficient hand brakes must be set and wheels blocked to prevent movement in both directions.

(3) Each hazmat employee who is responsible for unloading must secure access to the track to prevent entry by other rail equipment, including motorized service vehicles. This requirement may be satisfied by lining each switch providing access to the unloading area against movement and securing each switch with an effective locking device, or by using derails, portable bumper blocks, or other equipment that provides and equivalent level of safety.

(4) Each hazmat employee who is responsible for unloading must display caution signs on the track or on the tank cars to warn persons approaching the cars from the open end of the track and must be left up until after all closures are secured and the cars are in proper condition for transportation. The caution signs must be of metal or other durable material, rectangular, at 30.48 cm (12 inches) high by 38.10 cm (15 inches) wide, and bear the word “STOP.” The word “STOP” must appear in letters at least 10.16 cm (4 inches) high. The letters must be white on a blue background. Additional words, such as “Tank Car Connected” or “Crew at Work,” may also appear in white letters under the word “STOP.”

(5) The transloading facility operator must maintain written safety procedures (such as those it may already be

required to maintain pursuant to the Department of Labor’s Occupational Safety and Health Administration requirements in 29 CFR 1910.119 and 1910.120) in a location where they are immediately available to hazmat employees responsible for the transloading operation.

(6) Before a manhole cover or outlet valve cap is removed from a tank car, the car must be relieved of all interior pressure by cooling the tank with water or by venting the tank by raising the safety valve or opening the dome vent at short intervals. However, if venting to relieve pressure will cause a dangerous amount of vapor to collect outside the car, venting and unloading must be deferred until the pressure is reduced by allowing the car to stand overnight, otherwise cooling the contents, or venting to a closed collection system. These precautions are not necessary when the car is equipped with a manhole cover which hinges inward or with an inner manhole cover which does not have to be removed to unload the car, and when pressure is relieved by piping vapor into a condenser or storage tank.

(b) After the pressure is released, for unloading processes that require the removal of the manhole cover, the seal must be broken and the manhole cover removed as follows:

(1) *Screw type.* The cover must be loosened by placing a bar between the manhole cover lug and knob. After two complete turns, so that the vent openings are exposed, the operation must be stopped, and if there is any sound of escaping vapor, the cover must be screwed down tightly and the interior pressure relieved as prescribed in paragraph (a)(6) of this section, before again attempting to remove the cover.

(2) *Hinged and bolted type.* All nuts must be unscrewed one complete turn, after which same precautions as prescribed for screw type cover must be observed.

(3) *Interior type.* All dirt and cinders must be carefully removed from around the cover before the yoke is unscrewed.

(c) When the car is unloaded through a bottom outlet valve, for unloading processes that require the removal of the manhole cover, the manhole cover must be adjusted as follows:

(1) *Screw type.* The cover must be put in place, but not entirely screwed down, so that air may enter the tank through the vent holes in threaded flange of the cover.

(2) *Hinged and bolted type.* A non-metallic block must be placed under one edge of the cover.

(3) *Interior type.* The screw must be tightened up in the yoke so that the cover is brought up within one-half inch of the closed position.

(d) When unloading through the bottom outlet of a car equipped with an interior manhole type cover, and in each case where unloading is done through the manhole (unless a special cover with a safety vent opening and a tight connection for the discharge outlet is used), the manhole must be protected by asbestos or metal covers against the entrance of sparks or other sources of ignition of vapor, or by being covered and surrounded with wet burlap or similar cloth material. The burlap or other cloth must be kept damp by the replacement or the application of water as needed.

(e) Seals or other substances must not be thrown into the tank and the contents may not be spilled over the car or tank.

(f) The valve rod handle or control in the dome must be operated several times to see that outlet valve in bottom of tank is on its seat before valve cap is removed.

(g) The valve cap, or the reducer when a large outlet is to be used, must be removed with a suitable wrench after the set screws are loosened and a pail must be placed in position to catch any liquid that may be in the outlet chamber. If the valve cap or reducer does not unscrew easily, it may be tapped lightly with a mallet or wooden block in an upward direction. If leakage shows upon starting the removal, the cap or reducer may not be entirely unscrewed. Sufficient threads must be left engaged and sufficient time allowed to permit controlled escape of any accumulation of liquid in the outlet chamber. If the leakage stops or the rate of leakage diminishes materially, the cap or reducer may be entirely removed. If the initial rate of leakage continues, further efforts must be made to seat the outlet valve (see para-

graph (f) of this section). If this fails, the cap or reducer must be screwed up tight and the tank must be unloaded through the dome. If upon removal of the outlet cap the outlet chamber is found to be blocked with frozen liquid or any other matter, the cap must be replaced immediately and a careful examination must be made to determine whether the outlet casting has been cracked. If the obstruction is not frozen liquid, the car must be unloaded through the dome. If the obstruction is frozen liquid and no crack has been found in the outlet casting, the car may, if circumstances require it, be unloaded from the bottom by removing the cap and attaching unloading connections immediately. Before opening the valve inside the tank car, steam must be applied to the outside of the outlet casting or wrap casting with burlap or other rags and hot water must be applied to melt the frozen liquid.

(h) Unloading connections must be securely attached to unloading pipes on the dome or to the bottom discharge outlets before any discharge valves are opened.

(i) Throughout the entire period of unloading and while a tank car has unloading equipment attached, the facility operator must assure that the tank car is:

(1) Attended by a designated hazmat employee who is physically present and who has an unobstructed view of the unloading operation; or

(2) Monitored by a signaling system (*e.g.*, video system, sensing equipment, or mechanical equipment) that is observed by a designated hazmat employee located either in the immediate area of the tank car or at a remote location within the facility, such as a control room. The signaling system must—

(i) Provide a level of surveillance equivalent to that provided in subparagraph (1) of this paragraph (i); and

(ii) Provide immediate notification to a designated hazmat employee of any system malfunction or other emergency so that, if warranted, responsive actions may be initiated immediately.

(j) Attendance is not required when piping is attached to a top outlet of a tank car, equipped with a protective

§ 174.81

housing required under §179.100-12 of this subchapter, for discharge of lading under the following conditions:

(1) All valves are tightly closed.

(2) The piping is not connected to hose or other unloading equipment and is fitted with a cap or plug of appropriate material and construction.

(3) The piping extends no more than 15.24 centimeters (6 inches) from the outer edge of the protective housing.

(k) In the absence of the unloader, a tank car may stand with unloading connections attached when no product is being transferred under the following conditions:

(1) The facility operator must designate a hazmat employee responsible for on-site monitoring of the transfer facility. The designated hazmat employee must be made familiar with the nature and properties of the product contained in the tank car; procedures to be followed in the event of an emergency; and, in the event of an emergency, have the ability and authority to take responsible actions.

(2) When a signaling system is used in accordance with paragraph (i) of this section, the system must be capable of alerting the designated hazmat employee in the event of an emergency and providing immediate notification of any monitoring system malfunction. If the monitoring system does not have self-monitoring capability, the designated hazmat employee must check the monitoring system hourly for proper operation.

(3) The tank car and facility shutoff valves must be secured in the closed position.

(4) Brakes must be set and wheels locked in accordance with paragraph (a)(2) of this section.

(5) Access to the track must be secured in accordance with paragraph (a)(3) of this section.

(l) As soon as a tank car is completely unloaded, all valves must be made tight by the use of a bar, wrench or other suitable tool, the unloading

49 CFR Ch. I (10-1-14 Edition)

connections must be removed and all other closures made tight.

(m) Railroad defect cards may not be removed.

(n) If oil or gasoline has been spilled on the ground around connections, it must be covered with fresh, dry sand or dirt.

(o) All tools and implements used in connection with unloading must be kept free of oil, dirt, and grit.

[Amdt. 174-26, 41 FR 16092, Apr. 15, 1976, as amended by Amdt. 174-26A, 41 FR 40685, Sept. 20, 1976; Amdt. 174-43, 48 FR 27699, June 16, 1983; Amdt. 174-68, 55 FR 52678, Dec. 21, 1990; 56 FR 66280, Dec. 20, 1991; Amdt. 174-81, 60 FR 49111, Sept. 21, 1995; Amdt. 174-83, 61 FR 28678, June 5, 1996; 68 FR 61941, Oct. 30, 2003; 70 FR 20034, Apr. 15, 2005; 72 FR 55693, Oct. 1, 2007; 76 FR 43530, July 20, 2011]

§ 174.81 Segregation of hazardous materials.

(a) This section applies to materials which meet one or more of the hazard classes defined in this subchapter and are in packages which are required to be labeled or placarded under the provisions of part 172 of this subchapter.

(b) When a rail car is to be transported by vessel, other than a ferry vessel, hazardous materials on or within that rail car must be stowed and segregated in accordance with §176.83(b) of this subchapter.

(c) Except as provided in §173.12(e) of this subchapter, cyanides, cyanide mixtures or solutions may not be stored, loaded and transported with acids; Division 4.2 materials may not be stored, loaded and transported with Class 8 liquids; and Division 6.1 Packing Group I, Hazard Zone A material may not be stored, loaded and transported with Class 3 material, Class 8 liquids, and Division 4.1, 4.2, 4.3, 5.1 or 5.2 material.

(d) Except as otherwise provided in this subchapter, hazardous materials must be stored, loaded or transported in accordance with the following table and other provisions of this section:

SEGREGATION TABLE FOR HAZARDOUS MATERIALS

Class or Division	Notes	1.1, 1.2	1.3	1.4	1.5	1.6	2.1	2.2	2.3 gas Zone A	2.3 gas Zone B	3	4.1	4.2	4.3	5.1	5.2	6.1 liq- uids PG I Zone A	7	8 liquids only
Explosives 1.1 and 1.2	A	*	*	*	*	*	X	X	X	X	X	X	X	X	X	X	X	X	X
Explosives 1.3		*	*	*	*	*	X	X	X	X	X	X	X	X	X	X	X	X	X
Explosives 1.4		*	*	*	*	*	X	X	X	X	X	X	X	X	X	X	X	X	X
Very insensitive explosives. 1.5	A	*	*	*	*	*	X	X	X	X	X	X	X	X	X	X	X	X	X
Extremely insensitive explosives. 1.6		*	*	*	*	*	X	X	X	X	X	X	X	X	X	X	X	X	X
Flammable gases 2.1		X	X	O	X	X	X	X	X	O	X	X	X	X	X	X	X	X	X
Non-toxic, non-flammable gases. 2.2		X	X	O	X	X	X	X	X	O	X	X	X	X	X	X	X	X	X
Poisonous gas Zone A 2.3		X	X	O	X	X	X	X	X	O	X	X	X	X	X	X	X	X	X
Poisonous gas Zone B 2.3		X	X	O	X	X	X	X	X	O	X	X	X	X	X	X	X	X	X
Flammable liquids 3		X	X	O	X	X	X	X	X	O	X	X	X	X	X	X	X	X	X
Flammable solids 4.1		X	X	O	X	X	X	X	X	O	X	X	X	X	X	X	X	X	X
Spontaneously combustible materials. 4.2		X	X	O	X	X	X	X	X	O	X	X	X	X	X	X	X	X	X
Dangerous when wet materials. 4.3		X	X	O	X	X	X	X	X	O	X	X	X	X	X	X	X	X	X
Oxidizers 5.1	A	X	X	O	X	X	X	X	X	O	X	X	X	X	X	X	X	X	X
Organic peroxides 5.2		X	X	O	X	X	X	X	X	O	X	X	X	X	X	X	X	X	X
Poisonous liquids PG I Zone A. 6.1		X	X	O	X	X	X	X	X	O	X	X	X	X	X	X	X	X	X
Radioactive materials ... 7		X	X	O	X	X	X	X	X	O	X	X	X	X	X	X	X	X	X
Corrosive liquids 8		X	X	O	X	X	X	X	X	O	X	X	X	X	X	X	X	X	X

§ 174.81

49 CFR Ch. I (10–1–14 Edition)

(e) Instructions for using the segregation table for hazardous materials in paragraph (d) of this section are as follows:

(1) The absence of any hazard class or division, or a blank space in the table indicates that no restrictions apply.

(2) The letter “X” in the table indicates that these materials may not be loaded, transported, or stored together in the same rail car or storage facility during the course of transportation.

(3) The letter “O” in the table indicates that these materials may not be loaded, transported, or stored together in the same rail car or storage facility during the course of transportation unless separated in a manner that, in the event of leakage from packages under conditions normally incident to transportation, commingling of hazardous materials would not occur. Notwithstanding the methods of separation employed, Class 8 (corrosive) liquids may not be loaded above or adjacent to Class 4 (flammable) or Class 5 (oxidizing) materials; except that shippers may load carload shipments of such materials together when it is known that the mixture of contents would not cause a fire or a dangerous evolution of heat or gas.

(4) The “*” in the table indicates that segregation among different Class 1 (explosive) materials is governed by the compatibility table in paragraph (f) of this section.

(5) The note “A” in the second column of the table means that, notwithstanding the requirements of the letter “X”, ammonium nitrate fertilizer may be loaded or stored with Division 1.1 (explosive) or Division 1.5 materials.

(6) When the §172.101 table or §172.402 of this subchapter requires a package to bear a subsidiary hazard label, segregation appropriate to the subsidiary hazard must be applied when that segregation is more restrictive than that required by the primary hazard. However, hazardous materials of the same class may be loaded and transported together without regard to segregation required by any secondary hazard if the materials are not capable of reacting dangerously with each other and causing combustion or dangerous evolution of heat, evolution of flammable, poisonous, or asphyxiant gases, or formation of corrosive or unstable materials.

(f) Class 1 (explosive) materials may not be loaded, transported, or stored together, except as provided in this section, and in accordance with the following table:

COMPATIBILITY TABLE FOR CLASS 1 (EXPLOSIVE) MATERIALS

Compatibility group	A	B	C	D	E	F	G	H	J	K	L	N	S
A		X	X	X	X	X	X	X	X	X	X	X	X
B	X		X	4	X	X	X	X	X	X	X	X	4/5
C	X	X		2	2	X	6	X	X	X	X	X	3 4/5
D	X	4	2		2	X	6	X	X	X	X	X	3 4/5
E	X	X	2	2		X	6	X	X	X	X	X	3 4/5
F	X	X	X	X	X		X	X	X	X	X	X	4/5
G	X	X	6	6	6	X		X	X	X	X	X	4/5
H	X	X	X	X	X	X	X		X	X	X	X	4/5
J	X	X	X	X	X	X	X	X		X	X	X	4/5
K	X	X	X	X	X	X	X	X	X		X	X	4/5
L	X	X	X	X	X	X	X	X	X	X	1	X	X
N	X	X	3	3	3	X	X	X	X	X	X	X	4/5
S	X	4/5	4/5	4/5	4/5	4/5	4/5	4/5	4/5	4/5	X	4/5	

(g) Instructions for using the compatibility table for Class 1 (explosive) materials in paragraph (f) of this section are as follows:

(1) A blank space in the table indicates that no restrictions apply.

(2) The letter “X” in the table indicates that explosives of different compatibility groups may not be carried on

the same rail car, unless packed in separate freight containers (e.g., two or more freight containers mounted upon the same rail car).

(3) The numbers in the table mean the following:

(i) “1” means explosives from compatibility group L may only be carried

on the same rail car with an identical explosive.

(ii) “2” means any combination of explosives from compatibility group C, D, or E is assigned to compatibility group E.

(iii) “3” means any combination of explosives from compatibility group C, D, or E with those in compatibility group N is assigned to compatibility group D.

(iv) “4” means detonators and detonating primers, Division 1.4S (explosives), may not be loaded in the same car with Division 1.1 and 1.2 (explosive) materials.

(v) “5” means Division 1.4S fireworks may not be loaded in the same car with Division 1.1 or 1.2 (explosive) materials.

(vi) “6” means explosive articles in compatibility group G, other than fireworks and those requiring special stowage, may be loaded and transported with articles of compatibility groups C, D and E, provided no explosive substances are carried in the same rail car.

(h) Except as provided in paragraph (i) of this section, explosives of the same compatibility group but of different divisions may be transported together provided that the whole shipment is transported as though its entire contents were of the lower numerical division (i.e., Division 1.1 being lower than Division 1.2). For example, a mixed shipment of Division 1.2 (explosive) materials and Division 1.4 (explosive) materials, compatibility group D, must be transported as Division 1.2 (explosive) materials.

(i) When Division 1.5 materials, compatibility group D are transported in the same freight container as Division 1.2 (explosive) materials, compatibility group D, the shipment must be transported as Division 1.1 (explosive) materials, compatibility group D.

[Amdt. 174-68, 55 FR 52678, Dec. 21, 1990, as amended at 56 FR 66280, Dec. 20, 1991; 57 FR 45464, Oct. 1, 1992; Amdt. 174-68, 57 FR 59310, Dec. 15, 1992; Amdt. 174-75, 58 FR 50237, Sept. 24, 1993; Amdt. 174-83, 61 FR 51339, Oct. 1, 1996; 64 FR 10781, Mar. 5, 1999; 66 FR 45383, Aug. 28, 2001; 67 FR 15743, Apr. 3, 2002; 70 FR 3310, Jan. 24, 2005; 75 FR 27215, May 14, 2010]

Subpart D—Handling of Placarded Rail Cars, Transport Vehicles and Freight Containers

§ 174.82 General requirements for the handling of placarded rail cars, transport vehicles, freight containers, and bulk packages.

(a) Unless otherwise specified, this subpart does not apply to the handling of rail cars, transport vehicles, freight containers, or bulk packagings, which contain Division 1.6, combustible liquids, Division 6.1 PG III materials, Class 9 materials, or ORM-D materials.

(b) A placarded rail car, transport vehicle, freight container, or bulk package may not be transported in a passenger train.

[Amdt. 174-68, 55 FR 52680, Dec. 21, 1990, as amended at 56 FR 66281, Dec. 20, 1991; 57 FR 45464, Oct. 1, 1992; Amdt. 174-74, 58 FR 51533, Oct. 1, 1993]

§ 174.83 Switching placarded rail cars, transport vehicles, freight containers, and bulk packagings.

(a) In switching operations where the use of hand brakes is necessary—

(1) It must be determined by trial whether a loaded, placarded car, or a car occupied by a rider in a draft containing a placarded car, has its hand brakes in proper working condition before it is cut off;

(2) A loaded, placarded tank car or a draft which includes a loaded placarded tank car may not be cut off until the preceding rail car clears the ladder track; and

(3) A loaded, placarded tank car or a draft which includes a loaded placarded tank car must clear the ladder track before another rail car is allowed to follow.

(b) Any loaded rail car placarded for a Division 1.1 or Division 1.2 explosive, a Division 2.3 Hazard Zone A gas or a Division 6.1 PG I Hazard Zone A material, or a Class DOT 113 tank car displaying a Division 2.1 (flammable gas) placard, including a Class DOT 113 tank car containing only a residue of a Division 2.1 material, may not be:

(1) Cut off while in motion;

(2) Coupled into with more force than is necessary to complete the coupling; or

§ 174.84

49 CFR Ch. I (10–1–14 Edition)

(3) Struck by any car moving under its own momentum.

(c) A placarded flatcar, or a flatcar carrying a placarded transport vehicle, freight container, or bulk packaging under this subchapter may not be cut off while in motion.

(d) No rail car moving under its own momentum may be permitted to strike any placarded flatcar or any flatcar carrying a placarded transport vehicle, freight container, or bulk packaging.

(e) No placarded flatcar or any flatcar carrying a placarded transport vehicle, freight container, or bulk packaging may be coupled into with more force than is necessary to complete the coupling.

(f) When transporting a rail car, transport vehicle, or freight container placarded for Division 1.1 or 1.2 (explosive) materials in a terminal, yard, or on a side track or siding, the placarded rail car must be separated from the engine by at least one non-placarded rail car and must be placed in a location so that it will be safe from danger of fire. A rail car, transport vehicle, or freight container placarded for Division 1.1 or 1.2 (explosive) materials may not be placed under a bridge or overhead crossing, or in or alongside a passenger shed or station, except during transfer operations.

[Amdt. 174–68, 55 FR 52680, Dec. 21, 1990, as amended at 56 FR 66281, Dec. 20, 1991; Amdt. 174–75, 58 FR 50237, Sept. 24, 1993; Amdt. 174–77, 59 FR 48549, Sept. 21, 1994; Amdt. 174–83, 61 FR 51339, Oct. 1, 1996; 66 FR 45383, Aug. 28, 2001]

§ 174.84 Position in train of loaded placarded rail cars, transport vehicles, freight containers or bulk packagings when accompanied by guards or technical escorts.

A rail car placarded in Division 1.1 or 1.2 (explosive); Division 2.3 (Hazard Zone A; poisonous gas); or Division 6.1 (PG I, Hazard Zone A; poisonous liquid) in a moving or standing train must be next to and ahead of any car occupied by the guards or technical escorts accompanying the placarded rail car. However, if a rail car occupied by the guards or technical escorts has temperature control equipment in operation, it must be the fourth car behind any car requiring Division 1.1 or 1.2 (explosive) placards.

[Amdt. 174–68, 55 FR 52680, Dec. 21, 1990, as amended at 56 FR 66281, Dec. 20, 1991; 66 FR 45383, Aug. 28, 2001]

§ 174.85 Position in train of placarded cars, transport vehicles, freight containers, and bulk packagings.

(a) Except as provided in paragraphs (b) and (c) of this section, the position in a train of each loaded placarded car, transport vehicle, freight container, and bulk packaging must conform to the provisions of this section.

(b) A car placarded “RADIOACTIVE” must comply with train positioning requirements of paragraph (d) of this section and must be separated from a locomotive, occupied caboose, or carload of undeveloped film by at least one non-placarded car.

(c) A tank car containing the residue of a hazardous material must be separated from a locomotive or occupied caboose by at least one rail car other than a placarded tank car.

(d) Position of rail cars in a train. In the following table:

POSITION IN TRAIN OF PLACARDED CARS TRANSPORTING HAZARDOUS MATERIALS

RESTRICTIONS	Placard Group 1		Placard Group 2		Placard Group 3		Placard Group 4
	Rail Car	Tank Car	Rail Car	Tank Car	Rail Car	Rail Car	
1. When train length permits, placarded car may not be nearer than the sixth car from the engine or occupied caboose.	X	X		X			
2. When train length does not permit, placarded car must be placed near the middle of the train, but not nearer than the second car from an engine or occupied caboose.	X	X		X			
3. A placarded car may not be placed next to an open-top car when any of the lading in the open top car protrudes beyond the car ends, or if the lading shifted, would protrude beyond the car ends..	X	X		X			

POSITION IN TRAIN OF PLACARDED CARS TRANSPORTING HAZARDOUS MATERIALS—Continued

RESTRICTIONS	Placard Group 1		Placard Group 2		Placard Group 3		Placard Group 4
	Rail Car	Tank Car	Rail Car	Tank Car	Rail Car	Rail Car	
4. A placarded car may not be placed next to a loaded flat car, except closed TOFC/COFC equipment, auto carriers, and other specially equipped cars with tie-down devices for securing vehicles. Permanent bulk head flat cars are considered the same as open-top cars.	X	X		X			
5. A placarded car may not be placed next to any transport vehicle or freight container having an internal combustion engine or an open-flame device in operation..	X	X		X			
6. Placarded cars may not be placed next to each other based on the following:							
Placard Group 1		X	X	X	X	X	X
Placard Group 2	X			X	X		X
Placard Group 3	X	X	X				X
Placard Group 4	X	X	X	X	X		

PLACARD GROUP:
 Group 1—Divisions 1.1 and 1.2 (explosive) materials.
 Group 2—Divisions 1.3, 1.4, 1.5 (explosive), Class 2 (compressed gas; other than Div 2.3, PG I, Zone A), Class 3 (flammable liquid), Class 4 (flammable solid), Class 5 (oxidizing), Class 6 (poisonous liquid; other than Div 6.1, PG I, Zone A), and Class 8 (corrosive) materials.
 Group 3—Divisions 2.3 (Zone A; poisonous gas) and 6.1 (PG I, Zone A; poisonous liquid) materials.
 Group 4—Class 7 (radioactive) materials.

- (1) Where an “X” appears at the intersection of a Placard Group column and a Restriction row, the corresponding restriction applies.
- (2) “Rail Car” means a car other than a tank car.
- (3) For purposes of this subpart, each unit of an articulated intermodal rail car shall be considered as one car.

[Amdt. 174-68, 55 FR 52680, Dec. 21, 1990, as amended at 57 FR 45464, Oct. 1, 1992; Amdt. 174-83, 61 FR 28678, June 5, 1996; Amdt.174-83, 61 FR 50255, Sept. 25, 1996; Amdt. 174-83, 61 FR 51339, Oct. 1, 1996; 64 FR 51919, Sept. 27, 1999; 66 FR 45383, Aug. 28, 2001]

§ 174.86 Maximum allowable operating speed.

- (a) For molten metals and molten glass shipped in packagings other than those prescribed in §173.247 of this subchapter, the maximum allowable operating speed may not exceed 24 km/hour (15 mph) for shipments by rail.
- (b) For trains transporting any loaded, placarded tank cars containing a material poisonous by inhalation, the maximum allowable operating speed may not exceed 80.5 km/hour (50 mph) for shipments by rail.

[74 FR 1801, Jan. 13, 2009]

Subpart E—Class I (Explosive) Materials

§ 174.101 Loading Class 1 (explosive) materials.

- (a) Boxes containing Division 1.1 or 1.2 (explosive) materials must be loaded so that the ends of wooden boxes will not bear against sides of any fiberboard boxes and so that the ends of any box will not cause a pressure point on a small area of another box.
- (b) Explosive bombs, unfuzed projectiles, rocket ammunition and rocket motors, Division 1.1, 1.2, or 1.3 (explosive) materials, which are not packed in wooden boxes, or large metal packages of incendiary bombs, each weighing 226 kg (500 pounds) or more, may be loaded in stock cars or in flat bottom gondola cars only if they are adequately braced. Boxed bombs, rocket ammunition and rocket motors, Division 1.1, 1.2, or 1.3 (explosive) materials, which due to their size cannot be loaded in closed cars, may be loaded in open-top cars or on flatcars, provided they are protected from the weather and accidental ignition.
- (c) Boxes of Division 1.1 or 1.2 (explosive) materials packed in long cartridges, bags, or sift-proof liners, and containing no liquid explosive ingredient, may be loaded on their sides or ends.

§ 174.101

49 CFR Ch. I (10–1–14 Edition)

(d) Division 1.1 or 1.2 (explosive) materials may not be loaded higher than any permanent car lining unless additional lining is provided as high as the lading.

(e) When the lading of a car includes any Class 1 (explosive) materials, the weight of the lading must be distributed insofar as possible to equalize the weight on each side of the car and over the trucks.

(f) Except when boxed, metal kegs containing Class 1 (explosive) materials must be loaded on their sides with their ends toward the ends of the car. Packages of Class 1 (explosive) materials may not be placed in the space opposite the doors unless the doorways are boarded on the inside as high as the lading. This paragraph does not apply to palletized packages if they are braced so they cannot fall or slide into the doorways during transportation.

(g) Wooden kegs, fiber kegs, barrels, and drums must be loaded on their sides or ends, to best suit the conditions.

(h) Packages containing any Division 1.1 or 1.2 (explosive) materials for (see §174.104), detonators, detonator assemblies, or boosters with detonators must be securely blocked and braced to prevent the packages from changing position, falling to the floor, or sliding into each other, under conditions normally incident to transportation. Class 1 (explosive) materials must be loaded so as to avoid transfer at stations. For recommended methods of blocking and bracing, see Bureau of Explosives Pamphlets No. 6 and 6A. Heavy packages or containers must be trucked, rolled, or moved by skids, fork trucks, or other handling devices and may not be dropped from trucks, platforms, or cars. Planks for rolling trucks from platforms to cars must have beveled ends. Loading platforms and the shoes of each workman must be free from grit. All possible precautions must be taken against fire. Class 1 (explosive) materials must be kept in a safe place and inaccessible to unauthorized persons while being held by a carrier for loading or delivery.

(i) To prevent delays of local freight trains, when there are shipments of Class 1 (explosive) materials for different destinations loaded in a “peddler

car” or “way car” the shipment for each destination must be stayed separately.

(j) Forwarding and transfer stations for Class 1 (explosive) materials must be provided with the necessary materials for staying.

(k) Shippers must furnish the material for staying packages of Class 1 (explosive) materials loaded by them.

(l) Division 1.1 or 1.2 (explosive) materials may not be loaded, transported, or stored in a rail car equipped with any type of lighted heater or open-flame device, or electric devices having exposed heating coils, or in a rail car equipped with any apparatus or mechanism utilizing an internal combustion engine in its operation.

(m) [Reserved]

(n) A container car or freight container on a flatcar or a gondola car other than a drop-bottom car, when properly loaded, blocked, and braced to prevent change of position under conditions normally incident to transportation, may be used to transport any Division 1.1 or 1.2 (explosive) material except black powder packed in metal containers. A freight container must be designed, constructed, and maintained so as to be weather tight and capable of preventing the entrance of sparks. In addition:

(1) A freight container must be of such design and so braced as to show no evidence of failure of the container or the bracing when subjected to impact from each end of at least 13 km (8.1 miles) per hour. Its efficiency shall be determined by actual test, using dummy loads equal in weight and general character to material to be shipped.

(2) A container car or car which is loaded with freight containers must be placarded with the Class 1 (explosive) materials placards as required by subpart F of part 172 of this subchapter and with properly executed car certificates as required by §174.104.

(3) Lading must be so loaded, blocked, and braced within the freight container that it will not change position under impact from each end of at least 13 km (8.1 miles) per hour.

(o) Division 1.1, 1.2, or 1.3 (explosive) materials may be loaded and transported in a tight closed truck body or

trailer on a flatcar. Wooden boxed bombs, rocket ammunition, and rocket motors, Division 1.1, 1.2, or 1.3 (explosive) materials, which due to their size cannot be loaded in tight, closed truck bodies or trailers, may be loaded in or on open-top truck bodies or trailers. However, they must be protected against accidental ignition. In addition:

(1) Each truck body or trailer must meet the requirements of part 177 of this subchapter, applicable to shipments of Class 1 (explosive) materials by motor vehicle.

(2) Each truck body or trailer must be secured on the rail car so that it will not permanently change position or show evidence of failure or impending failure of the method of securing the truck body or trailer under impact from each end of at least 13 km (8.1 miles) per hour. Its efficiency must be determined by actual test, using dummy loads equal in weight and general character to the material to be shipped. For recommended methods of blocking and bracing, see the Intermodal Loading Guide for Products in Closed Trailers and Containers (IBR, see §171.7 of this subchapter).

(3) Lading must be loaded, blocked, and braced within or on the truck body or trailer so that the lading will not change position under impact from each end of at least 13 km (8.1 miles) per hour. For recommended methods of blocking and bracing, see the Intermodal Loading Guide for Products in Closed Trailers and Containers (IBR, see §171.7 of this subchapter).

(4) Each rail car containing Class 1 (explosive) materials and each rail car loaded with truck bodies, trailers or containers containing Class 1 (explosive) materials must be placarded with Class 1 (explosive) materials placards as required by subpart F of part 172 of this subchapter and with properly executed car certificates as required by §174.104.

(5) Each fuel tank of a heater or refrigerating machinery on the truck bodies or trailers must be drained and all automatic heating or refrigerating machinery must be made inoperative by disconnection of the automatic con-

trols or the source of power for their operations.

[Amdt. 174-26, 41 FR 16092, Apr. 15, 1976, as amended by Amdt. 174-26A, 41 FR 40685, Sept. 20, 1976; Amdt. 174-26B, 41 FR 57071, Dec. 30, 1976; Amdt. 174-36, 44 FR 70732, Dec. 10, 1979; Amdt. 174-59, 51 FR 5974, Feb. 18, 1986; Amdt. 174-68, 55 FR 52681, Dec. 21, 1990; Amdt. 174-83, 61 FR 51339, Oct. 1, 1996; 66 FR 45383, Aug. 28, 2001; 76 FR 43531, July 20, 2011]

§ 174.102 Forbidden mixed loading and storage.

(a) Division 1.1 or 1.2 (explosive) materials and initiating or priming explosives may not be transported together in the same rail car. Additionally, they may not be transported or loaded in the same rail car or stored on carrier property with charged electric storage batteries or with any hazardous material for which a NONFLAMMABLE GAS, FLAMMABLE GAS, FLAMMABLE LIQUID, FLAMMABLE SOLID, OXIDIZER, ORGANIC PEROXIDE, RADIOACTIVE or CORROSIVE label is required.

(b) Class 1 (explosive) materials may not be loaded together or with other hazardous materials, except as provided in §174.81. See §174.104 for loading shipments of Class 1 (explosive) materials or any other material in a placarded and certified car containing a shipment of Division 1.1 or 1.2 (explosive) materials.

[Amdt. 174-26, 41 FR 16092, Apr. 15, 1976, as amended by Amdt. 174-68, 55 FR 52681, Dec. 21, 1990; 66 FR 45383, Aug. 28, 2001]

§ 174.103 Disposition of damaged or astray shipments.

(a) Packages of Class 1 (explosive) materials found damaged or broken in transit may be repaired when practicable and not dangerous. A broken box of Division 1.1 or 1.2 (explosive) materials that cannot be repaired must be reinforced by stout wrapping paper and twine, placed in another strong box and surrounded by dry, fine sawdust or dry and clean cotton waste or elastic wads made from dry newspapers. A ruptured can or keg must be sealed and enclosed in a strong cloth bag of good quality and boxed. Damaged packages thus protected and properly marked may be forwarded. The box and waybill

§ 174.104

must be marked to indicate that it has been repacked.

(b) Care must be exercised in repacking damaged containers so that no spark is produced by contact of metal or other hard surfaces which could ignite loose particles of explosive compositions that may be strewn on car floors or freight. In addition, the car floors must be thoroughly swept, and washed with a plentiful supply of water. Iron-wheel trucks, metal hammers, or other metal tools that may produce sparks may not be used. Metal tools must be limited to those made of brass, bronze, or copper.

(c) Each package of Class 1 (explosive) materials showing evidence of leakage of liquid ingredients must:

(1) Be refused if leakage is discovered before acceptance;

(2) Be disposed of to a person who is competent and willing to remove them from the carrier's property, if the leakage is discovered while the shipment is in transit; or

(3) Be removed immediately by consignee, if the leakage is discovered at the shipment's destination.

(d) When the disposition required by paragraph (c) of this section cannot be made, the leaking package must be packed in other boxes large enough to permit enclosure and the leaking boxes must be surrounded by at least 5 cm (2 inches) of dry, fine sawdust or dry and clean cotton waste, and be stored in a station magazine or other safe place until the arrival of an inspector of the Bureau of Explosives, or other authorized person, to superintend the destruction or disposition of the condemned material.

(e) If careful inspection shows that an astray shipment of Class 1 (explosive) materials is in proper condition for safe transportation, it must be forwarded immediately to its destination if known, or returned to the shipper by the most practicable route.

(f) When a package in an astray shipment is not in proper condition for safe transportation (see paragraphs (a), (c), and (d) of this section), or when the name and address of the consignee and the shipper are unknown, disposition

49 CFR Ch. I (10–1–14 Edition)

must be made as prescribed by paragraphs (c) and (d) of this section.

[Amdt. 174-26, 41 FR 16092, Apr. 15, 1976, as amended by Amdt. 174-68, 55 FR 52681, Dec. 21, 1990; 66 FR 45383, Aug. 28, 2001]

§ 174.104 Division 1.1 or 1.2 (explosive) materials; car selection, preparation, inspection, and certification.

(a) Except as provided in §174.101 (b), (n), and (o), Division 1.1 or 1.2 (explosive) materials being transported by rail may be transported only in a certified and properly placarded closed car of not less than 36,300 kg (80,028 pounds) capacity, with steel underframes and friction draft gear or cushioned underframe, except that on a narrow-gauge railroad they may be transported in a car of less capacity as long as the car of greatest capacity and strength available is used.

(b) Each rail car used for transporting Division 1.1 or 1.2 (explosive) materials must meet the following requirements as applicable:

(1) The car must be equipped with air brakes, hand brakes, and roller bearings which are in condition for service.

(2) The car may not have any holes or cracks in the roof, sides, ends, or doors through which sparks may enter, or unprotected decayed spots which may hold sparks and start a fire.

(3) The roof of the car must be carefully inspected from the outside for decayed spots, especially under or near the running board, and such spots must be covered or repaired to prevent their holding fire from sparks. A car with a roof generally decayed, even if tight, may not be used.

(4) The doors must close tightly so that sparks cannot get in at the joints, and, if necessary to achieve this degree of tightness, the doors must be stripped. The stripping should be placed on the inside and fastened to the door frames where it will form a shoulder against which the closed doors are pressed by means of wedges or cleats in door shoes or keepers. The openings under the doors should be similarly closed. The hasp fastenings must be examined with the doors closed and fastened, and the doors must be cleated when necessary to prevent them from shifting. When the car is opened for any reason, the wedges or cleats must

be replaced before car containing Class 1 (explosive) materials is permitted to proceed.

(5) The roller bearings and the trucks must be carefully examined and put in such condition as to reduce to a minimum the danger of hotboxes or other failure necessitating the setting out of the car before reaching its destination.

(6) The car must be carefully swept out before it is loaded. For less-than-carload shipments the space in which the packages are to be loaded must be carefully swept. If evidence of a potential hazardous residue is apparent after the floor has been swept, the carrier must either decontaminate the car or provide a suitable substitute car.

(7) Any holes in the floor or lining must be repaired and special care taken that there are no projecting nails or bolts or exposed pieces of metal which may work loose or produce holes in packages of Class 1 (explosive) materials during transit. Protruding nails in the floor or lining which have worked loose must be drawn, and if necessary for the purpose of fastening the floor or lining, new nails must be driven through other parts thereof.

(8) Metal floor plates must be completely covered with wood, plywood, or fiber or composition sheets of adequate thickness and strength to prevent contact of the floor plates with the packages of Class 1 (explosive) materials under conditions incident to transportation, except that the covering of metal floor plates is not necessary for carload shipments loaded by the Department of Defense provided the Class 1 (explosive) materials are of such nature that they are not liable to leakage of dust, powder, or vapor which might become the cause of an explosion.

(9) If the car is equipped with automobile loading devices, it may not be used unless the loading device is securely attached to the roof of the car with fastenings supplementing those already provided and so fixed that it cannot fall.

(10) The car must be equipped with high-friction composition brake shoes (except metal deck flat cars used for COFC/TOFC service may be equipped with high phosphorus cast iron brake-shoes) and brake rigging designed for

this type of brake shoe. Each brake shoe on the car must be at least 1 cm (0.4 inch) thick, and in safe and suitable condition for service.

(11) The car must have either a metal subfloor with no combustible material exposed beneath the car, or metal spark shields extending from center sill to side sills and from end sills to at least 30 cm (12 inches) beyond the extreme treads of the inside wheels of each truck, which are tightly fitted against the subfloor so that there is no vacant space or combustible material exposed. The metal subfloor or spark shields may not have an accumulation of oil, grease, or other debris which could support combustion.

(c) Before Division 1.1 or 1.2 (explosive) materials may be loaded into a rail car, the car must have been inspected and certified to be in compliance with the requirements of paragraph (b) of this section by a qualified person designated under §215.11 of this title. The certification shall be made in Car Certificate No. 1 on the form prescribed in paragraph (f) of this section.

(d) If the carrier furnishes the car to a shipper for loading Division 1.1 or 1.2 (explosive) materials, the shipper or his authorized employee shall, before commencing the loading of the car, inspect the interior thereof, and after loading certify to the proper condition of the car and the loading. This certification shall be made on the first signature line in Car Certificate No. 2 on the form prescribed in paragraph (f) of this section. In addition, the finished load must be inspected and certified to be in compliance with the requirements of this part by a qualified person designated under §215.11 of this title before the car goes forward. This certification shall be made on the second signature line in Car Certificate No. 2 on the form prescribed in paragraph (f) of this section. If the loading is performed by the carrier, Car Certificate No. 2 may only be signed by a qualified person designated under §215.11 of this title.

(e) If a trailer or container containing Division 1.1 or 1.2 (explosive) materials is loaded on a flatcar, the loading and securing of the load on the

§ 174.105

49 CFR Ch. I (10-1-14 Edition)

car must be supervised by a representative of the shipper or carrier. The certification shall be made in Car Certificate No. 3 on the form prescribed in paragraph (f) of this section.

(f) Each car certificate for use in connection with the inspection of rail cars for the carriage of Division 1.1 or 1.2 (explosive) materials shall be printed on strong tag board measuring 18 by 18 cm (7.1 by 7.1 inches) or 15 by 20 cm (5.9 by 7.9 inches). It must be duly executed in triplicate by the carrier, and by the shipper if he loads the shipments. The original must be filed by the carrier at the forwarding station in a separate file and the other two must be attached to the car, one to each outer side on a fixed placard board or as otherwise provided.

_____ Railroad
CAR CERTIFICATE

No. 1 _____ Station _____
20 ____.

I hereby certify that I have this day personally examined Car Number _____ and that the car is in condition for service and complies with the FRA Freight Car Safety Standards (49 CFR part 215) and with the requirements for freight cars used to transport explosives prescribed by the DOT Hazardous Materials Regulation (49 CFR part 174).

Qualified Person Designated Under 49 CFR 215.11

No. 2 _____ Station _____
20 ____.

I have this day personally examined the above car and hereby certify that the explosives in or on this car, or in or on vehicles or in containers have been loaded and braced; that placards have been applied, according to the regulations prescribed by the Department of Transportation; and that the doors of cars so equipped fit or have been stripped so that sparks cannot enter.

Shipper or his authorized agent
Qualified Person Designated Under 49 CFR 215.11

No. 3 _____ Station _____
20 ____.

I hereby certify that I have this day personally supervised the loading of the vehicles or containers on and their securement to the above car.

Shipper or railway employee inspecting loading and securement

NOTE 1: A shipper must decline to use a car not in proper condition.

NOTE 2: All certificates, where applicable, must be signed.

[Amdt. 174-26, 41 FR 16092, Apr. 15, 1976]

EDITORIAL NOTE: For FEDERAL REGISTER citations affecting § 174.104, see the List of CFR Sections Affected, which appears in the Finding Aids section of the printed volume and at www.fdsys.gov.

§ 174.105 Routing shipments, Division 1.1 or 1.2 (explosive) materials.

Before a shipment of Division 1.1 or 1.2 (explosive) materials destined to a point beyond the lines of the initial carrier is accepted from the shipper, the initial carrier shall ascertain that the shipment can go forward by the route designated. To avoid delays en route, the initial carrier must be in possession of full rate information before forwarding the shipment.

[Amdt. 174-26, 41 FR 16092, Apr. 15, 1976, as amended by Amdt. 174-68, 55 FR 52682, Dec. 21, 1990; 66 FR 45383, Aug. 28, 2001]

§ 174.106 "Order-Notify" or "C.O.D." shipments, Division 1.1 or 1.2 (explosive) materials.

(a) A carrier may not accept for transportation Division 1.1 or 1.2 (explosive) materials, detonators, or detonating primers in any quantity when consigned to "order-notify" or "C.O.D.", except on a through bill of lading to a place outside the United States.

(b) A carrier may not accept for transportation Division 1.1 or 1.2 (explosive) materials, detonators, or detonating primers which the shipper consigns to himself unless the shipper has a resident representative to receive them at the delivery point.

(c) A carrier may not accept Division 1.1 or 1.2 (explosive) materials for transportation subject to "stop-off privileges en route for partial loading or unloading."

[Amdt. 174-26, 41 FR 16092, Apr. 15, 1976, as amended by Amdt. 174-36, 44 FR 70732, Dec. 10, 1979; Amdt. 174-68, 55 FR 52682, Dec. 21, 1990; 66 FR 45383, Aug. 28, 2001]

§ 174.110 Car magazine.

When specially authorized by the carrier, Division 1.1 or 1.2 (explosive) materials in quantity not exceeding 68 kg (150 pounds) may be carried in construction or repair cars if the packages

of Class 1 (explosive) materials are placed in a "magazine" box made of sound lumber not less than 2.5 cm (0.98 inch) thick, covered on the exterior with metal, and provided with strong handles. The box must be plainly stenciled on the top, sides, and ends, in letters not less than 5 cm (2 inches) high, "EXPLOSIVES—DANGEROUS—HANDLE CAREFULLY". The box must be provided with strong hinges and with a lock for keeping it securely closed. Vacant space in the box must be filled with a cushioning material such as sawdust or excelsior, and the box must be properly stayed to prevent shifting within the car. The car must be placarded with EXPLOSIVES 1.1 or 1.2 (EXPLOSIVES A) placards when the magazine contains Division 1.1 or 1.2 (explosive) materials.

[Amdt. 174-26, 41 FR 16092, Apr. 15, 1976, as amended by Amdt. 174-26A, 41 FR 40685, Sept. 20, 1976; Amdt. 174-68, 55 FR 52682, Dec. 21, 1990; 66 FR 45383, Aug. 28, 2001; 68 FR 61942, Oct. 30, 2003]

§ 174.112 Loading Division 1.3 materials and Division 1.2 (explosive) materials (Also see § 174.101).

(a) Division 1.3 materials and Division 1.2 (explosive) materials may not be loaded, transported or stored in a rail car equipped with any type of lighted heater or open-flame device, or in a rail car equipped with any apparatus or mechanism utilizing an internal combustion engine in its operation.

(b) Except as provided in §174.101(b), (n), or (o) Division 1.3 materials and Division 1.2 (explosive) materials must be transported in a closed car or container car which is in good condition, and into which sparks cannot enter. The car does not require the car certificates prescribed in §174.104(c) through (f). If the doors are not tight, they must be stripped to prevent the entrance of sparks. Wood floored cars must be equipped with spark shields (see §174.104). Packages of Division 1.3 materials and Division 1.2 (explosive) materials must be blocked and braced to prevent their shifting and possible damage due to shifting of other freight during transportation. For recommended methods of blocking and bracing see Bureau of Explosives Pamphlet No. 6.

(c) Division 1.3 materials and Division 1.2 (explosive) materials may not be transported in a truck body, trailer, or container on a flatcar unless:

(1) The truck body, trailer, or container is closed and tight;

(2) All automatic heating or refrigerating machinery with which the truck body, trailer, or container is equipped is inoperative; and

(3) Packages of Division 1.2 materials and Division 1.3 (explosive) materials are blocked and braced within the truck body, trailer, or container to prevent their shifting and possible damage due to shifting of other freight during transportation (ends, sidewalls, or doors of the truck body, trailer, or container may not be relied on to prevent the shifting of heavy loads). For recommended methods of blocking and bracing see the Intermodal Loading Guide for Products in Closed Trailers and Containers (IBR, see §171.7 of this subchapter).

[Amdt. 174-26, 41 FR 16092, Apr. 15, 1976, as amended by Amdt. 174-26B, 41 FR 57072, Dec. 30, 1976; Amdt. 174-68, 55 FR 52682, Dec. 21, 1990; Amdt. 174-83, 61 FR 51339, Oct. 1, 1996; 66 FR 45383, Aug. 28, 2001; 68 FR 61942, Oct. 30, 2003; 76 FR 43531, July 20, 2011]

§ 174.114 Record to be made of change of seals on "Cars loaded with Division 1.1 or 1.2 (explosive) materials".

When a car seal is changed on a car requiring "EXPLOSIVES 1.1 or EXPLOSIVES 1.2 (EXPLOSIVES A) placards" while en route or before delivery to a consignee, a record of the change showing the following information must be made on or attached to the waybill or other form of memorandum which must accompany the car to its destination:

	Railroad	Place	Date
	Car Initials	Car Number	Number or description of seal broken
Number or description of seal used to reseal car	_____		
Reasons for opening car	_____		
Condition of load	_____		

§ 174.115

Name and occupation of person opening car

[Amdt. 174-26, 41 FR 16092, Apr. 15, 1976, as amended by Amdt. 174-26A, 41 FR 40685, Sept. 20, 1976; Amdt. 174-68, 55 FR 52682, Dec. 21, 1990]

§ 174.115 Loading Division 1.4 (explosive) materials.

(a) Division 1.4 (explosive) materials may be loaded into any closed car in good condition, or into any container car in good condition. Car certificates are not required. Packages of Division 1.4 (explosive) materials must be blocked and braced to prevent their shifting and possible damage due to shifting of other freight during transportation. For methods of recommended loading and bracing see Bureau of Explosives Pamphlet No. 6.

(b) Division 1.4 (explosive) materials may not be transported in a truck body, trailer, or container on a flatcar unless:

(1) The truck body, trailer, or container is closed and tight;

(2) All automatic heating or refrigerating machinery with which the truck body, trailer, or container is equipped is inoperative; and

(3) Packages of Division 1.4 (explosive) materials are blocked and braced within the truck body, trailer, or container to prevent their shifting and possible damage due to shifting of other freight during transportation. Ends, side walls, or doors of the truck body, trailer, or container may not be relied on to prevent shifting of heavy loads. For recommended methods of blocking and bracing see the Intermodal Loading Guide for Products in Closed Trailers and Containers (IBR, see § 171.7 of this subchapter).

[Amdt. 174-26, 41 FR 16092, Apr. 15, 1976, as amended by Amdt. 174-36, 44 FR 70732, Dec. 10, 1979; Amdt. 174-68, 55 FR 52682, Dec. 21, 1990; 66 FR 45383, Aug. 28, 2001; 68 FR 61942, Oct. 30, 2003; 76 FR 43531, July 20, 2011]

Subpart F—Detailed Requirements for Class 2 (Gases) Materials

§ 174.200 Special handling requirements.

(a) Division 2.1 (flammable gas) materials may not be loaded, transported, or stored in a rail car equipped with

49 CFR Ch. I (10–1–14 Edition)

any type of lighted heater or open-flame device, or in a rail car equipped with any apparatus or mechanism utilizing an internal combustion engine in its operation.

(b) Division 2.1 (flammable gas) materials may not be loaded in a truck body or trailer equipped with any type of lighted heater or any automatic heating or refrigerating apparatus when such truck bodies or trailers are loaded on flatcars except as provided in paragraph (c) of this section.

(c) Heating or refrigeration apparatus may be operated on a motor vehicle loaded on a flatcar when the motor vehicle is loaded with Division 2.1 (flammable gas) materials only if:

(1) The lading space is not equipped with any electrical apparatus that is not non-sparking or explosion-proof;

(2) There is no combustion apparatus in the lading space;

(3) There is no connection for the return of air from the lading space to any combustion apparatus; and

(4) The heating system conforms to § 393.77 of this title and does not heat any part of the lading over 54 °C (129 °F).

[Amdt. 174-26, 41 FR 16092, Apr. 15, 1976, as amended by Amdt. 174-68, 55 FR 52682, Dec. 21, 1990; 56 FR 66281, Dec. 20, 1991]

§ 174.201 Class 2 (gases) material cylinders.

(a) Except as provided in paragraphs (b) and (c) of this section, cylinders containing Class 2 (gases) materials being transported in a rail car must be:

(1) Securely lashed in an upright position so as to prevent their overturning;

(2) Loaded into racks securely attached to the car;

(3) Packed in boxes or crates of such dimensions as to prevent their overturning; or

(4) Loaded in a horizontal position.

(b) Specification DOT-4L (§ 178.57 of this subchapter) cylinders being transported in a rail car must be loaded in an upright position and be securely braced.

(c) Cylinders containing Class 2 (gases) materials may be transported in stock cars, gondola cars and flat

cars. However, they may not be transported in hopper bottom cars.

[Amdt. 174-26, 41 FR 16092, Apr. 15, 1976, as amended by Amdt. 174-26A, 41 FR 40685, Sept. 20, 1976; Amdt. 174-32, 43 FR 48644, Oct. 19, 1978; Amdt. 174-68, 55 FR 52682, Dec. 21, 1990]

§ 174.204 Tank car delivery of gases, including cryogenic liquids.

(a) A tank car containing Class 2 (gases) material may not be unloaded unless it is consigned for delivery and unloaded on a private track (see § 171.8 of this subchapter). However, if a private track is not available, it may be delivered and unloaded on carrier tracks subject to the following conditions:

(1) A tank car of DOT-106A or 110A type (§ 179.300 or § 179.301 of this subchapter) may not be delivered and the loaded unit tanks may not be removed from the car frame on carrier tracks. However, a carrier may give permission for the unloading of these containers on carrier tracks only if a private siding is not available within a reasonable trucking distance of the final destination. In addition, before the car is accepted for transportation, the shipper must obtain from the delivering carrier and file with the originating carrier, written permission for the removal and the consignee must furnish an adequately strong mechanical hoist by which the tanks can be lifted from the car and deposited directly upon vehicles furnished by the consignee for immediate removal from carrier property.

(2) The following tank cars may not be delivered and unloaded on carrier tracks unless the lading is piped directly from the car to permanent storage tanks of sufficient capacity to receive the entire contents of the car; however, such cars may be stored on a private track (see § 171.8 of this subchapter) or on carrier tracks designated by the carrier for such storage:

(i) A tank car containing Division 2.1 (flammable gas) material that is a cryogenic liquid; or

(ii) A tank car, except for a DOT-106A or 110A multi-unit tank car tank (§ 179.300 or § 179.301 of this subchapter), containing anhydrous ammonia; hydrogen chloride, refrigerated liquid; hydrocarbon gas, liquefied; or liquefied petroleum gas; and having interior

pipes for liquid and gas discharge valves equipped with check valves.

(b) [Reserved]

[Amdt. 174-26, 41 FR 16092, Apr. 15, 1976, as amended by Amdt. 174-26A, 41 FR 40685, Sept. 20, 1976; Amdt. 174-32, 43 FR 48644, Oct. 19, 1978; Amdt. 174-43, 48 FR 27699, June 16, 1983; 48 FR 50440, 50441, Nov. 1, 1983; Amdt. 174-68, 55 FR 52682, Dec. 21, 1990]

§ 174.290 Materials extremely poisonous by inhalation shipped by, for, or to the Department of Defense.

(a) General. The provisions of this section apply only to materials extremely poisonous by inhalation which are Division 2.3 materials in Hazard Zone A and Division 6.1 materials in Hazard Zone A, as defined in § 173.133(a)(2) of this subchapter. Such materials when shipped by, for, or to the Department of Defense may be transported by rail only if loaded and handled in accordance with the requirements of this section.

(b) A Division 2.3 Hazard Zone A or a Division 6.1 Hazard Zone A material extremely poisonous by inhalation may be transported in:

(1) UN 1N1 or UN 1N2 metal drums or equivalent military specification metal drums, by boxcar, gondola car (flat bottom), or stock car in carload lots. See §§ 174.55 and 174.600 for blocking, bracing, and stowage requirements;

(2) Tanks which are authorized under this subchapter for a Hazard Zone A material extremely poisonous by inhalation, Specification DOT 106A (§§ 179.300 and 179.301 of this subchapter), mounted on or secured to a multi-unit car or gondola car (flat bottom) in carload lots only;

(3) Bombs, by boxcar, or gondola car (flat bottom) in carload lots only; or

(4) Projectiles or ammunition for cannon with gas filled projectiles, by boxcar in carload or less-than-carload lots.

(c) Each shipment of one or more carloads of a material extremely poisonous by inhalation, as described in paragraph (b) of this section, must be accompanied by a Department of Defense qualified escort supplied with equipment to handle leaks and other packaging failures which could result in escape of the material. The escort shall remain with the shipment during

§ 174.300

49 CFR Ch. I (10–1–14 Edition)

the entire time that it is in the custody of the carrier and in the event of leakage or escape of material, shall make repairs and perform decontamination as necessary.

(d) When a material extremely poisonous by inhalation is transported in a tank, the tank must be securely mounted on a rail car especially provided for it or on a gondola car prepared with substantial wooden frames and blocks.

(e) Bombs, projectiles, and cannon ammunition being transported by rail must be loaded, blocked and braced as shown in Bureau of Explosives Pamphlet No. 6A, or Department of Defense specifications. When a shipment is loaded in a gondola car it must be securely blocked and braced and not loaded higher than the sides of the car.

(f) When a material extremely poisonous by inhalation is transported in drums with filling holes in the heads, they must be loaded on their bottoms. They may be loaded in rows, lengthwise of the car and any space between the sides of the car and the nearest row of drums must be “filled in” with wooden boards or lumber nailed to sides of the car sufficient in length and width to contact both hoops of drums, or they may be loaded across the car in staggered stacks of which the number of drums in alternate stacks is reduced by one drum. All drums in stacks following the first stack loaded in the end of the car must be placed tightly into the angle of the space formed by the sidewalls of the drum in the preceding stack. Any space between the sides of the car and the drums in stacks having the greater number of drums must be filled in with wooden boards or lumber nailed to sides of the car sufficient in length and width to contact both hoops of the drums.

(g) When a material extremely poisonous by inhalation is transported in drums with filling holes in the sides, they must be loaded on their sides with the filling holes up. They must be loaded lengthwise of the car in rows and any space between the sides of the car and the nearest row of drums must be filled in with wooden boards or lumber nailed to sides of the car sufficient in length and width to contact both hoops of the drums.

(h) When a material extremely poisonous by inhalation is transported in drums in a boxcar, they must be loaded from ends of the car toward the space between the car doors, and there braced by center gates and wedges. See Sketch 1, Bureau of Explosives Pamphlet No. 6.

(i) The doorways of a boxcar in which a material poisonous by inhalation is being transported must be protected by one of the methods prescribed in Sketch 1, Bureau of Explosives Pamphlet No. 6A.

[Amdt. 174–68, 55 FR 52683, Dec. 21, 1990; Amdt. 174–74, 58 FR 51533, Oct. 1, 1993; 65 FR 58630, Sept. 29, 2000]

Subpart G—Detailed Requirements for Class 3 (Flammable Liquid) Materials

§ 174.300 Special handling requirements.

(a) Class 3 (flammable liquid) materials may not be loaded, transported, or stored in a rail car equipped with any type of lighted heater or open-flame device, or in a rail car equipped with any apparatus or mechanism utilizing an internal combustion engine in its operation.

(b) A truck body or trailer which is loaded with a Class 3 (flammable liquid) materials and equipped with a lighted heater or any automatic heating or refrigerating apparatus may not be loaded on a flatcar except as provided in paragraph (c) of this section.

(c) Heating or refrigeration apparatus on a motor vehicle loaded with Class 3 (flammable liquid) materials may be operated while the motor vehicle is loaded on a flatcar only if:

(1) The lading space is not equipped with any electrical apparatus that is not non-sparking or explosion-proof;

(2) There is no combustion apparatus in the lading space;

(3) There is no connection for the return of air from the lading space to any combustion apparatus; and

(4) The heating system conforms to § 393.77 of this title and does not heat any part of the lading over 54 °C (129 °F).

(d) Metal barrels or drums containing Class 3 (flammable liquid) materials may be transported in a steel gondola

or flatcar or in a stock car. However, they may not be transported in a hopper bottom car.

[Amdt. 174-26, 41 FR 16092, Apr. 15, 1976, as amended by Amdt. 174-31, 43 FR 31143, July 20, 1978; Amdt. 174-68, 55 FR 52683, Dec. 21, 1990]

§ 174.304 Class 3 (flammable liquid) materials in tank cars.

A tank car containing a Class 3 (flammable liquid) material, other than liquid road asphalt or tar, may not be transported by rail unless it is originally consigned or subsequently reconsigned to a party having a private track on which it is to be delivered and unloaded (see §171.8 of this subchapter) or to a party using railroad siding facilities which are equipped for piping the liquid from the tank car to permanent storage tanks of sufficient capacity to receive the entire contents of the car.

[Amdt. 174-26, 41 FR 16092, Apr. 15, 1976, as amended by Amdt. 174-32, 43 FR 48644, Oct. 19, 1978; Amdt. 174-68, 55 FR 52683, Dec. 21, 1990]

Subparts H-I [Reserved]

Subpart J—Detailed Requirements for Division 6.1 (Poisonous) Materials

§ 174.600 Special handling requirements for materials extremely poisonous by inhalation.

A tank car containing a material extremely poisonous by inhalation which is a Division 2.3 material in Hazard Zone A or a Division 6.1 material in Hazard Zone A, as defined in §173.133(a)(2) of this subchapter, may not be transported by rail unless it is originally consigned or subsequently reconsigned to a party having a private track on which it is to be delivered and unloaded (see §171.8 of this subchapter) or to a party using railroad siding facilities which are equipped for piping the liquid or gas from the tank car to permanent storage tanks or sufficient capacity to receive the entire contents of the car. See the requirements in §174.290 for materials extremely poisonous by inhalation which are shipped

by, for, or to the Department of Defense.

[Amdt. 174-68, 55 FR 52684, Dec. 21, 1990]

§ 174.615 Cleaning cars.

(a) [Reserved]

(b) After Division 6.1 (poisonous) materials are unloaded from a rail car, that car must be thoroughly cleaned unless the car is used exclusively in the carriage of Division 6.1 (poisonous) materials.

[Amdt. 174-26, 41 FR 16092, Apr. 15, 1976, as amended by Amdt. 174-68, 55 FR 52684, Dec. 21, 1990; Amdt. 174-82, 61 FR 18933, Apr. 29, 1996]

§ 174.680 Division 6.1 (poisonous) materials with foodstuffs.

(a) Except as provided in paragraph (b) of this section, a carrier may not transport any package bearing a POISON or POISON INHALATION HAZARD label in the same car with any material marked as, or known to be, a foodstuff, feed or any other edible material intended for consumption by humans or animals.

(b) A carrier must separate any package bearing a POISON label displaying the text "PG III," or bearing a "PG III" mark adjacent to the POISON label, from materials marked as or known to be foodstuffs, feed or any other edible materials intended for consumption by humans or animals, as required in §174.81(e)(3) for classes identified with the letter "O" in the Segregation Table for Hazardous Materials.

[64 FR 10781, Mar. 5, 1999]

Subpart K—Detailed Requirements for Class 7 (Radioactive) Materials

§ 174.700 Special handling requirements for Class 7 (radioactive) materials.

(a) Each rail shipment of low specific activity materials or surface contaminated objects as defined in §173.403 of this subchapter must be loaded so as to avoid spillage and scattering of loose material. Loading restrictions are prescribed in §173.427 of this subchapter.

(b) The number of packages of Class 7 (radioactive) materials that may be transported by rail car or stored at any

§ 174.715

49 CFR Ch. I (10–1–14 Edition)

single location is limited to a total transport index and a total criticality safety index (as defined in §173.403 of this subchapter) of not more than 50 each. This provision does not apply to exclusive use shipments as described in §§173.403, 173.427, 173.441, and 173.457 of this subchapter.

(c) Each package of Class 7 (radioactive) material bearing RADIOACTIVE YELLOW-II or RADIOACTIVE YELLOW-III labels may not be placed closer than 0.9 m (3 feet) to an area (or dividing partition between areas) which may be continuously occupied by any passenger, rail employee, or shipment of one or more animals, nor closer than 4.5 m (15 feet) to any package containing undeveloped film (if so marked). If more than one package of Class 7 (radioactive) materials is present, the distance must be computed from the table below on the basis of the total transport index number (determined by adding together the transport index numbers on the labels of the individual packages) of packages in the rail car or storage area:

Total transport index	Minimum separation distance to nearest undeveloped film		Minimum distance to area of persons or minimum distance from dividing partition of a combination car	
	Meters	Feet	Meters	Feet
	None	0	0	0
0.1 to 10.0	4.5	15	0.9	3
10.1 to 20.0	6.7	22	1.2	4
20.1 to 30.0	7.7	29	1.5	5
30.1 to 40.0	10	33	1.8	6
40.1 to 50.0	10.9	36	2.1	7

NOTE: The distance in this table must be measured from the nearest point on the nearest packages of Class 7 (radioactive) materials.

(d) Each shipment of fissile material packages must conform to requirements of §§173.457 and 173.459.

(e) [Reserved]

(f) A person shall not remain unnecessarily in, on or near a transport vehicle containing Class 7 (radioactive) materials.

(g) In the case of packages shipped under the exclusive use provisions of §173.441(b) of this subchapter for packages with external radiation levels in excess of 2 mSv per hour (200 mrem per hour) at the package surface—

(1) The transport vehicle must meet the requirements for a closed transport vehicle (§173.403 of this subchapter);

(2) Each package must be secured so that its position within the transport vehicle remains fixed under conditions normally incident to transportation; and

(3) The radiation level may not exceed 0.02 mSv per hour (2 mrem per hour) in any normally occupied position in the transport vehicle or adjacent rail car.

[Amdt. 174-80, 60 FR 50331, Sept. 28, 1995, as amended by Amdt. 174-80, 61 FR 20753, May 8, 1996; 66 FR 45383, Aug. 28, 2001; 69 FR 3693, Jan. 26, 2004; 79 FR 40618, July 11, 2014]

§ 174.715 Cleanliness of transport vehicles after use.

(a) Each transport vehicle used for transporting Class 7 (radioactive) materials under exclusive use conditions (as defined in §173.403 of this subchapter) in accordance with §173.427(b)(4), §173.427(c), or §173.443(b), must be surveyed with appropriate radiation detection instruments after each use. A transport vehicle may not be returned to Class 7 (radioactive) materials exclusive use transport service, and then only for a subsequent exclusive use shipment utilizing the provisions of any of the paragraphs §173.427(b)(4), §173.427(c), or §173.443(b), until the radiation dose rate at any accessible surface is 0.005 mSv per hour (0.5 mrem per hour) or less, and there is no significant non-fixed contamination, as specified in §173.443(a) of this subchapter.

(b) This section does not apply to any transport vehicle used solely for transporting Class 7 (radioactive) materials if a survey of the interior surface shows that the radiation dose rate does not exceed 0.1 mSv per hour (10 mrem per hour) at the interior surface or 0.02 mSv per hour (2 mrem per hour) at 1 m (3.3 feet) from any interior surface. The transport vehicle must be stenciled with the words “FOR RADIOACTIVE MATERIALS USE ONLY” in lettering at least 7.6 cm (3 inches) high in a conspicuous place on both sides of the exterior of the transport vehicle, and it

must be kept closed at all times other than during loading and unloading.

[Amdt. 174-80, 60 FR 50332, Sept. 28, 1995, as amended by 66 FR 45383, Aug. 28, 2001; 79 FR 40618, July 11, 2014]

§ 174.750 Incidents involving leakage.

(a) In addition to the incident reporting requirements of §§171.15 and 171.16 of this subchapter, the carrier shall also notify the offeror at the earliest practicable moment following any incident in which there has been breakage, spillage, or suspected radioactive contamination involving Class 7 (radioactive) materials shipments. Transport vehicles, buildings, areas, or equipment in which Class 7 (radioactive) materials have been spilled may not be again placed in service or routinely occupied until the radiation dose rate at every accessible surface is less than 0.005 mSv per hour (0.5 mrem per hour) and there is no significant removable radioactive surface contamination (see §173.443 of this subchapter).

(b) The package or materials should be segregated as far as practicable from personnel contact. If radiological advice or assistance is needed, the U.S. Department of Energy (DOE) should also be notified. In case of obvious leakage, or if it appears likely that the inside container may have been damaged, care should be taken to avoid inhalation, ingestion, or contact with the Class 7 (radioactive) material. Any loose Class 7 (radioactive) materials should be left in a segregated area and held pending disposal instructions, from qualified persons.

[Amdt. 174-26, 41 FR 16092, Apr. 15, 1976, as amended by Amdt. 174-42, 48 FR 10245, Mar. 10, 1983; Amdt. 174-61, 51 FR 34987, Oct. 1, 1986; Amdt. 174-65, 53 FR 38274, Sept. 29, 1988; Amdt. 174-68, 55 FR 52684, Dec. 21, 1990; Amdt. 174-80, 60 FR 50332, Sept. 28, 1995]

PART 175—CARRIAGE BY AIRCRAFT

Subpart A—General Information and Regulations

Sec.

175.1 Purpose, scope and applicability.

175.3 Unacceptable hazardous materials shipments.

175.8 Exceptions for operator equipment and items of replacement.

175.9 Special aircraft operations.

175.10 Exceptions for passengers, crewmembers, and air operators.

175.20 Compliance and training.

175.25 Notification at air passenger facilities of hazardous materials restrictions.

175.26 Notification at cargo facilities of hazardous materials requirements.

175.30 Inspecting shipments.

175.31 Reports of discrepancies.

175.33 Shipping paper and notification of pilot-in-command.

175.34 Exceptions for cylinders of compressed oxygen or other oxidizing gases transported within the State of Alaska.

Subpart B—Loading, Unloading and Handling

175.75 Quantity limitations and cargo location.

175.78 Stowage compatibility of cargo.

175.88 Inspection, orientation and securing of packages of hazardous materials.

175.90 Damaged shipments.

Subpart C—Specific Regulations Applicable According to Classification of Material

175.310 Transportation of flammable liquid fuel; aircraft only means of transportation

175.501 Special requirements for oxidizers and compressed oxygen.

175.630 Special requirements for Division 6.1 (poisonous) material and Division 6.2 (infectious substances) materials.

175.700 Special limitations and requirements for Class 7 materials.

175.701 Separation distance requirements for packages containing Class 7 (radioactive) materials in passenger-carrying aircraft.

175.702 Separation distance requirements for packages containing Class 7 (radioactive) materials in cargo aircraft.

175.703 Other special requirements for the acceptance and carriage of packages containing Class 7 materials.

175.704 Plutonium shipments.

175.705 Radioactive contamination.

175.706 Separation distances for undeveloped film from packages containing Class 7 (radioactive) materials.

175.900 Handling requirements for carbon dioxide, solid (dry ice).

AUTHORITY: 49 U.S.C. 5101-5128; 44701; 49 CFR 1.81 and 1.97.

SOURCE: 71 FR 14604, Mar. 22, 2006, unless otherwise noted.

Subpart A—General Information and Regulations

§ 175.1 Purpose, scope and applicability.

(a) This part prescribes requirements that apply to the transportation of hazardous materials in commerce aboard (including attached to or suspended from) aircraft. The requirements in this part are in addition to other requirements contained in parts 171, 172, 173, 178, and 180 of this subchapter.

(b) This part applies to the offering, acceptance, and transportation of hazardous materials in commerce by aircraft to, from, or within the United States, and to any aircraft of United States registry anywhere in air commerce. This subchapter applies to any person who performs, attempts to perform, or is required to perform any function subject to this subchapter, including—(1) Air carriers, indirect air carriers, and freight forwarders and their flight and non-flight employees, agents, subsidiary and contract personnel (including cargo, passenger and baggage acceptance, handling, loading and unloading personnel); and

(2) Air passengers that carry any hazardous material on their person or in their carry-on or checked baggage.

(c) This part does not apply to aircraft of United States registry under lease to and operated by foreign nationals outside the United States if:

(1) Hazardous materials forbidden aboard aircraft by § 172.101 of this subchapter are not carried on the aircraft; and

(2) Other hazardous materials are carried in accordance with the regulations of the State (nation) of the aircraft operator.

§ 175.3 Unacceptable hazardous materials shipments.

A hazardous material that is not prepared for shipment in accordance with this subchapter may not be offered or accepted for transportation or transported aboard an aircraft.

§ 175.8 Exceptions for operator equipment and items of replacement.

(a) *Operator equipment.* This subchapter does not apply to—

(1) Aviation fuel and oil in tanks that are in compliance with the installation provisions of 14 CFR, chapter 1.

(2) Hazardous materials required aboard an aircraft in accordance with the applicable airworthiness requirements and operating regulations. Items of replacement for such materials must be transported in accordance with paragraph (a)(3) of this section.

(3) Items of replacement (company material (COMAT)) for hazardous materials described in paragraph (a)(2) of this section must be transported in accordance with this subchapter. When an operator transports its own replacement items described in paragraph (a)(2), the following exceptions apply:

(i) In place of required packagings, packagings specifically designed for the items of replacement may be used, provided such packagings provide at least an equivalent level of protection to those that would be required by this subchapter.

(ii) Aircraft batteries are not subject to quantity limitations such as those provided in § 172.101 or § 175.75(c) of this subchapter.

(4) Unless otherwise addressed by FAA regulation or policy (e.g. Advisory Circular), hazardous materials used by the operator aboard the aircraft, when approved by the Administrator of the Federal Aviation Administration.

(b) *Other operator exceptions.* This subchapter does not apply to—

(1) Oxygen, or any hazardous material used for the generation of oxygen, for medical use by a passenger, which is furnished by the aircraft operator in accordance with 14 CFR 121.574 or 135.91. For the purposes of this paragraph, an aircraft operator that does not hold a certificate under 14 CFR parts 121 or 135 may apply this exception in conformance with 14 CFR 121.574 or 135.91 in the same manner as required for a certificate holder. See § 175.501 for additional requirements applicable to the stowage of oxygen.

(2) Dry ice (carbon dioxide, solid) intended for use by the operator in food and beverage service aboard the aircraft.

(3) Aerosols of Division 2.2 only (for dispensing of food products), alcoholic beverages, colognes, liquefied gas lighters, perfumes, and portable electronic

devices containing lithium cells or batteries that meet the requirements of § 175.10(a)(18) carried aboard a passenger-carrying aircraft by the operator for use or sale on that specific aircraft. A liquefied gas lighter design must be examined and successfully tested by a person or agency authorized by the Associate Administrator.

(4) A tire assembly with a serviceable tire, provided the tire is not inflated to a gauge pressure exceeding the maximum rated pressure for that tire, and the tire (including valve assemblies) is protected from damage during transport. A tire or tire assembly which is unserviceable or damaged is forbidden from air transport; however, a damaged tire is not subject to the requirements of this subchapter if it contains no material meeting the definition of a hazardous material (e.g., Division 2.2).

[71 FR 14604, Mar. 22, 2006, as amended at 72 FR 55693, Oct. 1, 2007; 76 FR 3381, Jan. 19, 2011; 78 FR 1092, Jan. 7, 2013; 79 FR 46039, Aug. 6, 2014]

§ 175.9 Special aircraft operations.

(a) This subchapter applies to rotorcraft external load operations transporting hazardous material on board, attached to, or suspended from an aircraft. Operators must have all applicable requirements prescribed in 14 CFR part 133 approved by the FAA Administrator prior to accepting or transporting hazardous material. In addition, rotorcraft external load operations must be approved by the Associate Administrator prior to the initiation of such operations.

(b) *Exceptions.* This subchapter does not apply to the following materials used for special aircraft operations when applicable FAA operator requirements have been met, including training operator personnel on the proper handling and stowage of the hazardous materials carried:

(1) Hazardous materials loaded and carried in hoppers or tanks of aircraft certificated for use in aerial seeding, dusting spraying, fertilizing, crop improvement, or pest control, to be dispensed during such an operation.

(2) Parachute activation devices, lighting equipment, oxygen cylinders, flotation devices, smoke grenades,

flares, or similar devices carried during a parachute operation.

(3) Smoke grenades, flares, and pyrotechnic devices affixed to aircraft during any flight conducted as part of a scheduled air show or exhibition of aeronautical skill. The aircraft may not carry any persons other than required flight crewmembers. The affixed installation accommodating the smoke grenades, flares, or pyrotechnic devices on the aircraft must be approved for its intended use by the FAA Flight Standards District Office having responsibility for that aircraft.

(4) Hazardous materials are carried and used during dedicated air ambulance, fire fighting, or search and rescue operations.

(5) A transport incubator unit necessary to protect life or an organ preservation unit necessary to protect human organs, carried in the aircraft cabin, provided:

(i) The compressed gas used to operate the unit is in an authorized DOT specification cylinder and is marked, labeled, filled, and maintained as prescribed by this subchapter;

(ii) Each battery used is of the non-spillable type;

(iii) The unit is constructed so that valves, fittings, and gauges are protected from damage;

(iv) The pilot-in-command is advised when the unit is on board, and when it is intended for use;

(v) The unit is accompanied by a person qualified to operate it;

(vi) The unit is secured in the aircraft in a manner that does not restrict access to or use of any required emergency or regular exit or of the aisle in the passenger compartment; and,

(vii) Smoking within 3 m (10 feet) of the unit is prohibited.

(6) Hazardous materials that are loaded and carried on or in cargo only aircraft, and that are to be dispensed or expended during flight for weather control, environmental restoration or protection, forest preservation and protection, fire fighting and prevention, flood control, or avalanche control purposes, when the following requirements are met:

(i) Operations may not be conducted over densely populated areas, in a congested airway, or near any airport

where carrier passenger operations are conducted.

(ii) Each operator must prepare and keep current a manual containing operational guidelines and handling procedures, for the use and guidance of flight, maintenance, and ground personnel concerned in the dispensing or expending of hazardous materials. The manual must be approved by the FAA Principal Operations Inspector assigned to the operator.

(iii) No person other than a required flight crewmember, FAA inspector, or person necessary for handling or dispensing the hazardous material may be carried on the aircraft.

(iv) The operator of the aircraft must have advance permission from the owner of any airport to be used for the dispensing or expending operation.

(v) When Division 1.1, 1.2, and 1.3 materials (except detonators and detonator assemblies) and detonators or detonator assemblies are carried for avalanche control flights, the explosives must be handled by, and at all times be under the control of, a qualified blaster. When required by a State or local authority, the blaster must be licensed and the State or local authority must be identified in writing to the FAA Principal Operations Inspector assigned to the operator.

[76 FR 3381, Jan. 19, 2011]

§ 175.10 Exceptions for passengers, crewmembers, and air operators.

(a) This subchapter does not apply to the following hazardous materials when carried by aircraft passengers or crewmembers provided the requirements of §§171.15 and 171.16 (see paragraph (c) of this section) and the requirements of this section are met:

(1) (i) Non-radioactive medicinal and toilet articles for personal use (including aerosols) carried in carry-on and checked baggage. Release devices on aerosols must be protected by a cap or other suitable means to prevent inadvertent release;

(ii) Other aerosols in Div. 2.2 (non-flammable gas) with no subsidiary risk carried in checked baggage only. Release devices on aerosols must be protected by a cap or other suitable means to prevent inadvertent release; and

(iii) The aggregate quantity of these hazardous materials carried by each person may not exceed 2 kg (70 ounces) by mass or 2 L (68 fluid ounces) by volume and the capacity of each container may not exceed 0.5 kg (18 ounces) by mass or 500 ml (17 fluid ounces) by volume.

(2) One packet of safety matches or a lighter intended for use by an individual when carried on one's person or in carry-on baggage only. Lighter fuel, lighter refills, and lighters containing unabsorbed liquid fuel (other than liquefied gas) are not permitted on one's person or in carry-on or checked baggage.

(3) Implanted medical devices in humans or animals that contain hazardous materials, such as a heart pacemaker containing Class 7 (radioactive) material or lithium batteries; and radiopharmaceuticals that have been injected or ingested.

(4) Alcoholic beverages containing:

(i) Not more than 24% alcohol by volume; or

(ii) More than 24% and not more than 70% alcohol by volume when in unopened retail packaging not exceeding 5 liters (1.3 gallons) carried in carry-on or checked baggage, with a total net quantity per person of 5 liters (1.3 gallons) for such beverages.

(5) Perfumes and colognes purchased through duty-free sales and carried on one's person or in carry-on baggage.

(6) Hair curlers (curling irons) containing a hydrocarbon gas such as butane, no more than one per person, in carry-on or checked baggage. The safety cover must be securely fitted over the heating element. Gas refills for such curlers are not permitted in carry-on or checked baggage.

(7) A small medical or clinical mercury thermometer for personal use, when carried in a protective case in carry-on or checked baggage.

(8) Small arms ammunition for personal use carried by a crewmember or passenger in checked baggage only, if securely packed in boxes or other packaging specifically designed to carry small amounts of ammunition. Ammunition clips and magazines must also be securely boxed. This paragraph does not apply to persons traveling under the provisions of 49 CFR 1544.219.

(9) One self-defense spray (see §171.8 of this subchapter), not exceeding 118 mL (4 fluid ounces) by volume, that incorporates a positive means to prevent accidental discharge may be carried in checked baggage only.

(10) Dry ice (carbon dioxide, solid), with the approval of the operator:

(i) Quantities may not exceed 2.5 kg (5.5 pounds) per person when used to pack perishables not subject to the HMR. The package must permit the release of carbon dioxide gas; and

(ii) When carried in checked baggage, each package is marked "DRY ICE" or "CARBON DIOXIDE, SOLID," and marked with the net weight of dry ice or an indication the net weight is 2.5 kg (5.5 pounds) or less.

(11) A self-inflating life jacket fitted with no more than two small gas cartridges (containing no hazardous material other than a Div. 2.2 gas) for inflation purposes plus no more than two spare cartridges. The lifejacket and spare cartridges may be carried in carry-on or checked baggage, with the approval of the aircraft operator.

(12) Small compressed gas cylinders of Division 2.2 (containing no hazardous material other than a Division 2.2 gas) worn by the passenger for the operation of mechanical limbs and, in carry-on and checked baggage, spare cylinders of a similar size for the same purpose in sufficient quantities to ensure an adequate supply for the duration of the journey.

(13) A mercury barometer or thermometer carried as carry-on baggage, by a representative of a government weather bureau or similar official agency, provided that individual advises the operator of the presence of the barometer or thermometer in his baggage. The barometer or thermometer must be packaged in a strong packaging having a sealed inner liner or bag of strong, leak proof and puncture-resistant material impervious to mercury, which will prevent the escape of mercury from the package in any position.

(14) Electrically powered heat-producing articles (e.g., battery-operated equipment such as diving lamps and soldering equipment) as checked or carry-on baggage only and with the approval of the operator of the aircraft.

The heat-producing component, the energy source, or other component (e.g., fuse) must be removed to prevent unintentional functioning during transport. Any battery that is removed must be protected against short circuit by placement in original retail packaging or by otherwise insulating terminals (e.g., by taping over exposed terminals or placing each battery in a separate plastic bag or protective pouch).

(15) A wheelchair or other battery-powered mobility aid equipped with a nonspillable battery or a dry sealed battery when carried as checked baggage, provided—

(i) The battery conforms to the requirements of §173.159a(d) of this subchapter for non-spillable batteries;

(ii) The battery conforms to the requirements of §172.102(c)(1), Special provision 130 of this subchapter for dry sealed batteries, as applicable;

(iii) Visual inspection including removal of the battery, where necessary, reveals no obvious defects (removal of the battery from the housing should be performed by qualified airline personnel only);

(iv) The battery is disconnected and the battery terminals are protected to prevent short circuits, unless the wheelchair or mobility aid design provides an effective means of preventing unintentional activation, and

(v) The battery is—

(A) Securely attached to the wheelchair or mobility aid;

(B) Is removed and placed in a strong, rigid packaging marked "NONSPILLABLE BATTERY" (unless fully enclosed in a rigid housing that is properly marked);

(C) Is removed and placed in a strong, rigid packaging marked with the words "not restricted" in accordance with paragraph (c)(2) of §172.102, Special provision 130, of this subchapter; or

(D) Is handled in accordance with paragraph (a)(16)(iv) of this section.

(16) A wheelchair or other battery-powered mobility aid equipped with a spillable battery, when carried as checked baggage, provided—

(i) Visual inspection including removal of the battery, where necessary, reveals no obvious defects (however, removal of the battery from the housing

§ 175.10

49 CFR Ch. I (10–1–14 Edition)

should be performed by qualified airline personnel only);

(ii) The battery is disconnected and terminals are insulated to prevent short circuits;

(iii) The pilot-in-command is advised, either orally or in writing, prior to departure, as to the location of the battery aboard the aircraft; and

(iv) The wheelchair or mobility aid is loaded, stowed, secured and unloaded in an upright position, or the battery is removed, and carried in a strong, rigid packaging under the following conditions:

(A) The packaging must be leak-tight and impervious to battery fluid. An inner liner may be used to satisfy this requirement if there is absorbent material placed inside of the liner and the liner has a leakproof closure;

(B) The battery must be protected against short circuits, secured upright in the packaging, and be packaged with enough compatible absorbent material to completely absorb liquid contents in the event of rupture of the battery; and

(C) The packaging must be labeled with a CORROSIVE label, marked to indicate proper orientation, and marked with the words "Battery, wet, with wheelchair."

(17) A wheelchair or other mobility aid equipped with a lithium ion battery, when carried as checked baggage, provided—

(i) The lithium ion battery must be of a type that successfully passed each test in the UN Manual of Tests and Criteria (IBR; see §171.7 of this subchapter), as specified in §173.185 of this subchapter, unless approved by the Associate Administrator;

(ii) The operator must verify that:

(A) Visual inspection of the wheelchair or other mobility aid reveals no obvious defects;

(B) Battery terminals are protected from short circuits (e.g., enclosed within a battery housing);

(C) The battery must be securely attached to the mobility aid; and

(D) Electrical circuits are isolated;

(iii) The wheelchair or other mobility aid must be loaded and stowed in such a manner to prevent its unintentional activation and its battery must be protected from short circuiting;

(iv) The wheelchair or other mobility aid must be protected from damage by the movement of baggage, mail, service items, or other cargo;

(v) Where a lithium ion battery-powered wheelchair or other mobility aid is specifically designed to allow its battery to be removed by the user (e.g., collapsible):

(A) The battery must be removed from the wheelchair or other mobility aid according to instructions provided by the wheelchair or other mobility aid owner or its manufacturer;

(B) The battery must be carried in carry-on baggage only;

(C) Battery terminals must be protected from short circuits (by placement in original retail packaging or otherwise insulating the terminal e.g. by taping over exposed terminals or placing each battery in a separate plastic bag or protective pouch);

(D) The battery must not exceed 25 grams aggregate equivalent lithium content; and

(E) A maximum of one spare battery not exceeding 25 grams aggregate equivalent lithium content or two spares not exceeding 13.5 grams aggregate equivalent lithium content each may be carried;

(vi) The pilot-in-command is advised either orally or in writing, prior to departure, as to the location of the lithium ion battery or batteries aboard the aircraft.

(18) Except as provided in §173.21 of this subchapter, portable electronic devices (e.g., watches, calculating machines, cameras, cellular phones, laptop and notebook computers, camcorders, medical devices etc.) containing dry cells or dry batteries (including lithium cells or batteries) and spare dry cells or batteries for these devices, when carried by passengers or crew members for personal use. Portable electronic devices powered by lithium batteries may be carried in either checked or carry-on baggage. Spare lithium batteries must be carried in carry-on baggage only. Each installed or spare lithium battery must be of a type proven to meet the requirements of each test in the UN Manual of Tests and Criteria, Part III, Sub-section 38.3 and each spare lithium battery must be individually protected so as to prevent

short circuits (e.g., by placement in original retail packaging, by otherwise insulating terminals by taping over exposed terminals, or placing each battery in a separate plastic bag or protective pouch). In addition, each installed or spare lithium battery must not exceed the following:

(i) For a lithium metal battery, a lithium content of not more than 2 grams per battery; or

(ii) For a lithium ion battery, the Watt-hour rating must not exceed 100 Wh. With the approval of the operator, portable electronic devices may contain lithium ion batteries exceeding 100 Wh, but not exceeding 160 Wh and no more than two individually protected lithium ion batteries each exceeding 100 Wh, but not exceeding 160 Wh, may be carried per person as spare batteries in carry-on baggage.

(19) Fuel cells used to power portable electronic devices (e.g., cameras, cellular phones, laptop computers and camcorders) and spare fuel cell cartridges when transported personal use under the following conditions:

(i) Fuel cells and fuel cell cartridges may contain only Division 2.1 liquefied flammable gas, or hydrogen in a metal hydride, Class 3 flammable liquid (including methanol), Division 4.3 water-reactive material, or Class 8 corrosive material;

(ii) The quantity of fuel in any fuel cell or fuel cell cartridge may not exceed:

(A) 200 mL (6.76 ounces) for liquids;

(B) 120 mL (4 fluid ounces) for liquefied gases in non-metallic fuel cell cartridges, or 200 mL (6.76 ounces) for liquefied gases in metal fuel cell cartridges;

(C) 200 g (7 ounces) for solids; or

(D) For hydrogen in metal hydride, the fuel cell cartridges must have a water capacity of 120 mL (4 fluid ounces) or less;

(iii) No more than two spare fuel cell cartridges may be carried by a passenger or crew member as follows:

(A) Fuel cell cartridges containing Class 3 flammable liquid (including methanol) and Class 8 corrosive material in carry-on or checked baggage; and

(B) Division 2.1 liquefied flammable gas or hydrogen in a metal hydride and

Division 4.3 water-reactive material in carry-on baggage only;

(iv) Fuel cells containing fuel are permitted in carry-on baggage only;

(v) Fuel cell cartridges containing hydrogen in a metal hydride must meet the requirements in §173.230(d) of this subchapter;

(vi) Refueling of a fuel cell aboard an aircraft is not permitted except that the installation of a spare cartridge is allowed;

(vii) Each fuel cell and fuel cell cartridge must conform to IEC 62282-6-100 and IEC 62282-6-100 Amend. 1 (IBR; see §171.7 of this subchapter) and must be marked with a manufacturer's certification that it conforms to the specification. In addition, each fuel cell cartridge must be marked with the maximum quantity and type of fuel in the cartridge;

(viii) Interaction between fuel cells and integrated batteries in a device must conform to IEC 62282-6-100 and IEC 62282-6-100 Amend. 1 (IBR, see §171.7 of this subchapter). Fuel cells whose sole function is to charge a battery in the device are not permitted; and

(ix) Fuel cells must be of a type that will not charge batteries when the consumer electronic device is not in use and must be durably marked by the manufacturer with the wording: "APPROVED FOR CARRIAGE IN AIRCRAFT CABIN ONLY" to indicate that the fuel cell meets this requirement.

(20) Permeation devices for calibrating air quality monitoring equipment when carried in checked baggage provided the devices are constructed and packaged in accordance with §173.175.

(21) An internal combustion or fuel cell engine or a machine or apparatus containing an internal combustion or fuel cell engine when carried as checked baggage, provided—

(i) The engine contains no liquid or gaseous fuel. An engine may be considered as not containing fuel when the engine components and any fuel lines have been completely drained, sufficiently cleaned of residue, and purged of vapors to remove any potential hazard and the engine when held in any orientation will not release any liquid fuel;

§ 175.20

(ii) The fuel tank contains no liquid or gaseous fuel. A fuel tank may be considered as not containing fuel when the fuel tank and the fuel lines have been completely drained, sufficiently cleaned of residue, and purged of vapors to remove any potential hazard;

(iii) It is not equipped with a wet battery (including a non-spillable battery), a sodium battery or a lithium battery; and

(iv) It contains no other hazardous materials subject to the requirements of this subchapter.

(22) Non-infectious specimens transported in accordance with §173.4b(b).

(23) Insulated packagings containing refrigerated liquid nitrogen when carried in checked or carry-on baggage in accordance with the ICAO Technical Instructions (IBR, see §171.7 of this subchapter), Packing Instruction 202, the packaging specifications in part 6, chapter 5, and special provision A152.

(24) Small cartridges fitted into devices with no more than four small cylinders of carbon dioxide or other suitable gas in Division 2.2. The water capacity of each cylinder must not exceed 50 mL (equivalent to a 28 g carbon dioxide cartridge), with the approval of the operator.

(b) The exceptions provided in paragraph (a) of this section also apply to aircraft operators when transporting passenger or crewmember baggage that has been separated from the passenger or crewmember, including transfer to another carrier for transport to its final destination.

(c) The requirements to submit incident reports as required under §§171.15 and 171.16 of this subchapter apply to the air carrier.

[71 FR 14604, Mar. 22, 2006, as amended at 71 FR 78634, Dec. 29, 2006; 72 FR 44950, Aug. 9, 2007; 73 FR 4719, Jan. 28, 2008; 73 FR 23367, Apr. 30, 2008; 74 FR 2266, Jan. 14, 2009; 75 FR 73, Jan. 4, 2010; 76 FR 3381, Jan. 19, 2011; 76 FR 43531, July 20, 2011; 76 FR 82178, Dec. 30, 2011; 78 FR 1093, 1117, Jan. 7, 2013; 78 FR 65485, Oct. 31, 2013; 79 FR 46040, Aug. 6, 2014]

§ 175.20 Compliance and training.

An air carrier may not transport a hazardous material by aircraft unless each of its hazmat employees involved in that transportation is trained as required by subpart H of part 172 of this

49 CFR Ch. I (10–1–14 Edition)

subchapter. In addition, air carriers must comply with all applicable hazardous materials training requirements in 14 CFR part 121 and 135.

§ 175.25 Notification at air passenger facilities of hazardous materials restrictions.

(a) *Notices of requirements.* Each person who engages in for-hire air transportation of passengers must display notices of the requirements applicable to the carriage of hazardous materials aboard aircraft, and the penalties for failure to comply with those requirements in accordance with this section. Each notice must be legible, and be prominently displayed so it can be seen by passengers in locations where the aircraft operator issues tickets, checks baggage, and maintains aircraft boarding areas. At a minimum, each notice must communicate the following information:

(1) Federal law forbids the carriage of hazardous materials aboard aircraft in your luggage or on your person. A violation can result in five years' imprisonment and penalties of \$250,000 or more (49 U.S.C. 5124). Hazardous materials include explosives, compressed gases, flammable liquids and solids, oxidizers, poisons, corrosives and radioactive materials. Examples: Paints, lighter fluid, fireworks, tear gases, oxygen bottles, and radio-pharmaceuticals.

(2) There are special exceptions for small quantities (up to 70 ounces total) of medicinal and toilet articles carried in your luggage and certain smoking materials carried on your person. For further information contact your airline representative.

(b) *Ticket purchase.* During the ticket purchase process, regardless if the process is completed remotely (e.g., via the Internet or phone) or when completed at the airport, with or without assistance from another person (e.g., automated check-in facility), the aircraft operator must ensure that information on the types of hazardous materials a passenger is forbidden to transport aboard an aircraft is provided to passengers. Information may be in text or in pictorial form and, effective January 1, 2015, must be such that the final ticket purchase cannot

be completed until the passenger or a person acting on the passenger's behalf has indicated that it understands the restrictions on hazardous materials in baggage.

(c) *Check-in.* Effective January 1, 2015, when the flight check-in process is conducted remotely (e.g., via the Internet or phone) or when completed at the airport, without assistance from another person (e.g., automated check-in kiosk), the aircraft operator must ensure that information on the types of hazardous materials a passenger is forbidden to transport aboard an aircraft is provided to passengers. Information may be in text or in pictorial form and should be such that the check in process cannot be completed until the passenger or a person acting on the passenger's behalf has indicated that it understands the restrictions on hazardous materials in baggage.

(d) *Signage.* When the check in process is not conducted remotely (e.g., at the airport with the assistance of an airline representative), passenger notification of permitted and forbidden hazardous materials may be completed through signage (electronic or otherwise), provided it is legible and prominently displayed.

[78 FR 65486, Oct. 31, 2013]

§ 175.26 Notification at cargo facilities of hazardous materials requirements.

(a) Each person who engages in the acceptance or transport of cargo for transportation by aircraft shall display notices to persons offering such cargo of the requirements applicable to the carriage of hazardous materials aboard aircraft, and the penalties for failure to comply with those requirements, at each facility where cargo is accepted. Each notice must be legible, and be prominently displayed so it can be seen. At a minimum, each notice must communicate the following information:

(1) Cargo containing hazardous materials (dangerous goods) for transportation by aircraft must be offered in accordance with the Federal Hazardous Materials Regulations (49 CFR parts 171 through 180).

(2) A violation can result in five years' imprisonment and penalties of \$250,000 or more (49 U.S.C. 5124).

(3) Hazardous materials (dangerous goods) include explosives, compressed gases, flammable liquids and solids, oxidizers, poisons, corrosives and radioactive materials.

(b) The information contained in paragraph (a) of this section must be printed:

(1) Legibly in English, and, where cargo is accepted outside of the United States, in the language of the host country; and

(2) On a background of contrasting color.

(c) Size and color of the notice are optional. Additional information, examples, or illustrations, if not inconsistent with required information, may be included.

(d) *Exceptions.* Display of a notice required by paragraph (a) of this section is not required at:

(1) An unattended location (e.g., a drop box) provided a general notice advising customers of a prohibition on shipments of hazardous materials through that location is prominently displayed; or

(2) A customer's facility where hazardous materials packages are accepted by a carrier.

§ 175.30 Inspecting shipments.

(a) No person may accept a hazardous material for transportation aboard an aircraft unless the aircraft operator ensures the hazardous material is:

(1) Authorized, and is within the quantity limitations specified for carriage aboard aircraft according to §172.101 of this subchapter or as otherwise specifically provided by this subchapter.

(2) Described and certified on a shipping paper prepared in duplicate in accordance with part 172 of this subchapter or as authorized by subpart C of part 171 of this subchapter. See §175.33 for shipping paper retention requirements;

(3) Marked and labeled in accordance with subparts D and E of part 172 or as authorized by subpart C of part 171 of this subchapter, and placarded (when required) in accordance with subpart F of part 172 of this subchapter; and

§ 175.31

(4) Labeled with a “CARGO AIR-CRAFT ONLY” label (see §172.448 of this subchapter) if the material as presented is not permitted aboard passenger-carrying aircraft.

(5) Described on alternative written documentation when authorized in accordance with §173.185(c)(4)(v). See §175.33 for alternative written documentation retention requirements.

(b) Except as provided in paragraph (d) of this section, no person may carry a hazardous material in a package, outside container, or overpack aboard an aircraft unless the package, outside container, or overpack is inspected by the operator of the aircraft immediately before placing it:

(1) Aboard the aircraft; or

(2) In a unit load device or on a pallet prior to loading aboard the aircraft.

(c) A hazardous material may be carried aboard an aircraft only if, based on the inspection by the operator, the package, outside container, or overpack containing the hazardous material:

(1) Has no holes, leakage or other indication that its integrity has been compromised; and

(2) For Class 7 (radioactive) materials, does not have a broken seal, except packages contained in overpacks need not be inspected for seal integrity.

(d) The requirements of paragraphs (b) and (c) of this section do not apply to Dry ice (carbon dioxide, solid).

(e) An overpack containing packages of hazardous materials may be accepted only if the operator has taken all reasonable steps to establish that:

(1) The overpack does not contain a package bearing the “CARGO AIR-CRAFT ONLY” label unless—

(i) The overpack affords clear visibility of and easy access to the package;

(ii) The package contains a material which may be carried inaccessibly under the provisions of §175.75(e); or

(iii) Not more than one package is overpacked.

(2) The proper shipping names, identification numbers, labels and special handling instructions appearing on the inside packages are clearly visible or reproduced on the outside of the overpack, and

49 CFR Ch. I (10–1–14 Edition)

(3) The word “OVERPACK” appears on the outside of the overpack when specification packagings are required.

[71 FR 14604, Mar. 22, 2006, as amended at 72 FR 25177, May 3, 2007; 73 FR 57006, Oct. 1, 2008; 76 FR 3383, Jan. 19, 2011; 79 FR 46040, Aug. 6, 2014]

§ 175.31 Reports of discrepancies.

(a) Each person who discovers a discrepancy, as defined in paragraph (b) of this section, relative to the shipment of a hazardous material following its acceptance for transportation aboard an aircraft shall, as soon as practicable, notify the nearest FAA Regional or Field Security Office by telephone or electronically, and shall provide the following information:

(1) Name and telephone number of the person reporting the discrepancy.

(2) Name of the aircraft operator.

(3) Specific location of the shipment concerned.

(4) Name of the shipper.

(5) Nature of discrepancy.

(6) Address of the shipper or person responsible for the discrepancy, if known, by the air carrier.

(b) Discrepancies which must be reported under paragraph (a) of this section are those involving hazardous materials which are improperly described, certified, labeled, marked, or packaged, in a manner not ascertainable when accepted under the provisions of §175.30(a) of this subchapter including packages or baggage which are found to contain hazardous materials subsequent to their being offered and accepted as other than hazardous materials.

§ 175.33 Shipping paper and notification of pilot-in-command.

(a) When a hazardous material subject to the provisions of this subchapter is carried in an aircraft, a copy of the shipping paper required by §175.30(a)(2) must accompany the shipment it covers during transportation aboard the aircraft, and the operator of the aircraft must provide the pilot-in-command with accurate and legible written information as early as practicable before departure of the aircraft, which specifies at least the following:

(1) The proper shipping name, hazard class and identification number of the material, including any remaining

aboard from prior stops, as specified in §172.101 of this subchapter or the ICAO Technical Instructions. In the case of Class 1 materials, the compatibility group letter also must be shown. If a hazardous material is described by the proper shipping name, hazard class, and identification number appearing in:

(i) Section 172.101 of this subchapter. Except for the requirement to indicate the type of package, any additional description requirements provided in §§172.202, and 172.203 of this subchapter must also be shown on the notification.

(ii) The ICAO Technical Instructions (IBR, see §171.7 of this subchapter), any additional information required to be shown on shipping papers by subpart C of part 171 of this subchapter must also be shown in the notification.

(2) The total number of packages;

(3) The net quantity or gross weight, as applicable, for each package except those containing Class 7 (radioactive) materials. For a shipment consisting of multiple packages containing hazardous materials bearing the same proper shipping name and identification number, only the total quantity and an indication of the quantity of the largest and smallest package at each loading location need to be provided;

(4) The location of the packages aboard the aircraft;

(5) Confirmation that no damaged or leaking packages have been loaded on the aircraft;

(6) For Class 7 (radioactive) materials, the number of packages, overpacks or freight containers, their category, transport index (if applicable), and their location aboard the aircraft;

(7) The date of the flight;

(8) The telephone number of a person not aboard the aircraft from whom the information contained in the notification of pilot-in-command can be obtained. The aircraft operator must ensure the telephone number is monitored at all times the aircraft is in flight. The telephone number is not required to be placed on the notification of pilot-in-command if the phone number is in a location in the cockpit available and known to the flight crew.

(9) Confirmation that the package must be carried only on cargo aircraft

if its transportation aboard passenger-carrying aircraft is forbidden; and

(10) An indication, when applicable, that a hazardous material is being carried under terms of a special permit.

(11) For UN1845, Carbon dioxide, solid (dry ice), only the UN number, proper shipping name, hazard class, total quantity in each hold aboard the aircraft, and the airport at which the package(s) is to be unloaded must be provided.

(12) For shipments of lithium cells or batteries (UN3090 or UN3480) offered for transportation, or transported in accordance with §173.185(c)(4)(v) of this subchapter, only the UN Number, proper shipping name, hazard class, and the total quantity at each specific loading location and whether the package must be loaded on a cargo only aircraft.

(b) A copy of the written notification to pilot-in-command shall be readily available to the pilot-in-command during flight. Emergency response information required by subpart G of part 172 of this subchapter must be maintained in the same manner as the written notification to pilot-in-command during transport of the hazardous material aboard the aircraft.

(c) The aircraft operator must—

(1) Retain a copy of the shipping paper required by §175.30(a)(2) or an electronic image thereof, that is accessible at or through its principal place of business and must make the shipping paper available, upon request, to an authorized official of a federal, state, or local government agency at reasonable times and locations. For a hazardous waste, each shipping paper copy must be retained for three years after the material is accepted by the initial carrier. For all other hazardous materials, each shipping paper copy must be retained by the operator for one year after the material is accepted by the initial carrier. Each shipping paper copy must include the date of acceptance by the carrier. The date on the shipping paper may be the date a shipper notifies the air carrier that a shipment is ready for transportation, as indicated on the air bill or bill of lading, as an alternative to the date the shipment is picked up or accepted by the carrier. Only an initial carrier must receive and retain a copy of the

§ 175.34

shipper's certification, as required by § 172.204 of this subchapter.

(2) Retain a copy of each notification of pilot-in-command, an electronic image thereof, or the information contained therein for 90 days at the airport of departure or the operator's principal place of business.

(3) Have the information required to be retained under this paragraph readily accessible at the airport of departure and the intended airport of arrival for the duration of the flight leg.

(4) Make available, upon request, to an authorized official of a Federal, State, or local government agency (including an emergency responder(s)) at reasonable times and locations, the documents or information required to be retained by this paragraph. In the event of a reportable incident, as defined in § 171.15 of this subchapter, make immediately available to an authorized official of a Federal, State, or local government agency (including an emergency responders), the documents or information required to be retained by this paragraph.

(5) Retain a copy of the alternative written documentation when provided in accordance with § 173.185(c)(4)(v)(B) of this subchapter or an electronic image thereof, or the information contained therein for 90 days at the airport of departure or the operator's principal place of business.

(d) The documents required by paragraphs (a) and (b) this section may be combined into one document if it is given to the pilot-in-command before departure of the aircraft.

[71 FR 14604, Mar. 22, 2006, as amended at 72 FR 25177, May 3, 2007; 73 FR 57006, Oct. 1, 2008; 74 FR 2267, Jan. 14, 2009; 79 FR 46040, Aug. 6, 2014]

§ 175.34 Exceptions for cylinders of compressed oxygen or other oxidizing gases transported within the State of Alaska.

(a) *Exceptions.* When transported in the State of Alaska, cylinders of compressed oxygen or other oxidizing gases aboard aircraft are excepted from all the requirements of §§ 173.302(f)(3) through (5) and 173.304(f)(3) through (5) of this subchapter subject to the following conditions:

49 CFR Ch. I (10–1–14 Edition)

(1) Transportation of the cylinders by a ground-based or water-based mode of transportation is unavailable and transportation by aircraft is the only practical means for transporting the cylinders to their destination;

(2) Each cylinder is fully covered with a fire or flame resistant blanket that is secured in place; and

(3) The operator of the aircraft complies with the applicable notification procedures under § 175.33.

(b) *Aircraft restrictions.* This exception only applies to the following types of aircraft:

(1) Cargo-only aircraft transporting the cylinders to a delivery destination that receives cargo-only service at least once a week.

(2) Passenger and cargo-only aircraft transporting the cylinders to a delivery destination that does not receive cargo only service once a week.

[79 FR 15046, Mar. 18, 2014]

Subpart B—Loading, Unloading and Handling

§ 175.75 Quantity limitations and cargo location.

(a) No person may carry on an aircraft a hazardous material except as permitted by this subchapter.

(b) Except as otherwise provided in this subchapter, no person may carry a hazardous material in the cabin of a passenger-carrying aircraft or on the flight deck of any aircraft, and the hazardous material must be located in a place that is inaccessible to persons other than crew members. Hazardous materials may be carried in a main deck cargo compartment of a passenger aircraft provided that the compartment is inaccessible to passengers and that it meets all certification requirements for a Class B aircraft cargo compartment in 14 CFR 25.857(b) or for a Class C aircraft cargo compartment in 14 CFR 25.857(c). A package bearing a "KEEP AWAY FROM HEAT" handling marking must be protected from direct sunshine and stored in a cool and ventilated place, away from sources of heat.

(c) For each package containing a hazardous material acceptable for carriage aboard passenger-carrying aircraft, no more than 25 kg (55 pounds) net weight of hazardous material may be loaded in an inaccessible manner. In addition to the 25 kg limitation, an additional 75 kg (165 pounds) net weight of Division 2.2 (non-flammable compressed gas) may be loaded in an inaccessible manner. The requirements of this paragraph do not apply to Class 9, articles of Identification Numbers UN0012, UN0014, or UN0055 also meeting the requirements of §173.63(b), and Limited or Excepted Quantity material.

(d) For the purposes of this section—

(1) *Accessible* means, on passenger-carrying or cargo-only aircraft that each package is loaded where a crew member or other authorized person can access, handle, and, when size and weight permit, separate such packages from other cargo during flight, including a freight container in an accessible cargo compartment when packages are loaded in an accessible manner. Additionally, a package is considered accessible when transported on a cargo-only aircraft if it is:

(i) In a cargo compartment certified by FAA as a Class C aircraft cargo compartment as defined in 14 CFR 25.857(c); or

(ii) In an FAA-certified freight container that has an approved fire or smoke detection system and fire suppression system equivalent to that required by the certification requirements for a Class C aircraft cargo compartment.

(2) *Inaccessible* means all other configurations to include packages loaded where a crew member or other authorized person cannot access, handle, and, when size and weight permit, separate such packages from other cargo during flight, including a freight container in an accessible cargo compartment when packages are loaded in an inaccessible manner.

(e) For transport aboard cargo-only aircraft, the requirements of paragraphs (c) and (d) of this section do not apply to the following hazardous materials:

(1) Class 3, PG III (unless the substance is also labeled CORROSIVE), Class 6.1 (unless the substance is also labeled for any hazard class or division except FLAMMABLE LIQUID), Division 6.2, Class 7 (unless the hazardous material meets the definition of another hazard class), Class 9, articles of Identification Numbers UN0012, UN0014, or UN0055 also meeting the requirements of §173.63(b), and those marked as a Limited Quantity or Excepted Quantity material.

(2) Packages of hazardous materials transported aboard a cargo aircraft, when other means of transportation are impracticable or not available, in accordance with procedures approved in writing by the FAA Regional or Field Security Office in the region where the operator is located.

(3) Packages of hazardous materials carried on small, single pilot, cargo aircraft if:

(i) No person is carried on the aircraft other than the pilot, an FAA inspector, the shipper or consignee of the material, a representative of the shipper or consignee so designated in writing, or a person necessary for handling the material;

(ii) The pilot is provided with written instructions on the characteristics and proper handling of the materials; and

(iii) Whenever a change of pilots occurs while the material is on board, the new pilot is briefed under a hand-to-hand signature service provided by the operator of the aircraft.

(f) At a minimum, quantity limits and loading instructions in the following quantity and loading table must be followed to maintain acceptable quantity and loading between packages containing hazardous materials. The quantity and loading table is as follows:

QUANTITY AND LOADING TABLE

Applicability	Forbidden	Quantity Limitation: 25 kg net weight of hazardous material plus 75 kg net weight of Division 2.2 (non-flammable compressed gas) per cargo compartment	No limit
Passenger-carrying aircraft	Cargo Aircraft Only labeled packages.	Inaccessible	Accessible.
Cargo-only aircraft— Packages authorized aboard a passenger-carrying aircraft.	Not applicable	Inaccessible (Note 1)	Accessible (Note 2).
Cargo-only aircraft— Packages not authorized aboard a passenger-carrying aircraft and displaying a Cargo Aircraft Only label.	Inaccessible (Note 1)	Not applicable	Accessible (Note 2).

Note 1: The following materials are not subject to this loading restriction—
a. Class 3, PG III (unless the substance is also labeled CORROSIVE).
b. Division 6.1 (unless the substance is also labeled for any hazard class or division except FLAMMABLE LIQUID)
c. Class 7 (unless the hazardous material meets the definition of another hazard class).
d. Class 9, Limited Quantity or Excepted Quantity material.
e. Articles of Identification Numbers UN0012, UN0014, or UN0055 also meeting the requirements of § 173.63(b).
Note 2: Aboard cargo-only aircraft, packages required to be loaded in a position that is considered to be accessible include those loaded in a Class C cargo compartment.

[76 FR 82178, Dec. 30, 2011, as amended at 78 FR 65486, Oct. 31, 2013]

§ 175.78 Stowage compatibility of cargo.

(a) For stowage on an aircraft, in a cargo facility, or in any other area at an airport designated for the stowage of hazardous materials, packages containing hazardous materials which might react dangerously with one another may not be placed next to each other or in a position that would allow

a dangerous interaction in the event of leakage.

(b) At a minimum, the segregation instructions prescribed in the following Segregation Table must be followed to maintain acceptable segregation between packages containing hazardous materials with different hazards. The Segregation Table instructions apply whether or not the class or division is the primary or subsidiary risk. The Segregation Table follows:

SEGREGATION TABLE

Hazard label	Class or division							
	1	2	3	4.2	4.3	5.1	5.2	8
1	Note 1	Note 2	Note 2	Note 2	Note 2	Note 2	Note 2	Note 2
2	Note 2							
3	Note 2					X		
4.2	Note 2					X		
4.3	Note 2							X
5.1	Note 2		X	X				
5.2	Note 2							
8	Note 2				X			

(c) Instructions for using the Segregation Table are as follows:

(1) Hazard labels, classes or divisions not shown in the table are not subject to segregation requirements.

(2) Dots at the intersection of a row and column indicate that no restrictions apply.

(3) The letter “X” at the intersection of a row and column indicates that packages containing these classes of hazardous materials may not be stowed next to or in contact with each other, or in a position which would allow interaction in the event of leakage of the contents.

(4) Note 1. “Note 1” at the intersection of a row and column means the following:

(i) Only Division 1.4, Compatibility Group S, explosives are permitted to be transported aboard a passenger aircraft. Only certain Division 1.3, Compatibility Groups C and G, and Division 1.4, Compatibility Groups B, C, D, E, G and S, explosives may be transported aboard a cargo aircraft.

(ii) Division 1.4 explosives in Compatibility Group S may be stowed with Division 1.3 and 1.4 explosives in compatibility groups as permitted aboard aircraft under paragraph (c)(4)(i) above.

(iii) Except for Division 1.4B explosives and as otherwise provided in this Note, explosives of different compatibility groups may be stowed together whether or not they belong to the same division. Division 1.4B explosives must not be stowed together with any other explosive permitted aboard aircraft except Division 1.4S, unless segregated as prescribed in paragraph (c)(4)(iv) of this section (“Note 1”).

(iv) Division 1.4B and Division 1.3 explosives may not be stowed together. Division 1.4B explosives must be loaded into separate unit load devices and, when stowed aboard the aircraft, the unit load devices must be separated by other cargo with a minimum separation of 2 m (6.5 feet). When not loaded in unit load devices, Division 1.4B and Division 1.3 explosives must be loaded into different, non-adjacent loading positions and separated by other cargo with a minimum separation of 2 m (6.5 feet).

(5) Note 2. “Note 2” at the intersection of a row and column means that other than explosives of Division 1.4, Compatibility Group S, explosives may not be stowed together with that class.

(6) Packages containing hazardous materials with multiple hazards in the class or divisions, which require segregation in accordance with the Segregation Table, need not be segregated from other packages bearing the same UN number.

(7) A package labeled “BLASTING AGENT” may not be stowed next to or in a position that will allow contact

with a package of special fireworks or railway torpedoes.

[71 FR 14604, Mar. 22, 2006, as amended at 71 FR 54396, Sept. 14, 2006; 71 FR 78634, Dec. 29, 2006; 76 FR 3384, Jan. 19, 2011]

§ 175.88 Inspection, orientation and securing packages of hazardous materials.

(a) A unit load device may not be loaded on an aircraft unless the device has been inspected and found to be free from any evidence of leakage from, or damage to, any package containing hazardous materials.

(b) A package containing hazardous materials marked “THIS SIDE UP” or “THIS END UP”, or with arrows to indicate the proper orientation of the package, must be stored and loaded aboard an aircraft in accordance with such markings. A package without orientation markings containing liquid hazardous materials must be stored and loaded with top closure facing upward.

(c) Packages containing hazardous materials must be secured in an aircraft in a manner that will prevent any shifting or any change in the orientation of the packages. Packages containing Class 7 (radioactive) materials must be secured in a manner that ensures that the separation requirements of §§ 175.701 and 175.702 will be maintained at all times during flight.

[71 FR 14604, Mar. 22, 2006, as amended at 74 FR 2268, Jan. 14, 2009]

§ 175.90 Damaged shipments.

(a) Packages or overpacks containing hazardous materials must be inspected for damage or leakage after being unloaded from an aircraft. When packages or overpacks containing hazardous materials have been transported in a unit load device, the area where the unit load device was stowed must be inspected for evidence of leakage or contamination immediately upon removal of the unit load device from the aircraft, and the packages or overpacks must be inspected for evidence of damage or leakage when the unit load device is unloaded. In the event of leakage or suspected leakage, the compartment in which the package, overpack, or unit load device was carried must be

§ 175.310

inspected for contamination and decontaminated, if applicable.

(b) Except as provided in § 175.700, the operator of an aircraft must remove from the aircraft any package, baggage or cargo that appears to be leaking or contaminated by a hazardous material. In the case of a package, baggage or cargo that appears to be leaking, the operator must ensure that other packages, baggage or cargo in the same shipment are in proper condition for transport aboard the aircraft and that no other package, baggage or cargo has been contaminated or is leaking. If an operator becomes aware that a package, baggage or cargo not identified as containing a hazardous material has been contaminated, or the operator has cause to believe that a hazardous material may be the cause of the contamination, the operator must take reasonable steps to identify the nature and source of contamination before proceeding with the loading of the contaminated baggage or cargo. If the contaminating substance is found or suspected to be hazardous material, the operator must isolate the package, baggage or cargo and take appropriate steps to eliminate any identified hazard before continuing the transportation of the item by aircraft.

(c) No person may place aboard an aircraft a package, baggage or cargo that is contaminated with a hazardous material or appears to be leaking.

(d) If a package containing a material in Division 6.2 (infectious substance) is found to be damaged or leaking, the person finding the package must:

(1) Avoid handling the package or keep handling to a minimum;

(2) Inspect packages adjacent to the leaking package for contamination and withhold from further transportation any contaminated packages until it is ascertained that they can be safely transported;

(3) Comply with the reporting requirement of §§ 171.15 and 175.31 of this subchapter; and

(4) Notify the consignor or consignee.

49 CFR Ch. I (10–1–14 Edition)

**Subpart C—Specific Regulations
Applicable According to
Classification of Material**

**§ 175.310 Transportation of flammable
liquid fuel; aircraft only means of
transportation.**

(a) When other means of transportation are impracticable, flammable liquid fuels may be carried on certain passenger and cargo aircraft as provided in this section, without regard to the packaging references and quantity limits listed in Columns 7, 8 and 9 of the § 172.101 Hazardous Materials Table. All requirements of this subchapter that are not specifically covered in this section continue to apply to shipments made under the provisions of this section. For purposes of this section “impracticable” means transportation is not physically possible or cannot be performed by routine and frequent means of other transportation, due to extenuating circumstances. Extenuating circumstances include: conditions precluding highway or water transportation, such as a frozen vessel route; road closures due to catastrophic weather or volcanic activity; or a declared state of emergency. The desire for expedience of a shipper, carrier, or consignor, is not relevant in determining whether other means of transportation are impracticable. The stowage requirements of § 175.75(a) do not apply to a person operating an aircraft under the provisions of this section which, because of its size and configuration, makes it impossible to comply.

(b) A small passenger-carrying aircraft operated entirely within the State of Alaska or into a remote area, in other than scheduled passenger operations, may carry up to 76 L (20 gallons) of flammable liquid fuel (in Packing Group II or Packing Group III), when:

(1) The flight is necessary to meet the needs of a passenger; and

(2) The fuel is carried in one of the following types of containers:

(i) Strong tight metal containers of not more than 20 L (5.3 gallons) capacity, each packed inside a UN 4G fiberboard box, at the Packing Group II performance level, or each packed inside a

UN 4C1 wooden box, at the Packing Group II performance level;

(ii) Airtight, leakproof, inside containers of not more than 40 L (11 gallons) capacity and of at least 28-gauge metal, each packed inside a UN 4C1 wooden box, at the Packing Group II performance level;

(iii) UN 1A1 steel drums, at the Packing Group I or II performance level, of not more than 20 L (5.3 gallons) capacity; or

(iv) In fuel tanks attached to flammable liquid fuel powered equipment under the following conditions:

(A) Each piece of equipment is secured in an upright position;

(B) Each fuel tank is filled in a manner that will preclude spillage of fuel during loading, unloading, and transportation; and

(C) Fueling and refueling of the equipment is prohibited in or on the aircraft.

(3) In the case of a passenger-carrying helicopter, the fuel or fueled equipment must be carried on external cargo racks or slings.

(c) Flammable liquid fuels may be carried on a cargo aircraft, subject to the following conditions:

(1)(i) The flammable liquid fuel is in Packing Group II or Packing Group III except as indicated in paragraph (c)(1)(iv) of this section;

(ii) The fuel is carried in packagings authorized in paragraph (b) of this section;

(iii) The fuel is carried in metal drums (UN 1A1, 1B1, 1N1) authorized for Packing Group I or Packing Group II liquid hazardous materials and having rated capacities of 220 L (58 gallons) or less. These single packagings may not be transported in the same aircraft with Class 1, Class 5, or Class 8 materials.

(iv) Combustible and flammable liquid fuels (including those in Packing Group I) may be carried in installed aircraft tanks each having a capacity of more than 450 L (118.9 gallons), subject to the following additional conditions:

(A) The tanks and their associated piping and equipment and the installation thereof must have been approved for the material to be transported by

the appropriate FAA Flight Standards District Office.

(B) In the case of an aircraft being operated by a certificate holder, the operator shall list the aircraft and the approval information in its operating specifications. If the aircraft is being operated by other than a certificate holder, a copy of the FAA Flight Standards District Office approval required by this section must be carried on the aircraft.

(C) The crew of the aircraft must be thoroughly briefed on the operation of the particular bulk tank system being used.

(D) During loading and unloading and thereafter until any remaining fumes within the aircraft are dissipated:

(1) Only those electrically operated bulk tank shutoff valves that have been approved under a supplemental type certificate may be electrically operated.

(2) No engine or electrical equipment, avionic equipment, or auxiliary power units may be operated, except position lights in the steady position and equipment required by approved loading or unloading procedures, as set forth in the operator's operations manual, or for operators that are not certificate holders, as set forth in a written statement.

(3) Static ground wires must be connected between the storage tank or fueler and the aircraft, and between the aircraft and a positive ground device.

(2) [Reserved]

(d) The following restrictions apply to loading, handling, or carrying fuel under the provisions of this section:

(1) During loading and unloading, no person may smoke, carry a lighted cigarette, cigar, or pipe, or operate any device capable of causing an open flame or spark within 15 m (50 feet) of the aircraft.

(2) No person may fill a container, other than an approved bulk tank, with a Class 3 material or combustible liquid or discharge a Class 3 material or combustible liquid from a container, other than an approved bulk tank, while that container is inside or within 15 m (50 feet) of the aircraft.

(3) When filling an approved bulk tank by hose from inside the aircraft, the doors and hatches of the aircraft

§ 175.501

49 CFR Ch. I (10–1–14 Edition)

must be fully open to insure proper ventilation.

(4) Each area or compartment in which the fuel is loaded is suitably ventilated to prevent the accumulation of fuel vapors.

(5) Fuel is transferred to the aircraft fuel tanks only while the aircraft is on the ground.

(6) Before each flight, the pilot-in-command:

(i) Prohibits smoking, lighting matches, the carrying of any lighted cigar, pipe, cigarette or flame, and the use of anything that might cause an open flame or spark, while in flight; and

(ii) For passenger aircraft, informs each passenger of the location of the fuel and the hazards involved.

(e) Operators must comply with the following:

(1) If the aircraft is being operated by a holder of a certificate issued under 14 CFR part 121 or part 135, operations must be conducted in accordance with conditions and limitations specified in the certificate holder's operations specifications or operations manual accepted by the FAA. If the aircraft is being operated under 14 CFR part 91, operations must be conducted in accordance with an operations plan accepted and acknowledged in writing by the FAA Principal Operations Inspector assigned to the operator.

(2) The aircraft and the loading arrangement to be used must be approved for the safe carriage of the particular materials concerned by the FAA Principal Operations Inspector assigned to the operator.

§ 175.501 Special requirements for oxidizers and compressed oxygen.

(a) Compressed oxygen, when properly labeled Oxidizer or Oxygen, may be loaded and transported as provided in this section. Except for Oxygen, compressed, no person may load or transport a hazardous material for which an OXIDIZER label is required under this subchapter in an inaccessible cargo compartment that does not have a fire or smoke detection system and a fire suppression system.

(b) In addition to the quantity limitations prescribed in §175.75, no more than a combined total of six cylinders

of compressed oxygen may be stowed on an aircraft in the inaccessible aircraft cargo compartment(s) that do not have fire or smoke detection systems and fire suppression systems.

(c) When loaded into a passenger-carrying aircraft or in an inaccessible cargo location on a cargo-only aircraft, cylinders of compressed oxygen must be stowed horizontally on the floor or as close as practicable to the floor of the cargo compartment or unit load device. This provision does not apply to cylinders stowed in the cabin of the aircraft in accordance with paragraph (e) of this section.

(d) When transported in a Class B aircraft cargo compartment (see 14 CFR 25.857(b)) or its equivalent (i.e., an accessible cargo compartment equipped with a fire or smoke detection system, but not a fire suppression system), cylinders of compressed oxygen must be loaded in a manner that a crew member can see, handle and, when size and weight permit, separate the cylinders from other cargo during flight. No more than six cylinders of compressed oxygen and, in addition, one cylinder of medical-use compressed oxygen per passenger needing oxygen at destination—with a rated capacity of 1000 L (34 cubic feet) or less of oxygen—may be carried in a Class B aircraft cargo compartment or its equivalent.

(e) A cylinder containing medical-use compressed oxygen, owned or leased by an aircraft operator or offered for transportation by a passenger needing it for personal medical use at destination, may be carried in the cabin of a passenger-carrying aircraft in accordance with the following provisions:

(1) No more than six cylinders belonging to the aircraft operator and, in addition, no more than one cylinder per passenger needing the oxygen at destination, may be transported in the cabin of the aircraft under the provisions of this paragraph (e);

(2) The rated capacity of each cylinder may not exceed 1,000 L (34 cubic feet);

(3) Each cylinder must conform to the provisions of this subchapter and be placed in:

(i) An outer packaging that conforms to the performance criteria of Air

Transport Association (ATA) Specification 300 for a Category I Shipping Container; or

(ii) A metal, plastic or wood outer packaging that conforms to a UN standard at the Packing Group I or II performance level.

(4) The aircraft operator shall securely stow the cylinder in its overpack or outer packaging in the cabin of the aircraft and shall notify the pilot-in-command as specified in §175.33 of this part; and

(5) Shipments under this paragraph (e) are not subject to—

(i) Sections 173.302(f) and 173.304(f) of this subchapter, subpart C of part 172 of this subchapter, and, for passengers only, subpart H of part 172 of this subchapter;

(ii) Section 173.25(a)(4) of this subchapter; and

(iii) Paragraph (b) of this section.

[72 FR 4456, Jan. 31, 2007, as amended at 72 FR 55099, Sept. 28, 2007]

§ 175.630 Special requirements for Division 6.1 (poisonous) material and Division 6.2 (infectious substances) materials.

(a) A package required to bear a POISON, POISON INHALATION HAZARD, or INFECTIOUS SUBSTANCE label may not be carried in the same compartment of an aircraft with material which is marked as or known to be a foodstuff, feed, or any other edible material intended for consumption by humans or animals unless:

(1) The Division 6.1 or Division 6.2 material and the foodstuff, feed, or other edible material are loaded in separate unit load devices which, when stowed on the aircraft, are not adjacent to each other; or

(2) The Division 6.1 or Division 6.2 material are loaded in one closed unit load device and the foodstuff, feed or other material is loaded in another closed unit load device.

(b) No person may operate an aircraft that has been used to transport any package required to bear a POISON or POISON INHALATION HAZARD label unless, upon removal of such package, the area in the aircraft in which it was carried is visually inspected for evidence of leakage, spillage, or other contamination. All contamination dis-

covered must be either isolated or removed from the aircraft. The operation of an aircraft contaminated with such Division 6.1 materials is considered to be the carriage of poisonous materials under paragraph (a) of this section.

(c) When unloaded from the aircraft, each package, overpack, pallet, or unit load device containing a Division 6.2 material must be inspected for signs of leakage. If evidence of leakage is found, the cargo compartment in which the package, overpack, or unit load device was transported must be disinfected. Disinfection may be by any means that will make the material released ineffective at transmitting disease.

[71 FR 14604, Mar. 22, 2006, as amended at 71 FR 32263, June 2, 2006]

§ 175.700 Special limitations and requirements for Class 7 materials.

(a) Except as provided in §§173.4a, 173.422 and 173.423 of this subchapter, no person may carry any Class 7 materials aboard a passenger-carrying aircraft unless that material is intended for use in, or incident to research (See §171.8 of this subchapter), medical diagnosis or treatment. Regardless of its intended use, no person may carry a Type B(M) package aboard a passenger-carrying aircraft, a vented Type B(M) package aboard any aircraft, or a liquid pyrophoric Class 7 material aboard any aircraft.

(b) *Limits for transport index and criticality safety index.* A person may carry the following Class 7 (radioactive) materials aboard an aircraft only when—

(1) On a passenger-carrying aircraft—

(i) Each single package on the aircraft has a transport index no greater than 3.0;

(ii) The combined transport index and the combined criticality index of all the packages on the aircraft are each no greater than 50.

(2) On a cargo aircraft—

(i) Each single package on the aircraft has a transport index no greater than 10.0.

(ii) The combined transport index of all the packages on the aircraft is no greater than 200, and the combined criticality index of all the packages on the aircraft is no greater than—

§ 175.701

(A) 50 on a non-exclusive use cargo aircraft, or

(B) 100 on an aircraft assigned for the exclusive use of the shipper [offeror] for the specific shipment of fissile Class 7 material. Instructions for the exclusive use must be developed by the shipper [offeror] and carrier, and the instructions must accompany the shipping papers.

(3) The combined transport index and combined criticality index are determined by adding together the transport index and criticality index numbers, respectively, shown on the labels of the individual packages.

(c) No person may carry in a passenger-carrying aircraft any package required to be labeled RADIOACTIVE YELLOW-II or RADIOACTIVE YELLOW-III label unless the package is carried on the floor of the cargo compartment or freight container.

[71 FR 14604, Mar. 22, 2006, as amended at 74 FR 2268, Jan. 14, 2009]

§ 175.701 Separation distance requirements for packages containing Class 7 (radioactive) materials in passenger-carrying aircraft.

(a) The following table prescribes the minimum separation distances that must be maintained in a passenger-carrying aircraft between Class 7 (radioactive) materials labeled RADIOACTIVE YELLOW-II or RADIOACTIVE YELLOW-III and passengers and crew:

Transport index or sum of transport indexes of all packages in the aircraft or predesignated area	Minimum separation distances	
	Centimeters	Inches
0.1 to 1.0	30	12
1.1 to 2.0	50	20
2.1 to 3.0	70	28
3.1 to 4.0	85	34
4.1 to 5.0	100	40
5.1 to 6.0	115	46
6.1 to 7.0	130	52
7.1 to 8.0	145	57
8.1 to 9.0	155	61
9.1 to 10.0	165	65
10.1 to 11.0	175	69
11.1 to 12.0	185	73
12.1 to 13.0	195	77
13.1 to 14.0	205	81
14.1 to 15.0	215	85
15.1 to 16.0	225	89
16.1 to 17.0	235	93
17.1 to 18.0	245	97
18.1 to 20.0	260	102
20.1 to 25.0	290	114
25.1 to 30.0	320	126
30.1 to 35.0	350	138
35.1 to 40.0	375	148

49 CFR Ch. I (10-1-14 Edition)

Transport index or sum of transport indexes of all packages in the aircraft or predesignated area	Minimum separation distances	
	Centimeters	Inches
40.1 to 45.0	400	157
45.1 to 50.0	425	167

(b) When transported aboard passenger-carrying aircraft packages, overpacks or freight containers labeled Radioactive Yellow-II or Radioactive Yellow-III must be separated from live animals by a distance of at least 0.5 m (20 inches) for journeys not exceeding 24 hours, and by a distance of at least 1.0 m (39 inches) for journeys longer than 24 hours.

(c) Except as provided in paragraph (d) of this section, the minimum separation distances prescribed in paragraphs (a) and (b) of this section are determined by measuring the shortest distance between the surfaces of the Class 7 (radioactive) materials package and the surfaces bounding the space occupied by passengers or animals. If more than one package of Class 7 (radioactive) materials is placed in a passenger-carrying aircraft, the minimum separation distance for these packages shall be determined in accordance with paragraphs (a) and (b) of this section on the basis of the sum of the transport index numbers of the individual packages or overpacks.

(d) *Predesignated areas.* A package labeled RADIOACTIVE YELLOW-II or RADIOACTIVE YELLOW-III may be carried in a passenger-carrying aircraft in accordance with a system of predesignated areas established by the aircraft operator. Each aircraft operator that elects to use a system of predesignated areas shall submit a detailed description of the proposed system to the Associate Administrator for approval prior to implementation of the system. A proposed system of predesignated areas is approved if the Associate Administrator determines that it is designed to assure that:

(1) The packages can be placed in each predesignated area in accordance with the minimum separation distances prescribed in paragraph (a) of this section; and

(2) The predesignated areas are separated from each other by minimum distance equal to at least four times the distances required by paragraphs (a)

and (b) of this section for the predesignated area containing packages with the largest sum of transport indexes.

§ 175.702 Separation distance requirements for packages containing Class 7 (radioactive) materials in cargo aircraft.

(a) No person may carry in a cargo aircraft any package required by §172.403 of this subchapter to be labeled Radioactive Yellow-II or Radioactive Yellow-III unless:

(1) The total transport index for all packages does not exceed 50.0 and the

packages are carried in accordance with §175.701(a); or

(2) The total transport index for all packages exceeds 50.0; and

(i) The separation distance between the surfaces of the radioactive materials packages, overpacks or freight containers and any space occupied by live animals is at least 0.5 m (20 inches) for journeys not exceeding 24 hours and at least 1.0 m (39 inches) for journeys longer than 24 hours; and

(ii) The minimum separation distances between the radioactive material and any areas occupied by persons that are specified in the following table are maintained:

Transport index or sum of transport indexes of all packages in the aircraft or predesignated area	Minimum separation distances	
	Centimeters	Inches
50.1 to 60.0	465	183
60.1 to 70.0	505	199
70.1 to 80.0	545	215
80.1 to 90.0	580	228
90.1 to 100.0	610	240
100.1 to 110.0	645	254
110.1 to 120.0	670	264
120.1 to 130.0	700	276
130.1 to 140.0	730	287
140.1 to 150.0	755	297
150.1 to 160.0	780	307
160.1 to 170.0	805	317
170.1 to 180.0	830	327
180.1 to 190.0	855	337
190.1 to 200.0	875	344

(b) In addition to the limits on combined criticality safety indexes stated in §175.700(b),

(1) The criticality safety index of any single group of packages must not exceed 50.0 (as used in this section, the term “group of packages” means packages that are separated from each other in an aircraft by a distance of 6 m (20 feet) or less); and

(2) Each group of packages must be separated from every other group in the aircraft by not less than 6 m (20 feet), measured from the outer surface of each group.

[71 FR 14604, Mar. 22, 2006, as amended at 71 FR 54396, Sept. 14, 2006; 77 FR 60943, Oct. 5, 2012; 79 FR 40618, July 11, 2014]

§ 175.703 Other special requirements for the acceptance and carriage of packages containing Class 7 materials.

(a) No person may accept for carriage in an aircraft packages of Class 7 materials, other than limited quantities, contained in a rigid or non-rigid overpack, including a fiberboard box or plastic bag, unless they have been prepared for shipment in accordance with §172.403(h) of this subchapter.

(b) Each shipment of fissile material packages must conform to the requirements of §§173.457 and 173.459 of this subchapter.

(c) No person shall offer or accept for transportation, or transport, by air—

(1) Vented Type B(M) packages, packages which require external cooling by an ancillary cooling system or packages subject to operational controls during transport; or

§ 175.704

49 CFR Ch. I (10–1–14 Edition)

(2) Liquid pyrophoric Class 7 (radioactive) materials.

(d) Packages with radiation levels at the package surface or a transport index in excess of the limits specified in §173.441(a) of this subchapter may not be transported by aircraft except under special arrangements approved by the Associate Administrator.

§ 175.704 Plutonium shipments.

Shipments of plutonium which are subject to 10 CFR 71.88(a)(4) must comply with the following:

(a) Each package containing plutonium must be secured and restrained to prevent shifting under normal conditions.

(b) A package of plutonium having a gross mass less than 40 kg (88 pounds) and both its height and diameter less than 50 cm (19.7 inches)—

(1) May not be transported aboard an aircraft carrying other cargo required to bear a Division 1.1 label; and

(2) Must be stowed aboard the aircraft on the main deck or the lower cargo compartment in the aft-most location that is possible for cargo of its size and weight, and no other cargo may be stowed aft of packages containing plutonium.

(c) A package of plutonium exceeding the size and weight limitations in paragraph (b) of this section—

(1) May not be transported aboard an aircraft carrying other cargo required to bear any of the following labels: Class 1 (all Divisions), Class 2 (all Divisions), Class 3, Class 4 (all Divisions), Class 5 (all Divisions), or Class 8; and

(2) Must be securely cradled and tied down to the main deck of the aircraft in a manner that restrains the package against the following internal forces acting separately relative to the deck of the aircraft; Upward, 2g; Forward, 9g; Sideward, 1.5g; Downward, 4.5g.

§ 175.705 Radioactive contamination.

(a) A carrier shall take care to avoid possible inhalation, ingestion, or contact by any person with Class 7 (radioactive) materials that may have been released from their packagings.

(b) When contamination is present or suspected, the package containing a Class 7 material, any loose Class 7 material, associated packaging material, and any other materials that have been contaminated must be segregated as far as practicable from personnel contact until radiological advice or assistance is obtained from the U.S. Department of Energy or appropriate State or local radiological authorities.

(c) An aircraft in which Class 7 (radioactive) material has been released must be taken out of service and may not be returned to service or routinely occupied until the aircraft is checked for radioactive substances and it is determined that any radioactive substances present do not meet the definition of radioactive material, as defined in §173.403 of this subchapter.

(d) Each aircraft used routinely for transporting Class 7 materials shall be periodically checked for radioactive contamination, and an aircraft must be taken out of service if contamination exceeds the level specified in paragraph (c). The frequency of these checks shall be related to the likelihood of contamination and the extent to which Class 7 materials are transported.

(e) In addition to the reporting requirements of (§§171.15 and 171.16 of this subchapter and §175.31 of this part, an aircraft operator shall notify the offeror at the earliest practicable moment following any incident in which there has been breakage, spillage, or suspected radioactive contamination involving Class 7 (radioactive) materials shipments.

[71 FR 14604, Mar. 22, 2006, as amended at 79 FR 40618, July 11, 2014]

§ 175.706 Separation distances for undeveloped film from packages containing Class 7 (radioactive) materials.

No person may carry in an aircraft any package of Class 7 (radioactive) materials required by §172.403 of this subchapter to be labeled Radioactive Yellow-II or Radioactive Yellow-III closer than the distances shown in the table below to any package marked as containing underdeveloped film.

Transport index	Minimum separation distance to nearest undeveloped film for various times in transit									
	Up to 2 hours		2 to 4 hours		4 to 8 hours		8 to 12 hours		Over 12 hours	
	Meters	Feet	Meters	Feet	Meters	Feet	Meters	Feet	Meters	Feet
0.1 to 1.0	0.3	1	0.6	2	0.9	3	1.2	4	1.5	5
1.1 to 5.0	0.9	3	1.2	4	1.8	6	2.4	8	3.3	11
5.1 to 10.0	1.2	4	1.8	6	2.7	9	3.3	11	4.5	15
10.1 to 20.0 ...	1.5	5	2.4	8	3.6	12	4.8	16	6.6	22
20.1 to 30.0 ...	2.1	7	3	10	4.5	15	6	20	8.7	29
30.1 to 40.0 ...	2.4	8	3.3	11	5.1	17	6.6	22	9.9	33
40.1 to 50.0 ...	2.7	9	3.6	12	5.7	19	7.2	24	10.8	36

§175.900 Handling requirements for carbon dioxide, solid (dry ice).

Carbon dioxide, solid (dry ice) when shipped by itself or when used as a refrigerant for other commodities, may be carried only if the operator has made suitable arrangements based on the aircraft type, the aircraft ventilation rates, the method of packing and stowing, whether animals will be carried on the same flight and other factors. The operator must ensure that the ground staff is informed that the dry ice is being loaded or is on board the aircraft. For arrangements between the shipper and operator, see §173.217 of this subchapter. Where dry ice is contained in a unit load device (ULD) or other type of pallet prepared by a single shipper in accordance with §173.217 and the operator after the acceptance adds additional dry ice, the operator must ensure that the information provided to the Pilot-in-Command and the marking on the ULD when used as a packaging reflects that revised quantity of dry ice.

[73 FR 4719, Jan. 28, 2008]

PART 176—CARRIAGE BY VESSEL

Subpart A—General

- Sec.
- 176.1 Purpose and scope.
- 176.2 Definitions.
- 176.3 Unacceptable hazardous materials shipments.
- 176.4 Port security and safety regulations.
- 176.5 Application to vessels.
- 176.7 Documentation for vessel personnel.
- 176.9 “Order-Notify” or “C.O.D.” shipments.
- 176.11 Exceptions.
- 176.13 Responsibility for compliance and training.
- 176.15 Enforcement.
- 176.18 Assignment and certification.

Subpart B—General Operating Requirements

- 176.24 Shipping papers.
- 176.27 Certificate.
- 176.30 Dangerous cargo manifest.
- 176.31 Special permits.
- 176.36 Preservation of records.
- 176.39 Inspection of cargo.
- 176.45 Emergency situations.
- 176.48 Situation requiring report.
- 176.50 Acceptance of damaged or leaking packages.
- 176.52 Rejections of shipments in violation.
- 176.54 Repairs involving welding, burning, and power-actuated tools and appliances.

Subpart C—General Handling and Stowage

- 176.57 Supervision of handling and stowage.
- 176.58 Preparation of the vessel.
- 176.60 “No Smoking” signs.
- 176.63 Stowage locations.
- 176.65 Alternative stowage procedures.
- 176.69 General stowage requirements for hazardous materials.
- 176.70 Stowage requirements for marine pollutants.
- 176.72 Handling of break-bulk hazardous materials.
- 176.74 On deck stowage of break-bulk hazardous materials.
- 176.76 Transport vehicles, freight containers, and portable tanks containing hazardous materials.
- 176.77 Stowage of barges containing hazardous materials on board barge-carrying vessels.
- 176.78 Use of power-operated industrial trucks on board vessels.

Subpart D—General Segregation Requirements

- 176.80 Applicability.
- 176.83 Segregation.

Pt. 176

49 CFR Ch. I (10–1–14 Edition)

176.84 Other requirements for stowage and segregation for cargo vessels and passenger vessels.

Subpart E—Special Requirements for Transport Vehicles Loaded With Hazardous Materials and Transported on Board Ferry Vessels

176.88 Applicability.
176.89 Control of transport vehicles.
176.90 Private automobiles.
176.91 Motorboats.
176.92 Cylinders laden in vehicles.
176.93 Vehicles having refrigerating or heating equipment.

Subpart F—Special Requirements for Barges

176.95 Applicability.
176.96 Materials of construction.
176.97 Prohibition of dump scows.
176.98 Stowage of hazardous materials on board barges.
176.99 Permit requirements for certain hazardous materials.

Subpart G—Detailed Requirements for Class 1 (Explosive) Materials

176.100 Permit for Divisions 1.1 and 1.2 (explosive) materials.
176.102 Supervisory detail.
176.104 Loading and unloading Class 1 (explosive) materials.
176.108 Supervision of Class 1 (explosive) materials during loading, unloading, handling and stowage.

STOWAGE

176.112 Applicability.
176.116 General stowage conditions for Class 1 (explosive) materials.
176.118 Electrical requirement.
176.120 Lightning protection.
176.122–176.124 [Reserved]
176.128–176.136 [Reserved]
176.137 Portable magazine.
176.138 Deck stowage.

SEGREGATION

176.140 Segregation from other classes of hazardous materials.
176.142 [Reserved]
176.144 Segregation of Class 1 (explosive) materials.
176.145 Segregation in single hold vessels.
176.146 Segregation from non-hazardous materials.

PRECAUTIONS DURING LOADING AND UNLOADING

176.148 Artificial lighting.
176.150 Radio and radar.
176.154 Fueling (bunkering).

176.156 Defective packages.
176.160 Protection against weather.
176.162 Security.
176.164 Fire precautions and firefighting.

PASSENGER VESSELS

176.166 Transport of Class 1 (explosive) materials on passenger vessels.

CARGO TRANSPORT UNITS AND SHIPBORNE BARGES

176.168 Transport of Class 1 (explosive) materials in vehicle spaces.
176.170 Transport of Class 1 (explosive) materials in freight containers.
176.172 Structural serviceability of freight containers and vehicles carrying Class 1 (explosive) materials on ships.
176.174 Transport of Class 1 (explosive) materials in shipborne barges.

HANDLING CLASS 1 (EXPLOSIVE) MATERIALS IN PORT

176.176 Signals.
176.178 Mooring lines.
176.180 Watchkeeping.
176.182 Conditions for handling on board ship.
176.184 Class 1 (explosive) materials of Compatibility Group L.
176.190 Departure of vessel.
176.192 Cargo handling equipment for freight containers carrying Class 1 (explosive) materials.

MAGAZINE VESSELS

176.194 Stowage of Class 1 (explosive) materials on magazine vessels.

Subpart H—Detailed Requirements for Class 2 (Compressed Gas) Materials

176.200 General stowage requirements.
176.205 Under deck stowage requirements.
176.210 On deck stowage requirements.
176.220 Smoking or open flame and posting of warning signs.
176.225 Stowage of chlorine.
176.230 Stowage of Division 2.1 (flammable gas) materials.

Subpart I—Detailed Requirements for Class 3 (Flammable) and Combustible Liquid Materials

176.305 General stowage requirements.
176.315 Fire protection requirements.
176.320 Use of hand flashlights.
176.325 Smoking or open flame and posting of warning signs.

176.340 Combustible liquids in portable tanks.

Subpart J—Detailed Requirements for Class 4 (Flammable Solids), Class 5 (Oxidizers and Organic Peroxides), and Division 1.5 Materials

176.400 Stowage of Division 1.5, Class 4 (flammable solids) and Class 5 (oxidizers and organic peroxides) materials.

176.405 Stowage of charcoal.

176.410 Division 1.5 materials, ammonium nitrate and ammonium nitrate mixtures.

176.415 Permit requirements for Division 1.5, ammonium nitrates, and certain ammonium nitrate fertilizers.

Subpart K [Reserved]

Subpart L—Detailed Requirements for Division 2.3 (Poisonous Gas) and Division 6.1 (Poisonous) Materials

176.600 General stowage requirements.

176.605 Care following leakage or sifting of Division 2.3 (poisonous gas) and Division 6.1 (poisonous) materials.

Subpart M—Detailed Requirements for Radioactive Materials

176.700 General stowage requirements.

176.704 Requirements relating to transport indices and criticality safety indices.

176.708 Segregation distances.

176.710 Care following leakage or sifting of radioactive materials.

176.715 Contamination control.

176.720 Requirements for carriage of INF cargo in international transportation.

Subpart N—Detailed Requirements for Class 8 (Corrosive Materials) Materials

176.800 General stowage requirements.

176.805 On deck stowage.

Subpart O—Detailed Requirements for Cotton and Vegetable Fibers, Motor Vehicles, Polymeric Beads, and Plastic Molding Compounds

176.900 Packaging and stowage of cotton and vegetable fibers; general.

176.901 Stowage of cotton or vegetable fibers with rosin or pitch.

176.903 Stowage of cotton or vegetable fibers with coal.

176.905 Stowage of motor vehicles or mechanical equipment.

176.907 Polymeric Beads and Plastic Molding Compounds.

AUTHORITY: 49 U.S.C. 5101–5128; 49 CFR 1.81 and 1.97.

Subpart A—General

§ 176.1 Purpose and scope.

This part prescribes requirements in addition to those contained in parts 171, 172, and 173 of this subchapter to be observed with respect to the transportation of hazardous materials by vessel.

§ 176.2 Definitions.

As used in this part—

Cantline means the v-shaped groove between two abutting, parallel horizontal cylinders.

Cargo net means a net made of fiber or wire used to provide convenience in handling loose or packaged cargo to and from a vessel.

Cargo transport unit means a transport vehicle, a freight container, a portable tank or a multiple element gas container (MEGC). A *closed cargo transport unit* means a cargo transport unit in which the contents are totally enclosed by permanent structures. An *open cargo transport unit* means a cargo transport unit that is not a closed cargo transport unit. Cargo transport units with fabric sides or tops are not closed cargo transport units for the purposes of this part.

Clear of living quarters means that the hazardous material must be located so that in the event of release of the material, leakage or vapors will not penetrate accommodations, machinery spaces or other work areas by means of entrances or other openings in bulkheads or ventilation ducts.

Closed freight container means a freight container which totally encloses its contents by permanent structures. A freight container formed partly by a tarpaulin, plastic sheet, or similar material is not a closed freight container.

Closed cargo transport unit for Class 1 (explosive) materials means a freight container or transport vehicle that fully encloses the contents by permanent structures and can be secured to the ship's structure and are, except for the carriage of division 1.4 explosives, structurally serviceable (see §176.172). Portable magazines conforming to §176.137 are also considered closed cargo transport units for Class 1. Small compartments such as deck houses and

mast lockers are included. Cargo transport units with fabric sides or tops are not closed cargo transport units. The floor of any closed cargo transport unit must either be constructed of wood, close-boarded or so arranged that goods are stowed on sparred gratings, wooden pallets or dunnage.

Commandant (CG-522), USCG means the Chief, Office of Operating and Environmental Standards, United States Coast Guard, Washington, DC 20593-0001.

Compartment means any space on a vessel that is enclosed by the vessel's decks and its sides or permanent steel bulkheads.

CSC safety approval plate means the safety approval plate specified in Annex I of the International Convention for Safe Containers (1972) and conforming to the specifications in 49 CFR 451.23 and 451.25. The plate is evidence that a freight container was designed, constructed, and tested under international rules incorporated into U.S. regulations in 49 CFR parts 450 through 453. The plate is found in the door area of the container.

Deck structure means a structure of substantial weight and size located on the weather deck of a vessel and integral with the deck. This term includes superstructures, deck houses, mast houses, and bridge structures.

Draft means a load or combination of loads capable of being hoisted into or out of a vessel in a single lift.

Dunnage means lumber of not less than 25 mm (0.98 inch) commercial thickness or equivalent material laid over or against structures such as tank tops, decks, bulkheads, frames, plating, or ladders, or used for filling voids or fitting around cargo, to prevent damage during transportation.

Explosives anchorage means an anchorage so designated under 33 CFR part 110, subpart B.

Explosive article means an article or device that contains one or more explosive substances. Individual explosive substances are identified in column 17 of the Dangerous Goods List in the IMDG Code (IBR, see §171.7 of this subchapter).

Explosives handling facility means—

(1) A “designated waterfront facility” designated under 33 CFR part 126

when loading, handling, and unloading Class 1 (explosives) materials; or

(2) A facility for loading, unloading, and handling military Class 1 (explosives) materials which is operated or controlled by an agency of the Department of Defense.

Explosive substance means a solid or liquid material, or a mixture of materials, which is in itself capable by chemical reaction of producing gas at such a temperature and pressure and at such a speed as to cause damage to its surroundings. Individual explosive substances are identified in column 17 of the Dangerous Goods List in the IMDG Code.

Handling means the operation of loading and unloading a vessel; transfer to, from, or within a vessel, and any ancillary operations.

Hold means a compartment below deck that is used exclusively for the carriage of cargo.

In containers or the like means any clean, substantial, weatherproof box structure which can be secured to the vessel's structure, including a portable magazine or a closed cargo transport unit. Whenever this stowage is specified, stowage in deckhouses, mast lockers and oversized weatherproof packages (overpacks) is also acceptable.

Incompatible materials means two materials whose stowage together may result in undue hazards in the case of leakage, spillage, or other accident.

INF cargo means packaged irradiated nuclear fuel, plutonium or high-level radioactive wastes as those terms are defined in the “International Code for the Safe Carriage of Packaged Irradiated Nuclear Fuel, Plutonium and High-Level Radioactive Wastes on Board Ships” (INF Code) contained in the IMDG Code.

Landing mat means a shock absorbing pad used in loading Class 1 (explosive) materials on vessels.

Machinery Spaces of Category A are those spaces, and trunks to such spaces, which contain:

(1) Internal combustion machinery used for main propulsion;

(2) Internal combustion machinery used for purposes other than main propulsion where such machinery has in the aggregate a total power output of not less than 375 kw; or

(3) any oil-fired boiler or fuel unit.

Magazine means an enclosure designed to protect certain goods of Class 1 (explosive) materials from damage by other cargo and adverse weather conditions during loading, unloading, and when in transit; and to prevent unauthorized access. A magazine may be a fixed structure or compartment in the vessel, a closed freight container, a closed transport vehicle, or a portable magazine. Magazines may be positioned in any part of the ship conforming with the relevant provisions for Class 1 (explosive) materials contained in Subpart G of this part provided that magazines which are fixed structures are sited so that their doors, where fitted, are easily accessible.

Master of the Vessel, as used in this part, includes the person in charge of an unmanned vessel or barge.

Open freight container means a freight container that does not totally enclose its contents by permanent structures.

Overstowed means a package or container is stowed directly on top of another. However, with regard to Class 1 (explosive) stowage, such goods may themselves be stacked to a safe level but other goods should not be stowed directly on top of them.

Pallet means a portable platform for stowing, handling, and moving cargo.

Palletized unit means packages or unpackaged objects stacked on a pallet, banded and secured to the pallet by metal, fabric, or plastic straps for the purpose of handling as a single unit.

Pie plate means a round, oval, or hexagonal pallet without sideboards, used in conjunction with a cargo net to handle loose cargo on board a vessel.

Portable magazine means a strong, closed, prefabricated, steel or wooden, closed box or container, other than a freight container, designed and used to handle Class 1 (explosive) materials either by hand or mechanical means.

Potential or possible sources of ignition means, but is not limited to, open fires, machinery exhausts, galley uptakes, electrical outlets and electrical equipment including those on refrigerated or heated cargo transport units unless they are of a type designed to operate in a hazardous environment.

Protected from sources of heat means that packages and cargo transport

units must be stowed at least 2.4 m from heated ship structures, where the surface temperature is liable to exceed 131 °F (55 °C). Examples of heated structures are steam pipes, heating coils, top or side walls of heated fuel and cargo tanks, and bulkheads of machinery spaces. In addition, packages not loaded inside a cargo transport unit and stowed on deck must be shaded from direct sunlight. The surface of a cargo transport unit can heat rapidly when in direct sunlight in nearly windless conditions and the cargo may also become heated. Depending on the nature of the goods in the cargo transport unit, and the planned voyage, precautions must be taken to ensure that exposure to direct sunlight is reduced.

Readily combustible material means a material which may or may not be classed as a hazardous material but which is easily ignited and supports combustion. Examples of readily combustible materials include wood, paper, straw, vegetable fibers, products made from such materials, coal, lubricants, and oils. This definition does not apply to packaging material or dunnage.

Responsible person means a person empowered by the master of the vessel to make all decisions relating to his or her specific task, and having the necessary knowledge and experience for that purpose.

Safe working load means the maximum gross weight that cargo handling equipment is approved to lift.

Skilled person means a person having the knowledge and experience to perform a certain duty.

Skipboard means a square or rectangular pallet without sideboards, usually used in conjunction with a cargo net to handle loose cargo on board a vessel.

Splice as used in §176.172 of this part, means any repair of a freight container main structural member which replaces material, other than complete replacement of the member.

§ 176.3

Tray means a type of pallet constructed to specific dimensions for handling a particular load.

[Amdt. 176-30, 55 FR 52687, Dec. 21, 1990, as amended at 66 FR 8647, Feb. 1, 2001; 66 FR 33438, June 21, 2001; 66 FR 45184, Aug. 28, 2001; 67 FR 61015, Sept. 27, 2002; 68 FR 75747, 75748, Dec. 31, 2003; 69 FR 76179, Dec. 20, 2004; 73 FR 57006, Oct. 1, 2008; 74 FR 2268, Jan. 14, 2009; 76 FR 3384, Jan. 19, 2011; 78 FR 1093, Jan. 7, 2013]

§ 176.3 Unacceptable hazardous materials shipments.

(a) A carrier may not transport by vessel any shipment of a hazardous material that is not prepared for transportation in accordance with parts 172 and 173 of this subchapter, or as authorized by subpart C of part 171 of this subchapter.

(b) A carrier may not transport by vessel any explosive or explosive composition described in § 173.54 of this subchapter.

[Amdt. 176-1, 41 FR 16110, Apr. 15, 1976, as amended by Amdt. 176-30, 55 FR 52688, Dec. 21, 1990; 74 FR 2268, Jan. 14, 2009]

§ 176.4 Port security and safety regulations.

(a) Each carrier, master, agent, and charterer of a vessel and all other persons engaged in handling hazardous materials on board vessels shall comply with the applicable provisions of 33 CFR parts 6, 109, 110, 125, 126, and 160.

(b) Division 1.1 and 1.2 (explosive) materials may only be loaded on and unloaded from a vessel at—

(1) A facility of particular hazard as defined in 33 CFR 126.05(b);

(2) An explosives anchorage listed in 33 CFR part 110; or

(3) A facility operated or controlled by the Department of Defense.

(c) With the concurrence of the COTP, Division 1.1 and 1.2 (explosive) materials may be loaded on or unloaded from a vessel in any location acceptable to the COTP.

[Amdt. 176-30, 55 FR 52688, Dec. 21, 1990, as amended at 66 FR 45384, Aug. 28, 2001]

§ 176.5 Application to vessels.

(a) Except as provided in paragraph (b) of this section, this subchapter applies to each domestic or foreign vessel when in the navigable waters of the United States, regardless of its char-

49 CFR Ch. I (10-1-14 Edition)

acter, tonnage, size, or service, and whether self-propelled or not, whether arriving or departing, underway, moored, anchored, aground, or while in dry dock.

(b) This subchapter does not apply to:

(1) A public vessel not engaged in commercial service;

(2) A vessel constructed or converted for the principal purpose of carrying flammable or combustible liquid cargo in bulk in its own tanks, when only carrying these liquid cargoes;

(3) A vessel of 15 gross tons or smaller when not engaged in carrying passengers for hire;

(4) A vessel used exclusively for pleasure;

(5) A vessel of 500 gross tons or smaller when engaged in fisheries;

(6) A tug or towing vessel, except when towing another vessel having Class 1 (explosive) materials, Class 3 (flammable liquids), or Division 2.1 (flammable gas) materials, in which case the owner/operator of the tug or towing vessel shall make such provisions to guard against and extinguish fire as the Coast Guard may prescribe;

(7) A cable vessel, dredge, elevator vessel, fireboat, icebreaker, pile driver, pilot boat, welding vessel, salvage vessel, or wrecking vessel; or

(8) A foreign vessel transiting the territorial sea of the United States without entering the internal waters of the United States, if all hazardous materials being carried on board are being carried in accordance with the requirements of the IMDG Code (IBR, see § 171.7 of this subchapter).

(c) [Reserved]

(d) Except for transportation in bulk packagings (as defined in § 171.8 of this subchapter), the bulk carriage of hazardous materials by water is governed by 46 CFR chapter I, subchapters D, I, N and O.

[Amdt. 176-1, 41 FR 16110, Apr. 15, 1976, as amended by Amdt. 176-1A, 41 FR 40687, Sept. 20, 1976; Amdt. 176-14, 47 FR 44471, Oct. 7, 1982; Amdt. 176-24, 51 FR 5974, Feb. 18, 1986; Amdt. 176-30, 55 FR 52688, Dec. 21, 1990; 56 FR 66281, Dec. 20, 1991; Amdt. 176-34, 58 FR 51533, Oct. 1, 1993; 66 FR 8647, Feb. 1, 2001; 68 FR 75747, Dec. 31, 2003]

§ 176.7 Documentation for vessel personnel.

Each owner, operator, master, agent, person in charge, and charterer must ensure that vessel personnel required to have a license, certificate of registry, or merchant mariner's document by 46 CFR parts 10 and 12 possess a license, certificate or document, as appropriate.

[68 FR 23842, May 5, 2003]

§ 176.9 "Order-Notify" or "C.O.D." shipments.

A carrier may not transport Division 1.1 or 1.2 (explosive) materials, detonators, or boosters with detonators which are:

(a) Consigned to "order-notify" or "C.O.D.", except on a through bill of lading to a place outside the United States; or

(b) Consigned by the shipper to himself unless he has a resident representative to receive the shipment at the port of discharge.

[Amdt. 176-30, 55 FR 52688, Dec. 21, 1990, as amended at 66 FR 45384, Aug. 28, 2001]

§ 176.11 Exemptions.

(a) A hazardous material may be offered and accepted for transport by vessel when in conformance with the IMDG Code (IBR, see § 171.7 of this subchapter), subject to the conditions and limitations set forth in subpart C of part 171 of this subchapter. The requirements of §§ 176.83, 176.84, and 176.112 through 176.174 are not applicable to shipments of Class 1 (explosive) materials made in accordance with the IMDG Code. A hazardous material which conforms to the provisions of this paragraph (a) is not subject to the requirement specified in § 172.201(d) of this subchapter for an emergency response telephone number, when transportation of the hazardous material originates and terminates outside the United States and the hazardous material—

(1) Is not offloaded from the vessel; or
 (2) Is offloaded between ocean vessels at a U.S. port facility without being transported by public highway.

(b) Canadian shipments and packages may be transported by vessel if they are transported in accordance with this

subchapter. (See subparts B and C of part 171 of this subchapter.)

(c) The requirements of this subchapter governing the transportation of combustible liquids do not apply to the transportation of combustible liquids in non-bulk (see definitions in § 171.8 of this subchapter) packages on board vessels.

(d) Transport vehicles, containing hazardous materials loaded in accordance with specific requirements of this subchapter applicable to such vehicles, may be transported on board a ferry vessel or carfloat, subject to the applicable requirements specified in §§ 176.76, 176.100, and subpart E of this part.

(e) Hazardous materials classed and shipped as ORM-D are not subject to the requirements of this part unless they are offered for transportation as hazardous wastes.

(f) Paragraph (a) of this section does not apply to hazardous materials, including certain hazardous wastes and hazardous substances as defined in § 171.8 of this subchapter, which are not subject to the requirements of the IMDG Code.

(g) The requirements of this subchapter do not apply to atmospheric gases used in a refrigeration system.

[Amdt. 176-1, 41 FR 16110, Apr. 15, 1976]

EDITORIAL NOTE: For FEDERAL REGISTER citations affecting § 176.11, see the List of CFR Sections Affected, which appears in the Finding Aids section of the printed volume and at www.fdsys.gov.

§ 176.13 Responsibility for compliance and training.

(a) Unless this subchapter specifically provides that another person shall perform a particular duty, each carrier shall perform the duties specified and comply with all applicable requirements in this part and shall ensure its hazmat employees receive training in relation thereto.

(b) A carrier may not transport a hazardous material by vessel unless each of its hazmat employees involved in that transportation is trained as required by subpart H of part 172 of this subchapter.

(c) The record of training required by § 172.704(d) of this subchapter for a crewmember who is a hazmat employee

§ 176.15

subject to the training requirements of this subchapter must be kept on board the vessel while the crewmember is in service on board the vessel.

[Amdt. 176-31, 57 FR 20954, May 15, 1992, as amended by Amdt. 176-35, 59 FR 49134, Sept. 26, 1994]

§ 176.15 Enforcement.

(a) An enforcement officer of the U.S. Coast Guard may at any time and at any place, within the jurisdiction of the United States, board any vessel for the purpose of enforcement of this subchapter and inspect any shipment of hazardous materials as defined in this subchapter.

(b) [Reserved]

[Amdt. 176-1, 41 FR 16110, Apr. 15, 1976, as amended by Amdt. 176-1A, 41 FR 40687, Sept. 20, 1976; Amdt. 176-24, 51 FR 5974, Feb. 18, 1986]

§ 176.18 Assignment and certification.

(a) The National Cargo Bureau, Inc., is authorized to assist the Coast Guard in administering this subchapter with respect to the following:

(1) Inspection of vessels for suitability for loading hazardous materials;

(2) Examination of stowage of hazardous materials;

(3) Making recommendations for stowage requirements of hazardous materials cargo; and

(4) Issuance of certificates of loading setting forth that the stowage of hazardous materials is in accordance with the requirements of this subchapter.

(b) A certificate of loading issued by the National Cargo Bureau, Inc., may be accepted by the Coast Guard as prima facie evidence that the cargo is stowed in conformity with the requirements of this subchapter.

[Amdt. 176-1, 41 FR 16110, Apr. 15, 1976, as amended by Amdt. 176-24, 51 FR 5974, Feb. 18, 1986]

Subpart B—General Operating Requirements

§ 176.24 Shipping papers.

(a) A person may not accept a hazardous material for transportation or transport a hazardous material by vessel unless that person has received a

49 CFR Ch. I (10-1-14 Edition)

shipping paper prepared in accordance with part 172 of this subchapter, or as authorized by subpart C of part 171 of this subchapter, unless the material is excepted from shipping paper requirements under this subchapter.

(b) Each person receiving a shipping paper required by this section must retain a copy or an electronic image thereof, that is accessible at or through its principal place of business and must make the shipping paper available, upon request, to an authorized official of a Federal, State, or local government agency at reasonable times and locations. For a hazardous waste, each shipping paper copy must be retained for three years after the material is accepted by the initial carrier. For all other hazardous materials, each shipping paper copy must be retained for one year after the material is accepted by the carrier. Each shipping paper copy must include the date of acceptance by the carrier. The date on the shipping paper may be the date a shipper presents a booking for carriage with the carrier as an alternative to the date the shipment is picked up, accepted, or loaded on the vessel by the carrier.

[67 FR 66574, Nov. 1, 2002, as amended at 70 FR 73165, Dec. 9, 2005; 72 FR 25177, May 3, 2007]

§ 176.27 Certificate.

(a) A carrier may not transport a hazardous material by vessel unless a certificate prepared in accordance with § 172.204 of this subchapter has been received.

(b) In the case of an import or export shipment of a hazardous material that will not be transported by rail, highway, or air, the shipper may certify on the bill of lading or other shipping paper that the hazardous material is properly classed, described, marked, packaged, and labeled according to part 172 of this subchapter or in accordance with the requirements of the IMDG Code (IBR, *see* § 171.7 of this subchapter). See subpart C of part 171 of this subchapter.

(c)(1) A person responsible for packing or loading a freight container or transport vehicle with packages of hazardous materials for transportation by a manned vessel in ocean or coastwise

service, must provide the vessel operator, at the time the shipment is offered for transportation by vessel, with a signed container packing certificate stating, at a minimum, that—

(i) The freight container or transport vehicle is serviceable for the materials loaded therein, contains no incompatible goods, and is properly marked, labeled or placarded, as applicable; and

(ii) When the freight container or transport vehicle contains packages, those packages have been inspected prior to loading, are properly marked, labeled or placarded, as applicable; are not damaged; and are properly secured.

(2) The certification may appear on a shipping paper or on a separate document as a statement, such as “It is declared that the packing of the container has been carried out in accordance with the applicable provisions [of 49 CFR], [of the IMDG Code], or [of 49 CFR and the IMDG Code].”

[69 FR 76180, Dec. 20, 2004; 72 FR 25177, May 3, 2007]

§ 176.30 Dangerous cargo manifest.

(a) The carrier, its agents, and any person designated for this purpose by the carrier or agents must prepare a dangerous cargo manifest, list, or stowage plan. This document may not include a material that is not subject to the requirements of the Hazardous Material Regulations (49 CFR parts 171 through 180) or the International Maritime Dangerous Goods Code (IMDG Code) (IBR, see §171.7 of this subchapter). This document must be kept on or near the vessel’s bridge, except when the vessel is docked in a United States port. When the vessel is docked in a United States port, this document may be kept in the vessel’s cargo office or another location designated by the master of the vessel provided that a sign is placed beside the designated holder on or near the vessel’s bridge indicating the location of the dangerous cargo manifest, list, or stowage plan. This document must always be in a location that is readily accessible to emergency response and enforcement personnel. It must contain the following information:

(1) Name of vessel and official number. (If the vessel has no official num-

ber, the international radio call sign must be substituted.);

(2) Nationality of vessel;

(3) Shipping name and identification number of each hazardous material on board as listed in §172.101 of this subchapter or as listed in the IMDG Code and an emergency response telephone number as prescribed in subpart G of part 172 of this subchapter.

(4) The number and description of packages (barrels, drums, cylinders, boxes, etc.) and gross weight for each type of packaging;

(5) Classification of the hazardous material in accordance with either:

(i) The Hazardous Materials Table, the §172.101 table; or

(ii) The IMDG Code.

(6) Any additional description required by §172.203 of this subchapter.

(7) Stowage location of the hazardous material on board the vessel.

(8) In the case of a vessel used for the storage of explosives or other hazardous materials, the following additional information is required:

(i) Name and address of vessel’s owner;

(ii) Location of vessel’s mooring;

(iii) Name of person in charge of vessel;

(iv) Name and address of the owner of the cargo; and

(v) A complete record, by time intervals of one week, of all receipts and disbursements of hazardous materials. The name and address of the consignor must be shown against all receipts and the name and address of the consignee against all deliveries.

(b) The hazardous material information on the dangerous cargo manifest must be the same as the information furnished by the shipper on the shipping order or other shipping paper, except that the IMO “correct technical name” and the IMO class may be indicated on the manifest as provided in paragraphs (a)(3) and (a)(5) of this section. The person who supervises the preparation of the manifest, list, or stowage plan shall ensure that the information is correctly transcribed, and shall certify to the truth and accuracy of this information to the best of his knowledge and belief by his signature and notation of the date prepared.

§ 176.31

(c) The carrier and its agents shall insure that the master, or a licensed deck officer designated by the master and attached to the vessel, or in the case of a barge, the person in charge of the barge, acknowledges the correctness of the dangerous cargo manifest, list or stowage plan by his signature.

(d) For barges, manned or unmanned, the requirements of this section apply except for the following:

(1) In the case of a manned barge, the person in charge of the barge shall prepare the dangerous cargo manifest.

(2) In the case of an unmanned barge, the person responsible for loading the barge is responsible for the preparation of a dangerous cargo manifest, list, or stowage plan and must designate an individual for that purpose.

(3) For all barges, manned or unmanned, the dangerous cargo manifest must be on board the barge in a readily accessible location and a copy must be furnished to the person in charge of the towing vessel.

(e) Each carrier who transports or stores hazardous materials on a vessel shall retain a copy of the dangerous cargo manifest, list, or stowage plan for at least one year, and shall make that document available for inspection in accordance with §176.36(b) of this subchapter.

[Amdt. 176-1, 41 FR 16110, Apr. 15, 1976]

EDITORIAL NOTE: For FEDERAL REGISTER citations affecting §176.30, see the List of CFR Sections Affected, which appears in the Finding Aids section of the printed volume and at www.fdsys.gov.

§ 176.31 Special permits.

If a hazardous material is being transported by vessel under the authority of an exemption or special permit and a copy of the exemption or special permit is required to be on board the vessel, it must be kept with the dangerous cargo manifest.

[70 FR 73165, Dec. 9, 2005]

§ 176.36 Preservation of records.

(a) When this part requires shipping orders, manifest, cargo lists, stowage plans, reports, or any other papers, documents or similar records to be prepared, the carrier shall preserve them or copies of them in his place of busi-

49 CFR Ch. I (10-1-14 Edition)

ness or office in the United States for a period of one year after their preparation.

(b) Any record required to be preserved must be made available upon request to an authorized representative of the Department.

[Amdt. 176-1, 41 FR 16110, Apr. 15, 1976, as amended at 66 FR 45384, Aug. 28, 2001]

§ 176.39 Inspection of cargo.

(a) *Manned vessels.* The carrier, its agents, and any person designated for this purpose by the carrier or agents shall cause an inspection of each hold or compartment containing hazardous materials to be made after stowage is complete, and at least once every 24 hours thereafter, weather permitting, in order to ensure that the cargo is in a safe condition and that no damage caused by shifting, spontaneous heating, leaking, sifting, wetting, or other cause has been sustained by the vessel or its cargo since loading and stowage. However, freight containers or individual barges need not be opened. A vessel's holds equipped with smoke or fire detecting systems having an automatic monitoring capability need not be inspected except after stowage is complete and after periods of heavy weather. The carrier, its agents, and any person designated for this purpose by the carrier or agents shall cause an entry to be made in the vessel's deck log book for each inspection of the stowage of hazardous materials performed.

(b) *Unmanned and magazine vessels.* An inspection of the cargo must be made after stowage has been completed to ensure that stowage has been accomplished properly and that there are no visible signs of damage to any packages or evidence of heating, leaking, or sifting. This inspection must be made by the individual who is responsible to the carrier and who is in charge of loading and stowing the cargo on the unmanned vessels or the individual in charge in the case of a magazine vessel.

(c) The carrier, its agents, and any person designated for this purpose by the carrier or agents of each ocean-going vessel carrying hazardous material shall, immediately prior to entering a port in the United States, cause an inspection of that cargo to be made.

(d) When inspecting a cargo of hazardous materials capable of evolving flammable vapors, any artificial means of illumination must be of an explosion-proof type.

[Amdt. 176-1, 41 FR 16110, Apr. 15, 1976, as amended by Amdt. 176-8, 44 FR 23228, Apr. 19, 1979; Amdt. 176-9, 44 FR 49458, Aug. 23, 1979]

§ 176.45 Emergency situations.

(a) When an accident occurs on board a vessel involving hazardous materials, and the safety of the vessel, its passengers or crew are endangered, the master shall adopt such procedures as will, in his judgment, provide maximum safety for the vessel, its passengers, and its crew. When the accident results in damaged packages or the emergency use of unauthorized packagings, these packages may not be offered to any forwarding carrier for transportation. The master shall notify the nearest Captain of the Port, U.S. Coast Guard, and request instructions for disposition of the packages.

(b) Hazardous materials may be jettisoned only if the master believes this action necessary to prevent or substantially reduce a hazard to human life or reduce a substantial hazard to property.

[Amdt. 176-1, 41 FR 16110, Apr. 15, 1976, as amended by Amdt. 176-1B, 41 FR 57072, Dec. 30, 1976]

§ 176.48 Situation requiring report.

(a) When a fire or other hazardous condition exists on a vessel transporting hazardous materials, the master shall notify the nearest Captain of the Port as soon as possible and shall comply with any instructions given by the Captain of the Port.

(b) When an incident occurs during transportation in which a hazardous material is involved, a report may be required (see §§171.15 and 171.16 of this subchapter).

(c) If a package, portable tank, freight container, highway or railroad vehicle containing hazardous materials is jettisoned or lost, the master shall notify the nearest Captain of the Port

as soon as possible of the location, quantity, and type of the material.

[Amdt. 176-1, 41 FR 16110, Apr. 15, 1976, as amended by Amdt. 176-1A, 41 FR 40687, Sept. 20, 1976; Amdt. 176-1B, 41 FR 57072, Dec. 30, 1976; Amdt. 176-24, 51 FR 5974, Feb. 18, 1986; Amdt. 176-25, 52 FR 8592, Mar. 19, 1987]

§ 176.50 Acceptance of damaged or leaking packages.

A carrier may not transport by vessel any package that is so damaged as to permit the escape of its contents, that appears to have leaked, or that gives evidence of failure to properly contain the contents unless it is restored or repaired to the satisfaction of the master of the vessel. A package containing radioactive materials (other than low specific activity materials) may not be repaired or restored.

[Amdt. 176-1, 41 FR 16110, Apr. 15, 1976, as amended by Amdt. 176-1A, 41 FR 40687, Sept. 20, 1976]

§ 176.52 Rejections of shipments in violation.

(a) A carrier may not knowingly transport by vessel any hazardous material offered under a false or deceptive name, marking, invoice, shipping paper or other declaration, or without the shipper furnishing written information about the true nature of the material at the time of delivery.

(b) If a shipment in violation is found in transit, the master of the vessel shall adopt procedures which in his judgment provide maximum safety to the vessel, its passengers and its crew and which are in compliance with §176.45. If the vessel is in port, the material may not be delivered to any party, and the master shall immediately notify the nearest Captain of the Port and request instructions for disposition of the material.

[Amdt. 176-1, 41 FR 16110, Apr. 15, 1976, as amended by Amdt. 176-1B, 41 FR 57072, Dec. 30, 1976]

§ 176.54 Repairs involving welding, burning, and power-actuated tools and appliances.

(a) Except as provided in paragraph (b) of this section, repairs or work involving welding or burning, or the use of power-actuated tools or appliances which may produce intense heat may

§ 176.57

not be undertaken on any vessel having on board explosives or other hazardous materials as cargo.

(b) Paragraph (a) of this section does not apply if:

(1) The repairs or work are approved by the COTP under 33 CFR 126.30; or

(2) Emergency repairs to the vessel's main propelling or boiler plant or auxiliaries are necessary for the safety of the vessel. If such repairs are performed, the master of the vessel must immediately notify the nearest COTP.

[Amdt. 176-1, 41 FR 16110, Apr. 15, 1976, as amended by Amdt. 176-30, 55 FR 52689, Dec. 21, 1990; 75 FR 53597, Sept. 1, 2010]

Subpart C—General Handling and Stowage

§ 176.57 Supervision of handling and stowage.

(a) Hazardous materials may be handled or stowed on board a vessel only under the direction and observation of a responsible person assigned this duty.

(b) For a vessel engaged in coastwise voyages, or on rivers, bays, sounds or lakes, including the Great Lakes when the voyage is not foreign-going, the responsible person may be an employee of the carrier and assigned this duty by the carrier, or a licensed officer attached to the vessel and assigned by the master of the vessel.

(c) For a domestic vessel engaged in a foreign-going or intercoastal voyage, the responsible person must be an officer possessing an unexpired license issued by the USCG and assigned this duty by the master of the vessel.

(d) For a foreign vessel, the responsible person must be an officer of the vessel assigned this duty by the master of the vessel.

[Amdt. 176-30, 55 FR 52689, Dec. 21, 1990]

§ 176.58 Preparation of the vessel.

(a) Each hold or compartment in which hazardous materials are to be stowed must be free of all debris before the hazardous materials are stowed. Bilges must be examined and all residue of previous cargo removed.

(b) All decks, gangways, hatches, and cargo ports over or through which hazardous materials must be passed or handled in loading or unloading must

49 CFR Ch. I (10-1-14 Edition)

be free of all loose materials before cargo handling operations begin.

(c) No debris that creates a fire hazard or a hazardous condition for persons engaged in handling hazardous materials may be on the weather deck of a vessel during loading or unloading operations.

(d) Hatch beams and hatch covers may not be stowed in a location that would interfere with cargo handling.

[Amdt. 176-30, 55 FR 52689, Dec. 21, 1990]

§ 176.60 “No Smoking” signs.

When smoking is prohibited during the loading, stowing, storing, transportation, or unloading of hazardous materials by this part, the carrier and the master of the vessel are jointly responsible for posting “NO SMOKING” signs in conspicuous locations.

§ 176.63 Stowage locations.

(a) The table in §172.101 of this subchapter specifies generally the locations authorized for stowage of the various hazardous materials on board vessels. This part prescribes additional requirements with respect to the stowage of specific hazardous materials in addition to those authorized in §172.101 of this subchapter. This section sets forth the basic physical requirements for the authorized locations. Hazardous materials offered for transport as limited quantities are allocated stowage category A and are not subject to any of the specific stowage requirements indicated in column 10B in §172.101 of this subchapter for the material being transported.

(b) To qualify as “on deck” stowage, the location must be on the weather deck. If the location is in a house on the weather deck, the location must have a permanent structural opening to the atmosphere, such as a door, hatch, companionway or manhole, and must be vented to the atmosphere. The location may not have any structural opening to any living quarters, cargo, or other compartment unless the opening has means for being closed off and secured. Any deck house containing living quarters, a steering engine, a refrigerating unit, a refrigerated stowage box, or a heating unit may not be used unless that area is isolated from the cargo stowage area by a permanent,

and tight, metallic bulkhead. Stowage in a shelter or 'tween deck is not considered to be "on deck". A barge that is vented to the atmosphere and is stowed on deck on a barge-carrying ship is considered to be "on deck". When an entry in §172.101 of this subchapter requires "on-deck" stowage and is qualified by the requirement "protected from sources of heat", the stowage must be protected from the direct rays of the sun by means of structural erections or awnings except that such protection is not required for shipment in portable tanks.

(c) To qualify as "under deck" stowage, the location must be in a hold or compartment below the weather deck capable of being ventilated and allotted entirely to the carriage of cargo. It must be bounded by permanent steel decks and bulkheads or the shell of the vessel. The deck openings must have means for effectively closing the hold or compartment against the weather, and in the case of superimposed holds, for effectively closing off each hold. A hold or compartment containing a crew passage formed by battens or by mesh or wire screen bulkhead may not be used for the stowage of any hazardous material unless a watchman is provided for this area.

(d) To qualify as "under deck away from heat", the location must be under deck and have built-in means for ventilation. If it is subject to heat from any artificial source, it only qualifies for the stowage of those hazardous materials for which "under deck" stowage is authorized.

(e) Notwithstanding the stowage provisions given in the table in §172.101 of this subchapter, empty packages containing residue, including IBCs and large packages, may be stowed "on deck" or "under deck" in a mechanically ventilated cargo space. However, empty pressure receptacles containing residue that carry a label of class 2.3 must be stowed "on deck" and waste aerosols must be stowed in accordance with the table in §172.101 of this subchapter.

(f) *Stowage of containers on board hatchless container ships.* (1) Containers holding a hazardous material may be stowed in or vertically above a

hatchless container hold if the following conditions are met:

(1) All hazardous materials are permitted for *under deck* stowage as specified in the Table in §172.101 of this subchapter; and

(2) The hatchless container hold is in full compliance with the provisions of SOLAS, Chapter II-2/Regulation 19 (IBR; *see* §171.7 of this subchapter), applicable to enclosed container cargo spaces, as appropriate for the cargo transported.

[Amdt. 176-1, 41 FR 16110, Apr. 15, 1976, as amended by Amdt. 176-1A, 41 FR 40687, Sept. 20, 1976; Amdt. 176-1B, 41 FR 57072, Dec. 30, 1976; Amdt. 176-12, 45 FR 81572, Dec. 11, 1980; 66 FR 33438, June 21, 2001; 66 FR 45184, Aug. 28, 2001; 68 FR 45038, July 31, 2003; 69 FR 76180, Dec. 20, 2004; 76 FR 3384, Jan. 19, 2011; 78 FR 1094, Jan. 7, 2013]

§ 176.65 Alternative stowage procedures.

When a hazardous material is to be loaded on board a vessel and it is shown to the satisfaction of the Coast Guard Captain of the Port for the place where the vessel is being loaded that it is impracticable to comply with a stowage location requirement specified in the §172.101 table of this subchapter or a segregation, handling or stowage requirement specified in this part, the Captain of the Port may authorize in writing the use of an alternative stowage location or method of segregation, handling or stowage subject to such conditions as he finds will insure a level of safety at least equal to that afforded by the regulatory requirement concerned.

[Amdt. 176-30, 55 FR 52689, Dec. 21, 1990]

§ 176.69 General stowage requirements for hazardous materials.

(a) Hazardous materials (except as provided in paragraph (c) of this section and Class 9 (miscellaneous hazardous) materials) must be stowed in a manner that will facilitate inspection during the voyage, their removal from a potentially dangerous situation, and the removal of packages in case of fire.

(b) Each package marked in accordance with §172.312(a)(2) of this subchapter must be stowed as to remain in the position indicated during transportation.

§ 176.70

(c) If a vessel designed for and carrying hazardous materials in freight containers or a vessel designed for and carrying hazardous materials in barges is equipped with a fixed fire extinguishing and fire detection system, the freight containers or barges need not be stowed in the manner required by paragraph (a) of this section. When freight containers or barges containing hazardous materials are stowed on deck, they need not be stowed in the manner required by paragraph (a) of this section if fire fighting equipment capable of reaching and piercing the freight container or barge is on board the vessel.

(d) Packages of hazardous materials must be secured and dunnaged to prevent shifting in any direction. Vertical restraints are not required if the shape of the package and the stuffing pattern preclude shifting of the load.

(e) Packages of hazardous materials must be braced and dunnaged so that they are not likely to be pierced by the dunnage or crushed by a superimposed load.

[Amdt. 176-1, 41 FR 16110, Apr. 15, 1976, as amended by Amdt. 176-1A, 41 FR 40687, Sept. 20, 1976; Amdt. 176-12, 45 FR 81573, Dec. 11, 1980; Amdt. 176-30, 55 FR 52689, Dec. 21, 1990; 56 FR 66282, Dec. 20, 1991; 68 FR 61942, Oct. 30, 2003]

§ 176.70 Stowage requirements for marine pollutants.

(a) Marine pollutants must be properly stowed and secured to minimize the hazards to the marine environment without impairing the safety of the ship and the persons on board.

(b) Where stowage is permitted "on deck or under deck", under deck stowage is preferred except when a weather deck provides equivalent protection.

(c) Where stowage "on deck only" is required, preference should be given to stowage on well-protected decks or to stowage inboard in sheltered areas of exposed decks.

[Amdt. 176-31, 57 FR 52940, Nov. 5, 1992]

§ 176.72 Handling of break-bulk hazardous materials.

(a) A metal bale hook may not be used for handling any package of hazardous materials.

49 CFR Ch. I (10-1-14 Edition)

(b) The use of equipment designed to lift or move cargo by means of pressure exerted on the packages may not be used for handling any package of hazardous materials if the device can damage the package or the package is not designed to be moved in that manner.

(c) Pallets, slings, cargo nets and other related equipment used in loading packages of hazardous materials must give adequate support to the packages. The packages must be contained so that they are not able to fall during loading.

§ 176.74 On deck stowage of break-bulk hazardous materials.

(a) Packages containing hazardous materials must be secured by enclosing in boxes, cribs or cradles and proper lashing by use of wire rope, strapping or other means, including shoring and bracing, or both. Lashing of deck cargo is permitted if eye pads are used to attach the lashings. Lashings may not be secured to guard rails. Bulky articles must be shored.

(b) A packaging susceptible to weather or water damage must be protected so that it will not be exposed to the weather or to sea water.

(c) Not more than fifty percent of the total open deck area should be used for stowage of hazardous materials (except Class 9 (miscellaneous hazardous material)).

(d) Fireplugs, hoses, sounding pipes, and access to these must be free and clear of all cargo.

(e) Crew and passenger spaces and areas set aside for the crew's use may not be used to stow any hazardous material.

(f) A hazardous material may not be stowed within a horizontal distance of 25 feet of an operating or embarkation point of a lifeboat.

(g) Hazardous materials must be stowed to permit safe access to the crew's quarters and to all parts of the deck required in navigation and necessary working of the vessel.

(h) When runways for use of the crew are built over stowed hazardous materials, they must be constructed and fitted with rails and lifelines so as to

afford complete protection to the crew when in use.

[Amdt. 176-1, 41 FR 16110, Apr. 15, 1976, as amended by Amdt. 176-1B, 41 FR 57072, Dec. 30, 1976; Amdt. 176-30, 55 FR 52689, Dec. 21, 1990; 56 FR 66282, Dec. 20, 1991; 66 FR 45181, Aug. 28, 2001]

§ 176.76 Transport vehicles, freight containers, and portable tanks containing hazardous materials.

(a) Except as provided in paragraphs (b) through (f) of this section, hazardous materials authorized to be transported by vessel may be carried on board a vessel in a transport vehicle or freight container, subject to the following conditions (see additional requirements concerning the transport of Class 1 (explosive) materials in §§ 176.168 through 176.172 of this subchapter):

(1) The material must be in proper condition for transportation according to the requirements of this subchapter;

(2) All packages in the transport vehicle or freight container must be secured to prevent shifting in any direction. Vertical restraint is not required if the shape of the packages, loading pattern, and horizontal restraint preclude vertical shifting of the load within the freight container or transport vehicle;

(3) Bulkheads made of dunnage which extend to the level of the cargo must be provided unless the packages are stowed flush with the sides or ends;

(4) Dunnage must be secured to the floor when the cargo consists of dense materials or heavy packages;

(5) Each package marked in accordance with § 172.312(a)(2) of this subchapter must be stowed as marked;

(6) Any slack spaces between packages must be filled with dunnage;

(7) The weight in a container must be distributed throughout as evenly as possible and the maximum permissible weight must not be exceeded;

(8) Adjacent levels of bagged and baled cargo must be stowed in alternate directions so that each tier binds the tier above and below it;

(9) When security devices, beacons or other tracking or monitoring equipment are used, they must be securely installed and must be of a certified safe type for the hazardous materials that

will be carried within the freight container or transport vehicle in which such as device or equipment is installed.

(10) The lading must be contained entirely within the freight container or vehicle body without overhang or projection except that oversized machinery such as tractors or vehicles with batteries attached may overhang or project outside the intermodal container provided all of that portion of the lading that consists of hazardous materials is contained entirely within the freight container. No open-bed container or vehicle is permitted to carry hazardous materials unless it is equipped with a means of properly securing the lading.

(11) When packages are secured with banding or straps, these restraints must not be over-tightened to cause damage or deformation of the packages or the securing points (such as D-rings) within the freight container or transport vehicle.

(b) A transport vehicle containing hazardous materials may be carried only on board a trailership, trainship, ferry vessel or car float.

(c) [Reserved]

(d) A transport vehicle or freight container equipped with heating or refrigeration equipment may be operated on board a vessel. However, the equipment may not be operated in any hold or compartment in which any flammable liquid or gas is stowed. Any heating or air conditioning equipment having a fuel tank containing a flammable liquid or gas may be stowed only "on deck". Equipment electrically powered and designed to operate within an environment containing flammable vapors may be operated below deck in a hold or compartment containing a flammable liquid or gas.

(e) A transport vehicle, loaded with any hazardous material which is required to be stowed "on deck" by § 172.101 of this subchapter, may be stowed one deck below the weather deck when transported on a trainship or trailership which is unable to provide "on deck" stowage because of the vessel's design. Otherwise, the transport vehicle or container must be transported "on deck."

§ 176.76

49 CFR Ch. I (10–1–14 Edition)

(f) A hazardous material may be carried on board a vessel in a portable tank subject to the following conditions:

(1) Small passenger vessels of 100 gross tons, or less, may carry a hazardous material in a portable tank only when 16 or less passengers are on board and only when specifically authorized by the Officer-in-Charge, Marine Inspection, by endorsement of the vessel's Certificate of Inspection.

(2) Portable tanks containing flammable liquids or gases, combustible liquids with flashpoints below 60 °C (140 °F), that are insoluble in water, or organic peroxides, spontaneously combustible materials, or water reactive materials must be stowed on deck irrespective of the stowage authorized in §172.101 of this subchapter. Portable tanks containing hazardous materials not restricted to on deck stowage by the previous sentence must be stowed in accordance with the requirements specified in §172.101 of this subchapter.

(3) Aluminum, magnesium, and their alloys are specifically prohibited as materials of construction of portable tanks.

(g) *Cryogenic liquids.* For shipment of cryogenic liquids on board a vessel the packaging must be designed and filled so that:

(1) Any cryogenic liquid being transported in a cargo tank, regardless of the pressure in the package, must be contained in a steel jacketed Specification MC-338 (§178.338 of this subchapter) insulated cargo tank.

(2) Any valve or fitting with moving or abrading parts that may come in contact with any cryogenic liquid may not be made of aluminum.

(3) For a flammable cryogenic liquid being transported in a cargo tank, the elapsed time between the loading of the cargo tank and the subsequent unloading of the cargo tank at its final destination may not exceed the marked rated holding time (MRHT) of the cargo tank for the cryogenic liquid being transported, which must be displayed on or adjacent to the specification plate.

(4) Portable tanks, cargo tanks, and tank cars containing cryogenic liquids must be stowed "on deck" regardless of the stowage authorized in §172.101 of

this subchapter. Cargo tanks or tank cars containing cryogenic liquids may be stowed one deck below the weather deck when transported on a trailership or trainship that is unable to provide "on deck" stowage because of the vessel's design. Tank cars must be Class DOT-113 or AAR-204W tank cars.

(h) A fumigated cargo transport unit may only be transported on board a vessel subject to the following conditions and limitations:

(1) The fumigated cargo transport unit may be placed on board a vessel only if at least 24 hours have elapsed since the unit was last fumigated;

(2) The fumigated cargo transport unit is accompanied by a document showing the date of fumigation and the type and amount of fumigant used;

(3) Prior to loading, the master is informed of the intended placement of the fumigated cargo transport unit on board the vessel and the information provided on the accompanying document;

(4) Equipment that is capable of detecting the fumigant and instructions for the equipment's use is provided on the vessel;

(5) The fumigated cargo transport unit must be stowed at least 5 m from any opening to accommodation spaces;

(6) Fumigated cargo transport units may only be transported on deck on vessels carrying more than 25 passengers; and

(7) Fumigants may not be added to cargo transport units while on board a vessel.

(i) A cargo transport unit packed or loaded with flammable gas or flammable liquid having a flashpoint below +23 °C transported on deck must be stowed "away from" possible sources of ignition. In the case of container ships, a distance equivalent to one container space athwartships away from possible sources of ignition applied in any direction will satisfy this requirement.

[Amdt. 176-1, 41 FR 16110, Apr. 15, 1976]

EDITORIAL NOTE: For FEDERAL REGISTER citations affecting §176.76, see the List of CFR Sections Affected, which appears in the Finding Aids section of the printed volume and at www.fdsys.gov.

§ 176.77 Stowage of barges containing hazardous materials on board barge-carrying vessels.

(a) A barge which contains hazardous materials may be transported on board a barge-carrying vessel if it is stowed in accordance with the requirements of this section.

(b) A barge which contains hazardous materials for which only "on deck" stowage is authorized must be stowed above the weather deck and be vented to the atmosphere.

(c) A barge which contains hazardous materials for which both "on deck" and "below deck" stowage is authorized may be stowed above or below the weather deck.

[Amdt. 176-30, 55 FR 52689, Dec. 21, 1990 as amended at 76 FR 56317, Sept. 13, 2011]

§ 176.78 Use of power-operated industrial trucks on board vessels.

(a) *Power Operated trucks.* A power-operated truck (including a power-operated tractor, forklift, or other specialized truck used for cargo handling) may not be used on board a vessel in a space containing a hazardous material unless the truck conforms to the requirements of this section. The COTP may suspend or prohibit the use of cargo handling vehicles or equipment when that use constitutes a safety hazard.

(b) Each truck must have a specific designation of Underwriter's Laboratories or Factory Mutual Laboratories. Any repair or alteration to a truck must be equivalent to that required on the original designation.

(c) *Description of designations.* The recognized testing laboratory type designations are as follows:

(1) An "E" designated unit is an electrically-powered unit that has minimum acceptable safeguards against inherent fire hazards.

(2) An "EE" designated unit is an electrically-powered unit that has, in addition to all the requirements for the "E" unit, the electric motor and all other electrical equipment completely enclosed.

(3) An "EX" designated unit is an electrically-powered unit that differs from the "E" and "EE" unit in that the electrical fittings and equipment are so designed, constructed, and as-

sembled that the unit may be used in certain atmospheres containing flammable vapors or dusts.

(4) A "G" designated unit is a gasoline-powered unit having minimum acceptable safeguards against inherent fire hazards.

(5) A "GS" designated unit is a gasoline-powered unit that is provided with additional safeguards to the exhaust, fuel, and electrical systems.

(6) An "LP" designated unit is similar to a "G" unit except that it is powered by liquefied petroleum gas instead of gasoline.

(7) An "LPS" designated unit is a unit similar to a "GS" unit except that liquefied petroleum gas is used for fuel instead of gasoline.

(8) A "D" designated unit is a unit similar to a "G" unit except that it is powered by a diesel engine instead of a gasoline engine.

(9) A "DS" designated unit is a unit powered by a diesel engine provided with additional safeguards to the exhaust, fuel, and electrical systems.

(d) *Class 1 (explosive) materials.* No power-operated truck may be used to handle Class 1 (explosive) materials or other cargo in an area near Class 1 (explosive) materials on board a vessel except:

(1) A power-operated truck designated EE or EX.

(2) A power-operated truck designated LPS, GS, D, or DS may be used under conditions acceptable to the COTP.

(e) *Other hazardous materials.* (1) Only an "EX", "EE", "GS", "LPA", or "DS" truck may be used in a hold or compartment containing Division 2.1 (flammable gas) materials, Class 3 (flammable liquids), Class 4 (flammable solids) materials, or Class 5 (oxidizers or organic peroxides) materials, cottons or other vegetable fibers, or bulk sulfur.

(2) Only a designated truck may be used to handle any other hazardous material not covered in paragraph (d) or (e)(1) of this section.

(f) *Minimum safety features.* In addition to the construction and design safety features required, each truck must have at least the following minimum safety features:

§ 176.78

49 CFR Ch. I (10-1-14 Edition)

(1) The truck must be equipped with a warning horn, whistle, gong, or other device that may be heard clearly above normal shipboard noises.

(2) When the truck operation may expose the operator to danger from a falling object, the truck must be equipped with a driver's overhead guard. When the overall height of the truck with forks in the lowered position is limited by head room the overhead guard may be omitted. This overhead guard is only intended to offer protection from impact of small packages, boxes, bagged material, or similar hazards.

(3) A forklift truck used to handle small objects or unstable loads must be equipped with a load backrest extension having height, width, and strength sufficient to prevent any load, or part of it, from falling toward the mast when the mast is in a position of maximum backward tilt. The load backrest extension must be constructed in a manner that does not interfere with good visibility.

(4) The forks on a fork lift truck must be secured to the carriage so as to prevent any unintentional lifting of the toe which could create a hazard. The forks may not display permanent deformation when subjected to a test load of three times the rated capacity.

(5) Each fork extension or other attachment must be secured to prevent unintentional lifting or displacement on primary forks.

(6) Tires extending beyond the confines of the truck shall be provided with a guard to prevent the tires from throwing particles at the operator.

(7) Unless the steering mechanism is a type that prevents road reactions from causing the steering handwheel to spin, a mushroom type steering knob must be used to engage the palm of the operator's hand, or the steering mechanism must be arranged in some other manner to prevent injury. The knob must be mounted within the perimeter of the wheel.

(8) All steering controls must be confined within the clearnace of the truck or guarded so that moving of the controls will not result in injury to the operator when passing stanchions, obstructions or other.

(g) *Special operating conditions.* (1) A truck may not be used on board a ves-

sel unless prior notification of its use is given to the master or senior deck officer on board.

(2) Before a truck is operated on board a vessel, it must be in a safe operating condition as determined by the master or senior deck officer on board.

(3) Any truck that emits sparks or flames from the exhaust system must immediately be removed from service and may not be returned to service until the cause of these sparks or flames has been eliminated.

(4)-(5) [Reserved]

(6) All truck motors must be shut off immediately when a breakage or leakage of packages containing flammable liquids or gases, flammable solids, oxidizers, or organic peroxides occurs or is discovered.

(7) The rated capacity of the truck must be posted on the truck at all times in a conspicuous place. This capacity may not be exceeded.

(8) At least one Coast Guard approved marine type size 1 Type B, or UL approved 5BC portable fire extinguisher, or its approved equivalent, must be affixed to the truck in a readily accessible position or must be kept in close proximity, available for immediate use.

(9) The vessel's fire fighting equipment, both fixed (where installed) and portable, must be kept ready for immediate use in the vicinity of the space being worked.

(h) *Refueling.* (1) A truck using gasoline as fuel may not be refueled in the hold or on the weather deck of a vessel unless a portable non-spilling fuel handling system of not over five gallons capacity is used. Gasoline may not be transferred to a portable non-spilling fuel handling device on board the vessel.

(2) A truck using liquefied petroleum gas as fuel may not be refueled in the hold or on the weather deck of a vessel unless it is fitted with a removable tank and the hand-operated shutoff valve of the depleted tank is closed. In addition, the motor must be run until it stalls from lack of fuel and then the hand-operated shut off valve closed before the quick disconnect fitting to the fuel tank is disconnected.

(3) A truck using diesel oil as fuel may not be refueled on the weather

deck or in the hold of a vessel unless a portable container of not over a five gallon capacity is used. A truck may be refueled or a portable container may be refilled from a larger container of diesel fuel on the weather deck of a vessel if a suitable pump is used for the transfer operation and a drip pan of adequate size is used to prevent any dripping of fuel on the deck.

(4) Refueling must be performed under the direct supervision of an experienced and responsible person specifically designated for this duty by the person in charge of the loading or unloading of the vessel.

(5) Refueling may not be undertaken with less than two persons specifically assigned and present for the complete operation, at least one of whom must be experienced in using the portable fire extinguishers required in the fuel area.

(6) At least one Coast Guard approved marine type size 1 Type B or UL approved 5BC portable fire extinguisher or its approved equivalent, must be provided in the fueling area. This is in addition to the extinguisher required by paragraph (g)(8) of this section.

(7) The location for refueling trucks must be designated by the master or senior deck officer on board the vessel. "NO SMOKING" signs must be conspicuously posted in the area.

(8) The location designated for refueling must be adequately ventilated to insure against accumulation of any hazardous concentration of vapors.

(9) Before any truck in a hold is refueled or before any fuel handling device or unmounted liquefied petroleum gas cylinder is placed in a hold, the motors of all trucks in the same hold must be stopped.

(10) All fuel handling devices and unmounted liquefied petroleum gas containers must be removed from a hold before any truck motor is started and the trucks are placed in operation in that hold.

(i) *Replacing batteries.* Batteries for electrically powered trucks and for the ignition systems of internal combustion powered trucks may be changed in the hold of a vessel subject to the following conditions:

(1) Only suitable handling equipment may be employed.

(2) Adequate precautions must be taken to avoid damage to the battery, short circuiting of the battery, and spillage of the electrolyte.

(j) *Charging of batteries.* Batteries of industrial trucks may be recharged in a hold of a vessel subject to the following conditions:

(1) The batteries must be housed in a suitable, ventilated, portable metal container with a suitable outlet at the top for connection of a portable air hose, or must be placed directly beneath a suitable outlet at the top for connection of a portable air hose. The air hose must be permanently connected to an exhaust duct leading to the open deck and terminate in a gooseneck or other suitable weather head. If natural ventilation is not practicable or adequate, mechanical means of exhaust must be employed in conjunction with the duct. The air outlet on the battery container must be equipped with an interlock switch so arranged that the charging of the battery cannot take place unless the air hose is properly connected to the box.

(2) If mechanical ventilation is used, an additional interlock must be provided between the fan and the charging circuit so that the fan must be in operation in order to complete the charging circuit for operation. It is preferable that this interlock switch be of a centrifugal type driven by the fan shaft.

(3) The hold may not contain any hazardous materials.

(4) The charging facilities may be part of the truck equipment or may be separate from the truck and located inside or outside the cargo hold. The power supply or charging circuit (whichever method is used) must be connected to the truck by a portable plug connection of the break-away type. This portable plug must be so engaged with the truck battery charging outlet that any movement of the truck away from the charging station will break the connection between the plug and receptacle without exposing any live parts to contact with a conducting surface or object and without the plug falling to the deck where it may become subject to damage.

(5) All unmounted batteries must be suitably protected or removed from an

§ 176.80

area in the hold of the vessel before any truck is operated in that area.

(k) *Stowage of power-operated industrial trucks on board a vessel.* Trucks stowed on board a vessel must meet vessel stowage requirements in § 176.905.

(l) *Packaging and stowage of fuel on board a vessel.* Division 2.1 (flammable gas) materials and flammable liquids used as fuel for industrial trucks must be packaged and stowed as authorized in 46 CFR 147.60 or 46 CFR 147.45, respectively.

[Amdt. 176-1, 41 FR 16110, Apr. 15, 1976, as amended by Amdt. 176-1A, 41 FR 40687, Sept. 20, 1976; Amdt. 176-30, 55 FR 52689, Dec. 21, 1990; Amdt. 176-39, 61 FR 18933, Apr. 29, 1996; Amdt. 176-43, 62 FR 24741, May 6, 1997; 65 FR 58630, Sept. 29, 2000; 68 FR 61942, Oct. 30, 2003]

Subpart D—General Segregation Requirements

§ 176.80 Applicability.

(a) This subpart sets forth segregation requirements in addition to any segregation requirements set forth elsewhere in this subchapter.

(b) Hazardous materials in limited quantities when loaded in transport vehicles and freight containers, are exempted from the segregation requirements of this subpart and any additional segregation specified in this subchapter for transportation by vessel.

[Amdt. 176-1, 41 FR 16110, Apr. 15, 1976, as amended by Amdt. 176-3, 42 FR 57967, Nov. 7, 1977]

§ 176.83 Segregation.

(a) *General.* (1) The requirements of this section apply to all cargo spaces on deck or under deck of all types of vessels, and to all cargo transport units.

(2) Segregation is obtained by maintaining certain distances between incompatible hazardous materials or by requiring the presence of one or more steel bulkheads or decks between them or a combination thereof. Intervening spaces between such hazardous materials may be filled with other cargo which is not incompatible with the hazardous materials.

(3) The general requirements for segregation between the various classes of dangerous goods are shown in the seg-

49 CFR Ch. I (10-1-14 Edition)

regation table. In addition to these general requirements, there may be a need to segregate a particular material from other materials which would contribute to its hazard. Such segregation requirements are indicated by code numbers in Column 10B of the § 172.101 Table.

(4) Segregation is not required:

(i) Between hazardous materials of different classes which comprise the same substance but vary only in their water content (for example, sodium sulfide in Division 4.2 or Class 8) or quantity for Class 7 materials; or

(ii) Between hazardous materials of different classes which comprise a group of substances that do not react dangerously with each other. The following materials are grouped by compatibility:

(A) Hydrogen peroxide, aqueous solutions *with not less than 8 percent but less than 20 percent hydrogen peroxide (stabilized as necessary)*; Hydrogen peroxide, aqueous solutions *with not less than 20 percent but not more than 40 percent hydrogen peroxide*; Hydrogen peroxide, aqueous solutions *with more than 40 percent but not more than 60 percent hydrogen peroxide*; Hydrogen peroxide and peroxyacetic acid mixtures, *stabilized with acids, water and not more than 5 percent peroxyacetic acid*; Organic peroxide type D, liquid; Organic peroxide type E, liquid; Organic peroxide type F, liquid; and

(B) Dichlorosilane, Silicon tetrachloride, and Trichlorosilane.

(5) Whenever hazardous materials are stowed together, whether or not in a cargo transport unit, the segregation of such hazardous materials from others must always be in accordance with the most restrictive requirements for any of the hazardous materials concerned.

(6) When the § 172.101 Table or § 172.402 requires packages to bear a subsidiary hazard label or labels, the segregation appropriate to the subsidiary hazards must be applied when that segregation is more restrictive than that required by the primary hazard. For the purposes of this paragraph, the segregation requirements corresponding to an explosive subsidiary hazard are—except for organic peroxides which are those

corresponding to Division 1.3—those for Division 1.4 (explosive) materials.

(7) Where, for the purposes of segregation, terms such as “away from” a particular hazard class are used in the §172.101 Table, the segregation requirement applies to:

(i) All hazardous materials within the hazard class; and

(ii) All hazardous materials for which a secondary hazard label of that class is required.

(8) Notwithstanding the requirements of paragraphs (a)(6) and (a)(7) of this section, hazardous materials of the same class may be stowed together without regard to segregation required by secondary hazards (subsidiary risk label(s)), provided the substances do not react dangerously with each other and cause:

(i) Combustion and/or evolution of considerable heat;

(ii) Evolution of flammable, toxic or asphyxiant gases;

(iii) The formation of corrosive substances; or

(iv) The formation of unstable substances.

(9) Stowage in a shelter-tween deck cargo space is not considered to be “on deck” stowage.

(10) Where the code in column (10B) of the §172.101 Table specifies that “Segregation as for. . .” applies, the segregation requirements applicable to

that class in the §176.83(b) General Segregation Table must be applied. However, for the purposes of paragraph (a)(8) of this section, which permits substances of the same class to be stowed together provided they do not react dangerously with each other, the segregation requirements of the class as represented by the primary hazard class in the §172.101 Table entry must be applied.

(11) Certain exceptions from segregation for waste cyanides or waste cyanide mixtures or solutions transported with acids; waste Division 4.2 materials transported with Class 8 liquids; and waste Division 6.1 Packing Group I, Hazard Zone A material transported with waste Class 3 material, Class 8 liquids, and Division 4.1, 4.2, 4.3, 5.1 or 5.2 material are set forth in §173.12(e) of this subchapter.

(b) *General Segregation Table.* The following table sets forth the general requirements for segregation between the various classes (divisions) of hazardous materials. Certain divisions are listed as separate hazard classes for the purpose of this table (e.g., “2.1” and “2.2”). The properties of materials within each class may vary greatly and may require greater segregation than is reflected in this table. If the §172.101 Table sets forth particular requirements for segregation, they take precedence over these general requirements.

TABLE 176.83(b)—GENERAL SEGREGATION REQUIREMENTS FOR HAZARDOUS MATERIALS

[Segregation must also take account of a single secondary hazard label, as required by paragraph (a)(6) of this section.]

Class	1.1 1.2 1.5	1.3	1.4 1.6	2.1	2.2	2.3	3	4.1	4.2	4.3	5.1	5.2	6.1	6.2	7	8	9
Explosives, 1.1, 1.2, 1.5	(*)	(*)	(*)	4	2	2	4	4	4	4	4	4	2	4	2	4	X
Explosives, 1.3	(*)	(*)	(*)	4	2	2	4	3	3	4	4	4	2	4	2	2	X
Explosives, 1.4, 1.6	(*)	(*)	(*)	2	1	1	2	2	2	2	2	2	X	4	2	2	X
Flammable gases 2.1	4	4	2	X	X	X	2	1	2	X	2	2	X	4	2	1	X
Non-toxic, non-flammable gases 2.2	2	2	1	X	X	X	1	X	1	X	X	1	X	2	1	X	X
Poisonous gases 2.3	2	2	1	X	X	X	2	X	2	X	X	2	X	2	1	X	X
Flammable liquids 3	4	4	2	2	1	2	X	X	2	1	2	2	X	3	2	X	X
Flammable solids 4.1	4	3	2	1	X	X	X	X	1	X	1	2	X	3	2	1	X
Spontaneously combustible substances 4.2	4	3	2	2	1	2	2	1	X	1	2	2	1	3	2	1	X
Substances which are dangerous when wet 4.3	4	4	2	X	X	X	1	X	1	X	2	2	X	2	2	1	X
Oxidizing substances 5.1	4	4	2	2	X	X	2	1	2	2	X	2	1	3	1	2	X
Organic peroxides 5.2	4	4	2	2	1	2	2	2	2	2	2	X	1	3	2	2	X
Poisons 6.1	2	2	X	X	X	X	X	X	1	X	1	1	X	1	X	X	X
Infectious substances 6.2	4	4	4	4	2	2	3	3	3	2	3	3	1	X	3	3	X

TABLE 176.83(b)—GENERAL SEGREGATION REQUIREMENTS FOR HAZARDOUS MATERIALS—
Continued

[Segregation must also take account of a single secondary hazard label, as required by paragraph (a)(6) of this section.]

Class	1.1 1.2 1.5	1.3	1.4 1.6	2.1	2.2	2.3	3	4.1	4.2	4.3	5.1	5.2	6.1	6.2	7	8	9
Radioactive materials																	
7	2	2	2	2	1	1	2	2	2	2	1	2	X	3	X	2	X
Corrosives 8	4	2	2	1	X	X	X	1	1	1	2	2	X	3	2	X	X
Miscellaneous dan- gerous substances 9	X	X	X	X	X	X	X	X	X	X	X	X	X	X	X	X	X

Numbers and symbols relate to the following terms as defined in this section:
 1—"Away from."
 2—"Separated from."
 3—"Separated by a complete compartment or hold from."
 4—"Separated longitudinally by an intervening complete compartment or hold from."
 X—The segregation, if any, is shown in the § 172.101 table.
 *—See § 176.144 of this part for segregation within Class 1.

(c) Segregation requirements for breakbulk cargo. (1) The requirements of this paragraph apply to the segregation of packages containing hazardous materials and stowed as breakbulk cargo; (2) Definition of the segregation terms:

- (i) Legend:
 - (A) Package containing incompatible goods.

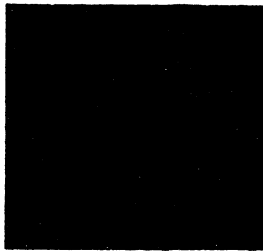

(B) Reference package.

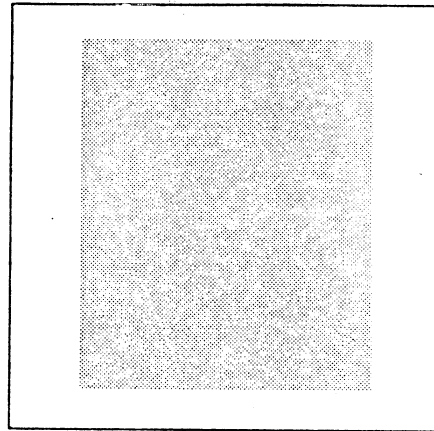

(C) Deck resistant to fire and liquid.



NOTE: Full vertical lines represent transverse bulkheads between compartments or holds resistant to fire and liquid.

(ii) "Away from": Effectively segregated so that the incompatible materials cannot interact dangerously in the event of an accident but may be carried in the same compartment or hold or on deck provided a minimum horizontal separation of 3 m (10 feet) projected vertically is obtained.

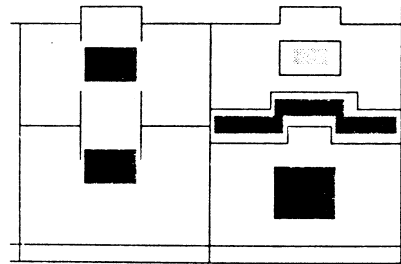
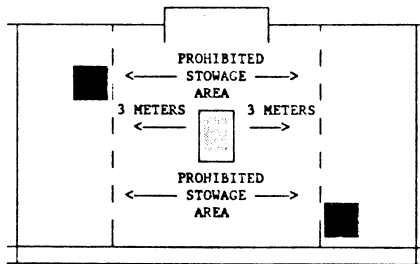

(iii) "Separated From": In different compartments or holds when stowed under deck. If the intervening deck is resistant to fire and liquid, a vertical separation (i.e., in different compartments) is acceptable as equivalent to this segregation. For "on deck" stowage, this segregation means a separation by a distance of at least 6 m (20 feet) horizontally.

(iv) "Separated by a complete compartment or hold from": Either a vertical or horizontal separation. If the intervening decks are not resistant to fire and liquid, then only a longitudinal separation (i.e., by an intervening complete compartment or hold) is acceptable. For "on deck" stowage, this segregation means a separation by a distance of at least 12 m (39 feet) horizontally. The same distance must be applied if one package is stowed "on deck", and the other one in an upper compartment.

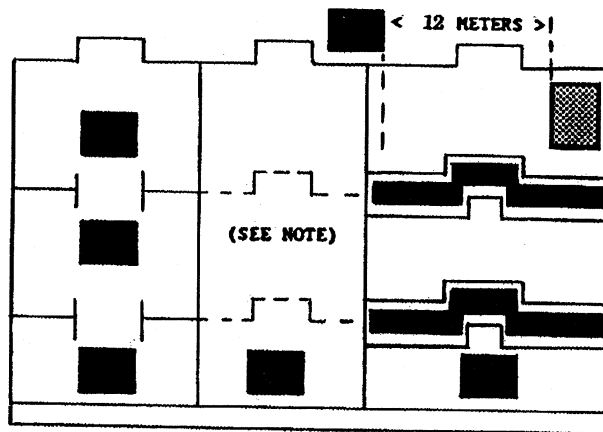

NOTE: One of the two decks must be resistant to fire and liquid.

(v) "Separated longitudinally by an intervening complete compartment or hold from": Vertical separation alone does not meet this requirement. Between a package "under deck" and one "on deck" a minimum distance of 24 m (79

feet) including a complete compartment must be maintained longitudinally. For "on deck" stowage, this segregation means a separation by a distance of at least 24 m (79 feet) longitudinally.

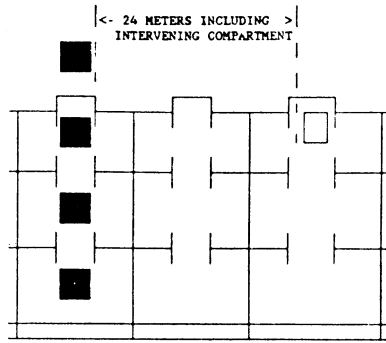

(d) *Segregation in cargo transport units:* Two hazardous materials for which any segregation is required may not be stowed in the same cargo transport unit.

(e) *Segregation of hazardous materials stowed as breakbulk cargo from those packed in cargo transport units:* (1) Hazardous materials stowed as breakbulk cargo must be segregated from materials packed in open cargo transport units in accordance with paragraph (c) of this section.

(2) Hazardous materials stowed as breakbulk cargo must be segregated from materials packed in closed cargo transport units in accordance with

paragraph (c) of this section, except that:

(i) Where “away from” is required, no segregation between packages and the closed cargo transport units is required; and

(ii) Where “separated from” is required, the segregation between the packages and the closed cargo transport units may be the same as for “away from”.

(f) *Segregation of cargo transport units on board container vessels:* (1) Except for hatchless container ships, this paragraph applies to segregation of cargo transport units that are carried on board container vessels, or on other types of vessels, provided these cargo spaces are properly fitted for permanent stowage of containers during transport.

(2) For container vessels which have cargo spaces used for breakbulk cargo or any other method of stowage, the appropriate paragraph of this section applies to the relevant cargo space.

(3) *Segregation Table.* Table §176.83(f) sets forth the general requirements for segregation between cargo transport units on board container vessels.

(4) In table §176.83(f), a *container space* means a distance of not less than 6 m (20 feet) fore and aft or not less than 2.5 m (8 feet) athwartship.

TABLE 176.83(f)—SEGREGATION OF CONTAINERS ON BOARD CONTAINER SHIPS

Segregation requirement	Vertical			Horizontal							
	Closed versus closed	Closed versus open	Open versus open	Closed versus closed		Closed versus open		Open versus open			
				On deck	Under deck	On deck	Under deck	On deck	Under deck		
1. "Away from"	One on top of the other permitted.	Open on top of closed permitted.	Not in the same vertical line unless segregated by a deck.	No restriction	No restriction	No restriction	No restriction	One container space.	One container space.	One container space or one bulkhead.	One container space.
2. "Separated from".	Not in the same vertical line unless segregated by a deck.	As for open versus open.	Not in the same vertical line unless segregated by a deck.	One container space.	One container space.	One container space.	One container space or one bulkhead.	One container space.	Two container spaces.	One bulkhead.	One bulkhead.
3. "Separated by a complete compartment or hold from".	Not in the same vertical line unless segregated by a deck.	As for open versus open.	Not in the same vertical line unless segregated by a deck.	One container space.	One container space.	One container space.	One bulkhead	One container space.	Two container spaces.	Two bulkheads.	Two bulkheads.
4. "Separated longitudinally by an intervening complete compartment or hold from".	Prohibited	Prohibited	Four container spaces.	One bulkhead and four container spaces*.	Prohibited	Prohibited

* Containers not less than 6 m (20 feet) from intervening bulkhead.
NOTE: All bulkheads and decks must be resistant to fire and liquid.

(g) *Segregation of cargo transport units on board trailerships and trainships:* (1) The requirements of this paragraph apply to the segregation of cargo transport units which are carried on board trailerships and trainships or in “roll-on/roll-off” cargo spaces.

(2) For trailerships and trainships which have spaces suitable for

breakbulk cargo, containers, or any other method of stowage, the appropriate paragraph of this section applies to the relevant cargo space.

(3) *Segregation Table.* Table §176.83(g) sets forth the general requirements for segregation between transport units on board trailerships and trainships.

TABLE 176.83(g)—SEGREGATION OF CARGO TRANSPORT UNITS ON BOARD TRAILERSHIPS AND TRAINSHIPS.

Segregation requirement		Closed versus closed		Closed versus open		Open versus open	
		On deck	Under deck	On deck	Under deck	On deck	Under deck
		1. “Away From”	Fore and aft Athwartships	No restriction	No restriction	No restriction	No restriction
2. “Separated from”.	Fore and aft	At least 6 m	At least 6 m or one bulkhead.	At least 6 m	At least 6 m or one bulkhead.	At least 6 m	At least 12 m or one bulkhead
	Athwartships	At least 3 m	At least 3 m or one bulkhead.	At least 3 m	At least 6 m or one bulkhead.	At least 6 m	At least 12 m or one bulkhead
3. “Separated by a complete compartment or hold from”.	Fore and aft	At least 12 m	At least 24 m + deck.	At least 24 m	At least 24 m + deck.	At least 36 m	Two decks or two bulkheads.
	Athwartships	At least 12 m	At least 24 m + deck.	At least 24 m	At least 24 m + deck.	At least 36 m	Prohibited.
4. “Separated longitudinally by an intervening complete compartment or hold from”.	Fore and aft	At least 36 m	Two bulkheads or at least 36 m + two decks.	At least 36 m	At least 48 m including two bulkheads.	At least 48 m	Prohibited.
	Athwartships	Prohibited	Prohibited	Prohibited	Prohibited	Prohibited	Prohibited.

NOTE: All bulkheads and decks must be resistant to fire and liquid.

(h) *Segregation on board barge carrying vessels:* (1) The requirements of this section apply to the segregation in shipborne barges as well as to the segregation between shipborne barges carried on board vessels specially designed and equipped to carry such barges.

(2) On barge-carrying vessels which incorporate other stowage spaces or any other method of stowage, barges containing hazardous materials must be segregated from hazardous materials not stowed in barges as prescribed in paragraphs (b) and (j) of this section.

(i) *Segregation in shipborne barges:* Hazardous materials transported in shipborne barges must be segregated as prescribed in paragraphs (a), (b), and (c) of this section.

(j) *Segregation between shipborne barges on barge-carrying vessels:* (1) When a shipborne barge is loaded with two or more hazardous materials with different requirements for segregation,

the most stringent applicable segregation requirement must be applied.

(2) “Away from” and “separated from” require no segregation between shipborne barges.

(3) For barge-carrying vessels with vertical holds, “Separated by a complete compartment or hold from” means that separate holds are required. On barge-carrying vessels having horizontal barge levels, separate barge levels are required and the barges may not be in the same vertical line.

(4) “Separated longitudinally by an intervening complete compartment or hold from” means, for barge-carrying vessels with vertical holds, that separation by an intervening hold or engine room is required. On barge-carrying vessels having horizontal barge levels, separate barge levels and a longitudinal separation by at least two intervening barge spaces are required.

(k) *Segregation requirements for ferry vessels:* A ferry vessel (when operating either as a passenger or cargo vessel) that cannot provide the separation required in this section may carry incompatible hazardous materials in separate transport vehicles if they are stowed to give the maximum possible separation.

(1) *Segregation of containers on board hatchless (open-top) container ships:* (1) This paragraph applies to the segregation of cargo transport units that are transported on board hatchless container ships provided that the cargo spaces are properly fitted to give permanent stowage of the cargo transport units during transport.

(2) For container ships that have both hatchless container spaces and other spaces suitable for breakbulk cargo, conventional container stowage, or any other method of stowage, the appropriate requirements of this section apply to the relevant cargo space.

(3) *Segregation Table.* Table §176.83(1)(3) sets forth the general requirements for segregation of cargo transport units on board hatchless container ships.

(4) In Table §176.83(1)(3), a container space means a distance of not less than 6 m (20 feet) fore and aft or not less than 2.5 m (8 feet) athwartship.

TABLE § 176.83(L)(3)—SEGREGATION OF CARGO TRANSPORT UNITS ON BOARD HATCHLESS CONTAINER SHIPS

Segregation requirement	Vertical				Horizontal			
	Closed versus closed	Closed versus open	Open versus open		Closed versus closed		Closed versus open	
					On deck	Under deck	On deck	Under deck
1. "Away from"	On top of the other permitted.	Open on top of closed permitted.	Fore and aft	No restriction	No restriction	No restriction	One container space or one bulkhead.
2. "Separated from"	Otherwise as for "Open versus open".	Athwart ships.	No restriction	No restriction	No restriction	One container space.
3. "Separated by a complete compartment or hold from"	Not in the same vertical line.	As for "Open versus open".	Fore and aft	One container space.	One container space or one bulkhead.	One container space and not in or above same hold.	One bulkhead.
4. "Separated longitudinally by an intervening compartment or hold from"	Prohibited ...	Prohibited	Athwart ships.	One container space and not in or above same hold.	One bulkhead	One bulkhead	Two bulkheads.
				Fore and aft	Two container spaces and not in or above same hold.	One bulkhead	One bulkhead	Two bulkheads.
				Athwart ships.	Minimum horizontal distance of 24 m and not in or above same hold.	Minimum horizontal distance of 24 m and not in or above same hold.	Minimum horizontal distance of 24 m and not in or above same hold.	Two bulkheads.
				Fore and aft	Prohibited	Prohibited	Prohibited	Prohibited
				Athwart ships.	Prohibited	Prohibited	Prohibited	Prohibited

* Containers not less than 6 m (20 feet) from intervening bulkhead
Note: All bulkheads and decks must be resistant to fire and liquid.

(m) *Provisions for segregation groups:* (1) For the purpose of segregation, materials having certain similar chemical properties have been grouped together in segregation groups. The segregation groups (such as "acids", "chlorates", "permanganates") and the entries allocated to each of these groups include the substances identified in section 3.1.4 of the IMDG Code (IBR, see §171.7 of this subchapter). When column (10B) of the §172.101 Table refers to a numbered stowage provision set forth in §176.84(b) such as "Stow 'away from' acids", that particular stowage/segregation requirement applies to all the materials allocated to the respective segregation group.

(2) Not all hazardous materials falling within a segregation group are listed by name in the regulations. These materials are shipped under "n.o.s." entries. Although these "n.o.s." entries are not listed themselves in the above groups, the person who offers a hazardous material for transportation must decide whether allocation under a segregation group is appropriate.

(3) The segregation groups described above do not address materials that fall outside the classification criteria of the hazardous materials regulations, although it is recognized that some non-hazardous materials have certain chemical properties similar to hazardous materials listed in the segregation groups. A person who offers a hazardous material for transportation or the person responsible for packing the materials into a cargo transport unit who does have knowledge of the chemical properties of such non-hazardous materials may identify a relevant segregation group and apply the segregation requirements for that segregation group.

[Amdt. 176-30, 55 FR 52690, Dec. 21, 1990]

EDITORIAL NOTE: For FEDERAL REGISTER citations affecting §176.83, see the List of CFR Sections Affected, which appears in the Finding Aids section of the printed volume and at www.fdsys.gov.

§ 176.84 Other requirements for stowage and segregation for cargo vessels and passenger vessels.

(a) *General.* When Column 10B of the §172.101 Table refers to a numbered or alpha-numeric stowage provision for

water shipments, the meaning and requirements of that provision are set forth in this section. Terms in quotation marks are defined in §176.83. Other terms used in the table in this section such as "acids", "chlorates" and "permanganates" indicate different chemical groups referred to here as segregation groups. Materials falling within a segregation group are considered to have certain similar chemical properties and, although not exhaustive in nature, the materials belonging to each group include those substances identified in section 3.1.4 of the IMDG Code (IBR, see §171.7 of this subchapter) as set forth in §176.83(m).

(b) *Table of provisions:*

Code	Provisions
1	[Reserved]
2	Temperature controlled material.
3	Do not stow with high explosives.
4	Stow "Separated from" liquid organic materials.
5	Stow "Separated from" powdered metals and their compounds.
6	Emergency temperature material.
7	[Reserved]
8	Glass carboys not permitted on passenger vessels.
9	Glass carboys not permitted under deck.
10	Glass bottles not permitted under deck.
11	Keep away from heat and open flame.
12	Keep as cool as reasonably practicable.
13	Keep as dry as reasonably practicable.
14	For metal drums, stowage permitted under deck on cargo vessels.
15	May be stowed in portable magazine or metal locker.
16	No other cargo may be stowed in the same hold with this material.
17	Segregation same as for flammable gases but "away from" dangerous when wet.
18	Prohibited on any vessel carrying explosives (except explosives in Division 1.4, Compatibility group S).
20	Segregation same as for corrosives.
21	Segregation same as for flammable liquids.
22	Segregation same as for flammable liquids if flash point is below 60 °C (140 °F).
23	Segregation same as for flammable liquids if flash point is between 23 °C (73 °F) and 60 °C (140 °F).
24	Segregation same as for flammable solids.
25	Protected from sources of heat
26	Stow "away from" acids. ²
27	Stow "away from" alkaline compounds. ²
28	Stow "away from" flammable liquids.
29	Stow "away from" ammonium compounds.
30	Stow "away from" animal or vegetable oils.
31	Stow "away from" combustible materials.
32	Stow "away from" copper, its alloys and its salts.
33	Stow "away from" fluorides.
34	Stow "away from" foodstuffs.
35	Stow "away from" all odor-absorbing cargo.
36	Stow "away from" heavy metals and their compounds.
37	Stow "away from" hydrazine.

§ 176.84

49 CFR Ch. I (10–1–14 Edition)

Code	Provisions
38	Stow "away from" all other corrosives.
39	Stow "away from" liquid halogenated hydrocarbons.
40	Stow "clear of living quarters".
41	Stow "away from" mercury and its compounds.
42	Stow "away from" nitric acids and perchloric acids not exceeding 50 percent acid by weight.
43	Stow "away from" organic materials.
44	Stow "away from" oxidizers.
45	Stow "away from" permanganates.
46	Stow "away from" powdered metals.
47	Stow "away from" sodium compounds.
49	Stow "away from" corrosives.
51	Stow "separated from" acetylene.
52	Stow "separated from" acids. ^{1 2}
53	Stow "separated from" alkaline compounds. ²
54	Stow "separated from" animal or vegetable oils.
55	Stow "separated from" ammonia.
56	Stow "separated from" ammonium compounds.
57	Stow "separated from" chlorine.
58	Stow "separated from" cyanides.
59	Stow "separated from" combustible materials.
60	Stow "separated from" chlorates, chlorites, hypochlorites, nitrites, perchlorates, permanganates, and metallic powders.
61	Stow "separated from" corrosive materials.
62	Stow "separated from" diborane.
63	Stow "separated from" diethylene triamine.
64	Stow "separated from" explosives.
65	Stow "separated from" flammable substances.
66	Stow "separated from" flammable solids.
67	Stow "separated from" halides.
68	Stow "separated from" hydrogen.
69	Stow "separated from" hydrogen peroxide.
70	Stow "separated from" mercury salts.
71	Stow "separated from" nitric acid.
72	Stow "separated from" nitrogen compounds.
73	Stow "separated from" chlorates.
74	Stow "separated from" oxidizers.
75	Stow "separated from" permanganates.
76	Stow "separated by a complete compartment or hold from" organic peroxides.
77	Stow "separated longitudinally by a complete compartment or hold from" explosives.
78	Stow "separated longitudinally by an intervening complete compartment or hold from" explosives.
79	The maximum net quantity in one package for this material shipped aboard a passenger vessel is limited to 22.7 kg (50 pounds).
80	Toy torpedoes must not be packed with other special fireworks.
81	Under deck stowage permitted only if an indicating substance such as chloropicrin has been added.
82	Under deck stowage is permitted only if containing not more than 36 percent by weight of hydrazine.
83	[Reserved]
84	Under deck stowage must be in well-ventilated space.
85	Under deck stowage must be in mechanically ventilated space.

Code	Provisions
86	Stow "separated by a complete compartment or hold from" explosives Division 1.3.
87	Stow "separated from" Class 1 (explosives) except Division 1.4.
88	Stow "separated by a complete compartment or hold from" Class 1 (explosives) except Division 1.4.
89	Segregation same as for oxidizers.
90	Stow "separated from" radioactive materials.
91	Stow "separated from" flammable liquids.
92	Stow "separated from" powdered materials.
93	Stow not accessible to unauthorized persons on passenger vessels.
94	Plastic jerricans and plastic drums not permitted under deck.
95	Stow "separated from" foodstuffs.
96	Glass carboys not permitted under deck on passenger vessels.
97	Stow "away from" azides.
98	Stow "away from" all flammable materials.
99	Only new metal drums permitted on passenger vessels.
100	Stow "away from" flammable solids.
101	Stow "separated from" iron oxide.
102	Stow "separated from" all odor absorbing cargoes.
103	Only to be loaded under dry weather conditions.
104	Stow "separated from" bromine.
105	As approved by the Competent Authority of the country concerned.
106	Stow "separated from" powdered metal.
107	Stow "separated from" peroxides and superoxides.
108	The transport temperature should be indicated on the tank.
109	Label as a flammable liquid if flash point is 60 °C (140 °F) or below.
110	Packaging Group II if concentration does not exceed 70 percent acid.
111	If concentration exceeds 50 percent acid, notes 66, 74, 89, and 90 apply.
112	Packaging Group II for concentrations not less than 50 percent and Packaging Group III for concentrations less than 50 percent.
113	Packaging Group II if concentrations does not exceed 60 percent acid.
114	Corrosive subsidiary risk label required unless concentration is less than 80 percent.
115	If packaged in glass or earthenware inner packagings in wooden or fiberboard outer packagings, the maximum quantity on any vessel is 500 kg (equivalent to 450 L).
116	In a cargo space capable of being opened up in an emergency. The possible need to open hatches in case of fire to provide maximum ventilation and to apply water in an emergency and the consequent risk to the stability of the ship through flooding of the cargo space should be considered before loading.

Code	Provisions
117	In a clean cargo space capable of being opened up in an emergency. In the case of bagged fertilizer in freight containers, it is sufficient if in the case of an emergency, the cargo is accessible through free approaches (hatch entries) and mechanical ventilation enables the master to exhaust any gases or fumes resulting from decomposition. The possible need to open hatches in case of fire to provide maximum ventilation and to apply water in an emergency and the consequent risk to the stability of the ship through flooding of the cargo space should be considered before loading.
118	Stowage—Category D, Category E freight containers and pallet boxes only. Ventilation may be required. The possible need to open hatches in a case of fire to provide maximum ventilation and to supply water in an emergency, and the consequent risk to the stability of the ship through flooding of the cargo space, should be considered before loading.
119	Double strip stowage recommended.
120	Provide good surface and through ventilation.
121	Packaging group III when the flash point of the flammable liquid is 23 °C (73 °F) or above.
122	Stow "separated from" infectious substances.
123	Stow "away from" infectious substances.
124	Stow "separated from" bromates.
125	Segregation same as for flammable liquids, but also "away from" flammable solids.
126	Segregation same as for Class 9, miscellaneous hazardous materials.
127	For packages carrying a subsidiary risk of Class 1 (explosives), segregation same as for Class 1, Division 1.3.
128	Stow in accordance with the IMDG Code, Sub-section 7.6.2.7.2 (incorporated by reference; see § 171.7 of this subchapter).
129	Stowage Category A applies, except for uranyl nitrate hexahydrate solution for which Category D applies.
130	Stowage Category A applies, except for uranyl nitrate hexahydrate solution, uranium metal hexahydrate solution, uranium metal pyrophoric and thorium metal pyrophoric for which Category D applies.
131	Stowage Category A applies, except for uranyl nitrate hexahydrate solution, uranium metal pyrophoric and thorium metal pyrophoric for which Category D applies, and taking into account any supplementary requirements specified in the transport documents.
132	Stowage A applies, taking into account any supplementary requirements specified in the transport documents.
133	Stow "separated from" sulfur.
134	Stow "separated from" UN2716.
135	Stow "Separated from" mercury and mercury compounds.
136	Stow "Separated from" carbon tetrachloride.
137	For arsenic sulphides, Stow "separated from" acids.
138	Stow "Separated from" peroxides.
141	Stow "away from" radioactive materials.
142	Packages in cargo transport units must be stowed so as to allow for adequate air circulation throughout the cargo.

Code	Provisions
144	When stowed under deck, mechanical ventilation shall be in accordance with SOLAS, Chapter II-2/Regulation 19 (IBR, see § 171.7 of this subchapter) for flammable liquids with flashpoint below 23 °C (73 °F).
145	Stow "separated from" ammonium compounds except for UN1444.
146	Category B stowage applies for unit loads in open cargo transport units.
M1—M6	[Reserved]

¹For waste cyanides or waste cyanide mixtures or solutions, refer to § 173.12(e) of this subchapter.
²Class 8 materials in PG II or III that otherwise are required to be segregated from one another may be transported in the same cargo transport unit, whether in the same packaging or not, provided the substances do not react dangerously with each other to cause combustion and/or evolution of considerable heat, or of flammable, toxic or asphyxiant gases, or the formation of corrosive or unstable substances; and the package does not contain more than 30 L (7.8 gallons) for liquids or 30 kg (66 lbs.) for solids.

(c) *Provisions for the stowage of Class 1 (explosive) materials:* (1) Explosive substances and explosive articles must be stowed in accordance with Column (10A) and Column (10B) of the 172.101 Table of this subchapter.

(2) The following notes in column 10B of the § 172.101 Table apply to the transport of Class 1 (explosive) materials by vessel:

Notes	Provisions
5E	Stow "away from" lead and its compounds.
14E	On deck, cargo transport unit must be steel.
15E	On deck, cargo transport unit must be leak-proof.
17E	On deck stowage is recommended.
19E	"Away from" explosives containing chlorates or perchlorates.
21E	Cargo space ventilation must be carefully controlled to avoid excessive condensation.
22E	"Away from" ammonium compounds and explosives containing ammonium compounds or salts.
23E	"Separated from" Division 1.4 and "separated longitudinally by an intervening complete compartment or hold from" Division 1.1, 1.2, 1.3, 1.5, and 1.6 except from explosives of compatibility group J.
26E	For closed cargo transport units, a non-metallic lining is required when not in effectively sealed, sift-proof packages.
27E	For closed cargo transport units, a non-metallic lining is required.

[Amdt. 176-30, 55 FR 52693, Dec. 21, 1990, as amended at 56 FR 66282, Dec. 20, 1991; Amdt. 176-43, 62 FR 24742, May 6, 1997; 66 FR 33438, June 21, 2001; 66 FR 45185, 45384, Aug. 28, 2001; 67 FR 15744, Apr. 3, 2002; 68 FR 45040, July 31, 2003; 69 FR 76183, Dec. 20, 2004; 70 FR 3310, Jan. 24, 2005; 71 FR 78634, Dec. 29, 2006; 74 FR 2268, Jan. 14, 2009; 76 FR 3384, Jan. 19, 2011; 78 FR 1094, Jan. 7, 2013]

Subpart E—Special Requirements for Transport Vehicles Loaded With Hazardous Materials and Transported on Board Ferry Vessels

§ 176.88 Applicability.

The requirements in this subpart are applicable to transport vehicles containing hazardous materials being transported on board ferry vessels and are in addition to any prescribed elsewhere in this subchapter. Vessels in a service similar to a ferry service, but not over a designated ferry route, may be treated as a ferry vessel for the purpose of this subpart if approved in writing by the District Commander.

[Amdt. 176–1, 41 FR 16110, Apr. 15, 1976, as amended by Amdt. 176–1A, 41 FR 40690, Sept. 20, 1976]

§ 176.89 Control of transport vehicles.

(a) A transport vehicle containing hazardous materials may be transported on board a ferry vessel, subject to the following conditions:

- (1) The operator or person in charge of the vehicle shall deliver to the vessel's representative a copy of the shipping papers and certificate required by §§ 176.24 and 176.27;
 - (2) The vehicle shall be placed at the location indicated by the vessel's representative;
 - (3) The parking brakes of the vehicle shall be set securely to prevent movement;
 - (4) The motor of a highway vehicle shall be shut off and not restarted until the vessel has completed its voyage and docked;
 - (5) All vehicle lights shall be cut off and not relighted until the vessel has completed its voyage and docked;
 - (6) The operator of a highway vehicle shall remain with the vehicle;
 - (7) No repairs or adjustments must be made to the vehicle while it is on the vessel;
 - (8) No hazardous materials are to be released from the vehicle; and
 - (9) Any instructions given by the vessel's representative during the voyage, and during "roll on" and "roll off" operations must be observed.
- (b) Smoking by any person in or around a vehicle is prohibited.

§ 176.90 Private automobiles.

A private automobile which is carrying any Class 1 (explosive) material (except permitted fireworks or small arms ammunition) may not be transported on a passenger-carrying ferry vessel unless the Class 1 (explosive) material is in compliance with packaging, labeling, marking, and certification requirements of this subchapter. Permitted fireworks and small arms ammunition may be carried without the required packaging, labeling, marking, or certification if they are in tight containers.

[Amdt. 176–1, 41 FR 16110, Apr. 15, 1976, as amended by Amdt. 176–30, 55 FR 52695, Dec. 21, 1990]

§ 176.91 Motorboats.

A motorboat may be transported on board a ferry vessel with gasoline in the tank and two other containers not exceeding 23 L (six gallons) capacity each if they are in the motorboat, closed, and in good condition.

[Amdt. 176–1, 41 FR 16110, Apr. 15, 1976, as amended by Amdt. 176–30, 55 FR 52695, Dec. 21, 1990]

§ 176.92 Cylinders laden in vehicles.

Any cylinder of Class 2 (compressed gas) material which is required to have a valve protection cap fitted in place may be transported on board a ferry vessel without having the valve protection cap in place when it is laden in a transport vehicle and is not removed from the vehicle while on the vessel.

[Amdt. 176–1, 41 FR 16110, Apr. 15, 1976, as amended by Amdt. 176–30, 55 FR 52695, Dec. 21, 1990]

§ 176.93 Vehicles having refrigerating or heating equipment.

(a) A transport vehicle fitted with refrigerating or heating equipment using a flammable liquid or Division 2.1 (flammable gas) material, or diesel oil as fuel, may be transported on a ferry vessel. However, the refrigerating or heating equipment may not be operated while the vehicle is on the vessel, unless the equipment complies with the following requirements:

- (1) The installation is rigidly mounted and free of any motion other than normal vibration in operation;

(2) An easily accessible shutoff control is fitted to the fuel and electrical supply of the refrigerating or heating equipment; and

(3) The fuel storage tank, the fuel lines, the carburetor and any other fuel devices are tight and show no signs of leakage.

(b) If the vehicle operator desires to operate the refrigerating or heating equipment while on the vessel and the equipment is not fitted with automatic starting and stopping devices, it must be started before the vehicle is taken on board. It may continue in operation while the vehicle is on the vessel, but if the motor stops it may not be restarted.

(c) In the case of a ferry vessel on a voyage exceeding 30 minutes' duration, stowage must be provided for transport vehicles having refrigerating or heating equipment operated by internal combustion engines which will permit ready diffusion of exhaust gases to the open air. Passenger vehicles may not be stowed in a position adjacent to vehicles operating internal combustion motors which expose the occupants of the passenger vehicles to excessive concentrations of exhaust fumes from such motors.

(d) A transport vehicle containing solid carbon dioxide as a refrigerant may be transported on a ferry vessel only if it is stowed in a well ventilated location.

[Amdt. 176-1, 41 FR 16110, Apr. 15, 1976, as amended by Amdt. 176-30, 55 FR 52695, Dec. 21, 1990; 68 FR 61942, Oct. 30, 2003]

Subpart F—Special Requirements for Barges

SOURCE: Amdt. 176-8, 44 FR 23228, Apr. 19, 1979, unless otherwise noted.

§ 176.95 Applicability.

The requirements prescribed in this subpart are applicable to the transportation of packaged hazardous materials on board barges. The requirements prescribed elsewhere in this subchapter for vessels similarly apply, except as provided in this subpart, to the transportation of packaged hazardous materials on board barges.

§ 176.96 Materials of construction.

Barges used to transport hazardous materials must be constructed of steel.

[Amdt. 176-30, 55 FR 52695, Dec. 21, 1990]

§ 176.97 Prohibition of dump scows.

Dump scows are barges having cargo carrying compartments of the hopper type and fitted with a bottom dump or a side dump. This type of barge is prohibited from the carriage of any class of hazardous material.

§ 176.98 Stowage of hazardous materials on board barges.

A material for which "on deck" stowage only is required by column (10) of the Hazardous Materials Table (§172.101 of this subchapter) may be stowed "under deck" on unmanned barges.

[Amdt. 176-8, 44 FR 23228, Apr. 19, 1979, as amended by Amdt. 176-30, 55 FR 52695, Dec. 21, 1990]

§ 176.99 Permit requirements for certain hazardous materials.

The permits required by §§176.100 and 176.415 for loading, unloading, and handling Divisions 1.1 and 1.2 (explosives) materials, Division 1.5 materials, ammonium nitrate and certain ammonium nitrate mixtures and fertilizers must be obtained before these materials may be loaded on, unloaded from, or handled on board a barge or barge-carrying vessel. However, a barge loaded with these materials being placed on, removed from, or handled on board a barge-carrying vessel is not subject to these permit requirements.

[Amdt. 176-30, 55 FR 52695, Dec. 21, 1990, as amended at 56 FR 66282, Dec. 20, 1991; 66 FR 45384, Aug. 28, 2001]

Subpart G—Detailed Requirements for Class 1 (Explosive) Materials

SOURCE: Amdt. 176-30, 55 FR 52696, Dec. 21, 1990, unless otherwise noted.

§ 176.100 Permit for Divisions 1.1 and 1.2 (explosive) materials.

Before Divisions 1.1 and 1.2 (explosive) materials may be discharged from, loaded on, handled or restowed on board a vessel at any place in the

§ 176.102

United States, the carrier must obtain a permit from the COTP in accordance with the procedures in 33 CFR 126.19. Exceptions to this permit requirement may be authorized by the COTP.

[Amdt. 176-30, 55 FR 52696, Dec. 21, 1990, as amended by Amdt. 176-34, 58 FR 51533, Oct. 1, 1993; 66 FR 45385, Aug. 28, 2001]

§ 176.102 Supervisory detail.

(a) Except as provided in paragraph (c) of this section, the COTP may assign a USCG supervisory detail to any vessel to supervise the loading, handling or unloading of Class 1 (explosive) materials.

(b) The owner, agent, charterer, master or person in charge of the vessel, and all persons engaged in the handling, loading, unloading, and stowage of Class 1 (explosive) materials shall obey all orders that are given by the officer in charge of the supervisory detail.

(c) If Class 1 (explosive) materials are loaded onto or unloaded from a vessel at a facility operated or controlled by the Department of Defense, the Commanding Officer of that facility may decline the USCG supervisory detail. Whenever the supervisory detail is declined, the Commanding Officer of the facility shall ensure compliance with the regulations in this part.

§ 176.104 Loading and unloading Class 1 (explosive) materials.

(a) Packages of Class 1 (explosive) materials may not be thrown, dropped, rolled, dragged, or slid over each other or over a deck.

(b) When Class 1 (explosive) materials are stowed in a hold below one in which any cargo is being handled, the hatch in the deck dividing the two holds must have all covers securely in place.

(c) Drafts of Class 1 (explosive) materials must be handled in accordance with the following:

(1) A draft may not be raised, lowered, or stopped by sudden application of power or brake.

(2) A draft may not be released by tripping or freeing one side of the cargo-handling equipment and tumbling the Class 1 (explosive) materials off.

(3) All drafts, beams, shackles, bridle, slings, and hoods must be manu-

49 CFR Ch. I (10-1-14 Edition)

ally freed before the winch takes control.

(4) Slings may not be dragged from under a draft by winching except for the topmost layer in the hold when power removal is the only practical method and when the cargo cannot be toppled.

(5) Handles or brackets on packages in a draft may not be used for slinging purposes.

(d) A combination woven rope and wire sling or a sling that is formed by use of an open hook may not be used in handling Class 1 (explosive) materials.

(e) Only a safety hook or a hook that has been closed by wire may be used in handling drafts of Class 1 (explosive) materials.

(f) Wire rope or wire rope assemblies, including splices and fittings, used in handling Class 1 (explosive) materials must be unpainted and kept bare to permit inspection of their safe working condition. A mechanical end fitting (pressed fitting) may be used in place of an eye splice, if the efficiency of the mechanical end fitting is at least equal to the efficiency of an eye splice prepared as prescribed in 29 CFR 1918.51(c)(1).

(g) Packages of Division 1.1 and 1.2 materials that are not part of a palletized unit must be loaded and unloaded from a vessel using a chute, conveyor or a mechanical hoist and a pallet, skipboard, tray or pie plate fitted with a cargo net or sideboards.

(h) Packages of Division 1.1 and 1.2 (explosive) materials must be loaded or unloaded in accordance with the following:

(1) A cargo net with a pallet, skipboard, tray, or pie plate, must be loaded so that no more than a minimum displacement of packages occurs when it is lifted.

(2) A cargo net must completely encompass the bottom and sides of the draft. The mesh of the cargo net must be of a size and strength that will prevent a package in the draft from passing through the net.

(3) When a tray is used in handling packages, no package may extend more than one-third its vertical dimension above the sideboard of the tray.

(i) A landing mat must be used when a draft of nonpalletized Division 1.1 or

1.2 (explosive) materials is deposited on deck. The landing mat must have dimensions of at least 1 m (3 feet) wide, 2 m (7 feet) long, and 10 cm (3.9 inches) thick, and be made of woven hemp, sisal, or similar fiber, or foam rubber, polyurethane or similar resilient material.

(j) In addition to the other requirements of this section, packages of Division 1.1 and 1.2 (explosive) materials must be handled in accordance with the following:

(1) Packages may not be loaded or unloaded through a hatch at the same time that other cargo is being handled in any hold served by that hatch.

(2) Packages may not be loaded or unloaded from the same hatch by using two pieces of cargo equipment unless the equipment is positioned at the forward and aft ends of the hatch.

(3) Packages may not be lifted over any hazardous materials.

(4) The height of any structure, equipment, or load on a deck over which packages must be lifted may not be higher than the hatch coaming or bulwark, or 1 m (3 feet), whichever is greater.

(k) Unpackaged explosive devices may not be handled by their lifting lugs or suspension lugs.

(l) A chute may not be used when loading or unloading Class 1 (explosive) materials in compatibility group A or B.

[Amdt. 176-30, 55 FR 52696, Dec. 21, 1990, as amended by Amdt. 176-40, 61 FR 27175, May 30, 1996; 65 FR 58630, Sept. 29, 2000; 66 FR 45384, 45385, Aug. 28, 2001]

§ 176.108 Supervision of Class 1 (explosive) materials during loading, unloading, handling and stowage.

(a) During the loading, unloading, handling and stowage of Class 1 (explosive) materials, a responsible person shall be in constant attendance during the entire operation to direct the loading, unloading, handling and stowage of Class 1 (explosive) materials, including the preparation of the holds. The responsible person must be aware of the hazards involved and the steps to be taken in an emergency, and must maintain sufficient contact with the master to ensure proper steps are taken in an emergency.

(b) Each person involved in the handling of Class 1 (explosive) materials on a vessel shall obey the orders of the responsible person.

(c) The responsible person must inspect all cargo-handling equipment to determine that it is in safe operating condition before it is used to handle Class 1 (explosive) materials.

STOWAGE

§ 176.112 Applicability.

The provisions of §§ 176.116(e), 176.118, and 176.120 of this subpart do not apply to Division 1.4 (explosive) materials, compatibility group S. Such materials may be stowed together with all other Class 1 (explosive) materials except those of compatibility group A or L. They must be segregated from other hazardous materials in accordance with table 176.83(b) of this part.

[Amdt. 176-30, 55 FR 52696, Dec. 21, 1990, as amended at 66 FR 45384, Aug. 28, 2001]

§ 176.116 General stowage conditions for Class 1 (explosive) materials.

(a) *Stowage Location:* (1) Class 1 (explosive) materials must be stowed in a cool part of the ship and must be kept as cool as practicable while on board. Class 1 (explosives) must be stowed as far away as practicable from any potential source of heat or ignition.

(2) With the exception of division 1.4 (explosive) materials, Class 1 (explosive) materials may not be positioned closer to the ship's side than a distance equal to one eighth of the beam or 2.4 m (8 feet), whichever is less.

(3) Except where the consignment of Class 1 (explosive) materials consists only of explosive articles, the wearing of shoes or boots with unprotected metal nails, heels, or tips of any kind is prohibited.

(b) *Wetness:* (1) Spaces where Class 1 (explosive) materials are stowed below deck must be dry. In the event of the contents of packages being affected by water when on board immediate advice must be sought from the shippers; pending this advice handling of the packages must be avoided.

(2) Bilges and bilge sections must be examined and any residue of previous cargo removed before Class 1 materials (explosive) are loaded onto the vessel.

(c) *Security*: All compartments, magazines, and cargo transport units containing Class 1 (explosive) materials must be locked or suitably secured in order to prevent unauthorized access.

(d) *Secure stowage*: Class 1 (explosive) materials must be securely stowed to prevent shifting in transit; where necessary, precautions must be taken to prevent cargo sliding down between the frames at the ship's sides.

(e) *Separation from accommodation spaces and machinery spaces*: (1) Class 1 (explosive) materials must be stowed as far away as practicable from any accommodation spaces or any machinery space and may not be stowed directly above or below such a space. The requirements in paragraphs (e)(2) through (e)(4) of this section are minimum requirements in addition to the applicable requirements of 46 CFR chapter I. Where the requirements of this subpart are less stringent than those of 46 CFR chapter I, the 46 CFR chapter I requirements must be satisfied for ships to which they are applicable.

(2) There must be a permanent A Class steel bulkhead between any accommodation space and any compartment containing Class 1 (explosive) materials. Division 1.1, 1.2, 1.3, or 1.5 materials may not be stowed within 3 m (10 feet) of this bulkhead; in the decks immediately above or below an accommodation space they must be stowed at least 3 m (10 feet) from the line of this bulkhead projected vertically.

(3) There must be a permanent A Class steel bulkhead between a compartment containing Class 1 (explosive) materials and any machinery space. Class 1 (explosive) materials, except those in Division 1.4 (explosive), may not be stowed within 3 m (10 feet) of this bulkhead; and in the decks above or below the machinery space they must be stowed at least 3 m (10 feet) from the line of this bulkhead projected vertically. In addition to this separation, there must be insulation to Class A60 standard as defined in 46 CFR 72.05–10(a)(1) if the machinery space is one of Category 'A' unless the only Class 1 (explosive) materials carried are in Division 1.4S (explosive).

(4) Where Class 1 (explosive) materials are stowed away from bulkheads bounding any accommodation space or machinery space, the intervening space may be filled with cargo that is not readily combustible.

(f) [Reserved]

[Amdt. 176–30, 55 FR 52696, Dec. 21, 1990, as amended at 66 FR 45384, 45385, Aug. 28, 2001; 69 FR 76183, Dec. 20, 2004; 68 FR 61942, Oct. 30, 2003; 78 FR 1095, Jan. 7, 2013]

§ 176.118 Electrical requirement.

(a) Electrical equipment and cables installed in compartments in which Class 1 (explosive) materials are stowed which do not need to be energized during the voyage must be isolated from the supply so that no part of the circuit within the compartment is energized. The method of isolation may be by withdrawal of fuses, opening of switches or circuit breakers, or disconnection from bus bars. The means, or access to the means, of disconnection/reconnection must be secured by a locked padlock under the control of a responsible person.

(b) Electrical equipment and cables in a cargo space in which Class 1 (explosive) materials are stowed which are energized during the voyage for the safe operation of the ship must meet the requirements of subchapter J of 46 CFR chapter I. Before Class 1 (explosive) materials are loaded aboard a vessel, all cables must be tested by a skilled person to ensure that they are safe and to determine satisfactory grounding, insulation resistance, and continuity of the cable cores, metal sheathing or armoring.

(c) All Class 1 (explosive) materials must be stowed in a safe position relative to electrical equipment and cables. Additional physical protection must be provided where necessary to minimize possible damage to the electrical equipment or cables, especially during loading and unloading.

(d) Cable joints in the compartments must be enclosed in metal-clad junction boxes.

(e) All lighting equipment and cables must be of the fixed type, and must meet the relevant inspection, test, and

installation standards of 46 CFR chapter I, subchapter J.

[Amdt. 176-30, 55 FR 52696, Dec. 21, 1990, as amended by Amdt. 176-34, 58 FR 51533, Oct. 1, 1993]

§ 176.120 Lightning protection.

A lightning conductor grounded to the sea must be provided on any mast or similar structure on a vessel on which Class 1 (explosive) materials are stowed unless effective electrical bonding is provided between the sea and the mast or structure from its extremity and throughout to the main body of the hull structure. (Steel masts in ships of all welded construction comply with this requirement).

§§ 176.122–176.124 [Reserved]

§§ 176.128–176.136 [Reserved]

§ 176.137 Portable magazine.

(a) Each portable magazine used for the stowage of Class 1 (explosive) materials on board vessels must meet the following requirements:

(1) It must be weather-tight, constructed of wood or metal lined with wood at least 2 cm (0.787 inch) thick, and with a capacity of no more than 3.1 cubic m (110 cubic feet).

(2) All inner surfaces must be smooth and free of any protruding nails, screws or other projections.

(3) If constructed of wood, a portable magazine must be framed of nominal 5 cm × 10 cm (2×4 inch) lumber, and sheathed with nominal 20 mm (0.787 inch) thick boards or plywood.

(4) When constructed of metal, the metal must be not less than 3.2 mm (0.126 inch) thick.

(5) Runners, bearers, or skids must be provided to elevate the magazine at least 10 cm (3.9 inches) from the deck. Padeyes, ring bolts, or other suitable means must be provided for securing.

(6) If the portable magazine has a door or hinged cover, the door or cover must have a strong hasp and padlock or equally effective means of securing.

(7) The portable magazine must be marked on its top and four sides, in letters at least 8 cm (3 inches) high, as follows:

EXPLOSIVES—HANDLE CAREFULLY—
KEEP LIGHTS AND FIRE AWAY.

(b) A portable magazine which meets the requirements for a type 2 or type 3 magazine under 27 CFR part 555 subpart K may be used for the stowage of Class 1 (explosive) materials on board vessels.

(c) A portable magazine with a capacity exceeding 3.1 m³ (110 cubic feet) may be used for the stowage of Class 1 (explosive) materials under such construction, handling, and stowage requirements as the COTP approves.

[Amdt. 176-30, 55 FR 52696, Dec. 21, 1990, as amended at 66 FR 45185, Aug. 28, 2001; 6 FR 56317, Sept. 13, 2011]

§ 176.138 Deck stowage.

(a) [Reserved]

(b) Class 1 (explosives) may not be stowed within a horizontal distance of 6 m (20 feet) from any source of heat and any possible sources of ignition. With the exception of division 1.4 (explosive) materials, Class 1 (explosives) materials may not be stowed within a horizontal distance of 12 m (39 feet) from the bridge, accommodation areas, and lifesaving appliances.

[Amdt. 176-30, 55 FR 52696, Dec. 21, 1990, as amended at 69 FR 76184, Dec. 20, 2004; 78 FR 1095, Jan. 7, 2013]

SEGREGATION

§ 176.140 Segregation from other classes of hazardous materials.

(a) Class 1 (explosive) materials must be segregated from other packaged hazardous materials in accordance with §176.83.

(b) Class 1 (explosive) materials must be segregated from bulk solid dangerous cargoes in accordance with the IMDG Code (IBR, see §171.7 of this subchapter). Notwithstanding §176.83(b), ammonium nitrate and sodium nitrate may be stowed together with blasting explosives, except those containing chlorates, provided the mixed stowage is treated as blasting explosives (see §176.410(e)).

[Amdt. 176-30, 55 FR 52696, Dec. 21, 1990, as amended at 68 FR 45041, July 31, 2003; 68 FR 75748, Dec. 31, 2003]

§ 176.142

49 CFR Ch. I (10–1–14 Edition)

§ 176.142 Reserved]

§ 176.144 Segregation of Class 1 (explosive) materials.

(a) Except as provided in §176.145 of this subchapter, stowage of Class 1 (ex-

plosive) materials within the same compartment, magazine, or cargo transport unit is subject to provisions contained in table 176.144(a).

TABLE 176.144(a)—AUTHORIZED MIXED STOWAGE FOR EXPLOSIVES

[An “X” indicates that explosives in the two different compatibility groups reflected by the location of the “X” may not be stowed in the same compartment, magazine, or cargo transport unit]

Compatibility groups	A	B	C	D	E	F	G	H	J	K	L	N	S
A		X	X	X	X	X	X	X	X	X	X	X	X
B	X		X	X	X	X	X	X	X	X	X	X	X
C	X	X		6	6	X	1	X	X	X	X	X	4
D	X	X	6		6	X	1	X	X	X	X	X	4
E	X	X	6	6		X	1	X	X	X	X	X	4
F	X	X	X	X	X		X	X	X	X	X	X	X
G	X	X	1	1	1	X		X	X	X	X	X	X
H	X	X	X	X	X	X	X		X	X	X	X	X
J	X	X	X	X	X	X	X	X		X	X	X	X
K	X	X	X	X	X	X	X	X	X		X	X	X
L	X	X	X	X	X	X	X	X	X	X	2	X	X
N	X	X	4	4	4	X	X	X	X	X	X	3	5
S	X										X	5	

- NOTES: 1. Explosive articles in compatibility group G, other than fireworks, may be stowed with articles of compatibility groups C, D, and E, provided no explosive substances are carried in the same compartment, magazine or cargo transport unit.
- 2. Explosives in compatibility group L may only be stowed in the same compartment, magazine or cargo transport unit with identical explosives within compatibility group L.
- 3. Different types of articles of Division 1.6, compatibility group N, may only be transported together when it is proven that there is no additional risk of sympathetic detonation between the articles. Otherwise they must be treated as division 1.1.
- 4. When articles of compatibility group N are transported with articles or substances of compatibility groups C, D or E, the goods of compatibility group N must be treated as compatibility group D.
- 5. When articles of compatibility group N are transported together with articles or substances of compatibility group S, the entire load must be treated as compatibility group N.
- 6. Any combination of articles in compatibility groups C, D and E must be treated as compatibility group E. Any combination of substances in compatibility groups C and D must be treated as the most appropriate compatibility group shown in Table 2 of § 173.52 taking into account the predominant characteristics of the combined load. This overall classification code must be displayed on any label or placard on a unit load or cargo transport unit as prescribed in subpart E (Labeling) and subpart F (Placarding).

(b) Where Class 1 (explosive) materials of different compatibility groups are allowed to be stowed in the same compartment, magazine, or cargo transport unit, the stowage arrangements must conform to the most stringent requirements for the entire load.

(c) Where a mixed load of Class 1 (explosive) materials of different hazard divisions and/or stowage arrangements is carried within a compartment, magazine, or cargo transport unit, the entire load must be treated as belonging to the hazard division having the greatest hazard. (For example, if a load of Division 1.1 (explosive) materials is mixed with Division 1.3 (explosive) materials, the load is treated as a Division 1.1 (explosive) material as defined in §173.50(b) of this subchapter and the stowage must conform to the most stringent requirements for the entire load).

(d) If some of the Class 1 (explosive) materials in a stowage mixture require

non-metallic lining of the closed cargo transport unit, Class 1 (explosive) materials requiring ordinary stowage may be stowed in the same closed cargo transport. When a closed cargo transport unit is used for such substances that require non-metallic lining of the closed cargo transport unit, the other Class 1 (explosive) materials stowed therein must have no exposed parts of any ferrous metal or aluminum alloy, unless separated by a partition.

(e) Segregation on deck: When Class 1 (explosive) materials in different compatibility groups are carried on deck, they must be stored not less than 6 m (20 feet) apart unless they are allowed under Table 176.144(a) to be stowed in the same compartment, magazine, or cargo transport unit.

(f) On a barge used to transfer class 1 (explosive) materials from a waterfront facility to a vessel at an explosives anchorage (or from the vessel to the water front facility), if compliance

with paragraph (e) of this section is not practicable, a sandbag barrier at least 0.6 m (2 feet) in thickness may be substituted for the 6 m (20 feet) separation.

[Amdt. 176-30, 55 FR 52696, Dec. 21, 1990, as amended at 66 FR 45384, 45385, Aug. 28, 2001; 69 FR 76184, Dec. 20, 2004; 70 FR 56099, Sept. 23, 2005; 78 FR 1095, Jan. 7, 2013]

§ 176.145 Segregation in single hold vessels.

(a) On board a vessel having a single cargo hold, Class 1 (explosive) materials in hazard division/compatibility group 1.1B and 1.2B may be stowed in the same compartment with substances of compatibility group D, provided:

(1) The net explosive weight of the compatibility group B explosive does not exceed 50 kg (110 pounds); and

(2) The compatibility group B explosive materials are stowed in a steel portable magazine that is stowed at least 6 m (20 feet) from the compatibility group D substances.

(b) Division/compatibility group 1.4B (explosive) materials may be stowed in the same compartment with substances of compatibility group D provided the Class 1 (explosive) materials of different compatibility groups are separated by either a distance of at least 6 m (20 feet) or by a steel partition.

[Amdt. 176-30, 55 FR 52696, Dec. 21, 1990, as amended at 66 FR 45384, Aug. 28, 2001]

§ 176.146 Segregation from non-hazardous materials.

(a) Except as required by paragraph (b) of this section, Class 1 (explosive) materials need not be segregated from other cargo of a non-dangerous nature.

(b) Readily combustible materials may not be stowed in the same compartment or hold as Class 1 (explosive) materials other than those in compatibility group S.

(c) [Reserved]

(d) In order to avoid contamination:

(1) An explosive substance or article which has a secondary POISON hazard label must be stowed "separated from" all foodstuffs, except when such materials are stowed in separate closed cargo transport units, the requirements for "away from" segregation apply.

(2) An explosive substance or article which has a secondary CORROSIVE hazard label must be stowed "away from" foodstuffs.

[Amdt. 176-30, 55 FR 52696, Dec. 21, 1990, as amended at 56 FR 66282, Dec. 20, 1991; 69 FR 76185, Dec. 20, 2004; 78 FR 1095, Jan. 7, 2013]

PRECAUTIONS DURING LOADING AND UNLOADING

§ 176.148 Artificial lighting.

Electric lights, except arc lights, are the only form of artificial lighting permitted when loading and unloading Class 1 (explosive) materials.

§ 176.150 Radio and radar.

(a) Except as provided in paragraph (b) of this section, when Class 1 (explosive) materials (other than explosive articles in Division 1.4 [explosive] or any explosive substance) are loaded, unloaded, or handled, the responsible person must ensure that all sources of electromagnetic radiation such as radio and radar transmitters are deenergized by opening the main switches controlling the sources and tagging them to warn that the devices are not to be energized until loading or unloading has ceased.

(b) During the loading or unloading of all explosive articles (except those in Division 1.4 [explosive]), no radio or radar transmitter may be used within 50 m (164 feet) of such articles except for VHF transmitters the power output of which does not exceed 25 watts and of which no part of the antenna system is within 2 m (7 feet) of the Class 1 (explosive) materials.

(c) Explosive articles which are sensitive to electromagnetic radiation from external sources must be stowed at a safe distance from the vessel's radio cabin, receiving and transmitting apparatus radio antenna or lead-in, and radar installation, with due regard to the character of the vessel and the degree of screening-off of the explosive articles.

[Amdt. 176-30, 55 FR 52696, Dec. 21, 1990, as amended at 66 FR 45384, Aug. 28, 2001]

§ 176.154 Fueling (bunkering).

(a) Class 1 (explosive) materials, except those in compatibility group S, may not be loaded or unloaded when

§ 176.156

fueling (bunkering) is in progress except with the prior authorization of the COTP, and under conditions prescribed by that officer.

(b) Vessels containing Class 1 (explosive) materials may not be fueled (bunkered) with the hatches open unless authorized by the COTP.

§ 176.156 Defective packages.

(a) No leaking, broken, or otherwise defective package containing Class 1 (explosive) materials, including packages which have been adversely affected by moisture, may be accepted for shipment. The master or person in charge of a vessel on which there is a defective package containing Class 1 (explosive) materials must seek advice from the shipper concerning withdrawal, repair, or replacement. No repair of damaged or defective package containing Class 1 (explosive) materials may be performed on board a vessel.

(b) No Class 1 (explosive) material, which for any reason has deteriorated or undergone a change of condition that increases the hazard attendant upon its conveyance or handling, may be moved in the port area, except as directed by the COTP.

(c) If any package of Class 1 (explosive) materials, or seal of a package of Class 1 (explosive) materials, appears to be damaged, that package must be set aside for examination and repair or otherwise legally disposed of as directed by the shipper.

(d) If any Class 1 (explosive) materials are spilled or released from a package, the responsible person must ensure that an appropriate emergency response is undertaken in accordance with the emergency response information required under §172.602 of this subchapter. The master of the vessel must report each incident involving spillage or release of Class 1 (explosive) materials to the COTP as soon as practicable.

[Amdt. 176-30, 55 FR 52696, Dec. 21, 1990, as amended at 56 FR 66282, Dec. 20, 1991]

§ 176.160 Protection against weather.

Any person loading or unloading packages containing Class 1 (explosive) materials shall take adequate meas-

49 CFR Ch. I (10-1-14 Edition)

ures to prevent these packages from becoming wet.

§ 176.162 Security.

A responsible person must be present at all times when the hatches of spaces containing Class 1 (explosive) materials are open. No unauthorized person may be permitted to access spaces in which Class 1 (explosive) materials are stowed. Magazines must be secured against unauthorized entry when loading has been completed, or when loading or unloading is stopped. Packages containing Class 1 (explosive) materials may not be opened on board ship.

§ 176.164 Fire precautions and fire-fighting.

(a) Matches, lighters, fire, and other ignition sources are prohibited on and near any vessel on which Class 1 (explosive) materials are being loaded, unloaded, or handled except in places designated by the master or the COTP.

(b) A fire hose of sufficient length to reach every part of the loading area with an effective stream of water must be laid and connected to the water main, ready for immediate use.

(c) No repair work may be carried out in a cargo space containing Class 1 (explosive) materials other than those of Division 1.4 (explosive). No welding, burning, cutting, or riveting operations involving the use of fire, flame, spark, or arc-producing equipment may be conducted on board except in an emergency; and, if in port, with the consent of the COTP.

(d) Each compartment, including a closed vehicle deck space, which contains Class 1 (explosive) materials must be provided with a fixed fire extinguishing system. Each adjacent cargo compartment either must be protected by a fixed fire extinguishing installation or must be accessible for firefighting operations.

(e) A vessel must have two sets of breathing apparatus and a power-operated fire pump, which, together with its source of power and sea connections, must be located outside the machinery space.

[Amdt. 176-30, 55 FR 52696, Dec. 21, 1990, as amended at 66 FR 45384, Aug. 28, 2001]

PASSENGER VESSELS

§ 176.166 Transport of Class 1 (explosive) materials on passenger vessels.

(a) Only the following Class 1 (explosive) materials may be transported as cargo on passenger vessels:

(1) Division 1.4 (explosive) materials, compatibility group S.

(2) Explosive articles designed for lifesaving purposes as identified in § 176.142(b)(2), if the total net explosive mass (weight) does not exceed 50 kg (110 pounds).

(3) Class 1 (explosive) materials in compatibility groups C, D, and E, if the

total net explosive mass (weight) does not exceed 10 kg (22 pounds) per vessel.

(4) Articles in compatibility group G other than those requiring special stowage, if the total net explosive mass (weight) does not exceed 10 kg (22 pounds) per vessel.

(5) Articles in compatibility group B, if the total net explosive mass (weight) does not exceed 5 kg (11 pounds).

(b) Class 1 (explosive) materials which may be carried on passenger vessels are identified in column (10) of the § 172.101 table. They must be stowed in accordance with table 176.166(b).

TABLE 176.166(b)—STOWAGE ARRANGEMENTS IN PASSENGER VESSELS

Class/Division	Samples, explosive	Goods, N.O.S. Class 1	Goods shipped under a specific proper shipping name													
			Compatibility group													
			A	B	C	D	E	F	G	H	J	K	L	N	S	
1.1	d	d	c..	e	e	e	e	e	c..	e	—	c..	—	c..	—	—
1.2	d	d	—	e	e	e	e	c..	e	c..	c..	c..	c..	—	—	—
1.3	d	d	—	—	e	e	—	c..	e	c..	c..	c..	—	—	—	—
1.4	d	d	—	b	b	b	b	c..	b	—	—	—	—	—	—	a
1.5	d	d	—	—	e	—	—	—	—	—	—	—	—	—	—	—
1.6	d	d	—	—	—	—	—	—	—	—	—	—	—	—	e	—

a—As for cargo ships, on deck or under deck.
 b—As for cargo ships, on deck or under deck, in portable magazines only.
 c—Prohibited.
 d—As specified by the Associate Administrator, or the competent authority of the country in which the Class 1 (explosive) materials are loaded on the vessel.
 e—In containers or the like, on deck only.

(c) Notwithstanding the provisions of paragraph (a) of this section, a combination of the substances and articles listed in paragraphs (a)(1) through (a)(5) of this section may be transported on the same passenger vessel provided the total net explosive mass (weight) of the combination of Class 1 (explosive) materials carried does not exceed the smallest quantity specified for any one of the substances or articles in the combination.

[Amdt. 176-30, 55 FR 52696, Dec. 21, 1990, as amended at 65 FR 58630, Sept. 29, 2000; 66 FR 45384, 45385, Aug. 28, 2001].

CARGO TRANSPORT UNITS AND SHIPBORNE BARGES

§ 176.168 Transport of Class 1 (explosive) materials in vehicle spaces.

(a) All transport vehicles and cargo must be properly secured.

(b) All transport vehicles used for the carriage of Class 1 (explosive) materials must be structurally serviceable as defined in § 176.172(a)(2).

(c) Vehicles used to transport Class 1 (explosive) materials must conform to the requirements in §§ 177.834 and 177.835 of this subchapter.

(d) Class 1 (explosive) materials which require special stowage must be transported in transport vehicles approved for the purpose by the Associate Administrator except that Class 1 (explosive) materials in compatibility group G or H may be carried in steel portable magazines or freight containers. Closed transport vehicles may be used as magazines; transport vehicles of other types may be used to transport Class 1 (explosive) materials which require ordinary stowage.

(e) Class 1 (explosive) materials of different compatibility groups may not

§ 176.170

be stowed in the same vehicle except as allowed in §176.144 of this subpart.

(f) Vehicles containing different Class 1 (explosive) materials require no segregation from each other, except that these materials may be carried together under the provisions of §176.144 of this subchapter. In all other instances, the vehicles must be “separated from” one another.

(g) All transport vehicles used for the transport of Class 1 (explosive) materials must have lashing arrangements for securing the vehicle on the ship and preventing the moving of the vehicle on its springs during the sea passage.

(h) Where a portable magazine or closed freight container is carried on a chassis, twist locks or other suitable securing arrangements must be provided and made secure.

[Amdt. 176-30, 55 FR 52696, Dec. 21, 1990, as amended at 66 FR 45384, Aug. 28, 2001; 68 FR 61942, Oct. 30, 2003]

§ 176.170 Transport of Class 1 (explosive) materials in freight containers.

(a) When Class 1 (explosive) materials are stowed in a freight container, the freight container, for the purposes of this subpart, may be regarded as a closed transport unit for class 1 or a magazine but not a separate compartment.

(b) Freight containers loaded with Class 1 (explosive) materials, except for explosives in Division 1.4, must not be stowed in the outermost row of containers.

(c) [Reserved]

(d) Class 1 (explosive) materials of different compatibility groups may not be stowed within the same freight container except as allowed in §176.144 of this subpart.

(e) On vessels, other than specially fitted container ships, freight containers containing Class 1 (explosive) materials must be stowed only in the lowest tier.

(f) Freight containers carrying different Class 1 (explosive) materials require no segregation from each other, if the provisions of §176.144 of this subpart allow the Class 1 (explosive) materials to be carried together in the same compartment. In all other instances, the containers must be “separated

49 CFR Ch. I (10-1-14 Edition)

from” one another in accordance with §176.83(f) of this part.

(g) Freight containers carrying Class 1 (explosive) materials may not be handled on board a vessel with fork lift trucks unless approved by the COTP. This does not preclude the use of front-loading trucks using side-frame lifting equipment.

[Amdt. 176-30, 55 FR 52696, Dec. 21, 1990, as amended at 56 FR 66282, Dec. 20, 1991; 68 FR 45041, July 31, 2003; 69 FR 76185, Dec. 20, 2004; 78 FR 1095, Jan. 7, 2013]

§ 176.172 Structural serviceability of freight containers and vehicles carrying Class 1 (explosive) materials on ships.

(a) Except for Division 1.4 materials, a freight container may not be offered for the carriage of Class 1 (explosive) materials, unless the container is structurally serviceable as evidenced by a current CSC (International Convention for Safe Containers) approval plate and verified by a detailed visual examination as follows:

(1) Before a freight container or transport vehicle is packed with Class 1 (explosive) materials, it must be visually examined by the shipper to ensure it is structurally serviceable, free of any residue of previous cargo, and its interior walls and floors are free from protrusions.

(2) *Structurally serviceable* means the freight container or the vehicle cannot have major defects in its structural components, such as top and bottom side rails, top and bottom end rails, door sill and header, floor cross members, corner posts, and corner fittings in a freight container. Major defects include—

(i) Dents or bends in the structural members greater than 19 mm (0.75 inch) in depth, regardless of length;

(ii) Cracks or breaks in structural members;

(iii) More than one splice or an improper splice (such as a lapped splice) in top or bottom end rails or door headers;

(iv) More than two splices in any one top or bottom side rail;

(v) Any splice in a door sill or corner post;

(vi) Door hinges and hardware that are seized, twisted, broken, missing, or otherwise inoperative;

(vii) Gaskets and seals that do not seal; or

(viii) For freight containers, any distortion of the overall configuration great enough to prevent proper alignment of handling equipment, mounting and securing chassis or vehicle, or insertion into ships' cells.

(3) In addition, deterioration of any component of the freight container or vehicle, regardless of the material of construction, such as rusted-out metal in sidewalls or disintegrated fiberglass, is prohibited. Normal wear, however, including oxidation (rust), slight dents and scratches, and other damage that does not affect serviceability or the weather-tight integrity of the units, is not prohibited.

(b) As used in paragraph (a) of this section, *splice* means any repair of a freight container main structural member which replaces material, except complete replacement of the member.

(c) All shipments of Class 1 (explosive) materials except those in Division 1.4 (explosive) must be accompanied by a statement, which may appear on the shipping paper, certifying that the freight container or the vehicle is structurally serviceable as defined in paragraph (a)(2) of this section.

[Amdt. 176-30, 55 FR 52696, Dec. 21, 1990, as amended at 66 FR 45384, Aug. 28, 2001; 74 FR 2268, Jan. 14, 2009]

§ 176.174 Transport of Class 1 (explosive) materials in shipborne barges.

(a) Fixed magazines may be built within a shipboard barge. Freight containers may be used as magazines within a barge.

(b) Shipborne barges may be used for the carriage of all types of Class 1 (explosive) materials. When carrying Class 1 (explosive) materials requiring special stowage, the following requirements apply:

(1) Class 1 (explosive) materials in compatibility group G or H must be stowed in freight containers.

(2) Class 1 (explosive) materials in compatibility group K or L must be stowed in steel magazines.

(c) Class 1 (explosive) materials of different compatibility groups may not be stowed within the same shipborne barge unless under §176.144(b) of this subpart they are authorized to be stowed in the same compartment.

[Amdt. 176-30, 55 FR 52696, Dec. 21, 1990, as amended at 69 FR 76185, Dec. 20, 2004]

HANDLING CLASS 1 (EXPLOSIVE) MATERIALS IN PORT

§ 176.176 Signals.

When Class 1 (explosive) materials are being loaded, handled, or unloaded on a vessel, the vessel must exhibit the following signals:

(a) By day, flag "B" (Bravo) of the international code of signals; and

(b) By night, an all-round fixed red light.

§ 176.178 Mooring lines.

(a) All lines used in mooring the vessel must be of sufficient strength, type, and number for the size of the vessel and local conditions.

(b) While the vessel is moored or anchored in a port area, towing wires of adequate size and length must be properly secured to mooring bits at the bow and stern ready for immediate use with the towing eyes passed outboard and kept at about water level.

(c) The mooring arrangements must be such that the vessel can be released quickly in an emergency.

§ 176.180 Watchkeeping.

Whenever Class 1 (explosive) materials are on board a vessel in port, there must be sufficient crew on board to maintain a proper watch and to operate the propulsion and firefighting equipment in case of an emergency.

§ 176.182 Conditions for handling on board ship.

(a) *Weather conditions.* Class 1 (explosive) materials may not be handled in weather conditions which may seriously increase the hazards presented by the Class 1 (explosive) materials. During electrical storms, cargo operations must be halted and all hatches containing Class 1 (explosive) materials must be closed.

(b) *Darkness.* Class 1 (explosive) materials may not be handled on board a

§ 176.184

vessel during the hours of darkness unless prior consent has been obtained from the COTP.

(c) *Lighting.* The area where Class 1 (explosive) materials are handled, or where preparations are being made to handle Class 1 (explosive) materials, must be illuminated with lighting that is sufficient to safely perform the handling operation.

(d) *Protective equipment.* (1) A sufficient quantity of appropriate protective equipment must be provided for the personnel involved in handling Class 1 (explosive) materials.

(2) The protective equipment must provide adequate protection against the hazards specific to the Class 1 (explosive) materials handled.

(e) *Intoxicated persons.* No person under the influence of alcohol or drugs to such an extent that the person's judgment or behavior is impaired may participate in any operation involving the handling of Class 1 (explosive) materials. The master of the vessel must keep any such person clear of any areas where Class 1 (explosive) materials are being handled.

(f) *Smoking.* (1) Smoking is prohibited on the vessel while Class 1 (explosive) materials are being handled or stowed except in places designated by the master of the vessel.

(2) Conspicuous notices prohibiting smoking must be posted and clearly visible at all locations where Class 1 (explosive) materials are handled or stored.

(g) All hatches and cargo ports opening into a compartment in which Class 1 (explosive) materials are stowed must be kept closed except during loading and unloading of the compartment. After loading, hatches must be securely closed.

§ 176.184 Class 1 (explosive) materials of Compatibility Group L.

Class 1 (explosive) materials in compatibility group L may not be handled in a port area without the special permission of, and subject to any special precautions required by, the COTP.

§ 176.190 Departure of vessel.

When loading of Class 1 (explosive) materials is completed, the vessel must

49 CFR Ch. I (10–1–14 Edition)

depart from the port area as soon as is reasonably practicable.

§ 176.192 Cargo handling equipment for freight containers carrying Class 1 (explosive) materials.

(a) Except in an emergency, only cargo handling equipment that has been specifically designed or modified for the handling of freight containers may be used to load, unload, or handle freight containers containing Division 1.1 or 1.2 (explosive) materials.

(b) The gross weight of a freight container containing Class 1 (explosive) materials may not exceed the safe working load of the cargo handling equipment by which it is handled.

[Amdt. 176-30, 55 FR 52696, Dec. 21, 1990, as amended at 66 FR 45384, Aug. 28, 2001]

MAGAZINE VESSELS

§ 176.194 Stowage of Class 1 (explosive) materials on magazine vessels.

(a) *General.* The requirements of this section are applicable to magazine vessels and are in addition to any other requirements in this subchapter.

(b) *Type vessel authorized.* A single deck vessel with or without a house on deck is the only type vessel that may be used as a magazine vessel. A magazine vessel may not be moved while Class 1 (explosive) materials are on board.

(c) *Location of explosives.* Division 1.1, 1.2, or 1.3 (explosive) materials, in excess of 2268 kg (5000 pounds), stored in any magazine vessel must be stowed below deck. No Class 1 (explosive) materials may be stowed on deck unless the vessel is fitted with a deck house having a stowage area which meets the requirements in this subpart for the stowage of Class 1 (explosive) materials. Detonators, detonator assemblies and boosters with detonators, Division 1.1 (explosive) may not be stored on the same magazine vessel with other Division 1.1, 1.2, and 1.3 (explosive) materials.

(d) *Class 1 (explosive) materials storage spaces.* Any compartment on a magazine vessel used for the stowage of Class 1 (explosive) materials must be completely sealed with wood so as to provide a smooth interior surface. Each metal stanchion in the compartment

must be boxed in the same manner. An overhead ceiling is not required when the overdeck is weather tight. All nail and bolt heads must be countersunk and any exposed metal must be covered with wood.

(e) *Initiating explosives, detonators and boosters with detonators.* No explosive substance in Division 1.1, compatibility group A may be stowed in the same compartment with any other Class 1 (explosive) materials when there are explosive substances in Division 1.1 or 1.2 (explosive) on the same magazine vessel. Detonators, detonator assemblies and boosters with detonators must be stowed at least 8 m (26 feet) from any bulkhead forming a boundary of a compartment containing any other Class 1 (explosive) materials.

(f) *Dry storage spaces.* A magazine vessel having a dry storage space capable of being used for any purpose whatsoever must have a cofferdam at least 61 cm (24 inches) wide fitted between the dry storage space and each adjacent compartment containing Class 1 (explosive) materials. The cofferdam must be constructed of wood or steel, formed by two tight athwartship bulkheads extending from the skin of the vessel to the overdeck. If the cofferdam extends to the weather deck, a watertight hatch must be fitted in the deck to provide access to the cofferdam.

(g) *Lighting.* Non-sparking, battery-powered, self-contained electric lanterns or non-sparking hand flashlights are the only means of artificial light authorized.

(h) *Living quarters.* Living quarters must be fitted on the inside with a non-combustible material approved by the Commandant, USCG. Bracketed ship's lamps are the only lighting fixtures authorized to be used in the living quarters. Any stove used for heating or cooking must be securely fastened and may not be mounted closer than 15 cm (5.9 inches) to the deck or sides of the house. Any smoke pipe for the stove which passes through the roof of the house must be kept at least 8 cm (3 inches) away from any woodwork. Each smoke pipe must be protected by a layer of non-combustible material approved by the Commandant, USCG, an air space of at least 2.54 cm (1 inch), and a metal collar of at least 1.5 mm

(0.059 inch) sheet secured only on the weather side of the roof. There may be no opening from any living quarters into any stowage compartment.

(i) *Storage of other hazardous materials.* Magazine vessels having Class 1 (explosive) materials on board may not be used for the storage of any other hazardous material.

(j) *Magazine vessel's stores.* Hazardous materials used as stores on board any magazine vessel must comply with the requirements of 46 CFR part 147.

(k) *Matches.* Safety matches requiring a prepared surface for ignition are the only type of matches authorized to be possessed or used on board a magazine vessel. They must be kept in a metal box or can with a metal cover and stored in the custodian's living quarters.

(l) *Firearms.* Firearms and ammunition (other than cargo) are not permitted on board a magazine vessel.

(m) *Fire extinguishing equipment.* No Class 1 (explosive) materials may be loaded or stowed in, unloaded from, or handled on any magazine vessel unless four fire extinguishers that meet the requirements for Type A Size II or Type B Size III in 46 CFR part 95, subpart 95.50 are near and accessible to the magazines.

(n) *Supervision.* A magazine vessel containing Class 1 (explosive) materials must be continuously attended by a custodian employed for that purpose by the vessel's owner.

(o) *Unauthorized persons on magazine vessels.* The custodian of a magazine vessel shall prevent unauthorized persons from coming on board unless it is necessary to abate a hazard to human life or a substantial hazard to property.

(p) *Repacking of Class 1 (explosive) materials on board.* No Class 1 (explosive) materials may be repacked on board a magazine vessel. Broken or damaged packages must be handled in accordance with the requirements of §176.156. Packages requiring an emergency response must be handled in accordance with the emergency response information required under §172.602 of this subchapter.

(q) *Work boat.* Each magazine vessel must be equipped with a work boat.

§ 176.200

(r) *Life preservers.* One approved personal flotation device must be available for each person employed on a magazine vessel.

(s) *Fenders.* Each magazine vessel must be fitted with fenders in sufficient number and size to prevent any vessel tying up alongside from coming in contact with the hull.

[Amdt. 176-30, 55 FR 52696, Dec. 21, 1990, as amended by Amdt. 176-41, 61 FR 51339, Oct. 1, 1996; 66 FR 45185, 45384, 45385, Aug. 28, 2001]

Subpart H—Detailed Requirements for Class 2 (Compressed Gas) Materials

SOURCE: Amdt. 176-30, 55 FR 52704, Dec. 21, 1990, unless otherwise noted.

§ 176.200 General stowage requirements.

(a) Each package of Class 2 (compressed gas) material being transported by vessel must be prevented from making direct contact with the vessel's deck, side, or bulwark by dunnage, shoring, or other effective means.

(b) When cylinders of Class 2 (compressed gas) materials being transported by vessel are stowed in a horizontal position, each tier must be stowed in the cantlines of the tier below it, and the valves on cylinders in adjacent tiers must be at alternate ends of the stow. Each tier may be stepped back and the ends alternated in order to clear the flange. Lashing must be provided to prevent any shifting.

(c) When cylinders of Class 2 (compressed gas) materials being transported by vessel are stowed in a vertical position they must be stowed in a block and cribbed or boxed-in with suitable sound lumber and the box or crib dunnaged to provide clearance from a steel deck at least 10 cm (3.9 inches) off any metal deck. Pressure receptacles in the box or crib must be braced to prevent any shifting of the pressure receptacles. The box or crib (gas rack) must be securely chocked and lashed to prevent movement in any direction.

(d) Any package containing Division 2.3 (poison gas) materials must be stowed separate from all foodstuffs.

49 CFR Ch. I (10-1-14 Edition)

(e) Class 2 (compressed gas) materials may not be stowed “on deck” over a hold or compartment containing coal.

(f) Class 2 (compressed gas) material must be kept as cool as practicable and be stowed away from all sources of heat and ignition. Any package containing a Division 2.1 (flammable gas) material is restricted from transport in powered refrigerated temperature controlled containers, unless the equipment is capable of preventing ignition of flammable vapors by having non-sparking or explosion-proof electric fittings within the cooling compartment.

[Amdt. 176-30, 55 FR 52704, Dec. 21, 1990, as amended at 68 FR 61942, Oct. 30, 2003; 74 FR 16143, Apr. 9, 2009; 78 FR 1095, Jan. 7, 2013]

§ 176.205 Under deck stowage requirements.

(a) When a Class 2 (compressed gas) material is stowed below deck, it must be stowed in a mechanically ventilated cargo space with no source of artificial heat and clear of living quarters. No bulkhead or deck of that hold or compartment may be a common boundary with any boiler room, engine room, coal bunker, galley or boiler room uptake.

(b) When Division 2.1 (flammable gas) materials are stowed below deck, they must be stowed in a hold or compartment which complies with paragraph (a) of this section and the following requirements:

(1) Each hold or compartment must be ventilated.

(2) Each hold or compartment must be equipped with an overhead water sprinkler system or fixed fire extinguishing system.

(3) Each electrical power line in the hold or compartment must be protected by a strong metal covering to prevent crushing by cargo being stowed against it.

(4) Except when fitted with electrical fixtures of the explosion-proof type, each electrical circuit serving the hold or compartment must be disconnected from all sources of power. No circuit may be energized until the Division 2.1 (flammable gas) cargo and any vapors have been removed from the hold or compartment. Explosion-proof portable lighting may be used if the source of power is from electrical outlets outside

the hold or compartment and above the weather deck.

(5) Any opening in a common bulkhead of an adjacent hold or compartment must be securely closed off and made gas-tight, unless the adjacent hold or compartment is also used for the stowage of Division 2.1 (flammable gas) materials.

(6) Full and efficient hatch covers must be used. Tarpaulins, if fitted, must be protected by dunnaging before overstuffing with any cargo. Each tarpaulin must be in one piece and free of rents, tears, and holes.

(7) A fire screen must be fitted at the weather end of each vent duct leading from the hold or compartment. The fire screen must completely cover the open area. It must consist of two layers of corrosion-resistant metal wire of 20×20 mesh or finer, spaced not less than 1 cm (0.4 inch) or more than 4 cm (1.6 inches) apart. The screen may be removable if means for securing it in place when in service are provided.

(8) The hold or compartment may not be fitted with any gooseneck type vent trunk head.

(9) Any electrical apparatus located in the hold or compartment must be capable of being disconnected from its power source by a positive means located outside the hold or compartment.

[Amdt. 176-30, 55 FR 52704, Dec. 21, 1990, as amended at 56 FR 66282, Dec. 20, 1991]

§ 176.210 On deck stowage requirements.

Cylinders of Class 2 (compressed gas) materials being transported by vessel must be protected from sources of heat. A tarpaulin covering the cylinders is not acceptable if it comes in contact with them.

[78 FR 1095, Jan. 7, 2013]

§ 176.220 Smoking or open flame and posting of warning signs.

(a) Smoking or the use of open flame is prohibited in any hold or compartment containing a Division 2.1 (flammable gas) material, near any Division 2.1 (flammable gas) material stowed on deck, or near any ventilator leading to a hold containing this material.

(b) A sign carrying the legend:

FLAMMABLE VAPORS

KEEP LIGHTS AND FIRE AWAY
NO SMOKING

must be conspicuously posted at each approach to an “on deck” Division 2.1 (flammable gas) material stowage area and near each cargo hold ventilator leading to a hold containing this material. The sign must be painted on a white background using red letters. The letters may not be less than 8 cm (3 inches) high.

§ 176.225 Stowage of chlorine.

Chlorine (UN 1017) must be stowed separate from copper or brass leaf sheets and from finely divided organic material.

§ 176.230 Stowage of Division 2.1 (flammable gas) materials.

Division 2.1 (flammable gas) materials transported in Specification 106A or 110A multi-unit car tanks must be stowed on deck only, and must be protected from sources of heat.

[78 FR 1095, Jan. 7, 2013]

Subpart I—Detailed Requirements for Class 3 (Flammable) and Combustible Liquid Materials

SOURCE: Amdt. 176-30, 55 FR 52705, Dec. 21, 1990, unless otherwise noted.

§ 176.305 General stowage requirements.

(a) A Class 3 (flammable) or combustible liquid must be kept as cool as reasonably practicable, protected from sources of heat, and away from potential sources of ignition.

(b) Except as otherwise provided in § 176.76(g), a package containing a Class 3 (flammable) liquid and equipped with a vent or safety relief device must be stowed “on deck” only.

(c) The following requirements apply to each hold or compartment in which any Class 3 (flammable) or combustible liquids are being transported:

(1) The hold or compartment must be ventilated except that the stowage of non-bulk packages of Class 3 (flammable) liquids with a flash point above 23 °C (73 °F) (see 49 CFR 171.8 definitions) may be in non-ventilated holds.

(2) Stowage of a Class 3 (flammable) or combustible liquid within 6 m (20

§ 176.305

49 CFR Ch. I (10–1–14 Edition)

feet) of a bulkhead which forms a boundary or deck of a boiler room, engine room, coal bunker, galley, or boiler room uptake is not permitted. If the amount of the liquid to be stowed in a hold will not permit compliance with the requirement for a 6 m (20 foot) separation, less separation distance is authorized if at least one of the following conditions exists:

(i) The bulkhead or deck is covered with at least 8 cm (3 inches) of insulation on the entire area subject to heat;

(ii) A temporary wooden bulkhead at least 5 cm (2 inches) thick is constructed in the hold at least 8 cm (3 inches) off an engine room or 15 cm (5.9 inches) off a boiler room bulkhead, covering the entire area of the bulkhead that is subject to heat, and the space between the permanent bulkhead and the temporary wooden bulkhead is filled with mineral wool or equivalent bulk noncombustible insulating material; or

(iii) A temporary wooden bulkhead is constructed of at least 2.5 cm (1 inch) thick tongue and groove sheathing, located 1 m (3 feet) from the boiler room or engine room bulkhead, and filled with sand to a height of 2 m (7 feet) above the tank top, or, if the cargo compartment is located between decks, 1 m (3 feet) of sand.

(3) Combustible liquids may not be stowed in a hold within 6 m (20 feet) of a common bulkhead with the engine room unless the means of vessel propulsion is internal combustion engines.

(4) Each cargo opening in a bulkhead of an adjacent hold must be securely closed off and made gas-tight, unless the adjacent hold is also used for the stowage of a Class 3 (flammable) or combustible liquid.

(d) In addition to the requirements specified in paragraph (b) of this section, the following requirements apply to each hold or compartment in which a Class 3 (flammable) liquid is transported:

(1) Full and effective hatch covers must be used. Tarpaulins, if fitted, must be protected by dunnaging before overstowing with any cargo. Each tarpaulin must be in one piece and free of rents, tears, and holes;

(2) If Class 3 (flammable) liquids in excess of 1016 kg (2240 pounds) are

stowed under deck in any one hold or compartment, a fire screen must be fitted at the weather end of each vent duct leading from that hold or compartment. The fire screen must completely cover the open area. It must consist of two layers of corrosion-resistant metal wire of 20×20 mesh or finer, spaced not less than 1 cm (0.4 inch) or more than 4 cm (1.6 inches) apart. The screen may be removable only if means for securing it in place when in service are provided;

(3) Each electrical power line in the hold or compartment must be protected by a strong metal covering to prevent crushing by cargo being stowed against it;

(4) Except when fitted with explosion-proof type electrical fixtures, each electrical circuit serving the hold or compartment must be disconnected from all sources of power from a point outside the hold or compartment containing flammable liquids. No circuit may be energized until the flammable liquids and any vapors have been removed from the hold or compartment. Explosion-proof type portable lighting may be used if the source of power is from electrical outlets outside the hold or compartment and above the weather deck; and

(5) A Class 3 (flammable) liquid in excess of 1016 kg (2240 pounds) may not be transported in any hold or compartment that is fitted with a gooseneck type of vent head.

(e) On a passenger vessel, each hold or compartment used to transport a Class 3 (flammable) liquid must be equipped with an overhead water sprinkler system or fixed fire-extinguishing system.

(f) On a passenger vessel, each hold or compartment used to transport Class 3 (flammable) liquids under a passenger space must have an overdeck of an A-60 type construction (see 46 CFR 72.05-10(c)(1)) or equivalent or have its underside covered with at least 8 cm (3 inches) of noncombustible insulation.

(g) No Class 3 (flammable) liquid in a drum or wooden case, having inside packagings of more than 1 L (0.3 gallon) capacity each, may be stowed as a beam filler. A wooden barrel, a wooden box or a fiberboard box, with any Class 3 (flammable) liquid material in inside

packagings of not more than 1 L (0.3 gallon) capacity each, may only be stowed as a beam filler if it is possible to stow and observe any "THIS SIDE UP" marking.

[Amdt. 176-30, 55 FR 52705, Dec. 21, 1990, as amended at 56 FR 66282, Dec. 20, 1991; 78 FR 1096, Jan. 7, 2013]

§ 176.315 Fire protection requirements.

(a) For each 79,500 L (21,000 U.S. gallons) or part thereof of any Class 3 (flammable) or combustible liquid being transported on board a vessel in a portable tank, rail tank car, or a motor vehicle cargo tank, there must be provided at least one B-V semiportable foam (152 L/40 gallon capacity) (see 46 CFR 95.50), dry chemical (45.4 kg (100 pounds) minimum capacity) or equivalent fire extinguisher, or a fire hose fitted with an approved portable mechanical foam nozzle with pick-up tube and two 19 L (5 gallon) cans of foam liquid concentrate. Each foam system must be suitable for use with each Class 3 (flammable) or combustible liquid for which it is required. Each fire extinguisher must be accessible to the tank it is intended to cover.

(b) The fire hose at each fire hydrant in the vicinity of Class 3 (flammable) and combustible liquids stowage areas must be fitted with an approved combination solid stream and water spray nozzle.

(c) The pressure must be maintained in the vessel's fire mains during the loading and unloading of any Class 3 (flammable) or combustible liquids.

(d) Two 7 kg (15-pound) capacity hand portable dry chemical or two portable 10 L (2.6 gallons) foam-type extinguishers must be accessible to any packaged Class 3 (flammable) or combustible liquid and suitable for use with the lading.

(e) The requirements of this section do not apply to portable tanks and their contents authorized under 46 CFR part 98 or 46 CFR part 64.

[Amdt. 176-30, 55 FR 52705, Dec. 21, 1990, as amended at 56 FR 66282, Dec. 20, 1991; 66 FR 45384, 45385, Aug. 28, 2001]

§ 176.320 Use of hand flashlights.

Each hand flashlight used on deck near or in any hold or compartment

containing a Class 3 (flammable) liquid, must be suitable for use in hazardous locations where fire or explosion hazards may exist.

§ 176.325 Smoking or open flame and posting of warning signs.

(a) Smoking or the use of open flame is prohibited in any hold or compartment containing a Class 3 (flammable) or combustible liquid, near any Class 3 (flammable) or combustible liquid stowed on deck, or near any ventilator leading to a hold containing such material.

(b) A sign carrying the legend:

FLAMMABLE VAPORS
KEEP LIGHTS AND FIRE AWAY
NO SMOKING

must be conspicuously posted at each approach to a Class 3 (flammable) or combustible liquid stowed "on deck" and near each cargo hold ventilator leading to a hold or compartment containing this material. This sign must be painted on a white background using red letters. The letters may not be less than 8 cm (3 inches) high.

§ 176.340 Combustible liquids in portable tanks.

Combustible liquids, having a flash point of 38 °C (100 °F) or higher, may be transported by vessel only in one of the portable tanks as specified below:

(a) Specification portable tanks authorized in § 173.241 of this subchapter.

(b) In nonspecification portable tanks, subject to the following conditions:

(1) Each portable tank must conform to a DOT specification 57 portable tank, except as otherwise provided in this paragraph;

(2) The rated capacity of the tank may not exceed 4,542 L (1,200 gallons), and the rated gross weight may not exceed 13,608 kg (30,000 pounds);

(3) The vibration test need not be performed;

(4) When the total surface area of the tank exceeds 14.9 square meters (160 square feet), the total emergency venting capacity must be determined in accordance with table I in § 178.345-10 of this subchapter;

(5) In place of a specification identification marking, the tank must be

§ 176.400

marked, on two sides in letters at least 5 cm (2 inches) high on contrasting background: “FOR COMBUSTIBLE LIQUIDS ONLY” and “49 CFR 176.340”. This latter marking constitutes certification by the person offering the combustible liquid materials for transportation that the portable tank conforms to this paragraph;

(6) Each tank must be made of steel;

(7) The design pressure of the tank must be not less than 62 kPa (9 psig);

(8) No pressure relief device may open at less than 34.4 kPa (5 psig);

(9) Each tank must be retested and marked at least once every 2 years in accordance with the requirements applicable to a DOT specification 57 portable tank in §180.605 of this subchapter; and

(10) Each tank must conform to the provisions of §173.24 of this subchapter and §180.605(b) and (j) of this subchapter.

(c) Portable tanks approved by the Commandant (G-MSO), USCG.

[Amdt. 176-30, 55 FR 52705, Dec. 21, 1990, as amended by Amdt. 176-41, 61 FR 51339, Oct. 1, 1996; 62 FR 51561, Oct. 1, 1997; 66 FR 45185, 45384, Aug. 28, 2001; 67 FR 61015, Sept. 27, 2002; 68 FR 57633, Oct. 6, 2003]

Subpart J—Detailed Requirements for Class 4 (Flammable Solids), Class 5 (Oxidizers and Organic Peroxides), and Division 1.5 Materials

SOURCE: Amdt. 176-30, 55 FR 52706, Dec. 21, 1990, unless otherwise noted.

§ 176.400 Stowage of Division 1.5, Class 4 (flammable solids) and Class 5 (oxidizers and organic peroxides) materials.

(a) Class 4 (flammable solid) material and Division 5.2 (organic peroxide) material must be kept as cool as reasonably practicable, protected from sources of heat, and away from potential sources of ignition.

(b) Division 5.2 (organic peroxide) material must be stowed away from living quarters or access to them. Division 5.2 (organic peroxide) material not requiring temperature control must be protected from sources of heat, including radiant heat and strong sunlight,

49 CFR Ch. I (10-1-14 Edition)

and must be stowed in a cool, well-ventilated area.

(c) No Division 1.5 or Class 5 (oxidizers and organic peroxides) material being transported by vessel may be stowed in the same hold or compartment with any readily combustible material such as a combustible liquid, a textile product, or with a finely divided substance, such as an organic powder.

(d) No Division 1.5 or Class 5 (oxidizers and organic peroxides) material being transported by vessel may be stowed in a hold or compartment containing sulfur in bulk, or in any hold or compartment above, below, or adjacent to one containing sulfur in bulk.

[Amdt. 176-30, 55 FR 52706, Dec. 21, 1990, as amended at 66 FR 45384, Aug. 28, 2001; 78 FR 1096, Jan. 7, 2013]

§ 176.405 Stowage of charcoal.

(a) Before stowing charcoal Division 4.2 (flammable solid), UN 1361, NA 1361, or UN 1362 on a vessel for transportation, the hold or compartment in which it is to be stowed must be swept as clean as practicable. All residue of any former cargo, including especially a petroleum product, a vegetable or animal oil, nitrate, or sulfur, must be removed.

(b) Charcoal packed in bags and offered for transportation on board a vessel in a quantity over 1016 kg (2240 pounds) must be loaded so that the bags are laid horizontally and stacked with space for efficient air circulation. If the bags are not compactly filled and closed to avoid free space within, vertical and horizontal dunnage strips must be laid between the bags. Space for ventilating must be maintained near bulkheads, the shell of the vessel, the deck, and the overhead. No more than 40,600 kg (89,508 pounds) of charcoal may be stowed in a hold or compartment when other stowage space is available. If the unavailability of hold or compartment space requires the stowage of a larger amount, the arrangement of the stow for ventilation must be adjusted to ensure a sufficient venting effect.

(c) Any loose material from bags broken during loading must be removed. Broken bags may be repacked or have the closures repaired and the repaired bags restowed.

(d) Charcoal “screenings” packed in bags must be stowed to provide spaces for air circulation between tiers regardless of the quantity stowed.

§ 176.410 Division 1.5 materials, ammonium nitrate and ammonium nitrate mixtures.

(a) This section prescribes requirements to be observed with respect to transportation of each of the following hazardous materials by vessel:

(1) Explosives, blasting, type E, and Explosives, blasting, type B, Division 1.5 compatibility group D, UN 0331 and UN 0332.

(2) Ammonium nitrate, Division 5.1 (oxidizer), UN1942.

(3) Ammonium nitrate fertilizer, Division 5.1 (oxidizer), UN 2067.

(b) This section does not apply to Ammonium nitrate fertilizer, Class 9, UN 2071 or to any non-acidic ammonium nitrate mixed fertilizer containing 13 percent or less ammonium nitrate, less than 5 percent organic material, and no other oxidizing material, and which does not meet the criteria for any other hazard set forth in part 173 of this subchapter.

(c) When Division 1.5 compatibility group D materials, ammonium nitrate, or any of the ammonium nitrate fertilizers listed in paragraph (a) of this section are transported by vessel:

(1) They must be stowed well away from any steam pipe, electric circuit, or other source of heat;

(2) Smoking is prohibited except in designated areas away from the material and “No-Smoking” signs must be posted in accordance with §176.60;

(3) Fire hoses must be connected, laid out, and tested before loading or unloading commences; and

(4) A fire watch must be posted in the hold or compartment where the material is being loaded or unloaded.

(d) When any of the hazardous materials listed in paragraph (a) of this section is transported in bags by vessel:

(1) The requirements specified in paragraph (c) of this section must be complied with;

(2) The temperature of the bagged material may not exceed 54 °C (130 °F);

(3) Minimum dunnage and sweatboards must be used to prevent any friction or abrasion of bags, and to

allow for the circulation of air and access of water in the event of fire;

(4) The bags must be stowed from side to side, out to the sweatboards;

(5) A space of 46 cm (18 inches) must be provided between any transverse bulkhead and the bags;

(6) The bags must be stowed so as to provide a 46 cm (18 inch) athwartship trench along the centerline of the compartment, continuous from top to bottom;

(7) The bags must be stowed so as to provide a 46 cm (18 inch) amidship trench running fore and aft from bulkhead to bulkhead;

(8) The bags may not be stowed less than 46 cm (18 inches) from any overhead deck beam;

(9) The bags must be stowed so as to provide vent flues 36 cm (14 inches) square at each corner of the hatch continuous from top to bottom;

(10) Trenching must be accomplished by alternating the direction of the bags in each tier (bulkheading); and

(11) The bags must be blocked and braced as necessary to prevent shifting of the bagged cargo adjacent to any trench area.

(e) Notwithstanding §176.83(b) of this part, ammonium nitrate and ammonium nitrate fertilizers classed as Division 5.1 (oxidizers) materials, may be stowed in the same hold, compartment, magazine, or freight container with Class 1 materials (explosive), except those containing chlorates, in accordance with the segregation and separation requirements of §176.144 of this part applying to Explosives, blasting, type B, and Explosives, blasting, type E, Division 1.5 compatibility group D.

(f) No mixture containing ammonium nitrate and any ingredient which would accelerate the decomposition of ammonium nitrate under conditions incident to transportation may be transported by vessel.

[Amdt. 176-30, 55 FR 52706, Dec. 21, 1990, as amended at 56 FR 66282, Dec. 20, 1991; Amdt. 176-34, 58 FR 51533, Oct. 1, 1993; Amdt. 176-38, 60 FR 49111, Sept. 21, 1995; 65 FR 58630, Sept. 29, 2000; 66 FR 45384, Aug. 28, 2001; 68 FR 45041, July 31, 2003]

§ 176.415

49 CFR Ch. I (10–1–14 Edition)

§ 176.415 Permit requirements for Division 1.5, ammonium nitrates, and certain ammonium nitrate fertilizers.

(a) Except as provided in paragraph (b) of this section, before any of the following material is loaded on or unloaded from a vessel at any waterfront facility, the owner/operator must obtain written permission from the Captain of the Port (COTP).

(1) Ammonium nitrate UN1942, ammonium nitrate fertilizers containing more than 70% ammonium nitrate, or Division 1.5 compatibility group D materials packaged in a paper bag, burlap bag, or other nonrigid combustible packaging, or any rigid packaging with combustible inside packagings,

(2) Any other ammonium nitrate or ammonium nitrate fertilizer not listed in § 176.410(a) or (b).

(b) Any of the following may be loaded on or unloaded from a vessel at any waterfront facility without a permit:

(1) Ammonium nitrate, Division 5.1 (oxidizer) UN1942, in a rigid packaging with a noncombustible inside packaging.

(2) Ammonium nitrate fertilizer, Division 5.1 (oxidizer) UN 2067, if the nearest COTP is notified at least 24 hours in advance of any loading or unloading in excess of 454 kg (1,000 pounds).

(3) Division 1.5 compatibility group D material in a rigid packaging with noncombustible inside packaging.

(4) Ammonium nitrate fertilizer, Class 9, UN 2071.

(c) Before a permit may be issued, the following requirements must be met in addition to any others the COTP may impose:

(1) If the material is Explosives, blasting, type E, Division 1.5 compatibility group D, UN0332 in a combustible packaging or in a rigid packaging with a combustible inside packaging, it must be loaded or unloaded at a facility remote from populous areas, or high-value or high-hazard industrial facilities, so that in the event of fire or explosion, loss of lives and property may be minimized;

(2) If the material is a Division 1.5 compatibility group D material in a non-rigid combustible packaging and loaded in a freight container or trans-

port vehicle, it may be loaded or unloaded at a non-isolated facility if the facility is approved by the COTP;

(3) Each facility at which the material is to be loaded or unloaded must conform with the requirements of the port security and local regulations and must have an abundance of water readily available for fire fighting and

(4) Each facility at which the material is to be loaded or unloaded must be located so that each vessel to be loaded or unloaded has an unrestricted passage to open water. Each vessel must be moored bow to seaward, and must be maintained in a mobile status during loading, unloading, or handling operations by the presence of tugs or the readiness of engines. Each vessel must have two wire towing hawsers, each having an eye splice, lowered to the water's edge, one at the bow and the other at the stern.

[Amdt. 176-30, 55 FR 52706, Dec. 21, 1990, as amended at 56 FR 66282, Dec. 20, 1991; Amdt. 176-35, 59 FR 49134, Sept. 26, 1994; 65 FR 58630, Sept. 29, 2000; 66 FR 45185, 45384, 45385, Aug. 28, 2001; 68 FR 45041, July 31, 2003; 74 FR 53189, Oct. 16, 2009]

Subpart K [Reserved]

Subpart L—Detailed Requirements for Division 2.3 (Poisonous Gas) and Division 6.1 (Poisonous) Materials

SOURCE: Amdt. 176-30, 55 FR 52708, Dec. 21, 1990, unless otherwise noted.

§ 176.600 General stowage requirements.

(a) Each package required to have a POISON GAS, POISON INHALATION HAZARD, or POISON label, being transported on a vessel, must be stowed clear of living quarters and any ventilation ducts serving living quarters and separated from foodstuffs, except when the hazardous materials and the foodstuffs are in different closed cargo transport units.

(b) Each package required to have both a POISON GAS label and a FLAMMABLE GAS label thereon must be segregated as a Division 2.1 (flammable gas) material.

(c) Each package bearing a POISON label displaying the text “PG III” or bearing a “PG III” mark adjacent to the poison label must be stowed away from foodstuffs.

(d) Each package of Division 2.3 (poisonous gas) material or Division 6.1 (poison) material that also bears a FLAMMABLE LIQUID or FLAMMABLE GAS label must be stowed in a mechanically ventilated space, kept as cool as reasonably practicable, and be protected from sources of heat and stowed away from potential sources of ignition.

[Amdt. 176-30, 55 FR 52708, Dec. 21, 1990, as amended at 57 FR 45465, Oct. 1, 1992; Amdt. 176-35, 59 FR 49134, Sept. 26, 1994; Amdt. 176-42, 62 FR 1236, Jan. 8, 1997; 64 FR 10782, Mar. 5, 1999; 69 FR 76185, Dec. 20, 2004; 78 FR 1096, Jan. 7, 2013]

§ 176.605 Care following leakage or sifting of Division 2.3 (poisonous gas) and Division 6.1 (poisonous) materials.

A hold or compartment containing a package of a Division 2.3 (poisonous gas) or Division 6.1 (poisonous) material which has leaked or sifted must be thoroughly cleaned and decontaminated after the cargo is unloaded and before the hold or compartment is used for the stowage of any other cargo.

Subpart M—Detailed Requirements for Radioactive Materials

SOURCE: Amdt. 176-15, 48 FR 10245, Mar. 10, 1983, unless otherwise noted.

§ 176.700 General stowage requirements.

(a) [Reserved]

(b) A package of radioactive materials which in still air has a surface temperature more than 5 °C (9 °F) above the ambient air may not be overstowed with any other cargo. If the package is stowed under deck, the hold or compartment in which it is stowed must be ventilated.

(c) For a shipment of radioactive materials requiring supplemental operational procedures, the shipper must furnish the master or person in charge of the vessel a copy of the necessary operational instructions.

(d) A person may not remain unnecessarily in a hold, or compartment, or in the immediate vicinity of any package on deck, containing radioactive materials.

(The information collection requirements in paragraph (d) were approved by the Office of Management and Budget under control numbers 2137-0534, 2137-0535 and 2137-0536)

[Amdt. 176-15, 48 FR 10245, Mar. 10, 1983, as amended by Amdt. 176-15, 48 FR 31220, July 7, 1983; Amdt. 176-23, 50 FR 41523, Oct. 11, 1985; Amdt. 176-37, 60 FR 50333, Sept. 28, 1995; 66 FR 45385, Aug. 28, 2001; 69 FR 3694, Jan. 26, 2004]

§ 176.704 Requirements relating to transport indices and criticality safety indices.

(a) The sum of the transport indices (TI’s) for all packages of Class 7 (radioactive) materials on board a vessel may not exceed the limits specified in Table IIIA of this section.

(b) For freight containers containing packages and overpacks of Class 7 (radioactive) materials, the radiation level may not exceed 2 mSv per hour (200 mrem per hour) at any point on the outside surface and 0.1 mSv per hour (10 mrem per hour) at 2 m (6.6 ft) from the outside surface of the freight container.

(c) The limitations specified in Table IIIA of this section do not apply to consignments of LSA-I material.

(d) The sum of the criticality safety indices (CSI’s) for all packages and overpacks of fissile Class 7 (radioactive) materials on board a vessel may not exceed the limits specified in Table IIIB of this section.

(e) Each group of fissile Class 7 (radioactive) material packages and overpacks, containing a sum of CSIs no greater than 50 for a non-exclusive use shipment, or no greater than 100 for an exclusive use shipment, must be separated from all other groups containing fissile material packages and overpacks by a distance of at least 6 m (20 ft) at all times.

(f) The limitations specified in paragraphs (a) through (c) of this section do not apply when the entire vessel is reserved or chartered for use by a single offeror under exclusive use conditions if—

§ 176.708

49 CFR Ch. I (10–1–14 Edition)

(1) The number of packages of fissile Class 7 (radioactive) material satisfies the individual package CSI limits of § 173.457 of this subchapter, except that the total sums of CSI's in the last column of Table IIIB of this section, including table note (d) apply;

(2) A radiation protection program for the shipment has been established and approved by the competent authority of the flag state of the vessel and, when requested, by the competent authority at each port of call;

(3) Stowage arrangements have been predetermined for the whole voyage, including any consignments to be loaded at ports of call;

(4) The loading, transport and unloading are to be supervised by persons qualified in the transport of radioactive material; and

(5) The entire shipment operation is approved by the Associate Administrator in advance.

(g) Table IIIA is as follows:

TABLE IIIA—TI LIMITS FOR FREIGHT CONTAINERS AND CONVEYANCES

Type of freight container or conveyance	Limit on total sum of transport indices in a single freight container or aboard a conveyance	
	Not under exclusive use	Under exclusive use
I. Freight container—small	50	N/A.
II. Freight container—large	50	No limit.
III. Vessel; ^{a,b}		
1. Hold, compartment or defined deck area:		
i. Packages, overpacks, small freight containers.	50	No limit.
ii. Large freight containers.	200	No limit.
2. Total vessel:		
i. Packages, overpacks, small freight containers.	200	No limit.
ii. Large freight containers.	No limit	No limit.

NOTES:

^aFor vessels, the requirements in both 1 and 2 must be fulfilled.

^bPackages or overpacks transported in or on a vehicle which are offered for transport in accordance with the provisions of § 173.441(b) of this subchapter may be transported by vessels provided that they are not removed from the vehicle at any time while on board the vessel.

(h) Table IIIB is as follows:

TABLE IIIB—CSI LIMITS FOR FREIGHT CONTAINERS AND CONVEYANCES

Type of freight container or conveyance	Limit on total sum of criticality safety indices in a single freight container or aboard a conveyance	
	Not under exclusive use	Under exclusive use
I. Freight container—small	50	N/A.
II. Freight container—large	50	100.
III. Vessel; ^{a,b}		
1. Hold, compartment or defined deck area:		
i. Packages, overpacks, small freight containers.	50	100.
ii. Large freight containers.	50	100.
2. Total vessel:		
i. Packages, overpacks, small freight containers.	200 ^c	200 ^d .
ii. Large freight containers.	No limit ^c ..	No limit ^d .

NOTES:

^aFor vessels, the requirements in both 1 and 2 must be fulfilled.

^bPackages or overpacks transported in or on a vehicle which are offered for transport in accordance with the provisions of § 173.441(b) of this subchapter may be transported by vessels provided that they are not removed from the vehicle at any time while on board the vessel. In that case, the entries under the heading "under exclusive use" apply.

^cThe consignment must be handled and stowed such that the total sum of CSIs in any group does not exceed 50, and such that each group is handled and stowed so that the groups are separated from each other by at least 6 m (20 ft).

^dThe consignment must be handled and stowed such that the total sum of CSIs in any group does not exceed 100, and such that each group is handled and stowed so that the groups are separated from each other by at least 6 m (20 ft). The intervening space between groups may be occupied by other cargo.

[69 FR 3694, Jan. 26, 2004]

§ 176.708 Segregation distances.

(a) Table IV lists minimum separation distances between radioactive materials and spaces regularly occupied by crew members or passengers, or between radioactive materials and undeveloped photographic film. It expresses the separation distances as a function of the sum of the TIs of all packages in a single consignment, in the case of 0 or 3 feet of intervening cargo of unit density for persons, and 0, 3, or 6 feet of intervening cargo of unit density for undeveloped film. Cargo of unit density is stowed cargo with a density of 1 long ton (2240 lbs.) per 36 cubic feet. Separation distances may be interpolated from the table where appropriate.

(b) Table IV is to be used to determine the separation distance for undeveloped film.

(c) Category YELLOW-II or YELLOW-III packages or overpacks must not be transported in spaces occupied by passengers, except those exclusively reserved for couriers specially authorized to accompany such packages or overpacks.

(d) The separation distances for crew members and passengers may be determined by one of two methods:

(1) By using Table IV to determine the minimum distances between the radioactive material packages and regularly occupied spaces or living quarters; or

(2) For one or more consignments of Class 7 (radioactive) material to be loaded on board a vessel under the exclusive use conditions described in

§176.704(f), by demonstration through direct measurement, made and documented by a suitably qualified person, that for the indicated exposure times the dose rate in regularly occupied spaces or living quarters is less than—

(i) For the crew: 7.0 $\mu\text{Sv/h}$ (0.70 mrem/h) up to 700 hours in a year, or 1.8 $\mu\text{Sv/h}$ (0.18 mrem/h) up to 2750 hours in a year; and

(ii) For the passengers: 1.8 $\mu\text{Sv/h}$ (0.18 mrem/h) up to 550 hours in a year, taking into account any relocation of cargo during the voyage.

(e) Any departure from the segregation provisions should be approved by the competent authority of the flag state of the ship and, when requested, by the competent authority at each port of call.

(f) Table IV is as follows:

§ 176.710 Care following leakage or sifting of radioactive materials.

(a) In case of fire, collision, or breakage involving any shipment of radioactive materials, other than materials of low specific activity, the radioactive materials must be segregated from unnecessary contact with personnel. In case of obvious leakage, or if the inside container appears to be damaged, the stowage area (hold, compartment, or deck area) containing this cargo must be isolated as much as possible to prevent radioactive material from entering any person's body through contact, inhalation, or ingestion. No person may handle the material or remain in the vicinity unless supervised by a qualified person.

(b) A hold or compartment in which leakage of radioactive materials has occurred may not be used for other cargo until it is decontaminated in accordance with the requirements of § 176.715.

(c) For reporting requirements, see § 171.15 of this subchapter.

§ 176.715 Contamination control.

Each hold, compartment, or deck area used for the transportation of low specific activity or surface contaminated object Class 7 (radioactive) materials under exclusive use conditions in accordance with § 173.427(b)(4), or § 173.427(c) must be surveyed with appropriate radiation detection instruments after each use. Such holds, compartments, and deck areas may not be used again for Class 7 (radioactive) materials exclusive use transport service, and then only for a subsequent exclusive use shipment utilizing the provisions of § 173.427(b)(4), or § 173.427(c) until the radiation dose rate at every accessible surface is less than 0.005 mSv/h (0.5 mrem/h), and the non-fixed contamination is not greater than the limits prescribed in § 173.443(a) of this subchapter.

[79 FR 40618, July 11, 2014]

§ 176.720 Requirements for carriage of INF cargo in international transportation.

In addition to all other applicable requirements of this subchapter, a vessel carrying INF cargo (see § 176.2, under

INF cargo definition) in international transportation must meet the requirements of the INF Code contained in the IMDG Code (IBR, see § 171.7 of this subchapter).

[68 FR 75748, Dec. 31, 2003]

Subpart N—Detailed Requirements for Class 8 (Corrosive Materials) Materials

SOURCE: Amdt. 176-30, 55 FR 52708, Dec. 21, 1990, unless otherwise noted.

§ 176.800 General stowage requirements.

(a) Each package required to have a Class 8 (corrosive) label thereon being transported on a vessel must be stowed clear of living quarters, and away from foodstuffs and cargo of an organic nature.

(b) A package of Class 8 (corrosive material) material may not be stowed over any readily combustible material.

(c) Glass carboys containing Class 8 (corrosive material) material may not be stowed on board any vessel, other than a barge, more than two tiers high unless each carboy is boxed or crated with neck protection extending to the sides of the carboy box. This protective construction must be strong enough to permit stacking one on top of the other.

(d) A Class 8 (corrosive material) material may not be stowed over a hold or compartment containing cotton unless the deck is of steel and the hatch is fitted with a tight coaming. In addition, the deck must be tight against leakage and the Class 8 (corrosive material) material may not be stowed over the square of the hatch.

(e) Each package of Class 8 (corrosive material) which also bears a FLAMMABLE LIQUID label must be stowed away from all sources of heat and ignition.

[Amdt. 176-30, 55 FR 52708, Dec. 21, 1990, as amended by Amdt. 176-39, 61 FR 18933, Apr. 29, 1996]

§ 176.805 On deck stowage.

When break bulk Class 8 (corrosive materials) materials being transported on a vessel are stowed on deck:

§ 176.900

49 CFR Ch. I (10–1–14 Edition)

(a) Provisions must be made for leakage from any package to drain away from other cargo into an overboard scupper or freeing port. The drainage may not enter an enclosed drainage system other than a direct overboard scupper. If this stowage is not practical, sufficient clean dry sand must be placed under and around the lower tier of packages to absorb any leakage.

(b) Dunnage must be provided on the deck and arranged so that any leakage will be apparent.

(c) Any leakage that occurs must be washed down, using liberal quantities of water.

Subpart O—Subpart O—Detailed Requirements for Cotton and Vegetable Fibers, Motor Vehicles, Polymeric Beads, and Plastic Molding Compounds

SOURCE: Amdt. 176–30, 55 FR 52708, Dec. 21, 1990, unless otherwise noted.

§ 176.900 Packaging and stowage of cotton and vegetable fibers; general.

(a) Cotton, Class 9, NA 1365, Cotton, wet, Division 4.2, UN 1365, and other vegetable fibers, Division 4.1, being transported on a vessel must be securely baled and bound. Each bale of cotton or vegetable fibers must be covered with bagging on at least three-fourths of its surface, including both ends. Cut cotton linters may be accepted for transportation by vessel when baled and covered with bagging on the soft sides only if the bale is compressed to a density of at least 512 kg/m³ (32 pounds per cubic foot) and it is bound with at least six bands per bale. Any poorly compressed bale or any bale having damaged bindings may not be transported by vessel.

(b) Each bale of Cotton, wet, Division 4.2, UN 1365 must be stowed separately from any bales of dry cotton or vegetable fibers, in a 'tween deck space, and not overstowed. Any bale of cotton or vegetable fibers which is saturated with water may not be transported by vessel.

(c) Bales of cotton or vegetable fibers showing contact with oil or grease may not be accepted for transportation by vessel.

(d) Cotton or vegetable fibers must be stowed in a hold or compartment in accordance with the following requirements:

(1) All traces of oil or residue in the hold or compartment must be removed;

(2) A recently painted hold or compartment may not be used unless it is thoroughly dry;

(3) Each ventilation cowl serving the hold or compartment must be fitted with a spark screen;

(4) When a bulkhead of the hold or compartment is common with a boiler room, engine room, coal bunker, or galley and subjected to heat, a wooden bulkhead must be erected between the bulkhead and any cotton or vegetable fibers. This wooden bulkhead must be at least 15 cm (6 inches) from a boiler room bulkhead, and at least 5 cm (2 inches) from an engine room, coal bunker, or galley bulkhead;

(5) Each 'tween deck hatch must be closed with hatch covers, tarpaulins, and dunnage; however, metal hatch covers which are sealed by other means to provide equivalent protection may be used;

(6) Each hold or compartment must be equipped with a carbon dioxide or overhead water sprinkler system or other approved fixed extinguishing system. Before loading, the extinguishing system must be examined to ensure that it is in good working condition; and

(7) Each hold or compartment must be clear of all debris and swept as clean as practicable before loading.

(e) Naked lights or any fire likely to produce sparks are not permitted on the vessel, dock area, or on any lighters alongside a vessel during loading or unloading of cotton or vegetable fibers.

(f) Upon completion of stowage, each opening must be completely closed. Where required, tarpaulins must be fitted and secured in place to provide a tight hold. During a period of temporary stoppage of loading or unloading, a hatch may be left open. However, during that period, a fire watch, designated by the master or officer-in-charge, must be stationed in the hold or compartment in which the cotton or vegetable fibers are stowed.

(g) At least one fire hose must be connected while cotton or vegetable fibers are being loaded or unloaded. Each fire pump must be operated before any loading or unloading. Pressure must be maintained on each fire main during the loading and the fire hose laid out ready for immediate use. Portable fire extinguishers must be placed to be readily available. The fire hose, fire pumps, and fire extinguishers may be the vessel's equipment or shore equipment.

(h) Smoking is not permitted on a vessel during the loading or unloading of cotton or vegetable fibers except at those times and in those places designated by the master. "NO SMOKING" signs must be conspicuously posted in appropriate places, and the responsible person in charge of the loading or unloading (see §176.57 of this part) must ensure that they are observed.

(i) Cotton or vegetable fibers may be stowed in the same hold over bulk sulfur if the sulfur has been trimmed and leveled and the hold is thoroughly cleaned of sulfur dust. A tight floor of two layers of 2.54 cm (1 inch) crossed clean dunnage boards must be laid on the sulfur before cotton or vegetable fibers are stowed. These substances may be stowed alongside each other in the same hold if they are separated by a tight dustproof wood bulkhead.

(j) Cotton or vegetable fibers may not be stowed in a 'tween deck hold over bulk sulfur in a lower hold unless the 'tween deck hold has been thoroughly cleaned of all sulfur dust and the 'tween deck hatch covers are in place and covered with tarpaulins and dunnage.

§ 176.901 Stowage of cotton or vegetable fibers with rosin or pitch.

(a) Unless impracticable, cotton or vegetable fibers being transported on a vessel may not be stowed in the same hold or compartment with rosin or pitch being transported on the same vessel.

(b) When separate stowage is impracticable, the cotton or vegetable fibers may be stowed in the same hold or compartment with rosin or pitch if they are separated by clean dunnage or a cargo of a non-combustible nature.

When such stowage within the same hold or compartment involves large amounts of cotton or fibers or of rosin or pitch, the rosin or pitch must be floored off with at least two layers of 2.54 cm (1 inch) dunnaging and the cotton or vegetable fibers stowed above.

§ 176.903 Stowage of cotton or vegetable fibers with coal.

Cotton or vegetable fibers being transported on a vessel may not be stowed in the same hold with coal. They may be stowed in adjacent holds if the holds are separated by a tight steel bulkhead and the cotton or vegetable fibers are dunnaged at least 5 cm (2 inches) off the bulkhead. Cotton or vegetable fibers may be stowed in a hold above or below one in which coal is stowed if there is a tight steel intervening deck and all hatch covers are in place and covered with tarpaulins.

§ 176.905 Stowage of motor vehicles or mechanical equipment.

(a) A vehicle or any mechanical equipment powered by an internal combustion engine, a fuel cell, batteries or a combination thereof, is subject to the following requirements when carried as cargo on a vessel:

(1) Before being loaded on a vessel, each vehicle or mechanical equipment must be inspected for fuel leaks and identifiable faults in the electrical system that could result in short circuit or other unintended electrical source of ignition. A vehicle or mechanical equipment showing any signs of leakage or electrical fault may not be transported.

(2) The fuel tank of a vehicle or mechanical equipment powered by liquid fuel may not be more than one-fourth full.

(3) Whenever possible, each vehicle or mechanical equipment must be stowed to allow for its inspection during transportation.

(4) Vehicles or mechanical equipment may be refueled when necessary in the hold of a vessel in accordance with §176.78 of this part.

(b) All equipment used for handling vehicles or mechanical equipment must be designed so that the fuel tank and the fuel system of the vehicle or mechanical equipment are protected

from stress that might cause rupture or other damage incident to handling.

(c) Two hand-held, portable, dry chemical fire extinguishers of at least 4.5 kg (10 pounds) capacity each must be separately located in an accessible location in each hold or compartment in which any vehicle or mechanical equipment is stowed.

(d) “NO SMOKING” signs must be conspicuously posted at each access opening to the hold or compartment.

(e) Each portable electrical light, including a flashlight, used in the stowage area must be an approved, explosion-proof type. All electrical connections for any light must be made to outlets outside the space in which any vehicle or mechanical equipment is stowed.

(f) Each hold or compartment must be ventilated and fitted with an overhead water sprinkler system or fixed fire extinguisher system.

(g) Each hold or compartment must be equipped with a smoke or fire detection system capable of alerting personnel on the bridge.

(h) All electrical equipment in the hold or compartment other than fixed explosion-proof lighting must be disconnected from its power source at a location outside the hold or compartment during the handling and transportation of any vehicle or mechanical equipment. Where the disconnecting means is a switch or circuit breaker, it must be locked in the open position until all vehicles have been removed.

(i) Exceptions—A vehicle or mechanical equipment is excepted from the requirements of this subchapter if any of the following are met:

(1) The vehicle or mechanical equipment has an internal combustion engine using liquid fuel that has a flashpoint less than 38 °C (100 °F), the fuel tank is empty, and the engine is run until it stalls for lack of fuel;

(2) The vehicle or mechanical equipment has an internal combustion engine using liquid fuel that has a flashpoint of 38 °C (100 °F) or higher, the fuel tank contains 418 L (110 gallons) of fuel or less, and there are no fuel leaks in any portion of the fuel system;

(3) The vehicle or mechanical equipment is stowed in a hold or compart-

ment designated by the administration of the country in which the vessel is registered as specially designed and approved for vehicles and mechanical equipment and there are no signs of leakage from the battery, engine, fuel cell, compressed gas cylinder or accumulator, or fuel tank, as appropriate. For vehicles with batteries connected and fuel tanks containing gasoline transported by U.S. vessels, see 46 CFR 70.10–1 and 90.10–38;

(4) The vehicle or mechanical equipment is electrically powered solely by wet electric storage batteries (including nonspillable batteries) or sodium batteries; or

(5) The vehicle or mechanical equipment is equipped with liquefied petroleum gas or other compressed gas fuel tanks, the tanks are completely emptied of liquefied or compressed gas and the positive pressure in the tank does not exceed 2 bar (29 psig), the line from the fuel tank to the regulator and the regulator itself is drained of all traces of liquefied or compressed gas, and the fuel shut-off valve is closed.

(j) Except as provided in §173.220(f) of this subchapter, the provisions of this subchapter do not apply to items of equipment such as fire extinguishers, compressed gas accumulators, airbag inflators and the like which are installed in the vehicle or mechanical equipment if they are necessary for the operation of the vehicle or equipment, or for the safety of its operator or passengers.

[76 FR 3384, Jan. 19, 2011, as amended at 76 FR 82179, Dec. 30, 2011; 78 FR 1117, Jan. 7, 2013; 78 FR 65486, Oct. 31, 2013]

§176.907 Polymeric Beads and Plastic Molding Compounds.

(a) When transported in cargo transport units, the cargo transport units must provide an adequate exchange of air in the unit. This adequate exchange of air may be accomplished by utilizing a ventilated container, an open-top container, or a container in one door off operation. When cargo transport units with venting devices are used these devices should be kept clear and operable. If mechanical devices are used for ventilation, they must be explosion-proof.

(b) As an alternative to the options presented in paragraph (a) of this section to ensure an adequate exchange of air; a refrigerated cargo transport unit may be used.

(c) The requirements in paragraph (a) and (b) of this section do not apply if the hazardous material is:

(1) Packed in hermetically sealed packagings or IBC's which conform to packing group II performance level for liquid dangerous goods with a total pressure in the packaging (i.e., the vapor pressure of the material plus the partial pressure of air or other inert gases, less 100kPa (15 psia)) at 55 °C (131 °F), determined on the basis of the hazardous material not completely filling the receptacle at a temperature of 55 °C (131 °C) or less at a filling temperature of 15 °C (59 °F), will not exceed two-thirds of the marked test pressure.

(2) [Reserved]

(d) Cargo transport units must be marked with a warning mark including the words "CAUTION—MAY CONTAIN FLAMMABLE VAPOR" or "CAUTION—MAY CONTAIN FLAMMABLE VAPOUR" with lettering having a height of at least 25 mm (1 inch). The mark must be affixed to each access point in a location where it will be easily seen by persons prior to opening or entering the cargo transport unit and must remain on the cargo transport unit until the following provisions are met:

(1) The cargo transport unit has been completely ventilated to remove any hazardous concentrations of vapor or gas;

(2) The immediate vicinity of the cargo transport unit is clear of any source of ignition; and

(3) The hazardous materials have been unloaded.

[78 FR 1096, Jan. 7, 2013]

PART 177—CARRIAGE BY PUBLIC HIGHWAY

Subpart A—General Information and Regulations

Sec.

177.800 Purpose and scope of this part and responsibility for compliance and training.

- 177.801 Unacceptable hazardous materials shipments.
- 177.802 Inspection.
- 177.804 Compliance with Federal Motor Carrier Safety Regulations.
- 177.810 Vehicular tunnels.
- 177.816 Driver training.
- 177.817 Shipping papers.
- 177.823 Movement of motor vehicles in emergency situations.

Subpart B—Loading and Unloading

- 177.834 General requirements.
- 177.835 Class 1 materials.
- 177.837 Class 3 materials.
- 177.838 Class 4 (flammable solid) materials, Class 5 (oxidizing) materials, and Division 4.2 (pyroforic liquid) materials.
- 177.839 Class 8 (corrosive) materials.
- 177.840 Class 2 (gases) materials.
- 177.841 Division 6.1 and Division 2.3 materials.
- 177.842 Class 7 (radioactive) material.
- 177.843 Contamination of vehicles.

Subpart C—Segregation and Separation Chart of Hazardous Materials

- 177.848 Segregation of hazardous materials.

Subpart D—Vehicles and Shipments in Transit; Accidents

- 177.854 Disabled vehicles and broken or leaking packages; repairs.

Subpart E—Regulations Applying to Hazardous Material on Motor Vehicles Carrying Passengers for Hire

- 177.870 Regulations for passenger carrying vehicles.

AUTHORITY: 49 U.S.C. 5101-5128; sec. 112 of Pub. L. 103-311, 108 Stat. 1673, 1676 (1994); sec. 32509 of Pub. L. 112-141, 126 Stat. 405, 805 (2012); 49 CFR 1.81 and 1.97.

Subpart A—General Information and Regulations

§ 177.800 Purpose and scope of this part and responsibility for compliance and training.

(a) *Purpose and scope.* This part prescribes requirements, in addition to those contained in parts 171, 172, 173, 178 and 180 of this subchapter, that are applicable to the acceptance and transportation of hazardous materials by private, common, or contract carriers by motor vehicle.

§ 177.801

(b) *Responsibility for compliance.* Unless this subchapter specifically provides that another person shall perform a particular duty, each carrier, including a connecting carrier, shall perform the duties specified and comply with all applicable requirements in this part and shall ensure its hazmat employees receive training in relation thereto.

(c) *Responsibility for training.* A carrier may not transport a hazardous material by motor vehicle unless each of its hazmat employees involved in that transportation is trained as required by this part and subpart H of part 172 of this subchapter.

(d) *No unnecessary delay in movement of shipments.* All shipments of hazardous materials must be transported without unnecessary delay, from and including the time of commencement of the loading of the hazardous material until its final unloading at destination.

[Amdt. 177-79, 57 FR 20954, May 15, 1992, as amended by Amdt.177-86, 61 FR 18933, Apr. 29, 1996]

§ 177.801 Unacceptable hazardous materials shipments.

No person may accept for transportation or transport by motor vehicle a forbidden material or hazardous material that is not prepared in accordance with the requirements of this subchapter.

[Amdt. 177-87, 61 FR 27175, May 30, 1996]

§ 177.802 Inspection.

Records, equipment, packagings and containers under the control of a motor carrier, insofar as they affect safety in transportation of hazardous materials by motor vehicle, must be made available for examination and inspection by a duly authorized representative of the Department.

[Amdt. 177-71, 54 FR 25015, June 12, 1989]

§ 177.804 Compliance with Federal Motor Carrier Safety Regulations.

(a) *General.* Motor carriers and other persons subject to this part must comply with 49 CFR part 383 and 49 CFR parts 390 through 397 (excluding §§397.3 and 397.9) to the extent those regulations apply.

49 CFR Ch. I (10-1-14 Edition)

(b) *Additional prohibitions.* A person transporting a quantity of hazardous materials requiring placarding under 49 CFR part 172 or any quantity of a material listed as a select agent or toxin in 42 CFR part 73:

(1) Must comply with the safe clearance requirements for highway-rail grade crossings in §392.12 of this title;

(2) May not engage in, allow, or require texting while driving, in accordance with §392.80 of this title; and

(3) May not engage in, allow, or require the use of a hand-held mobile telephone while driving, in accordance with §392.82 of this title.

[78 FR 58923, Sept. 25, 2013]

§ 177.810 Vehicular tunnels.

Except as regards Class 7 (radioactive) materials, nothing contained in parts 170-189 of this subchapter shall be so construed as to nullify or supersede regulations established and published under authority of State statute or municipal ordinance regarding the kind, character, or quantity of any hazardous material permitted by such regulations to be transported through any urban vehicular tunnel used for mass transportation.

[Amdt. 177-52, 46 FR 5316, Jan. 19, 1981, as amended by Amdt. 177-78, 55 FR 52710, Dec. 21, 1990; 62 FR 51561, Oct. 1, 1997]

§ 177.816 Driver training.

(a) In addition to the training requirements of §177.800, no carrier may transport, or cause to be transported, a hazardous material unless each hazmat employee who will operate a motor vehicle has been trained in the applicable requirements of 49 CFR parts 390 through 397 and the procedures necessary for the safe operation of that motor vehicle. Driver training shall include the following subjects:

(1) Pre-trip safety inspection;

(2) Use of vehicle controls and equipment, including operation of emergency equipment;

(3) Operation of vehicle, including turning, backing, braking, parking, handling, and vehicle characteristics including those that affect vehicle stability, such as effects of braking and

curves, effects of speed on vehicle control, dangers associated with maneuvering through curves, dangers associated with weather or road conditions that a driver may experience (e.g., blizzards, mountainous terrain, high winds), and high center of gravity;

(4) Procedures for maneuvering tunnels, bridges, and railroad crossings;

(5) Requirements pertaining to attendance of vehicles, parking, smoking, routing, and incident reporting; and

(6) Loading and unloading of materials, including—

(i) Compatibility and segregation of cargo in a mixed load;

(ii) Package handling methods; and

(iii) Load securement.

(b) *Specialized requirements for cargo tanks and portable tanks.* In addition to the training requirement of paragraph (a) of this section, each person who operates a cargo tank or a vehicle with a portable tank with a capacity of 1,000 gallons or more must receive training applicable to the requirements of this subchapter and have the appropriate State-issued commercial driver's license required by 49 CFR part 383. Specialized training shall include the following:

(1) Operation of emergency control features of the cargo tank or portable tank;

(2) Special vehicle handling characteristics, including: high center of gravity, fluid-load subject to surge, effects of fluid-load surge on braking, characteristic differences in stability among baffled, unbaffled, and multi-compartmented tanks; and effects of partial loads on vehicle stability;

(3) Loading and unloading procedures;

(4) The properties and hazards of the material transported; and

(5) Retest and inspection requirements for cargo tanks.

(c) The training required by paragraphs (a) and (b) of this section may be satisfied by compliance with the current requirements for a Commercial Driver's License (CDL) with a tank vehicle or hazardous materials endorsement.

(d) Training required by paragraph (b) of this section must conform to the requirements of §172.704 of this sub-

chapter with respect to frequency and recordkeeping.

[Amdt. 177-79, 57 FR 20954, May 15, 1992, as amended by Amdt. 177-79, 58 FR 5852, Jan. 22, 1993]

§ 177.817 Shipping papers.

(a) *General requirements.* A person may not accept a hazardous material for transportation or transport a hazardous material by highway unless that person has received a shipping paper prepared in accordance with part 172 of this subchapter or the material is excepted from shipping paper requirements under this subchapter. A subsequent carrier may not transport a hazardous material unless it is accompanied by a shipping paper prepared in accordance with part 172 of this subchapter, except for §172.204, which is not required.

(b) *Shipper certification.* An initial carrier may not accept a hazardous material offered for transportation unless the shipping paper describing the material includes a shipper's certification which meets the requirements in §172.204 of this subchapter. Except for a hazardous waste, the certification is not required for shipments to be transported entirely by private carriage and for bulk shipments to be transported in a cargo tank supplied by the carrier.

(c) *Requirements when interlining with carriers by rail.* A motor carrier shall mark on the shipping paper required by this section, if it offers or delivers a freight container or transport vehicle to a rail carrier for further transportation:

(1) A description of the freight container or transport vehicle; and

(2) The kind of placard affixed to the freight container or transport vehicle.

(d) This subpart does not apply to a material that is excepted from shipping paper requirements as specified in §172.200 of this subchapter.

(e) *Shipping paper accessibility—accident or inspection.* A driver of a motor vehicle containing hazardous material, and each carrier using such a vehicle,

§ 177.823

shall ensure that the shipping paper required by this section is readily available to, and recognizable by, authorities in the event of accident or inspection. Specifically, the driver and the carrier shall:

(1) Clearly distinguish the shipping paper, if it is carried with other shipping papers or other papers of any kind, by either distinctively tabbing it or by having it appear first; and

(2) Store the shipping paper as follows:

(i) When the driver is at the vehicle's controls, the shipping paper shall be: (A) Within his immediate reach while he is restrained by the lap belt; and (B) either readily visible to a person entering the driver's compartment or in a holder which is mounted to the inside of the door on the driver's side of the vehicle.

(ii) When the driver is not at the vehicle's controls, the shipping paper shall be: (A) In a holder which is mounted to the inside of the door on the driver's side of the vehicle; or (B) on the driver's seat in the vehicle.

(f) *Retention of shipping papers.* Each person receiving a shipping paper required by this section must retain a copy or an electronic image thereof, that is accessible at or through its principal place of business and must make the shipping paper available, upon request, to an authorized official of a Federal, State, or local government agency at reasonable times and locations. For a hazardous waste, the shipping paper copy must be retained for three years after the material is accepted by the initial carrier. For all other hazardous materials, the shipping paper copy must be retained for one year after the material is accepted by the carrier. Each shipping paper copy must include the date of acceptance by the carrier. A motor carrier (as defined in §390.5 of subchapter B of chapter III of subtitle B) using a shipping paper without change for multiple shipments of one or more hazardous materials having the same shipping name and identification number may retain a single copy of the shipping paper, instead of a copy for each shipment made, if the carrier also retains a record of each shipment made that includes shipping name, identification

49 CFR Ch. I (10–1–14 Edition)

number, quantity transported, and date of shipment.

[Amdt. 177–35, 41 FR 16130, Apr. 15, 1976, as amended by Amdt. 177–35A, 41 FR 40691, Sept. 20, 1976; Amdt. 177–48, 45 FR 47670, Nov. 10, 1980; Amdt. 177–65, 50 FR 11055, Mar. 19, 1985; Amdt. 177–72, 53 FR 17160, May 13, 1988; 67 FR 46128, July 12, 2002; 67 FR 66574, Nov. 1, 2002; 68 FR 19277, Apr. 18, 2003; 68 FR 57633, Oct. 6, 2003; 70 FR 73165, Dec. 9, 2005]

§ 177.823 Movement of motor vehicles in emergency situations.

(a) A carrier may not move a transport vehicle containing a hazardous material unless the vehicle is marked and placarded in accordance with part 172 or as authorized in §171.12a of this subchapter, or unless, in an emergency:

(1) The vehicle is escorted by a representative of a state or local government;

(2) The carrier has permission from the Department; or

(3) Movement of the transport vehicle is necessary to protect life or property.

(b) *Disposition of contents of cargo tank when unsafe to continue.* In the event of a leak in a cargo tank of such a character as to make further transportation unsafe, the leaking vehicle should be removed from the traveled portion of the highway and every available means employed for the safe disposal of the leaking material by preventing, so far as practicable, its spread over a wide area, such as by digging trenches to drain to a hole or depression in the ground, diverting the liquid away from streams or sewers if possible, or catching the liquid in containers if practicable. Smoking, and any other source of ignition, in the vicinity of a leaking cargo tank is not permitted.

(c) *Movement of leaking cargo tanks.* A leaking cargo tank may be transported only the minimum distance necessary to reach a place where the contents of the tank or compartment may be disposed of safely. Every available means must be utilized to prevent the leakage or spillage of the liquid upon the highway.

[Amdt. 177–35, 41 FR 16130, Apr. 15, 1976, as amended by Amdt. 177–67, 50 FR 41521, Oct. 11, 1985; Amdt. 177–86, 61 FR 18933, Apr. 29, 1996]

Subpart B—Loading and Unloading

NOTE: For prohibited loading and storage of hazardous materials, see § 177.848.

§ 177.834 General requirements.

(a) *Packages secured in a motor vehicle.* Any package containing any hazardous material, not permanently attached to a motor vehicle, must be secured against shifting, including relative motion between packages, within the vehicle on which it is being transported, under conditions normally incident to transportation. Packages having valves or other fittings must be loaded in a manner to minimize the likelihood of damage during transportation.

(b) Each package containing a hazardous material bearing package orientation markings prescribed in § 172.312 of this subchapter must be loaded on a transport vehicle or within a freight container in accordance with such markings and must remain in the correct position indicated by the markings during transportation.

(c) *No smoking while loading or unloading.* Smoking on or about any motor vehicle while loading or unloading any Class 1 (explosive), Class 3 (flammable liquid), Class 4 (flammable solid), Class 5 (oxidizing), or Division 2.1 (flammable gas) materials is forbidden.

(d) *Keep fire away, loading and unloading.* Extreme care shall be taken in the loading or unloading of any Class 1 (explosive), Class 3 (flammable liquid), Class 4 (flammable solid), Class 5 (oxidizing), or Division 2.1 (flammable gas) materials into or from any motor vehicle to keep fire away and to prevent persons in the vicinity from smoking, lighting matches, or carrying any flame or lighted cigar, pipe, or cigarette.

(e) *Handbrake set while loading and unloading.* No hazardous material shall be loaded into or on, or unloaded from, any motor vehicle unless the handbrake be securely set and all other reasonable precautions be taken to prevent motion of the motor vehicle during such loading or unloading process.

(f) *Use of tools, loading and unloading.* No tools which are likely to damage the effectiveness of the closure of any package or other container, or likely

adversely to affect such package or container, shall be used for the loading or unloading of any Class 1 (explosive) material or other dangerous article.

(g) [Reserved]

(h) *Precautions concerning containers in transit; fueling road units.* Reasonable care should be taken to prevent undue rise in temperature of containers and their contents during transit. There must be no tampering with such container or the contents thereof nor any discharge of the contents of any container between point of origin and point of billed destination. Discharge of contents of any container, other than a cargo tank or IM portable tank, must not be made prior to removal from the motor vehicle. Nothing contained in this paragraph shall be so construed as to prohibit the fueling of machinery or vehicles used in road construction or maintenance.

(i) *Attendance requirements—(1) Loading.* A cargo tank must be attended by a qualified person at all times when it is being loaded. The person who is responsible for loading the cargo tank is also responsible for ensuring that it is so attended.

(2) *Unloading.* A motor carrier who transports hazardous materials by a cargo tank must ensure that the cargo tank is attended by a qualified person at all times during unloading. However, the carrier's obligation to ensure attendance during unloading ceases when:

(i) The carrier's obligation for transporting the materials is fulfilled;

(ii) The cargo tank has been placed upon the consignee's premises; and

(iii) The motive power has been removed from the cargo tank and removed from the premises.

(3) Except for unloading operations subject to §§ 177.837(d), 177.840(p), and 177.840(q), a qualified person "attends" the loading or unloading of a cargo tank if, throughout the process, he is alert and is within 7.62 m (25 feet) of the cargo tank. The qualified person attending the unloading of a cargo tank must have an unobstructed view of the cargo tank and delivery hose to the maximum extent practicable during the unloading operation.

(4) A person is "qualified" if he has been made aware of the nature of the

hazardous material which is to be loaded or unloaded, he has been instructed on the procedures to be followed in emergencies, he is authorized to move the cargo tank, and he has the means to do so.

(j) Except for a cargo tank conforming to §173.29(b)(2) of this subchapter, a person may not drive a cargo tank motor vehicle containing a hazardous material regardless of quantity unless:

(1) All manhole closures are closed and secured; and

(2) All valves and other closures in liquid discharge systems are closed and free of leaks, except external emergency self-closing valves on MC 338 cargo tanks containing the residue of cryogenic liquids may remain either open or closed during transit.

(k) [Reserved]

(1) *Use of cargo heaters when transporting certain hazardous material.* Transportation includes loading, carrying, and unloading.

(1) *When transporting Class 1 (explosive) materials.* A motor vehicle equipped with a cargo heater of any type may transport Class 1 (explosive) materials only if the cargo heater is rendered inoperable by: (i) Draining or removing the cargo heater fuel tank; and (ii) disconnecting the heater's power source.

(2) *When transporting certain flammable material—(i) Use of combustion cargo heaters.* A motor vehicle equipped with a combustion cargo heater may be used to transport Class 3 (flammable liquid) or Division 2.1 (flammable gas) materials only if each of the following requirements are met:

(A) It is a catalytic heater.

(B) The heater's surface temperature cannot exceed 54 °C (130 °F)—either on a thermostatically controlled heater or on a heater without thermostatic control when the outside or ambient temperature is 16 °C (61 °F) or less.

(C) The heater is not ignited in a loaded vehicle.

(D) There is no flame, either on the catalyst or anywhere in the heater.

(E) The manufacturer has certified that the heater meets the requirements under paragraph (1)(2)(i) of this section by permanently marking the heater “MEETS DOT REQUIREMENTS FOR

CATALYTIC HEATERS USED WITH FLAMMABLE LIQUID AND GAS.”

(F) The heater is also marked “DO NOT LOAD INTO OR USE IN CARGO COMPARTMENTS CONTAINING FLAMMABLE LIQUID OR GAS IF FLAME IS VISIBLE ON CATALYST OR IN HEATER.”

(G) Heater requirements under §393.77 of this title are complied with.

(i) *Effective date for combustion heater requirements.* The requirements under paragraph (1)(2)(i) of this section govern as follows:

(A) Use of a heater manufactured after November 14, 1975, is governed by every requirement under (1)(2)(i) of this section;

(B) Use of a heater manufactured before November 15, 1975, is governed only by the requirements under (1)(2)(i) (A), (C), (D), (F) and (G) of this section until October 1, 1976; and

(C) Use of any heater after September 30, 1976, is governed by every requirement under paragraph (1)(2)(i) of this section.

(iii) *Restrictions on automatic cargo-space-heating temperature control devices.* Restrictions on these devices have two dimensions: Restrictions upon use and restrictions which apply when the device must not be used.

(A) *Use restrictions.* An automatic cargo-space-heating temperature control device may be used when transporting Class 3 (flammable liquid) or Division 2.1 (flammable gas) materials only if each of the following requirements is met:

(1) Electrical apparatus in the cargo compartment is nonsparking or explosion proof.

(2) There is no combustion apparatus in the cargo compartment.

(3) There is no connection for return of air from the cargo compartment to the combustion apparatus.

(4) The heating system will not heat any part of the cargo to more than 54 °C (129 °F).

(5) Heater requirements under §393.77 of this title are complied with.

(B) *Protection against use.* Class 3 (flammable liquid) or Division 2.1 (flammable gas) materials may be transported by a vehicle, which is equipped with an automatic cargo-

space-heating temperature control device that does not meet each requirement of paragraph (1)(2)(iii)(A) of this section, only if the device is first rendered inoperable, as follows:

(1) Each cargo heater fuel tank, if other than LPG, must be emptied or removed.

(2) Each LPG fuel tank for automatic temperature control equipment must have its discharge valve closed and its fuel feed line disconnected.

(m) Tanks constructed and maintained in compliance with Spec. 106A or 110A (§§179.300, 179.301 of this subchapter) that are authorized for the shipment of hazardous materials by highway in part 173 of this subchapter must be carried in accordance with the following requirements:

(1) Tanks must be securely chocked or clamped on vehicles to prevent any shifting.

(2) Equipment suitable for handling a tank must be provided at any point where a tank is to be loaded upon or removed from a vehicle.

(3) No more than two cargo carrying vehicles may be in the same combination of vehicles.

(4) Compliance with §§174.200 and 174.204 of this subchapter for combination rail freight, highway shipments and for trailer-on-flat-car service is required.

(n) Specification 56, 57, IM 101, and IM 102 portable tanks, when loaded, may not be stacked on each other nor placed under other freight during transportation by motor vehicle.

(o) *Unloading of IM and UN portable tanks.* No person may unload an IM or UN portable tank while it remains on a transport vehicle with the motive power unit attached except under the following conditions:

(1) The unloading operation must be attended by a qualified person in accordance with the requirements in paragraph (i) of this section. The person performing unloading functions must be trained in handling emergencies that may occur during the unloading operation.

(2) Prior to unloading, the operator of the vehicle on which the portable tank is transported must ascertain that the conditions of this paragraph (o) are met.

(3) An IM or UN portable tank equipped with a bottom outlet as authorized in Column (7) of the §172.101 Table of this subchapter by assignment of a T Code in the appropriate proper shipping name entry, and that contains a liquid hazardous material of Class 3, PG I or II, or PG III with a flash point of less than 100 °F (38 °C); Division 5.1, PG I or II; or Division 6.1, PG I or II, must conform to the outlet requirements in §178.275(d)(3) of this subchapter.

[29 FR 18795, Dec. 29, 1964. Redesignated at 32 FR 5606, Apr. 5, 1967]

EDITORIAL NOTE: For FEDERAL REGISTER citations affecting §177.834, see the List of CFR Sections Affected, which appears in the Finding Aids section of the printed volume and at www.fdsys.gov.

§ 177.835 Class 1 materials.

(See also §177.834 (a) to (j).)

(a) *Engine stopped.* No Class 1 (explosive) materials shall be loaded into or on or be unloaded from any motor vehicle with the engine running.

(b) *Care in loading, unloading, or other handling of Class 1 (explosive) materials.* No bale hooks or other metal tools shall be used for the loading, unloading, or other handling of Class 1 (explosive) materials, nor shall any package or other container of Class 1 (explosive) materials, except barrels or kegs, be rolled. No packages of Class 1 (explosive) materials shall be thrown or dropped during process of loading or unloading or handling of Class 1 (explosive) materials. Special care shall be exercised to the end that packages or other containers containing Class 1 (explosive) materials shall not catch fire from sparks or hot gases from the exhaust tailpipe.

(1) Whenever tarpaulins are used for covering Class 1 (explosive) materials, they shall be secured by means of rope, wire, or other equally efficient tie downs. Class 1 (explosive) materials placards or markings required by §177.823 shall be secured, in the appropriate locations, directly to the equipment transporting the Class 1 (explosive) materials. If the vehicle is provided with placard boards, the placards must be applied to these boards.

(2) [Reserved]

(c) *Class 1 (explosive) materials on vehicles in combination.* Division 1.1 or 1.2 (explosive) materials may not be loaded into or carried on any vehicle or a combination of vehicles if:

(1) More than two cargo carrying vehicles are in the combination;

(2) Any full trailer in the combination has a wheel base of less than 184 inches;

(3) Any vehicle in the combination is a cargo tank which is required to be marked or placarded under §177.823; or

(4) The other vehicle in the combination contains any:

(i) Substances, explosive, n.o.s., Division 1.1A (explosive) material (Initiating explosive),

(ii) Packages of Class 7 (radioactive) materials bearing “Yellow III” labels,

(iii) Division 2.3, Hazard Zone A or Hazard Zone B materials or Division 6.1, PG I, Hazard Zone A materials, or

(iv) Hazardous materials in a portable tank or a DOT specification 106A or 110A tank.

(d) [Reserved]

(e) *No sharp projections inside body of vehicles.* No motor vehicle transporting any kind of Class 1 (explosive) material shall have on the interior of the body in which the Class 1 (explosive) materials are contained, any inwardly projecting bolts, screws, nails, or other inwardly projecting parts likely to produce damage to any package or container of Class 1 (explosive) materials during the loading or unloading process or in transit.

(f) *Class 1 (explosive) materials vehicles, floors tight and lined.* Motor vehicles transporting Division 1.1, 1.2, or 1.3 (explosive) materials shall have tight floors; shall have that portion of the interior in contact with the load lined with either non-metallic material or non-ferrous metals, except that the lining is not required for truck load shipments loaded by the Departments of the Army, Navy or Air Force of the United States Government provided the Class 1 (explosive) materials are of such nature that they are not liable to leakage of dust, powder, or vapor which might become the cause of an explosion. The interior of the cargo space must be in good condition so that there will not be any likelihood of containers being damaged by exposed bolts, nuts,

broken side panels or floor boards, or any similar projections.

(g) No detonator assembly or booster with detonator may be transported on the same motor vehicle with any Division 1.1, 1.2 or 1.3 material (except other detonator assemblies, boosters with detonators or detonators), detonating cord Division 1.4 material or Division 1.5 material. No detonator may be transported on the same motor vehicle with any Division 1.1, 1.2 or 1.3 material (except other detonators, detonator assemblies or boosters with detonators), detonating cord Division 1.4 material or Division 1.5 material unless—

(1) It is packed in a specification MC 201 (§178.318 of this subchapter) container; or

(2) The package conforms with requirements prescribed in §173.62 of this subchapter, and its use is restricted to instances when—

(i) There is no Division 1.1, 1.2, 1.3 or 1.5 material loaded on the motor vehicle; and

(ii) A separation of 61 cm (24 inches) is maintained between each package of detonators and each package of detonating cord; or

(3) It is packed and loaded in accordance with a method approved by the Associate Administrator. One approved method requires that—

(i) The detonators are in packagings as prescribed in §173.63 of this subchapter which in turn are loaded into suitable containers or separate compartments; and

(ii) That both the detonators and the container or compartment meet the requirements of the IME Standard 22 (IBR, see §171.7 of this subchapter).

(h) *Lading within body or covered tailgate closed.* Except as provided in paragraph (g) of this section, dealing with the transportation of liquid nitroglycerin, desensitized liquid nitroglycerin or diethylene glycol dinitrate, all of that portion of the lading of any motor vehicle which consists of Class 1 (explosive) materials shall be contained entirely within the body of the motor vehicle or within the horizontal outline thereof, without overhang or projection of any part of the load and if such motor vehicle has a tailboard or tailgate, it shall be closed and secured in

place during such transportation. Every motor vehicle transporting Class 1 (explosive) materials must either have a closed body or have the body thereof covered with a tarpaulin, and in either event care must be taken to protect the load from moisture and sparks, except that subject to other provisions of these regulations, Class 1 (explosive) materials other than black powder may be transported on flat-bed vehicles if the explosive portion of the load on each vehicle is packed in fire and water resistant containers or covered with a fire and water resistant tarpaulin.

(i) *Class 1 (explosive) materials to be protected against damage by other lading.* No motor vehicle transporting any Class 1 (explosive) material may transport as a part of its load any metal or other articles or materials likely to damage such Class 1 (explosive) material or any package in which it is contained, unless the different parts of such load be so segregated or secured in place in or on the motor vehicle and separated by bulkheads or other suitable means as to prevent such damage.

(j) *Transfer of Class 1 (explosive) materials en route.* No Division 1.1, 1.2, or 1.3 (explosive) material shall be transferred from one container to another, or from one motor vehicle to another vehicle, or from another vehicle to a motor vehicle, on any public highway, street, or road, except in case of emergency. In such cases red electric lanterns, red emergency reflectors or red flags shall be set out in the manner prescribed for disabled or stopped motor vehicles. (See Motor Carrier Safety Regulations, part 392 of this title.) In any event, all practicable means, in addition to these hereinbefore prescribed, shall be taken to protect and warn other users of the highway against the hazard involved in any such transfer or against the hazard occasioned by the emergency making such transfer necessary.

(k) *Attendance of Class 1 (explosive) materials.* Division 1.1, 1.2, or 1.3 materials that are stored during transportation in commerce must be attended and afforded surveillance in accordance with 49 CFR 397.5. A safe haven that conforms to NFPA 498 (IBR, see §171.7 of the subchapter) constitutes a feder-

ally approved safe haven for the unattended storage of vehicles containing Division 1.1, 1.2, or 1.3 materials.

[29 FR 18795, Dec. 29, 1964. Redesignated at 32 FR 5606, Apr. 5, 1967]

EDITORIAL NOTE: For FEDERAL REGISTER citations affecting §177.835, see the List of CFR Sections Affected, which appears in the Finding Aids section of the printed volume and at www.fdsys.gov.

§ 177.837 Class 3 materials.

(See also §177.834 (a) to (j).)

(a) *Engine stopped.* Unless the engine of a cargo tank motor vehicle is to be used for the operation of a pump, Class 3 material may not be loaded into, or on, or unloaded from any cargo tank motor vehicle while the engine is running. The diesel engine of a cargo tank motor vehicle may be left running during the loading and unloading of a Class 3 material if the ambient atmospheric temperature is at or below -12°C (10°F).

(b) *Bonding and grounding containers other than cargo tanks prior to and during transfer of lading.* For containers which are not in metallic contact with each other, either metallic bonds or ground conductors shall be provided for the neutralization of possible static charges prior to and during transfers of Class 3 (flammable liquid) materials between such containers. Such bonding shall be made by first connecting an electric conductor to the container to be filled and subsequently connecting the conductor to the container from which the liquid is to come, and not in any other order. To provide against ignition of vapors by discharge of static electricity, the latter connection shall be made at a point well removed from the opening from which the Class 3 (flammable liquid) material is to be discharged.

(c) *Bonding and grounding cargo tanks before and during transfer of lading.* (1) When a cargo tank is loaded through an open filling hole, one end of a bond wire shall be connected to the stationary system piping or integrally connected steel framing, and the other end to the shell of the cargo tank to provide a continuous electrical connection. (If bonding is to the framing, it is essential that piping and framing be

electrically interconnected.) This connection must be made before any filling hole is opened, and must remain in place until after the last filling hole has been closed. Additional bond wires are not needed around All-Metal flexible or swivel joints, but are required for nonmetallic flexible connections in the stationary system piping. When a cargo tank is unloaded by a suction-piping system through an open filling hole of the cargo tank, electrical continuity shall be maintained from cargo tank to receiving tank.

(2) When a cargo tank is loaded or unloaded through a vapor-tight (not open hole) top or bottom connection, so that there is no release of vapor at a point where a spark could occur, bonding or grounding is not required. Contact of the closed connection must be made before flow starts and must not be broken until after the flow is completed.

(3) Bonding or grounding is not required when a cargo tank is unloaded through a nonvapor-tight connection into a stationary tank provided the metallic filling connection is maintained in contact with the filling hole.

(d) *Unloading combustible liquids.* For a cargo tank unloading a material meeting the definition for combustible liquid in §173.150(f) of this subchapter, the qualified person attending the unloading operation must remain within 45.72 meters (150 feet) of the cargo tank and 7.62 meters (25 feet) of the delivery hose and must observe both the cargo tank and the receiving container at least once every five minutes during unloading operations that take more than five minutes to complete.

[29 FR 18795, Dec. 29, 1964]

EDITORIAL NOTE: For FEDERAL REGISTER citations affecting §177.837, see the List of CFR Sections Affected, which appears in the Finding Aids section of the printed volume and at www.fdsys.gov.

§ 177.838 Class 4 (flammable solid) materials, Class 5 (oxidizing) materials, and Division 4.2 (pyroforic liquid) materials.

(See also §177.834 (a) to (j).)

(a) *Lading within body or covered; tailgate closed; pick-up and delivery.* All of that portion of the lading of any motor vehicle transporting Class 4 (flam-

mable solid) or Class 5 (oxidizing) materials shall be contained entirely within the body of the motor vehicle and shall be covered by such body, by tarpaulins, or other suitable means, and if such motor vehicle has a tailboard or tailgate, it shall be closed and secured in place during such transportation: *Provided, however,* That the provisions of this paragraph need not apply to “pick-up and delivery” motor vehicles when such motor vehicles are used in no other transportation than in and about cities, towns, or villages. Shipment in water-tight bulk containers need not be covered by a tarpaulin or other means.

(b) *Articles to be kept dry.* Special care shall be taken in the loading of any motor vehicle with Class 4 (flammable solid) or Class 5 (oxidizing) materials which are likely to become hazardous to transport when wet, to keep them from being wetted during the loading process and to keep them dry during transit. Special care shall also be taken in the loading of any motor vehicle with Class 4 (flammable solid) or Class 5 (oxidizing) materials, which are likely to become more hazardous to transport by wetting, to keep them from being wetted during the loading process and to keep them dry during transit. Examples of such dangerous materials are charcoal screenings, ground, crushed, or pulverized charcoal, and lump charcoal.

(c) *Lading ventilation, precautions against spontaneous combustion.* Whenever a motor carrier has knowledge concerning the hazards of spontaneous combustion or heating of any article to be loaded on a motor vehicle, such article shall be so loaded as to afford sufficient ventilation of the load to provide reasonable assurance against fire from this cause; and in such a case the motor vehicle shall be unloaded as soon as practicable after reaching its destination. Charcoal screenings, or ground, crushed, granulated, or pulverized charcoal, in bags, shall be so loaded that the bags are laid horizontally in the motor vehicle, and so piled that there will be spaces for effective air circulation, which spaces shall not be less than 10 cm (3.9 inches) wide; and air spaces shall be maintained between rows of bags. Bags shall not be piled

closer than 15 cm (5.9 inches) from the top of any motor vehicle with a closed body.

(d)-(e) [Reserved]

(f) Nitrates, except ammonium nitrate having organic coating, must be loaded in closed or open type motor vehicles, which must be swept clean and be free of any projections capable of injuring bags when so packaged. When shipped in open type motor vehicles, the lading must be suitably covered. Ammonium nitrate having organic coating must not be loaded in all-metal vehicles, other than those made of aluminum or aluminum alloys of the closed type.

(g) A motor vehicle may only contain 45.4 kg (100 pounds) or less net mass of material described as "Smokeless powder for small arms, Division 4.1".

(h) *Division 4.2 (pyrophoric liquid) materials in cylinders.* Cylinders containing Division 4.2 (pyrophoric liquid) materials, unless packed in a strong box or case and secured therein to protect valves, must be loaded with all valves and safety relief devices in the vapor space. All cylinders must be secured so that no shifting occurs in transit.

[29 FR 18795, Dec. 29, 1964. Redesignated at 32 FR 5606, Apr. 5, 1967]

EDITORIAL NOTE: For FEDERAL REGISTER citations affecting § 177.838, see the List of CFR Sections Affected, which appears in the Finding Aids section of the printed volume and at www.fdsys.gov.

§ 177.839 Class 8 (corrosive) materials.

(See also § 177.834(a) through (j).)

(a) *Nitric acid.* No packaging of nitric acid of 50 percent or greater concentration may be loaded above any packaging containing any other kind of material.

(b) *Storage batteries.* All storage batteries containing any electrolyte must be so loaded, if loaded with other lading, that all such batteries will be protected against other lading falling onto or against them, and adequate means must be provided in all cases for the protection and insulation of battery terminals against short circuits.

[Amdt. 177-87, 61 FR 27175, May 30, 1996]

§ 177.840 Class 2 (gases) materials.

(See also § 177.834 (a) to (j).)

(a) *Floors or platforms essentially flat.* Cylinders containing Class 2 (gases) materials shall not be loaded onto any part of the floor or platform of any motor vehicle which is not essentially flat; cylinders containing Class 2 (gases) materials may be loaded onto any motor vehicle not having a floor or platform only if such motor vehicle be equipped with suitable racks having adequate means for securing such cylinders in place therein. Nothing contained in this section shall be so construed as to prohibit the loading of such cylinders on any motor vehicle having a floor or platform and racks as hereinbefore described.

(1) *Cylinders.* Cylinders containing Class 2 gases must be securely restrained in an upright or horizontal position, loaded in racks, or packed in boxes or crates to prevent the cylinders from being shifted, overturned or ejected from the motor vehicle under normal transportation conditions. A pressure relief device, when installed, must be in communication with the vapor space of a cylinder containing a Division 2.1 (flammable gas) material.

(2) *Cylinders for hydrogen, cryogenic liquid.* A Specification DOT-4L cylinder containing hydrogen, cryogenic liquid may only be transported on a motor vehicle as follows:

(i) The vehicle must have an open body equipped with a suitable rack or support having a means to hold the cylinder upright when subjected to an acceleration of 2 "g" in any horizontal direction;

(ii) The combined total of the hydrogen venting rates, as marked, on the cylinders transported on one motor vehicle may not exceed 60 SCF per hour;

(iii) The vehicle may not enter a tunnel; and

(iv) Highway transportation is limited to private and contract carriage and to direct movement from point of origin to destination.

(b) Portable tank containers containing Class 2 (gases) materials shall be loaded on motor vehicles only as follows:

(1) Onto a flat floor or platform of a motor vehicle.

(2) Onto a suitable frame of a motor vehicle.

(3) In either such case, such containers shall be safely and securely blocked or held down to prevent shifting relative to each other or to the supporting structure when in transit, particularly during sudden starts and stops and changes of direction of the vehicle.

(4) Requirements of paragraphs (1) and (2) of this paragraph (b) shall not be construed as prohibiting stacking of containers provided the provisions of paragraph (3) of this paragraph (b) are fully complied with.

(c) [Reserved]

(d) *Engine to be stopped in cargo tank motor vehicles, except for transfer pump.* No Division 2.1 (flammable gas) material shall be loaded into or on or unloaded from any cargo tank motor vehicles with the engine running unless the engine is used for the operation of the transfer pump of the vehicle. Unless the delivery hose is equipped with a shut-off valve at its discharge end, the engine of the motor vehicle shall be stopped at the finish of such loading or unloading operation while the filling or discharge connections are disconnected.

(e) Chlorine cargo tank motor vehicles shall be shipped only when equipped:

(1) With a gas mask of a type approved by the National Institute of Occupational Safety and Health (NIOSH) Pittsburgh Research Center, U.S. Department of Health and Human Services for chlorine service; and

(2) With an emergency kit for controlling leaks in fittings on the dome cover plate.

(f) A cargo tank motor vehicle used for transportation of chlorine may not be moved, coupled or uncoupled, when any loading or unloading connections are attached to the vehicle, nor may it be left without the power unit attached unless the vehicle is chocked or equivalent means are provided to prevent motion. For additional requirements, see §173.315(o) of this subchapter.

(g) Each liquid discharge valve on a cargo tank motor vehicle, other than an engine fuel line valve, must be closed during transportation except during loading and unloading.

(h) The driver of a motor vehicle transporting a Division 2.1 (flammable

gas) material that is a cryogenic liquid in a package exceeding 450 L (119 gallons) of water capacity shall avoid unnecessary delays during transportation. If unforeseen conditions cause an excessive pressure rise, the driver shall manually vent the tank at a remote and safe location. For each shipment, the driver shall make a written record of the cargo tank pressure and ambient (outside) temperature:

(1) At the start of each trip,

(2) Immediately before and after any manual venting,

(3) At least once every five hours, and

(4) At the destination point.

(i) No person may transport a Division 2.1 (flammable gas) material that is a cryogenic liquid in a cargo tank motor vehicle unless the pressure of the lading is equal to or less than that used to determine the marked rated holding time (MRHT) and the one-way travel time (OWTT), marked on the cargo tank in conformance with §173.318(g) of this subchapter, is equal to or greater than the elapsed time between the start and termination of travel. This prohibition does not apply if, prior to expiration of the OWTT, the cargo tank is brought to full equilibration as specified in paragraph (j) of this section.

(j) Full equilibration of a cargo tank transporting a Division 2.1 (flammable gas) material that is a cryogenic liquid may only be done at a facility that loads or unloads a Division 2.1 (flammable gas) material that is a cryogenic liquid and must be performed and verified as follows:

(1) The temperature and pressure of the liquid must be reduced by a manually controlled release of vapor; and

(2) The pressure in the cargo tank must be measured at least ten minutes after the manual release is terminated.

(k) A carrier of carbon monoxide, cryogenic liquid must provide each driver with a self-contained air breathing apparatus that is approved by the National Institute of Occupational Safety and Health; for example, Mine Safety Appliance Co., Model 401, catalog number 461704.

(l) *Operating procedure.* Each operator of a cargo tank motor vehicle that is subject to the emergency discharge control requirements in §173.315(n) of

this subchapter must carry on or within the cargo tank motor vehicle written emergency discharge control procedures for all delivery operations. The procedures must describe the cargo tank motor vehicle's emergency discharge control features and, for a passive shut-down capability, the parameters within which they are designed to function. The procedures must describe the process to be followed if a facility-provided hose is used for unloading when the cargo tank motor vehicle has a specially equipped delivery hose assembly to meet the requirements of §173.315(n)(2) of this subchapter.

(m) *Cargo tank motor vehicle safety check.* Before unloading from a cargo tank motor vehicle containing a liquefied compressed gas, the qualified person performing the function must check those components of the discharge system, including delivery hose assemblies and piping, that are readily observed during the normal course of unloading to assure that they are of sound quality, without obvious defects detectable through visual observation and audio awareness, and that connections are secure. This check must be made after the pressure in the discharge system has reached at least equilibrium with the pressure in the cargo tank. Operators need not use instruments or take extraordinary actions to check components not readily visible. No operator may unload liquefied compressed gases from a cargo tank motor vehicle with a delivery hose assembly found to have any condition identified in §180.416(g)(1) of this subchapter or with piping systems found to have any condition identified in §180.416(g)(2) of this subchapter.

(n) *Emergency shut down.* If there is an unintentional release of product to the environment during unloading of a liquefied compressed gas, the qualified person unloading the cargo tank motor vehicle must promptly shut the internal self-closing stop valve or other primary means of closure and shut down all motive and auxiliary power equipment.

(o) *Daily test of off-truck remote shut-off activation device.* For a cargo tank motor vehicle equipped with an off-truck remote means to close the internal self-closing stop valve and shut off

all motive and auxiliary power equipment, an operator must successfully test the activation device within 18 hours prior to the first delivery of each day. For a wireless transmitter/receiver, the person conducting the test must be at least 45.72 m (150 feet) from the cargo tank and may have the cargo tank in his line of sight.

(p) *Unloading procedures for liquefied petroleum gas and anhydrous ammonia in metered delivery service.* An operator must use the following procedures for unloading liquefied petroleum gas or anhydrous ammonia from a cargo tank motor vehicle in metered delivery service:

(1) For a cargo tank with a capacity of 13,247.5 L (3,500 water gallons) or less, excluding delivery hose and piping, the qualified person attending the unloading operation must remain within 45.72 meters (150 feet) of the cargo tank and 7.62 meters (25 feet) of the delivery hose and must observe both the cargo tank and the receiving container at least once every five minutes when the internal self-closing stop valve is open during unloading operations that take more than five minutes to complete.

(2) For a cargo tank with a capacity greater than 13,247.5 L (3,500 water gallons), excluding delivery hose and piping, the qualified person attending the unloading operation must remain within 45.72 m (150 feet) of the cargo tank and 7.62 m (25 feet) of the delivery hose when the internal self-closing stop valve is open.

(i) Except as provided in paragraph (p)(2)(ii) of this section, the qualified person attending the unloading operation must have an unobstructed view of the cargo tank and delivery hose to the maximum extent practicable, except during short periods when it is necessary to activate controls or monitor the receiving container.

(ii) For deliveries where the qualified person attending the unloading operation cannot maintain an unobstructed view of the cargo tank, when the internal self-closing stop valve is open, the qualified person must observe both the cargo tank and the receiving container at least once every five minutes during unloading operations that take more

than five minutes to complete. In addition, by the compliance dates specified in §§ 173.315(n)(5) and 180.405(m)(3) of this subchapter, the cargo tank motor vehicle must have an emergency discharge control capability that meets the requirements of § 173.315(n)(2) or § 173.315(n)(4) of this subchapter.

(q) *Unloading procedures for liquefied petroleum gas and anhydrous ammonia in other than metered delivery service.* An operator must use the following procedures for unloading liquefied petroleum gas or anhydrous ammonia from a cargo tank motor vehicle in other than metered delivery service:

(1) The qualified person attending the unloading operation must remain within 7.62 m (25 feet) of the cargo tank when the internal self-closing stop valve is open.

(2) The qualified person attending the unloading operation must have an unobstructed view of the cargo tank and delivery hose to the maximum extent practicable, except during short periods when it is necessary to activate controls or monitor the receiving container.

(r) *Unloading using facility-provided hoses.* A cargo tank motor vehicle equipped with a specially designed delivery hose assembly to meet the requirements of § 173.315(n)(2) of this subchapter may be unloaded using a delivery hose assembly provided by the receiving facility under the following conditions:

(1) The qualified person monitoring unloading must visually examine the facility hose assembly for obvious defects prior to its use in the unloading operation.

(2) The qualified person monitoring unloading must remain within arm's reach of the mechanical means of closure for the internal self-closing stop valve when the internal self-closing stop valve is open except for short periods when it is necessary to activate controls or monitor the receiving container. For chlorine cargo tank motor vehicles, the qualified person must remain within arm's reach of a means to stop the flow of product except for short periods when it is necessary to activate controls or monitor the receiving container.

(3) If the facility hose is equipped with a passive means to shut off the flow of product that conforms to and is maintained to the performance standard in § 173.315(n)(2) of this subchapter, the qualified person may attend the unloading operation in accordance with the attendance requirements prescribed for the material being unloaded in § 177.834 of this section.

(s) *Off-truck remote shut-off activation device.* For a cargo tank motor vehicle with an off-truck remote control shut-off capability as required by § 173.315(n)(3) or (n)(4) of this subchapter, the qualified person attending the unloading operation must be in possession of the activation device at all times during the unloading process. This requirement does not apply if the activation device is part of a system that will shut off the unloading operation without human intervention in the event of a leak or separation in the hose.

(t) *Unloading without appropriate emergency discharge control equipment.* Until a cargo tank motor vehicle is equipped with emergency discharge control equipment in conformance with §§ 173.315(n)(2) and 180.405(m)(1) of this subchapter, the qualified person attending the unloading operation must remain within arm's reach of a means to close the internal self-closing stop valve when the internal self-closing stop valve is open except during short periods when the qualified person must activate controls or monitor the receiving container. For chlorine cargo tank motor vehicles unloaded after December 31, 1999, the qualified person must remain within arm's reach of a means to stop the flow of product except for short periods when it is necessary to activate controls or monitor the receiving container.

(u) *Unloading of chlorine cargo tank motor vehicles.* Unloading of chlorine from a cargo tank motor vehicle must be performed in compliance with Section 3 of the Chlorine Institute Pamphlet 57, "Emergency Shut-off Systems for Bulk Transfer of Chlorine" (IBR, see § 171.7 of this subchapter).

(Approved by the Office of Management and Budget under control number 2137-0542)

[29 FR 18795, Dec. 29, 1964. Redesignated at 32 FR 5606, Apr. 5, 1967]

EDITORIAL NOTE: For FEDERAL REGISTER citations affecting § 177.840, see the List of CFR Sections Affected, which appears in the Finding Aids section of the printed volume and at www.fdsys.gov.

§ 177.841 Division 6.1 and Division 2.3 materials.

(See also § 177.834 (a) to (j).)

(a) *Arsenical compounds in bulk.* Care shall be exercised in the loading and unloading of “arsenical dust”, “arsenic trioxide”, and “sodium arsenate”, allowable to be loaded into sift-proof, steel hopper-type or dump-type motor-vehicle bodies equipped with waterproof, dust-proof covers well secured in place on all openings, to accomplish such loading with the minimum spread of such compounds into the atmosphere by all means that are practicable; and no such loading or unloading shall be done near or adjacent to any place where there are or are likely to be, during the loading or unloading process assemblages of persons other than those engaged in the loading or unloading process, or upon any public highway or in any public place. Before any motor vehicle may be used for transporting any other articles, all detectable traces of arsenical materials must be removed therefrom by flushing with water, or by other appropriate method, and the marking removed.

(b) [Reserved]

(c) *Division 2.3 (poisonous gas) or Division 6.1 (poisonous) materials.* The transportation of a Division 2.3 (poisonous gas) or Division 6.1 (poisonous) material is not permitted if there is any interconnection between packagings.

(d) [Reserved]

(e) A motor carrier may not transport a package:

(1) Except as provided in paragraph (e)(3) of this section, bearing or required to bear a POISON or POISON INHALATION HAZARD label or placard in the same motor vehicle with material that is marked as or known to be foodstuffs, feed or edible material intended for consumption by humans or animals unless the poisonous material is packaged in accordance with this subchapter and is:

(i) Overpacked in a metal drum as specified in § 173.25(c) of this subchapter; or

(ii) Loaded into a closed unit load device and the foodstuffs, feed, or other edible material are loaded into another closed unit load device;

(2) Bearing or required to bear a POISON, POISON GAS or POISON INHALATION HAZARD label in the driver's compartment (including a sleeper berth) of a motor vehicle; or

(3) Bearing a POISON label displaying the text “PG III,” or bearing a “PG III” mark adjacent to the POISON label, with materials marked as, or known to be, foodstuffs, feed or any other edible material intended for consumption by humans or animals, unless the package containing the Division 6.1, Packing Group III material is separated in a manner that, in the event of leakage from packages under conditions normally incident to transportation, commingling of hazardous materials with foodstuffs, feed or any other edible material would not occur.

[29 FR 18795, Dec. 29, 1964]

EDITORIAL NOTE: For FEDERAL REGISTER citations affecting § 177.841, see the List of CFR Sections Affected, which appears in the Finding Aids section of the printed volume and at www.fdsys.gov.

§ 177.842 Class 7 (radioactive) material.

(a) The number of packages of Class 7 (radioactive) materials in any transport vehicle or in any single group in any storage location must be limited so that the total transport index number does not exceed 50. The total transport index of a group of packages and overpacks is determined by adding together the transport index number on the labels on the individual packages and overpacks in the group. This provision does not apply to exclusive use shipments described in §§ 173.441(b), 173.457, and 173.427 of this subchapter.

(b) Packages of Class 7 (radioactive) material bearing “RADIOACTIVE YELLOW-II” or “RADIOACTIVE YELLOW-III” labels may not be placed in a transport vehicle, storage location or in any other place closer than the distances shown in the following table to any area which may be continuously occupied by any passenger, employee, or animal, nor closer than the distances shown in the table to any package containing undeveloped film (if so

§ 177.843

49 CFR Ch. I (10–1–14 Edition)

marked), and must conform to the following conditions:

(1) If more than one of these packages is present, the distance must be computed from the following table on the basis of the total transport index number determined by adding together the transport index number on the labels on the individual packages and overpacks in the vehicle or storeroom.

(2) Where more than one group of packages is present in any single storage location, a single group may not have a total transport index greater than 50. Each group of packages must be handled and stowed not closer than 6 m (20 feet) (measured edge to edge) to any other group. The following table is to be used in accordance with the provisions of paragraph (b) of this section:

Total transport index	Minimum separation distance in meters (feet) to nearest undeveloped film in various times of transit					Minimum distance in meters (feet) to area of persons, or minimum distance in meters (feet) from dividing partition of cargo compartments
	Up to 2 hours	2–4 hours	4–8 hours	8–12 hours	Over 12 hours	
None	0.0 (0)	0.0 (0)	0.0 (0)	0.0 (0)	0.0 (0)	0.0 (0)
0.1 to 1.0	0.3 (1)	0.6 (2)	0.9 (3)	1.2 (4)	1.5 (5)	0.3 (1)
1.1 to 5.0	0.9 (3)	1.2 (4)	1.8 (6)	2.4 (8)	3.4 (11)	0.6 (2)
5.1 to 10.0	1.2 (4)	1.8 (6)	2.7 (9)	3.4 (11)	4.6 (15)	0.9 (3)
10.1 to 20.0	1.5 (5)	2.4 (8)	3.7 (12)	4.9 (16)	6.7 (22)	1.2 (4)
20.1 to 30.0	2.1 (7)	3.0 (10)	4.6 (15)	6.1 (20)	8.8 (29)	1.5 (5)
30.1 to 40.0	2.4 (8)	3.4 (11)	5.2 (17)	6.7 (22)	10.1 (33)	1.8 (6)
40.1 to 50.0	2.7 (9)	3.7 (12)	5.8 (19)	7.3 (24)	11.0 (36)	2.1 (7)

NOTE: The distance in this table must be measured from the nearest point on the nearest packages of Class 7 (radioactive) material.

(c) Shipments of low specific activity materials and surface contaminated objects, as defined in §173.403 of this subchapter, must be loaded so as to avoid spillage and scattering of loose materials. Loading restrictions are set forth in §173.427 of this subchapter.

(d) Packages must be so blocked and braced that they cannot change position during conditions normally incident to transportation.

(e) Persons should not remain unnecessarily in a vehicle containing Class 7 (radioactive) materials.

(f) The number of packages of fissile Class 7 (radioactive) material in any non-exclusive use transport vehicle must be limited so that the sum of the criticality safety indices (CSIs) does not exceed 50. In loading and storage areas, fissile material packages must be grouped so that the sum of CSIs in any one group is not greater than 50; there may be more than one group of fissile material packages in a loading or storage area, so long as each group is at least 6 m (20 feet) away from all other such groups. All pertinent requirements of §§173.457 and 173.459 apply.

(g) For shipments transported under exclusive use conditions the radiation dose rate may not exceed 0.02 mSv per hour (2 mrem per hour) in any position normally occupied in the motor vehicle. For shipments transported as exclusive use under the provisions of §173.441(b) of this subchapter for packages with external radiation levels in excess of 2 mSv (200 mrem per hour) at the package surface, the motor vehicle must meet the requirements of a closed transport vehicle (see §173.403 of this subchapter). The sum of criticality safety indices (CSIs) for packages containing fissile material may not exceed 100 in an exclusive use vehicle.

[Amdt. 177–85, 60 FR 50334, Sept. 28, 1995, as amended at 63 FR 52850, Oct. 1, 1998; 66 FR 45385, Aug. 28, 2001; 69 FR 3696, Jan. 26, 2004]

§ 177.843 Contamination of vehicles.

(a) Each motor vehicle used for transporting Class 7 (radioactive) materials under exclusive use conditions in accordance with §173.427(b)(4), §173.427(c), or §173.443(b) of this subchapter must be surveyed with radiation detection instruments after each use. A vehicle may not be returned to

Class 7 (radioactive) materials exclusive use transport service, and then only for a subsequent exclusive use shipment utilizing the provisions of any of the paragraphs §173.427(b)(4), §173.427(c), or §173.443(b), until the radiation dose rate at every accessible surface is 0.005 mSv/h (0.5 mrem/h) or less and the non-fixed contamination is not greater than the level prescribed in §173.443(a) of this subchapter.

(b) This section does not apply to any vehicle used solely for transporting Class 7 (radioactive) material if a survey of the interior surface shows that the radiation dose rate does not exceed 0.1 mSv per hour (10 mrem per hour) at the interior surface or 0.02 mSv per hour (2 mrem per hour) at 1 meter (3.3 feet) from any interior surface. These vehicles must be stenciled with the words “For Radioactive Materials Use Only” in lettering at least 7.6 cm (3 inches) high in a conspicuous place, on both sides of the exterior of the vehicle. These vehicles must be kept closed at all times other than loading and unloading.

(c) In case of fire, accident, breakage, or unusual delay involving shipments of Class 7 (radioactive) material, see §§171.15, 171.16 and 177.854 of this subchapter.

(d) Each transport vehicle used to transport Division 6.2 materials must be disinfected prior to reuse if a Division 6.2 material is released from its packaging during transportation. Disinfection may be by any means effective for neutralizing the material released.

[Amdt. 177-3, 33 FR 14933, Oct. 4, 1968, as amended by Amdt. 177-35, 41 FR 16131, Apr. 15, 1976; Amdt. 177-57, 48 FR 10247, Mar. 10, 1983; Amdt. 177-78, 55 FR 52712, Dec. 21, 1990; Amdt. 177-85, 60 FR 50335, Sept. 28, 1995; 63 FR 52850, Oct. 1, 1998; 65 FR 58631, Sept. 29, 2000; 67 FR 53142, Aug. 14, 2002; 75 FR 53597, Sept. 1, 2010; 79 FR 40618, July 11, 2014]

Subpart C—Segregation and Separation Chart of Hazardous Materials

§ 177.848 Segregation of hazardous materials.

(a) This section applies to materials which meet one or more of the hazard classes defined in this subchapter and are:

(1) In packages that must be labeled or placarded in accordance with part 172 of this subchapter;

(2) In a compartment within a multi-compartmented cargo tank subject to the restrictions in §173.33 of this subchapter; or

(3) In a portable tank loaded in a transport vehicle or freight container.

(b) When a transport vehicle is to be transported by vessel, other than a ferry vessel, hazardous materials on or within that vehicle must be stowed and segregated in accordance with §176.83(b) of this subchapter.

(c) In addition to the provisions of paragraph (d) of this section and except as provided in §173.12(e) of this subchapter, cyanides, cyanide mixtures or solutions may not be stored, loaded and transported with acids if a mixture of the materials would generate hydrogen cyanide; Division 4.2 materials may not be stored, loaded and transported with Class 8 liquids; and Division 6.1 Packing Group I, Hazard Zone A material may not be stored, loaded and transported with Class 3 material, Class 8 liquids, and Division 4.1, 4.2, 4.3, 5.1 or 5.2 materials.

(d) Except as otherwise provided in this subchapter, hazardous materials must be stored, loaded or transported in accordance with the following table and other provisions of this section:

SEGREGATION TABLE FOR HAZARDOUS MATERIALS

Class or division	Notes	1.1 1.2	1.3	1.4	1.5	1.6	2.1	2.2	2.3 gas zone A	2.3 gas Zone B	3	4.1	4.2	4.3	5.1	5.2	6.1 liq- uids PG I zone A	7	8 liquids only
Explosives 1.1 and 1.2	A	*	*	*	*	*	X	X	X	X	X	X	X	X	X	X	X	X	X
Explosives 1.3		*	*	*	*	*	X	X	X	X	X	X	X	X	X	X	X	X	X
Explosives 1.4		*	*	*	*	*	O	O	O	O	O	O	O	O	O	O	O	O	O
Very insensitive explosives. 1.5	A	*	*	*	*	*	X	X	X	X	X	X	X	X	X	X	X	X	X
Extremely insensitive explosives. 1.6		*	*	*	*	*													
Flammable gases 2.1		X	X	O	X	X													
Non-toxic, non-flammable gases. 2.2		X	X	O	X	X													
Poisonous gas Zone A 2.3		X	X	O	X	X	X	X			X	X	X	X	X	X			X
Poisonous gas Zone B 2.3		X	X	O	X	X	O	O			X	X	X	X	X	O			O
Flammable liquids 3		X	X	O	X	X	X	X	X	O	X	X	X	X	X	X	X	X	X
Flammable solids 4.1		X	X	O	X	X	X	X	X	O	X	X	X	X	X	X	X	X	X
Spontaneously combustible materials. 4.2		X	X	O	X	X	X	X	X	O	X	X	X	X	X	X	X	X	X
Dangerous when wet materials. 4.3		X	X		X	X													
Oxidizers 5.1	A	X	X		X	X													
Organic peroxides 5.2		X	X		X	X													
Poisonous liquids PG I Zone A. 6.1		X	X	O	X	X	O	X	X	O	X	X	X	X	X	X	X	X	X
Radioactive materials ... 7		X	X		X	X													
Corrosive liquids 8		X	X	O	X	X	O	X	X	O	X	X	X	X	X	X	X	X	X

(e) Instructions for using the segregation table for hazardous materials are as follows:

(1) The absence of any hazard class or division or a blank space in the table indicates that no restrictions apply.

(2) The letter "X" in the table indicates that these materials may not be loaded, transported, or stored together in the same transport vehicle or storage facility during the course of transportation.

(3) The letter "O" in the table indicates that these materials may not be loaded, transported, or stored together in the same transport vehicle or storage facility during the course of transportation unless separated in a manner that, in the event of leakage from packages under conditions normally incident to transportation, commingling of hazardous materials would not occur. Notwithstanding the methods of separation employed, Class 8 (corrosive) liquids may not be loaded above or adjacent to Class 4 (flammable) or Class 5 (oxidizing) materials; except that shippers may load truckload shipments of such materials together when it is known that the mixture of contents would not cause a fire or a dangerous evolution of heat or gas.

(4) The "*" in the table indicates that segregation among different Class

1 (explosive) materials is governed by the compatibility table in paragraph (f) of this section.

(5) The note "A" in the second column of the table means that, notwithstanding the requirements of the letter "X", ammonium nitrate (UN 1942) and ammonium nitrate fertilizer may be loaded or stored with Division 1.1 (explosive) or Division 1.5 materials.

(6) When the §172.101 table or §172.402 of this subchapter requires a package to bear a subsidiary hazard label, segregation appropriate to the subsidiary hazard must be applied when that segregation is more restrictive than that required by the primary hazard. However, hazardous materials of the same class may be stowed together without regard to segregation required for any secondary hazard if the materials are not capable of reacting dangerously with each other and causing combustion or dangerous evolution of heat, evolution of flammable, poisonous, or asphyxiant gases, or formation of corrosive or unstable materials.

(f) Class 1 (explosive) materials shall not be loaded, transported, or stored together, except as provided in this section, and in accordance with the following table:

COMPATIBILITY TABLE FOR CLASS 1 (EXPLOSIVE) MATERIALS

Compatibility group	A	B	C	D	E	F	G	H	J	K	L	N	S
A		X	X	X	X	X	X	X	X	X	X	X	X
B	X		X	X	X ⁽⁴⁾	X	X	X	X	X	X	X	X ⁽⁴⁾
C	X	X			2	2	X	6	X	X	X	X	3
D	X	X ⁽⁴⁾	2			2	X	6	X	X	X	X	3
E	X	X	2	2		X	6	X	X	X	X	X	3
F	X	X	X	X	X		X	X	X	X	X	X	4/5
G	X	X	6	6	6	X		X	X	X	X	X	4/5
H	X	X	X	X	X	X	X		X	X	X	X	4/5
J	X	X	X	X	X	X	X	X		X	X	X	4/5
K	X	X	X	X	X	X	X	X	X		X	X	4/5
L	X	X	X	X	X	X	X	X	X	X		X	X
N	X	X	3	3	3	X	X	X	X	X	X		4/5
S	X	4/5	4/5	4/5	4/5	4/5	4/5	4/5	4/5	4/5	X	4/5	

(g) Instructions for using the compatibility table for Class 1 (explosive) materials are as follows:

(1) A blank space in the table indicates that no restrictions apply.

(2) The letter "X" in the table indicates that explosives of different compatibility groups may not be carried on the same transport vehicle.

(3) The numbers in the table mean the following:

(i) "1" means an explosive from compatibility group L shall only be carried on the same transport vehicle with an identical explosive.

(ii) "2" means any combination of explosives from compatibility groups C,

D, or E is assigned to compatibility group E.

(iii) “3” means any combination of explosives from compatibility groups C, D, or E with those in compatibility group N is assigned to compatibility group D.

(iv) “4” means see §177.835(g) when transporting detonators.

(v) “5” means Division 1.4S fireworks may not be loaded on the same transport vehicle with Division 1.1 or 1.2 (explosive) materials.

(vi) “6” means explosive articles in compatibility group G, other than fireworks and those requiring special handling, may be loaded, transported and stored with other explosive articles of compatibility groups C, D and E, provided that explosive substances (such as those not contained in articles) are not carried in the same transport vehicle.

(h) Except as provided in paragraph (i) of this section, explosives of the same compatibility group but of different divisions may be transported together provided that the whole shipment is transported as though its entire contents were of the lower numerical division (i.e., Division 1.1 being lower than Division 1.2). For example, a mixed shipment of Division 1.2 (explosive) materials and Division 1.4 (explosive) materials, both of compatibility group D, must be transported as Division 1.2 (explosive) materials.

(i) When Division 1.5 materials, compatibility group D, are transported in the same freight container as Division 1.2 (explosive) materials, compatibility group D, the shipment must be transported as Division 1.1 (explosive) materials, compatibility group D.

[Amdt. 177–78, 55 FR 52712, Dec. 21, 1990]

EDITORIAL NOTE: For FEDERAL REGISTER citations affecting §177.848, see the List of CFR Sections Affected, which appears in the Finding Aids section of the printed volume and at www.fdsys.gov.

Subpart D—Vehicles and Shipments in Transit; Accidents

§ 177.854 Disabled vehicles and broken or leaking packages; repairs.

(a) *Care of lading, hazardous materials.* Whenever for any cause other than necessary traffic stops any motor vehicle

transporting any hazardous material is stopped upon the traveled portion of any highway or shoulder thereof, special care shall be taken to guard the vehicle and its load or to take such steps as may be necessary to provide against hazard. Special effort shall be made to remove the motor vehicle to a place where the hazards of the materials being transported may be provided against. See §§392.22, 392.24, and 392.25 of this title for warning devices required to be displayed on the highway.

(b) *Disposition of containers found broken or leaking in transit.* When leaks occur in packages or containers during the course of transportation, subsequent to initial loading, disposition of such package or container shall be made by the safest practical means afforded under paragraphs (c), (d), and (e) of this section.

(c) *Repairing or overpacking packages.* (1) Packages may be repaired when safe and practicable, such repairing to be in accordance with the best and safest practice known and available.

(2) Packages of hazardous materials that are damaged or found leaking during transportation, and hazardous materials that have spilled or leaked during transportation, may be forwarded to destination or returned to the shipper in a salvage drum in accordance with the requirements of §173.3(c) of this subchapter.

(d) *Transportation of repaired packages.* Any package repaired in accordance with the requirements of paragraph (c)(1) of this section may be transported to the nearest place at which it may safely be disposed of only in compliance with the following requirements:

(1) The package must be safe for transportation.

(2) The repair of the package must be adequate to prevent contamination of or hazardous admixture with other lading transported on the same motor vehicle therewith.

(3) If the carrier is not himself the shipper, the consignee’s name and address must be plainly marked on the repaired package.

(e) *Disposition of unsafe broken packages.* In the event any leaking package

or container cannot be safely and adequately repaired for transportation or transported, it shall be stored pending proper disposition in the safest and most expeditious manner possible.

(f) *Stopped vehicles; other dangerous articles.* Whenever any motor vehicle transporting Class 3 (flammable liquid), Class 4 (flammable solid), Class 5 (oxidizing), Class 8 (corrosive), Class 2 (gases), or Division 6.1 (poisonous) materials, is stopped for any cause other than necessary traffic stops upon the traveled portion of any highway, or a shoulder next thereto, the following requirements shall be complied with during the period of such stop:

(1) For motor vehicles other than cargo tank motor vehicles used for the transportation of Class 3 (flammable liquid) or Division 2.1 (flammable gas) materials and not transporting Division 1.1, 1.2, or 1.3 (explosive) materials, warning devices must be set out in the manner prescribed in §392.22 of this title.

(2) For cargo tanks used for the transportation of Class 3 (flammable liquid) or Division 2.1 (flammable gas) materials, whether loaded or empty, and vehicles transporting Division 1.1, 1.2, or 1.3 (explosive) materials, warning devices must be set out in the manner prescribed by §392.25 of this title.

(g) *Repair and maintenance of vehicles containing certain hazardous materials—*

(1) *General.* No person may use heat, flame or spark producing devices to repair or maintain the cargo or fuel containment system of a motor vehicle required to be placarded, other than COMBUSTIBLE, in accordance with subpart F of part 172 of this subchapter. As used in this section, "containment system" includes all vehicle components intended physically to contain cargo or fuel during loading or filling, transport, or unloading.

(2) *Repair and maintenance inside a building.* No person may perform repair or maintenance on a motor vehicle subject to paragraph (g)(1) of this section inside a building unless:

(i) The motor vehicle's cargo and fuel containment systems are closed (except as necessary to maintain or repair the vehicle's motor) and do not show any indication of leakage;

(ii) A means is provided, and a person capable of operate the motor vehicle is available, to immediately remove the motor vehicle if necessary in an emergency;

(iii) The motor vehicle is removed from the enclosed area upon completion of repair or maintenance work; and

(iv) For motor vehicles loaded with Division 1.1, 1.2, or 1.3 (explosive), Class 3 (flammable liquid), or Division 2.1 (flammable gas) materials, all sources of spark, flame or glowing heat within the area of enclosure (including any heating system drawing air therefrom) are extinguished, made inoperable or rendered explosion-proof by a suitable method. *Exception:* Electrical equipment on the vehicle, necessary to accomplish the maintenance function, may remain operational.

(h) *No repair with flame unless gas-free.* No repair of a cargo tank used for the transportation of any Class 3 (flammable liquid) or Division 6.1 (poisonous liquid) material, or any compartment thereof, or of any container for fuel of whatever nature, may be repaired by any method employing a flame, arc, or other means of welding, unless the tank or compartment shall first have been made gas-free.

[29 FR 18795, Dec. 29, 1964. Redesignated at 32 FR 5606, Apr. 5, 1967]

EDITORIAL NOTE: For FEDERAL REGISTER citations affecting §177.854, see the List of CFR Sections Affected, which appears in the Finding Aids section of the printed volume and at www.fdsys.gov.

Subpart E—Regulations Applying to Hazardous Material on Motor Vehicles Carrying Passengers for Hire

§ 177.870 Regulations for passenger carrying vehicles.

(a) *Vehicles transporting passengers and property.* In addition to the regulations in parts 170–189 of this subchapter the following requirements shall apply to vehicles transporting passengers and property.

(b) *No Class 1 (explosive) materials or other hazardous materials on passenger-carrying vehicles, exceptions.* No hazardous materials except small-arms

ammunition, emergency shipments of drugs, chemicals and hospital supplies, and the accompanying munitions of war of the Departments of the Army, Navy, and Air Force of the United States Government, are authorized by parts 170–189 of this subchapter to be transported on motor vehicles carrying passengers for hire where other practicable means of transportation is available.

(c) *Class 1 (explosive) materials in passenger-carrying space forbidden.* No Class 1 (explosive) material, except small-arms ammunition, may be carried in the passenger-carrying space of any motor vehicle transporting passengers for hire.

(d) *Hazardous materials on passenger carrying vehicles; quantity.* Where no other practicable means of transportation is available the following articles in the quantities as shown may be transported in motor vehicles carrying passengers for hire in a space other than that provided for passengers: Not to exceed 45 kg (99 pounds) gross weight of any or all of the kinds of Class 1 (explosive) materials permitted to be transported by passenger-carrying aircraft or rail car may be transported on a motor vehicle transporting passengers: *Provided, however,* That samples of Class 1 (explosive) materials for laboratory examination, not to exceed two samples, or a total of no more than 100 detonators, Division 1.4 (explosive) materials at one time in a single motor vehicle, may be transported in a motor vehicle transporting passengers.

(e) *Articles other than Class 1 (explosive) materials on passenger-carrying vehicles.* The gross weight of any given class of hazardous material other than Class 1 (explosive) materials shall not exceed 45 kg (99 pounds), and the aggregate weight of all such other dangerous articles shall not exceed 225 kg (496

pounds). This provision does not apply to nontoxic, nonflammable refrigerants, when such refrigerant is for servicing operations of a motor carrier on whose motor vehicles the refrigerant is used. A cylinder secured against shifting while in transit and not exceeding 113 kg (250 pounds) gross weight may be transported.

(f) *Division 6.1 (poisonous) or Division 2.3 (poisonous gas) materials on passenger-carrying vehicles.* No motor carrier may transport any extremely dangerous Division 6.1 (poisonous) or Division 2.3 (poisonous gas) material, or any paranitroaniline, in any amount, in or on any bus while engaged in the transportation of passengers; or any less dangerous Division 6.1 (poisonous) material, which is other than a liquid, in any amount exceeding an aggregate of 45 kg (99 pounds) gross weight in or on any such bus.

(g) *Class 7 (radioactive) materials.* In addition to the limitations prescribed in paragraphs (b) and (e) of this section, no person may transport any Class 7 (radioactive) material requiring labels under §§172.436, 172.438, and 172.440 of this subchapter in or on any motor vehicle carrying passengers for hire except where no other practicable means of transportation is available. Packages of Class 7 (radioactive) materials must be stored only in the trunk or baggage compartment of the vehicle, and must not be stored in any compartment occupied by persons. Packages of Class 7 (radioactive) materials must be handled and placed in the vehicle as prescribed in §177.842.

[29 FR 18795, Dec. 29, 1964. Redesignated at 32 FR 5606, Apr. 5, 1967]

EDITORIAL NOTE: For FEDERAL REGISTER citations affecting §177.870 see the List of CFR Sections Affected, which appears in the Finding Aids section of the printed volume and at www.fdsys.gov.

FINDING AIDS

A list of CFR titles, subtitles, chapters, subchapters and parts and an alphabetical list of agencies publishing in the CFR are included in the CFR Index and Finding Aids volume to the Code of Federal Regulations which is published separately and revised annually.

Table of CFR Titles and Chapters
Alphabetical List of Agencies Appearing in the CFR
List of CFR Sections Affected

Table of CFR Titles and Chapters

(Revised as of October 1, 2014)

Title 1—General Provisions

- I Administrative Committee of the Federal Register (Parts 1—49)
- II Office of the Federal Register (Parts 50—299)
- III Administrative Conference of the United States (Parts 300—399)
- IV Miscellaneous Agencies (Parts 400—500)

Title 2—Grants and Agreements

- SUBTITLE A—OFFICE OF MANAGEMENT AND BUDGET GUIDANCE FOR GRANTS AND AGREEMENTS
 - I Office of Management and Budget Governmentwide Guidance for Grants and Agreements (Parts 2—199)
 - II Office of Management and Budget Guidance (Parts 200—299)
- SUBTITLE B—FEDERAL AGENCY REGULATIONS FOR GRANTS AND AGREEMENTS
 - III Department of Health and Human Services (Parts 300—399)
 - IV Department of Agriculture (Parts 400—499)
 - VI Department of State (Parts 600—699)
 - VII Agency for International Development (Parts 700—799)
 - VIII Department of Veterans Affairs (Parts 800—899)
 - IX Department of Energy (Parts 900—999)
 - XI Department of Defense (Parts 1100—1199)
 - XII Department of Transportation (Parts 1200—1299)
 - XIII Department of Commerce (Parts 1300—1399)
 - XIV Department of the Interior (Parts 1400—1499)
 - XV Environmental Protection Agency (Parts 1500—1599)
 - XXVIII National Aeronautics and Space Administration (Parts 1800—1899)
 - XX United States Nuclear Regulatory Commission (Parts 2000—2099)
 - XXII Corporation for National and Community Service (Parts 2200—2299)
 - XXIII Social Security Administration (Parts 2300—2399)
 - XXIV Housing and Urban Development (Parts 2400—2499)
 - XXV National Science Foundation (Parts 2500—2599)
 - XXVI National Archives and Records Administration (Parts 2600—2699)
 - XXVII Small Business Administration (Parts 2700—2799)
 - XXVIII Department of Justice (Parts 2800—2899)

Title 2—Grants and Agreements—Continued

Chap.	
XXX	Department of Homeland Security (Parts 3000—3099)
XXXI	Institute of Museum and Library Services (Parts 3100—3199)
XXXII	National Endowment for the Arts (Parts 3200—3299)
XXXIII	National Endowment for the Humanities (Parts 3300—3399)
XXXIV	Department of Education (Parts 3400—3499)
XXXV	Export-Import Bank of the United States (Parts 3500—3599)
XXXVII	Peace Corps (Parts 3700—3799)
LVIII	Election Assistance Commission (Parts 5800—5899)

Title 3—The President

I	Executive Office of the President (Parts 100—199)
---	---

Title 4—Accounts

I	Government Accountability Office (Parts 1—199)
II	Recovery Accountability and Transparency Board (Parts 200—299)

Title 5—Administrative Personnel

I	Office of Personnel Management (Parts 1—1199)
II	Merit Systems Protection Board (Parts 1200—1299)
III	Office of Management and Budget (Parts 1300—1399)
V	The International Organizations Employees Loyalty Board (Parts 1500—1599)
VI	Federal Retirement Thrift Investment Board (Parts 1600—1699)
VIII	Office of Special Counsel (Parts 1800—1899)
IX	Appalachian Regional Commission (Parts 1900—1999)
XI	Armed Forces Retirement Home (Parts 2100—2199)
XIV	Federal Labor Relations Authority, General Counsel of the Federal Labor Relations Authority and Federal Service Impasses Panel (Parts 2400—2499)
XV	Office of Administration, Executive Office of the President (Parts 2500—2599)
XVI	Office of Government Ethics (Parts 2600—2699)
XXI	Department of the Treasury (Parts 3100—3199)
XXII	Federal Deposit Insurance Corporation (Parts 3200—3299)
XXIII	Department of Energy (Parts 3300—3399)
XXIV	Federal Energy Regulatory Commission (Parts 3400—3499)
XXV	Department of the Interior (Parts 3500—3599)
XXVI	Department of Defense (Parts 3600—3699)
XXVIII	Department of Justice (Parts 3800—3899)
XXIX	Federal Communications Commission (Parts 3900—3999)
XXX	Farm Credit System Insurance Corporation (Parts 4000—4099)
XXXI	Farm Credit Administration (Parts 4100—4199)

Title 5—Administrative Personnel—Continued

Chap.	
XXXIII	Overseas Private Investment Corporation (Parts 4300—4399)
XXXIV	Securities and Exchange Commission (Parts 4400—4499)
XXXV	Office of Personnel Management (Parts 4500—4599)
XXXVII	Federal Election Commission (Parts 4700—4799)
XL	Interstate Commerce Commission (Parts 5000—5099)
XLI	Commodity Futures Trading Commission (Parts 5100—5199)
XLII	Department of Labor (Parts 5200—5299)
XLIII	National Science Foundation (Parts 5300—5399)
XLV	Department of Health and Human Services (Parts 5500—5599)
XLVI	Postal Rate Commission (Parts 5600—5699)
XLVII	Federal Trade Commission (Parts 5700—5799)
XLVIII	Nuclear Regulatory Commission (Parts 5800—5899)
XLIX	Federal Labor Relations Authority (Parts 5900—5999)
L	Department of Transportation (Parts 6000—6099)
LII	Export-Import Bank of the United States (Parts 6200—6299)
LIII	Department of Education (Parts 6300—6399)
LIV	Environmental Protection Agency (Parts 6400—6499)
LV	National Endowment for the Arts (Parts 6500—6599)
LVI	National Endowment for the Humanities (Parts 6600—6699)
LVII	General Services Administration (Parts 6700—6799)
LVIII	Board of Governors of the Federal Reserve System (Parts 6800—6899)
LIX	National Aeronautics and Space Administration (Parts 6900—6999)
LX	United States Postal Service (Parts 7000—7099)
LXI	National Labor Relations Board (Parts 7100—7199)
LXII	Equal Employment Opportunity Commission (Parts 7200—7299)
LXIII	Inter-American Foundation (Parts 7300—7399)
LXIV	Merit Systems Protection Board (Parts 7400—7499)
LXV	Department of Housing and Urban Development (Parts 7500—7599)
LXVI	National Archives and Records Administration (Parts 7600—7699)
LXVII	Institute of Museum and Library Services (Parts 7700—7799)
LXVIII	Commission on Civil Rights (Parts 7800—7899)
LXIX	Tennessee Valley Authority (Parts 7900—7999)
LXX	Court Services and Offender Supervision Agency for the District of Columbia (Parts 8000—8099)
LXXI	Consumer Product Safety Commission (Parts 8100—8199)
LXXIII	Department of Agriculture (Parts 8300—8399)
LXXIV	Federal Mine Safety and Health Review Commission (Parts 8400—8499)
LXXVI	Federal Retirement Thrift Investment Board (Parts 8600—8699)
LXXVII	Office of Management and Budget (Parts 8700—8799)
LXXX	Federal Housing Finance Agency (Parts 9000—9099)
LXXXIII	Special Inspector General for Afghanistan Reconstruction (Parts 9300—9399)

Title 5—Administrative Personnel—Continued

Chap.	
LXXXIV	Bureau of Consumer Financial Protection (Parts 9400—9499)
LXXXVI	National Credit Union Administration (Parts 9600—9699)
XCVII	Department of Homeland Security Human Resources Management System (Department of Homeland Security—Office of Personnel Management) (Parts 9700—9799)
XCVII	Council of the Inspectors General on Integrity and Efficiency (Parts 9800—9899)
XCIX	Military Compensation and Retirement Modernization Commission (Parts 9900—9999)

Title 6—Domestic Security

I	Department of Homeland Security, Office of the Secretary (Parts 1—99)
X	Privacy and Civil Liberties Oversight Board (Parts 1000—1099)

Title 7—Agriculture

	SUBTITLE A—OFFICE OF THE SECRETARY OF AGRICULTURE (PARTS 0—26)
	SUBTITLE B—REGULATIONS OF THE DEPARTMENT OF AGRICULTURE
I	Agricultural Marketing Service (Standards, Inspections, Marketing Practices), Department of Agriculture (Parts 27—209)
II	Food and Nutrition Service, Department of Agriculture (Parts 210—299)
III	Animal and Plant Health Inspection Service, Department of Agriculture (Parts 300—399)
IV	Federal Crop Insurance Corporation, Department of Agriculture (Parts 400—499)
V	Agricultural Research Service, Department of Agriculture (Parts 500—599)
VI	Natural Resources Conservation Service, Department of Agriculture (Parts 600—699)
VII	Farm Service Agency, Department of Agriculture (Parts 700—799)
VIII	Grain Inspection, Packers and Stockyards Administration (Federal Grain Inspection Service), Department of Agriculture (Parts 800—899)
IX	Agricultural Marketing Service (Marketing Agreements and Orders; Fruits, Vegetables, Nuts), Department of Agriculture (Parts 900—999)
X	Agricultural Marketing Service (Marketing Agreements and Orders; Milk), Department of Agriculture (Parts 1000—1199)
XI	Agricultural Marketing Service (Marketing Agreements and Orders; Miscellaneous Commodities), Department of Agriculture (Parts 1200—1299)
XIV	Commodity Credit Corporation, Department of Agriculture (Parts 1400—1499)
XV	Foreign Agricultural Service, Department of Agriculture (Parts 1500—1599)

Title 7—Agriculture—Continued

Chap.	
XVI	Rural Telephone Bank, Department of Agriculture (Parts 1600—1699)
XVII	Rural Utilities Service, Department of Agriculture (Parts 1700—1799)
XXVIII	Rural Housing Service, Rural Business-Cooperative Service, Rural Utilities Service, and Farm Service Agency, Department of Agriculture (Parts 1800—2099)
XX	Local Television Loan Guarantee Board (Parts 2200—2299)
XXV	Office of Advocacy and Outreach, Department of Agriculture (Parts 2500—2599)
XXVI	Office of Inspector General, Department of Agriculture (Parts 2600—2699)
XXVII	Office of Information Resources Management, Department of Agriculture (Parts 2700—2799)
XXVIII	Office of Operations, Department of Agriculture (Parts 2800—2899)
XXIX	Office of Energy Policy and New Uses, Department of Agriculture (Parts 2900—2999)
XXX	Office of the Chief Financial Officer, Department of Agriculture (Parts 3000—3099)
XXXI	Office of Environmental Quality, Department of Agriculture (Parts 3100—3199)
XXXII	Office of Procurement and Property Management, Department of Agriculture (Parts 3200—3299)
XXXIII	Office of Transportation, Department of Agriculture (Parts 3300—3399)
XXXIV	National Institute of Food and Agriculture (Parts 3400—3499)
XXXV	Rural Housing Service, Department of Agriculture (Parts 3500—3599)
XXXVI	National Agricultural Statistics Service, Department of Agriculture (Parts 3600—3699)
XXXVII	Economic Research Service, Department of Agriculture (Parts 3700—3799)
XXXVIII	World Agricultural Outlook Board, Department of Agriculture (Parts 3800—3899)
XLI	[Reserved]
XLII	Rural Business-Cooperative Service and Rural Utilities Service, Department of Agriculture (Parts 4200—4299)

Title 8—Aliens and Nationality

I	Department of Homeland Security (Immigration and Naturalization) (Parts 1—499)
V	Executive Office for Immigration Review, Department of Justice (Parts 1000—1399)

Title 9—Animals and Animal Products

I	Animal and Plant Health Inspection Service, Department of Agriculture (Parts 1—199)
---	---

Title 9—Animals and Animal Products—Continued

Chap.

- II Grain Inspection, Packers and Stockyards Administration (Packers and Stockyards Programs), Department of Agriculture (Parts 200—299)
- III Food Safety and Inspection Service, Department of Agriculture (Parts 300—599)

Title 10—Energy

- I Nuclear Regulatory Commission (Parts 0—199)
- II Department of Energy (Parts 200—699)
- III Department of Energy (Parts 700—999)
- X Department of Energy (General Provisions) (Parts 1000—1099)
- XIII Nuclear Waste Technical Review Board (Parts 1300—1399)
- XVII Defense Nuclear Facilities Safety Board (Parts 1700—1799)
- XVIII Northeast Interstate Low-Level Radioactive Waste Commission (Parts 1800—1899)

Title 11—Federal Elections

- I Federal Election Commission (Parts 1—9099)
- II Election Assistance Commission (Parts 9400—9499)

Title 12—Banks and Banking

- I Comptroller of the Currency, Department of the Treasury (Parts 1—199)
- II Federal Reserve System (Parts 200—299)
- III Federal Deposit Insurance Corporation (Parts 300—399)
- IV Export-Import Bank of the United States (Parts 400—499)
- V Office of Thrift Supervision, Department of the Treasury (Parts 500—599)
- VI Farm Credit Administration (Parts 600—699)
- VII National Credit Union Administration (Parts 700—799)
- VIII Federal Financing Bank (Parts 800—899)
- IX Federal Housing Finance Board (Parts 900—999)
- X Bureau of Consumer Financial Protection (Parts 1000—1099)
- XI Federal Financial Institutions Examination Council (Parts 1100—1199)
- XII Federal Housing Finance Agency (Parts 1200—1299)
- XIII Financial Stability Oversight Council (Parts 1300—1399)
- XIV Farm Credit System Insurance Corporation (Parts 1400—1499)
- XV Department of the Treasury (Parts 1500—1599)
- XVI Office of Financial Research (Parts 1600—1699)
- XVII Office of Federal Housing Enterprise Oversight, Department of Housing and Urban Development (Parts 1700—1799)
- XVIII Community Development Financial Institutions Fund, Department of the Treasury (Parts 1800—1899)

- Title 13—Business Credit and Assistance**
- Chap.
- I Small Business Administration (Parts 1—199)
 - III Economic Development Administration, Department of Commerce (Parts 300—399)
 - IV Emergency Steel Guarantee Loan Board (Parts 400—499)
 - V Emergency Oil and Gas Guaranteed Loan Board (Parts 500—599)

Title 14—Aeronautics and Space

- I Federal Aviation Administration, Department of Transportation (Parts 1—199)
- II Office of the Secretary, Department of Transportation (Aviation Proceedings) (Parts 200—399)
- III Commercial Space Transportation, Federal Aviation Administration, Department of Transportation (Parts 400—1199)
- V National Aeronautics and Space Administration (Parts 1200—1299)
- VI Air Transportation System Stabilization (Parts 1300—1399)

Title 15—Commerce and Foreign Trade

- SUBTITLE A—OFFICE OF THE SECRETARY OF COMMERCE (PARTS 0—29)
- SUBTITLE B—REGULATIONS RELATING TO COMMERCE AND FOREIGN TRADE
 - I Bureau of the Census, Department of Commerce (Parts 30—199)
 - II National Institute of Standards and Technology, Department of Commerce (Parts 200—299)
 - III International Trade Administration, Department of Commerce (Parts 300—399)
 - IV Foreign-Trade Zones Board, Department of Commerce (Parts 400—499)
 - VII Bureau of Industry and Security, Department of Commerce (Parts 700—799)
 - VIII Bureau of Economic Analysis, Department of Commerce (Parts 800—899)
 - IX National Oceanic and Atmospheric Administration, Department of Commerce (Parts 900—999)
 - XI Technology Administration, Department of Commerce (Parts 1100—1199)
 - XIII East-West Foreign Trade Board (Parts 1300—1399)
 - XIV Minority Business Development Agency (Parts 1400—1499)
- SUBTITLE C—REGULATIONS RELATING TO FOREIGN TRADE AGREEMENTS
 - XX Office of the United States Trade Representative (Parts 2000—2099)
- SUBTITLE D—REGULATIONS RELATING TO TELECOMMUNICATIONS AND INFORMATION
 - XXIII National Telecommunications and Information Administration, Department of Commerce (Parts 2300—2399)

Title 16—Commercial Practices

Chap.

- I Federal Trade Commission (Parts 0—999)
- II Consumer Product Safety Commission (Parts 1000—1799)

Title 17—Commodity and Securities Exchanges

- I Commodity Futures Trading Commission (Parts 1—199)
- II Securities and Exchange Commission (Parts 200—399)
- IV Department of the Treasury (Parts 400—499)

Title 18—Conservation of Power and Water Resources

- I Federal Energy Regulatory Commission, Department of Energy (Parts 1—399)
- III Delaware River Basin Commission (Parts 400—499)
- VI Water Resources Council (Parts 700—799)
- VIII Susquehanna River Basin Commission (Parts 800—899)
- XIII Tennessee Valley Authority (Parts 1300—1399)

Title 19—Customs Duties

- I U.S. Customs and Border Protection, Department of Homeland Security; Department of the Treasury (Parts 0—199)
- II United States International Trade Commission (Parts 200—299)
- III International Trade Administration, Department of Commerce (Parts 300—399)
- IV U.S. Immigration and Customs Enforcement, Department of Homeland Security (Parts 400—599)

Title 20—Employees' Benefits

- I Office of Workers' Compensation Programs, Department of Labor (Parts 1—199)
- II Railroad Retirement Board (Parts 200—399)
- III Social Security Administration (Parts 400—499)
- IV Employees' Compensation Appeals Board, Department of Labor (Parts 500—599)
- V Employment and Training Administration, Department of Labor (Parts 600—699)
- VI Office of Workers' Compensation Programs, Department of Labor (Parts 700—799)
- VII Benefits Review Board, Department of Labor (Parts 800—899)
- VIII Joint Board for the Enrollment of Actuaries (Parts 900—999)
- IX Office of the Assistant Secretary for Veterans' Employment and Training Service, Department of Labor (Parts 1000—1099)

Title 21—Food and Drugs

Chap.

- I Food and Drug Administration, Department of Health and Human Services (Parts 1—1299)
- II Drug Enforcement Administration, Department of Justice (Parts 1300—1399)
- III Office of National Drug Control Policy (Parts 1400—1499)

Title 22—Foreign Relations

- I Department of State (Parts 1—199)
- II Agency for International Development (Parts 200—299)
- III Peace Corps (Parts 300—399)
- IV International Joint Commission, United States and Canada (Parts 400—499)
- V Broadcasting Board of Governors (Parts 500—599)
- VII Overseas Private Investment Corporation (Parts 700—799)
- IX Foreign Service Grievance Board (Parts 900—999)
- X Inter-American Foundation (Parts 1000—1099)
- XI International Boundary and Water Commission, United States and Mexico, United States Section (Parts 1100—1199)
- XII United States International Development Cooperation Agency (Parts 1200—1299)
- XIII Millennium Challenge Corporation (Parts 1300—1399)
- XIV Foreign Service Labor Relations Board; Federal Labor Relations Authority; General Counsel of the Federal Labor Relations Authority; and the Foreign Service Impasse Disputes Panel (Parts 1400—1499)
- XV African Development Foundation (Parts 1500—1599)
- XVI Japan-United States Friendship Commission (Parts 1600—1699)
- XVII United States Institute of Peace (Parts 1700—1799)

Title 23—Highways

- I Federal Highway Administration, Department of Transportation (Parts 1—999)
- II National Highway Traffic Safety Administration and Federal Highway Administration, Department of Transportation (Parts 1200—1299)
- III National Highway Traffic Safety Administration, Department of Transportation (Parts 1300—1399)

Title 24—Housing and Urban Development

SUBTITLE A—OFFICE OF THE SECRETARY, DEPARTMENT OF HOUSING AND URBAN DEVELOPMENT (PARTS 0—99)

SUBTITLE B—REGULATIONS RELATING TO HOUSING AND URBAN DEVELOPMENT

- I Office of Assistant Secretary for Equal Opportunity, Department of Housing and Urban Development (Parts 100—199)

Title 24—Housing and Urban Development—Continued

Chap.

- II Office of Assistant Secretary for Housing-Federal Housing Commissioner, Department of Housing and Urban Development (Parts 200—299)
- III Government National Mortgage Association, Department of Housing and Urban Development (Parts 300—399)
- IV Office of Housing and Office of Multifamily Housing Assistance Restructuring, Department of Housing and Urban Development (Parts 400—499)
- V Office of Assistant Secretary for Community Planning and Development, Department of Housing and Urban Development (Parts 500—599)
- VI Office of Assistant Secretary for Community Planning and Development, Department of Housing and Urban Development (Parts 600—699) [Reserved]
- VII Office of the Secretary, Department of Housing and Urban Development (Housing Assistance Programs and Public and Indian Housing Programs) (Parts 700—799)
- VIII Office of the Assistant Secretary for Housing—Federal Housing Commissioner, Department of Housing and Urban Development (Section 8 Housing Assistance Programs, Section 202 Direct Loan Program, Section 202 Supportive Housing for the Elderly Program and Section 811 Supportive Housing for Persons With Disabilities Program) (Parts 800—899)
- IX Office of Assistant Secretary for Public and Indian Housing, Department of Housing and Urban Development (Parts 900—1699)
- X Office of Assistant Secretary for Housing—Federal Housing Commissioner, Department of Housing and Urban Development (Interstate Land Sales Registration Program) (Parts 1700—1799)
- XII Office of Inspector General, Department of Housing and Urban Development (Parts 2000—2099)
- XV Emergency Mortgage Insurance and Loan Programs, Department of Housing and Urban Development (Parts 2700—2799) [Reserved]
- XX Office of Assistant Secretary for Housing—Federal Housing Commissioner, Department of Housing and Urban Development (Parts 3200—3899)
- XXIV Board of Directors of the HOPE for Homeowners Program (Parts 4000—4099) [Reserved]
- XXV Neighborhood Reinvestment Corporation (Parts 4100—4199)

Title 25—Indians

- I Bureau of Indian Affairs, Department of the Interior (Parts 1—299)
- II Indian Arts and Crafts Board, Department of the Interior (Parts 300—399)
- III National Indian Gaming Commission, Department of the Interior (Parts 500—599)
- IV Office of Navajo and Hopi Indian Relocation (Parts 700—799)

Title 25—Indians—Continued

Chap.

- V Bureau of Indian Affairs, Department of the Interior, and Indian Health Service, Department of Health and Human Services (Part 900)
- VI Office of the Assistant Secretary-Indian Affairs, Department of the Interior (Parts 1000—1199)
- VII Office of the Special Trustee for American Indians, Department of the Interior (Parts 1200—1299)

Title 26—Internal Revenue

- I Internal Revenue Service, Department of the Treasury (Parts 1—End)

Title 27—Alcohol, Tobacco Products and Firearms

- I Alcohol and Tobacco Tax and Trade Bureau, Department of the Treasury (Parts 1—399)
- II Bureau of Alcohol, Tobacco, Firearms, and Explosives, Department of Justice (Parts 400—699)

Title 28—Judicial Administration

- I Department of Justice (Parts 0—299)
- III Federal Prison Industries, Inc., Department of Justice (Parts 300—399)
- V Bureau of Prisons, Department of Justice (Parts 500—599)
- VI Offices of Independent Counsel, Department of Justice (Parts 600—699)
- VII Office of Independent Counsel (Parts 700—799)
- VIII Court Services and Offender Supervision Agency for the District of Columbia (Parts 800—899)
- IX National Crime Prevention and Privacy Compact Council (Parts 900—999)
- XI Department of Justice and Department of State (Parts 1100—1199)

Title 29—Labor

SUBTITLE A—OFFICE OF THE SECRETARY OF LABOR (PARTS 0—99)

SUBTITLE B—REGULATIONS RELATING TO LABOR

- I National Labor Relations Board (Parts 100—199)
- II Office of Labor-Management Standards, Department of Labor (Parts 200—299)
- III National Railroad Adjustment Board (Parts 300—399)
- IV Office of Labor-Management Standards, Department of Labor (Parts 400—499)
- V Wage and Hour Division, Department of Labor (Parts 500—899)
- IX Construction Industry Collective Bargaining Commission (Parts 900—999)

Title 29—Labor—Continued

- Chap.
- X National Mediation Board (Parts 1200—1299)
 - XII Federal Mediation and Conciliation Service (Parts 1400—1499)
 - XIV Equal Employment Opportunity Commission (Parts 1600—1699)
 - XVII Occupational Safety and Health Administration, Department of Labor (Parts 1900—1999)
 - XX Occupational Safety and Health Review Commission (Parts 2200—2499)
 - XXV Employee Benefits Security Administration, Department of Labor (Parts 2500—2599)
 - XXVII Federal Mine Safety and Health Review Commission (Parts 2700—2799)
 - XL Pension Benefit Guaranty Corporation (Parts 4000—4999)

Title 30—Mineral Resources

- I Mine Safety and Health Administration, Department of Labor (Parts 1—199)
- II Bureau of Safety and Environmental Enforcement, Department of the Interior (Parts 200—299)
- IV Geological Survey, Department of the Interior (Parts 400—499)
- V Bureau of Ocean Energy Management, Department of the Interior (Parts 500—599)
- VII Office of Surface Mining Reclamation and Enforcement, Department of the Interior (Parts 700—999)
- XII Office of Natural Resources Revenue, Department of the Interior (Parts 1200—1299)

Title 31—Money and Finance: Treasury

SUBTITLE A—OFFICE OF THE SECRETARY OF THE TREASURY (PARTS 0—50)

SUBTITLE B—REGULATIONS RELATING TO MONEY AND FINANCE

- I Monetary Offices, Department of the Treasury (Parts 51—199)
- II Fiscal Service, Department of the Treasury (Parts 200—399)
- IV Secret Service, Department of the Treasury (Parts 400—499)
- V Office of Foreign Assets Control, Department of the Treasury (Parts 500—599)
- VI Bureau of Engraving and Printing, Department of the Treasury (Parts 600—699)
- VII Federal Law Enforcement Training Center, Department of the Treasury (Parts 700—799)
- VIII Office of International Investment, Department of the Treasury (Parts 800—899)
- IX Federal Claims Collection Standards (Department of the Treasury—Department of Justice) (Parts 900—999)
- X Financial Crimes Enforcement Network, Department of the Treasury (Parts 1000—1099)

Title 32—National Defense

Chap.

SUBTITLE A—DEPARTMENT OF DEFENSE

- I Office of the Secretary of Defense (Parts 1—399)
 - V Department of the Army (Parts 400—699)
 - VI Department of the Navy (Parts 700—799)
 - VII Department of the Air Force (Parts 800—1099)
- ### SUBTITLE B—OTHER REGULATIONS RELATING TO NATIONAL DEFENSE
- XII Defense Logistics Agency (Parts 1200—1299)
 - XVI Selective Service System (Parts 1600—1699)
 - XVII Office of the Director of National Intelligence (Parts 1700—1799)
 - XXVIII National Counterintelligence Center (Parts 1800—1899)
 - XIX Central Intelligence Agency (Parts 1900—1999)
 - XX Information Security Oversight Office, National Archives and Records Administration (Parts 2000—2099)
 - XXI National Security Council (Parts 2100—2199)
 - XXIV Office of Science and Technology Policy (Parts 2400—2499)
 - XXVII Office for Micronesian Status Negotiations (Parts 2700—2799)
 - XXVIII Office of the Vice President of the United States (Parts 2800—2899)

Title 33—Navigation and Navigable Waters

- I Coast Guard, Department of Homeland Security (Parts 1—199)
- II Corps of Engineers, Department of the Army (Parts 200—399)
- IV Saint Lawrence Seaway Development Corporation, Department of Transportation (Parts 400—499)

Title 34—Education

SUBTITLE A—OFFICE OF THE SECRETARY, DEPARTMENT OF EDUCATION (PARTS 1—99)

SUBTITLE B—REGULATIONS OF THE OFFICES OF THE DEPARTMENT OF EDUCATION

- I Office for Civil Rights, Department of Education (Parts 100—199)
- II Office of Elementary and Secondary Education, Department of Education (Parts 200—299)
- III Office of Special Education and Rehabilitative Services, Department of Education (Parts 300—399)
- IV Office of Vocational and Adult Education, Department of Education (Parts 400—499)
- V Office of Bilingual Education and Minority Languages Affairs, Department of Education (Parts 500—599)
- VI Office of Postsecondary Education, Department of Education (Parts 600—699)
- VII Office of Educational Research and Improvement, Department of Education (Parts 700—799)[Reserved]

SUBTITLE C—REGULATIONS RELATING TO EDUCATION

Title 34—Education—Continued

Chap.

- XI National Institute for Literacy (Parts 1100—1199)
- XII National Council on Disability (Parts 1200—1299)

Title 35 [Reserved]

Title 36—Parks, Forests, and Public Property

- I National Park Service, Department of the Interior (Parts 1—199)
- II Forest Service, Department of Agriculture (Parts 200—299)
- III Corps of Engineers, Department of the Army (Parts 300—399)
- IV American Battle Monuments Commission (Parts 400—499)
- V Smithsonian Institution (Parts 500—599)
- VI [Reserved]
- VII Library of Congress (Parts 700—799)
- VIII Advisory Council on Historic Preservation (Parts 800—899)
- IX Pennsylvania Avenue Development Corporation (Parts 900—999)
- X Presidio Trust (Parts 1000—1099)
- XI Architectural and Transportation Barriers Compliance Board (Parts 1100—1199)
- XII National Archives and Records Administration (Parts 1200—1299)
- XV Oklahoma City National Memorial Trust (Parts 1500—1599)
- XVI Morris K. Udall Scholarship and Excellence in National Environmental Policy Foundation (Parts 1600—1699)

Title 37—Patents, Trademarks, and Copyrights

- I United States Patent and Trademark Office, Department of Commerce (Parts 1—199)
- II U.S. Copyright Office, Library of Congress (Parts 200—299)
- III Copyright Royalty Board, Library of Congress (Parts 300—399)
- IV Assistant Secretary for Technology Policy, Department of Commerce (Parts 400—599)

Title 38—Pensions, Bonuses, and Veterans' Relief

- I Department of Veterans Affairs (Parts 0—199)
- II Armed Forces Retirement Home (Parts 200—299)

Title 39—Postal Service

- I United States Postal Service (Parts 1—999)
- III Postal Regulatory Commission (Parts 3000—3099)

Title 40—Protection of Environment

- I Environmental Protection Agency (Parts 1—1099)

Title 40—Protection of Environment—Continued

Chap.

- IV Environmental Protection Agency and Department of Justice (Parts 1400—1499)
- V Council on Environmental Quality (Parts 1500—1599)
- VI Chemical Safety and Hazard Investigation Board (Parts 1600—1699)
- VII Environmental Protection Agency and Department of Defense; Uniform National Discharge Standards for Vessels of the Armed Forces (Parts 1700—1799)
- VIII Gulf Coast Ecosystem Restoration Council (Parts 1800—1899)

Title 41—Public Contracts and Property Management

SUBTITLE A—FEDERAL PROCUREMENT REGULATIONS SYSTEM
[NOTE]

SUBTITLE B—OTHER PROVISIONS RELATING TO PUBLIC CONTRACTS

- 50 Public Contracts, Department of Labor (Parts 50-1—50-999)
- 51 Committee for Purchase From People Who Are Blind or Severely Disabled (Parts 51-1—51-99)
- 60 Office of Federal Contract Compliance Programs, Equal Employment Opportunity, Department of Labor (Parts 60-1—60-999)
- 61 Office of the Assistant Secretary for Veterans' Employment and Training Service, Department of Labor (Parts 61-1—61-999)
- 62—100 [Reserved]

SUBTITLE C—FEDERAL PROPERTY MANAGEMENT REGULATIONS SYSTEM

- 101 Federal Property Management Regulations (Parts 101-1—101-99)
- 102 Federal Management Regulation (Parts 102-1—102-299)
- 103—104 [Reserved]
- 105 General Services Administration (Parts 105-1—105-999)
- 109 Department of Energy Property Management Regulations (Parts 109-1—109-99)
- 114 Department of the Interior (Parts 114-1—114-99)
- 115 Environmental Protection Agency (Parts 115-1—115-99)
- 128 Department of Justice (Parts 128-1—128-99)
- 129—200 [Reserved]

SUBTITLE D—OTHER PROVISIONS RELATING TO PROPERTY MANAGEMENT [RESERVED]

SUBTITLE E—FEDERAL INFORMATION RESOURCES MANAGEMENT REGULATIONS SYSTEM [RESERVED]

SUBTITLE F—FEDERAL TRAVEL REGULATION SYSTEM

- 300 General (Parts 300-1—300-99)
- 301 Temporary Duty (TDY) Travel Allowances (Parts 301-1—301-99)
- 302 Relocation Allowances (Parts 302-1—302-99)
- 303 Payment of Expenses Connected with the Death of Certain Employees (Part 303-1—303-99)
- 304 Payment of Travel Expenses from a Non-Federal Source (Parts 304-1—304-99)

Title 42—Public Health

Chap.

- I Public Health Service, Department of Health and Human Services (Parts 1—199)
- IV Centers for Medicare & Medicaid Services, Department of Health and Human Services (Parts 400—599)
- V Office of Inspector General-Health Care, Department of Health and Human Services (Parts 1000—1999)

Title 43—Public Lands: Interior

SUBTITLE A—OFFICE OF THE SECRETARY OF THE INTERIOR (PARTS 1—199)

SUBTITLE B—REGULATIONS RELATING TO PUBLIC LANDS

- I Bureau of Reclamation, Department of the Interior (Parts 400—999)
- II Bureau of Land Management, Department of the Interior (Parts 1000—9999)
- III Utah Reclamation Mitigation and Conservation Commission (Parts 10000—10099)

Title 44—Emergency Management and Assistance

- I Federal Emergency Management Agency, Department of Homeland Security (Parts 0—399)
- IV Department of Commerce and Department of Transportation (Parts 400—499)

Title 45—Public Welfare

SUBTITLE A—DEPARTMENT OF HEALTH AND HUMAN SERVICES (PARTS 1—199)

SUBTITLE B—REGULATIONS RELATING TO PUBLIC WELFARE

- II Office of Family Assistance (Assistance Programs), Administration for Children and Families, Department of Health and Human Services (Parts 200—299)
- III Office of Child Support Enforcement (Child Support Enforcement Program), Administration for Children and Families, Department of Health and Human Services (Parts 300—399)
- IV Office of Refugee Resettlement, Administration for Children and Families, Department of Health and Human Services (Parts 400—499)
- V Foreign Claims Settlement Commission of the United States, Department of Justice (Parts 500—599)
- VI National Science Foundation (Parts 600—699)
- VII Commission on Civil Rights (Parts 700—799)
- VIII Office of Personnel Management (Parts 800—899)
- X Office of Community Services, Administration for Children and Families, Department of Health and Human Services (Parts 1000—1099)
- XI National Foundation on the Arts and the Humanities (Parts 1100—1199)

Title 45—Public Welfare—Continued

Chap.	
XII	Corporation for National and Community Service (Parts 1200—1299)
XIII	Office of Human Development Services, Department of Health and Human Services (Parts 1300—1399)
XVI	Legal Services Corporation (Parts 1600—1699)
XVII	National Commission on Libraries and Information Science (Parts 1700—1799)
XVIII	Harry S. Truman Scholarship Foundation (Parts 1800—1899)
XXI	Commission on Fine Arts (Parts 2100—2199)
XXIII	Arctic Research Commission (Part 2301)
XXIV	James Madison Memorial Fellowship Foundation (Parts 2400—2499)
XXV	Corporation for National and Community Service (Parts 2500—2599)

Title 46—Shipping

I	Coast Guard, Department of Homeland Security (Parts 1—199)
II	Maritime Administration, Department of Transportation (Parts 200—399)
III	Coast Guard (Great Lakes Pilotage), Department of Homeland Security (Parts 400—499)
IV	Federal Maritime Commission (Parts 500—599)

Title 47—Telecommunication

I	Federal Communications Commission (Parts 0—199)
II	Office of Science and Technology Policy and National Security Council (Parts 200—299)
III	National Telecommunications and Information Administration, Department of Commerce (Parts 300—399)
IV	National Telecommunications and Information Administration, Department of Commerce, and National Highway Traffic Safety Administration, Department of Transportation (Parts 400—499)

Title 48—Federal Acquisition Regulations System

1	Federal Acquisition Regulation (Parts 1—99)
2	Defense Acquisition Regulations System, Department of Defense (Parts 200—299)
3	Health and Human Services (Parts 300—399)
4	Department of Agriculture (Parts 400—499)
5	General Services Administration (Parts 500—599)
6	Department of State (Parts 600—699)
7	Agency for International Development (Parts 700—799)
8	Department of Veterans Affairs (Parts 800—899)
9	Department of Energy (Parts 900—999)

Title 48—Federal Acquisition Regulations System—Continued

Chap.

- 10 Department of the Treasury (Parts 1000—1099)
- 12 Department of Transportation (Parts 1200—1299)
- 13 Department of Commerce (Parts 1300—1399)
- 14 Department of the Interior (Parts 1400—1499)
- 15 Environmental Protection Agency (Parts 1500—1599)
- 16 Office of Personnel Management, Federal Employees Health Benefits Acquisition Regulation (Parts 1600—1699)
- 17 Office of Personnel Management (Parts 1700—1799)
- 18 National Aeronautics and Space Administration (Parts 1800—1899)
- 19 Broadcasting Board of Governors (Parts 1900—1999)
- 20 Nuclear Regulatory Commission (Parts 2000—2099)
- 21 Office of Personnel Management, Federal Employees Group Life Insurance Federal Acquisition Regulation (Parts 2100—2199)
- 23 Social Security Administration (Parts 2300—2399)
- 24 Department of Housing and Urban Development (Parts 2400—2499)
- 25 National Science Foundation (Parts 2500—2599)
- 28 Department of Justice (Parts 2800—2899)
- 29 Department of Labor (Parts 2900—2999)
- 30 Department of Homeland Security, Homeland Security Acquisition Regulation (HSAR) (Parts 3000—3099)
- 34 Department of Education Acquisition Regulation (Parts 3400—3499)
- 51 Department of the Army Acquisition Regulations (Parts 5100—5199)
- 52 Department of the Navy Acquisition Regulations (Parts 5200—5299)
- 53 Department of the Air Force Federal Acquisition Regulation Supplement (Parts 5300—5399) [Reserved]
- 54 Defense Logistics Agency, Department of Defense (Parts 5400—5499)
- 57 African Development Foundation (Parts 5700—5799)
- 61 Civilian Board of Contract Appeals, General Services Administration (Parts 6100—6199)
- 63 Department of Transportation Board of Contract Appeals (Parts 6300—6399)
- 99 Cost Accounting Standards Board, Office of Federal Procurement Policy, Office of Management and Budget (Parts 9900—9999)

Title 49—Transportation

SUBTITLE A—OFFICE OF THE SECRETARY OF TRANSPORTATION
(PARTS 1—99)

SUBTITLE B—OTHER REGULATIONS RELATING TO TRANSPORTATION

- I Pipeline and Hazardous Materials Safety Administration, Department of Transportation (Parts 100—199)

Title 49—Transportation—Continued

Chap.

- II Federal Railroad Administration, Department of Transportation (Parts 200—299)
- III Federal Motor Carrier Safety Administration, Department of Transportation (Parts 300—399)
- IV Coast Guard, Department of Homeland Security (Parts 400—499)
- V National Highway Traffic Safety Administration, Department of Transportation (Parts 500—599)
- VI Federal Transit Administration, Department of Transportation (Parts 600—699)
- VII National Railroad Passenger Corporation (AMTRAK) (Parts 700—799)
- VIII National Transportation Safety Board (Parts 800—999)
- X Surface Transportation Board, Department of Transportation (Parts 1000—1399)
- XI Research and Innovative Technology Administration, Department of Transportation (Parts 1400—1499) [Reserved]
- XII Transportation Security Administration, Department of Homeland Security (Parts 1500—1699)

Title 50—Wildlife and Fisheries

- I United States Fish and Wildlife Service, Department of the Interior (Parts 1—199)
- II National Marine Fisheries Service, National Oceanic and Atmospheric Administration, Department of Commerce (Parts 200—299)
- III International Fishing and Related Activities (Parts 300—399)
- IV Joint Regulations (United States Fish and Wildlife Service, Department of the Interior and National Marine Fisheries Service, National Oceanic and Atmospheric Administration, Department of Commerce); Endangered Species Committee Regulations (Parts 400—499)
- V Marine Mammal Commission (Parts 500—599)
- VI Fishery Conservation and Management, National Oceanic and Atmospheric Administration, Department of Commerce (Parts 600—699)

Alphabetical List of Agencies Appearing in the CFR

(Revised as of October 1, 2014)

Agency	CFR Title, Subtitle or Chapter
Administrative Committee of the Federal Register	1, I
Administrative Conference of the United States	1, III
Advisory Council on Historic Preservation	36, VIII
Advocacy and Outreach, Office of	7, XXV
Afghanistan Reconstruction, Special Inspector General for	22, LXXXIII
African Development Foundation	22, XV
Federal Acquisition Regulation	48, 57
Agency for International Development	2, VII; 22, II
Federal Acquisition Regulation	48, 7
Agricultural Marketing Service	7, I, IX, X, XI
Agricultural Research Service	7, V
Agriculture Department	2, IV; 5, LXXXIII
Advocacy and Outreach, Office of	7, XXXV
Agricultural Marketing Service	7, I, IX, X, XI
Agricultural Research Service	7, V
Animal and Plant Health Inspection Service	7, III; 9, I
Chief Financial Officer, Office of	7, XXX
Commodity Credit Corporation	7, XIV
Economic Research Service	7, XXXVII
Energy Policy and New Uses, Office of	2, IX; 7, XXIX
Environmental Quality, Office of	7, XXXI
Farm Service Agency	7, VII, XVIII
Federal Acquisition Regulation	48, 4
Federal Crop Insurance Corporation	7, IV
Food and Nutrition Service	7, II
Food Safety and Inspection Service	9, III
Foreign Agricultural Service	7, XV
Forest Service	36, II
Grain Inspection, Packers and Stockyards Administration	7, VIII; 9, II
Information Resources Management, Office of	7, XXVII
Inspector General, Office of	7, XXVI
National Agricultural Library	7, XLI
National Agricultural Statistics Service	7, XXXVI
National Institute of Food and Agriculture	7, XXXIV
Natural Resources Conservation Service	7, VI
Operations, Office of	7, XXVIII
Procurement and Property Management, Office of	7, XXXII
Rural Business-Cooperative Service	7, XVIII, XLII, L
Rural Development Administration	7, XLII
Rural Housing Service	7, XVIII, XXXV, L
Rural Telephone Bank	7, XVI
Rural Utilities Service	7, XVII, XVIII, XLII, L
Secretary of Agriculture, Office of	7, Subtitle A
Transportation, Office of	7, XXXIII
World Agricultural Outlook Board	7, XXXVIII
Air Force Department	32, VII
Federal Acquisition Regulation Supplement	48, 53
Air Transportation Stabilization Board	14, VI
Alcohol and Tobacco Tax and Trade Bureau	27, I
Alcohol, Tobacco, Firearms, and Explosives, Bureau of	27, II
AMTRAK	49, VII
American Battle Monuments Commission	36, IV
American Indians, Office of the Special Trustee	25, VII

Agency	CFR Title, Subtitle or Chapter
Animal and Plant Health Inspection Service	7, III; 9, I
Appalachian Regional Commission	5, IX
Architectural and Transportation Barriers Compliance Board	36, XI
Arctic Research Commission	45, XXIII
Armed Forces Retirement Home	5, XI
Army Department	32, V
Engineers, Corps of	33, II; 36, III
Federal Acquisition Regulation	48, 51
Bilingual Education and Minority Languages Affairs, Office of	34, V
Blind or Severely Disabled, Committee for Purchase from People Who Are	41, 51
Broadcasting Board of Governors	22, V
Federal Acquisition Regulation	48, 19
Bureau of Ocean Energy Management, Regulation, and Enforcement	30, II
Census Bureau	15, I
Centers for Medicare & Medicaid Services	42, IV
Central Intelligence Agency	32, XIX
Chemical Safety and Hazardous Investigation Board	40, VI
Chief Financial Officer, Office of	7, XXX
Child Support Enforcement, Office of	45, III
Children and Families, Administration for	45, II, III, IV, X
Civil Rights, Commission on	5, LXVIII; 45, VII
Civil Rights, Office for	34, I
Council of the Inspectors General on Integrity and Efficiency	5, XCVIII
Court Services and Offender Supervision Agency for the District of Columbia	5, LXX
Coast Guard	33, I; 46, I; 49, IV
Coast Guard (Great Lakes Pilotage)	46, III
Commerce Department	2, XIII; 44, IV; 50, VI
Census Bureau	15, I
Economic Analysis, Bureau of	15, VIII
Economic Development Administration	13, III
Emergency Management and Assistance	44, IV
Federal Acquisition Regulation	48, 13
Foreign-Trade Zones Board	15, IV
Industry and Security, Bureau of	15, VII
International Trade Administration	15, III; 19, III
National Institute of Standards and Technology	15, II
National Marine Fisheries Service	50, II, IV
National Oceanic and Atmospheric Administration	15, IX; 50, II, III, IV, VI
National Telecommunications and Information Administration	15, XXIII; 47, III, IV
National Weather Service	15, IX
Patent and Trademark Office, United States	37, I
Productivity, Technology and Innovation, Assistant Secretary for	37, IV
Secretary of Commerce, Office of	15, Subtitle A
Technology Administration	15, XI
Technology Policy, Assistant Secretary for	37, IV
Commercial Space Transportation	14, III
Commodity Credit Corporation	7, XIV
Commodity Futures Trading Commission	5, XLI; 17, I
Community Planning and Development, Office of Assistant Secretary for	24, V, VI
Community Services, Office of	45, X
Comptroller of the Currency	12, I
Construction Industry Collective Bargaining Commission	29, IX
Consumer Financial Protection Bureau	5, LXXXIV; 12, X
Consumer Product Safety Commission	5, LXXI; 16, II
Copyright Royalty Board	37, III
Corporation for National and Community Service	2, XXXII; 45, XII, XXV
Cost Accounting Standards Board	48, 99
Council on Environmental Quality	40, V
Court Services and Offender Supervision Agency for the District of Columbia	5, LXX; 28, VIII
Customs and Border Protection	19, I

Agency	CFR Title, Subtitle or Chapter
Defense Contract Audit Agency	32, I
Defense Department	2, XI; 5, XXVI; 32, Subtitle A; 40, VII
Advanced Research Projects Agency	32, I
Air Force Department	32, VII
Army Department	32, V; 33, II; 36, III, 48, 51
Defense Acquisition Regulations System	48, 2
Defense Intelligence Agency	32, I
Defense Logistics Agency	32, I, XII; 48, 54
Engineers, Corps of	33, II; 36, III
National Imagery and Mapping Agency	32, I
Navy Department	32, VI; 48, 52
Secretary of Defense, Office of	2, XI; 32, I
Defense Contract Audit Agency	32, I
Defense Intelligence Agency	32, I
Defense Logistics Agency	32, XII; 48, 54
Defense Nuclear Facilities Safety Board	10, XVII
Delaware River Basin Commission	18, III
District of Columbia, Court Services and Offender Supervision Agency for the	5, LXX; 28, VIII
Drug Enforcement Administration	21, II
East-West Foreign Trade Board	15, XIII
Economic Analysis, Bureau of	15, VIII
Economic Development Administration	13, III
Economic Research Service	7, XXXVII
Education, Department of	2, XXXIV; 5, LIII
Bilingual Education and Minority Languages Affairs, Office of	34, V
Civil Rights, Office for	34, I
Educational Research and Improvement, Office of	34, VII
Elementary and Secondary Education, Office of	34, II
Federal Acquisition Regulation	48, 34
Postsecondary Education, Office of	34, VI
Secretary of Education, Office of	34, Subtitle A
Special Education and Rehabilitative Services, Office of	34, III
Vocational and Adult Education, Office of	34, IV
Educational Research and Improvement, Office of	34, VII
Election Assistance Commission	2, LVIII; 11, II
Elementary and Secondary Education, Office of	34, II
Emergency Oil and Gas Guaranteed Loan Board	13, V
Emergency Steel Guarantee Loan Board	13, IV
Employee Benefits Security Administration	29, XXV
Employees' Compensation Appeals Board	20, IV
Employees Loyalty Board	5, V
Employment and Training Administration	20, V
Employment Standards Administration	20, VI
Endangered Species Committee	50, IV
Energy, Department of	2, IX; 5, XXIII; 10, II, III, X
Federal Acquisition Regulation	48, 9
Federal Energy Regulatory Commission	5, XXIV; 18, I
Property Management Regulations	41, 109
Energy, Office of	7, XXIX
Engineers, Corps of	33, II; 36, III
Engraving and Printing, Bureau of	31, VI
Environmental Protection Agency	2, XV; 5, LIV; 40, I, IV, VII
Federal Acquisition Regulation	48, 15
Property Management Regulations	41, 115
Environmental Quality, Office of	7, XXXI
Equal Employment Opportunity Commission	5, LXII; 29, XIV
Equal Opportunity, Office of Assistant Secretary for	24, I
Executive Office of the President	3, I
Administration, Office of	5, XV
Environmental Quality, Council on	40, V
Management and Budget, Office of	2, Subtitle A; 5, III, LXXXVII; 14, VI; 48, 99

Agency	CFR Title, Subtitle or Chapter
National Drug Control Policy, Office of	21, III
National Security Council	32, XXI; 47, 2
Presidential Documents	3
Science and Technology Policy, Office of	32, XXIV; 47, II
Trade Representative, Office of the United States	15, XX
Export-Import Bank of the United States	2, XXXV; 5, LII; 12, IV
Family Assistance, Office of	45, II
Farm Credit Administration	5, XXXI; 12, VI
Farm Credit System Insurance Corporation	5, XXX; 12, XIV
Farm Service Agency	7, VII, XVIII
Federal Acquisition Regulation	48, 1
Federal Aviation Administration	14, I
Commercial Space Transportation	14, III
Federal Claims Collection Standards	31, IX
Federal Communications Commission	5, XXIX; 47, I
Federal Contract Compliance Programs, Office of	41, 60
Federal Crop Insurance Corporation	7, IV
Federal Deposit Insurance Corporation	5, XXII; 12, III
Federal Election Commission	5, XXXVII; 11, I
Federal Emergency Management Agency	44, I
Federal Employees Group Life Insurance Federal Acquisition Regulation	48, 21
Federal Employees Health Benefits Acquisition Regulation	48, 16
Federal Energy Regulatory Commission	5, XXIV; 18, I
Federal Financial Institutions Examination Council	12, XI
Federal Financing Bank	12, VIII
Federal Highway Administration	23, I, II
Federal Home Loan Mortgage Corporation	1, IV
Federal Housing Enterprise Oversight Office	12, XXVII
Federal Housing Finance Agency	5, LXXX; 12, XII
Federal Housing Finance Board	12, IX
Federal Labor Relations Authority	5, XIV, XLIX; 22, XIV
Federal Law Enforcement Training Center	31, VII
Federal Management Regulation	41, 102
Federal Maritime Commission	46, IV
Federal Mediation and Conciliation Service	29, XII
Federal Mine Safety and Health Review Commission	5, LXXIV; 29, XXVII
Federal Motor Carrier Safety Administration	49, III
Federal Prison Industries, Inc.	28, III
Federal Procurement Policy Office	48, 99
Federal Property Management Regulations	41, 101
Federal Railroad Administration	49, II
Federal Register, Administrative Committee of	1, I
Federal Register, Office of	1, II
Federal Reserve System	12, II
Board of Governors	5, LVIII
Federal Retirement Thrift Investment Board	5, VI, LXXXVI
Federal Service Impasses Panel	5, XIV
Federal Trade Commission	5, XLVII; 16, I
Federal Transit Administration	49, VI
Federal Travel Regulation System	41, Subtitle F
Financial Crimes Enforcement Network	31, X
Financial Research Office	12, XVI
Financial Stability Oversight Council	12, XIII
Fine Arts, Commission on	45, XXI
Fiscal Service	31, II
Fish and Wildlife Service, United States	50, I, IV
Food and Drug Administration	21, I
Food and Nutrition Service	7, II
Food Safety and Inspection Service	9, III
Foreign Agricultural Service	7, XV
Foreign Assets Control, Office of	31, V
Foreign Claims Settlement Commission of the United States	45, V
Foreign Service Grievance Board	22, IX
Foreign Service Impasse Disputes Panel	22, XIV
Foreign Service Labor Relations Board	22, XIV
Foreign-Trade Zones Board	15, IV

Agency	CFR Title, Subtitle or Chapter
Forest Service	36, II
General Services Administration	5, LVII; 41, 105
Contract Appeals, Board of	48, 61
Federal Acquisition Regulation	48, 5
Federal Management Regulation	41, 102
Federal Property Management Regulations	41, 101
Federal Travel Regulation System	41, Subtitle F
General	41, 300
Payment From a Non-Federal Source for Travel Expenses	41, 304
Payment of Expenses Connected With the Death of Certain Employees	41, 303
Relocation Allowances	41, 302
Temporary Duty (TDY) Travel Allowances	41, 301
Geological Survey	30, IV
Government Accountability Office	4, I
Government Ethics, Office of	5, XVI
Government National Mortgage Association	24, III
Grain Inspection, Packers and Stockyards Administration	7, VIII; 9, II
Gulf Coast Ecosystem Restoration Council	40, VIII
Harry S. Truman Scholarship Foundation	45, XXVIII
Health and Human Services, Department of	2, III; 5, XLV; 45, Subtitle A,
Centers for Medicare & Medicaid Services	42, IV
Child Support Enforcement, Office of	45, III
Children and Families, Administration for	45, II, III, IV, X
Community Services, Office of	45, X
Family Assistance, Office of	45, II
Federal Acquisition Regulation	48, 3
Food and Drug Administration	21, I
Human Development Services, Office of	45, XIII
Indian Health Service	25, V
Inspector General (Health Care), Office of	42, V
Public Health Service	42, I
Refugee Resettlement, Office of	45, IV
Homeland Security, Department of	2, XXX; 6, I; 8, I
Coast Guard	33, I; 46, I; 49, IV
Coast Guard (Great Lakes Pilotage)	46, III
Customs and Border Protection	19, I
Federal Emergency Management Agency	44, I
Human Resources Management and Labor Relations Systems	5, XCVII
Immigration and Customs Enforcement Bureau	19, IV
Transportation Security Administration	49, XII
HOPE for Homeowners Program, Board of Directors of	24, XXIV
Housing and Urban Development, Department of	2, XXIV; 5, LXV; 24, Subtitle B
Community Planning and Development, Office of Assistant Secretary for	24, V, VI
Equal Opportunity, Office of Assistant Secretary for	24, I
Federal Acquisition Regulation	48, 24
Federal Housing Enterprise Oversight, Office of	12, XVII
Government National Mortgage Association	24, III
Housing—Federal Housing Commissioner, Office of Assistant Secretary for	24, II, VIII, X, XX
Housing, Office of, and Multifamily Housing Assistance Restructuring, Office of	24, IV
Inspector General, Office of	24, XII
Public and Indian Housing, Office of Assistant Secretary for Secretary, Office of	24, IX
Housing—Federal Housing Commissioner, Office of Assistant Secretary for	24, Subtitle A, VII
Housing, Office of, and Multifamily Housing Assistance Restructuring, Office of	24, II, VIII, X, XX
Housing, Office of, and Multifamily Housing Assistance Restructuring, Office of	24, IV
Human Development Services, Office of	45, XIII
Immigration and Customs Enforcement Bureau	19, IV
Immigration Review, Executive Office for	8, V
Independent Counsel, Office of	28, VII

Agency	CFR Title, Subtitle or Chapter
Indian Affairs, Bureau of	25, I, V
Indian Affairs, Office of the Assistant Secretary	25, VI
Indian Arts and Crafts Board	25, II
Indian Health Service	25, V
Industry and Security, Bureau of	15, VII
Information Resources Management, Office of	7, XXVII
Information Security Oversight Office, National Archives and Records Administration	32, XX
Inspector General	
Agriculture Department	7, XXVI
Health and Human Services Department	42, V
Housing and Urban Development Department	24, XII, XV
Institute of Peace, United States	22, XVII
Inter-American Foundation	5, LXIII; 22, X
Interior Department	2, XIV
American Indians, Office of the Special Trustee	25, VII
Bureau of Ocean Energy Management, Regulation, and Enforcement	30, II
Endangered Species Committee	50, IV
Federal Acquisition Regulation	48, 14
Federal Property Management Regulations System	41, 114
Fish and Wildlife Service, United States	50, I, IV
Geological Survey	30, IV
Indian Affairs, Bureau of	25, I, V
Indian Affairs, Office of the Assistant Secretary	25, VI
Indian Arts and Crafts Board	25, II
Land Management, Bureau of	43, II
National Indian Gaming Commission	25, III
National Park Service	36, I
Natural Resource Revenue, Office of	30, XII
Ocean Energy Management, Bureau of	30, V
Reclamation, Bureau of	43, I
Secretary of the Interior, Office of	2, XIV; 43, Subtitle A
Surface Mining Reclamation and Enforcement, Office of	30, VII
Internal Revenue Service	26, I
International Boundary and Water Commission, United States and Mexico, United States Section	22, XI
International Development, United States Agency for Federal Acquisition Regulation	22, II 48, 7
International Development Cooperation Agency, United States	22, XII
International Joint Commission, United States and Canada	22, IV
International Organizations Employees Loyalty Board	5, V
International Trade Administration	15, III; 19, III
International Trade Commission, United States	19, II
Interstate Commerce Commission	5, XL
Investment Security, Office of	31, VIII
James Madison Memorial Fellowship Foundation	45, XXIV
Japan–United States Friendship Commission	22, XVI
Joint Board for the Enrollment of Actuaries	20, VIII
Justice Department	2, XXVIII; 5, XXVIII; 28, I, XI; 40, IV
Alcohol, Tobacco, Firearms, and Explosives, Bureau of	27, II
Drug Enforcement Administration	21, II
Federal Acquisition Regulation	48, 28
Federal Claims Collection Standards	31, IX
Federal Prison Industries, Inc.	28, III
Foreign Claims Settlement Commission of the United States	45, V
Immigration Review, Executive Office for	8, V
Offices of Independent Counsel	28, VI
Prisons, Bureau of	28, V
Property Management Regulations	41, 128
Labor Department	5, XLII
Employee Benefits Security Administration	29, XXV
Employees' Compensation Appeals Board	20, IV
Employment and Training Administration	20, V

Agency	CFR Title, Subtitle or Chapter
Employment Standards Administration	20, VI
Federal Acquisition Regulation	48, 29
Federal Contract Compliance Programs, Office of	41, 60
Federal Procurement Regulations System	41, 50
Labor-Management Standards, Office of	29, II, IV
Mine Safety and Health Administration	30, I
Occupational Safety and Health Administration	29, XXVII
Office of Workers' Compensation Programs	20, VII
Public Contracts	41, 50
Secretary of Labor, Office of	29, Subtitle A
Veterans' Employment and Training Service, Office of the Assistant Secretary for	41, 61; 20, IX
Wage and Hour Division	29, V
Workers' Compensation Programs, Office of	20, I
Labor-Management Standards, Office of	29, II, IV
Land Management, Bureau of	43, II
Legal Services Corporation	45, XXVI
Library of Congress	36, VII
Copyright Royalty Board	37, III
U.S. Copyright Office	37, II
Local Television Loan Guarantee Board	7, XX
Management and Budget, Office of	5, III, LXXXVII; 14, VI; 48, 99
Marine Mammal Commission	50, V
Maritime Administration	46, II
Merit Systems Protection Board	5, II, LXIV
Micronesia Status Negotiations, Office for	32, XXXVII
Military Compensation and Retirement Modernization Commission	5, XCIX
Millennium Challenge Corporation	22, XIII
Mine Safety and Health Administration	30, I
Minority Business Development Agency	15, XIV
Miscellaneous Agencies	1, IV
Monetary Offices	31, I
Morris K. Udall Scholarship and Excellence in National Environmental Policy Foundation	36, XVI
Museum and Library Services, Institute of	2, XXXI
National Aeronautics and Space Administration	2, XVIII; 5, LIX; 14, V 48, 18
Federal Acquisition Regulation	7, XLI
National Agricultural Library	7, XXXVI
National Agricultural Statistics Service	2, XXII; 45, XII, XXV
National and Community Service, Corporation for	2, XXVI; 5, LXVI; 36, XII
National Archives and Records Administration	32, XX
Information Security Oversight Office	1, IV
National Capital Planning Commission	1, IV
National Commission for Employment Policy	45, XVII
National Commission on Libraries and Information Science	34, XII
National Council on Disability	32, XVIII
National Counterintelligence Center	5, LXXXVI; 12, VII
National Credit Union Administration	28, IX
National Crime Prevention and Privacy Compact Council	21, III
National Drug Control Policy, Office of	2, XXXII
National Endowment for the Arts	2, XXXIII
National Endowment for the Humanities	45, XI
National Foundation on the Arts and the Humanities	23, II, III; 47, VI; 49, V
National Highway Traffic Safety Administration	32, I
National Imagery and Mapping Agency	25, III
National Indian Gaming Commission	34, XI
National Institute for Literacy	7, XXXIV
National Institute of Food and Agriculture	15, II
National Institute of Standards and Technology	32, XVII
National Intelligence, Office of Director of	5, LXI; 29, I
National Labor Relations Board	50, II, IV
National Marine Fisheries Service	29, X
National Mediation Board	15, IX; 50, II, III, IV, VI
National Oceanic and Atmospheric Administration	

Agency	CFR Title, Subtitle or Chapter
National Park Service	36, I
National Railroad Adjustment Board	29, III
National Railroad Passenger Corporation (AMTRAK)	49, VII
National Science Foundation	2, XXV; 5, XLIII; 45, VI
Federal Acquisition Regulation	48, 25
National Security Council	32, XXI
National Security Council and Office of Science and Technology Policy	47, II
National Telecommunications and Information Administration	15, XXIII; 47, III, IV
National Transportation Safety Board	49, VIII
Natural Resources Conservation Service	7, VI
Natural Resource Revenue, Office of	30, XII
Navajo and Hopi Indian Relocation, Office of	25, IV
Navy Department	32, VI
Federal Acquisition Regulation	48, 52
Neighborhood Reinvestment Corporation	24, XXV
Northeast Interstate Low-Level Radioactive Waste Commission	10, XVIII
Nuclear Regulatory Commission	2, XX; 5, XLVIII; 10, I
Federal Acquisition Regulation	48, 20
Occupational Safety and Health Administration	29, XVII
Occupational Safety and Health Review Commission	29, XX
Ocean Energy Management, Bureau of	30, V
Offices of Independent Counsel	28, VI
Office of Workers' Compensation Programs	20, VII
Oklahoma City National Memorial Trust	36, XV
Operations Office	7, XXVIII
Overseas Private Investment Corporation	5, XXXIII; 22, VII
Patent and Trademark Office, United States	37, I
Payment From a Non-Federal Source for Travel Expenses	41, 304
Payment of Expenses Connected With the Death of Certain Employees	41, 303
Peace Corps	2, XXXVII; 22, III
Pennsylvania Avenue Development Corporation	36, IX
Pension Benefit Guaranty Corporation	29, XL
Personnel Management, Office of	5, I, XXXV; 45, VIII
Human Resources Management and Labor Relations Systems, Department of Homeland Security	5, XCVII
Federal Acquisition Regulation	48, 17
Federal Employees Group Life Insurance Federal Acquisition Regulation	48, 21
Federal Employees Health Benefits Acquisition Regulation	48, 16
Pipeline and Hazardous Materials Safety Administration	49, I
Postal Regulatory Commission	5, XLVI; 39, III
Postal Service, United States	5, LX; 39, I
Postsecondary Education, Office of	34, VI
President's Commission on White House Fellowships	1, IV
Presidential Documents	3
Presidio Trust	36, X
Prisons, Bureau of	28, V
Privacy and Civil Liberties Oversight Board	6, X
Procurement and Property Management, Office of	7, XXXII
Productivity, Technology and Innovation, Assistant Secretary	37, IV
Public Contracts, Department of Labor	41, 50
Public and Indian Housing, Office of Assistant Secretary for	24, IX
Public Health Service	42, I
Railroad Retirement Board	20, II
Reclamation, Bureau of	43, I
Recovery Accountability and Transparency Board	4, II
Refugee Resettlement, Office of	45, IV
Relocation Allowances	41, 302
Research and Innovative Technology Administration	49, XI
Rural Business-Cooperative Service	7, XVIII, XLII, L
Rural Development Administration	7, XLII
Rural Housing Service	7, XVIII, XXXV, L

Agency	CFR Title, Subtitle or Chapter
Rural Telephone Bank	7, XVI
Rural Utilities Service	7, XVII, XVIII, XLII, L
Saint Lawrence Seaway Development Corporation	33, IV
Science and Technology Policy, Office of	32, XXIV
Science and Technology Policy, Office of, and National Security Council	47, II
Secret Service	31, IV
Securities and Exchange Commission	5, XXXIV; 17, II
Selective Service System	32, XVI
Small Business Administration	2, XXVII; 13, I
Smithsonian Institution	36, V
Social Security Administration	2, XXIII; 20, III; 48, 23
Soldiers' and Airmen's Home, United States	5, XI
Special Counsel, Office of	5, VIII
Special Education and Rehabilitative Services, Office of State Department	34, III
Federal Acquisition Regulation	2, VI; 22, I; 28, XI
Surface Mining Reclamation and Enforcement, Office of	48, 6
Surface Transportation Board	30, VII
Susquehanna River Basin Commission	49, X
Technology Administration	18, VIII
Technology Policy, Assistant Secretary for	15, XI
Tennessee Valley Authority	37, IV
Thrift Supervision Office, Department of the Treasury	5, LXIX; 18, XIII
Trade Representative, United States, Office of	12, V
Transportation, Department of	15, XX
Commercial Space Transportation	2, XII; 5, L
Contract Appeals, Board of	14, III
Emergency Management and Assistance	48, 63
Federal Acquisition Regulation	44, IV
Federal Aviation Administration	48, 12
Federal Highway Administration	14, I
Federal Motor Carrier Safety Administration	23, I, II
Federal Railroad Administration	49, III
Federal Transit Administration	49, II
Maritime Administration	49, VI
National Highway Traffic Safety Administration	46, II
Pipeline and Hazardous Materials Safety Administration	23, II, III; 47, IV; 49, V
Saint Lawrence Seaway Development Corporation	49, I
Secretary of Transportation, Office of	33, IV
Surface Transportation Board	14, II; 49, Subtitle A
Transportation Statistics Bureau	49, X
Transportation, Office of	49, XI
Transportation Security Administration	7, XXXIII
Transportation Statistics Bureau	49, XII
Travel Allowances, Temporary Duty (TDY)	49, XI
Treasury Department	41, 301
Alcohol and Tobacco Tax and Trade Bureau	5, XXI; 12, XV; 17, IV;
Community Development Financial Institutions Fund	31, IX
Comptroller of the Currency	27, I
Customs and Border Protection	12, XVIII
Engraving and Printing, Bureau of	12, I
Federal Acquisition Regulation	19, I
Federal Claims Collection Standards	31, VI
Federal Law Enforcement Training Center	48, 10
Financial Crimes Enforcement Network	31, IX
Fiscal Service	31, VII
Foreign Assets Control, Office of	31, X
Internal Revenue Service	31, X
Investment Security, Office of	31, II
Monetary Offices	31, V
Secret Service	26, I
Secretary of the Treasury, Office of	31, VIII
Thrift Supervision, Office of	31, I
Truman, Harry S. Scholarship Foundation	31, IV
United States and Canada, International Joint Commission	31, Subtitle A
	12, V
	45, XVIII
	22, IV

Agency	CFR Title, Subtitle or Chapter
United States and Mexico, International Boundary and Water Commission, United States Section	22, XI
U.S. Copyright Office	37, II
Utah Reclamation Mitigation and Conservation Commission	43, III
Veterans Affairs Department	2, VIII; 38, I
Federal Acquisition Regulation	48, 8
Veterans' Employment and Training Service, Office of the Assistant Secretary for	41, 61; 20, IX
Vice President of the United States, Office of	32, XXVIII
Vocational and Adult Education, Office of	34, IV
Wage and Hour Division	29, V
Water Resources Council	18, VI
Workers' Compensation Programs, Office of	20, I
World Agricultural Outlook Board	7, XXXVIII

List of CFR Sections Affected

All changes in this volume of the Code of Federal Regulations (CFR) that were made by documents published in the FEDERAL REGISTER since January 1, 2009 are enumerated in the following list. Entries indicate the nature of the changes effected. Page numbers refer to FEDERAL REGISTER pages. The user should consult the entries for chapters, parts and subparts as well as sections for revisions.

For changes to this volume of the CFR prior to this listing, consult the annual edition of the monthly List of CFR Sections Affected (LSA). The LSA is available at *www.fdsys.gov*. For changes to this volume of the CFR prior to 2001, see the “List of CFR Sections Affected, 1949–1963, 1964–1972, 1973–1985, and 1986–2000” published in 11 separate volumes. The “List of CFR Sections Affected 1986–2000” is available at *www.fdsys.gov*.

49 CFR	2009	74 FR Page	49 CFR—Continued	74 FR Page
Subtitle B			Chapter I—Continued	
Chapter I			172.320 (e) revised.....	53188
107 Authority citation revised	53185		172.322 (d)(1) and (e) revised.....	2252
107.329 (a) and (b) amended	68702		172.400a (c) revised	2252
107.301–107.339 (Subpart D) Ap- pendix A amended.....	53185, 68702		172.401 (c)(5) added.....	2252
107.705 (a)(1) revised.....	53185		172.402 (d)(1) revised	2252
171.1 (g) amended	68702		172.446 (b) revised	2252
171.7 (a)(3) table amended.....	1796, 2232		172.448 Revised	2252
(a)(2)(i) revised; (a)(3) table and (b) amended	16140		172.500 (b)(5) revised	2253
171.8 Amended.....	2233, 53185		172.604 Revised	53422
171.12 (a)(1) revised	53185		173.4 Revised.....	2253
171.14 (h) revised.....	2233		173.4a Added.....	2254
171.15 (b)(4) and (5) revised; (b)(6) added	2233		173.4b Added.....	2255
(a) introductory text revised	53186		173.5b Added	16142
171.16 (a)(3) and (4) revised; (a)(5) added	2233		173.12 (f) revised	2255
171.22 (a) revised	53186		173.21 (c) revised	2255
171.25 (c)(5) and (d)(3) added	2233		173.24 (c)(2) revised	2255
172 Technical correction.....	54489		173.24b (e) redesignated as (f) and revised; new (e) added	2255
172.101 Table amended	1796, 2233, 52900, 53186		173.31 (b)(6) introductory text and (e)(2)(ii) revised; (e)(2)(iii) and (iv) added	1799
Appendix B amended	2249		173.62 (b) table and (c) table amended	2256
Regulation at 74 FR 52900 con- firmed.....	65696		(c) table amended	53188
172.102 (c)(3) amended.....	1799		173.115 (b) revised; (k) redesi- gnated as (l); new (k) added	2256
(c)(1), (2), (4), (5) and (8) amended	2249		(c)(2) revised	16143
172.201 (d) revised.....	53422		173.124 (a)(2)(ii)(C) and (iii)(C) re- vised.....	53188
172.202 (a)(3) introductory text, (4) and (6)(vi) revised.....	2252		173.133 (a)(2)(i) Note (2) revised	53188
			173.134 (b)(13)(i) revised	2257
			173.137 (c)(2) revised; note added	2257
			173.159 Revised	2257

49 CFR (10–1–14 Edition)

49 CFR—Continued

74 FR
Page

Chapter I—Continued

173.159a Added..... 2258

173.168 (a) revised 2259

(d)(2) revised 53188

173.189 (e) revised 2259

173.196 (a)(1) and (2) revised 2259

173.206 Added 2259

173.220 (a)(2), (c), (d) and (e)(1) re-
vised; (g)(2) amended 2259

173.222 Heading and (c)(3) re-
vised 2259

173.225 (c)(8) table, (e) table and
(g) table amended 2260

173.226 (c) revised 2263

173.230 Revised 2263

173.244 (a) amended 1799

173.249 (a) amended; (g) added 1800

173.301 (i) revised 16143

173.304 (f)(3)(ii) revised 53188

173.304b Revised 2265

173.306 (a)(5) added; (b)(1), (2), (3),
(i) and (j) revised 2265

173.307 (a)(5) added 2266

173.314 (c) introductory text and
table revised; (c) notes 11 and 12
and (d) added 1800

173.322 (d) revised 2266

173.323 (c)(1) revised 1801

173.338 Revised 16143

174 Technical correction 54489

174.2 Added 1801

174.26 (b) revised 53423

174.59 Revised 53189

174.86 Revised 1801

175.10 (a) introductory text, (10),
(15)(i) through (iv), (17) and (18)
revised; (c) added 2266

175.33 (a)(1)(i) and (c)(4) revised;
(a)(11) added 2267

175.75 (d) and (e) revised; (f)
added 2267

175.88 (c) revised 2268

175.700 (a) revised 2268

176.2 Amended 2268

176.3 (a) revised 2268

176.84 (b) table amended 2268

176.172 (a) introductory text re-
vised 2268

176.200 (f) revised 16143

176.415 (c)(2) and (3) amended;
(c)(4) revised 53189

2010

49 CFR

75 FR
Page

Subtitle B

Chapter I

105 Authority citation revised 27211

105.40 (b) introductory text
amended 27211

107 Authority citation revised 15619,
27212

107.1 Amended 27212

107.105 (a) revised 27212

107.107 (b)(1), (3), (4) and (5) re-
vised 27212

107.109 Revised 27212

107.117 (d)(3) amended 53596

107.329 (a) and (b) amended 53596

107.612 (a) and (b) revised 15619

171.1 (g) amended 53596

171.6 (b)(2) table amended 53596

171.7 (a)(3) table correctly amend-
ed 69

(b) table amended 53596

171.8 Amended 5390, 27213, 60338

172.101 (1)(3) correctly revised;
table correctly amended 69

Table amended 5390, 53596

172.102 (c)(1), (4) Table 1 and Table
2 amended; (c)(4) introductory
text revised; (c)(4) Table 3
added 5391

172.202 (a)(4) correctly amend-
ed 72

172.322 (e)(2)(i) introductory text
and (ii) correctly amended 72

172.407 (c)(2) correctly revised 72

172.448 (c) correctly revised 72

172.514 (c)(3) and (4) revised; (c)(5)
added 5392

172.604 (b)(1) and (2) revised 53596

172.704 (a)(5) and (c)(2) revised 10988

172.800 (b) revised 10988

(b)(2), (7) and (9) revised 53597

172.802 (b) redesignated as (c); (a)
introductory text and new (c)
revised; new (b) and (d)
added 10989

173.3 (d)(6) revised 27213

173.4 (a)(5) amended 5393

173.4a (c)(1), (e)(3)(i) and (g)(2)
correctly revised 72

173.4b (a)(4) amended 5393

173.5a (b) revised 27213

173.7 (c) amended 5393

173.12 (b) and (e) revised; (f) redesi-
gnated as (g); new (f) added 27214

173.13 (c)(1)(ii) revised 27215

173.22 (a)(4) amended 5393, 60339

List of CFR Sections Affected

49 CFR—Continued

75 FR
Page

Chapter I—Continued

173.27 (f) introductory text re-
vised..... 53597

173.28 (a) and (f) amended..... 5393, 60339

173.29 (b)(2)(iv)(B) correctly re-
vised..... 72

173.31 (d)(1)(vi) revised..... 27215

173.35 (h)(2) introductory text
amended..... 5393

173.36 Added..... 5393

173.62 (c)(5) table correctly
amended..... 72
(c) table amended..... 5394

173.115 (b)(1) correctly amend-
ed..... 72

173.159a Heading correctly re-
vised; (b) correctly amend-
ed..... 72

173.171 Introductory text re-
vised..... 53597

173.197 (c) introductory text
amended..... 60339

173.206 (c) correctly revised..... 72

173.220 (d) correctly amended..... 73

173.223 Heading and (a) introduc-
tory text revised..... 5394

173.230 (e)(2)(i), (ii), (f)(2), (3) and
(4) correctly revised..... 73

173.240 (e) added..... 5394

173.241 (e) added..... 5394

173.242 (e) added..... 5395

173.249 (b) revised..... 5395

173.301 (h)(3)(ii) amended..... 5395

173.306 (a)(5)(v) correctly revised;
(a)(5)(vi) correctly redesign-
ated as (a)(5)(vii); new
(a)(5)(vi) correctly added..... 73
(a)(2)(i) revised..... 5395
(k) redesignated as (l); new (k)
added..... 27215

173.310 Added..... 27215

173.314 (c) table amended..... 53597

173.334 (d) amended..... 5395

173.338 (a) amended..... 5395

174 Authority citation revised..... 5395

174.63 Heading and (a) revised..... 5395

174.81 (c) revised..... 27215

175.10 (a)(15)(iv)(B) and (18)(ii)
correctly revised..... 73

176.54 (b)(1) amended..... 53597

176.83 (a)(11) revised..... 27215

177.843 (a) revised..... 53597

177.848 (c) revised..... 27216

2011

49 CFR

76 FR
Page

Subtitle B

Chapter I

105 Policy statement..... 37661

105.20 (a)(4) amended..... 56310

105.25 (b)(2)(iv) amended..... 56310

105.35 (a)(4) added..... 460

105.40 (d) amended..... 56310

106.95 (a) amended..... 56310

107 Policy statement..... 37661

107.1 Amended..... 460

107.105 Revised..... 460
(c)(14) added..... 43524
(a)(1)(ii) and (iii) revised;
(a)(1)(iv) added..... 44500
(a)(1)(iii) amended..... 56310

107.107 Revised..... 461
(b)(7) added..... 43524
(b)(3) revised..... 44500
(b)(1)(iii) amended..... 56310

107.109 Revised..... 462
(a)(9) added..... 43524
(a)(3) revised..... 44501
(a)(1)(iii) amended..... 56310

107.113 (a), (d), (f)(5), (g) and (h) re-
vised..... 463

107.117 (d)(5) revised..... 463

107.121 Revised..... 463

107.123 Revised..... 463

107.125 (a)(1) and (c) revised..... 463

109 Added..... 11592
Policy statement..... 37661

107.127 (a) amended..... 56310

107.305 (b)(4) amended..... 56311

107.608 (d) revised..... 56311

107.616 (a) revised..... 56311

107.805 (f) amended..... 56311

130.31 (a) introductory text and
(b) introductory text re-
vised..... 56311

171 Policy statement..... 37661

171.7 (a)(3) table amended..... 3343, 5491,
32873, 43524, 56311

171.8 Amended..... 464, 3345, 43525

171.14 Removed..... 43525

171.15 (a) introductory text re-
vised..... 43525

171.16 (b)(1) revised..... 56311

171.22 (f)(2) revised..... 56311

171.23 (b)(9) removed..... 3345
(a)(4)(ii) revised..... 56311

171.25 (b)(1) amended; (b)(4)
added; (c)(5) and (d)(3) re-
moved..... 3345

172 Policy statement..... 37661

172.101 (c)(10)(i) revised; (e) and
Table amended..... 3345

49 CFR (10-1-14 Edition)

49 CFR—Continued

	76 FR Page
Chapter I—Continued	
Appendix A amended.....	37285
(c)(2) revised; table amended	43525
Table amended.....	56312, 82172
172.102 (c)(1), (2), (7)(ii) Table, (8) and (9) amended; (c)(4) Table 1 and (7)(ii) revised.....	3362
(c)(1) amended.....	43526
172.200 (b)(3) revised	3365
172.202 (b) revised.....	43527
172.203 (b) revised	3365
(i)(2) revised; (p) added.....	43527
(p) revised	81400
172.300 (c) added.....	3365
172.301 (a)(1) revised	3365
(f) revised.....	56314
172.312 (c)(5) revised	3365
172.315 Revised.....	3365, 82174
172.316 (a)(1) and (2) revised.....	3366
172.322 (d)(4) added.....	3367
172.323 (a) introductory text re- vised.....	56314
172.324 (a) amended; (b) revised; (c) added.....	3367
172.326 (a) amended.....	3367
172.327 Added	3367
172.336 (d) added	43527
172.400a (d) revised.....	56314
172.402 (b) revised.....	56314
172.404 Revised	43527
172.432 (a) revised; (c) added.....	43527
(c) amended.....	56314
(a) revised	81400
172.446 (a) revised; (c) added.....	43528
(c) amended.....	56314
(a) revised	81400
172.500 (b)(3) revised	3367
172.502 (b)(2) revised	3367
172.512 (b) revised.....	56314
172.514 (c)(4) revised.....	43528
172.519 (c)(1) revised	43528
(b)(4) revised; (f) amended.....	56314
172.552 (c) added	43528
172.704 (a)(4) revised.....	56314
172.800 (b)(15) revised	56314
172.820 (b) introductory text and (f) revised	56314
173 Policy statement	37661, 38053
173.3 (c)(6) and (d)(6) revised	43528
173.4 (a) introductory text and (c) revised; (a)(1)(v) added.....	3368
173.4a (a)(4) and (g)(3) added; (b)(1), (5) and (d)(3) revised	3368
173.4b (b) added.....	3368
173.5 (d), (e) and (f) redesignated as (f), (g) and (h); new (d) and (e) added	5491

49 CFR—Continued

	76 FR Page
Chapter I—Continued	
173.5a Heading revised; (c) added	5492
173.8 (d)(6) revised.....	56315
173.12 Second (f) following (g) re- moved	56315
173.22a (b) amended.....	56315
173.23 (h) redesignated as (i); new (h) added	5492
173.24b (e) heading revised.....	56315
173.25 (a)(6) added	3368
173.27 (f) introductory text re- moved; (f)(1), (2), (3) and table 3 added	3368
(f)(2)(i) and (3) Table 3 revised	82175
173.32 (c)(2) amended.....	81400
173.40 (c)(1) amended	3371
173.52 (b) Table 2 revised.....	56315
173.57 (c)(1) revised	56315
173.58 (a)(5) revised	3371
(b) heading revised	56315
173.59 Amended	3371
173.60 (b)(14) revised.....	43529
173.62 (c) table amended	43529
(c)(5) table amended	56315
173.63 (b) revised.....	3371
173.115 (a)(2) and (1)(3) revised	56316
173.120 (c)(1)(i) and (ii) revised	3371
(e) added	43529
(d) amended	56316
173.121 (a) revised	3372
(c) added	43529
173.124 (b)(2) revised	3372
(b)(2) heading revised	82177
173.132 (e) added	43529
173.133 (c) added	43529
173.134 (c)(2) revised	43530
173.136 (a) revised	3372
173.137 Introductory text amend- ed.....	3372
173.144 Revised	3372
173.150 (b) and (c) revised	3373
173.151 (b), (c) and (d) revised	3373
(d) amended	82177
173.152 (b) and (c) revised	3374
173.153 (b) and (c) revised	3374
173.154 (b) and (c) revised	3374
173.155 (b) and (c) revised	3375
173.156 Revised	3375
(b)(1) introductory text revised	82177
173.161 Revised.....	3375
173.165 Added	3376
173.167 Added	3377
173.168 (d)(2) introductory text re- vised.....	56316
173.175 Added	43530

List of CFR Sections Affected

49 CFR—Continued

	76 FR Page
Chapter I—Continued	
173.189 (a) amended	43530
173.220 Revised	3377
173.225 (c)(8) table and (e) table amended	3378
173.230 (g) and (h) revised	3379
173.242 (b) introductory text re- vised	5492
173.301 (f)(2) revised; (o) redesign- ated as (l)	56316
173.301a (d)(3) revised	56317
173.301b (c)(2)(iii) and (e) re- vised	3380
173.302 (f)(3)(ii) and (4) revised	56317
173.304 (f)(3)(ii) and (4) revised	56317
173.306 (h)(2), (i) and (l) revised	3380
(a)(3)(v) revised	56317
(a) introductory text, (l), (3) intro- ductory text, (5) introduc- tory text and (b) introductory text amended; (h)(2)(i) revised	82178
173.307 (a)(6) added	3380
173.311 Added	3381
Amended	82178
173.315 (j) and (m) revised	5493
173.322 (e) added	3381
174 Policy statement	37661
174.55 (a) revised	43530
174.67 (a)(6), (b) introductory text, (l) and (c) introductory text revised	43530
174.101 (o)(2) and (3) revised	43531
174.104 (f) revised	56317
(f) amended	81400
174.112 (c)(3) revised	43531
174.115 (b)(3) revised	43531
175 Policy statement	37661
175.8 (b)(3) amended	3381
175.9 Revised	3381
175.10 (a)(17) and (18) redesignated as (a)(18) and (19); new (a)(17) added; new (a)(19) revised	3381
(a)(17)(i)(B) and (ii)(B) revised	43531
(a)(19) revised	82178
175.25 Revised	3382
175.30 (e)(3) revised	3383
175.75 Revised	3383
175.78 (c)(4)(iii) revised	3384
176 Policy statement	37661
Authority citation revised	56317
176.2 Amended	3384
176.63 (f)(2) revised	3384
175.75 Revised	82178
176.76 (a)(9) added	3384
176.77 (c) revised	56317
176.84 (b) table amended	3384

49 CFR—Continued

	76 FR Page
Chapter I—Continued	
176.137 (b) revised	56317
176.142 Removed	3384
176.905 Revised	3384
(j) revised	82179
177.804 Existing text designated as (a); new (a) heading and (b) added	10778
(c) added	75485
177.834 (o)(3) revised; (o)(4) re- moved	56317
177.835 (k) added	32873
(g)(3) introductory text and (ii) revised	56318
177.840 (a)(1) and (u) revised	56318
177.848 (c) revised	43531
(g)(3)(vi) amended	56318

2012

49 CFR

	77 FR Page
Subtitle B	
Chapter I	
107 Authority citation revised	60939
107.202 (a)(4) revised	60939
171.7 (a)(3) table amended	37983, 60939
171.8 Amended	37983, 60939
172.101 (c)(10)(ii) revised	60939
Table amended	60940
172.102 (c)(3) and (5) amended	60942
172.201 (a)(2) revised; (a)(5) added	37983
172.202 (b) amended	37983
172.204 (a) introductory text amended; (a)(3) and (d)(3) added	37983
(a)(2) amended	60942
172.514 (c)(4) revised	60942
172.604 (a) introductory text and (a)(3)(ii) revised	37984
173 Policy statement	429, 9865
173.12 (b)(2)(ii)(B) and (C) re- vised	60942
173.27 (a), (d) and (e) revised	22509
173.35 (g) and (h) revised	60942
173.133 (e) redesignated as (c) and revised; CFR correction	60056
173.134 Second (c) removed; (c)(2) revised; CFR correction	60056
Second (c) redesignated as (e) and revised	60942
173.159a (c) introductory text re- vised	60942
173.314 (e) and (k) revised	37984
173.319 (a)(3) revised	60942
173.435 Table amended	60942
174.63 (c)(2) revised	37985

49 CFR (10–1–14 Edition)

49 CFR—Continued 77 FR
Page

Chapter I—Continued

175.702 (a)(2)(ii) table heading re-
vised.....60943

2013

49 CFR 78 FR
Page

Subtitle B

Chapter I

Chapter I Policy statement41853

105.40 (d) revised15321

107 Authority citation revised22800,
23506,60733

107.329 Revised22800

107.301–107.339 (Subpart D) Ap-
pendix A amended.....22800

Appendix A revised.....60733

107.401 Revised42473

107.402 Revised42473

(d)(1)(ii) revised60750

107.403 Heading and (c) revised;
(d) added42474

107.405 Removed42474

107.612 Revised23506

107.801 (b) amended60750

107.803 (c)(6) revised60750

109 Authority citation revised60763

109.5 (a) introductory text re-
vised; (b) added60763

109.16 Added60763

109.25 (Subpart D) Added60763

130 Authority citation revised60750

171 Authority citation revised22800

171.1 (g) revised.....22800

171.7 Revised1027

Amended15321

(dd)(2) revised65468

171.8 Amended.....1033, 42474, 65468

171.16 (d)(2) revised1112

171.23 (a)(4)(iii) added; eff. 10-1-
13.....60751

172 Technical correction17874

Authority citation revised42475,
45892

172.101 (c)(10)(i) introductory text
and (k) revised; (c)(10)(iii) and
table amended.....1033

Table corrected8431

Table amended.....14712, 15322, 17874,
42475, 65469

(c)(6) and table revised.....60751

Table correctly amended; CFR
correction.....69310

172.102 (c)(1), (2), (3), (8)(ii) and (9)
amended; (c)(4) Table 1 and
(7)(iii) revised.....1070

49 CFR—Continued 78 FR
Page

Chapter I—Continued

(c)(1) amended ...1112, 14714, 42477, 45892,
65478

(c)(1) amended; (c)(6) revised15326

(c)(1) and (7)(ii) table amended
.....60753

172.200 (b)(3) revised1112

172.202 (a)(6)(vii) added1072

(a)(6)(vii) revised.....65478

172.203 (i)(3) revised1072

(e)(1) and (2) revised15326

(k) introductory text and (1) re-
vised60753

172.204 (d) introductory text re-
vised.....15326

172.301 (a)(1) revised1072

(a)(1)(i) revised.....65478

172.312 (c)(3) revised1073

172.315 (d) revised1113

(d)(1) revised65478

172.316 (a)(2) revised1113

(a) revised65478

172.320 (b) and (d) revised42477

172.336 (c) revised14714, 65478

172.400 (b) table amended60753

172.407 (f) revised1073

172.512 (b)(1)(iii) revised60753

172.604 (d)(2) revised1073

(d)(1) revised60753

173 Authority citation revised42477,
45892

Technical correction17874

Policy statement60763, 60766

173.4b (b)(8) revised1073

173.6 (a)(6) added.....1113

(a)(2) revised15326

(a)(6) amended.....65478

173.12 (b)(2)(ii)(A) revised1073

(b)(3) revised15326

173.21 (f)(3)(ii) revised1073

173.22 (a)(4) revised1113

(a)(4)(ii) amended.....60754

(a)(4)(ii) and (iii) revised65478

173.24 (i) revised65479

173.25 (a)(6) revised; (a)(7)
added1113

(a)(6) and (7) revised65479

173.27 (f)(2)(i)(F) revised; (f)(3)
Table 3 amended65479

173.33 (g) revised15326

173.37 Added1073

173.50 (b)(5) revised1074

173.52 (b) Table 1 amended1074

173.56 (h)(2) revised1074

(b) introductory text revised; (j)
removed.....42477

173.59 Amended1074, 42477

List of CFR Sections Affected

49 CFR—Continued

78 FR
Page

Chapter I—Continued

173.62 (c) table amended..... 1074, 65479
(c)(5) table amended15326
(b) table amended60754

173.63 (b) revised 1084, 65480
(b)(1)(ii) revised1113

173.64 Added 42477

173.65 Added 42477

173.115 (k) revised 1085

173.121 (b)(1)(iii) revised 1085

173.124 (a)(2)(iv) revised 60754

173.134 (c)(2) revised 15327

173.144 Revised 1113, 65481

173.150 (c) revised 1114
(d) revised15327
(d)(2)(ii) and (ii) revised65481

173.151 (b) and (c) revised 1114

173.152 (c) revised 1114

173.153 (c) revised 1114

173.154 (c) revised 1114

173.155 (c) revised 1114

173.156 Revised 1114
(b)(1) introductory text re-
vised;(b)(2)(vi) removed.....65481

173.158 (d)(2), (e), (f)(3), (g) and (h)
introductory text revised 1085

173.159a (d)(3) added..... 1085
(c) introductory text and (1) re-
vised15328

173.160 Revised 1085

173.161 (d)(2) revised 1115

173.162 (a)(1), (2) and (c) re-
vised 1085

173.164 (a)(1), (b) and (c)(2) re-
vised; (a)(5) and (f) added..... 1085

173.165 Revised 1086, 65481
(c) revised1115

173.166 Revised 45892

173.167 Revised 1115
(a) introductory text revised65482

173.171 Introductory text, (a), (c)
and (d) revised 14714, 65482

173.175 (g) added 1087

173.176 Added 1087
(a)(2)(i) and (ii) revised 65482

173.181 (b) and (c) revised 1087

173.183 (a) revised 1087

173.184 (b) revised 1088

173.185 (a)(1) revised 65482

173.186 (e) revised 1088

173.187 (a) and (d) revised 1088

173.188 (a)(1) introductory text,
(2) and (b)(1) revised 1088

173.189 (b) revised 1088

173.193 (a) amended 1088

173.194 (b)(1) and (2) revised 1088

173.196 (a)(3) revised 1088

49 CFR—Continued

78 FR
Page

Chapter I—Continued

173.199 (d)(1) revised 1088
(d)(2) revised60754

173.201 (b) amended 1089

173.202 (b) amended 1089

173.203 (b) amended 1089

173.211 (b) and (c) amended 1089

173.212 (b) and (c) amended 1089

173.213 (b) and (c) amended 1089

173.219 (b)(1), (c)(1) and (5) re-
vised 1089

173.220 (d) revised 1089
(a)(1) and (2) revised 60754

173.221 (a) revised; (c) added 1089

173.225 (c) table and (e) table
amended 1089
(c) table and (e) table revised 65482

173.226 (c)(1) amended 1090

173.230 (e)(2)(ii) and (f)(3) re-
vised 1091
(h) revised1116
(f)(3) amended 65485

173.240 (f) added 1091

173.301 (f)(1) and (j) revised 60754

173.301b (c)(2)(ii) and (d) re-
vised 1091
(d)(1) amended 65485

173.302a (a)(3) revised 1091

173.304 (d) heading amended 60754

173.306 (j) revised 1091
(i)(2) revised1116

173.309 Revised 1116

173.313 Heading and introductory
text revised; table amended 1091

173.316 (a)(8) redesignated as
(a)(9); new (a)(8) added 1092

173.318 (b)(7)(vi) added 1092

173.335 Added 1092

173.340 (c)(1), (2) and (d) re-
vised 1092

173.476 (d) revised 60754

174 Authority citation revised 60754

175 Authority citation revised 65485

175.8 (b)(3) revised 1092

175.10 (a)(14), (15), (18) introduc-
tory text, (19)(vii) AND (viii)
revised; (a)(18)(iii) and (20)
through (24) added 1093
(a)(17) revised1117
(a)(15)(v)(C), (19)(vii), (viii) and
(24) revised; (a)(21) amended 65485

175.25 (b) and (c)(1) revised 1117
Revised 65486

175.75 (c) and (e)(1) revised; (f)
table amended 65486

176 Technical correction 17874
Authority citation revised 65486

49 CFR (10–1–14 Edition)

49 CFR—Continued 78 FR
Page

Chapter I—Continued

176.2 Amended.....1093

176.30 (a) introductory text re-
vised.....14714

176.63 (a), (b) and (e) revised1094

176.76 (a)(11) added.....1094

176.83 (m)(1), (2) and (3) revised.....1094

176.84 (a) revised; (b) table and
(c)(2) table amended1094

176.116 (a) revised; (f) removed1095

176.128 Removed.....1095

176.130 Removed.....1095

176.133 Removed.....1095

176.134 Removed.....1095

176.136 Removed.....1095

176.138 (b) revised1095

176.144 (a) table amended; (d) re-
vised1095

176.146 (a) and (b) revised; (c) re-
moved.....1095

176.170 (a) revised; (c) removed.....1095

176.200 (c) revised1095

176.210 Revised.....1095

176.230 Revised.....1096

176.305 (a) revised1096

176.400 (a) and (b) revised1096

176.600 (d) revised1096

176.900–176.905 (Subpart O) Head-
ing revised1096

176.905 (i) revised.....1117, 65486

176.907 Added1096

177 Authority citation revised;
eff. 10-25-2013.....58923

Authority citation revised60754

177.804 Revised; eff. 10-25-201358923

177.834 (j)(2) revised15328

2014

(Regulations published from January 1,
2014, through October 1, 2014)

49 CFR 79 FR
Page

Subtitle B

Chapter I

107 Authority citation revised46199

107.338 Added.....46199

107.705 (c) revised.....15043

109 Heading revised.....46199

Policy statement55403

109.101–109.103 (Subpart E)
Added.....46199

171 Policy statement55403

171.7 (n)(3) revised.....15043

49 CFR—Continued 79 FR
Page

Chapter I—Continued

(d)(2), (i), (p) and (ee) removed;
(d)(3) through (8), (j) through
(o) and (q) through (dd) redesign-
ated as new (d)(2) through (7),
new (i) through (m) and new (n)
through (bb); (a)(1), new (q)(1)
and new (u)(9) revised40609

171.8 Amended46034

171.12 (a)(6) revised46034

171.24 (d)(1)(ii) and (iii) revised46034

171.25 (b)(3) revised46034

172 Policy statement55403

172.101 Table amended15043, 46034

172.102 (c)(1), (3) and (5) amend-
ed15045

(c)(1) and (2) amended46036

172.203 (d)(2), (3) and (4) re-
vised.....40609

172.310 (b) revised.....40609

172.402 (d)(1) revised.....40609

172.403 (d) and (g)(2) revised.....40609

172.504 (e) Table 1 footnote 1 re-
vised.....40610

172.505 (b) revised.....40610

173 Policy statement55403, 56988,
56989

173.4 (a)(1)(iv) removed; (b) re-
vised.....40610

173.25 (a)(4) revised40610

173.62 (c)(5) table corrected; CFR
correction43266

173.150 (g) added.....15045

173.185 Revised46036

173.219 (b)(3) revised.....46039

173.220 (d) and (f)(1) revised.....46039

173.401 (b)(4) revised; (b)(5)
added.....40610

173.403 Amended40610

173.410 (i)(3) revised40611

173.411 Revised40611

173.412 (f) and (k)(3)(ii) revised40612

173.415 (a) revised.....40612

173.416 (c) revised.....40612

173.417 (a)(3), (b)(3) and Table 3 re-
moved; (c) revised40612

173.420 (a)(2)(ii) removed; (a)(3)(i)
and (6) revised; (e) added.....40612

173.421 Revised40613

173.422 Introductory text, (a) and
(e) revised40613

173.427 Revised40613

173.433 (b) introductory text, (c)
introductory text, (1), (d)(3)
and (h) revised40614

173.435 Table amended40615

173.436 Table amended40615

List of CFR Sections Affected

49 CFR—Continued	79 FR Page	49 CFR—Continued	79 FR Page
Chapter I—Continued		Chapter I—Continued	
173.443 Revised	40616	175.8 (a)(4) added	46039
173.465 (a) and (d)(1)(i) revised	40617	175.10 (a)(18) revised	46040
173.466 (a) revised	40617	175.30 (a)(5) added	46040
173.469 (b)(2)(ii), (iii), (d)(1) and (2) revised; (e) added	40617	175.33 (a)(12) and (c)(5) added	46040
173.473 (a)(1) revised	40617	175.34 Added	15046
173.476 (a) revised	40617	175.702 (b) revised; (c) removed	40618
173.477 (a) revised	40617	175.705 (c) revised	40618
174 Policy statement	55403	176 Policy statement	55403
174.700 (e) removed	40618	176.715 Revised	40618
174.715 (a) revised	40618	177 Authority citation revised	40618
175 Policy statement	55403	Policy statement	55403
		177.843 (a) revised	40618

