

172 of this subchapter pertaining to shipping papers and placarding, and otherwise conforms to the applicable requirements of part 176 of this subchapter.

(2) The requirement in §172.201(d) of this subchapter for an emergency telephone number does not apply to shipments made in accordance with the IMDG Code if the hazardous material is not offloaded from the vessel, or is offloaded between ocean vessels at a U.S. port facility without being transported by public highway.

[72 FR 25172, May 3, 2007, as amended at 72 FR 44847, Aug. 9, 2007; 73 FR 57004, Oct. 1, 2008; 74 FR 2233, Jan. 14, 2009; 76 FR 3345, Jan. 19, 2011; 79 FR 46034, Aug. 6, 2014; 80 FR 1116, Jan. 8, 2015; 87 FR 78010, Dec. 21, 2022]

§ 171.26 Additional requirements for the use of the IAEA Regulations.

A Class 7 (radioactive) material being imported into or exported from the United States or passing through the United States in the course of being shipped between places outside the United States may be offered for transportation or transported in accordance with the IAEA Regulations (IBR, see §171.7) as authorized in paragraph (a) of §171.22, provided the requirements in §171.22, as applicable, are met.

PART 172—HAZARDOUS MATERIALS TABLE, SPECIAL PROVISIONS, HAZARDOUS MATERIALS COMMUNICATIONS, EMERGENCY RESPONSE INFORMATION, TRAINING REQUIREMENTS, AND SECURITY PLANS

Subpart A—General

- Sec.
- 172.1 Purpose and scope.
- 172.3 Applicability.

Subpart B—Table of Hazardous Materials and Special Provisions

- 172.101 Purpose and use of hazardous materials table.
- 172.102 Special provisions.

Subpart C—Shipping Papers

- 172.200 Applicability.
- 172.201 Preparation and retention of shipping papers.

- 172.202 Description of hazardous material on shipping papers.
- 172.203 Additional description requirements.
- 172.204 Shipper's certification.
- 172.205 Hazardous waste manifest.

Subpart D—Marking

- 172.300 Applicability.
- 172.301 General marking requirements for non-bulk packagings.
- 172.302 General marking requirements for bulk packagings.
- 172.303 Prohibited marking.
- 172.304 Marking requirements.
- 172.306 [Reserved]
- 172.308 Authorized abbreviations.
- 172.310 Class 7 (radioactive) materials.
- 172.312 Liquid hazardous materials in non-bulk packagings.
- 172.313 Poisonous hazardous materials.
- 172.315 Limited quantities.
- 172.316 [Reserved]
- 172.317 KEEP AWAY FROM HEAT handling mark.
- 172.320 Explosive hazardous materials.
- 172.322 Marine pollutants.
- 172.323 Infectious substances.
- 172.324 Hazardous substances in non-bulk packagings.
- 172.325 Elevated temperature materials.
- 172.326 Portable tanks.
- 172.327 Petroleum sour crude oil in bulk packaging.
- 172.328 Cargo tanks.
- 172.330 Tank cars and multi-unit tank car tanks.
- 172.331 Bulk packagings other than portable tanks, cargo tanks, tank cars and multi-unit tank car tanks.
- 172.332 Identification number markings.
- 172.334 Identification numbers; prohibited display.
- 172.336 Identification numbers; special provisions.
- 172.338 Replacement of identification numbers.

Subpart E—Labeling

- 172.400 General labeling requirements.
- 172.400a Exceptions from labeling.
- 172.401 Prohibited labeling.
- 172.402 Additional labeling requirements.
- 172.403 Class 7 (radioactive) material.
- 172.404 Labels for mixed and consolidated packaging.
- 172.405 Authorized label modifications.
- 172.406 Placement of labels.
- 172.407 Label specifications.
- 172.411 EXPLOSIVE 1.1, 1.2, 1.3, 1.4, 1.5 and 1.6 labels, and EXPLOSIVE Subsidiary label.
- 172.415 NON-FLAMMABLE GAS label.
- 172.416 POISON GAS label.
- 172.417 FLAMMABLE GAS label.
- 172.419 FLAMMABLE LIQUID label.

§ 172.1

- 172.420 FLAMMABLE SOLID label.
- 172.422 SPONTANEOUSLY COMBUSTIBLE label.
- 172.423 DANGEROUS WHEN WET label.
- 172.426 OXIDIZER label.
- 172.427 ORGANIC PEROXIDE label.
- 172.429 POISON INHALATION HAZARD label.
- 172.430 POISON label.
- 172.431 [Reserved]
- 172.432 INFECTIOUS SUBSTANCE label.
- 172.436 RADIOACTIVE WHITE-I label.
- 172.438 RADIOACTIVE YELLOW-II label.
- 172.440 RADIOACTIVE YELLOW-III label.
- 172.441 FISSILE label.
- 172.442 CORROSIVE label.
- 172.444 [Reserved]
- 172.446 CLASS 9 label.
- 172.447 LITHIUM BATTERY label.
- 172.448 CARGO AIRCRAFT ONLY label.
- 172.450 EMPTY label.

Subpart F—Placarding

- 172.500 Applicability of placarding requirements.
- 172.502 Prohibited and permissive placarding.
- 172.503 Identification number display on placards.
- 172.504 General placarding requirements.
- 172.505 Placarding for subsidiary hazards.
- 172.506 Providing and affixing placards: Highway.
- 172.507 Special placarding provisions: Highway.
- 172.508 Placarding and affixing placarding: Rail.
- 172.510 Special placarding provisions: Rail.
- 172.512 Freight containers and aircraft unit load devices.
- 172.514 Bulk packagings.
- 172.516 Visibility and display of placards.
- 172.519 General specifications for placards.
- 172.521 DANGEROUS placard.
- 172.522 EXPLOSIVES 1.1, EXPLOSIVES 1.2 and EXPLOSIVES 1.3 placards.
- 172.523 EXPLOSIVES 1.4 placard.
- 172.524 EXPLOSIVES 1.5 placard.
- 172.525 EXPLOSIVES 1.6 placard.
- 172.526 [Reserved]
- 172.527 Background requirements for certain placards.
- 172.528 NON-FLAMMABLE GAS placard.
- 172.530 OXYGEN placard.
- 172.532 FLAMMABLE GAS placard.
- 172.536 [Reserved]
- 172.540 POISON GAS placard.
- 172.542 FLAMMABLE placard.
- 172.544 COMBUSTIBLE placard.
- 172.546 FLAMMABLE SOLID placard.
- 172.547 SPONTANEOUSLY COMBUSTIBLE placard.
- 172.548 DANGEROUS WHEN WET placard.
- 172.550 OXIDIZER placard.
- 172.552 ORGANIC PEROXIDE placard.
- 172.553 [Reserved]

49 CFR Ch. I (10–1–23 Edition)

- 172.554 POISON placard.
- 172.555 POISON INHALATION HAZARD placard.
- 172.556 RADIOACTIVE placard.
- 172.558 CORROSIVE placard.
- 172.560 CLASS 9 placard.

Subpart G—Emergency Response Information

- 172.600 Applicability and general requirements.
- 172.602 Emergency response information.
- 172.604 Emergency response telephone number.
- 172.606 Carrier information contact.

Subpart H—Training

- 172.700 Purpose and scope.
- 172.701 Federal-State relationship.
- 172.702 Applicability and responsibility for training and testing.
- 172.704 Training requirements.

Subpart I—Safety and Security Plans

- 172.800 Purpose and applicability.
- 172.802 Components of a security plan.
- 172.804 Relationship to other Federal requirements.
- 172.820 Additional planning requirements for transportation by rail.
- 172.822 Limitation on actions by states, local governments, and Indian tribes.
- APPENDIX A TO PART 172—OFFICE OF HAZARDOUS MATERIALS TRANSPORTATION COLOR TOLERANCE CHARTS AND TABLES
- APPENDIX B TO PART 172—TREFOIL SYMBOL
- APPENDIX C TO PART 172—DIMENSIONAL SPECIFICATIONS FOR RECOMMENDED PLACARD HOLDER
- APPENDIX D TO PART 172—RAIL RISK ANALYSIS FACTORS

AUTHORITY: 49 U.S.C. 5101–5128, 44701; 49 CFR 1.81, 1.96 and 1.97.

SOURCE: Amdt. 172–29, 41 FR 15996, Apr. 15, 1976, unless otherwise noted.

Subpart A—General

§ 172.1 Purpose and scope.

This part lists and classifies those materials which the Department has designated as hazardous materials for purposes of transportation and prescribes the requirements for shipping papers, package marking, labeling, and transport vehicle placarding applicable to the shipment and transportation of those hazardous materials.

[Amdt. 172–29, 41 FR 15997, Apr. 15, 1976, as amended by 66 FR 45379, Aug. 28, 2001]

§ 172.3 Applicability.

(a) This part applies to—

(1) Each person who offers a hazardous material for transportation, and

(2) Each carrier by air, highway, rail, or water who transports a hazardous material.

(b) When a person, other than one of those provided for in paragraph (a) of this section, performs a packaging labeling or marking function required by this part, that person shall perform the function in accordance with this part.

[Amdt. 172-29, 41 FR 15996, Apr. 15, 1976, as amended by Amdt. 172-32, 41 FR 38179, Sept. 9, 1976]

Subpart B—Table of Hazardous Materials and Special Provisions

§ 172.101 Purpose and use of hazardous materials table.

(a) The Hazardous Materials Table (Table) in this section designates the materials listed therein as hazardous materials for the purpose of transportation of those materials. For each listed material, the Table identifies the hazard class or specifies that the material is forbidden in transportation, and gives the proper shipping name or directs the user to the preferred proper shipping name. In addition, the Table specifies or references requirements in this subchapter pertaining to labeling, packaging, quantity limits aboard aircraft and stowage of hazardous materials aboard vessels.

(b) *Column 1: Symbols.* Column 1 of the Table contains six symbols (“+”, “A”, “D”, “G”, “I” and “W”) as follows:

(1) The plus (+) sign fixes the proper shipping name, hazard class and packing group for that entry without regard to whether the material meets the definition of that class, packing group or any other hazard class definition. When the plus sign is assigned to a proper shipping name in Column (1) of the § 172.101 Table, it means that the material is known to pose a risk to humans. When a plus sign is assigned to mixtures or solutions containing a material where the hazard to humans is significantly different from that of the pure material or where no hazard to humans is posed, the material may be described using an alternative shipping

name that represents the hazards posed by the material. An appropriate alternate proper shipping name and hazard class may be authorized by the Associate Administrator.

(2) The letter “A” denotes a material that is subject to the requirements of this subchapter only when offered or intended for transportation by aircraft, unless the material is a hazardous substance or a hazardous waste. A shipping description entry preceded by an “A” may be used to describe a material for other modes of transportation provided all applicable requirements for the entry are met.

(3) The letter “D” identifies proper shipping names which are appropriate for describing materials for domestic transportation but may be inappropriate for international transportation under the provisions of international regulations (e.g., IMO, ICAO). An alternate proper shipping name may be selected when either domestic or international transportation is involved.

(4) The letter “G” identifies proper shipping names for which one or more technical names of the hazardous material must be entered in parentheses, in association with the basic description. (See § 172.203(k).)

(5) The letter “I” identifies proper shipping names which are appropriate for describing materials in international transportation. An alternate proper shipping name may be selected when only domestic transportation is involved.

(6) The letter “W” denotes a material that is subject to the requirements of this subchapter only when offered or intended for transportation by vessel, unless the material is a hazardous substance or a hazardous waste. A shipping description entry preceded by a “W” may be used to describe a material for other modes of transportation provided all applicable requirements for the entry are met.

(c) *Column 2: Hazardous materials descriptions and proper shipping names.* Column 2 lists the hazardous materials descriptions and proper shipping names of materials designated as hazardous materials. Modification of a proper shipping name may otherwise be required or authorized by this section. Proper shipping names are limited to

those shown in Roman type (not italics).

(1) Proper shipping names may be used in the singular or plural and in either capital or lower case letters. Words may be alternatively spelled in the same manner as they appear in the ICAO Technical Instructions or the IMDG Code. For example “aluminum” may be spelled “aluminium” and “sulfur” may be spelled “sulphur”. However, the word “inflammable” may not be used in place of the word “flammable”.

(2) Punctuation marks and words in italics are not part of the proper shipping name, but may be used in addition to the proper shipping name. The word “or” in italics indicates that there is a choice of terms in the sequence that may alternately be used as the proper shipping name or as part of the proper shipping name, as appropriate. For example, for the hazardous materials description “Carbon dioxide, solid or Dry ice” either “Carbon dioxide, solid” or “Dry ice” may be used as the proper shipping name; and for the hazardous materials description “Articles, pressurized pneumatic or hydraulic,” either “Articles, pressurized pneumatic” or “Articles, pressurized hydraulic” may be used as the proper shipping name.

(3) The word “poison” or “poisonous” may be used interchangeably with the word “toxic” when only domestic transportation is involved. The abbreviation “n.o.i.” or “n.o.i.b.n.” may be used interchangeably with “n.o.s.”.

(4) Except for hazardous wastes, when qualifying words are used as part of the proper shipping name, their sequence in the package markings and shipping paper description is optional. However, the entry in the Table reflects the preferred sequence.

(5) When one entry references another entry by use of the word “see”, if both names are in Roman type, either name may be used as the proper shipping name (e.g., Ethyl alcohol, *see* Ethanol).

(6) When a proper shipping name includes a concentration range as part of the shipping description, the actual concentration, if it is within the range stated, may be used in place of the concentration range. For example, an

aqueous solution of hydrogen peroxide containing 30 percent peroxide may be described as “Hydrogen peroxide, aqueous solution *with not less than 20 percent but not more than 40 percent hydrogen peroxide*” or “Hydrogen peroxide, aqueous solution *with 30 percent hydrogen peroxide*.” Also, the percent sign (%) may be used in place of the word “percent” when words in italics containing the word “percent” are used in addition to the proper shipping name.

(7) Use of the prefix “mono” is optional in any shipping name, when appropriate. Thus, Iodine monochloride may be used interchangeably with Iodine chloride. In “Glycerol alpha-monochlorohydrin” the term “mono” is considered a prefix to the term “chlorohydrin” and may be deleted.

(8) Use of the word “liquid” or “solid”. The word “liquid” or “solid” may be added to a proper shipping name when a hazardous material specifically listed by name may, due to differing physical states, be a liquid or solid. When the packaging specified in Column 8 is inappropriate for the physical state of the material, the table provided in paragraph (i)(4) of this section should be used to determine the appropriate packaging section.

(9) *Hazardous wastes*. If the word “waste” is not included in the hazardous material description in Column 2 of the Table, the proper shipping name for a hazardous waste (as defined in §171.8 of this subchapter), shall include the word “Waste” preceding the proper shipping name of the material. For example: Waste acetone.

(10) *Mixtures and solutions*. (i) A mixture or solution meeting the definition of one or more hazard class that is not identified specifically by name, comprised of a single predominant hazardous material identified in the Table by technical name and one or more hazardous and/or non-hazardous material, must be described using the proper shipping name of the hazardous material and the qualifying word “mixture” or “solution”, as appropriate, unless—

(A) Except as provided in §172.101(i)(4) the packaging specified in Column 8 is inappropriate to the physical state of the material;

(B) The shipping description indicates that the proper shipping name

applies only to the pure or technically pure hazardous material;

(C) The hazard class, packing group, or subsidiary hazard of the mixture or solution is different from that specified for the entry;

(D) There is a significant change in the measures to be taken in emergencies;

(E) The material is identified by special provision in Column 7 of the §172.101 Table as a material poisonous by inhalation; however, it no longer meets the definition of poisonous by inhalation or it falls within a different hazard zone than that specified in the special provision; or

(F) The material can be appropriately described by a shipping name that describes its intended application, such as "Coating solution", "Extracts, flavoring" or "Compound, cleaning liquid."

(ii) If one or more of the conditions in paragraphs (c)(10)(i)(A) through (F) of this section is satisfied then the proper shipping name selection process in (c)(12)(ii) must be used.

(iii) A mixture or solution meeting the definition of one or more hazard class that is not identified in the Table specifically by name, comprised of two or more hazardous materials in the same hazard class, must be described using an appropriate shipping description (e.g., "Flammable liquid, n.o.s."). The name that most appropriately describes the material shall be used; e.g., an alcohol not listed by its technical name in the Table shall be described as "Alcohol, n.o.s." rather than "Flammable liquid, n.o.s.". Some mixtures may be more appropriately described according to their application, such as "Coating solution" or "Extracts, flavoring liquid" rather than by an n.o.s. entry. Under the provisions of subparts C and D of this part, the technical names of at least two components most predominately contributing to the hazards of the mixture or solution may be required in association with the proper shipping name.

(11) Except for a material subject to or prohibited by §173.21, §173.54, §173.56(d), §173.56(e), §173.224(c) or §173.225(b) of this subchapter, a material that is considered to be a hazardous waste or a sample of a material

for which the hazard class is uncertain and must be determined by testing may be assigned a tentative proper shipping name, hazard class, identification number and packing group, if applicable, based on the shipper's tentative determination according to:

(i) Defining criteria in this subchapter;

(ii) The hazard precedence prescribed in §173.2a of this subchapter;

(iii) The shipper's knowledge of the material;

(iv) In addition to paragraphs (c)(11)(i) through (iii) of this section, for a sample of a material other than a waste, the following must be met:

(A) Except when the word "Sample" already appears in the proper shipping name, the word "Sample" must appear as part of the proper shipping name or in association with the basic description on the shipping paper.

(B) When the proper shipping description for a sample is assigned a "G" in Column (1) of the §172.101 Table, and the primary constituent(s) for which the tentative classification is based are not known, the provisions requiring a technical name for the constituent(s) do not apply; and

(C) A sample must be transported in a combination packaging that conforms to the requirements of this subchapter that are applicable to the tentative packing group assigned, and may not exceed a net mass of 2.5 kg (5.5 pounds) per package.

NOTE TO PARAGRAPH (c)(11): For the transportation of samples of self-reactive materials, organic peroxides, explosives or lighters, see §173.224(c)(3), §173.225(c)(2), §173.56(d) or §173.308(b)(2) of this subchapter, respectively.

(12) Except when the proper shipping name in the Table is preceded by a plus (+)—

(i) If it is specifically determined that a material meets the definition of a hazard class, packing group or hazard zone, other than the class, packing group or hazard zone shown in association with the proper shipping name, or does not meet the defining criteria for a subsidiary hazard shown in Column 6 of the Table, the material shall be described by an appropriate proper shipping name listed in association with the correct hazard class, packing

group, hazard zone, or subsidiary hazard for the material.

(ii) *Generic or n.o.s. descriptions.* If an appropriate technical name is not shown in the Table, selection of a proper shipping name shall be made from the generic or n.o.s. descriptions corresponding to the specific hazard class, packing group, hazard zone, or subsidiary hazard, if any, for the material. The name that most appropriately describes the material shall be used; e.g., an alcohol not listed by its technical name in the Table shall be described as “Alcohol, n.o.s.” rather than “Flammable liquid, n.o.s.”. Some mixtures may be more appropriately described according to their application, such as “Coating solution” or “Extracts, flavoring, liquid”, rather than by an n.o.s. entry, such as “Flammable liquid, n.o.s.” It should be noted, however, that an n.o.s. description as a proper shipping name may not provide sufficient information for shipping papers and package markings. Under the provisions of subparts C and D of this part, the technical name of one or more constituents which makes the product a hazardous material may be required in association with the proper shipping name.

(iii) *Multiple hazard materials.* If a material meets the definition of more than one hazard class, and is not identified in the Table specifically by name (e.g., acetyl chloride), the hazard class of the material shall be determined by using the precedence specified in §173.2a of this subchapter, and an appropriate shipping description (e.g., “Flammable liquid, corrosive n.o.s.”) shall be selected as described in paragraph (c)(12)(ii) of this section.

(iv) If it is specifically determined that a material is not a forbidden material and does not meet the definition of any hazard class, the material is not a hazardous material.

(13) *Self-reactive materials and organic peroxides.* A generic proper shipping name for a self-reactive material or an organic peroxide, as listed in Column 2 of the Table, must be selected based on the material’s technical name and concentration, in accordance with the provisions of §173.224 or §173.225 of this subchapter, respectively.

(14) A proper shipping name that describes all isomers of a material may be used to identify any isomer of that material if the isomer meets criteria for the same hazard class or division, subsidiary risk(s) and packing group, unless the isomer is specifically identified in the Table.

(15) Unless a hydrate is specifically listed in the Table, a proper shipping name for the equivalent anhydrous substance may be used, if the hydrate meets the same hazard class or division, subsidiary risk(s) and packing group.

(16) Unless it is already included in the proper shipping name in the §172.101 Table, the qualifying words “liquid” or “solid” may be added in association with the proper shipping name when a hazardous material specifically listed by name in the §172.101 Table may, due to the differing physical states of the various isomers of the material, be either a liquid or a solid (for example “Dinitrotoluenes, liquid” and “Dinitrotoluenes, solid”). Use of the words “liquid” or “solid” is subject to the limitations specified for the use of the words “mixture” or “solution” in paragraph (c)(10) of this section. The qualifying word “molten” may be added in association with the proper shipping name when a hazardous material, which is a solid in accordance with the definition in §171.8 of this subchapter, is offered for transportation in the molten state (for example, “Alkylphenols, solid, n.o.s., molten”).

(17) Unless it is already included in the proper shipping name in the §172.101 Table, the qualifying word “stabilized” may be added in association with the proper shipping name, as appropriate, where without stabilization the substance would be forbidden for transportation according to §173.21(f) of this subchapter.

(d) *Column 3: Hazard class or Division.* Column 3 contains a designation of the hazard class or division corresponding to each proper shipping name, or the word “Forbidden”.

(1) A material for which the entry in this column is “Forbidden” may not be offered for transportation or transported. This prohibition does not apply if the material is diluted, stabilized or incorporated in a device and it is

classed in accordance with the definitions of hazardous materials contained in part 173 of this subchapter.

(2) When a reevaluation of test data or new data indicates a need to modify the "Forbidden" designation or the hazard class or packing group specified for a material specifically identified in the Table, this data should be submitted to the Associate Administrator.

(3) A basic description of each hazard class and the section reference for class definitions appear in §173.2 of this subchapter.

(4) Each reference to a Class 3 material is modified to read "Combustible liquid" when that material is reclassified in accordance with §173.150(e) or (f) of this subchapter or has a flash point above 60 °C (140 °F) but below 93 °C (200 °F).

(e) *Column 4: Identification number.* Column 4 lists the identification number assigned to each proper shipping name. Those preceded by the letters "UN" are associated with proper shipping names considered appropriate for international transportation as well as domestic transportation. Those preceded by the letters "NA" are associated with proper shipping names not recognized for transportation outside of the United States. Identification numbers in the "NA9000" series are associated with proper shipping names not appropriately covered by international hazardous materials (dangerous goods) transportation standards, or not appropriately addressed by international transportation standards for emergency response information purposes, except for transportation in the United States. Those preceded by the letters "ID" are associated with proper shipping names recognized by the ICAO Technical Instructions (see §171.7 of this subchapter for availability).

(f) *Column 5: Packing group.* Column 5 specifies one or more packing groups assigned to a material corresponding to the proper shipping name and hazard class for that material. Class 2, Class 7, and Division 6.2 do not have packing groups. Articles in classes other than Class 1 are not assigned to packing groups. For packing purposes, any requirement for a specific packaging performance level is set out in the appli-

cable packing authorizations of part 173. Packing Groups I, II, and III indicate the degree of danger presented by the material is great, medium, or minor, respectively. If more than one packing group is indicated for an entry, the packing group for the hazardous material is determined using the criteria for assignment of packing groups specified in subpart D of part 173. When a reevaluation of test data or new data indicates a need to modify the specified packing group(s), the data should be submitted to the Associate Administrator. Each reference in this column to a material that is a hazardous waste or a hazardous substance, and whose proper shipping name preceded in Column 1 of the Table by the letter "A" or "W," is modified to read "III" on those occasions when the material is offered for transportation or transported by a mode in which its transportation is not otherwise subject to requirements of this subchapter.

(g) *Column 6: Labels.* Column 6 specifies codes which represent the hazard warning labels required for a package filled with a material conforming to the associated hazard class and proper shipping name, unless the package is otherwise excepted from labeling by a provision in subpart E of this part, or part 173 of this subchapter. The first code is indicative of the primary hazard of the material. Additional label codes are indicative of subsidiary hazards. Provisions in §172.402 may require that a label other than that specified in Column 6 be affixed to the package in addition to that specified in Column 6. No label is required for a material classed as a combustible liquid or for a Class 3 material that is reclassified as a combustible liquid. For "Empty" label requirements, see §173.428 of this subchapter. The codes contained in Column 6 are defined according to the following table:

LABEL SUBSTITUTION TABLE

Label code	Label name
1	Explosive
1.1 ¹	Explosive 1.1 ¹
1.2 ¹	Explosive 1.2 ¹
1.3 ¹	Explosive 1.3 ¹
1.4 ¹	Explosive 1.4 ¹
1.5 ¹	Explosive 1.5 ¹
1.6 ¹	Explosive 1.6 ¹
2.1	Flammable Gas

LABEL SUBSTITUTION TABLE—Continued

Label code	Label name
2.2	Non-Flammable Gas
2.3	Poison Gas
3	Flammable Liquid
4.1	Flammable Solid
4.2	Spontaneously Combustible
4.3	Dangerous When Wet
5.1	Oxidizer
5.2	Organic Peroxide
6.1 (inhalation hazard, Zone A or B).	Poison Inhalation Hazard
6.1 (other than inhalation hazard, Zone A or B) ² .	Poison
6.2	Infectious substance
7	Radioactive
8	Corrosive
9	Class 9

¹ Refers to the appropriate compatibility group letter.
² The packing group for a material is indicated in column 5 of the table.

(h) *Column 7: Special provisions.* Column 7 specifies codes for special provisions applicable to hazardous materials. When Column 7 refers to a special provision for a hazardous material, the meaning and requirements of that special provision are as set forth in § 172.102 of this subpart.

(i) *Column 8: Packaging authorizations.* Columns 8A, 8B and 8C specify the applicable sections for exceptions, non-bulk packaging requirements and bulk packaging requirements, respectively, in part 173 of this subchapter. Columns 8A, 8B and 8C are completed in a manner which indicates that “§173.” precedes the designated numerical entry. For example, the entry “202” in Column 8B associated with the proper shipping name “Gasoline” indicates that for this material conformance to non-bulk packaging requirements prescribed in § 173.202 of this subchapter is required. When packaging requirements are specified, they are in addition to the standard requirements for all packagings prescribed in § 173.24 of this subchapter and any other applicable requirements in subparts A and B of part 173 of this subchapter.

(1) Exceptions. Column 8A contains exceptions from some of the requirements of this subchapter. The referenced exceptions are in addition to those specified in subpart A of part 173 and elsewhere in this subchapter. A “None” in this column means no packaging exceptions are authorized, except as may be provided by special provisions in Column 7.

(2) Non-bulk packaging. Column 8B references the section in part 173 of this subchapter which prescribes packaging requirements for non-bulk packagings. A “None” in this column means non-bulk packagings are not authorized, except as may be provided by special provisions in Column 7. Each reference in this column to a material which is a hazardous waste or a hazardous substance, and whose proper shipping name is preceded in Column 1 of the Table by the letter “A” or “W”, is modified to include “§173.203” or “§173.213”, as appropriate for liquids and solids, respectively, on those occasions when the material is offered for transportation or transported by a mode in which its transportation is not otherwise subject to the requirements of this subchapter.

(3) *Bulk packaging.* Column (8C) specifies the section in part 173 of this subchapter that prescribes packaging requirements for bulk packagings, subject to the limitations, requirements, and additional authorizations of Columns (7) and (8B). A “None” in Column (8C) means bulk packagings are not authorized, except as may be provided by special provisions in Column (7) and in packaging authorizations Column (8B). Additional authorizations and limitations for use of UN portable tanks are set forth in Column 7. For each reference in this column to a material that is a hazardous waste or a hazardous substance, and whose proper shipping name is preceded in Column 1 of the Table by the letter “A” or “W” and that is offered for transportation or transported by a mode in which its transportation is not otherwise subject to the requirements of this subchapter:

(i) The column reference is § 173.240 or § 173.241, as appropriate.

(ii) For a solid material, the exception provided in special provision B54 is applicable.

(iii) For a Class 9 material, which meets the definition of an elevated temperature material, the column reference is § 173.247.

(4) For a hazardous material which is specifically named in the Table and whose packaging sections specify packagings not applicable to the form of the material (e.g., packaging specified is for solid material and the material is

being offered for transportation in a liquid form) the following table should be used to determine the appropriate packaging section:

Packaging section reference for solid materials	Corresponding packaging section for liquid materials
§ 173.187	§ 173.181
§ 173.211	§ 173.201
§ 173.212	§ 173.202
§ 173.213	§ 173.203
§ 173.240	§ 173.241
§ 173.242	§ 173.243

(5) *Cylinders.* For cylinders, both non-bulk and bulk packaging authorizations are set forth in Column (8B). Notwithstanding a designation of “None” in Column (8C), a bulk cylinder may be used when specified through the section reference in Column (8B).

(j) *Column 9: Quantity limitations.* Columns 9A and 9B specify the maximum quantities that may be offered for transportation in one package by passenger-carrying aircraft or passenger-carrying rail car (Column 9A) or by cargo aircraft only (Column 9B), subject to the following:

(1) “Forbidden” means the material may not be offered for transportation or transported in the applicable mode of transport.

(2) The quantity limitation is “net” except where otherwise specified, such as for “Consumer commodity” which specifies “30 kg gross.”

(3) When articles or devices are specifically listed by name, the net quantity limitation applies to the entire article or device (less packaging and packaging materials) rather than only to its hazardous components.

(4) A package offered or intended for transportation by aircraft and which is filled with a material forbidden on passenger-carrying aircraft but permitted on cargo aircraft only, or which exceeds the maximum net quantity authorized on passenger-carrying aircraft, shall be labelled with the CARGO AIRCRAFT ONLY label specified in §172.448 of this part.

(5) The total net quantity of hazardous material for an outer non-bulk packaging that contains more than one hazardous material may not exceed the lowest permitted maximum net quantity per package as shown in Column 9A or 9B, as appropriate. If one mate-

rial is a liquid and one is a solid, the maximum net quantity must be calculated in kilograms. See §173.24a(c)(1)(iv).

(k) *Column 10: Vessel stowage requirements.* Column 10A [Vessel stowage] specifies the authorized stowage locations on board cargo and passenger vessels. Column 10B [Other provisions] specifies codes for stowage and handling requirements for specific hazardous materials. Hazardous materials offered for transportation as limited quantities are allocated stowage category A and are not subject to the stowage codes assigned by column 10B. The meaning of each code in Column 10B is set forth in §176.84 of this subchapter. Section 176.63 of this subchapter sets forth the physical requirements for each of the authorized locations listed in Column 10A. (For bulk transportation by vessel, see 46 CFR parts 30 to 40, 70, 98, 148, 151, 153 and 154.) The authorized stowage locations specified in Column 10A are defined as follows:

(1) Stowage category “A” means the material may be stowed “on deck” or “under deck” on a cargo vessel or on a passenger vessel.

(2) Stowage category “B” means—
 (i) The material may be stowed “on deck” or “under deck” on a cargo vessel and on a passenger vessel carrying a number of passengers limited to not more than the larger of 25 passengers, or one passenger per each 3 m of overall vessel length; and

(ii) “On deck only” on passenger vessels in which the number of passengers specified in paragraph (k)(2)(i) of this section is exceeded.

(3) Stowage category “C” means the material must be stowed “on deck only” on a cargo vessel or on a passenger vessel.

(4) Stowage category “D” means the material must be stowed “on deck only” on a cargo vessel or on a passenger vessel carrying a number of passengers limited to not more than the larger of 25 passengers or one passenger per each 3 m of overall vessel length, but the material is prohibited on a passenger vessel in which the limiting number of passengers is exceeded.

(5) Stowage category “E” means the material may be stowed “on deck” or

§ 172.101

49 CFR Ch. I (10–1–23 Edition)

“under deck” on a cargo vessel or on a passenger vessel carrying a number of passengers limited to not more than the larger of 25 passengers, or one passenger per each 3 m of overall vessel length, but is prohibited from carriage on a passenger vessel in which the limiting number of passengers is exceeded.

(6) Stowage category “01” means the material may be stowed “on deck” in closed cargo transport units or “under deck” on a cargo vessel (up to 12 passengers) or on a passenger vessel.

(7) Stowage category “02” means the material may be stowed “on deck” in closed cargo transport units or “under deck” on a cargo vessel (up to 12 passengers) or “on deck” in closed cargo transport units or “under deck” in closed cargo transport units on a passenger vessel.

(8) Stowage category “03” means the material may be stowed “on deck” in closed cargo transport units or “under deck” on a cargo vessel (up to 12 passengers) but the material is prohibited on a passenger vessel.

(9) Stowage category “04” means the material may be stowed “on deck” in closed cargo transport units or “under deck” in closed cargo transports on a cargo vessel (up to 12 passengers) but the material is prohibited on a passenger vessel.

(10) Stowage category “05” means the material may be stowed “on deck” in

closed cargo transport units on a cargo vessel (up to 12 passengers) but the material is prohibited on a passenger vessel.

(1) *Changes to the Table.* (1) Unless specifically stated otherwise in a rule document published in the FEDERAL REGISTER amending the Table—

(i) Such a change does not apply to the shipment of any package filled prior to the effective date of the amendment; and

(ii) Stocks of preprinted shipping papers and package markings may be continued in use, in the manner previously authorized, until depleted or for a one-year period, subsequent to the effective date of the amendment, whichever is less.

(2) Except as otherwise provided in this section, any alteration of a shipping description or associated entry which is listed in the §172.101 Table must receive prior written approval from the Associate Administrator.

(3) The proper shipping name of a hazardous material changed in the May 6, 1997 final rule, in effect on October 1, 1997, only by the addition or omission of the word “compressed,” “inhibited,” “liquefied” or “solution” may continue to be used to comply with package marking requirements, until January 1, 2003.

§ 172.101 HAZARDOUS MATERIALS TABLE

Sym-bols (1)	Hazardous materials descriptions and proper shipping names (2)	Hazard class or Division (3)	Identi-fication Numbers (4)	PG (5)	Label Codes (6)	Special provisions (§ 172.102) (7)	(8)			(9)		(10) Vessel stowage		
							Packaging (§ 173.***)			Quantity limitations (see §§ 173.27 and 175.75)		Loca-tion (10A)	Other (10B)	
							Excep-tions (8A)	Non-bulk (8B)	Bulk (8C)	Passenger aircraft/rail (9A)	Cargo air-craft only (9B)			
A	<i>Accellerene, see p-Nitrosodimethylaniline</i>													
	<i>Accumulators, electric, see Batteries, wet etc</i>													
	<i>Accumulators, pressurized, pneumatic or hydraulic (containing non-flammable gas), see Articles pressurized, pneumatic or hydraulic (containing non-flammable gas)</i>													
	Acetal	3	UN1088	II	3	IB2, T4, TP1	150	202	242	5 L	60 L	E		
	Acetaldehyde	3	UN1089	I	3	B16, T11, TP2, TP7	None	201	243	Forbidden	30 L	E		
	Acetaldehyde ammonia	9	UN1841	III	9	IB8, IP3, IP7, T1, TP33	155	204	240	200 kg	200 kg	A	34	
	Acetaldehyde oxime	3	UN2332	III	3	B1, IB3, T4, TP1	150	203	242	60 L	220 L	A		
	Acetic acid, glacial or Acetic acid solution, with more than 80 percent acid, by mass	8	UN2789	II	8, 3	A3, A7, A10, B2, IB2, T7, TP2	154	202	243	1 L	30 L	A	53, 58	
	Acetic acid solution, not less than 50 percent but not more than 80 percent acid, by mass	8	UN2790	II	8	148, A3, A7, A10, B2, IB2, T7, TP2	154	202	242	1 L	30 L	A	53, 58	
	Acetic acid solution, with more than 10 percent and less than 50 percent acid, by mass	8	UN2790	III	8	148, IB3, T4, TP1	154	203	242	5 L	60 L	A	53, 58	
	Acetic anhydride	8	UN1715	II	8, 3	A3, A7, A10, B2, IB2, T7, TP2	154	202	243	1 L	30 L	A	40, 53, 58	
	Acetone	3	UN1090	II	3	IB2, T4, TP1	150	202	242	5 L	60 L	B		
	Acetone cyanohydrin, stabilized	6.1	UN1541	I	6.1	2, B9, B14, B32, B76, B77, N34, T20, TP2, TP13, TP38, TP45	None	227	244	Forbidden	Forbidden	D	25, 40, 52, 53	
	Acetone oils	3	UN1091	II	3	IB2, T4, TP1, TP8	150	202	242	5 L	60 L	B		
	Acetonitrile	3	UN1648	II	3	IB2, T7, TP2	150	202	242	5 L	60 L	B	40	
	<i>Acetyl acetone peroxide with more than 9 percent by mass active oxygen</i>	Forbidden												
	<i>Acetyl benzoyl peroxide, solid, or with more than 40 percent in solution</i>	Forbidden												

Pipeline and Haz. Matls. Safety Admin., DOT

§ 172.101

§ 172.101 HAZARDOUS MATERIALS TABLE—Continued

Sym-bols (1)	Hazardous materials descriptions and proper shipping names (2)	Hazard class or Division (3)	Identi-fication Numbers (4)	PG (5)	Label Codes (6)	Special provisions (§ 172.102) (7)	(8)			(9)		(10) Vessel stowage	
							Packaging (§ 173.***)			Quantity limitations (see §§ 173.27 and 175.75)		Loca-tion (10A)	Other (10B)
							Excep-tions (8A)	Non-bulk (8B)	Bulk (8C)	Passenger aircraft/rail (9A)	Cargo air-craft only (9B)		
	Acetyl bromide	8	UN1716	II	8	B2, IB2, T8, TP2	154	202	242	1 L	30 L	C	40, 53, 58
	Acetyl chloride	3	UN1717	II	3, 8	A3, A7, IB1, N34, T8, TP2	150	202	243	1 L	5 L	B	40, 53, 58
	<i>Acetyl cyclohexanesulfonyl peroxide, with more than 82 percent wetted with less than 12 percent water</i>	Forbidden											
	Acetyl iodide	8	UN1898	II	8	B2, IB2, T7, TP2, TP13	154	202	242	1 L	30 L	C	40, 53, 58
	Acetyl methyl carbinol	3	UN2621	III	3	B1, IB3, T2, TP1	150	203	242	60 L	220 L	A	
	<i>Acetyl peroxide, solid, or with more than 25 percent in solution</i>	Forbidden											
	Acetylene, dissolved	2.1	UN1001		2.1	N86, N88	None	303	None	Forbidden	15 kg	D	25, 40, 57
	<i>Acetylene (liquefied)</i>	Forbidden											
	<i>Acetylene silver nitrate</i>	Forbidden											
	<i>Acetylene, solvent free</i>	Forbidden											
	<i>Acetylene tetrabromide, see Tetrabromoethane</i>	Forbidden											
	<i>Acid butyl phosphate, see Butyl acid phosphate</i>												
	Acid, sludge, <i>see</i> Sludge acid												
	Acridine	6.1	UN2713	III	6.1	IB8, IP3, T1, TP33	153	213	240	100 kg	200 kg	A	
	Acrolein dimer, stabilized	3	UN2607	III	3	387, B1, IB3, T2, TP1	150	203	242	60 L	220 L	C	25, 40
	Acrolein, stabilized	6.1	UN1092	I	6.1, 3	1, 380, 387, B9, B14, B30, B42, B77, T22, TP2, TP7, TP13, TP38, TP44	None	226	244	Forbidden	Forbidden	D	25, 40
	Acrylamide, solid	6.1	UN2074	III	6.1	IB8, IP3, T1, TP33	153	213	240	100 kg	200 kg	A	12, 25
	Acrylamide solution	6.1	UN3426	III	6.1	IB3, T4, TP1	153	203	241	60 L	220 L	A	12, 25
	Acrylic acid, stabilized	8	UN2218	II	8, 3	387, B2, IB2, T7, TP2	154	202	243	1 L	30 L	C	25, 40, 53, 58
	Acrylonitrile, stabilized	3	UN1093	I	3, 6.1	387, B9, T14, TP2, TP13	None	201	243	Forbidden	30 L	D	25, 40
	<i>Actuating cartridge, explosive, see Cartridges, power device</i>												

§ 172.101

49 CFR Ch. I (10-1-23 Edition)

	Adhesives, containing a flammable liquid	3	UN1133	I	3	T11, TP1, TP8, TP27	150	201	243	1 L	30 L	B		
				II	3	149, B52, IB2, T4, TP1, TP8	150	173	242	5 L	60 L	B		
	Adiponitrile	6.1	UN2205	III	3	B1, B52, IB3, T2, TP1	150	173	242	60 L	220 L	A		
G	Adsorbed gas, n.o.s	2.2	UN3511	2.2	IB3, T3, TP1	153	203	241	60 L	220 L	A		
G	Adsorbed gas, flammable, n.o.s	2.1	UN3510	2.1	None	302c	None	75 kg	150 kg	A		
G	Adsorbed gas, oxidizing, n.o.s	2.2	UN3513	2.2, 5.1	None	302c	None	Forbidden	150 kg	D	40	
G	Adsorbed gas, toxic, n.o.s. Inhalation hazard zone A	2.3	UN3512	2.3	1	None	302c	None	Forbidden	Forbidden	D	40
G	Adsorbed gas, toxic, n.o.s. Inhalation hazard zone B	2.3	UN3512	2.3	2, B9, B14	None	302c	None	Forbidden	Forbidden	D	40	
G	Adsorbed gas, toxic, n.o.s. Inhalation hazard zone C	2.3	UN3512	2.3	3, B14	None	302c	None	Forbidden	Forbidden	D	40	
G	Adsorbed gas, toxic, n.o.s. Inhalation hazard zone D	2.3	UN3512	2.3	4	None	302c	None	Forbidden	Forbidden	D	40	
G	Adsorbed gas, toxic, corrosive, n.o.s. Inhalation hazard zone A	2.3	UN3516	2.3, 8	1, 379	None	302c	None	Forbidden	Forbidden	D	40	
G	Adsorbed gas, toxic, corrosive, n.o.s. Inhalation hazard zone B	2.3	UN3516	2.3, 8	2, 379, B9, B14	None	302c	None	Forbidden	Forbidden	D	40	
G	Adsorbed gas, toxic, corrosive, n.o.s. Inhalation hazard zone C	2.3	UN3516	2.3, 8	3, 379, B14	None	302c	None	Forbidden	Forbidden	D	40	
G	Adsorbed gas, toxic, corrosive, n.o.s. Inhalation hazard zone D	2.3	UN3516	2.3, 8	4, 379	None	302c	None	Forbidden	Forbidden	D	40	
G	Adsorbed gas, toxic, flammable, n.o.s. Inhalation hazard zone A	2.3	UN3514	2.3, 2.1	1	None	302c	None	Forbidden	Forbidden	D	40	
G	Adsorbed gas, toxic, flammable, n.o.s. Inhalation hazard zone B	2.3	UN3514	2.3, 2.1	2, B9, B14	None	302c	None	Forbidden	Forbidden	D	40	
G	Adsorbed gas, toxic, flammable, n.o.s. Inhalation hazard zone C	2.3	UN3514	2.3, 2.1	3, B14	None	302c	None	Forbidden	Forbidden	D	40	
G	Adsorbed gas, toxic, flammable, n.o.s. Inhalation hazard zone D	2.3	UN3514	2.3, 2.1	4	None	302c	None	Forbidden	Forbidden	D	40	
G	Adsorbed gas, toxic, flammable, corrosive, n.o.s. Inhalation hazard zone A	2.3	UN3517	2.3, 2.1, 8	1	None	302c	None	Forbidden	Forbidden	D	17, 40	
G	Adsorbed gas, toxic, flammable, corrosive, n.o.s. Inhalation hazard zone B	2.3	UN3517	2.3, 2.1, 8	2, B9, B14	None	302c	None	Forbidden	Forbidden	D	17, 40	
G	Adsorbed gas, toxic, flammable, corrosive, n.o.s. Inhalation hazard zone C	2.3	UN3517	2.3, 2.1, 8	3, B14	None	302c	None	Forbidden	Forbidden	D	17, 40	
G	Adsorbed gas, toxic, flammable, corrosive, n.o.s. Inhalation hazard zone D	2.3	UN3517	2.3, 2.1, 8	4	None	302c	None	Forbidden	Forbidden	D	17, 40	
G	Adsorbed gas, toxic, oxidizing, n.o.s. Inhalation hazard zone A	2.3	UN3515	2.3, 5.1	1	None	302c	None	Forbidden	Forbidden	D	40	
G	Adsorbed gas, toxic, oxidizing, n.o.s. Inhalation hazard zone B	2.3	UN3515	2.3, 5.1	2, B9, B14	None	302c	None	Forbidden	Forbidden	D	40	

§ 172.101 HAZARDOUS MATERIALS TABLE—Continued

§ 172.101

49 CFR Ch. I (10-1-23 Edition)

Sym-bols	Hazardous materials descriptions and proper shipping names	Hazard class or Division	Identi-fication Numbers	PG	Label Codes	Special provisions (§ 172.102)	(8)			(9)		(10) Vessel stowage	
							Packaging (§ 173.***)			Quantity limitations (see §§ 173.27 and 175.75)		Loca-tion	Other
							Excep-tions	Non-bulk	Bulk	Passenger aircraft/rail	Cargo air-craft only		
(1)	(2)	(3)	(4)	(5)	(6)	(7)	(8A)	(8B)	(8C)	(9A)	(9B)	(10A)	(10B)
G	Adsorbed gas, toxic, oxidizing, n.o.s. <i>Inhalation hazard zone C</i>	2.3	UN3515	2.3, 5.1	3, B14	None	302c	None	Forbidden	Forbidden	D	40
G	Adsorbed gas, toxic, oxidizing, n.o.s. <i>Inhalation hazard zone D</i>	2.3	UN3515	2.3, 5.1	4	None	302c	None	Forbidden	Forbidden	D	40
G	Adsorbed gas, toxic, oxidizing, cor-rosive, n.o.s. <i>Inhalation hazard zone A</i>	2.3	UN3518	2.3, 5.1, 8	1	None	302c	None	Forbidden	Forbidden	D	40, 89, 90
G	Adsorbed gas, toxic, oxidizing, cor-rosive, n.o.s. <i>Inhalation hazard zone B</i>	2.3	UN3518	2.3, 5.1, 8	2, B9, B14	None	302c	None	Forbidden	Forbidden	D	40, 89, 90
G	Adsorbed gas, toxic, oxidizing, cor-rosive, n.o.s. <i>Inhalation hazard zone C</i>	2.3	UN3518	2.3, 5.1, 8	3, B14	None	302c	None	Forbidden	Forbidden	D	40, 89, 90
G	Adsorbed gas, toxic, oxidizing, cor-rosive, n.o.s. <i>Inhalation hazard zone D</i>	2.3	UN3518	2.3, 5.1, 8	4	None	302c	None	Forbidden	Forbidden	D	40, 89, 90
	Aerosols, <i>corrosive, Packing Group II or III, (each not exceeding 1 L capacity)</i>	2.2	UN1950	2.2, 8	A34	306	None	None	75 kg	150 kg	A	25, 87, 126, 157
	Aerosols, <i>flammable, (each not ex-ceeding 1 L capacity)</i>	2.1	UN1950	2.1	N82	306	None	None	75 kg	150 kg	A	25, 87, 126, 157
	Aerosols, <i>flammable, n.o.s. (engine starting fluid) (each not exceeding 1 L capacity)</i>	2.1	UN1950	2.1	N82	306	304	None	Forbidden	150 kg	A	25, 87, 126, 157
	Aerosols, <i>non-flammable, (each not exceeding 1 L capacity)</i>	2.2	UN1950	2.2	306	None	None	75 kg	150 kg	A	25, 87, 126, 157
	Aerosols, <i>poison, Packing Group III (each not exceeding 1 L capacity)</i>	2.2	UN1950	2.2, 6.1	306	None	None	Forbidden	Forbidden	A	25, 87, 126, 157
	<i>Air bag inflators, or Air bag mod-ules, or Seat-belt pretensioners, see Safety devices, electrically initiated or Safety devices, pyro-technic</i>												

	Air, compressed	2.2	UN1002		2.2		78	306, 307	302	302	75 kg	150 kg	A	
	Air, refrigerated liquid, (<i>cryogenic liquid</i>)	2.2	UN1003		2.2, 5.1		T75, TP5, TP22	320	316	318, 319	Forbidden	Forbidden	D	51
	Air, refrigerated liquid, (<i>cryogenic liquid</i>) non-pressurized	2.2	UN1003		2.2, 5.1		T75, TP5, TP22	320	316	318, 319	Forbidden	Forbidden	D	51
	<i>Aircraft engines (including turbines), see Engines, internal combustion</i>													
	<i>Aircraft evacuation slides, see Life saving appliances etc</i>													
	Aircraft hydraulic power unit fuel tank (<i>containing a mixture of anhydrous hydrazine and monomethyl hydrazine</i>) (M86 fuel)	3	UN3165	I	3, 6.1, 8		None	172	None	Forbidden	42 L	E	21, 40, 49, 100
	<i>Aircraft survival kits, see Life saving appliances etc</i>													
G	Alcoholates solution, n.o.s., in alcohol	3	UN3274	II	3, 8		IB2	150	202	243	1 L	5 L	B	52
	Alcoholic beverages	3	UN3065	II	3		24, 149, B1, IB2, T4, TP1	150	202	242	5 L	60 L	A	
				III	3		24, B1, IB3, N11, T2, TP1	150	203	242	60 L	220 L	A	
	Alcohols, n.o.s.	3	UN1987	I	3		172, T11, TP1, TP8, TP27	4b	201	243	1 L	30 L	E	
				II	3		172, IB2, T7, TP1, TP8, TP28	4b, 150	202	242	5 L	60 L	B	
				III	3		172, B1, IB3, T4, TP1, TP29	4b, 150	203	242	60 L	220 L	A	
G	Alcohols, flammable, toxic n.o.s	3	UN1986	I	3, 6.1		T14, TP2, TP13, TP27	None	201	243	Forbidden	30 L	E	40
				II	3, 6.1		IB2, T11, TP2, TP27	150	202	243	1 L	60 L	B	40
				III	3, 6.1		B1, IB3, T7, TP1, TP28	150	203	242	60 L	220 L	A	
	Aldehydes, n.o.s.	3	UN1989	I	3		T11, TP1, TP27	None	201	243	1 L	30 L	E	
				II	3		IB2, T7, TP1, TP8, TP28	150	202	242	5 L	60 L	B	
				III	3		B1, IB3, T4, TP1, TP29	150	203	242	60 L	220 L	A	
G	Aldehydes, flammable, toxic, n.o.s.	3	UN1988	I	3, 6.1		T14, TP2, TP13, TP27	None	201	243	Forbidden	30 L	E	40
				II	3, 6.1		IB2, T11, TP2, TP27	150	202	243	1 L	60 L	B	40
				III	3, 6.1		B1, IB3, T7, TP1, TP28	150	203	242	60 L	220 L	A	
	Aldol	6.1	UN2839	II	6.1		IB2, T7, TP2	153	202	243	5 L	60 L	A	12, 25
G	Alkali metal alcoholates, self-heating, corrosive, n.o.s.	4.2	UN3206	II	4.2, 8		64, A7, IB5, IP2, T3, TP33, W31	None	212	242	15 kg	50 kg	B	52
				III	4.2, 8		64, A7, IB8, IP3, T1, TP33, W31	None	213	242	25 kg	100 kg	B	52
	Alkali metal alloys, liquid, n.o.s	4.3	UN1421	I	4.3		A2, A7, B48, N34, W31	None	201	244	Forbidden	1 L	D	13, 52, 148
	Alkali metal amalgam, liquid	4.3	UN1389	I	4.3		A2, A7, N34, W31	None	201	244	Forbidden	1 L	D	13, 40, 52, 148
	Alkali metal amalgam, solid	4.3	UN3401	I	4.3		IB4, IP1, N40, T9, TP7, TP33, W31	None	211	242	Forbidden	15 kg	D	13, 52, 148

§ 172.101 HAZARDOUS MATERIALS TABLE—Continued

Sym-bols	Hazardous materials descriptions and proper shipping names	Hazard class or Division	Identi-fication Numbers	PG	Label Codes	Special provisions (§ 172.102)	(8)			(9)		(10) Vessel stowage	
							Packaging (§ 173.***)			Quantity limitations (see §§ 173.27 and 175.75)		Loca-tion	Other
							Excep-tions	Non-bulk	Bulk	Passenger aircraft/rail	Cargo air-craft only		
(1)	(2)	(3)	(4)	(5)	(6)	(7)	(8A)	(8B)	(8C)	(9A)	(9B)	(10A)	(10B)
	Alkali metal amides	4.3	UN1390	II	4.3	A6, A7, A8, A19, A20, IB7, IP2, IP21, T3, TP33, W31, W40	151	212	241	15 kg	50 kg	E	13, 40, 52, 148
	Alkali metal dispersions, flammable or Alkaline earth metal dispersions, flammable	4.3	UN3482	I	4.3, 3	A2, A7, W31	None	201	244	Forbidden	1 L	D	13, 52, 148
	Alkali metal dispersions, or Alkaline earth metal dispersions	4.3	UN1391	I	4.3	A2, A7, W31	None	201	244	Forbidden	1 L	D	13, 52, 148
G	Alkaline earth metal alcoholates, n.o.s.	4.2	UN3205	II	4.2	65, A7, IB6, IP2, T3, TP33, W31	None	212	241	15 kg	50 kg	B	
				III	4.2	65, A7, IB8, IP3, T1, TP33, W31	None	213	241	25 kg	100 kg	B	
	Alkaline earth metal alloys, n.o.s.	4.3	UN1393	II	4.3	A19, IB7, IP2, IP4, T3, TP33, W31, W40	151	212	241	15 kg	50 kg	E	13, 52, 148
	Alkaline earth metal amalgams, liquid	4.3	UN1392	I	4.3	A19, N34, N40, W31	None	201	244	Forbidden	1 L	E	13, 40, 52, 148
	Alkaline earth metal amalgams, solid	4.3	UN3402	I	4.3	A19, N34, N40, T9, TP7, TP33, W31	None	211	242	Forbidden	15 kg	D	13, 52, 148
G	Alkaloids, liquid, n.o.s., or Alkaloid salts, liquid, n.o.s.	6.1	UN3140	I	6.1	A4, T14, TP2, TP27	None	201	243	1 L	30 L	A	
				II	6.1	IB2, T11, TP2, TP27	153	202	243	5 L	60 L	A	
G	Alkaloids, solid, n.o.s. or Alkaloid salts, solid, n.o.s. <i>poisonous</i>	6.1	UN1544	III	6.1	IB3, T7, TP1, TP28	153	203	241	60 L	220 L	A	
				I	6.1	IB7, IP1, T6, TP33	None	211	242	5 kg	50 kg	A	
				II	6.1	IB8, IP2, IP4, T3, TP33	153	212	242	25 kg	100 kg	A	
				III	6.1	IB8, IP3, T1, TP33	153	213	240	100 kg	200 kg	A	
				II	8	B2, IB2, T8, TP2, TP13	154	202	242	1 L	30 L	B	53, 58
	Alkyl sulfonic acids, liquid or Aryl sulfonic acids, liquid with more than 5 percent free sulfuric acid	8	UN2584	II	8								
	Alkyl sulfonic acids, liquid or Aryl sulfonic acids, liquid with not more than 5 percent free sulfuric acid	8	UN2586	III	8	IB3, T4, TP1	154	203	241	5 L	60 L	B	53, 58
	Alkyl sulfonic acids, solid or Aryl sulfonic acids, solid, with more than 5 percent free sulfuric acid	8	UN2583	II	8	IB8, IP2, IP4, T3, TP33	154	212	240	15 kg	50 kg	A	53, 58

§ 172.101

49 CFR Ch. I (10-1-23 Edition)

Alkyl sulfonic acids, solid or Aryl sulfonic acids, solid <i>with not more than 5 percent free sulfuric acid</i>	8	UN2585	III	8	IB8, IP3, T1, TP33	154	213	240	25 kg	100 kg	A	53, 58
Alkylphenols, liquid, n.o.s. (<i>including C2-C12 homologues</i>)	8	UN3145	I	8	T14, TP2	None	201	243	0.5 L	2.5 L	B	
			II	8	IB2, T11, TP2, TP27	154	202	242	1 L	30 L	B	
			III	8	IB3, T7, TP1, TP28	154	203	241	5 L	60 L	A	
Alkylphenols, solid, n.o.s. (<i>including C2-C12 homologues</i>)	8	UN2430	I	8	IB7, IP1, T6, TP33	None	211	242	1 kg	25 kg	B	
			II	8	IB8, IP2, IP4, T3, TP33	154	212	240	15 kg	50 kg	B	
			III	8	IB8, IP3, T1, TP33	154	213	240	25 kg	100 kg	A	
Alkylsulfuric acids	8	UN2571	II	8	B2, IB2, T8, TP2, TP13, TP28	154	202	242	1 L	30 L	C	14, 53, 58
<i>Allethrin</i> , see Pesticides, liquid, toxic, n.o.s.												
Allyl acetate	3	UN2333	II	3, 6.1	IB2, T7, TP1, TP13	150	202	243	1 L	60 L	E	40
Allyl alcohol	6.1	UN1098	I	6.1, 3	2, B9, B14, B32, B77, T20, TP2, TP13, TP38, TP45	None	227	244	Forbidden	Forbidden	D	40
Allyl bromide	3	UN1099	I	3, 6.1	T14, TP2, TP13	None	201	243	Forbidden	30 L	B	40
Allyl chloride	3	UN1100	I	3, 6.1	T14, TP2, TP13	None	201	243	Forbidden	30 L	E	40
<i>Allyl chlorocarbonate</i> , see Allyl chloroformate												
Allyl chloroformate	6.1	UN1722	I	6.1, 3, 8	2, B9, B14, B32, N41, T20, TP2, TP13, TP38, TP45	None	227	244	Forbidden	Forbidden	D	21, 40, 53, 58, 100
Allyl ethyl ether	3	UN2335	II	3, 6.1	IB2, T7, TP1, TP13	150	202	243	1 L	60 L	E	40
Allyl formate	3	UN2336	I	3, 6.1	T14, TP2, TP13	None	201	243	Forbidden	30 L	E	40
Allyl glycidyl ether	3	UN2219	III	3	B1, IB3, T2, TP1	150	203	242	60 L	220 L	A	
Allyl iodide	3	UN1723	II	3, 8	A3, IB1, N34, T7, TP2, TP13	150	202	243	1 L	5 L	B	40, 53, 58
Allyl isothiocyanate, stabilized	6.1	UN1545	II	6.1, 3	387, A3, A7, IB2, T7, TP2	153	202	243	Forbidden	60 L	D	25, 40
Allylamine	6.1	UN2334	I	6.1, 3	2, B9, B14, B32, T20, TP2, TP13, TP38, TP45	None	227	244	Forbidden	Forbidden	D	40, 52
Allyltrichlorosilane, stabilized	8	UN1724	II	8, 3	387, A7, B2, B6, N34, T10, TP2, TP7, TP13	None	206	243	Forbidden	30 L	C	25, 40, 53, 58
Aluminum borohydride or Aluminum borohydride in devices	4.2	UN2870	I	4.2, 4.3	B11, T21, TP7, TP33	None	181	244	Forbidden	Forbidden	D	13, 148
Aluminum bromide, anhydrous	8	UN1725	II	8	IB8, IP2, IP4, T3, TP33	154	212	240	15 kg	50 kg	A	40, 53, 58
Aluminum bromide, solution	8	UN2580	III	8	IB3, T4, TP1	154	203	241	5 L	60 L	A	53, 58
Aluminum carbide	4.3	UN1394	II	4.3	A20, IB7, IP2, IP21, N41, T3, TP33, W31, W40	151	212	242	15 kg	50 kg	A	13, 52, 148
Aluminum chloride, anhydrous	8	UN1726	II	8	IB8, IP2, IP4, T3, TP33	154	212	240	15 kg	50 kg	A	40, 53, 58
Aluminum chloride, solution <i>Aluminum dross, wet or hot</i>	8	UN2581	III	8	IB3, T4, TP1	154	203	241	5 L	60 L	A	53, 58

§ 172.101 HAZARDOUS MATERIALS TABLE—Continued

Sym-bols	Hazardous materials descriptions and proper shipping names	Hazard class or Division	Identi-fication Numbers	PG	Label Codes	Special provisions (§ 172.102)	(8)			(9)		(10) Vessel stowage	
							Packaging (§ 173.***)			Quantity limitations (see §§ 173.27 and 175.75)		Loca-tion	Other
							Excep-tions	Non-bulk	Bulk	Passenger aircraft/rail	Cargo air-craft only		
(1)	(2)	(3)	(4)	(5)	(6)	(7)	(8A)	(8B)	(8C)	(9A)	(9B)	(10A)	(10B)
D	Aluminum ferrosilicon powder	4.3	UN1395	II	4.3, 6.1	A19, IB5, IP2, T3, TP33, W31, W40	151	212	242	15 kg	50 kg	A	13, 39, 40, 52, 53, 85, 103, 148
				III	4.3, 6.1	A19, A20, IB4	151	213	241	25 kg	100 kg	A	13, 39, 40, 52, 53, 85, 103, 148
	Aluminum hydride	4.3	UN2463	I	4.3	A19, N40, W31	None	211	242	Forbidden	15 kg	E	13, 148
	Aluminum, molten	9	NA9260	III	9	IB3, T1, TP3	None	None	247	Forbidden	Forbidden	D	
	Aluminum nitrate	5.1	UN1438	III	5.1	A1, A29, IB8, IP3, T1, TP33	152	213	240	25 kg	100 kg	A	
	<i>Aluminum phosphate solution, see Corrosive liquids, etc</i>												
	Aluminum phosphide	4.3	UN1397	I	4.3, 6.1	A8, A19, N40, W31	None	211	242	Forbidden	15 kg	E	13, 40, 52, 85, 148
	Aluminum phosphide pesticides	6.1	UN3048	I	6.1	A8, IB7, IP1, T6, TP33, W31	None	211	242	Forbidden	15 kg	E	40, 85
	Aluminum powder, coated	4.1	UN1309	II	4.1	IB8, IP2, IP21, T3, TP33, W100	151	212	240	15 kg	50 kg	A	13, 39, 52, 53, 74, 101, 147, 148
					III	4.1	B134, IB8, IP21, T1, TP33, W100	151	213	240	25 kg	100 kg	A
Aluminum powder, uncoated	4.3	UN1396	II	4.3	A19, A20, IB7, IP2, IP21, T3, TP33, W31, W40	151	212	242	15 kg	50 kg	A	13, 39, 52, 53, 148	

§ 172.101

49 CFR Ch. I (10-1-23 Edition)

			III	4.3	A19, A20, IB8, IP21, T1, TP33, W31	151	213	241	25 kg	100 kg	A	13, 39, 52, 53, 148	
	Aluminum resinate	4.1	UN2715	III	4.1	IB6, T1, TP33	151	213	240	25 kg	100 kg	A	
	Aluminum silicon powder, uncoated	4.3	UN1398	III	4.3	A1, A19, B136, IB8, IP4, T1, TP33, W31	151	213	241	25 kg	100 kg	A	13, 39, 40, 52, 53, 85, 103, 148
	Aluminum smelting by-products or Aluminum remelting by-products	4.3	UN3170	II	4.3	128, B115, IB7, IP2, IP21, T3, TP33, W31, W40	151	212	242	15 kg	50 kg	B	13, 85, 103, 148
				III	4.3	128, B115, IB8, IP21, T1, TP33, W31	151	213	241	25 kg	100 kg	B	13, 85, 103, 148
	<i>Amatols, see</i> Explosives, blasting, type B												
G	Amine, flammable, corrosive, n.o.s. or Polyamines, flammable, corrosive, n.o.s.	3	UN2733	I	3, 8	T14, TP1, TP27	None	201	243	0.5 L	2.5 L	D	40, 52
				II	3, 8	IB2, T11, TP1, TP27	150	202	243	1 L	5 L	B	40, 52
				III	3, 8	B1, IB3, T7, TP1, TP28	150	203	242	5 L	60 L	A	40, 52
G	Amine, liquid, corrosive, flammable, n.o.s. or Polyamines, liquid, corrosive, flammable, n.o.s.	8	UN2734	I	8, 3	A3, N34, T14, TP2, TP27	None	201	243	0.5 L	2.5 L	A	52
				II	8, 3	IB2, T11, TP2, TP27	154	202	243	1 L	30 L	A	52
G	Amines, liquid, corrosive, n.o.s. or Polyamines, liquid, corrosive, n.o.s.	8	UN2735	I	8	B10, N34, T14, TP2, TP27	None	201	243	0.5 L	2.5 L	A	52
				II	8	B2, IB2, T11, TP1, TP27	154	202	242	1 L	30 L	A	52
				III	8	IB3, T7, TP1, TP28	154	203	241	5 L	60 L	A	52
G	Amines, solid, corrosive, n.o.s., or Polyamines, solid, corrosive n.o.s.	8	UN3259	I	8	IB7, IP1, T6, TP33	None	211	242	1 kg	25 kg	A	52
				II	8	IB8, IP2, IP4, T3, TP33	154	212	240	15 kg	50 kg	A	52
				III	8	IB8, IP3, T1, TP33	154	213	240	25 kg	100 kg	A	52
	2-Amino-4-chlorophenol	6.1	UN2673	II	6.1	IB8, IP2, IP4, T3, TP33	153	212	242	25 kg	100 kg	A	
	2-Amino-5-diethylaminopentane	6.1	UN2946	III	6.1	IB3, T4, TP1	153	203	241	60 L	220 L	A	
	2-Amino-4,6-Dinitrophenol, wetted with not less than 20 percent water by mass	4.1	UN3317	I	4.1	23, A8, A19, A20, N41, W31	None	211	None	1 kg	15 kg	E	28, 36
	2-(2-Aminoethoxy) ethanol	8	UN3055	III	8	IB3, T4, TP1	154	203	241	5 L	60 L	A	52
	N-Aminoethylpiperazine	8	UN2815	III	8, 6.1	IB3, T4, TP1	154	203	241	5 L	60 L	B	12, 25, 40, 52
+	Aminophenols (<i>o</i> -; <i>m</i> -; <i>p</i> -) Aminopropylidiethanolamine, Amines, etc <i>n</i> -Aminopropylmorpholine, Amines, etc	6.1	UN2512	III	6.1	IB8, IP3, T1, TP33	153	213	240	100 kg	200 kg	A	

§ 172.101 HAZARDOUS MATERIALS TABLE—Continued

Sym-bols	Hazardous materials descriptions and proper shipping names	Hazard class or Division	Identi-fication Numbers	PG	Label Codes	Special provisions (§ 172.102)	(8)			(9)		(10) Vessel stowage	
							Packaging (§ 173.***)			Quantity limitations (see §§ 173.27 and 175.75)		Loca-tion	Other
							Excep-tions	Non-bulk	Bulk	Passenger aircraft/rail	Cargo air-craft only		
(1)	(2)	(3)	(4)	(5)	(6)	(7)	(8A)	(8B)	(8C)	(9A)	(9B)	(10A)	(10B)
	Aminopyridines (<i>o</i> -; <i>m</i> -; <i>p</i> -)	6.1	UN2671	II	6.1	IB8, IP2, IP4, T3, TP33	153	212	242	25 kg	100 kg	B	12, 25, 40, 52
I	Ammonia, anhydrous	2.3	UN1005	2.3, 8	4, 379, N87, T50	None	304	314, 315	Forbidden	Forbidden	D	40, 52, 57
D	Ammonia, anhydrous	2.2	UN1005	2.2	13, 379, T50	None	304	314, 315	Forbidden	Forbidden	D	40, 52, 57
	Ammonia solution, relative density less than 0.880 at 15 degrees C in water, with more than 35 percent but not more than 50 percent ammonia	2.2	UN2073		2.2	N87	306	304	314, 315	Forbidden	150 kg	E	40, 52, 57
	Ammonia solution, relative density between 0.880 and 0.957 at 15 degrees C in water, with more than 10 percent but not more than 35 percent ammonia	8	UN2672	III	8	336, IB3, IP8, T7, TP2	154	203	241	5 L	60 L	A	40, 52, 85
I	Ammonia solution, relative density less than 0.880 at 15 degrees C in water, with more than 50 percent ammonia	2.3	UN3318		2.3, 8	4, N87, T50	None	304	314, 315	Forbidden	Forbidden	D	40, 52, 57
D	Ammonia solution, relative density less than 0.880 at 15 degrees C in water, with more than 50 percent ammonia	2.2	UN3318		2.2	13, T50	None	304	314, 315	Forbidden	Forbidden	D	40, 52, 57
	Ammonium arsenate	6.1	UN1546	II	6.1	IB8, IP2, IP4, T3, TP33	153	212	242	25 kg	100 kg	A	53
	Ammonium azide	Forbidden											
	Ammonium bifluoride, solid, see Ammonium hydrogen difluoride, solid												
	Ammonium bifluoride solution, see Ammonium hydrogen difluoride, solution												
	Ammonium bromate	Forbidden											
	Ammonium chlorate	Forbidden											
	Ammonium dichromate	5.1	UN1439	II	5.1	IB8, IP2, IP4, T3, TP33	152	212	242	5 kg	25 kg	A	52
	Ammonium dinitro-o-cresolate, solid	6.1	UN1843	II	6.1	IB8, IP2, IP4, T3, TP33	153	212	242	25 kg	100 kg	B	36, 65, 66, 77

§ 172.101

49 CFR Ch. I (10-1-23 Edition)

	Ammonium dinitro-o-cresolate solution	6.1	UN3424	II	6.1	IB2, T7, TP2	153	202	243	5 L	60 L	B	36, 66, 78, 91
				III	6.1	IB2, T7, TP2	153	203	241	60 L	220 L	A	36, 66, 78, 91
	Ammonium fluoride	6.1	UN2505	III	6.1	IB8, IP3, T1, TP33	153	213	240	100 kg	200 kg	A	52
	Ammonium fluorosilicate	6.1	UN2854	III	6.1	IB8, IP3, T1, TP33	153	213	240	100 kg	200 kg	A	52
	<i>Ammonium fulminate</i>	Forbidden											
	Ammonium hydrogen sulfate	8	UN2506	II	8	IB8, IP2, IP4, T3, TP33	154	212	240	15 kg	50 kg	A	40, 53, 58
	Ammonium hydrogendifluoride, solid	8	UN1727	II	8	IB8, IP2, IP4, N34, T3, TP33	154	212	240	15 kg	50 kg	A	25, 40, 52, 53, 58
	Ammonium hydrogendifluoride, solution	8	UN2817	II	8, 6.1	IB2, N34, T8, TP2, TP13	154	202	243	1 L	30 L	B	40, 53, 58
				III	8, 6.1	IB3, N3, T4, TP1, TP13	154	203	241	5 L	60 L	B	40, 53, 58, 95
	<i>Ammonium hydrosulfide, solution, see Ammonium sulfide solution</i>												
	<i>Ammonium hydroxide, see Ammonia solutions, etc</i>												
D	Ammonium metavanadate	6.1	UN2859	II	6.1	IB8, IP2, IP4, T3, TP33	153	212	242	25 kg	100 kg	A	44, 89, 100, 141
	Ammonium nitrate based fertilizer	5.1	UN2067	III	5.1	52, 148, 150, B120, IB8, IP3, T1, TP33	152	213	240	25 kg	100 kg	B	25, 59, 60, 66, 117, 124*
A W	Ammonium nitrate based fertilizer	9	UN2071	III	9	132, B136, IB8, IP3	155	213	240	200 kg	200 kg	A	
	Ammonium nitrate emulsion or Ammonium nitrate suspension or Ammonium nitrate gel, intermediate for blasting explosives	5.1	UN3375	II	5.1	147, 148, 163, IB2, IP16	None	231	251	Forbidden	Forbidden	D	25, 59, 60, 66, 124
D	Ammonium nitrate-fuel oil mixture containing only prilled ammonium nitrate and fuel oil	1.5D	NA0331	1.5D	148	None	62	None	Forbidden	Forbidden	03	25, 19E
	Ammonium nitrate, liquid (hot concentrated solution)	5.1	UN2426	5.1	148, B5, T7	None	None	243	Forbidden	Forbidden	D	59, 60, 124
	Ammonium nitrate, with more than 0.2 percent combustible substances, including any organic substance calculated as carbon, to the exclusion of any other added substance	1.1D	UN0222	1.1D	370	None	62	None	Forbidden	Forbidden	04	25, 19E
	Ammonium nitrate, with not more than 0.2% combustible substances, including any organic substance calculated as carbon, to the exclusion of any other added substance	5.1	UN1942	III	5.1	148, A1, A29, B120, IB8, IP3, T1, TP33	152	213	240	25 kg	100 kg	A	25, 59, 60, 66, 116, 124
	<i>Ammonium nitrite</i>	Forbidden											

§ 172.101 HAZARDOUS MATERIALS TABLE—Continued

Sym-bols (1)	Hazardous materials descriptions and proper shipping names (2)	Hazard class or Division (3)	Identi-fication Numbers (4)	PG (5)	Label Codes (6)	Special provisions (§ 172.102) (7)	(8)			(9)		(10) Vessel stowage	
							Packaging (§ 173.***)			Quantity limitations (see §§ 173.27 and 175.75)		Loca-tion (10A)	Other (10B)
							Excep-tions (8A)	Non-bulk (8B)	Bulk (8C)	Passenger aircraft/rail (9A)	Cargo air-craft only (9B)		
	Ammonium perchlorate	1.1D	UN0402	1.1D	107	None	62	None	Forbidden	Forbidden	04	25, 19E
	Ammonium perchlorate	5.1	UN1442	II	5.1	107, A9, IB6, IP2, T3, TP33	152	212	242	5 kg	25 kg	E	58, 69
	<i>Ammonium permanganate</i>	Forbidden	UN1444	III	5.1	A1, A29, IB8, IP3, T1, TP33	152	213	240	25 kg	100 kg	A	
	Ammonium persulfate												
	Ammonium picrate, <i>dry or wetted with less than 10 percent water, by mass</i>	1.1D	UN0004	1.1D	None	62	None	Forbidden	Forbidden	04	25, 5E, 19E
	Ammonium picrate, <i>wetted with not less than 10 percent water, by mass</i>	4.1	UN1310	I	4.1	23, A2, N41, W31	None	211	None	0.5 kg	0.5 kg	D	28, 36
	Ammonium polysulfide, solution	8	UN2818	II	8, 6.1	IB2, T7, TP2, TP13	154	202	243	1 L	30 L	B	12, 25, 40, 52
					8, 6.1	IB3, T4, TP1, TP13	154	203	241	5 L	60 L	B	12, 25, 40, 52
	Ammonium polyvanadate	6.1	UN2861	II	6.1	IB8, IP2, IP4, T3, TP33	153	212	242	25 kg	100 kg	A	44, 89, 100, 141
	<i>Ammonium silicofluoride, see Ammonium fluorosilicate</i>												
	Ammonium sulfide solution	8	UN2683	II	8, 6.1, 3	IB1, T7, TP2, TP13	154	202	243	1 L	30 L	B	12, 22, 25, 52, 100
	<i>Ammunition, blank, see Cartridges for weapons, blank</i>												
	<i>Ammunition, illuminating with or without burster, expelling charge or propelling charge</i>	1.2G	UN0171	1.2G		62	62	Forbidden	Forbidden	03	25
	<i>Ammunition, illuminating with or without burster, expelling charge or propelling charge</i>	1.3G	UN0254	1.3G		62	62	Forbidden	Forbidden	03	25
	<i>Ammunition, illuminating with or without burster, expelling charge or propelling charge</i>	1.4G	UN0297	1.4G		62	62	Forbidden	75 kg	02	25

§ 172.101

49 CFR Ch. I (10-1-23 Edition)

Ammunition, incendiary liquid or gel, with burster, expelling charge or propelling charge	1.3J	UN0247	1.3J	62	None	Forbidden	Forbidden	05	25, 23E
<i>Ammunition, incendiary (water-activated contrivances) with burster, expelling charge or propelling charge, see Contrivances, water-activated, etc.</i>											
Ammunition, incendiary, white phosphorus, with burster, expelling charge or propelling charge	1.2H	UN0243	1.2H	62	62	Forbidden	Forbidden	05	25, 14E, 15E, 17E
Ammunition, incendiary, white phosphorus, with burster, expelling charge or propelling charge	1.3H	UN0244	1.3H	62	62	Forbidden	Forbidden	05	25, 14E, 15E, 17E
Ammunition, incendiary with or without burster, expelling charge, or propelling charge	1.2G	UN0009	1.2G	62	62	Forbidden	Forbidden	03	25
Ammunition, incendiary with or without burster, expelling charge, or propelling charge	1.3G	UN0010	1.3G	62	62	Forbidden	Forbidden	03	25
Ammunition, incendiary with or without burster, expelling charge or propelling charge	1.4G	UN0300	1.4G	62	62	Forbidden	75 kg	02	25
Ammunition, practice	1.4G	UN0362	1.4G	62	62	Forbidden	75 kg	02	25
Ammunition, practice	1.3G	UN0488	1.3G	62	62	Forbidden	Forbidden	03	25
Ammunition, proof	1.4G	UN0363	1.4G	62	62	Forbidden	75 kg	02	25
<i>Ammunition, rocket, see Warheads, rocket etc</i>											
<i>Ammunition, SA (small arms), see Cartridges for weapons, etc</i>											
<i>Ammunition, smoke (water-activated contrivances), white phosphorus, with burster, expelling charge or propelling charge, see Contrivances, water-activated, etc. (UN 0248)</i>											
<i>Ammunition, smoke (water-activated contrivances), without white phosphorus or phosphides, with burster, expelling charge or propelling charge, see Contrivances, water-activated, etc. (UN 0249)</i>											
Ammunition smoke, white phosphorus with burster, expelling charge, or propelling charge	1.2H	UN0245	1.2H	62	62	Forbidden	Forbidden	05	25, 14E, 15E, 17E

§ 172.101 HAZARDOUS MATERIALS TABLE—Continued

Sym-bols (1)	Hazardous materials descriptions and proper shipping names (2)	Hazard class or Division (3)	Identi-fication Numbers (4)	PG (5)	Label Codes (6)	Special provisions (§ 172.102) (7)	(8)			(9)		(10) Vessel stowage	
							Packaging (§ 173.***)			Quantity limitations (see §§ 173.27 and 175.75)		Loca-tion (10A)	Other (10B)
							Excep-tions (8A)	Non-bulk (8B)	Bulk (8C)	Passenger aircraft/rail (9A)	Cargo air-craft only (9B)		
	Ammunition, smoke, white phosphorus <i>with burster, expelling charge, or propelling charge</i>	1.3H	UN0246	1.3H		62	62	Forbidden	Forbidden	05	25, 14E, 15E, 17E
	Ammunition, smoke <i>with or without burster, expelling charge or propelling charge</i>	1.2G	UN0015	1.2G		62	62	Forbidden	Forbidden	03	25, 17E
	Ammunition, smoke <i>with or without burster, expelling charge or propelling charge</i>	1.3G	UN0016	1.3G		62	62	Forbidden	Forbidden	03	25, 17E
	Ammunition, smoke <i>with or without burster, expelling charge or propelling charge</i>	1.4G	UN0303	1.4G		62	62	Forbidden	75 kg	02	25, 14E, 15E, 17E
	<i>Ammunition, sporting, see Cartridges for weapons, etc. (UN 0012; UN 0328; UN 0339)</i>												
	Ammunition, tear-producing, non-explosive, <i>without burster or expelling charge, non-fuzed</i>	6.1	UN2017	6.1, 8	None	212	None	Forbidden	50 kg	E	13, 40
	Ammunition, tear-producing <i>with burster, expelling charge or propelling charge</i>	1.2G	UN0018	1.2G, 8, 6.1		62	62	Forbidden	Forbidden	03	25, 17E
	Ammunition, tear-producing <i>with burster, expelling charge or propelling charge</i>	1.3G	UN0019	1.3G, 8, 6.1		62	62	Forbidden	Forbidden	03	25, 17E
	Ammunition, tear-producing <i>with burster, expelling charge or propelling charge</i>	1.4G	UN0301	1.4G, 8, 6.1		62	62	Forbidden	75 kg	02	25, 14E, 15E, 17E
	Ammunition, toxic, non-explosive, <i>without burster or expelling charge, non-fuzed</i>	6.1	UN2016	6.1	None	212	None	Forbidden	100 kg	E	13, 40

§ 172.101

49 CFR Ch. I (10-1-23 Edition)

§ 172.101 HAZARDOUS MATERIALS TABLE—Continued

Sym- bols	Hazardous materials descriptions and proper shipping names	Hazard class or Division	Identi- fication Numbers	PG	Label Codes	Special provisions (§ 172.102)	(8)			(9)		(10) Vessel stowage	
							Packaging (§ 173.***)			Quantity limitations (see §§ 173.27 and 175.75)		Loca- tion	Other
							Excep- tions	Non-bulk	Bulk	Passenger aircraft/rail	Cargo air- craft only		
(1)	(2)	(3)	(4)	(5)	(6)	(7)	(8A)	(8B)	(8C)	(9A)	(9B)	(10A)	(10B)
	Antimony pentafluoride	8	UN1732	III	8	IB3, T4, TP1	154	203	241	5 L	60 L	C	40, 53, 58
				II	8, 6.1	A3, A7, A10, IB2, N3, N36, T7, TP2	154	202	243	Forbidden	30 L	D	40, 44, 53, 58, 89, 100, 141
	Antimony potassium tartrate	6.1	UN1551	III	6.1	IB8, IP3, T1, TP33	153	213	240	100 kg	200 kg	A	
	Antimony powder	6.1	UN2871	III	6.1	IB8, IP3, T1, TP33	153	213	240	100 kg	200 kg	A	
	<i>Antimony sulfide and a chlorate, mixtures of</i>	Forbidden											
	<i>Antimony sulfide, solid, see Antimony compounds, inorganic, n.o.s.</i>												
	Antimony trichloride, liquid	8	UN1733	II	8	B2, IB2	154	202	242	1 L	30 L	C	40, 53, 58
	Antimony trichloride, solid	8	UN1733	II	8	IB8, IP2, IP4, T3, TP33	154	212	240	15 kg	50 kg	A	40, 53, 58
	<i>Aqua ammonia, see Ammonia solution, etc</i>												
	Argon, compressed	2.2	UN1006		2.2		306, 307	302	314, 315	75 kg	150 kg	A	
	Argon, refrigerated liquid (<i>cryogenic liquid</i>)	2.2	UN1951		2.2	T75, TP5	320	316	318	50 kg	500 kg	D	
	Arsenic	6.1	UN1558	II	6.1	IB8, IP2, IP4, T3, TP33	153	212	242	25 kg	100 kg	A	
	Arsenic acid, liquid	6.1	UN1553	I	6.1	T20, TP2, TP7, TP13, W31	None	201	243	1 L	30 L	B	46
	Arsenic acid, solid	6.1	UN1554	II	6.1	IB8, IP2, IP4, T3, TP33	153	212	242	25 kg	100 kg	A	
	Arsenic bromide	6.1	UN1555	II	6.1	IB8, IP2, IP4, T3, TP33	153	212	242	25 kg	100 kg	A	12, 25, 40
	<i>Arsenic chloride, see Arsenic trichloride</i>												
G	Arsenic compounds, liquid, n.o.s. <i>inorganic, including arsenates, n.o.s.; arsenites, n.o.s.; arsenic sulfides, n.o.s.; and organic compounds of arsenic, n.o.s</i>	6.1	UN1556	I	6.1	T14, TP2, TP13, TP27	None	201	243	1 L	30 L	B	40, 137

§ 172.101

49 CFR Ch. I (10-1-23 Edition)

G	Arsenic compounds, solid, n.o.s. <i>inorganic, including arsenates, n.o.s.; arsenites, n.o.s.; arsenic sulfides, n.o.s.; and organic compounds of arsenic, n.o.s.</i>	6.1	UN1557	II	6.1	IB2, T11, TP2, TP13, TP27	153	202	243	5 L	60 L	B	40, 137
				III	6.1	IB3, T7, TP2, TP28	153	203	241	60 L	220 L	B	40, 137
				I	6.1	IB7, IP1, T6, TP33	None	211	242	5 kg	50 kg	A	137
		6.1	UN1559	II	6.1	IB8, IP2, IP4, T3, TP33	153	212	242	25 kg	100 kg	A	137
				III	6.1	IB8, IP3, T1, TP33	153	213	240	100 kg	200 kg	A	137
				II	6.1	IB8, IP2, IP4, T3, TP33	153	212	242	25 kg	100 kg	A	
		6.1	UN1560	I	6.1	2, B9, B14, B32, T20, TP2, TP13, TP38, TP45	None	227	244	Forbidden	Forbidden	B	40
						IB8, IP2, IP4, T3, TP33	153	212	242	25 kg	100 kg	A	
		6.1	UN1561	II	6.1	IB8, IP2, IP4, T3, TP33	153	212	242	25 kg	100 kg	A	
		6.1	UN1562	II	6.1	IB8, IP2, IP4, T3, TP33	153	212	242	25 kg	100 kg	A	
		3	UN2760	I	3, 6.1	T14, TP2, TP13, TP27	None	201	243	Forbidden	30 L	B	40
		6.1	UN2994	II	3, 6.1	IB2, T11, TP2, TP13, TP27	150	202	243	1 L	60 L	B	40
				I	6.1	T14, TP2, TP13, TP27	None	201	243	1 L	30 L	B	40
				II	6.1	IB2, T11, TP2, TP13, TP27	153	202	243	5 L	60 L	B	40
		6.1	UN2993	III	6.1	IB3, T7, TP2, TP28	153	203	241	60 L	220 L	A	40
I	6.1, 3			T14, TP2, TP13, TP27	None	201	243	1 L	30 L	B	40		
6.1	UN2759	II	6.1, 3	IB2, T11, TP2, TP13, TP27	153	202	243	5 L	60 L	B	40		
		III	6.1, 3	B1, IB3, T7, TP2, TP28	153	203	242	60 L	220 L	A	40		
		I	6.1	IB7, IP1, T6, TP33	None	211	242	5 kg	50 kg	A	40		
6.1	UN2759	II	6.1	IB8, IP2, IP4, T3, TP33	153	212	242	25 kg	100 kg	A	40		
		III	6.1	IB8, IP3, T1, TP33	153	213	240	100 kg	200 kg	A	40		
		II	6.1	IB8, IP2, IP4, T3, TP33	153	212	242	25 kg	100 kg	A	40		
2.3	UN2188		2.3, 2.1		1	None	192	245	Forbidden	Forbidden	D	40	
2.3	UN3522		2.3, 2.1		1	None	302c	None	Forbidden	Forbidden	D		
G	Articles containing a substance liable to spontaneous combustion, n.o.s.	4.2	UN3542		4.2		131, 391	None	214	214	Forbidden	Forbidden

§ 172.101 HAZARDOUS MATERIALS TABLE—Continued

Sym-bols	Hazardous materials descriptions and proper shipping names	Hazard class or Division	Identi-fication Numbers	PG	Label Codes	Special provisions (§ 172.102)	(8)			(9)		(10) Vessel stowage	
							Packaging (§ 173.***)			Quantity limitations (see §§ 173.27 and 175.75)		Loca-tion	Other
							Excep-tions	Non-bulk	Bulk	Passenger aircraft/rail	Cargo air-craft only		
(1)	(2)	(3)	(4)	(5)	(6)	(7)	(8A)	(8B)	(8C)	(9A)	(9B)	(10A)	(10B)
G	Articles containing a substance which in contact with water emits flammable gases, n.o.s.	4.3	UN3543	4.3	131, 391	None	214	214	Forbidden	Forbidden	
G	Articles containing corrosive substance, n.o.s.	8	UN3547	8	391	None	232	232	Forbidden	Forbidden	B
G	Articles containing flammable gas, n.o.s.	2.1	UN3537	2.1	391	None	232	232	Forbidden	Forbidden	D
G	Articles containing flammable liquid, n.o.s.	3	UN3540	3	391	None	232	232	Forbidden	Forbidden	B
G	Articles containing flammable solid, n.o.s.	4.1	UN3541	4.1	391	None	232	232	Forbidden	Forbidden	B
G	Articles containing miscellaneous dangerous goods, n.o.s.	9	UN3548	9	391	None	232	232	Forbidden	Forbidden	A
G	Articles containing non-flammable, non-toxic gas, n.o.s.	2.2	UN3538	2.2	391	None	232	232	Forbidden	Forbidden	A
G	Articles containing organic peroxide, n.o.s.	5.2	UN3545	5.2	131, 391	None	214	214	Forbidden	Forbidden	
G	Articles containing oxidizing substance, n.o.s.	5.1	UN3544	5.1	131, 391	None	214	214	Forbidden	Forbidden	
G	Articles containing toxic gas, n.o.s.	2.3	UN3539	2.3	131, 391	None	214	214	Forbidden	Forbidden	
G	Articles containing toxic substance, n.o.s.	6.1	UN3546	6.1	391	None	232	232	Forbidden	Forbidden	B
	Articles, explosive, extremely insensitive or Articles, EEI	1.6N	UN0486	1.6N	None	62	None	Forbidden	Forbidden	03	25
G	Articles, explosive, n.o.s.	1.4S	UN0349	1.4S	101, 148, 347, 382	None	62	None	25 kg	100 kg	01	25
G	Articles, explosive, n.o.s.	1.4B	UN0350	1.4B	101	None	62	None	Forbidden	Forbidden	05	25
G	Articles, explosive, n.o.s.	1.4C	UN0351	1.4C	101	None	62	None	Forbidden	75 kg	02	25
G	Articles, explosive, n.o.s.	1.4D	UN0352	1.4D	101	None	62	None	Forbidden	75 kg	02	25
G	Articles, explosive, n.o.s.	1.4G	UN0353	1.4G	101	None	62	None	Forbidden	75 kg	02	25
G	Articles, explosive, n.o.s.	1.1L	UN0354	1.1L	101	None	62	None	Forbidden	Forbidden	02	25, 14E, 15E
G	Articles, explosive, n.o.s.	1.2L	UN0355	1.2L	101	None	62	None	Forbidden	Forbidden	05	25, 14E, 15E
G	Articles, explosive, n.o.s.	1.3L	UN0356	1.3L	101	None	62	None	Forbidden	Forbidden	05	25, 14E, 15E

§ 172.101

49 CFR Ch. I (10-1-23 Edition)

G	Articles, explosive, n.o.s	1.1C	UN0462	1.1C	101	None	62	None	Forbidden	Forbidden	03	25
G	Articles, explosive, n.o.s	1.1D	UN0463	1.1D	101	None	62	None	Forbidden	Forbidden	03	25
G	Articles, explosive, n.o.s	1.1E	UN0464	1.1E	101	None	62	None	Forbidden	Forbidden	03	25
G	Articles, explosive, n.o.s	1.1F	UN0465	1.1F	101	None	62	None	Forbidden	Forbidden	03	25
G	Articles, explosive, n.o.s	1.2C	UN0466	1.2C	101	None	62	None	Forbidden	Forbidden	03	25
G	Articles, explosive, n.o.s	1.2D	UN0467	1.2D	101	None	62	None	Forbidden	Forbidden	03	25
G	Articles, explosive, n.o.s	1.2E	UN0468	1.2E	101	None	62	None	Forbidden	Forbidden	03	25
G	Articles, explosive, n.o.s	1.2F	UN0469	1.2F	101	None	62	None	Forbidden	Forbidden	03	25
G	Articles, explosive, n.o.s	1.3C	UN0470	1.3C	101	None	62	None	Forbidden	Forbidden	03	25
G	Articles, explosive, n.o.s.	1.4E	UN0471	1.4E	101	None	62	None	Forbidden	75 kg	03	25
G	Articles, explosive, n.o.s	1.4F	UN0472	1.4F	101	None	62	None	Forbidden	Forbidden	03	25
	Articles, pressurized pneumatic or hydraulic containing non-flammable gas	2.2	UN3164	2.2	371	306	302, 304	None	No limit	No limit	A	
	Articles, pyrophoric	1.2L	UN0380	1.2L	None	62	None	Forbidden	Forbidden	05	25, 14E, 15E, 17E
	Articles, pyrotechnic for technical purposes	1.1G	UN0428	1.1G	None	62	None	Forbidden	Forbidden	03	25
	Articles, pyrotechnic for technical purposes	1.2G	UN0429	1.2G	None	62	None	Forbidden	Forbidden	03	25
	Articles, pyrotechnic for technical purposes	1.3G	UN0430	1.3G	None	62	None	Forbidden	Forbidden	03	25
	Articles, pyrotechnic for technical purposes	1.4G	UN0431	1.4G	381	None	62	None	Forbidden	75 kg	02	25
	Articles, pyrotechnic for technical purposes	1.4S	UN0432	1.4S	None	62	None	25 kg	100 kg	01	25
D	Asbestos	9	NA2212	III	9	156, IB8, IP2, IP4	155	216	216, 240	200 kg	200 kg	A	34, 40
G I	Asbestos, amphibole amosite, tremolite, actinolite, anthophyllite, or crocidolite	9	UN2212	II	9	156, IB8, IP2, IP4, T3, TP33	155	216	216, 240	Forbidden	Forbidden	A	34, 40
I	Asbestos, chrysotile	9	UN2590	III	9	156, IB8, IP2, IP3, T1, TP33	155	216	216, 240	200 kg	200 kg	A	34, 40
	Ascaridole (organic peroxide)	Forbidden											
D	Asphalt, at or above its flash point	3	NA1999	III	3	IB3, T1, TP3	150	203	247	Forbidden	Forbidden	D	
D	Asphalt, cut back, see Tars, liquid, etc												
	Automobile, motorcycle, tractor, other self-propelled vehicle, engine, or other mechanical apparatus, see Vehicles or Battery etc												
A, G	Aviation regulated liquid, n.o.s	9	UN3334	9	A35, A189	155	204		450 L	450 L	A	
A, G	Aviation regulated solid, n.o.s	9	UN3335	9	A35	155	204		400 kg	400 kg	A	
	Azaurolic acid (salt of) (dry)	Forbidden											
	Azido guanidine picrate (dry)	Forbidden											
	5-Azido-1-hydroxy tetrazole	Forbidden											

§ 172.101 HAZARDOUS MATERIALS TABLE—Continued

Sym-bols (1)	Hazardous materials descriptions and proper shipping names (2)	Hazard class or Division (3)	Identi-fication Numbers (4)	PG (5)	Label Codes (6)	Special provisions (§ 172.102) (7)	(8)			(9)		(10) Vessel stowage	
							Packaging (§ 173.***)			Quantity limitations (see §§ 173.27 and 175.75)		Loca-tion (10A)	Other (10B)
							Excep-tions (8A)	Non-bulk (8B)	Bulk (8C)	Passenger aircraft/rail (9A)	Cargo air-craft only (9B)		
	<i>Azido hydroxy tetrazole (mercury and silver salts)</i>	Forbidden											
	<i>3-Azido-1,2-Propylene glycol dinitrate</i>	Forbidden											
	<i>Azidothiocarbonic acid</i>	Forbidden											
	<i>Azidoethyl nitrate</i>	Forbidden											
	<i>1-Aziridinylphosphine oxide-(tris), see Tris-(1-aziridinyl) phosphine oxide, solution</i>												
	<i>Azodicarbonamide</i>	4.1	UN3242	II	4.1	38, IB8, T3, TP33	151	223	240	Forbidden	Forbidden	D	2, 52, 53, 74
	<i>Azotetrazole (dry)</i>	Forbidden											
	<i>Barium</i>	4.3	UN1400	II	4.3	A19, IB7, IP2, IP21, T3, TP33, W31, W40	151	212	241	15 kg	50 kg	E	13, 52, 148
	<i>Barium alloys, pyrophoric</i>	4.2	UN1854	I	4.2	T21, TP7, TP33, W31	None	181	None	Forbidden	Forbidden	D	13, 148
	<i>Barium azide, dry or wetted with less than 50 percent water, by mass</i>	1.1A	UN0224	1.1A, 6.1	111, 117	None	62	None	Forbidden	Forbidden	05	25
	<i>Barium azide, wetted with not less than 50 percent water, by mass</i>	4.1	UN1571	I	4.1, 6.1	162, A2, W31	None	182	None	Forbidden	0.5 kg	D	28, 36
	<i>Barium bromate</i>	5.1	UN2719	II	5.1, 6.1	IB8, IP2, IP4, T3, TP33	152	212	242	5 kg	25 kg	A	56, 58
	<i>Barium chlorate, solid</i>	5.1	UN1445	II	5.1, 6.1	A9, IB6, IP2, N34, T3, TP33	152	212	242	5 kg	25 kg	A	56, 58
	<i>Barium chlorate, solution</i>	5.1	UN3405	II	5.1, 6.1	A9, IB2, N34, T4, TP1	152	202	243	1 L	5 L	A	56, 58, 133
				III	5.1, 6.1	A9, IB2, N34, T4, TP1	152	203	242	2.5 L	30 L	A	56, 58, 133
G	<i>Barium compounds, n.o.s</i>	6.1	UN1564	II	6.1	IB8, IP2, IP4, T3, TP33	153	212	242	25 kg	100 kg	A	
				III	6.1	IB8, IP3, T1, TP33	153	213	240	100 kg	200 kg	A	
	<i>Barium cyanide</i>	6.1	UN1565	I	6.1	IB7, IP1, N74, N75, T6, TP33, W31	None	211	242	5 kg	50 kg	A	40, 52
	<i>Barium hypochlorite with more than 22 percent available chlorine</i>	5.1	UN2741	II	5.1, 6.1	A7, A9, IB8, IP2, IP4, N34, T3, TP33	152	212	None	5 kg	25 kg	B	4, 52, 56, 58, 106
	<i>Barium nitrate</i>	5.1	UN1446	II	5.1, 6.1	IB8, IP2, IP4, T3, TP33	152	212	242	5 kg	25 kg	A	
	<i>Barium oxide</i>	6.1	UN1884	III	6.1	IB8, IP3, T1, TP33	153	213	240	100 kg	200 kg	A	

§ 172.101

49 CFR Ch. I (10-1-23 Edition)

§ 172.101 HAZARDOUS MATERIALS TABLE—Continued

Sym-bols	Hazardous materials descriptions and proper shipping names	Hazard class or Division	Identi-fication Numbers	PG	Label Codes	Special provisions (§ 172.102)	(8)			(9)		(10) Vessel stowage	
							Packaging (§ 173.***)			Quantity limitations (see §§ 173.27 and 175.75)		Loca-tion	Other
							Excep-tions	Non-bulk	Bulk	Passenger aircraft/rail	Cargo air-craft only		
(1)	(2)	(3)	(4)	(5)	(6)	(7)	(8A)	(8B)	(8C)	(9A)	(9B)	(10A)	(10B)
	<i>Benzene phosphorus thiodichloride, see Phenyl phosphorus thiodichloride</i>	8	UN2225	III	8	IB3, T4, TP1	154	203	241	5 L	60 L	A	40
	Benzene sulfonyl chloride	Forbidden											
	<i>Benzene triozonide</i>	6.1	UN1885	II	6.1	IB8, IP2, IP4, T3, TP33	153	212	242	25 kg	100 kg	A	
	<i>Benzenethiol, see Phenyl mercaptan</i>					A210							
	Benzidine	6.1	UN2224	II	6.1	IB2, T7, TP2	153	202	243	5 L	60 L	A	40, 52
	<i>1, 3, 2-Benzodioxaborole</i>	6.1	UN2587	II	6.1	IB8, IP2, IP4, T3, TP33	153	212	242	25 kg	100 kg	A	
	<i>Benzol, see Benzene</i>	8	UN2226	II	8	B2, IB2, T7, TP2	154	202	242	1 L	30 L	A	40, 53, 58
	Benzonitrile	3	UN2338	II	3	IB2, T4, TP1	150	202	242	5 L	60 L	B	40
	<i>Benzotrifluoride</i>	Forbidden											
	<i>Benzoxidiazoles (dry)</i>	Forbidden											
	<i>Benzoyl azide</i>	8	UN1736	II	8	B2, IB2, T8, TP2, TP13	154	202	242	1 L	30 L	C	40, 53, 58
	Benzoyl chloride	6.1	UN1737	II	6.1, 8	A3, A7, IB2, N33, N34, T8, TP2, TP13	None	202	243	1 L	30 L	D	13, 40, 53, 58
	Benzyl bromide	6.1	UN1738	II	6.1, 8	A3, A7, B70, IB2, N33, N42, T8, TP2, TP13	None	202	243	1 L	30 L	D	13, 40, 53, 58
	Benzyl chloride	6.1	UN1738	II	6.1, 8	A3, A7, B8, B11, IB2, N33, N34, N43, T8, TP2, TP13	153	202	243	1 L	30 L	D	13, 40, 53, 58
	<i>Benzyl chloride unstabilized</i>	8	UN1739	I	8	B4, N41, T10, TP2, TP13	None	201	243	Forbidden	2.5 L	D	40, 53, 58
	Benzyl chloroformate	6.1	UN2653	II	6.1	IB2, T7, TP2	153	202	243	5 L	60 L	B	12, 40
	Benzyl iodide	8	UN2619	II	8, 3	B2, IB2, T7, TP2	154	202	243	1 L	30 L	A	25, 40, 52
	Benzyl dimethylamine	6.1	UN1886	II	6.1	IB2, T7, TP2	153	202	243	5 L	60 L	D	40
G	Beryllium compounds, n.o.s	6.1	UN1566	III	6.1	IB8, IP2, IP4, T3, TP33	153	212	242	25 kg	100 kg	A	
						IB8, IP3, T1, TP33	153	213	240	100 kg	200 kg	A	
	Beryllium nitrate	5.1	UN2464	II	5.1, 6.1	IB8, IP2, IP4, T3, TP33	152	212	242	5 kg	25 kg	A	

§ 172.101

49 CFR Ch. I (10-1-23 Edition)

D	Beryllium, powder	6.1	UN1567	II	6.1, 4.1	IB8, IP2, IP4, T3, TP33, W100	153	212	242	15 kg	50 kg	A	13, 147, 148, 25
	Bicyclo [2,2,1] hepta-2,5-diene, stabilized or 2,5-Norbornadiene, stabilized	3	UN2251	II	3	387, IB2, T7, TP2	150	202	242	5 L	60 L	D	
	Biological substance, Category B	6.2	UN3373			A82	134	199	None	4 L or 4 kg	4 L or 4 kg	A	40
	<i>Biphenyl triazone</i>	Forbidden											
	Bipyridilium pesticides, liquid, flammable, toxic, flash point less than 23 degrees C	3	UN2782	I	3, 6.1	T14, TP2, TP13, TP27	None	201	243	Forbidden	30 L	E	
				II	3, 6.1	IB2, T11, TP2, TP13, TP27	150	202	243	1 L	60 L	B	40
	Bipyridilium pesticides, liquid, toxic	6.1	UN3016	I	6.1	T14, TP2, TP13, TP27	None	201	243	1 L	30 L	B	40
				II	6.1	IB2, T11, TP2, TP13, TP27	153	202	243	5 L	60 L	B	40
	Bipyridilium pesticides, liquid, toxic, flammable, flash point not less than 23 degrees C	6.1	UN3015	III	6.1	IB3, T7, TP2, TP28	153	203	241	60 L	220 L	A	40
				I	6.1, 3	T14, TP2, TP13, TP27	None	201	243	1 L	30 L	B	21, 40
				II	6.1, 3	IB2, T11, TP2, TP13, TP27	153	202	243	5 L	60 L	B	21, 40
	Bipyridilium pesticides, solid, toxic	6.1	UN2781	III	6.1, 3	B1, IB3, T7, TP2, TP28	153	203	242	60 L	220 L	A	21, 40
				I	6.1	IB7, IP1, T6, TP33	None	211	242	5 kg	50 kg	A	40
				II	6.1	IB8, IP2, IP4, T3, TP33	153	212	242	25 kg	100 kg	A	40
				III	6.1	IB8, IP3, T1, TP33	153	213	240	100 kg	200 kg	A	40
	<i>Bis (Aminopropyl) piperazine, see Corrosive liquid, n.o.s.</i>												
	Bisulfate, aqueous solution	8	UN2837	II	8	A7, B2, IB2, N34, T7, TP2	154	202	242	1 L	30 L	A	
				III	8	A7, IB3, N34, T4, TP1	154	203	241	5 L	60 L	A	
	Bisulfites, aqueous solutions, n.o.s.	8	UN2693	III	8	IB3, T7, TP1, TP28	154	203	241	5 L	60 L	A	40, 52
	Black powder, compressed or Gunpowder, compressed or Black powder, in pellets or Gunpowder, in pellets	1.1D	UN0028	1.1D	None	62	None	Forbidden	Forbidden	04	25
Black powder or Gunpowder, granular or as a meal	1.1D	UN0027	1.1D	None	62	None	Forbidden	Forbidden	04	25	
Black powder for small arms	4.1	NA0027	I	4.1		70	None	170	None	Forbidden	Forbidden	E	
<i>Blasting agent, n.o.s., see Explosives, blasting etc</i>													
<i>Blasting cap assemblies, see Detonator assemblies, non-electric, for blasting</i>													
<i>Blasting caps, electric, see Detonators, electric for blasting</i>													
<i>Blasting caps, non-electric, see Detonators, non-electric, for blasting</i>													
<i>Bleaching powder, see Calcium hypochlorite mixtures, etc</i>													

§ 172.101 HAZARDOUS MATERIALS TABLE—Continued

Sym-bols (1)	Hazardous materials descriptions and proper shipping names (2)	Hazard class or Division (3)	Identi-fication Numbers (4)	PG (5)	Label Codes (6)	Special provisions (§ 172.102) (7)	(8)			(9)		(10) Vessel stowage	
							Packaging (§ 173.***)			Quantity limitations (see §§ 173.27 and 175.75)		Loca-tion (10A)	Other (10B)
							Excep-tions (8A)	Non-bulk (8B)	Bulk (8C)	Passenger aircraft/rail (9A)	Cargo air-craft only (9B)		
	Bombs, photo-flash	1.1F	UN0037	1.1F		62	None	Forbidden	Forbidden	03	25
	Bombs, photo-flash	1.1D	UN0038	1.1D		62	62	Forbidden	Forbidden	03	25
	Bombs, photo-flash	1.2G	UN0039	1.2G		62	62	Forbidden	Forbidden	03	25
	Bombs, photo-flash	1.3G	UN0299	1.3G		62	62	Forbidden	Forbidden	03	25
	Bombs, smoke, non-explosive, with corrosive liquid, without initiating device	8	UN2028	II	8	None	160	None	Forbidden	50 kg	E	40
	Bombs, with bursting charge	1.1F	UN0033	1.1F		62	None	Forbidden	Forbidden	03	25
	Bombs, with bursting charge	1.1D	UN0034	1.1D		62	62	Forbidden	Forbidden	03	25
	Bombs, with bursting charge	1.2D	UN0035	1.2D		62	62	Forbidden	Forbidden	03	25
	Bombs, with bursting charge	1.2F	UN0291	1.2F		62	None	Forbidden	Forbidden	03	25
	Bombs with flammable liquid, with bursting charge	1.1J	UN0399	1.1J		62	None	Forbidden	Forbidden	05	25, 23E
	Bombs with flammable liquid, with bursting charge	1.2J	UN0400	1.2J		62	None	Forbidden	Forbidden	05	25, 23E
	Boosters with detonator	1.1B	UN0225	1.1B	None	62	None	Forbidden	Forbidden	05	25
	Boosters with detonator	1.2B	UN0268	1.2B	None	62	None	Forbidden	Forbidden	05	25
	Boosters, without detonator	1.1D	UN0042	1.1D	148	None	62	None	Forbidden	Forbidden	03	25
	Boosters, without detonator	1.2D	UN0283	1.2D	None	62	None	Forbidden	Forbidden	03	25
	Borate and chlorate mixtures, see Chlorate and borate mixtures												
	Borneol	4.1	UN1312	III	4.1	A1, IB8, IP3, T1, TP33	151	213	240	25 kg	100 kg	A	
+	Boron tribromide	8	UN2692	I	8, 6.1	2, B9, B14, B32, N34, T20, TP2, TP13, TP38, TP45	None	227	244	Forbidden	Forbidden	C	12, 25, 53, 58
	Boron trichloride	2.3	UN1741	2.3, 8	3, B9, B14	None	304	314	Forbidden	Forbidden	D	25, 40
	Boron trifluoride	2.3	UN1008	2.3, 8	2, 238, B9, B14	None	302	314, 315	Forbidden	Forbidden	D	40
	Boron trifluoride acetic acid complex, liquid	8	UN1742	II	8	B2, B6, IB2, T8, TP2	154	202	242	1 L	30 L	A	53, 58
	Boron trifluoride acetic acid complex, solid	8	UN3419	II	8	B2, B6, IB8, IP2, IP4, T3, TP33	154	212	240	15 kg	50 kg	A	53, 58
	Boron trifluoride, adsorbed	2.3	UN3519	2.3, 8	2, B9, B14	None	302c	None	Forbidden	Forbidden	D	40
	Boron trifluoride diethyl etherate	8	UN2604	I	8, 3	A19, T10, TP2, W31	None	201	243	0.5 L	2.5 L	D	40, 53, 58
	Boron trifluoride dihydrate	8	UN2851	II	8	IB2, T7, TP2	154	212	240	15 kg	50 kg	B	12, 25, 40, 53, 58

§ 172.101

49 CFR Ch. I (10-1-23 Edition)

	Boron trifluoride dimethyl etherate	4.3	UN2965	I	4.3, 8, 3	A19, T10, TP2, TP7, TP13, W31	None	201	243	Forbidden	1 L	D	21, 25, 40, 49, 100
	Boron trifluoride propionic acid complex, liquid	8	UN1743	II	8	B2, IB2, T8, TP2	154	202	242	1 L	30 L	A	53, 58
	Boron trifluoride propionic acid complex, solid	8	UN3420	II	8	B2, IB8, IP2, IP4, T3, TP33	154	212	240	15 kg	50 kg	A	53, 58
G	<i>Box toe gum</i> , see Nitrocellulose etc												
	Bromates, inorganic, aqueous solution, n.o.s	5.1	UN3213	II	5.1	350, IB2, T4, TP1	152	202	242	1 L	5 L	B	56, 58, 133
				III	5.1	350, IB2, T4, TP1	152	203	241	2.5 L	30 L	B	56, 58, 133
G	Bromates, inorganic, n.o.s	5.1	UN1450	II	5.1	350, IB8, IP2, IP4, T3, TP33	152	212	242	5 kg	25 kg	A	56, 58
+	Bromine	8	UN1744	I	8, 6.1	1, B9, B85, N34, N43, T22, TP2, TP10, TP13	None	226	249	Forbidden	Forbidden	D	12, 25, 40, 53, 58, 66, 74, 89, 90
	<i>Bromine azide</i>	Forbidden											
	Bromine chloride	2.3	UN2901		2.3, 8, 5.1	2, B9, B14, N86	None	304	314, 315	Forbidden	Forbidden	D	40, 89, 90
+	Bromine pentafluoride	5.1	UN1745	I	5.1, 6.1, 8	1, B9, B14, B30, T22, TP2, TP13, TP38, TP44	None	228	244	Forbidden	Forbidden	D	25, 40, 53, 58, 66, 90
+	Bromine solutions	8	UN1744	I	8, 6.1	1, B9, B85, N34, N43, T22, TP2, TP10, TP13	None	226	249	Forbidden	Forbidden	D	12, 25, 40, 53, 58, 66, 74, 89, 90
+	Bromine solutions	8	UN1744	I	8, 6.1	2, B9, B85, N34, N43, T22, TP2, TP10, TP13	None	227	249	Forbidden	Forbidden	D	12, 25, 40, 53, 58, 66, 74, 89, 90
+	Bromine trifluoride	5.1	UN1746	I	5.1, 6.1, 8	2, B9, B14, B32, T22, TP2, TP13, TP38, TP45	None	228	244	Forbidden	Forbidden	D	25, 40, 53, 58, 66, 90
	<i>4-Bromo-1,2-dinitrobenzene</i>	Forbidden											
	<i>4-Bromo-1,2-dinitrobenzene (unstable at 59 degrees C)</i>	Forbidden											
	1-Bromo-3-chloropropane	6.1	UN2688	III	6.1	IB3, T4, TP1	153	203	241	60 L	220 L	A	
	1-Bromo-3-methylbutane	3	UN2341	III	3	B1, IB3, T2, TP1	150	203	242	60 L	220 L	A	
	<i>1-Bromo-3-nitrobenzene (unstable at 56 degrees C)</i>	Forbidden											
	2-Bromo-2-nitropropane-1,3-diol	4.1	UN3241	III	4.1	46, IB8, IP3	151	213	None	25 kg	50 kg	C	12, 25, 40
	Bromoacetic acid, solid	8	UN3425	II	8	A7, IB8, IP2, IP4, N34, T3, TP33	154	212	240	15 kg	50 kg	A	53, 58

§ 172.101 HAZARDOUS MATERIALS TABLE—Continued

Sym-bols	Hazardous materials descriptions and proper shipping names	Hazard class or Division	Identi-fication Numbers	PG	Label Codes	Special provisions (§ 172.102)	(8)			(9)		(10) Vessel stowage		
							Packaging (§ 173.***)			Quantity limitations (see §§ 173.27 and 175.75)		Loca-tion	Other	
							Excep-tions	Non-bulk	Bulk	Passenger aircraft/rail	Cargo air-craft only			
(1)	(2)	(3)	(4)	(5)	(6)	(7)	(8A)	(8B)	(8C)	(9A)	(9B)	(10A)	(10B)	
+	Bromoacetic acid solution	8	UN1938	II	8	A7, B2, IB2, T7, TP2	154	202	242	1 L	30 L	A	40, 53, 58	
				III	8	B2, IB3, T7, TP2	154	203	241	5 L	60 L	A	40, 53, 58	
	Bromoacetone	6.1	UN1569	II	6.1, 3	2, T20, TP2, TP13	None	193	245	Forbidden	Forbidden	D	40	
	Bromoacetyl bromide	8	UN2513	II	8	B2, IB2, T8, TP2	154	202	242	1 L	30 L	C	40, 53, 58	
	Bromobenzene	3	UN2514	III	3	B1, IB3, T2, TP1	150	203	242	60 L	220 L	A		
	Bromobenzyl cyanides, liquid	6.1	UN1694	I	6.1	T14, TP2, TP13, W31	None	201	243	Forbidden	30 L	D	12, 25, 40, 52	
	Bromobenzyl cyanides, solid	6.1	UN3449	I	6.1	T6, TP33, W31	None	211	242	5 kg	50 kg	D	12, 25, 40, 52	
	1-Bromobutane	3	UN1126	II	3	IB2, T4, TP1	150	202	242	5 L	60 L	B	40	
	2-Bromobutane	3	UN2339	II	3	B1, IB2, T4, TP1	150	202	242	5 L	60 L	B	40	
	Bromochloromethane	6.1	UN1887	III	6.1	IB3, T4, TP1	153	203	241	60 L	220 L	A		
	2-Bromoethyl ether	3	UN2340	II	3	IB2, T4, TP1	150	202	242	5 L	60 L	B	40	
	Bromoform	6.1	UN2515	III	6.1	IB3, T4, TP1	153	203	241	60 L	220 L	A	12, 25, 40	
	Bromomethylpropanes	3	UN2342	II	3	IB2, T4, TP1	150	202	242	5 L	60 L	B		
	2-Bromopentane	3	UN2343	II	3	IB2, T4, TP1	150	202	242	5 L	60 L	B		
	Bromopropanes	3	UN2344	II	3	IB2, T4, TP1	150	202	242	5 L	60 L	B	40	
	3-Bromopropyne	3	UN2345	II	3	IB3, T2, TP1	150	203	242	60 L	220 L	A		
	<i>Bromosilane</i>	Forbidden				IB2, T4, TP1	150	202	242	5 L	60 L	D	40	
	<i>Bromotoluene-alpha, see Benzyl bromide</i>													
	Bromotrifluoroethylene	2.1	UN2419		2.1		None	304	314, 315	Forbidden	150 kg	B	40	
	Bromotrifluoromethane or Refrigerant gas, R 13B1.	2.2	UN1009		2.2	T50	306	304	314, 315	75 kg	150 kg	A		
Brucine	6.1	UN1570	I	6.1	IB7, IP1, T6, TP33	None	211	242	5 kg	50 kg	A			
Burstlers, explosive	1.1D	UN0043	1.1D	None	62	None	Forbidden	Forbidden	03	25		
Butadienes, stabilized or Butadienes and Hydrocarbon mixture, stabilized containing more than 40% butadienes	2.1	UN1010	2.1	387, T50	306	304	314, 315	Forbidden	150 kg	B	25, 40		
Butane see also Petroleum gases, liquefied	2.1	UN1011		2.1	19, T50	306	304	314, 315	Forbidden	150 kg	E	40		

§ 172.101

49 CFR Ch. I (10-1-23 Edition)

<i>Butane, butane mixtures and mixtures having similar properties in cartridges each not exceeding 500 grams, see Receptacles, etc</i>													
Butanedione	3	UN2346	II	3	IB2, T4, TP1	150	202	242	5 L	60 L	B		
1,2,4-Butanetriol trinitrate	Forbidden												
Butanols	3	UN1120	II	3	IB2, T4, TP1, TP29	150	202	242	5 L	60 L	B		
			III	3	B1, IB3, T2, TP1	150	203	242	60 L	220 L	A		
<i>tert</i> -Butoxycarbonyl azide	Forbidden												
Butyl acetates	3	UN1123	II	3	IB2, T4, TP1	150	202	242	5 L	60 L	B		
			III	3	B1, IB3, T2, TP1	150	203	242	60 L	220 L	A		
Butyl acid phosphate	8	UN1718	III	8	IB3, T4, TP1	154	203	241	5 L	60 L	A	53, 58	
Butyl acrylates, stabilized	3	UN2348	III	3	387, B1, IB3, T2, TP1	150	203	242	60 L	220 L	C	25	
<i>Butyl alcohols, see</i> Butanols													
Butyl benzenes	3	UN2709	III	3	B1, IB3, T2, TP2	150	203	242	60 L	220 L	A		
<i>n</i> -Butyl bromide, see 1-Bromobutane													
<i>n</i> -Butyl chloride, see Chlorobutanes													
<i>n</i> -Butyl chloroformate	6.1	UN2743	I	6.1, 8, 3	2, B9, B14, B32, T20, TP2, TP13, TP38, TP45	None	227	244	Forbidden	Forbidden	A	12, 13, 21, 25, 40, 53, 58, 100	
<i>Butyl ethers, see</i> Dibutyl ethers													
<i>Butyl ethyl ether, see</i> Ethyl butyl ether													
<i>n</i> -Butyl formate	3	UN1128	II	3	IB2, T4, TP1	150	202	242	5 L	60 L	B		
<i>tert</i> -Butyl hydroperoxide, with more than 90 percent with water	Forbidden												
<i>tert</i> -Butyl hypochlorite	4.2	UN3255	I	4.2, 8	None	211	243	Forbidden	Forbidden	D	40	
N- <i>n</i> -Butyl imidazole	6.1	UN2690	II	6.1	IB2, T7, TP2	153	202	243	5 L	60 L	A		
<i>tert</i> -Butyl isocyanate	6.1	UN2484	I	6.1, 3	1, B9, B14, B30, T20, TP2, TP13, TP38, TP44	None	226	244	Forbidden	Forbidden	D	40	
<i>n</i> -Butyl isocyanate	6.1	UN2485	I	6.1, 3	2, B9, B14, B32, B77, T20, TP2, TP13, TP38, TP45	None	227	244	Forbidden	Forbidden	D	40	
Butyl mercaptan	3	UN2347	II	3	A3, IB2, T4, TP1	150	202	242	5 L	60 L	D	52, 95, 102	
<i>n</i> -Butyl methacrylate, stabilized	3	UN2227	III	3	387, B1, IB3, T2, TP1	150	203	242	60 L	220 L	C	25	
Butyl methyl ether	3	UN2350	II	3	IB2, T4, TP1	150	202	242	5 L	60 L	B		
Butyl nitrites	3	UN2351	I	3	T11, TP1, TP8, TP27	150	201	243	1 L	30 L	E	40	
			II	3	IB2, T4, TP1	150	202	242	5 L	60 L	B	40	
			III	3	B1, IB3, T2, TP1	150	203	242	60 L	220 L	A	40	
<i>tert</i> -Butyl peroxyacetate, with more than 76 percent in solution	Forbidden												
<i>n</i> -Butyl peroxydicarbonate, with more than 52 percent in solution	Forbidden												
<i>tert</i> -Butyl peroxyisobutyrate, with more than 77 percent in solution	Forbidden												
<i>Butyl phosphoric acid, see</i> Butyl acid phosphate													

§ 172.101 HAZARDOUS MATERIALS TABLE—Continued

Sym-bols (1)	Hazardous materials descriptions and proper shipping names (2)	Hazard class or Division (3)	Identi-fication Numbers (4)	PG (5)	Label Codes (6)	Special provisions (§ 172.102) (7)	(8)			(9)		(10) Vessel stowage	
							Packaging (§ 173.***)			Quantity limitations (see §§ 173.27 and 175.75)		Loca-tion (10A)	Other (10B)
							Excep-tions (8A)	Non-bulk (8B)	Bulk (8C)	Passenger aircraft/rail (9A)	Cargo air-craft only (9B)		
	Butyl propionates	3	UN1914	III	3	B1, IB3, T2, TP1	150	203	242	60 L	220 L	A	
	5-tert-Butyl-2,4,6-trinitro-m-xylene or Musk xylene	4.1	UN2956	III	4.1	159	151	223	None	Forbidden	Forbidden	D	12, 25, 40, 127
	Butyl vinyl ether, stabilized	3	UN2352	II	3	387, IB2, T4, TP1	150	202	242	5 L	60 L	C	25, 40
	n-Butylamine	3	UN1125	II	3, 8	IB2, T7, TP1	150	202	242	1 L	5 L	B	40, 52
	N-Butylaniline	6.1	UN2738	II	6.1	IB2, T7, TP2	153	202	243	5 L	60 L	A	74
	tert-Butylcyclohexylchloroformate	6.1	UN2747	III	6.1	IB3, T4, TP1	153	203	241	60 L	220 L	A	12, 13, 25, 40
	Butylene <i>see also</i> Petroleum gases, liquefied	2.1	UN1012		2.1	19, T50	306	304	314, 315	Forbidden	150 kg	E	40
	1,2-Butylene oxide, stabilized	3	UN3022	II	3	387, IB2, T4, TP1	150	202	242	5 L	60 L	C	25, 27, 49
	Butyltoluenes	6.1	UN2667	III	6.1	IB3, T4, TP1	153	203	241	60 L	220 L	A	
	Butyltrichlorosilane	8	UN1747	II	8, 3	A7, B2, B6, N34, T10, TP2, TP7, TP13	None	206	243	Forbidden	30 L	C	40, 53, 58
	1,4-Butynediol	6.1	UN2716	III	6.1	A1, IB8, IP3, T1, TP33	153	213	240	100 kg	200 kg	C	52, 53, 70
	Butyraldehyde	3	UN1129	II	3	IB2, T4, TP1	150	202	242	5 L	60 L	B	
	Butyraldoxime	3	UN2840	III	3	B1, IB3, T2, TP1	150	203	242	60 L	220 L	A	
	Butyric acid	8	UN2820	III	8	IB3, T4, TP1	154	203	241	5 L	60 L	A	12, 25, 53, 58
	Butyric anhydride	8	UN2739	III	8	IB3, T4, TP1	154	203	241	5 L	60 L	A	53, 58
	Butyronitrile	3	UN2411	II	3, 6.1	IB2, T7, TP1, TP13	150	202	243	1 L	60 L	E	40
	Butyryl chloride	3	UN2353	II	3, 8	IB2, T8, TP2, TP13	150	202	243	1 L	5 L	C	40, 53, 58
	Cacodylic acid	6.1	UN1572	II	6.1	IB8, IP2, IP4, T3, TP33	153	212	242	25 kg	100 kg	E	52, 53, 58
G	Cadmium compounds	6.1	UN2570	I	6.1	IB7, IP1, T6, TP33	None	211	242	5 kg	50 kg	A	
				II	6.1	IB8, IP2, IP4, T3, TP33	153	212	242	25 kg	100 kg	A	
				III	6.1	IB8, IP3, T1, TP33	153	213	240	100 kg	200 kg	A	
	Caesium hydroxide	8	UN2682	II	8	IB8, IP2, IP4, T3, TP33	154	212	240	15 kg	50 kg	A	29, 52.
	Caesium hydroxide solution	8	UN2681	II	8	B2, IB2, T7, TP2	154	202	242	1 L	30 L	A	29, 52
				III	8	IB3, T4, TP1	154	203	241	5 L	60 L	A	29, 52
	Calcium	4.3	UN1401	II	4.3	IB7, IP2, IP21, T3, TP33, W31, W40	151	212	241	15 kg	50 kg	E	13, 52, 148
	Calcium arsenate	6.1	UN1573	II	6.1	IB8, IP2, IP4, T3, TP33	153	212	242	25 kg	100 kg	A	
	Calcium arsenate and calcium arsenite, mixtures, solid	6.1	UN1574	II	6.1	IB8, IP2, IP4, T3, TP33	153	212	242	25 kg	100 kg	A	

§ 172.101

49 CFR Ch. I (10-1-23 Edition)

Calcium bisulfite solution, see Bisulfites, aqueous solutions, n.o.s.													
Calcium carbide	4.3	UN1402	I	4.3	A1, A8, B55, B59, IB4, IP1, N34, T9, TP7, TP33, W31	None	211	242	Forbidden	15 kg	B	13, 52, 148	
			II	4.3	A1, A8, B55, B59, IB7, IP2, IP21, N34, T3, TP33, W31, W40	151	212	241	15 kg	50 kg	B	13, 52, 148	
Calcium chlorate	5.1	UN1452	II	5.1	A9, IB8, IP2, IP4, N34, T3, TP33	152	212	242	5 kg	25 kg	A	56, 58	
Calcium chlorate aqueous solution	5.1	UN2429	II	5.1	A2, IB2, N41, T4, TP1	152	202	242	1 L	5 L	B	56, 58, 133	
			III	5.1	A2, IB2, N41, T4, TP1	152	203	241	2.5 L	30 L	B	56, 68, 133	
Calcium chlorite	5.1	UN1453	II	5.1	A9, IB8, IP2, IP4, N34, T3, TP33	152	212	242	5 kg	25 kg	A	56, 58	
Calcium cyanamide with more than 0.1 percent of calcium carbide	4.3	UN1403	III	4.3	A1, A19, IB8, IP4, T1, TP33, W31	151	213	241	25 kg	100 kg	A	13, 52, 148	
Calcium cyanide	6.1	UN1575	I	6.1	IB7, IP1, N79, N80, T6, TP33, W31	None	211	242	5 kg	50 kg	A	40, 52	
Calcium dithionite or Calcium hydrosulfite	4.2	UN1923	II	4.2	A19, A20, IB6, IP2, T3, TP33, W31	None	212	241	15 kg	50 kg	E	13	
Calcium hydride	4.3	UN1404	I	4.3	A19, N40, W31	None	211	242	Forbidden	15 kg	E	13, 52, 148	
Calcium hydrosulfite, see Calcium dithionite													
Calcium hypochlorite, dry, corrosive or Calcium hypochlorite mixture, dry, corrosive with more than 39% available chlorine (8.8% available oxygen)	5.1	UN3485	II	5.1, 8	165, 166, A7, A9, IB8, IP2, IP4, IP13, N34, W9	152	212	None	5 kg	25 kg	D	4, 25, 52, 56, 58, 69, 142	
Calcium hypochlorite, dry or Calcium hypochlorite mixture dry with more than 39% available chlorine (8.8% available oxygen)	5.1	UN1748	II	5.1	165, 166, A7, A9, IB8, IP2, IP4, IP13, N34, W9	152	212	None	5 kg	25 kg	D	4, 25, 52, 56, 58, 69, 142	
			III	5.1	165, 171, A7, A9, IB8, IP4, IP13, N34, W9	152	213	240	25 kg	100 kg	D	4, 25, 52, 56, 58, 69, 142	
Calcium hypochlorite, hydrated, corrosive or Calcium hypochlorite, hydrated mixture, corrosive with not less than 5.5% but not more than 16% water	5.1	UN3487	II	5.1, 8	165, IB8, IP2, IP4, IP13, W9	152	212	240	5 kg	25 kg	D	4, 25, 52, 56, 58, 69, 142	
			III	5.1, 8	165, IB8, IP4, W9	152	213	240	25 kg	100 kg	D	4, 25, 52, 56, 58, 69, 142	

§ 172.101 HAZARDOUS MATERIALS TABLE—Continued

Sym-bols (1)	Hazardous materials descriptions and proper shipping names (2)	Hazard class or Division (3)	Identi-fication Numbers (4)	PG (5)	Label Codes (6)	Special provisions (§ 172.102) (7)	(8)			(9)		(10) Vessel stowage	
							Packaging (§ 173.***)			Quantity limitations (see §§ 173.27 and 175.75)		Loca-tion (10A)	Other (10B)
							Excep-tions (8A)	Non-bulk (8B)	Bulk (8C)	Passenger aircraft/rail (9A)	Cargo air-craft only (9B)		
A	Calcium hypochlorite, hydrated or Calcium hypochlorite, hydrated mixture, with not less than 5.5% but not more than 16% water	5.1	UN2880	II	5.1	165, IB8, IP2, IP4, IP13, W9	152	212	240	5 kg	25 kg	D	4, 25, 52, 56, 58, 69, 142
				III	5.1	165, 171, IB8, IP4, IP13, W9	152	213	240	25 kg	100 kg	D	4, 25, 52, 56, 58, 69, 142
	Calcium hypochlorite mixture, dry, corrosive with more than 10% but not more than 39% available chlorine	5.1	UN3486	III	5.1, 8	165, A1, A29, IB8, IP3, IP13, N34, W9, W10	152	213	240	5 kg	25 kg	D	4, 25, 52, 56, 58, 69, 142
	Calcium hypochlorite mixture, dry, with more than 10% but not more than 39% available chlorine	5.1	UN2208	III	5.1	165, A1, A29, IB8, IP3, IP13, N34, W9, W10	152	213	240	25 kg	100 kg	D	4, 25, 52, 56, 58, 69, 142
	Calcium manganese silicon	4.3	UN2844	III	4.3	A1, A19, IB8, IP4, T1, TP33, W31	151	213	241	25 kg	100 kg	A	13, 52, 85, 103, 148
	Calcium nitrate	5.1	UN1454	III	5.1	34, B120, IB8, IP3, T1, TP33	152	213	240	25 kg	100 kg	A
	Calcium oxide	8	UN1910	III	8	IB8, IP3, T1, TP33	154	213	240	25 kg	100 kg	A	
	Calcium perchlorate	5.1	UN1455	II	5.1	IB6, IP2, T3, TP33	152	212	242	5 kg	25 kg	A	56, 58
	Calcium permanganate	5.1	UN1456	II	5.1	IB6, IP2, T3, TP33	152	212	242	5 kg	25 kg	D	56, 58, 138
	Calcium peroxide	5.1	UN1457	II	5.1	IB6, IP2, T3, TP33, W100	152	212	242	5 kg	25 kg	C	13, 52, 66, 75, 148
	Calcium phosphide	4.3	UN1360	I	4.3, 6.1	A8, A19, N40, W31	None	211	242	Forbidden	15 kg	E	13, 40, 52, 85, 148
	Calcium, pyrophoric or Calcium alloys, pyrophoric	4.2	UN1855	I	4.2	W31	None	187	None	Forbidden	Forbidden	D	13, 148
	Calcium resinate	4.1	UN1313	III	4.1	A1, A19, IB6, T1, TP33	151	213	240	25 kg	100 kg	A	
Calcium resinate, fused Calcium selenate, see Selenates or Selenites	4.1	UN1314	III	4.1	A1, A19, IB4, T1, TP33	151	213	240	25 kg	100 kg	A		

§ 172.101

49 CFR Ch. I (10-1-23 Edition)

Calcium silicide	4.3	UN1405	II	4.3	A19, IB7, IP2, IP21, T3, TP33, W31	151	212	241	15 kg	50 kg	B	13, 52, 85, 103, 148
			III	4.3	A1, A19, IB8, IP21, T1, TP33, W31	151	213	241	25 kg	100 kg	B	
Camphor oil	3	UN1130	III	3	B1, IB3, T2, TP1	150	203	242	60 L	220 L	A	
Camphor, synthetic	4.1	UN2717	III	4.1	A1, IB8, IP3, T1, TP33	151	213	240	25 kg	100 kg	A	
<i>Cannon primers, see Primers, tubular</i>												
Capacitor, asymmetric with an energy storage capacity greater than 0.3 Wh	9	UN3508	9	372	176	176	176	No limit	No Limit	A	
Capacitor, electric double layer with an energy storage capacity greater than 0.3 Wh	9	UN3499	9	361	176	176	176	No limit	No limit	A	
Caproic acid	8	UN2829	III	8	IB3, T4, TP1	154	203	241	5 L	60 L	A	53, 58
<i>Caps, blasting, see Detonators, etc</i>												
Carbamate pesticides, liquid, flammable, toxic, flash point less than 23 degrees C	3	UN2758	I	3, 6.1	T14, TP2, TP13, TP27	None	201	243	Forbidden	30 L	B	40
Carbamate pesticides, liquid, toxic	6.1	UN2992	II	3, 6.1	IB2, T11, TP2, TP13, TP27	150	202	243	1 L	60 L	B	40
			I	6.1	T14, TP2, TP13, TP27	None	201	243	1 L	30 L	B	40
Carbamate pesticides, liquid, toxic, flammable, flash point not less than 23 degrees C	6.1	UN2991	II	6.1	IB2, T11, TP2, TP13, TP27	153	202	243	5 L	60 L	B	40
			I	6.1, 3	IB3, T7, TP2, TP28 T14, TP2, TP13, TP27	153 None	203 201	241 243	60 L 1 L	220 L 30 L	A B	40 40
Carbamate pesticides, solid, toxic	6.1	UN2757	III	6.1, 3	B1, IB3, T7, TP2, TP28	153	203	242	60 L	220 L	A	40
			I	6.1	IB7, IP1, T6, TP33	None	211	242	5 kg	50 kg	A	40
			II	6.1	IB8, IP2, IP4, T3, TP33	153	212	242	25 kg	100 kg	A	40
			III	6.1	IB8, IP3, T1, TP33	153	213	240	100 kg	200 kg	A	40
<i>Carbolic acid, see Phenol, solid or Phenol, molten</i>												
<i>Carbolic acid solutions, see Phenol solutions</i>												
Carbon, activated	4.2	UN1362	III	4.2	IB8, IP3, T1, TP33, W31	None	213	241	0.5 kg	0.5 kg	A	12, 25
Carbon, animal or vegetable origin	4.2	UN1361	II	4.2	IB6, T3, TP33	None	212	242	Forbidden	Forbidden	A	12, 25
			III	4.2	IB8, IP3, T1, TP33	None	213	241	Forbidden	Forbidden	A	12, 25
<i>Carbon bisulfide, see Carbon disulfide</i>												
Carbon dioxide	2.2	UN1013		2.2		306	302, 304	302, 314, 315	75 kg	150 kg	A	

§ 172.101 HAZARDOUS MATERIALS TABLE—Continued

Sym-bols	Hazardous materials descriptions and proper shipping names	Hazard class or Division	Identi-fication Numbers	PG	Label Codes	Special provisions (§ 172.102)	(8)			(9)		(10) Vessel stowage	
							Packaging (§ 173.***)			Quantity limitations (see §§ 173.27 and 175.75)		Loca-tion	Other
							Excep-tions	Non-bulk	Bulk	Passenger aircraft/rail	Cargo air-craft only		
(1)	(2)	(3)	(4)	(5)	(6)	(7)	(8A)	(8B)	(8C)	(9A)	(9B)	(10A)	(10B)
A W	Carbon dioxide, refrigerated liquid	2.2	UN2187		2.2	T75, TP5	306	304	314, 315	50 kg	500 kg	D	
	Carbon dioxide, solid or Dry ice	9	UN1845		None		217	217	240	200 kg	200 kg	C	40
	Carbon disulfide	3	UN1131	I	3, 6.1	B16, T14, TP2, TP7, TP13, W31	None	201	243	Forbidden	Forbidden	D	40, 78, 115
	Carbon monoxide, compressed	2.3	UN1016		2.3, 2.1	4	None	302	314, 315	Forbidden	25 kg	D	40
D	Carbon monoxide, refrigerated liquid (<i>cryogenic liquid</i>)	2.3	NA9202		2.3, 2.1	4, T75, TP5	None	316	318	Forbidden	Forbidden	D	
	Carbon tetrabromide	6.1	UN2516	III	6.1	IB8, IP3, T1, TP33	153	213	240	100 kg	200 kg	A	25
	Carbon tetrachloride	6.1	UN1846	II	6.1	IB2, N36, T7, TP2	153	202	243	5 L	60 L	A	40
	<i>Carbonyl chloride, see Phosgene</i>												
	Carbonyl fluoride	2.3	UN2417		2.3, 8	2	None	302	None	Forbidden	Forbidden	D	40
	Carbonyl sulfide	2.3	UN2204		2.3, 2.1	3, B14	None	304	314, 315	Forbidden	Forbidden	D	40
	<i>Cartridge cases, empty primed, see Cases, cartridge, empty, with primer</i>												
	<i>Cartridges, actuating, for aircraft ejector seat catapult, fire extinguisher, canopy removal or apparatus, see Cartridges, power device</i>												
	<i>Cartridges, explosive, see Charges, demolition</i>												
	<i>Cartridges, sporting, see Cartridges for weapons, inert projectile, or Cartridges, small arms</i>												
	Cartridges, flash	1.1G	UN0049	1.1G	None	62	None	Forbidden	Forbidden	03	25
	Cartridges, flash	1.3G	UN0050	1.3G	None	62	None	Forbidden	75 kg	03	25
	Cartridges for weapons, blank	1.1C	UN0326	1.1C	None	62	None	Forbidden	Forbidden	03	25
	Cartridges for weapons, blank	1.2C	UN0413	1.2C	None	62	None	Forbidden	Forbidden	03	25
	Cartridges for weapons, blank or Cartridges, small arms, blank	1.3C	UN0327	1.3C	None	62	None	Forbidden	Forbidden	03	25
	Cartridges for weapons, blank or Cartridges, small arms, blank	1.4C	UN0338	1.4C	None	62	None	Forbidden	75 kg	02	25

§ 172.101

49 CFR Ch. I (10-1-23 Edition)

Cartridges for weapons, blank or Cartridges, small arms, blank or Cartridges for tools, blank	1.4S	UN0014	None	63	62	None	25 kg	100 kg	01	25	
Cartridges for weapons, inert projectile	1.2C	UN0328	1.2C	None	62	62	Forbidden	Forbidden	03	25	
Cartridges for weapons, inert projectile or Cartridges, small arms	1.4S	UN0012	None	63	62	None	25 kg	100 kg	01	25	
Cartridges for weapons, inert projectile or Cartridges, small arms	1.4C	UN0339	1.4C	None	62	None	Forbidden	75 kg	02	25	
Cartridges for weapons, inert projectile or Cartridges, small arms	1.3C	UN0417	1.3C	None	62	None	Forbidden	Forbidden	03	25	
Cartridges for weapons, with bursting charge	1.1F	UN0005	1.1F	None	62	None	Forbidden	Forbidden	03	25	
Cartridges for weapons, with bursting charge	1.1E	UN0006	1.1E	None	62	62	Forbidden	Forbidden	03	25	
Cartridges for weapons, with bursting charge	1.2F	UN0007	1.2F	None	62	None	Forbidden	Forbidden	03	25	
Cartridges for weapons, with bursting charge	1.2E	UN0321	1.2E	None	62	62	Forbidden	Forbidden	03	25	
Cartridges for weapons, with bursting charge	1.4F	UN0348	1.4F	None	62	None	Forbidden	Forbidden	03	25	
Cartridges for weapons, with bursting charge	1.4E	UN0412	1.4E	None	62	62	Forbidden	75 kg	03	25	
Cartridges, oil well	1.3C	UN0277	1.3C	None	62	62	Forbidden	Forbidden	03	25	
Cartridges, oil well	1.4C	UN0278	1.4C	None	62	62	Forbidden	75 kg	02	25	
Cartridges, power device	1.3C	UN0275	1.3C	None	62	62	Forbidden	75 kg	03	25	
Cartridges, power device	1.4C	UN0276	1.4C	None	62	62	Forbidden	75 kg	02	25	
Cartridges, power device	1.4S	UN0323	1.4S	110, 347	63	62	25 kg	100 kg	01	25	
Cartridges, power device	1.2C	UN0381	1.2C	None	62	62	Forbidden	Forbidden	03	25	
Cartridges, safety, blank, see Cartridges for weapons, blank (UN 0014)													
Cartridges, safety, see Cartridges for weapons, inert projectile, or Cartridges, small arms or Cartridges, power device (UN 0323)													
Cartridges, signal	1.3G	UN0054	1.3G	None	62	None	Forbidden	75 kg	03	25	
Cartridges, signal	1.4G	UN0312	1.4G	None	62	None	Forbidden	75 kg	02	25	
Cartridges, signal	1.4S	UN0405	1.4S	None	62	None	25 kg	100 kg	01	25	
Cartridges, starter, jet engine, see Cartridges, power device													
Cases, cartridge, empty with primer	1.4S	UN0055	1.4S	50	63	62	25 kg	100 kg	01	25	
Cases, cartridges, empty with primer	1.4C	UN0379	1.4C	50	None	62	None	Forbidden	75 kg	02	25
Cases, combustible, empty, without primer	1.4C	UN0446	1.4C	None	62	None	Forbidden	75 kg	02	25	
Cases, combustible, empty, without primer	1.3C	UN0447	1.3C	None	62	None	Forbidden	Forbidden	03	25	
Casinghead gasoline see Gasoline													

§ 172.101 HAZARDOUS MATERIALS TABLE—Continued

§ 172.101

49 CFR Ch. I (10-1-23 Edition)

Sym-bols	Hazardous materials descriptions and proper shipping names	Hazard class or Division	Identi-fication Numbers	PG	Label Codes	Special provisions (§ 172.102)	(8)			(9)		(10) Vessel stowage	
							Packaging (§ 173.***)			Quantity limitations (see §§ 173.27 and 175.75)		Loca-tion	Other
							Excep-tions	Non-bulk	Bulk	Passenger aircraft/rail	Cargo air-craft only		
(1)	(2)	(3)	(4)	(5)	(6)	(7)	(8A)	(8B)	(8C)	(9A)	(9B)	(10A)	(10B)
A W	Castor beans or Castor meal or Castor pomace or Castor flake	9	UN2969	II	None	IB8, IP2, IP4, T3, TP33	155	204	240	No limit	No limit	E	34, 40, 44, 122
G	Caustic alkali liquids, n.o.s.	8	UN1719	II III	8 8	A210 B2, IB2, T11, TP2, TP27 IB3, T7, TP1, TP28	154 154	202 203	242 241	1 L 5 L	30 L 60 L	A A	29, 52 29, 52
	Caustic potash, see Potassium hydroxide etc												
	Caustic soda, (etc.) see Sodium hydroxide etc												
	Cells, containing sodium	4.3	UN3292	4.3		189	189	189	25 kg	No limit	A	
	Celluloid, in block, rods, rolls, sheets, tubes, etc., except scrap	4.1	UN2000	III	4.1	420	151	213	240	25 kg	100 kg	A	
	Celluloid, scrap	4.2	UN2002	III	4.2	IB8, IP3	None	213	241	Forbidden	Forbidden	D	
	Cement, see Adhesives containing flammable liquid												
	Cerium, slabs, ingots, or rods	4.1	UN1333	II	4.1	IB8, IP2, IP4, N34, W100	151	212	240	15 kg	50 kg	A	13, 74, 91, 147, 148
	Cerium, turnings or gritty powder	4.3	UN3078	II	4.3	A1, IB7, IP2, IP21, T3, TP33, W31, W40	151	212	242	15 kg	50 kg	E	13, 52, 148
	Cesium or Caesium	4.3	UN1407	I	4.3	A7, A19, IB4, IP1, N34, N40, W31	None	211	242	Forbidden	15 kg	D	13, 52, 148
	Cesium nitrate or Caesium nitrate	5.1	UN1451	III	5.1	A1, A29, IB8, IP3, T1, TP33	152	213	240	25 kg	100 kg	A	
D	Charcoal briquettes, shell, screenings, wood, etc.	4.2	NA1361	III	4.2	IB8, T1, TP33	151	213	240	25 kg	100 kg	A	12
	Charges, bursting, plastics bonded	1.1D	UN0457	1.1D	None	62	None	Forbidden	Forbidden	03	25
	Charges, bursting, plastics bonded	1.2D	UN0458	1.2D	None	62	None	Forbidden	Forbidden	03	25
	Charges, bursting, plastics bonded	1.4D	UN0459	1.4D	None	62	None	Forbidden	75 kg	02	25
	Charges, bursting, plastics bonded	1.4S	UN0460	1.4S	347	None	62	None	25 kg	100 kg	01	25
	Charges, demolition	1.1D	UN0048	1.1D	None	62	62	Forbidden	Forbidden	03	25
	Charges, depth	1.1D	UN0056	1.1D	None	62	62	Forbidden	Forbidden	03	25
	Charges, expelling, explosive, for fire extinguishers, see Cartridges, power device												
	Charges, explosive, commercial without detonator	1.1D	UN0442	1.1D	None	62	None	Forbidden	Forbidden	03	25

	Charges, explosive, commercial <i>without detonator</i>	1.2D	UN0443	1.2D	None	62	None	Forbidden	Forbidden	03	25	
	Charges, explosive, commercial <i>without detonator</i>	1.4D	UN0444	1.4D	None	62	None	Forbidden	75 kg	02	25	
	Charges, explosive, commercial <i>without detonator</i>	1.4S	UN0445	1.4S	347	None	62	None	25 kg	100 kg	01	25
	Charges, propelling	1.1C	UN0271	1.1C	None	62	None	Forbidden	Forbidden	03	25	
	Charges, propelling	1.3C	UN0272	1.3C	None	62	None	Forbidden	Forbidden	03	25	
	Charges, propelling	1.2C	UN0415	1.2C	None	62	None	Forbidden	Forbidden	03	25	
	Charges, propelling	1.4C	UN0491	1.4C	None	62	None	Forbidden	75 kg	02	25	
	Charges, propelling, for cannon	1.3C	UN0242	1.3C	None	62	None	Forbidden	Forbidden	03	25	
	Charges, propelling, for cannon	1.1C	UN0279	1.1C	None	62	None	Forbidden	Forbidden	03	25	
	Charges, propelling, for cannon	1.2C	UN0414	1.2C	None	62	None	Forbidden	Forbidden	03	25	
	Charges, shaped, flexible, linear	1.4D	UN0237	1.4D	None	62	None	Forbidden	75 kg	02	25	
	Charges, shaped, flexible, linear	1.1D	UN0288	1.1D	None	62	None	Forbidden	Forbidden	04	25	
	Charges, shaped, <i>without detonator</i>	1.1D	UN0059	1.1D	None	62	None	Forbidden	Forbidden	03	25	
	Charges, shaped, <i>without detonator</i>	1.2D	UN0439	1.2D	None	62	None	Forbidden	Forbidden	03	25	
	Charges, shaped, <i>without detonator</i>	1.4D	UN0440	1.4D	None	62	None	Forbidden	75 kg	02	25	
	Charges, shaped, <i>without detonator</i>	1.4S	UN0441	1.4S	347	None	62	None	25 kg	100 kg	01	25
	Charges, supplementary explosive	1.1D	UN0060	1.1D	None	62	None	Forbidden	Forbidden	03	25	
D	Chemical kit	8	NA1760	II	8	154	161	None	1 L	30 L	B	40	
	Chemical kit	9	UN3316	9	15	161	None	10 kg	10 kg	A		
G	Chemical under pressure, corrosive, n.o.s	2.2	UN3503	2.2, 8	362, T50, TP40	None	335	313, 315	Forbidden	100 kg	D	40
G	Chemical under pressure, flammable, corrosive, n.o.s	2.1	UN3505	2.1, 8	362, T50, TP40	None	335	313, 315	Forbidden	75 kg	D	40
G	Chemical under pressure, flammable, n.o.s	2.1	UN3501	2.1	362, T50, TP40	None	335	313, 315	Forbidden	75 kg	D	40
G	Chemical under pressure, flammable, toxic, n.o.s	2.1	UN3504	2.1, 6.1	362, T50, TP40	None	335	313, 315	Forbidden	75 kg	D	40
G	Chemical under pressure, n.o.s	2.2	UN3500	2.2	362, T50, TP40	None	335	313, 315	75 kg	150 kg	B	
G	Chemical under pressure, toxic, n.o.s	2.2	UN3502	2.2, 6.1	362, T50, TP40	None	335	313, 315	Forbidden	100 kg	D	40
	Chloral, anhydrous, stabilized	6.1	UN2075	II	6.1	IB2, T7, TP2	153	202	243	5 L	60 L	D	40
	Chlorate and borate mixtures	5.1	UN1458	II	5.1	A9, IB8, IP2, IP4, N34, T3, TP33	152	212	240	5 kg	25 kg	A	56, 58
				III	5.1	A9, IB8, IP3, N34, T1, TP33	152	213	240	25 kg	100 kg	A	56, 58
	Chlorate and magnesium chloride mixture solid	5.1	UN1459	II	5.1	A9, IB8, IP2, IP4, N34, T3, TP33	152	212	240	5 kg	25 kg	A	56, 58
				III	5.1	A9, IB8, IP3, N34, T1, TP33	152	213	240	25 kg	100 kg	A	56, 58
	Chlorate and magnesium chloride mixture solution	5.1	UN3407	II	5.1	A9, IB2, N34, T4, TP1	152	202	242	1 L	5 L	A	56, 58, 133
				III	5.1	A9, IB2, N34, T4, TP1	152	203	241	2.5 L	30 L	A	56, 58, 133
	<i>Chlorate of potash, see Potassium chlorate</i>													

§ 172.101 HAZARDOUS MATERIALS TABLE—Continued

Sym-bols	Hazardous materials descriptions and proper shipping names	Hazard class or Division	Identi-fication Numbers	PG	Label Codes	Special provisions (§ 172.102)	(8)			(9)		(10) Vessel stowage	
							Packaging (§ 173.***)			Quantity limitations (see §§ 173.27 and 175.75)		Loca-tion	Other
							Excep-tions	Non-bulk	Bulk	Passenger aircraft/rail	Cargo air-craft only		
(1)	(2)	(3)	(4)	(5)	(6)	(7)	(8A)	(8B)	(8C)	(9A)	(9B)	(10A)	(10B)
G	<i>Chlorate of soda, see Sodium chlorate</i>	5.1	UN3210	II	5.1	351, IB2, T4, TP1	152	202	242	1 L	5 L	B	56, 58, 133
	III				5.1	351, IB2, T4, TP1	152	203	241	2.5 L	30 L	B	56, 58, 133
G	Chlorates, inorganic, aqueous solution, n.o.s	5.1	UN1461	II	5.1	351, A9, IB6, IP2, N34, T3, TP33	152	212	242	5 kg	25 kg	A	56, 58
	Chloric acid aqueous solution, with not more than 10 percent chloric acid	5.1	UN2626	II	5.1	IB2, T4, TP1, W31	152	229	None	Forbidden	Forbidden	D	53, 56, 58
	<i>Chloride of phosphorus, see Phosphorus trichloride</i>												
	<i>Chloride of sulfur, see Sulfur chloride</i>												
	<i>Chlorinated lime, see Calcium hypochlorite mixtures, etc</i>												
	Chlorine	2.3	UN1017		2.3, 5.1, 8	2, B9, B14, N86, T50, TP19	None	304	314, 315	Forbidden	Forbidden	D	40, 51, 55, 62, 68, 89, 90
	Chlorine, adsorbed	2.3	UN3520	2.3, 5.1, 8	2, B9, B14, N86	None	302c	None	Forbidden	Forbidden	D	40, 89, 90
D	<i>Chlorine azide</i>	Forbidden											
	Chlorine dioxide, hydrate, frozen	5.1	NA9191	II	5.1, 6.1		None	229	None	Forbidden	Forbidden	E	
	<i>Chlorine dioxide (not hydrate)</i>	Forbidden											
	Chlorine pentafluoride	2.3	UN2548		2.3, 5.1, 8	1, B7, B9, B14, N86	None	304	314	Forbidden	Forbidden	D	40, 89, 90
	Chlorine trifluoride	2.3	UN1749		2.3, 5.1, 8	2, B7, B9, B14, N86	None	304	314	Forbidden	Forbidden	D	40, 89, 90
	Chlorite solution	8	UN1908	II	8	A3, A7, B2, IB2, N34, T7, TP2, TP24	154	202	242	1 L	30 L	B	26, 44, 89, 100, 141

§ 172.101

49 CFR Ch. I (10-1-23 Edition)

				III	8	A3, A7, B2, IB3, N34, T4, TP2, TP24	154	203	241	5 L	60 L	B	26, 44, 89, 100, 141
G	Chlorites, inorganic, n.o.s	5.1	UN1462	II	5.1	352, A7, IB6, IP2, N34, T3, TP33	152	212	242	5 kg	25 kg	A	56, 58
	1-Chloro-1,1-difluoroethane or Refrigerant gas R 142b	2.1	UN2517		2.1	T50	306	304	314, 315	Forbidden	150 kg	B	40
	3-Chloro-4-methylphenyl isocyanate, liquid	6.1	UN2236	II	6.1	IB2	153	202	243	5 L	60 L	B	40
	3-Chloro-4-methylphenyl isocyanate, solid	6.1	UN3428	II	6.1	IB8, IP2, IP4, T3, TP33	153	212	242	25 kg	100 kg	B	40
	1-Chloro-1,2,2,2-tetrafluoroethane or Refrigerant gas R 124	2.2	UN1021		2.2	T50	306	304	314, 315	75 kg	150 kg	A	
	4-Chloro-o-toluidine hydrochloride, solid	6.1	UN1579	III	6.1	IB8, IP3, T1, TP33	153	213	240	100 kg	200 kg	A	
	4-Chloro-o-toluidine hydrochloride, solution	6.1	UN3410	III	6.1	IB3, T4, TP1	153	203	241	60 L	220 L	A	
	1-Chloro-2,2,2-trifluoroethane or Refrigerant gas R 133a	2.2	UN1983		2.2	T50	306	304	314, 315	75 kg	150 kg	A	
	Chloroacetic acid, molten	6.1	UN3250	II	6.1, 8	IB1, T7, TP3, TP28	None	202	243	Forbidden	Forbidden	C	40, 53, 58
	Chloroacetic acid, solid	6.1	UN1751	II	6.1, 8	A3, A7, IB8, IP2, IP4, N34, T3, TP33	153	212	242	15 kg	50 kg	C	40, 53, 58
	Chloroacetic acid, solution	6.1	UN1750	II	6.1, 8	A7, IB2, N34, T7, TP2	153	202	243	1 L	30 L	C	40, 53, 58
	Chloroacetone, stabilized	6.1	UN1695	I	6.1, 3, 8	2, B9, B14, B32, N12, N32, N34, T20, TP2, TP13, TP38, TP45	None	227	244	Forbidden	Forbidden	D	21, 40, 100
	<i>Chloroacetone (unstabilized)</i>	Forbidden											
+	Chloroacetonitrile	6.1	UN2668	I	6.1, 3	2, B9, B14, B32, IB9, T20, TP2, TP13, TP38, TP45	None	227	244	Forbidden	Forbidden	A	12, 25, 40, 52
	Chloroacetophenone, liquid, (CN)	6.1	UN3416	II	6.1	A3, IB2, N12, N32, N33, T7, TP2, TP13	None	202	243	Forbidden	60 L	D	12, 25, 40
	Chloroacetophenone, solid, (CN)	6.1	UN1697	II	6.1	A3, IB8, IP2, IP4, N12, N32, N33, N34, T3, TP2, TP13, TP33	None	212	None	Forbidden	100 kg	D	12, 25, 40
	Chloroacetyl chloride	6.1	UN1752	I	6.1, 8	2, B3, B8, B9, B14, B32, B77, N34, N43, T20, TP2, TP13, TP38, TP45	None	227	244	Forbidden	Forbidden	D	40, 53, 58
	Chloroanilines, liquid	6.1	UN2019	II	6.1	IB2, T7, TP2	153	202	243	5 L	60 L	A	52
	Chloroanilines, solid	6.1	UN2018	II	6.1	IB8, IP2, IP4, T3, TP33	153	212	242	25 kg	100 kg	A	
	Chloroanisidines	6.1	UN2233	III	6.1	IB8, IP3, T1, TP33	153	213	240	100 kg	200 kg	A	
	Chlorobenzene	3	UN1134	III	3	B1, IB3, T2, TP1	150	203	242	60 L	220 L	A	
	<i>Chlorobenzol</i> , see Chlorobenzene												
	Chlorobenzotrifluorides	3	UN2234	III	3	B1, IB3, T2, TP1	150	203	242	60 L	220 L	A	40
	Chlorobenzyl chlorides, liquid	6.1	UN2235	III	6.1	IB3, T4, TP1	153	203	241	60 L	220 L	A	
	Chlorobenzyl chlorides, solid	6.1	UN3427	III	6.1	IB8, IP3, T1, TP33	153	213	240	100 kg	200 kg	A	
	Chlorobutanes	3	UN1127	II	3	IB2, T4, TP1	150	202	242	5 L	60 L	B	

§ 172.101 HAZARDOUS MATERIALS TABLE—Continued

§ 172.101

49 CFR Ch. I (10-1-23 Edition)

Sym-bols (1)	Hazardous materials descriptions and proper shipping names (2)	Hazard class or Division (3)	Identi-fication Numbers (4)	PG (5)	Label Codes (6)	Special provisions (§ 172.102) (7)	(8)			(9)		(10) Vessel stowage	
							Packaging (§ 173.***)			Quantity limitations (see §§ 173.27 and 175.75)		Loca-tion (10A)	Other (10B)
							Excep-tions (8A)	Non-bulk (8B)	Bulk (8C)	Passenger aircraft/rail (9A)	Cargo air-craft only (9B)		
	Chlorocresols solution	6.1	UN2669	II	6.1	IB2, T7, TP2	153	202	243	5 L	60 L	A	12, 25
	Chlorocresols, solid	6.1	UN3437	III	6.1	IB3, T7, TP2	153	203	241	60 L	220 L	A	12, 25
	Chlorodifluorobromomethane or Refrigerant gas R 12B1	2.2	UN1974	II	6.1	IB8, IP2, IP4, T3, TP33	153	212	242	25 kg	100 kg	A	12, 25
	Chlorodifluoromethane and chloropentafluoroethane mixture or Refrigerant gas R 502 with fixed boiling point, with approximately 49 percent chlorodifluoromethane	2.2	UN1973		2.2	T50	306	304	314, 315	75 kg	150 kg	A	
	Chlorodifluoromethane or Refrigerant gas R 22	2.2	UN1018		2.2	T50	306	304	314, 315	75 kg	150 kg	A	
+	Chlorodinitrobenzenes, liquid.	6.1	UN1577	II	6.1	IB2, T7, TP2	153	202	243	5 L	60 L	B	91
+	Chlorodinitrobenzenes, solid	6.1	UN3441	II	6.1	IB8, IP2, IP4, T3, TP33	153	212	242	25 kg	100 kg	A	91
	2-Chloroethanal	6.1	UN2232	I	6.1	2, B9, B14, B32, T20, TP2, TP13, TP38, TP45	None	227	244	Forbidden	Forbidden	D	40
	Chloroform	6.1	UN1888	III	6.1	IB3, N36, T7, TP2	153	203	241	60 L	220 L	A	40
G	Chloroformates, toxic, corrosive, flammable, n.o.s	6.1	UN2742	II	6.1, 8, 3	5, IB1, T7, TP2	153	202	243	1 L	30 L	A	12, 13, 21, 25, 40, 53, 58, 100
G	Chloroformates, toxic, corrosive, n.o.s	6.1	UN3277	II	6.1, 8	IB2, T8, TP2, TP13, TP28	153	202	243	1 L	30 L	A	12, 13, 25, 40, 53, 58
	Chloromethyl chloroformate	6.1	UN2745	II	6.1, 8	IB2, T7, TP2, TP13	153	202	243	1 L	30 L	A	12, 13, 25, 40, 53, 58
	Chloromethyl ethyl ether	3	UN2354	II	3, 6.1	IB2, T7, TP1, TP13	150	202	243	1 L	60 L	E	40
	Chloronitroanilines	6.1	UN2237	III	6.1	IB8, IP3, T1, TP33	153	213	240	100 kg	200 kg	A	
+	Chloronitrobenzenes, liquid	6.1	UN3409	II	6.1	IB2, T7, TP2	153	202	243	5 L	60 L	A	44, 89, 100, 141
+	Chloronitrobenzenes, solid	6.1	UN1578	II	6.1	IB8, IP2, IP4, T3, TP33	153	212	242	25 kg	100 kg	A	
	Chloronitrotoluenes, liquid	6.1	UN2433	III	6.1	IB3, T4, TP1	153	203	241	60 L	220 L	A	44, 89, 100, 141
	Chloronitrotoluenes, solid	6.1	UN3457	III	6.1	IB8, IP3, T1, TP33	153	213	240	25 kg	200 kg	A	

	Chloropentafluoroethane or Refrigerant gas R 115	2.2	UN1020		2.2		T50	306	304	314, 315	75 kg	150 kg	A	
	Chlorophenolates, liquid or Phenolates, liquid	8	UN2904	III	8		IB3	154	203	241	5 L	60 L	A	
	Chlorophenolates, solid or Phenolates, solid	8	UN2905	III	8		IB8, IP3, T1, TP33	154	213	240	25 kg	100 kg	A	
	Chlorophenols, liquid	6.1	UN2021	III	6.1		IB3, T4, TP1	153	203	241	60 L	220 L	A	
	Chlorophenols, solid	6.1	UN2020	III	6.1		IB8, IP3, T1, TP1, TP33	153	213	240	100 kg	200 kg	A	
	Chlorophenyltrichlorosilane	8	UN1753	II	8		A7, B2, B6, N34, T10, TP2, TP7	None	206	242	Forbidden	30 L	C	40, 53, 58
+	Chloropicrin	6.1	UN1580	I	6.1		2, B7, B9, B14, B32, B46, T22, TP2, TP13, TP38, TP45	None	227	244	Forbidden	Forbidden	D	40
	Chloropicrin and methyl bromide mixtures	2.3	UN1581		2.3		2, B9, B14, N86, T50	None	193	314, 315	Forbidden	Forbidden	D	25, 40
	Chloropicrin and methyl chloride mixtures	2.3	UN1582		2.3		2, N86, T50	None	193	245	Forbidden	Forbidden	D	25, 40
	<i>Chloropicrin mixture, flammable (pressure not exceeding 14.7 psia at 115 degrees F flash point below 100 degrees F) see Toxic liquids, flammable, etc</i>													
G	Chloropicrin mixtures, n.o.s	6.1	UN1583	I	6.1		5	None	201	243	Forbidden	Forbidden	C	40
				II	6.1		IB2	153	202	243	Forbidden	Forbidden	C	40
				III	6.1		IB3	153	203	241	Forbidden	Forbidden	C	40
D	Chloropivaloyl chloride	6.1	NA9263	I	6.1, 8		2, B9, B14, B32, T20, TP4, TP13, TP38, TP45	None	227	244	Forbidden	Forbidden	B	40
	Chloroplatinic acid, solid	8	UN2507	III	8		IB8, IP3, T1, TP33	154	213	240	25 kg	100 kg	A	53, 58
	Chloroprene, stabilized	3	UN1991	I	3, 6.1		387, B57, T14, TP2, TP13	None	201	243	Forbidden	30 L	D	25, 40
	<i>Chloroprene, uninhibited</i>		Forbidden											
	1-Chloropropane	3	UN1278	II	3		IB2, IP8, N34, T7, TP2	150	202	242	Forbidden	60 L	E	
	2-Chloropropane	3	UN2356	I	3		N36, T11, TP2, TP13	150	201	243	1 L	30 L	E	
	3-Chloropropanol-1	6.1	UN2849	III	6.1		IB3, T4, TP1	153	203	241	60 L	220 L	A	
	2-Chloropropene	3	UN2456	I	3		N36, T11, TP2	150	201	243	1 L	30 L	E	
	2-Chloropropionic acid	8	UN2511	III	8		IB3, T4, TP2	154	203	241	5 L	60 L	A	8, 53, 58
	2-Chloropyridine	6.1	UN2822	II	6.1		IB2, T7, TP2	153	202	243	5 L	60 L	A	40
	Chlorosilanes, corrosive, flammable, n.o.s	8	UN2986	II	8, 3		T14, TP2, TP7, TP13, TP27	None	206	243	Forbidden	30 L	C	40, 53, 58
	Chlorosilanes, corrosive, n.o.s	8	UN2987	II	8		B2, T14, TP2, TP7, TP13, TP27	None	206	242	Forbidden	30 L	C	40, 53, 58
	Chlorosilanes, flammable, corrosive, n.o.s	3	UN2985	II	3, 8		T14, TP2, TP7, TP13, TP27	None	206	243	Forbidden	5 L	B	40, 53, 58
G	Chlorosilanes, toxic, corrosive, flammable, n.o.s	6.1	UN3362	II	6.1, 8, 3		T14, TP2, TP7, TP13, TP27	None	206	243	Forbidden	30 L	C	40, 53, 58, 125
G	Chlorosilanes, toxic, corrosive, n.o.s	6.1	UN3361	II	6.1, 8		T14, TP2, TP7, TP13, TP27	None	206	243	Forbidden	30 L	C	40, 53, 58

§ 172.101 HAZARDOUS MATERIALS TABLE—Continued

Sym- bols	Hazardous materials descriptions and proper shipping names	Hazard class or Division	Identi- fication Numbers	PG	Label Codes	Special provisions (§ 172.102)	(8)			(9)		(10) Vessel stowage	
							Packaging (§ 173.***)			Quantity limitations (see §§ 173.27 and 175.75)		Loca- tion	Other
							Excep- tions	Non-bulk	Bulk	Passenger aircraft/rail	Cargo air- craft only		
(1)	(2)	(3)	(4)	(5)	(6)	(7)	(8A)	(8B)	(8C)	(9A)	(9B)	(10A)	(10B)
	Chlorosilanes, water-reactive, flam- mable, corrosive, n.o.s	4.3	UN2988	I	4.3, 3, 8	A2, T14, TP2, TP7, TP13, W31	None	201	244	Forbidden	1 L	D	13, 21, 40, 49, 53, 58, 100, 147, 148
+	Chlorosulfonic acid (<i>with or without sulfur trioxide</i>)	8	UN1754	I	8, 6.1	2, B9, B10, B14, B32, T20, TP2, TP38, TP45	None	227	244	Forbidden	Forbidden	C	40, 53, 58
	Chlorotoluenes	3	UN2238	III	3	B1, IB3, T2, TP1	150	203	242	60 L	220 L	A	
	Chlorotoluidines, liquid	6.1	UN3429	III	6.1	IB3, T4, TP1	153	203	241	60 L	220 L	A	
	Chlorotoluidines, solid	6.1	UN2239	III	6.1	IB8, IP3, T1, TP33	153	213	240	100 kg	200 kg	A	
	Chlorotrifluoromethane and trifluoromethane azeotropic mix- ture or Refrigerant gas R 503 <i>with approximately 60 percent chlorotrifluoromethane</i>	2.2	UN2599		2.2		306	304	314, 315	75 kg	150 kg	A	
	Chlorotrifluoromethane or Refrig- erant gas R 13	2.2	UN1022		2.2		306	304	314, 315	75 kg	150 kg	A	
	Chromic acid solution	8	UN1755	II	8	B2, IB2, T8, TP2	154	202	242	1 L	30 L	C	40, 44, 53, 58, 89, 100, 141
				III	8	IB3, T4, TP1	154	203	241	5 L	60 L	C	40, 44, 53, 58, 89, 100, 141
	<i>Chromic anhydride, see Chromium trioxide, anhydrous</i>												
	Chromic fluoride, solid	8	UN1756	II	8	IB8, IP2, IP4, T3, TP33	154	212	240	15 kg	50 kg	A	52, 53, 58
	Chromic fluoride, solution	8	UN1757	II	8	B2, IB2, T7, TP2	154	202	242	1 L	30 L	A	53, 58
				III	8	IB3, T4, TP1	154	203	241	5 L	60 L	A	53, 58
				III	8	IB3, T4, TP1	154	203	241	5 L	60 L	A	
	Chromium nitrate	5.1	UN2720	III	5.1	A1, A29, IB8, IP3, T1, TP33	152	213	240	25 kg	100 kg	A	

§ 172.101

49 CFR Ch. I (10-1-23 Edition)

	Chromium oxychloride	8	UN1758	I	8	A7, B10, N34, T10, TP2	None	201	243	0.5 L	2.5 L	C	40, 53, 58, 66, 74, 89, 90
	Chromium trioxide, anhydrous	5.1	UN1463	II	5.1, 6.1, 8	IB8, IP2, IP4, T3, TP33, W31	152	212	242	5 kg	25 kg	A	66, 90
	Chromosulfuric acid	8	UN2240	I	8	A7, B4, B6, N34, T10, TP2, TP13	None	201	243	0.5 L	2.5 L	B	40, 53, 58, 66, 74, 89, 90
	<i>Chromyl chloride, see Chromium oxychloride</i>												
	<i>Cigar and cigarette lighters, charged with fuel, see Lighters or Lighter refills containing flammable gas.</i>												
	<i>Coal briquettes, hot</i>	Forbidden											
	Coal gas, compressed	2.3	UN1023		2.3, 2.1		3	302	314, 315	Forbidden	Forbidden	D	40
	Coal tar distillates, flammable	3	UN1136	II III	3 3	IB2, T4, TP1 B1, IB3, T4, TP1, TP29	150 150	202 203	242 242	5 L 60 L	60 L 220 L	B A	
	<i>Coal tar dye, corrosive, liquid, n.o.s., see Dyes, liquid or solid, n.o.s. or Dye intermediates, liquid or solid, corrosive, n.o.s.</i>												
	Coating solution (includes surface treatments or coatings used for industrial or other purposes such as vehicle undercoating, drum or barrel lining)	3	UN1139	I	3	T11, TP1, TP8, TP27	150	201	243	1 L	30 L	E	
				II	3	149, 383, IB2, T4, TP1, TP8	150	202	242	5 L	60 L	B	
				III	3	B1, IB3, T2, TP1	150	203	242	60 L	220 L	A	
	Cobalt naphthenates, powder	4.1	UN2001	III	4.1	A19, IB8, IP3, T1, TP33	151	213	240	25 kg	100 kg	A	
	Cobalt resinate, precipitated	4.1	UN1318	III	4.1	A1, A19, IB6, T1, TP33	151	213	240	25 kg	100 kg	A	
	<i>Coke, hot</i>	Forbidden											
	<i>Collodion, see Nitrocellulose etc</i>												
D G	Combustible liquid, n.o.s.	Comb liq	NA1993	III	None	148, IB3, T1, TP1	150	203	241	60 L	220 L	A
G	Components, explosive train, n.o.s.	1.2B	UN0382	1.2B	101	None	62	None	Forbidden	Forbidden	05	25
G	Components, explosive train, n.o.s.	1.4B	UN0383	1.4B	101	None	62	None	Forbidden	75 kg	05	25
G	Components, explosive train, n.o.s.	1.4S	UN0384	1.4S	101, 347	None	62	None	25 kg	100 kg	01	25
G	Components, explosive train, n.o.s.	1.1B	UN0461	1.1B	101	None	62	None	Forbidden	Forbidden	05	25
	<i>Composition B, see Hexolite, etc</i>												
D G	Compounds, cleaning liquid	8	NA1760	I	8	A7, B10, T14, TP2, TP27	None	201	243	0.5 L	2.5 L	B	40
				II	8	386, B2, IB2, N37, T11, TP2, TP27	154	202	242	1 L	30 L	B	40
				III	8	386, IB3, N37, T7, TP1, TP28	154	203	241	5 L	60 L	A	40

§ 172.101 HAZARDOUS MATERIALS TABLE—Continued

§ 172.101

49 CFR Ch. I (10-1-23 Edition)

Sym-bols	Hazardous materials descriptions and proper shipping names	Hazard class or Division	Identi-fication Numbers	PG	Label Codes	Special provisions (§ 172.102)	(8)			(9)		(10) Vessel stowage		
							Packaging (§ 173.***)			Quantity limitations (see §§ 173.27 and 175.75)		Loca-tion	Other	
							Excep-tions	Non-bulk	Bulk	Passenger aircraft/rail	Cargo air-craft only			
(1)	(2)	(3)	(4)	(5)	(6)	(7)	(8A)	(8B)	(8C)	(9A)	(9B)	(10A)	(10B)	
D G	Compounds, cleaning liquid	3	NA1993	I	3	T11, TP1	150	201	243	1 L	30 L	E		
					II	3	IB2, T7, TP1, TP8, TP28	150	202	242	5 L	60 L	B	
					III	3	B1, B52, IB3, T4, TP1, TP29	150	203	242	60 L	220 L	A	
D G	Compounds, tree killing, liquid or Compounds, weed killing, liquid	8	NA1760	I	8	A7, B10, T14, TP2, TP27	None	201	243	0.5 L	2.5 L	B	40	
					II	8	B2, IB2, N37, T11, TP2, TP27	154	202	242	1 L	30 L	B	40
D G	Compounds, tree killing, liquid or Compounds, weed killing, liquid	3	NA1993	III	8	IB3, N37, T7, TP1, TP28	154	203	241	5 L	60 L	A	40	
					I	3	T11, TP1	150	201	243	1 L	30 L	E	
					II	3	IB2, T7, TP1, TP8, TP28	150	202	242	5 L	60 L	B	
D G	Compounds, tree killing, liquid or Compounds, weed killing, liquid	6.1	NA2810	III	3	B1, B52, IB3, T4, TP1, TP29	150	203	242	60 L	220 L	A		
					I	6.1	T14, TP2, TP13, TP27	None	201	243	1 L	30 L	B	40
G	Compressed gas, flammable, n.o.s.	2.1	UN1954		6.1	IB2, T11, TP2, TP27	153	202	243	5 L	60 L	B	40	
					III	2.1	IB3, T7, TP1, TP28	153	203	241	60 L	220 L	A	40
G	Compressed gas, n.o.s.	2.2	UN1956		2.2		306, 307	302, 305	314, 315	75 kg	150 kg	A		
G	Compressed gas, oxidizing, n.o.s.	2.2	UN3156		2.2, 5.1	A14	306	302	314, 315	75 kg	150 kg	D		
G I	Compressed gas, toxic, corrosive, n.o.s. <i>Inhalation Hazard Zone A</i>	2.3	UN3304		2.3, 8		1	None	192	245	Forbidden	Forbidden	D	40
G I	Compressed gas, toxic, corrosive, n.o.s. <i>Inhalation Hazard Zone B</i>	2.3	UN3304		2.3, 8	2, B9, B14	None	302, 305	314, 315	Forbidden	Forbidden	D	40	
G I	Compressed gas, toxic, corrosive, n.o.s. <i>Inhalation Hazard Zone C</i>	2.3	UN3304		2.3, 8	3, B14	None	302, 305	314, 315	Forbidden	Forbidden	D	40	
G I	Compressed gas, toxic, corrosive, n.o.s. <i>Inhalation Hazard Zone D</i>	2.3	UN3304		2.3, 8		4	None	302, 305	314, 315	Forbidden	Forbidden	D	40
G I	Compressed gas, toxic, flammable, corrosive, n.o.s. <i>Inhalation Hazard Zone A</i>	2.3	UN3305		2.3, 2.1, 8		1	None	192	245	Forbidden	Forbidden	D	17, 40
G I	Compressed gas, toxic, flammable, corrosive, n.o.s. <i>Inhalation Hazard Zone B</i>	2.3	UN3305		2.3, 2.1, 8	2, B9, B14	None	302, 305	314, 315	Forbidden	Forbidden	D	17, 40	

G I	Compressed gas, toxic, flammable, corrosive, n.o.s. <i>Inhalation Hazard Zone C</i>	2.3	UN3305	2.3, 2.1, 8	3, B14	None	302, 305	314, 315	Forbidden	Forbidden	D	17, 40
G I	Compressed gas, toxic, flammable, corrosive, n.o.s. <i>Inhalation Hazard Zone D</i>	2.3	UN3305	2.3, 2.1, 8	4	None	302, 305	314, 315	Forbidden	Forbidden	D	17, 40
G	Compressed gas, toxic, flammable, n.o.s. <i>Inhalation hazard Zone A</i>	2.3	UN1953	2.3, 2.1	1	None	192	245	Forbidden	Forbidden	D	40
G	Compressed gas, toxic, flammable, n.o.s. <i>Inhalation hazard Zone B</i>	2.3	UN1953	2.3, 2.1	2, B9, B14	None	302, 305	314, 315	Forbidden	Forbidden	D	40
G	Compressed gas, toxic, flammable, n.o.s. <i>Inhalation Hazard Zone C</i>	2.3	UN1953	2.3, 2.1	3, B14	None	302, 305	314, 315	Forbidden	Forbidden	D	40
G	Compressed gas, toxic, flammable, n.o.s. <i>Inhalation Hazard Zone D</i>	2.3	UN1953	2.3, 2.1	4	None	302, 305	314, 315	Forbidden	Forbidden	D	40
G	Compressed gas, toxic, n.o.s. <i>Inhalation Hazard Zone A</i>	2.3	UN1955	2.3	1	None	192	245	Forbidden	Forbidden	D	40
G	Compressed gas, toxic, n.o.s. <i>Inhalation Hazard Zone B</i>	2.3	UN1955	2.3	2, B9, B14	None	302, 305	314, 315	Forbidden	Forbidden	D	40
G	Compressed gas, toxic, n.o.s. <i>Inhalation Hazard Zone C</i>	2.3	UN1955	2.3	3, B14	None	302, 305	314, 315	Forbidden	Forbidden	D	40
G	Compressed gas, toxic, n.o.s. <i>Inhalation Hazard Zone D</i>	2.3	UN1955	2.3	4	None	302, 305	314, 315	Forbidden	Forbidden	D	40
G I	Compressed gas, toxic, oxidizing, corrosive, n.o.s. <i>Inhalation Hazard Zone A</i>	2.3	UN3306	2.3, 5.1, 8	1	None	192	244	Forbidden	Forbidden	D	40, 89, 90
G I	Compressed gas, toxic, oxidizing, corrosive, n.o.s. <i>Inhalation Hazard Zone B</i>	2.3	UN3306	2.3, 5.1, 8	2, B9, B14	None	302, 305	314, 315	Forbidden	Forbidden	D	40, 89, 90
G I	Compressed gas, toxic, oxidizing, corrosive, n.o.s. <i>Inhalation Hazard Zone C</i>	2.3	UN3306	2.3, 5.1, 8	3, B14	None	302, 305	314, 315	Forbidden	Forbidden	D	40, 89, 90
G I	Compressed gas, toxic, oxidizing, corrosive, n.o.s. <i>Inhalation Hazard Zone D</i>	2.3	UN3306	2.3, 5.1, 8	4	None	302, 305	314, 315	Forbidden	Forbidden	D	40, 89, 90
G	Compressed gas, toxic, oxidizing, n.o.s. <i>Inhalation Hazard Zone A</i>	2.3	UN3303	2.3, 5.1	1	None	192	245	Forbidden	Forbidden	D	40
G	Compressed gas, toxic, oxidizing, n.o.s. <i>Inhalation Hazard Zone B</i>	2.3	UN3303	2.3, 5.1	2, B9, B14	None	302, 305	314, 315	Forbidden	Forbidden	D	40
G	Compressed gas, toxic, oxidizing, n.o.s. <i>Inhalation Hazard Zone C</i>	2.3	UN3303	2.3, 5.1	3, B14	None	302, 305	314, 315	Forbidden	Forbidden	D	40
G	Compressed gas, toxic, oxidizing, n.o.s. <i>Inhalation Hazard Zone D</i>	2.3	UN3303	2.3, 5.1	4	None	302, 305	314, 315	Forbidden	Forbidden	D	40
	Consumer commodity	9	ID8000	9		167	167	None	30 kg gross	30 kg gross		
G	Contrivances, water-activated, with burster, expelling charge or propelling charge	1.2L	UN0248 1.2L	None	62	None	Forbidden	Forbidden	05	25, 14E, 15E, 17E

§ 172.101 HAZARDOUS MATERIALS TABLE—Continued

Sym-bols	Hazardous materials descriptions and proper shipping names	Hazard class or Division	Identi-fication Numbers	PG	Label Codes	Special provisions (§ 172.102)	(8)			(9)		(10) Vessel stowage	
							Packaging (§ 173.***)			Quantity limitations (see §§ 173.27 and 175.75)		Loca-tion	Other
							Excep-tions	Non-bulk	Bulk	Passenger aircraft/rail	Cargo air-craft only		
(1)	(2)	(3)	(4)	(5)	(6)	(7)	(8A)	(8B)	(8C)	(9A)	(9B)	(10A)	(10B)
G	Contrivances, water-activated, <i>with burster, expelling charge or propelling charge</i>	1.3L	UN0249	1.3L	None	62	None	Forbidden	Forbidden	05	25, 14E, 15E, 17E
	Copper acetoarsenite <i>Copper acetylide</i> <i>Copper amine azide</i>	6.1 Forbidden Forbidden	UN1585	II	6.1	IB8, IP2, IP4, T3, TP33	153	212	242	25 kg	100 kg	A	
	Copper arsenite	6.1	UN1586	II	6.1	IB8, IP2, IP4, T3, TP33	153	212	242	25 kg	100 kg	A	
	Copper based pesticides, liquid, flammable, toxic, <i>flash point less than 23 degrees C</i>	3	UN2776	I	3, 6.1	T14, TP2, TP13, TP27	None	201	243	Forbidden	30 L	B	40
				II	3, 6.1	IB2, T11, TP2, TP13, TP27	150	202	243	1 L	60 L	B	40
	Copper based pesticides, liquid, toxic	6.1	UN3010	I	6.1	T14, TP2, TP13, TP27	None	201	243	1 L	30 L	B	40
				II	6.1	IB2, T11, TP2, TP13, TP27	153	202	243	5 L	60 L	B	40
	Copper based pesticides, liquid, toxic, flammable, <i>flash point not less than 23 degrees C</i>	6.1	UN3009	III I	6.1 6.1, 3	IB3, T7, TP2, TP28 T14, TP2, TP13, TP27	153 None	203 201	241 243	60 L 1 L	220 L 30 L	A B	40 40
				II	6.1, 3	IB2, T11, TP2, TP13, TP27	153	202	243	5 L	60 L	B	40
	Copper based pesticides, solid, toxic	6.1	UN2775	III I	6.1, 3 6.1	B1, IB3, T7, TP2, TP28 IB7, IP1, T6, TP33	153 None	203 211	242 242	60 L 5 kg	220 L 50 kg	A A	40 40
				II	6.1	IB8, IP2, IP4, T3, TP33	153	212	242	25 kg	100 kg	A	40
	Copper chlorate	5.1	UN2721	III II	6.1 5.1	IB8, IP3, T1, TP33 A1, IB8, IP2, IP4, T3, TP33	153 152	213 212	240 242	100 kg 5 kg	200 kg 25 kg	A A	40 56, 58
	Copper chloride	8	UN2802	III	8	IB8, IP3, T1, TP33	154	213	240	25 kg	100 kg	A	53, 58
	Copper cyanide	6.1	UN1587	II	6.1	IB8, IP2, IP4, T3, TP33	153	204	242	25 kg	100 kg	A	52
	<i>Copper selenate, see Selenates or Selenites</i> <i>Copper selenite, see Selenates or Selenites</i> <i>Copper tetramine nitrate</i>	Forbidden											

§ 172.101

49 CFR Ch. I (10-1-23 Edition)

A,W	Copra	4.2	UN1363	III	4.2	B136, IB8, IP3, IP7	None	213	241	Forbidden	Forbidden	A	13, 25, 119
	Cord, detonating, <i>flexible</i>	1.1D	UN0065	1.1D	102, 148	63(a)	62	None	Forbidden	Forbidden	03	25
	Cord, detonating, <i>flexible</i>	1.4D	UN0289	1.4D	148	None	62	None	Forbidden	75 kg	02	25
	Cord, detonating or Fuze, detonating <i>metal clad</i>	1.2D	UN0102	1.2D	None	62	None	Forbidden	Forbidden	03	25
	Cord, detonating or Fuze, detonating <i>metal clad</i>	1.1D	UN0290	1.1D	None	62	None	Forbidden	Forbidden	03	25
	Cord, detonating, mild effect or Fuze, detonating, mild effect <i>metal clad</i>	1.4D	UN0104	1.4D	None	62	None	Forbidden	75 kg	02	25
	Cord, igniter	1.4G	UN0066	1.4G	None	62	None	Forbidden	75 kg	02	25
	<i>Cordeau detonant fuse</i> , see Cord, detonating, etc; Cord, detonating, <i>flexible</i>												
G	<i>Cordite</i> , see Powder, smokeless												
	Corrosive liquid, acidic, inorganic, n.o.s	8	UN3264	I	8	B10, T14, TP2, TP27	None	201	243	0.5 L	2.5 L	B	40, 53, 58
				II	8	386, B2, IB2, T11, TP2, TP27	154	202	242	1 L	30 L	B	40, 53, 58
				III	8	IB3, T7, TP1, TP28	154	203	241	5 L	60 L	A	40, 53, 58
G	Corrosive liquid, acidic, organic, n.o.s	8	UN3265	I	8	B10, T14, TP2, TP27	None	201	243	0.5 L	2.5 L	B	40, 53, 58
				II	8	148, B2, IB2, T11, TP2, TP27	154	202	242	1 L	30 L	B	40, 53, 58
				III	8	386, IB3, T7, TP1, TP28	154	203	241	5 L	60 L	A	40, 53, 58
G	Corrosive liquid, basic, inorganic, n.o.s	8	UN3266	I	8	T14, TP2, TP27	None	201	243	0.5 L	2.5 L	B	40, 52
				II	8	386, B2, IB2, T11, TP2, TP27	154	202	242	1 L	30 L	B	40, 52
				III	8	IB3, T7, TP1, TP28	154	203	241	5 L	60 L	A	40, 52
G	Corrosive liquid, basic, organic, n.o.s	8	UN3267	I	8	B10, T14, TP2, TP27	None	201	243	0.5 L	2.5 L	B	40, 52
				II	8	B2, IB2, T11, TP2, TP27	154	202	242	1 L	30 L	B	40, 52
				III	8	IB3, T7, TP1, TP28	154	203	241	5 L	60 L	A	40, 52
G	Corrosive liquid, self-heating, n.o.s	8	UN3301	I	8, 4.2	B10	None	201	243	0.5 L	2.5 L	D	
				II	8, 4.2	B2, IB1	154	202	242	1 L	30 L	D	
G	Corrosive liquids, flammable, n.o.s.	8	UN2920	I	8, 3	B10, T14, TP2, TP27	None	201	243	0.5 L	2.5 L	C	25, 40
				II	8, 3	B2, IB2, T11, TP2, TP27	154	202	243	1 L	30 L	C	25, 40
G	Corrosive liquids, n.o.s	8	UN1760	I	8	A7, B10, T14, TP2, TP27	None	201	243	0.5 L	2.5 L	B	40
				II	8	B2, IB2, T11, TP2, TP27	154	202	242	1 L	30 L	B	40
				III	8	IB3, T7, TP1, TP28	154	203	241	5 L	60 L	A	40
G	Corrosive liquids, oxidizing, n.o.s.	8	UN3093	I	8, 5.1	A7	None	201	243	Forbidden	2.5 L	C	89
				II	8, 5.1	A7, IB2	154	202	243	1 L	30 L	C	89
G	Corrosive liquids, toxic, n.o.s	8	UN2922	I	8, 6.1	A7, B10, T14, TP2, TP13, TP27	None	201	243	0.5 L	2.5 L	B	40
				II	8, 6.1	B3, IB2, T7, TP2	154	202	243	1 L	30 L	B	40

§ 172.101 HAZARDOUS MATERIALS TABLE—Continued

Sym-bols	Hazardous materials descriptions and proper shipping names	Hazard class or Division	Identi-fication Numbers	PG	Label Codes	Special provisions (§ 172.102)	(8)			(9)		(10) Vessel stowage	
							Packaging (§ 173.***)			Quantity limitations (see §§ 173.27 and 175.75)		Loca-tion	Other
							Excep-tions	Non-bulk	Bulk	Passenger aircraft/rail	Cargo air-craft only		
(1)	(2)	(3)	(4)	(5)	(6)	(7)	(8A)	(8B)	(8C)	(9A)	(9B)	(10A)	(10B)
G	Corrosive liquids, water-reactive, n.o.s	8	UN3094	III	8, 6.1	IB3, T7, TP1, TP28 A7	154	203	241	5 L	60 L	B	40
				I	8, 4.3		None	201	243	Forbidden	1 L	E	13, 148
G	Corrosive solid, acidic, inorganic, n.o.s	8	UN3260	II	8, 4.3	IB7, IP1, T6, TP33	None	202	243	1 L	5 L	E	13, 148
				I	8		None	211	242	1 kg	25 kg	B	53, 58
G	Corrosive solid, acidic, organic, n.o.s	8	UN3261	II	8	IB8, IP2, IP4, T3, TP33 IB8, IP3, T1, TP33 IB7, IP1, T6, TP33	154	212	240	15 kg	50 kg	B	53, 58
				III	8		154	213	240	25 kg	100 kg	A	53, 58
				I	8		None	211	242	1 kg	25 kg	B	53, 58
G	Corrosive solid, basic, inorganic, n.o.s.	8	UN3262	II	8	IB8, IP2, IP4, T3, TP33 IB8, IP3, T1, TP33	154	212	240	15 kg	50 kg	B	53, 58
				I	8		None	211	242	1 kg	25 kg	B	52
G	Corrosive solid, basic, organic, n.o.s.	8	UN3263	II	8	IB8, IP2, IP4, T3, TP33 IB8, IP3, T1, TP33	154	212	240	15 kg	50 kg	B	52
				I	8		None	211	242	1 kg	25 kg	B	52
G	Corrosive solids, flammable, n.o.s.	8	UN2921	II	8	IB8, IP2, IP4, T3, TP33 IB6, T6, TP33	154	212	240	15 kg	50 kg	B	52
				I	8, 4.1		None	211	242	1 kg	25 kg	B	12, 25
G	Corrosive solids, n.o.s.	8	UN1759	II	8, 4.1	IB8, IP2, IP4, T3, TP33 IB7, IP1, T6, TP33	154	212	242	15 kg	50 kg	B	12, 25
				I	8		None	211	242	1 kg	25 kg	B	
G	Corrosive solids, oxidizing, n.o.s.	8	UN3084	II	8	128, IB8, IP2, IP4, T3, TP33 128, IB8, IP3, T1, TP33	154	212	240	15 kg	50 kg	C	
				I	8, 5.1		None	211	242	1 kg	25 kg	C	
G	Corrosive solids, self-heating, n.o.s	8	UN3095	II	8, 5.1	IB6, IP2, T3, TP33 T6, TP33	154	212	242	15 kg	50 kg	C	
				I	8, 4.2		None	211	243	1 kg	25 kg	C	
G	Corrosive solids, toxic, n.o.s	8	UN2923	II	8, 4.2	IB6, IP2, T3, TP33 IB7, T6, TP33	154	212	242	15 kg	50 kg	C	
				I	8, 6.1		None	211	242	1 kg	25 kg	B	40
G	Corrosive solids, water-reactive, n.o.s	8	UN3096	II	8, 6.1	IB8, IP2, IP4, T3, TP33 IB8, IP3, T1, TP33 IB4, IP1, T6, TP33	154	212	240	15 kg	50 kg	B	40
				III	8, 6.1		154	213	240	25 kg	100 kg	B	40
				I	8, 4.3		None	211	243	1 kg	25 kg	D	13, 148
D W	Cotton	9	NA1365		9	137, IB8, IP2, IP4, W41	None	None	None	No limit	No limit	A	

§ 172.101

49 CFR Ch. I (10-1-23 Edition)

A W	Cotton waste, oily	4.2	UN1364	III	4.2	IB8, IP3, IP7	None	213	None	Forbidden	Forbidden	A	54
A I W	Cotton, wet	4.2	UN1365	III	4.2	IB8, IP3, IP7	None	204	241	Forbidden	Forbidden	A	
	Coumarin derivative pesticides, liquid, flammable, toxic, flash point less than 23 degrees C	3	UN3024	I	3, 6.1	T14, TP2, TP13, TP27	None	201	243	Forbidden	Forbidden 30 L	B	40
				II	3, 6.1	IB2, T11, TP2, TP13, TP27	150	202	243	1 L	60 L	B	40
	Coumarin derivative pesticides, liquid, toxic	6.1	UN3026	I	6.1	T14, TP2, TP13, TP27	None	201	243	1 L	30 L	B	40
				II	6.1	IB2, T11, TP2, TP27	153	202	243	5 L	60 L	B	40
				III	6.1	IB3, T7, TP1, TP28	153	203	241	60 L	220 L	A	40
	Coumarin derivative pesticides, liquid, toxic, flammable, flash point not less than 23 degrees C	6.1	UN3025	I	6.1, 3	T14, TP2, TP13, TP27	None	201	243	1 L	30 L	B	40
				II	6.1, 3	IB2, T11, TP2, TP13, TP27	153	202	243	5 L	60 L	B	40
				III	6.1, 3	B1, IB3, T7, TP1, TP28	153	203	242	60 L	220 L	A	40
	Coumarin derivative pesticides, solid, toxic	6.1	UN3027	I	6.1	IB7, IP1, T6, TP33	None	211	242	5 kg	50 kg	A	40
				II	6.1	IB8, IP2, IP4, T3, TP33	153	212	242	25 kg	100 kg	A	40
				III	6.1	IB8, IP3, T1, TP33	153	213	240	100 kg	200 kg	A	40
	Cresols, liquid	6.1	UN2076	II	6.1, 8	IB2, IP2, IP4, T7, TP2	153	202	243	1 L	30 L	B	
	Cresols, solid	6.1	UN3455	II	6.1, 8	IB8, IP2, IP4, T3, TP33	153	212	242	15 kg	50 kg	B	
	Cresylic acid	6.1	UN2022	II	6.1, 8	IB2, T7, TP2, TP13	153	202	243	1 L	30 L	B	
	Crotonaldehyde or Crotonaldehyde, stabilized	6.1	UN1143	I	6.1, 3	2, 175, 387, B9, B14, B32, B77, T20, TP2, TP13, TP38, TP45	None	227	244	Forbidden	Forbidden	D	25, 40
	Crotonic acid, liquid	8	UN3472	III	8	IB8, T1	154	203	241	5 L	60 L	A	12, 25, 53, 58
	Crotonic acid, solid	8	UN2823	III	8	IB8, IP3, T1, TP33	154	213	240	25 kg	100 kg	A	12, 25, 53, 58
	Crotonylene	3	UN1144	I	3	T11, TP2	150	201	243	1 L	30 L	E	
	Cupriethylenediamine solution	8	UN1761	II	8, 6.1	IB2, T7, TP2	154	202	243	1 L	30 L	A	52
				III	8, 6.1	IB3, T7, TP1, TP28	154	203	242	5 L	60 L	A	52, 95
	Cutters, cable, explosive Cyanide or cyanide mixtures, dry, see Cyanides, inorganic, solid, n.o.s.	1.4S	UN0070	1.4S	None	62	62	25 kg	100 kg	01	25
G	Cyanide solutions, n.o.s.	6.1	UN1935	I	6.1	T14, TP2, TP13, TP27	None	201	243	1 L	30 L	B	40, 52
				II	6.1	IB2, T11, TP2, TP13, TP27	153	202	243	5 L	60 L	A	40, 52
				III	6.1	IB3, T7, TP2, TP13, TP28	153	203	241	60 L	220 L	A	40, 52
	Cyanides, inorganic, solid, n.o.s.	6.1	UN1588	I	6.1	IB7, IP1, N74, N75, T6, TP33	None	211	242	5 kg	50 kg	A	52
				II	6.1	IB8, IP2, IP4, N74, N75, T3, TP33	153	212	242	25 kg	100 kg	A	52
				III	6.1	IB8, IP3, N74, N75, T1, TP33	153	213	240	100 kg	200 kg	A	52

§ 172.101 HAZARDOUS MATERIALS TABLE—Continued

Sym-bols (1)	Hazardous materials descriptions and proper shipping names (2)	Hazard class or Division (3)	Identi-fication Numbers (4)	PG (5)	Label Codes (6)	Special provisions (§ 172.102) (7)	(8)			(9)		(10) Vessel stowage	
							Packaging (§ 173.***)			Quantity limitations (see §§ 173.27 and 175.75)		Loca-tion (10A)	Other (10B)
							Excep-tions (8A)	Non-bulk (8B)	Bulk (8C)	Passenger aircraft/rail (9A)	Cargo air-craft only (9B)		
	Cyanogen	2.3	UN1026		2.3, 2.1	2	None	304	245	Forbidden	Forbidden	D	40
	Cyanogen bromide	6.1	UN1889	I	6.1, 8	A6, A8, T6, TP33, W31	None	211	242	1 kg	15 kg	D	40, 52
	Cyanogen chloride, stabilized	2.3	UN1589	2.3, 8	1, 387	None	192	245	Forbidden	Forbidden	D	25, 40
	Cyanuric chloride	8	UN2670	II	8	IB8, IP2, IP4, T3, TP33	None	212	240	15 kg	50 kg	A	12, 25, 40, 53, 58
	<i>Cyanuric triazide</i>	Forbidden											
	Cyclobutane	2.1	UN2601		2.1		306	304	314, 315	Forbidden	150 kg	B	40
	Cyclobutyl chloroformate	6.1	UN2744	II	6.1, 8, 3	IB1, T7, TP2, TP13	153	202	243	1 L	30 L	A	12, 13, 21, 25, 40, 53, 58, 100
	1,5,9-Cyclododecatriene	6.1	UN2518	III	6.1	IB3, T4, TP1	153	203	241	60 L	220 L	A	40
	Cycloheptane	3	UN2241	II	3	IB2, T4, TP2	150	202	242	5 L	60 L	B	40
	Cycloheptatriene	3	UN2603	II	3, 6.1	IB2, T7, TP1, TP13	150	202	243	1 L	60 L	E	40
	Cycloheptene	3	UN2242	II	3	B1, IB2, T4, TP1	150	202	242	5 L	60 L	B	
	Cyclohexane	3	UN1145	II	3	IB2, T4, TP1	150	202	242	5 L	60 L	E	
	Cyclohexanone	3	UN1915	III	3	B1, IB3, T2, TP1	150	203	242	60 L	220 L	A	
	Cyclohexene	3	UN2256	II	3	IB2, T4, TP1	150	202	242	5 L	60 L	E	
	Cyclohexenyltrichlorosilane	8	UN1762	II	8	A7, B2, N34, T10, TP2, TP7, TP13	None	206	242	Forbidden	30 L	C	40, 53, 58
	Cyclohexyl acetate	3	UN2243	III	3	B1, IB3, T2, TP1	150	203	242	60 L	220 L	A	
	Cyclohexyl isocyanate	6.1	UN2488	I	6.1, 3	2, B9, B14, B32, B77, T20, TP2, TP13, TP38, TP45	None	227	244	Forbidden	Forbidden	D	40
	Cyclohexyl mercaptan	3	UN3054	III	3	B1, IB3, T2, TP1	150	203	242	60 L	220 L	A	40, 95, 102
	Cyclohexylamine	8	UN2357	II	8, 3	IB2, T7, TP2	154	202	243	1 L	30 L	A	40, 52
	Cyclohexyltrichlorosilane	8	UN1763	II	8	A7, B2, N34, T10, TP2, TP7, TP13	None	206	242	Forbidden	30 L	C	40, 53, 58
	Cyclonite and cyclotetramethylenetetranitramine mixtures, wetted or desensitized see RDX and HMX mixtures, wetted or desensitized etc												

§ 172.101

49 CFR Ch. I (10-1-23 Edition)

Cyclonite and HMX mixtures, wetted or desensitized <i>see</i> RDX and HMX mixtures, wetted or desensitized <i>etc</i>												
Cyclonite and octogen mixtures, wetted or desensitized <i>see</i> RDX and HMX mixtures, wetted or desensitized <i>etc</i>												
Cyclonite, <i>see</i> Cyclotrimethylenetrinitramine, <i>etc</i>												
Cyclooctadiene phosphines, <i>see</i> 9-Phosphabicyclononanes												
Cyclooctadienes	3	UN2520	III	3	B1, IB3, T2, TP1	150	203	242	60 L	220 L	A	
Cyclooctatetraene	3	UN2358	II	3	IB2, T4, TP1	150	202	242	5 L	60 L	B	
Cyclopentane	3	UN1146	II	3	IB2, T7, TP1	150	202	242	5 L	60 L	E	
<i>Cyclopentane, methyl, see</i> Methylcyclopentane												
Cyclopentanol	3	UN2244	III	3	B1, IB3, T2, TP1	150	203	242	60 L	220 L	A	
Cyclopentanone	3	UN2245	III	3	B1, IB3, T2, TP1	150	203	242	60 L	220 L	A	
Cyclopentene	3	UN2246	II	3	IB2, IP8, T7, TP2	150	202	242	5 L	60 L	E	
Cyclopropane	2.1	UN1027		2.1	T50	306	304	314, 315	Forbidden	150 kg	E	40
<i>Cyclotetramethylene tetranitramine (dry or unphlegmatized) (HMX)</i>	Forbidden											
Cyclotetramethylenetetranitramine, desensitized or Octogen, desensitized or HMX, desensitized	1.1D	UN0484	1.1D	None	62	None	Forbidden	Forbidden	04	25
Cyclotetramethylenetetranitramine, wetted or HMX, wetted or Octogen, wetted with not less than 15 percent water, by mass	1.1D	UN0226	1.1D	None	62	None	Forbidden	Forbidden	04	25
Cyclotrimethylenetrinitramine and octogen, mixtures, wetted or desensitized <i>see</i> RDX and HMX mixtures, wetted or desensitized, <i>etc</i>												
Cyclotrimethylenetrinitramine and cyclotetramethylenetetranitramine mixtures, wetted or desensitized <i>see</i> RDX and HMX mixtures, wetted or desensitized <i>etc</i>												
Cyclotrimethylenetrinitramine and HMX mixtures, wetted or desensitized <i>see</i> RDX and HMX mixtures, wetted or desensitized <i>etc</i>												
Cyclotrimethylenetrinitramine, desensitized or Cyclonite, desensitized or Hexogen, desensitized or RDX, desensitized	1.1D	UN0483	1.1D	None	62	None	Forbidden	Forbidden	04	25

§ 172.101 HAZARDOUS MATERIALS TABLE—Continued

Sym-bols (1)	Hazardous materials descriptions and proper shipping names (2)	Hazard class or Division (3)	Identi-fication Numbers (4)	PG (5)	Label Codes (6)	Special provisions (§ 172.102) (7)	(8)			(9)		(10) Vessel stowage	
							Packaging (§ 173.***)			Quantity limitations (see §§ 173.27 and 175.75)		Loca-tion (10A)	Other (10B)
							Excep-tions (8A)	Non-bulk (8B)	Bulk (8C)	Passenger aircraft/rail (9A)	Cargo air-craft only (9B)		
	Cyclotrimethylenetrinitramine, wetted or Cyclonite, wetted or Hexogen, wetted or RDX, wetted with not less than 15 percent water by mass	1.1D	UN0072	1.1D	None	62	None	Forbidden	Forbidden	04	25
	Cymenes	3	UN2046	III	3	B1, IB3, T2, TP1	150	203	242	60 L	220 L	A	
	Dangerous goods in articles or Dangerous goods in machinery or Dangerous goods in apparatus	9	UN3363	9	136, A105	None	222	None	See A105	See A105	A	
	Decaborane	4.1	UN1868	II	4.1, 6.1	A19, A20, IB6, IP2, T3, TP33, W31	151	212	None	Forbidden	50 kg	A	74
	Decahydronaphthalene	3	UN1147	III	3	B1, IB3, T2, TP1	150	203	242	60 L	220 L	A	
	n-Decane	3	UN2247	III	3	B1, IB3, T2, TP1	150	203	242	60 L	220 L	A	
	Deflagrating metal salts of aromatic nitroderivatives, n.o.s.	1.3C	UN0132	1.3C	None	62	None	Forbidden	Forbidden	04	25, 5E
	<i>Delay electric igniter, see Igniters</i>												
D	Denatured alcohol	3	NA1987	II III	3 3	172, T8 172, B1, T7	150 150	202 203	242 242	5 L 60 L	60 L 220 L	B A	
	<i>Depth charges, see Charges, depth</i>												
G	Desensitized explosive, liquid, n.o.s.	3	UN3379	I	3	164	None	201	None	Forbidden	Forbidden	D	36
G	Desensitized explosives, solid, n.o.s.	4.1	UN3380	I	4.1	164, 197	None	211	None	Forbidden	Forbidden	D	28, 36
	<i>Detonating relays, see Detonators, etc</i>												
	Detonator assemblies, non-electric for blasting	1.1B	UN0360	1.1B	None	62	None	Forbidden	Forbidden	05	25
	Detonator assemblies, non-electric, for blasting	1.4B	UN0361	1.4B	148	63(f), 63(g)	62	None	Forbidden	75 kg	05	25
	Detonator assemblies, non-electric, for blasting	1.4S	UN0500	1.4S	148, 347	63(f), 63(g)	62	None	25 kg	100 kg	01	25
	Detonators, electric, for blasting	1.1B	UN0030	1.1B	148	63(f), 63(g)	62	None	Forbidden	Forbidden	05	25
	Detonators, electric, for blasting	1.4B	UN0255	1.4B	148	63(f), 63(g)	62	None	Forbidden	75 kg	05	25
	Detonators, electric for blasting	1.4S	UN0456	1.4S	148, 347	63(f), 63(g)	62	None	25 kg	100 kg	01	25

§ 172.101

49 CFR Ch. I (10-1-23 Edition)

Detonators, electronic <i>programmable for blasting</i>	1.1B	UN0511	1.1B		148	63(f), 63(g)	62	None	Forbidden	Forbidden	05	25
Detonators, electronic <i>programmable for blasting</i>	1.4B	UN0512	1.4B		103	63(f), 63(g)	62	None	Forbidden	75 kg	05	25
Detonators, electronic <i>programmable for blasting</i>	1.4S	UN0513	1.4S		148, 347	63(f), 63(g)	62	None	25 kg	100 kg	01	25
Detonators for ammunition	1.1B	UN0073	1.1B		None	62	None	Forbidden	Forbidden	05	25
Detonators for ammunition	1.2B	UN0364	1.2B		None	62	None	Forbidden	Forbidden	05	25
Detonators for ammunition	1.4B	UN0365	1.4B		None	62	None	Forbidden	75 kg	05	25
Detonators for ammunition	1.4S	UN0366	1.4S	347	None	62	None	25 kg	100 kg	01	25
Detonators, non-electric, <i>for blasting</i>	1.1B	UN0029	1.1B		None	62	None	Forbidden	Forbidden	05	25
Detonators, non-electric, <i>for blasting</i>	1.4B	UN0267	1.4B		63(f), 63(g)	62	None	Forbidden	75 kg	05	25
Detonators, non-electric, <i>for blasting</i>	1.4S	UN0455	1.4S	148, 347	63(f), 63(g)	62	None	25 kg	100 kg	01	25
Deuterium, compressed	2.1	UN1957		2.1		N89	306	302	None	Forbidden	150 kg	E	40
Devices, small, hydrocarbon gas powered or Hydrocarbon gas re-fills for small devices with release device	2.1	UN3150		2.1			306	304	None	1 kg	15 kg	B	40
Di-n-amyamine	3	UN2841	III	3, 6.1		B1, IB3, T4, TP1	150	203	242	60 L	220 L	A	52
<i>Di-n-butyl peroxydicarbonate, with more than 52 percent in solution</i>	Forbidden												
Di-n-butylamine	8	UN2248	II	8, 3		IB2, T7, TP2	154	202	243	1 L	30 L	A	52
<i>2,2-Di-(tert-butylperoxy) butane, with more than 55 percent in solution</i>	Forbidden												
<i>Di-(tert-butylperoxy) phthalate, with more than 55 percent in solution</i>	Forbidden												
<i>2,2-Di-(4,4-di-tert-butylperoxycyclohexyl) propane, with more than 42 percent with inert solid</i>	Forbidden												
<i>Di-2,4-dichlorobenzoyl peroxide, with more than 75 percent with water</i>	Forbidden												
1,2-Di-(dimethylamino)ethane	3	UN2372	II	3		IB2, T4, TP1	150	202	242	5 L	60 L	B	
<i>Di-2-ethylhexyl phosphoric acid, see Diisooctyl acid phosphate</i>													
<i>Di-(1-hydroxytetrazole) (dry)</i>	Forbidden												
<i>Di-(1-naphthoyl) peroxide</i>	Forbidden												
<i>a,a'-Di-(nitroxy) methyl ether</i>	Forbidden												
<i>Di-(beta-nitroxyethyl) ammonium nitrate</i>	Forbidden												
Diacetone alcohol	3	UN1148	II III	3 3		IB2, T4, TP1 B1, IB3, T2, TP1	150 150	202 203	242 242	5 L 60 L	60 L 220 L	B A	

§ 172.101 HAZARDOUS MATERIALS TABLE—Continued

Sym-bols	Hazardous materials descriptions and proper shipping names	Hazard class or Division	Identi-fication Numbers	PG	Label Codes	Special provisions (§ 172.102)	(8)			(9)		(10) Vessel stowage	
							Packaging (§ 173.***)			Quantity limitations (see §§ 173.27 and 175.75)		Loca-tion	Other
							Excep-tions	Non-bulk	Bulk	Passenger aircraft/rail	Cargo air-craft only		
(1)	(2)	(3)	(4)	(5)	(6)	(7)	(8A)	(8B)	(8C)	(9A)	(9B)	(10A)	(10B)
D	<i>Diacetone alcohol peroxides, with more than 57 percent in solution with more than 9 percent hydrogen peroxide, less than 26 percent diacetone alcohol and less than 9 percent water; total active oxygen content more than 9 percent by mass</i>	Forbidden											
	<i>Diacetyl, see Butanedione</i>	Forbidden											
	<i>Diacetyl peroxide, solid, or with more than 25 percent in solution</i>	3	UN2359	II	3, 6.1, 8	IB2, T7, TP1	150	202	243	1 L	5 L	B	21, 40, 52, 100
	<i>Diallylamine</i>	3	UN2360	II	3, 6.1	IB2, N12, T7, TP1, TP13	150	202	243	1 L	60 L	E	40
	<i>Diallylether</i>	6.1	UN2651	III	6.1	IB8, IP3, T1, TP33	153	213	240	100 kg	200 kg	A	
	<i>4,4'-Diaminodiphenyl methane</i>	Forbidden											
	<i>p-Diazidobenzene</i>	Forbidden											
	<i>1,2-Diazoethane</i>	Forbidden											
	<i>1,1'-Diazoaminonaphthalene</i>	Forbidden											
	<i>Diazoaminotetrazole (dry)</i>	Forbidden											
	<i>Diazodinitrophenol (dry)</i>	Forbidden											
	<i>Diazodinitrophenol, wetted with not less than 40 percent water or mixture of alcohol and water, by mass</i>	1.1A	UN0074	1.1A	111, 117	None	62	None	Forbidden	Forbidden	05	25
<i>Diazodiphenylmethane</i>	Forbidden												
<i>Diazonium nitrates (dry)</i>	Forbidden												
<i>Diazonium perchlorates (dry)</i>	Forbidden												
<i>1,3-Diazopropane</i>	Forbidden												
<i>Dibenzyl peroxydicarbonate, with more than 87 percent with water</i>	Forbidden												
<i>Dibenzylchlorosilane</i>	8	UN2434	II	8	B2, T10, TP2, TP7, TP13	154	206	242	Forbidden	30 L	C	40, 53, 58	
<i>Diborane</i>	2.3	UN1911		2.3, 2.1	1, N89	None	302	None	Forbidden	Forbidden	D	40, 57	
<i>Diborane mixtures</i>	2.1	NA1911		2.1	5	None	302	245	Forbidden	Forbidden	D	40, 57	
<i>Dibromoacetylene</i>	Forbidden												
<i>1,2-Dibromobutan-3-one</i>	6.1	UN2648	II	6.1	IB2	153	202	243	5 L	60 L	B	40	
<i>Dibromochloropropane</i>	6.1	UN2872	II	6.1	IB2, T7, TP2	153	202	243	5 L	60 L	A		

§ 172.101

49 CFR Ch. I (10-1-23 Edition)

A	Dibromodifluoromethane, R12B2 1,2-Dibromoethane, see Ethylene dibromide	9	UN1941	III	6.1	IB3, T4, TP1	153	203	241	60 L	220 L	A	25
				III	None	T11, TP2	155	203	241	100 L	220 L	A	
D	Dibromomethane	6.1	UN2664	III	6.1	IB3, T4, TP1	153	203	241	60 L	220 L	A	12, 25, 40, 74, 40
	Dibutyl ethers	3	UN1149	III	3	B1, IB3, T2, TP1	150	203	242	60 L	220 L	A	
	Dibutylaminoethanol	6.1	UN2873	III	6.1	IB3, T4, TP1	153	203	241	60 L	220 L	A	
	<i>N,N</i> -Dichlorozodocarbonamidine (salts of) (dry)	Forbidden											
	1,1-Dichloro-1-nitroethane	6.1	UN2650	II	6.1	IB2, T7, TP2	153	202	243	5 L	60 L	A	
	3,5-Dichloro-2,4,6-trifluoropyridine	6.1	NA9264	I	6.1	2, B9, B14, B32, T20, TP4, TP13, TP38, TP45	None	227	244	Forbidden	Forbidden	A	
	Dichloroacetic acid	8	UN1764	II	8	A3, A7, B2, IB2, N34, T8, TP2	154	202	242	1 L	30 L	A	
	1,3-Dichloroacetone	6.1	UN2649	II	6.1	IB8, IP2, IP4, T3, TP33	153	212	242	25 kg	100 kg	B	
	Dichloroacetyl chloride	8	UN1765	II	8	A3, A7, B2, B6, IB2, N34, T7, TP2	154	202	242	1 L	30 L	D	
	<i>Dichloroacetylene</i>	Forbidden											
+	Dichloroanilines, liquid	6.1	UN1590	II	6.1	IB2, T7, TP2	153	202	243	5 L	60 L	A	40
	Dichloroanilines, solid	6.1	UN3442	II	6.1	IB8, IP2, IP4, T3, TP33	153	212	242	25 kg	100 kg	A	40
+	<i>o</i> -Dichlorobenzene	6.1	UN1591	III	6.1	IB3, T4, TP1	153	203	241	60 L	220 L	A	40
	2,2'-Dichlorodiethyl ether	6.1	UN1916	II	6.1, 3	IB2, N33, N34, T7, TP2	153	202	243	5 L	60 L	A	
	Dichlorodifluoromethane and difluoroethane azeotropic mixture or Refrigerant gas R 500 with approximately 74 percent dichlorodifluoromethane	2.2	UN2602	II	2.2	T50	306	304	314, 315	75 kg	150 kg	A	
	Dichlorodifluoromethane or Refrigerant gas R 12	2.2	UN1028		2.2	T50	306	304	314, 315	75 kg	150 kg	A	
	Dichlorodimethyl ether, symmetrical	6.1	UN2249	I	6.1, 3		None	201	243	Forbidden	Forbidden	B	40
	1,1-Dichloroethane	3	UN2362	II	3	IB2, T4, TP1	150	202	242	5 L	60 L	B	40
	1,2-Dichloroethane, see Ethylene dichloride	Forbidden											
	<i>Dichloroethyl sulfide</i>	Forbidden											
	1,2-Dichloroethylene	3	UN1150	II	3	IB2, T7, TP2	150	202	242	5 L	60 L	B	13
	Dichlorofluoromethane or Refrigerant gas R21	2.2	UN1029		2.2	T50	306	304	314, 315	75 kg	150 kg	A	
	Dichloroisocyanuric acid, dry or Dichloroisocyanuric acid salts	5.1	UN2465	II	5.1	28, IB8, IP2, IP4, T3, TP33	152	212	240	5 kg	25 kg	A	
	Dichloroisopropyl ether	6.1	UN2490	II	6.1	IB2, T7, TP2	153	202	243	5 L	60 L	B	25, 40
	Dichloromethane	6.1	UN1593	III	6.1	IB3, IP8, N36, T7, TP2	153	203	241	60 L	220 L	A	
	Dichloropentanes	3	UN1152	III	3	B1, IB3, T2, TP1	150	203	242	60 L	220 L	A	
	Dichlorophenyl isocyanates	6.1	UN2250	II	6.1	IB8, IP2, IP4, T3, TP33	153	212	242	25 kg	100 kg	B	
	Dichlorophenyltrichlorosilane	8	UN1766	II	8	IB2, N36, T4, TP1	None	206	242	Forbidden	30 L	C	40, 53, 58
	1,2-Dichloropropane	3	UN1279	II	3	IB2, N36, T4, TP1	150	202	242	5 L	60 L	B	12, 25, 40
	1,3-Dichloropropanol-2	6.1	UN2750	II	6.1	IB2, T7, TP2	153	202	243	5 L	60 L	A	

§ 172.101 HAZARDOUS MATERIALS TABLE—Continued

Sym-bols	Hazardous materials descriptions and proper shipping names	Hazard class or Division	Identi-fication Numbers	PG	Label Codes	Special provisions (§ 172.102)	(8)			(9)		(10) Vessel stowage	
							Packaging (§ 173.***)			Quantity limitations (see §§ 173.27 and 175.75)		Loca-tion	Other
							Excep-tions	Non-bulk	Bulk	Passenger aircraft/rail	Cargo air-craft only		
(1)	(2)	(3)	(4)	(5)	(6)	(7)	(8A)	(8B)	(8C)	(9A)	(9B)	(10A)	(10B)
	<i>Dichloropropene and propylene di-chloride mixture, see 1,2-Dichloropropane</i>	3	UN2047	II	3	IB2, T4, TP1	150	202	242	5 L	60 L	B	
	Dichloropropenes			III	3	B1, IB3, T2, TP1	150	203	242	60 L	220 L	A	
	Dichlorosilane	2.3	UN2189		2.3, 2.1, 8	2, B9, B14	None	304	314, 315	Forbidden	Forbidden	D	17, 40
	1,2-Dichloro-1,1,2,2-tetrafluoroethane or Refrigerant gas R 114	2.2	UN1958		2.2	T50	306	304	314, 315	75 kg	150 kg	A	
	<i>Dichlorovinylchloroarsine</i>	Forbidden											
	<i>Dicycloheptadiene, see Bicyclo [2,2,1] hepta-2,5-diene, stabilized</i>												
	Dicyclohexylamine	8	UN2565	III	8	IB3, T4, TP1	154	203	241	5 L	60 L	A	52
	Dicyclohexylammonium nitrite	4.1	UN2687	III	4.1	IB8, IP3, T1, TP33	151	213	240	25 kg	100 kg	A	25
	Dicyclopentadiene	3	UN2048	III	3	B1, IB3, T2, TP1	150	203	242	60 L	220 L	A	
	Didymium nitrate	5.1	UN1465	III	5.1	A1, IB8, IP3, T1, TP33	152	213	240	25 kg	100 kg	A	
D	Diesel fuel	3	NA1993	III	None	144, B1, IB3, T4, TP1, TP29	150	203	242	60 L	220 L	A	
I	Diesel fuel	3	UN1202	III	3	144, B1, IB3, T2, TP1	150	203	242	60 L	220 L	A	
	<i>Diethanol nitrosamine dinitrate (dry)</i>	Forbidden											
	Diethoxymethane	3	UN2373	II	3	IB2, T4, TP1	150	202	242	5 L	60 L	E	
	3,3-Diethoxypropene	3	UN2374	II	3	IB2, T4, TP1	150	202	242	5 L	60 L	B	
	Diethyl carbonate	3	UN2366	III	3	B1, IB3, T2, TP1	150	203	242	60 L	220 L	A	
	<i>Diethyl cellosolve, see Ethylene glycol diethyl ether</i>												
	Diethyl ether or Ethyl ether	3	UN1155	I	3	T11, TP2	150	201	243	1 L	30 L	E	40
	Diethyl ketone	3	UN1156	II	3	IB2, T4, TP1	150	202	242	5 L	60 L	B	
	<i>Diethyl peroxydicarbonate, with more than 27 percent in solution</i>	Forbidden											
	Diethyl sulfate	6.1	UN1594	II	6.1	IB2, T7, TP2	153	202	243	5 L	60 L	C	
	Diethyl sulfide	3	UN2375	II	3	IB2, T7, TP1, TP13	150	202	243	5 L	60 L	E	
	Diethylamine	3	UN1154	II	3, 8	A3, IB2, N34, T7, TP1	150	202	243	1 L	5 L	E	40, 52
	2-Diethylaminoethanol	8	UN2686	II	8, 3	B2, IB2, T7, TP2	154	202	243	1 L	30 L	A	52
	3-Diethylamino-propylamine	3	UN2684	III	3, 8	B1, IB3, T4, TP1	150	203	242	5 L	60 L	A	52
+	N, N-Diethylaniline	6.1	UN2432	III	6.1	IB3, T4, TP1	153	203	241	60 L	220 L	A	
	Diethylbenzene	3	UN2049	III	3	B1, IB3, T2, TP1	150	203	242	60 L	220 L	A	

§ 172.101

49 CFR Ch. I (10-1-23 Edition)

Diethylchlorosilane	8	UN1767	II	8, 3	A7, B6, N34, T10, TP2, TP7, TP13	None	206	243	Forbidden	30 L	C	40, 53, 58
<i>Diethylene glycol dinitrate</i>	Forbidden											
Diethyleneglycol dinitrate, desensitized with not less than 25 percent non-volatile water-insoluble phlegmatizer, by mass	1.1D	UN0075	1.1D	None	62	None	Forbidden	Forbidden	04	25, 21E
Diethylenetriamine	8	UN2079	II	8	B2, IB2, T7, TP2	154	202	242	1 L	30 L	A	40, 52
N,N-Diethylethylenediamine	8	UN2685	II	8, 3	IB2, T7, TP2	154	202	243	1 L	30 L	A	52
<i>Diethylgold bromide</i>	Forbidden											
Diethylthiophosphoryl chloride	8	UN2751	II	8	B2, IB2, T7, TP2	154	212	240	15 kg	50 kg	D	12, 25, 40, 53, 58
<i>Difluorochloroethanes, see 1-Chloro-1,1-difluoroethanes</i>												
1,1-Difluoroethane or Refrigerant gas R 152a	2.1	UN1030		2.1	T50	306	304	314, 315	Forbidden	150 kg	B	40
1,1-Difluoroethylene or Refrigerant gas R 1132a	2.1	UN1959		2.1		306	304	None	Forbidden	150 kg	E	40
Difluoromethane or Refrigerant gas R 32	2.1	UN3252	2.1	T50	306	304	314, 315	Forbidden	150 kg	D	40
Difluorophosphoric acid, anhydrous	8	UN1768	II	8	A7, B2, IB2, N5, N34, T8, TP2	154	202	242	1 L	30 L	A	40, 53, 58
2,3-Dihydropyran	3	UN2376	II	3	IB2, T4, TP1	150	202	242	5 L	60 L	B	
<i>1,8-Dihydroxy-2,4,5,7-tetranitroanthraquinone (chrysamminic acid)</i>	Forbidden											
<i>Diiodoacetylene</i>	Forbidden											
Diisobutyl ketone	3	UN1157	III	3	B1, IB3, T2, TP1	150	203	242	60 L	220 L	A	
Diisobutylamine	3	UN2361	III	3, 8	B1, IB3, T4, TP1	150	203	242	5 L	60 L	A	52
Diisobutylene, isomeric compounds	3	UN2050	II	3	IB2, T4, TP1	150	202	242	5 L	60 L	B	
Diisooctyl acid phosphate	8	UN1902	III	8	IB3, T4, TP1	154	203	241	5 L	60 L	A	53, 58
Diisopropyl ether	3	UN1159	II	3	IB2, T4, TP1	150	202	242	5 L	60 L	E	40
Diisopropylamine	3	UN1158	II	3, 8	IB2, T7, TP1	150	202	243	1 L	5 L	B	52
<i>Diisopropylbenzene hydroperoxide, with more than 72 percent in solution</i>	Forbidden											
Diketene, stabilized	6.1	UN2521	I	6.1, 3	2, 387, B9, B14, B32, T20, TP2, TP13, TP38, TP45	None	227	244	Forbidden	Forbidden	D	25, 26, 27, 40
1,2-Dimethoxyethane	3	UN2252	II	3	IB2, T4, TP1	150	202	242	5 L	60 L	B	
1,1-Dimethoxyethane	3	UN2377	II	3	IB2, T7, TP1	150	202	242	5 L	60 L	B	
Dimethyl carbonate	3	UN1161	II	3	IB2, T4, TP1	150	202	242	5 L	60 L	B	
<i>Dimethyl chlorothiophosphate, see Dimethyl thiophosphoryl chloride</i>												
<i>2,5-Dimethyl-2,5-dihydroperoxy hexane, with more than 82 percent with water</i>	Forbidden											
Dimethyl disulfide	3	UN2381	II	3, 6.1	IB2, T7, TP2, TP13	150	202	242	Forbidden	Forbidden	B	40

§ 172.101 HAZARDOUS MATERIALS TABLE—Continued

Sym-bols (1)	Hazardous materials descriptions and proper shipping names (2)	Hazard class or Division (3)	Identi-fication Numbers (4)	PG (5)	Label Codes (6)	Special provisions (§ 172.102) (7)	(8)			(9)		(10) Vessel stowage	
							Packaging (§ 173.***)			Quantity limitations (see §§ 173.27 and 175.75)		Loca-tion (10A)	Other (10B)
							Excep-tions (8A)	Non-bulk (8B)	Bulk (8C)	Passenger aircraft/rail (9A)	Cargo air-craft only (9B)		
	Dimethyl ether	2.1	UN1033		2.1	T50	306	304	314, 315	Forbidden	150 kg	B	40
	Dimethyl-N-propylamine	3	UN2266	II	3, 8	IB2, T7, TP2, TP13	150	202	243	1 L	5 L	B	40, 52
	Dimethyl sulfate	6.1	UN1595	I	6.1, 8	2, B9, B14, B32, B77, T20, TP2, TP13, TP38, TP45	None	227	244	Forbidden	Forbidden	D	40, 53, 58
	Dimethyl sulfide	3	UN1164	II	3	IB2, IP8, T7, TP2	150	202	242	5 L	60 L	E	40
	Dimethyl thiophosphoryl chloride	6.1	UN2267	II	6.1, 8	IB2, T7, TP2	153	202	243	1 L	30 L	B	25, 53, 58
	Dimethylamine, anhydrous	2.1	UN1032	2.1	N87, T50	None	304	314, 315	Forbidden	150 kg	D	40, 52
	Dimethylamine solution	3	UN1160	II	3, 8	IB2, T7, TP1	150	202	243	1 L	5 L	B	52.
	2-Dimethylaminoacetonitrile	3	UN2378	II	3, 6.1	IB2, T7, TP1	150	202	243	1 L	60 L	A	40, 52
	2-Dimethylaminoethanol	8	UN2051	II	8, 3	B2, IB2, T7, TP2	154	202	243	1 L	30 L	A	52
	2-Dimethylaminoethyl acrylate, stabilized	6.1	UN3302	II	6.1	387, IB2, T7, TP2	153	202	243	5 L	60 L	D	25
	2-Dimethylaminoethyl methacrylate, stabilized	6.1	UN2522	II	6.1	387, IB2, T7, TP2	153	202	243	5 L	60 L	B	40
	N,N-Dimethylaniline	6.1	UN2253	II	6.1	IB1, T7, TP2	153	202	243	5 L	60 L	A	
	2,3-Dimethylbutane	3	UN2457	II	3	IB2, T7, TP1	150	202	242	5 L	60 L	E	
	1, 3-Dimethylbutylamine	3	UN2379	II	3, 8	IB2, T7, TP1	150	202	243	1 L	5 L	B	52.
	Dimethylcarbonyl chloride	8	UN2262	II	8	B2, IB2, T7, TP2	154	202	242	1 L	30 L	A	40, 53, 58
	Dimethylcyclohexanes	3	UN2263	II	3	IB2, T4, TP1	150	202	242	5 L	60 L	B	
	N,N-Dimethylcyclohexylamine	8	UN2264	II	8, 3	B2, IB2, T7, TP2	154	202	243	1 L	30 L	A	40, 52
	Dimethyldichlorosilane	3	UN1162	II	3, 8	B77, T10, TP2, TP7, TP13	None	206	243	Forbidden	Forbidden	B	40
	Dimethyldiethoxysilane	3	UN2380	II	3	IB2, T4, TP1	150	202	242	5 L	60 L	B	
	Dimethyldioxanes	3	UN2707	II	3	IB2, T4, TP1	150	202	242	5 L	60 L	B	
				III	3	B1, IB3, T2, TP1	150	203	242	60 L	220 L	A	
	N,N-Dimethylformamide	3	UN2265	III	3	B1, IB3, T2, TP2	150	203	242	60 L	220 L	A	
	<i>Dimethylhexane dihydroperoxide (dry)</i>	Forbidden											
	Dimethylhydrazine, symmetrical	6.1	UN2382	I	6.1, 3	2, B9, B14, B32, B77, T20, TP2, TP13, TP38, TP45	None	227	244	Forbidden	Forbidden	D	40, 52, 74.

§ 172.101

49 CFR Ch. I (10-1-23 Edition)

Dimethylhydrazine, unsymmetrical	6.1	UN1163	I	6.1, 3, 8	2, B7, B9, B14, B32, T20, TP2, TP13, TP38, TP45	None	227	244	Forbidden	Forbidden	D	21, 38, 40, 52, 100, 40
2,2-Dimethylpropane	2.1	UN2044		2.1		306	304	314, 315	Forbidden	150 kg	E	
Dinitro-o-cresol	6.1	UN1598	II	6.1	IB8, IP2, IP4, T3, TP33	153	212	242	25 kg	100 kg	A	
1,3-Dinitro-5,5-dimethyl hydantoin	Forbidden											
Dinitro-7,8-dimethylglycoluril (dry)	Forbidden											
1,3-Dinitro-4,5-dinitrosobenzene	Forbidden											
1,4-Dinitro-1,1,4,4-tetramethylolbutanetetrinitrate (dry)	Forbidden											
2,4-Dinitro-1,3,5-trimethylbenzene	Forbidden											
Dinitroanilines	6.1	UN1596	II	6.1	IB8, IP2, IP4, T3, TP33	153	212	242	25 kg	100 kg	A	91
Dinitrobenzenes, liquid	6.1	UN1597	II	6.1	11, IB2, T7, TP2	153	202	243	5 L	60 L	A	91
			III	6.1	11, IB3, T7, TP2	153	203	241	60 L	220 L	A	91
Dinitrobenzenes, solid	6.1	UN3443	II	6.1	IB8, IP2, IP4, T3, TP33	153	212	242	25 kg	100 kg	A	91
Dinitrochlorobenzene, see												
Chlorodinitrobenzene												
1,2-Dinitroethane	Forbidden											
1,1-Dinitroethane (dry)	Forbidden											
Dinitrogen tetroxide	2.3	UN1067		2.3, 5.1, 8	1, B7, B14, B45, B46, B61, B66, B67, B77, T50, TP21	None	336	314	Forbidden	Forbidden	D	40, 89, 90
Dinitroglycoluril or Dingu	1.1D	UN0489	1.1D	None	62	None	Forbidden	Forbidden	04	25
Dinitromethane	Forbidden											
Dinitrophenol, dry or wetted with less than 15 percent water, by mass	1.1D	UN0076	1.1D, 6.1	None	62	None	Forbidden	Forbidden	04	25, 5E
Dinitrophenol solutions	6.1	UN1599	II	6.1	IB2, T7, TP2	153	202	243	5 L	60 L	A	36
			III	6.1	IB3, T4, TP1	153	203	241	60 L	220 L	A	36
Dinitrophenol, wetted with not less than 15 percent water, by mass	4.1	UN1320	I	4.1, 6.1	23, A8, A19, A20, N41, W31	None	211	None	1 kg	15 kg	E	28, 36
Dinitrophenolates alkali metals, dry or wetted with less than 15 percent water, by mass	1.3C	UN0077	1.3C, 6.1	None	62	None	Forbidden	Forbidden	04	25, 5E
Dinitrophenolates, wetted with not less than 15 percent water, by mass	4.1	UN1321	I	4.1, 6.1	23, A8, A19, A20, N41, W31	None	211	None	1 kg	15 kg	E	28, 36
Dinitropropylene glycol	Forbidden											
Dinitroresorcinol, dry or wetted with less than 15 percent water, by mass	1.1D	UN0078	1.1D	None	62	None	Forbidden	Forbidden	04	25, 5E
2,4-Dinitroresorcinol (heavy metal salts of) (dry)	Forbidden											
4,6-Dinitroresorcinol (heavy metal salts of) (dry)	Forbidden											
Dinitroresorcinol, wetted with not less than 15 percent water, by mass	4.1	UN1322	I	4.1	23, A8, A19, A20, N41, W31	None	211	None	1 kg	15 kg	E	28, 36

§ 172.101 HAZARDOUS MATERIALS TABLE—Continued

Sym-bols	Hazardous materials descriptions and proper shipping names	Hazard class or Division	Identi-fication Numbers	PG	Label Codes	Special provisions (§ 172.102)	(8)			(9)		(10) Vessel stowage	
							Packaging (§ 173.***)			Quantity limitations (see §§ 173.27 and 175.75)		Loca-tion	Other
							Excep-tions	Non-bulk	Bulk	Passenger aircraft/rail	Cargo air-craft only		
(1)	(2)	(3)	(4)	(5)	(6)	(7)	(8A)	(8B)	(8C)	(9A)	(9B)	(10A)	(10B)
	3,5-Dinitrosalicylic acid (lead salt) (dry)	Forbidden											
	Dinitrobenzene	1.3C	UN0406	1.3C	None	62	None	Forbidden	Forbidden	04	25
	Dinitrosobenzylamine and salts of (dry)	Forbidden											
	2,2-Dinitrostilbene	Forbidden											
	Dinitrotoluenes, liquid	6.1	UN2038	II	6.1	IB2, T7, TP2	153	202	243	5 L	60 L	A	
	Dinitrotoluenes, molten	6.1	UN1600	II	6.1	T7, TP3	None	202	243	Forbidden	Forbidden	C	
	Dinitrotoluenes, solid	6.1	UN3454	II	6.1	IB8, IP2, IP4, T3, TP33	153	212	242	25 kg	100 kg	A	
	1,9-Dinitroxy pentamethylene-2,4,6,8-tetramine (dry)	Forbidden											
	Dioxane	3	UN1165	II	3	IB2, T4, TP1	150	202	242	5 L	60 L	B	
	Dioxolane	3	UN1166	II	3	IB2, T4, TP1	150	202	242	5 L	60 L	B	40
	Dipentene	3	UN2052	III	3	B1, IB3, T2, TP1	150	203	242	60 L	220 L	A	
	Diphenylamine chloroarsine	6.1	UN1698	I	6.1	T6, TP33, W31	None	201	None	Forbidden	Forbidden	D	40
	Diphenylchloroarsine, liquid	6.1	UN1699	I	6.1	A8, B14, B32, N33, N34, T14, TP2, TP13, TP27, W31	None	201	243	Forbidden	30 L	D	40
	Diphenylchloroarsine, solid	6.1	UN3450	I	6.1	IB7, IP1, T6, TP33, W31	None	211	242	5 kg	50 kg	D	40
	Diphenyldichlorosilane	8	UN1769	II	8	A7, B2, N34, T10, TP2, TP7, TP13	None	206	242	Forbidden	30 L	C	40, 53, 58
	Diphenylmethyl bromide	8	UN1770	II	8	IB8, IP2, IP4, T3, TP33	154	212	240	15 kg	50 kg	D	40, 53, 58
	Dipicryl sulfide, dry or wetted with less than 10 percent water, by mass	1.1D	UN0401	1.1D	None	62	None	Forbidden	Forbidden	04	25
	Dipicryl sulfide, wetted with not less than 10 percent water, by mass	4.1	UN2852	I	4.1	162, A2, N41, N84, W31	None	211	None	Forbidden	0.5 kg	D	28, 36
	Dipicrylamine, see Hexanitrodiphenylamine	Forbidden											
	Dipropionyl peroxide, with more than 28 percent in solution	Forbidden											
	Di-n-propyl ether	3	UN2384	II	3	IB2, T4, TP1	150	202	242	5 L	60 L	B	
	Dipropyl ketone	3	UN2710	III	3	B1, IB3, T2, TP1	150	203	242	60 L	220 L	A	
	Dipropylamine	3	UN2383	II	3, 8	IB2, T7, TP1	150	202	243	1 L	5 L	B	25, 52
G	Disinfectant, liquid, corrosive, n.o.s	8	UN1903	I	8	A7, B10, T14, TP2, TP27	None	201	243	0.5 L	2.5 L	B	
G	Disinfectants, liquid, corrosive n.o.s.	8	UN1903	II	8	B2, IB2, T7, TP2	154	202	242	1 L	30 L	B	

§ 172.101

49 CFR Ch. I (10-1-23 Edition)

G	Disinfectants, liquid, toxic, n.o.s.	6.1	UN3142	III	8	IB3, T4, TP1	154	203	241	5 L	60 L	A	40
				I	6.1	A4, T14, TP2, TP27	None	201	243	1 L	30 L	A	
				II	6.1	IB2, T11, TP2, TP27	153	202	243	5 L	60 L	A	
G	Disinfectants, solid, toxic, n.o.s.	6.1	UN1601	III	6.1	IB3, T7, TP1, TP28	153	203	241	60 L	220 L	A	40
				I	6.1	IB7, IP1, T6, TP33	None	211	242	5 kg	50 kg	A	
				II	6.1	IB8, IP2, IP4, T3, TP33	153	212	242	25 kg	100 kg	A	
G	Disodium trioxosilicate Dispersant gases, n.o.s. see Refrigerant gases, n.o.s. Divinyl ether, stabilized Dodecyltrichlorosilane	8	UN3253	III	6.1	IB8, IP3, T1, TP33	153	213	240	100 kg	200 kg	A	40
				III	8	IB8, IP3, T1, TP33	154	213	240	25 kg	100 kg	A	
				I	3	387, A7, T11, TP2	None	201	243	1 L	30 L	E	
G	Dyes, liquid, toxic, n.o.s. or Dye intermediates, liquid, toxic, n.o.s.	6.1	UN1602	II	8	A7, B2, B6, N34, T10, TP2, TP7, TP13	None	206	242	Forbidden	30 L	C	25, 40, 53, 58
				III	8	11, IB3, T7, TP1, TP28	154	203	241	5 L	60 L	A	
				I	6.1	11, B10, T14, TP2, TP27	None	201	243	0.5 L	2.5 L	A	
G	Dyes, solid, corrosive, n.o.s. or Dye intermediates, solid, corrosive, n.o.s.	8	UN3147	II	8	11, B2, IB2, T11, TP2, TP27	154	202	242	1 L	30 L	A	40
				III	8	11, IB3, T7, TP1, TP28	154	203	241	5 L	60 L	A	
				I	8	IB7, IP1, T6, TP33	None	211	242	1 kg	25 kg	A	
G	Dyes, solid, toxic, n.o.s. or Dye intermediates, solid, toxic, n.o.s.	6.1	UN3143	II	6.1	IB2	153	202	243	5 L	60 L	A	85
				III	8	IB8, IP2, IP4, T3, TP33	154	212	240	15 kg	50 kg	A	
				I	6.1	IB8, IP3, T1, TP33	154	213	240	25 kg	100 kg	A	
G	Elevated temperature liquid, flammable, n.o.s., with flash point above 37.8 C, at or above its flash point	3	UN3256	III	3	A5, IB7, IP1, T6, TP33	None	211	242	5 kg	50 kg	A	85
				II	6.1	IB8, IP2, IP4, T3, TP33	153	212	242	25 kg	100 kg	A	
				III	6.1	IB8, IP3, T1, TP33	153	213	240	100 kg	200 kg	A	
G	Elevated temperature liquid, n.o.s., at or above 100 C and below its flash point (including molten metals, molten salts, etc.)	9	UN3257	III	9	IB1, T3, TP3, TP29	None	None	247	Forbidden	Forbidden	A	85
				III	9	IB1, T3, TP3, TP29	None	None	247	Forbidden	Forbidden	A	
				III	9	IB1, T3, TP3, TP29	None	None	247	Forbidden	Forbidden	A	
G	Elevated temperature solid, n.o.s., at or above 240 C, see § 173.247(h)(4)	9	UN3258	III	9		247 (h)(4)	None	247	Forbidden	Forbidden	A	85

§ 172.101 HAZARDOUS MATERIALS TABLE—Continued

§ 172.101

49 CFR Ch. I (10-1-23 Edition)

Sym-bols (1)	Hazardous materials descriptions and proper shipping names (2)	Hazard class or Division (3)	Identi-fication Numbers (4)	PG (5)	Label Codes (6)	Special provisions (§ 172.102) (7)	(8)			(9)		(10) Vessel stowage	
							Packaging (§ 173.***)			Quantity limitations (see §§ 173.27 and 175.75)		Loca-tion (10A)	Other (10B)
							Excep-tions (8A)	Non-bulk (8B)	Bulk (8C)	Passenger aircraft/rail (9A)	Cargo air-craft only (9B)		
	Engine, internal combustion, flammable gas powered or Engine, fuel cell, flammable gas powered or Machinery, internal combustion, flammable gas powered or Machinery, fuel cell, flammable gas powered	2.1	UN3529	2.1	135, A200	220	220	220	Forbidden	No limit	E	
	Engine, internal combustion, flammable liquid powered or Engine, fuel cell, flammable liquid powered or Machinery, internal combustion, flammable liquid powered or Machinery, fuel cell, flammable liquid powered	3	UN3528	3	135, A200	220	220	220	No limit	No limit	E	149
	Engine, internal combustion or Machinery, internal combustion	9	UN3530	9	135, A200	220	220	220	No limit	No limit	A	
G	Environmentally hazardous substance, liquid, n.o.s.	9	UN3082	III	9	8, 146, 173, 335, 441, IB3, T4, TP1, TP29	155	203	241	No limit	No limit	A
G	Environmentally hazardous substance, solid, n.o.s.	9	UN3077	III	9	8, 146, 335, 384, 441, A112, B54, B120, IB8, IP3, N20, N91, T1, TP33	155	213	240	No limit	No limit	A
+	Epibromohydrin	6.1	UN2558	I	6.1, 3	T14, TP2, TP13	None	201	243	Forbidden	Forbidden	D	40
	Epichlorohydrin	6.1	UN2023	II	6.1, 3	IB2, T7, TP2, TP13	153	202	243	5 L	60 L	A	40
	1,2-Epoxy-3-ethoxypropane	3	UN2752	III	3	B1, IB3, T2, TP1	150	203	242	60 L	220 L	A	
	Esters, n.o.s.	3	UN3272	II	3	IB2, T7, TP1, TP8, TP28	150	202	242	5 L	60 L	B	
	<i>Etching acid, liquid, n.o.s., see Hydrofluoric acid, etc</i>												
	Ethane	2.1	UN1035		2.1		306	304	302	Forbidden	150 kg	E	40
D	Ethane-Propane mixture, refrigerated liquid	2.1	NA1961		2.1	T75, TP5	None	316	314, 315	Forbidden	Forbidden	D	40
	Ethane, refrigerated liquid	2.1	UN1961		2.1	T75, TP5	None	None	315	Forbidden	Forbidden	D	40
	<i>Ethanol amine dinitrate</i>	Forbidden											

Ethanol and gasoline mixture or Ethanol and motor spirit mixture or Ethanol and petrol mixture, with more than 10% ethanol	3	UN3475	II	3	144, 177, IB2, T4, TP1	150	202	242	5 L	60 L	E	
Ethanol or Ethyl alcohol or Ethanol solutions or Ethyl alcohol solutions	3	UN1170	II	3	24, IB2, T4, TP1	4b, 150	202	242	5 L	60 L	A	
Ethanolamine or Ethanolamine solutions	8	UN2491	III	3	24, B1, IB3, T2, TP1	4b, 150	203	242	60 L	220 L	A	52.
Ether, see Diethyl ether												
Ethers, n.o.s.	3	UN3271	II	3	IB2, T7, TP1, TP8, TP28	150	202	242	5 L	60 L	B	
Ethyl acetate	3	UN1173	III	3	B1, IB3, T4, TP1, TP29	150	203	242	60 L	220 L	A	
Ethyl acrylate, stabilized	3	UN1917	II	3	IB2, T4, TP1	150	202	242	5 L	60 L	B	
Ethyl alcohol, see Ethanol	3	UN1917	II	3	387, IB2, T4, TP1, TP13	150	202	242	5 L	60 L	C	25, 40
Ethyl aldehyde, see Acetaldehyde												
Ethyl amyl ketone	3	UN2271	III	3	B1, IB3, T2, TP1	150	203	242	60 L	220 L	A	
N-Ethylbenzyltoluidines, solid	6.1	UN3460	III	6.1	IB8, IP3, T1, TP33	153	213	240	100 kg	200 kg	A	
N-Ethyl-N-benzylaniline	6.1	UN2274	III	6.1	IB3, T4, TP1	153	203	241	60 L	220 L	A	
Ethyl borate	3	UN1176	II	3	IB2, T4, TP1	150	202	242	5 L	60 L	B	
Ethyl bromide	6.1	UN1891	II	6.1	IB2, IP8, T7, TP2, TP13	153	202	243	5 L	60 L	B	40, 85
Ethyl bromoacetate	6.1	UN1603	II	6.1, 3	IB2, T7, TP2	153	202	243	Forbidden	Forbidden	D	40
Ethyl butyl ether	3	UN1179	II	3	B1, IB2, T4, TP1	150	202	242	5 L	60 L	B	
Ethyl butyrate	3	UN1180	III	3	B1, IB3, T2, TP1	150	203	242	60 L	220 L	A	
Ethyl chloride	2.1	UN1037		2.1	B77, N86, T50	None	322	314, 315	Forbidden	150 kg	B	40
Ethyl chloroacetate	6.1	UN1181	II	6.1, 3	IB2, T7, TP2	153	202	243	5 L	60 L	A	
Ethyl chloroformate	6.1	UN1182	I	6.1, 3, 8	2, B9, B14, B32, N34, T20, TP2, TP13, TP38, TP45	None	227	244	Forbidden	Forbidden	D	21, 40, 53, 58, 100
Ethyl 2-chloropropionate	3	UN2935	III	3	B1, IB3, T2, TP1	150	203	242	60 L	220 L	A	
Ethyl chlorothioformate	8	UN2826	II	8, 6.1, 3	2, B9, B14, B32, T20, TP2, TP38, TP45	None	227	244	Forbidden	Forbidden	A	40, 53, 58
Ethyl crotonate	3	UN1862	II	3	IB2, T4, TP2	150	202	242	5 L	60 L	B	
Ethyl ether, see Diethyl ether												
Ethyl fluoride or Refrigerant gas R161	2.1	UN2453		2.1		306	304	314, 315	Forbidden	150 kg	E	40
Ethyl formate	3	UN1190	II	3	IB2, T4, TP1	150	202	242	5 L	60 L	E	
Ethyl hydroperoxide	Forbidden											
Ethyl isobutyrate	3	UN2385	II	3	IB2, T4, TP1	150	202	242	5 L	60 L	B	
Ethyl isocyanate	6.1	UN2481	I	6.1, 3	1, B9, B14, B30, T20, TP2, TP13, TP38, TP44	None	226	244	Forbidden	Forbidden	D	40, 52
Ethyl lactate	3	UN1192	III	3	B1, IB3, T2, TP1	150	203	242	60 L	220 L	A	
Ethyl mercaptan	3	UN2363	I	3	T11, TP2, TP13	None	201	243	Forbidden	30 L	E	95, 102
Ethyl methacrylate, stabilized	3	UN2277	II	3	387, IB2, T4, TP1	150	202	242	5 L	60 L	C	25
Ethyl methyl ether	2.1	UN1039		2.1		None	201	314, 315	Forbidden	150 kg	B	40
Ethyl methyl ketone or Methyl ethyl ketone	3	UN1193	II	3	IB2, T4, TP1	150	202	242	5 L	60 L	B	

§ 172.101 HAZARDOUS MATERIALS TABLE—Continued

Sym-bols	Hazardous materials descriptions and proper shipping names	Hazard class or Division	Identi-fication Numbers	PG	Label Codes	Special provisions (§ 172.102)	(8)			(9)		(10) Vessel stowage	
							Packaging (§ 173.***)			Quantity limitations (see §§ 173.27 and 175.75)		Loca-tion	Other
							Excep-tions	Non-bulk	Bulk	Passenger aircraft/rail	Cargo air-craft only		
(1)	(2)	(3)	(4)	(5)	(6)	(7)	(8A)	(8B)	(8C)	(9A)	(9B)	(10A)	(10B)
D	Ethyl nitrite solutions	3	UN1194	I	3, 6.1		None	201	None	Forbidden	Forbidden	E	40, 105
	Ethyl orthoformate	3	UN2524	III	3	B1, IB3, T2, TP1	150	203	242	60 L	220 L	A	
	Ethyl oxalate	6.1	UN2525	III	6.1	IB3, T4, TP1	153	203	241	60 L	220 L	A	
	<i>Ethyl perchlorate</i>	Forbidden											
	Ethyl phosphonothioic dichloride, anhydrous	6.1	NA2927	I	6.1, 8	2, B9, B14, B32, T20, TP4, TP12, TP13, TP38, TP45	None	227	244	Forbidden	Forbidden	D	40
	Ethyl phosphonous dichloride, anhydrous <i>pyrophoric liquid</i>	6.1	NA2845	I	6.1, 4.2	2, B9, B14, B32, T20, TP4, TP12, TP13, TP38, TP45	None	227	244	Forbidden	Forbidden	D	18
	Ethyl phosphorodichloridate	6.1	NA2927	I	6.1, 8	2, B9, B14, B32, T20, TP4, TP12, TP13, TP38, TP45	None	227	244	Forbidden	Forbidden	D	40
	Ethyl propionate	3	UN1195	II	3	IB2, T4, TP1	150	202	242	5 L	60 L	B	
	Ethyl propyl ether	3	UN2615	II	3	IB2, T4, TP1	150	202	242	5 L	60 L	E	
	<i>Ethyl silicate, see Tetraethyl silicate</i>												
	Ethylacetylene, stabilized	2.1	UN2452	2.1	387, N88	None	304	314, 315	Forbidden	150 kg	B	25, 40
	Ethylamine	2.1	UN1036	2.1	B77, N87, T50	None	321	314, 315	Forbidden	150 kg	D	40, 52
	Ethylamine, aqueous solution <i>with not less than 50 percent but not more than 70 percent ethylamine</i>	3	UN2270	II	3, 8	IB2, T7, TP1	150	202	243	1 L	5 L	B	40, 52.
	N-Ethylaniline	6.1	UN2272	III	6.1	IB3, T4, TP1	153	203	241	60 L	220 L	A	52, 74
	2-Ethylaniline	6.1	UN2273	III	6.1	IB3, T4, TP1	153	203	241	60 L	220 L	A	52, 74
	Ethylbenzene	3	UN1175	II	3	IB2, T4, TP1	150	202	242	5 L	60 L	B	
	N-Ethylbenzyltoluidines liquid	6.1	UN2753	III	6.1	IB3, T7, TP1	153	203	241	60 L	220 L	A	
	2-Ethylbutanol	3	UN2275	III	3	B1, IB3, T2, TP1	150	203	242	60 L	220 L	A	
2-Ethylbutyl acetate	3	UN1177	III	3	B1, IB3, T2, TP1	150	203	242	60 L	220 L	A		
2-Ethylbutyraldehyde	3	UN1178	II	3	B1, IB2, T4, TP1	150	202	242	5 L	60 L	B		
Ethylchloroarsine	6.1	UN1892	I	6.1	2, B9, B14, B32, T20, TP2, TP13, TP38, TP45	None	227	244	Forbidden	Forbidden	D	40	
Ethylchlorosilane	4.3	UN1183	I	4.3, 8, 3	A2, A7, N34, T14, TP2, TP7, TP13, W31	None	201	244	Forbidden	1 L	D	21, 40, 49, 53, 58, 100	

§ 172.101

49 CFR Ch. I (10-1-23 Edition)

Ethylene, acetylene and propylene in mixture, refrigerated liquid with at least 71.5 percent ethylene with not more than 22.5 percent acetylene and not more than 6 percent propylene	2.1	UN3138		2.1	T75, TP5	None	304	314, 315	Forbidden	Forbidden	D	40, 57	
Ethylene chlorohydrin	6.1	UN1135	I	6.1, 3	2, B9, B14, B32, T20, TP2, TP13, TP38, TP45	None	227	244	Forbidden	Forbidden	D	40	
Ethylene <i>Ethylene diamine dperchlorate</i>	2.1	UN1962		2.1		306	304	302	Forbidden	150 kg	E	40	
Ethylene dibromide	6.1	UN1605	I	6.1	2, B9, B14, B32, B77, T20, TP2, TP13, TP38, TP45	None	227	244	Forbidden	Forbidden	D	40	
<i>Ethylene dibromide and methyl bromide liquid mixtures, see Methyl bromide and ethylene dibromide, liquid mixtures</i>													
Ethylene dichloride	3	UN1184	II	3, 6.1	IB2, N36, T7, TP1	150	202	243	1 L	60 L	B	40	
Ethylene glycol diethyl ether	3	UN1153	II	3	IB2, T4, TP1	150	202	242	5 L	60 L	A		
			III	3	B1, IB3, T2, TP1	150	203	242	60 L	220 L	A		
<i>Ethylene glycol dinitrate</i>													
Ethylene glycol monoethyl ether	3	UN1171	III	3	B1, IB3, T2, TP1	150	203	242	60 L	220 L	A		
Ethylene glycol monoethyl ether acetate	3	UN1172	III	3	B1, IB3, T2, TP1	150	203	242	60 L	220 L	A		
Ethylene glycol monomethyl ether	3	UN1188	III	3	B1, IB3, T2, TP1	150	203	242	60 L	220 L	A		
Ethylene glycol monomethyl ether acetate	3	UN1189	III	3	B1, IB3, T2, TP1	150	203	242	60 L	220 L	A		
Ethylene oxide and carbon dioxide mixture with more than 87 percent ethylene oxide	2.3	UN3300		2.3, 2.1		4	None	304	314, 315	Forbidden	Forbidden	D	40
Ethylene oxide and carbon dioxide mixtures with more than 9 percent but not more than 87 percent ethylene oxide	2.1	UN1041		2.1		T50	306	304	314, 315	Forbidden	25 kg	B	40
Ethylene oxide and carbon dioxide mixtures with not more than 9 percent ethylene oxide	2.2	UN1952		2.2			306	304	314, 315	75 kg	150 kg	A	
Ethylene oxide and chlorotetrafluoroethane mixture with not more than 8.8 percent ethylene oxide	2.2	UN3297		2.2		T50	306	304	314, 315	75 kg	150 kg	A	
Ethylene oxide and dichlorodifluoromethane mixture, with not more than 12.5 percent ethylene oxide	2.2	UN3070		2.2		T50	306	304	314, 315	75 kg	150 kg	A	
Ethylene oxide and pentafluoroethane mixture with not more than 7.9 percent ethylene oxide	2.2	UN3298		2.2		T50	306	304	314, 315	75 kg	150 kg	A	

§ 172.101 HAZARDOUS MATERIALS TABLE—Continued

Sym-bols (1)	Hazardous materials descriptions and proper shipping names (2)	Hazard class or Division (3)	Identi-fication Numbers (4)	PG (5)	Label Codes (6)	Special provisions (§ 172.102) (7)	(8)			(9)		(10) Vessel stowage	
							Packaging (§ 173.***)			Quantity limitations (see §§ 173.27 and 175.75)		Loca-tion (10A)	Other (10B)
							Excep-tions (8A)	Non-bulk (8B)	Bulk (8C)	Passenger aircraft/rail (9A)	Cargo air-craft only (9B)		
	Ethylene oxide and propylene oxide mixtures, with not more than 30 percent ethylene oxide	3	UN2983	I	3, 6.1	5, A11, N4, N34, T14, TP2, TP7, TP13	None	201	243	Forbidden	30 L	E	40
	Ethylene oxide and tetrafluoroethane mixture with not more than 5.6 percent ethylene oxide	2.2	UN3299		2.2	T50	306	304	314, 315	75 kg	150 kg	A	
	Ethylene oxide or Ethylene oxide with nitrogen up to a total pressure of 1 MPa (10 bar) at 50 degrees C	2.3	UN1040		2.3, 2.1	4, 342, T50, TP20	None	323	323	Forbidden	Forbidden	D	40
	Ethylene, refrigerated liquid (cryogenic liquid)	2.1	UN1038		2.1	T75, TP5	None	316	318, 319	Forbidden	Forbidden	D	40
	Ethylenediamine	8	UN1604	II	8, 3	IB2, T7, TP2	154	202	243	1 L	30 L	A	40, 52.
	Ethyleneimine, stabilized	6.1	UN1185	I	6.1, 3	1, 387, B9, B14, B30, B77, N25, N32, T22, TP2, TP13, TP38, TP44	None	226	244	Forbidden	Forbidden	D	25, 40
	<i>Ethylhexaldehyde, see Octyl aldehydes etc</i>												
	2-Ethylhexyl chloroformate	6.1	UN2748	II	6.1, 8	IB2, T7, TP2, TP13	153	202	243	1 L	30 L	A	12, 13, 25, 40, 53, 58
	2-Ethylhexylamine	3	UN2276	III	3, 8	B1, IB3, T4, TP1	150	203	242	5 L	60 L	A	40, 52
	Ethylphenyldichlorosilane	8	UN2435	II	8	A7, B2, N34, T10, TP2, TP7, TP13	None	206	242	Forbidden	30 L	C	53, 58
	1-Ethylpiperidine	3	UN2386	II	3, 8	IB2, T7, TP1	150	202	243	1 L	5 L	B	52.
	N-Ethyltoluidines	6.1	UN2754	II	6.1	IB2, T7, TP2	153	202	243	5 L	60 L	A	
	Ethyltrichlorosilane	3	UN1196	II	3, 8	A7, N34, T10, TP2, TP7, TP13	None	206	243	Forbidden	5 L	B	40
	<i>Etiologic agent, see Infectious substances, etc</i>												
	<i>Explosive articles, see Articles, explosive, n.o.s. etc</i>												
	Explosive, blasting, type A	1.1D	UN0081	1.1D	148	None	62	None	Forbidden	Forbidden	04	25, 19E, 21E
	Explosive, blasting, type B	1.1D	UN0082	1.1D	None	62	None	Forbidden	Forbidden	04	25, 19E

§ 172.101

49 CFR Ch. I (10-1-23 Edition)

	Explosive, blasting, type B or Agent blasting, Type B	1.5D	UN0331	1.5D	105, 106, 148	None	62	None	Forbidden	Forbidden	03	25, 19E	
	Explosive, blasting, type C	1.1D	UN0083	1.1D	123	None	62	None	Forbidden	Forbidden	04	25, 22E	
	Explosive, blasting, type D	1.1D	UN0084	1.1D	None	62	None	Forbidden	Forbidden	04	25	
	Explosive, blasting, type E	1.1D	UN0241	1.1D	148	None	62	None	Forbidden	Forbidden	04	25, 19E	
	Explosive, blasting, type E or Agent blasting, Type E	1.5D	UN0332	1.5D	105, 106, 148	None	62	None	Forbidden	Forbidden	03	25, 19E	
	<i>Explosive, forbidden. See § 173.54 Explosive substances, see Substances, explosive, n.o.s. etc Explosives, slurry, see Explosive, blasting, type E Explosives, water gels, see Explosive, blasting, type E</i>				Forbidden									
	Extracts, aromatic, liquid	3	UN1169	II	3	149, IB2, T4, TP1, TP8	150	202	242	5 L	60 L	B		
				III	3	B1, IB3, T2, TP1	150	203	242	60 L	220 L	A		
	Extracts, flavoring, liquid	3	UN1197	II	3	149, IB2, T4, TP1, TP8	150	202	242	5 L	60 L	B		
				III	3	B1, IB3, T2, TP1	150	203	242	60 L	220 L	A		
	<i>Fabric with animal or vegetable oil, see Fibers or fabrics, etc</i>													
	Ferric arsenate	6.1	UN1606	II	6.1	IB8, IP2, IP4, T3, TP33	153	212	242	25 kg	100 kg	A		
	Ferric arsenite	6.1	UN1607	II	6.1	IB8, IP2, IP4, T3, TP33	153	212	242	25 kg	100 kg	A		
	Ferric chloride, anhydrous	8	UN1773	III	8	IB8, IP3, T1, TP33	154	213	240	25 kg	100 kg	A	53, 58	
	Ferric chloride, solution	8	UN2582	III	8	B15, IB3, T4, TP1	154	203	241	5 L	60 L	A	53, 58	
	Ferric nitrate	5.1	UN1466	III	5.1	A1, A29, IB8, IP3, T1, TP33	152	213	240	25 kg	100 kg	A		
	Ferrocerium	4.1	UN1323	II	4.1	59, A19, IB8, IP2, IP4, T3, TP33, W100	151	212	240	15 kg	50 kg	A	13, 147, 148	
	Ferrosilicon with 30 percent or more but less than 90 percent silicon	4.3	UN1408	III	4.3, 6.1	A1, A19, B6, IB8, IP4, IP7, T1, TP33, W100	151	213	240	25 kg	100 kg	A	13, 40, 52, 53, 85, 103, 148	
	Ferrous arsenate	6.1	UN1608	II	6.1	IB8, IP2, IP4, T3, TP33	153	212	242	25 kg	100 kg	A		
D	Ferrous chloride, solid	8	NA1759	II	8	IB8, IP2, IP4, T3, TP33	154	212	240	15 kg	50 kg	A		
D	Ferrous chloride, solution	8	NA1760	II	8	B3, IB2, T11, TP2, TP27	154	202	242	1 L	30 L	B	40	
	Ferrous metal borings or Ferrous metal shavings or Ferrous metal turnings or Ferrous metal cuttings in a form liable to self-heating	4.2	UN2793	III	4.2	A1, A19, B134, B136, IB8, IP3, IP7, IP21, W100	None	213	241	25 kg	100 kg	A	13, 148	
	Fertilizer ammoniating solution with free ammonia	2.2	UN1043		2.2	N87	306	304	314, 315	Forbidden	150 kg	E	40	
A I W	Fibers, animal or Fibers, vegetable burnt, wet or damp	4.2	UN1372	III	4.2		151	213	240	Forbidden	Forbidden	A		
A, I, W	Fibers, vegetable, dry	4.1	UN3360	III	4.1		137	151	213	240	Forbidden	Forbidden	A

§ 172.101 HAZARDOUS MATERIALS TABLE—Continued

§ 172.101

49 CFR Ch. I (10-1-23 Edition)

(1) Sym-bols	(2) Hazardous materials descriptions and proper shipping names	(3) Hazard class or Division	(4) Identi-fication Numbers	(5) PG	(6) Label Codes	(7) Special provisions (§ 172.102)	(8) Packaging (§ 173.***)			(9) Quantity limitations (see §§ 173.27 and 175.75)		(10) Vessel stowage	
							Excep-tions	Non-bulk	Bulk	Passenger aircraft/rail	Cargo air-craft only	Loca-tion	Other
A W	Fibers or Fabrics, animal or vegetable or Synthetic, n.o.s. with animal or vegetable oil	4.2	UN1373	III	4.2	137, IB8, IP3, T1, TP33, W31	None	213	241	Forbidden	Forbidden	A	
	Fibers or Fabrics impregnated with weakly nitrated nitrocellulose, n.o.s	4.1	UN1353	III	4.1	A1, IB8, IP3	151	213	240	25 kg	100 kg	D	
	Films, nitrocellulose base, from which gelatine has been removed; film scrap, see Celluloid scrap	4.1	UN1324	III	4.1	151	183	None	25 kg	100 kg	D	28
	Films, nitrocellulose base, gelatine coated (except scrap)	8	UN1774	II	8	N41	154	202	None	1 L	30 L	A	
	Fire extinguisher charges, corrosive liquid	2.2	UN1044	2.2	110	309	309	None	75 kg	150 kg	A
	Fire extinguisher charges, expelling, explosive, see Cartridges, power device	4.1	UN2623	III	4.1	A1, A19	151	213	None	25 kg	100 kg	A	52
	Fire extinguishers containing compressed or liquefied gas	1.1G	UN0333	1.1G	108	None	62	None	Forbidden	Forbidden	03	25
	Fireworks	1.2G	UN0334	1.2G	108	None	62	None	Forbidden	Forbidden	03	25
	Fireworks	1.3G	UN0335	1.3G	108	None	62	None	Forbidden	Forbidden	03	25
	Fireworks	1.4G	UN0336	1.4G	108, 200	None	62	None	Forbidden	75 kg	02	25
	Fireworks	1.4S	UN0337	1.4S	108	None	62	None	25 kg	100 kg	01	25
	First aid kit	9	UN3316	9	15	161	161	None	10 kg	10 kg	A	
A, W	Fish meal, stabilized or Fish scrap, stabilized	9	UN2216	III	None	155, B136, IB8, IP3, T1, TP33	155	218	218	100 kg	200 kg	B	25, 88, 122, 128
	Fish meal, unstabilized or Fish scrap, unstabilized	4.2	UN1374	II	4.2	155, A1, A19, IB8, IP2, IP4, T3, TP33, W31, W40	None	212	241	Forbidden	Forbidden	B	18, 25, 128
	Flammable compressed gas, see Compressed or Liquefied gas, flammable, etc												

	<i>Flammable compressed gas (small receptacles not fitted with a dispersion device, not refillable), see Receptacles, etc</i>												
	<i>Flammable gas in lighters, see Lighters or lighter refills, cigarettes, containing flammable gas</i>												
G	Flammable liquid, toxic, corrosive, n.o.s.	3	UN3286	I	3, 6.1, 8	T14, TP2, TP13, TP27	None	201	243	Forbidden	2.5 L	E	21, 40, 100
				II	3, 6.1, 8	IB2, T11, TP2, TP13, TP27	150	202	243	1 L	5 L	B	21, 40, 100
G	Flammable liquids, corrosive, n.o.s.	3	UN2924	I	3, 8	T14, TP2	None	201	243	0.5 L	2.5 L	E	40
				II	3, 8	IB2, T11, TP2, TP27	150	202	243	1 L	5 L	B	40
				III	3, 8	B1, IB3, T7, TP1, TP28	150	203	242	5 L	60 L	A	40
G	Flammable liquids, n.o.s.	3	UN1993	I	3	T11, TP1, TP27	150	201	243	1 L	30 L	E	
				II	3	IB2, T7, TP1, TP8, TP28	150	202	242	5 L	60 L	B	
				III	3	B1, B52, IB3, T4, TP1, TP29	150	203	242	60 L	220 L	A	
G	Flammable liquids, toxic, n.o.s.	3	UN1992	I	3, 6.1	T14, TP2, TP13, TP27	None	201	243	Forbidden	30 L	E	40
				II	3, 6.1	IB2, T7, TP2, TP13	150	202	243	1 L	60 L	B	40
				III	3, 6.1	B1, IB3, T7, TP1, TP28	150	203	242	60 L	220 L	A	
G	Flammable solid, corrosive, inorganic, n.o.s.	4.1	UN3180	II	4.1, 8	A1, IB6, IP2, T3, TP33	151	212	242	15 kg	50 kg	D	40
G	Flammable solid, inorganic, n.o.s.	4.1	UN3178	II	4.1, 8	A1, IB6, T1, TP33	151	213	242	25 kg	100 kg	D	40
				III	4.1	A1, IB8, IP2, IP4, T3, TP33	151	212	240	15 kg	50 kg	B	
G	Flammable solid, organic, molten, n.o.s.	4.1	UN3176	II	4.1	A1, IB8, IP3, T1, TP33	151	213	240	25 kg	100 kg	B	
				III	4.1	IB1, T3, TP3, TP26	151	212	240	Forbidden	Forbidden	C	
G	Flammable solid, oxidizing, n.o.s.	4.1	UN3097	II	4.1, 5.1	IB1, T1, TP3, TP26	151	213	240	Forbidden	Forbidden	C	40
				III	4.1, 5.1	131, T1, TP33	151	214	214	Forbidden	Forbidden	D	40
G	Flammable solid, toxic, inorganic, n.o.s.	4.1	UN3179	II	4.1, 6.1	A1, IB6, IP2, T3, TP33	151	212	242	15 kg	50 kg	B	40
				III	4.1, 6.1	A1, IB6, T1, TP33	151	213	242	25 kg	100 kg	B	40
G	Flammable solids, corrosive, organic, n.o.s.	4.1	UN2925	II	4.1, 8	A1, IB6, IP2, T3, TP33	151	212	242	15 kg	50 kg	D	40
G	Flammable solids, organic, n.o.s.	4.1	UN1325	III	4.1, 8	A1, IB6, T1, TP33	151	213	242	25 kg	100 kg	D	40
				II	4.1	A1, IB8, IP2, IP4, T3, TP33	151	212	240	15 kg	50 kg	B	
G	Flammable solids, toxic, organic, n.o.s.	4.1	UN2926	III	4.1	A1, IB8, IP3, T1, TP33	151	213	240	25 kg	100 kg	B	40
				II	4.1, 6.1	A1, IB6, IP2, T3, TP33	151	212	242	15 kg	50 kg	B	40
				III	4.1, 6.1	A1, IB6, T1, TP33	151	213	242	25 kg	100 kg	B	40
	Flares, aerial	1.3G	UN0093	1.3G	None	62	None	Forbidden	75 kg	03	25
	Flares, aerial	1.4G	UN0403	1.4G	None	62	None	Forbidden	75 kg	02	25

§ 172.101 HAZARDOUS MATERIALS TABLE—Continued

§ 172.101

Sym-bols (1)	Hazardous materials descriptions and proper shipping names (2)	Hazard class or Division (3)	Identi-fication Numbers (4)	PG (5)	Label Codes (6)	Special provisions (§ 172.102) (7)	(8)			(9)		(10) Vessel stowage	
							Packaging (§ 173.***)			Quantity limitations (see §§ 173.27 and 175.75)		Loca-tion (10A)	Other (10B)
							Excep-tions (8A)	Non-bulk (8B)	Bulk (8C)	Passenger aircraft/rail (9A)	Cargo air-craft only (9B)		
	Flares, aerial	1.4S	UN0404	1.4S	None	62	None	25 kg	100 kg	01	25
	Flares, aerial	1.1G	UN0420	1.1G	None	62	None	Forbidden	Forbidden	03	25
	Flares, aerial	1.2G	UN0421	1.2G	None	62	None	Forbidden	Forbidden	03	25
	<i>Flares, airplane, see</i> Flares, aerial												
	<i>Flares, signal, see</i> Cartridges, sig-nal												
	Flares, surface	1.3G	UN0092	1.3G	None	62	None	Forbidden	75 kg	03	25
	Flares, surface	1.1G	UN0418	1.1G	None	62	None	Forbidden	Forbidden	03	25
	Flares, surface	1.2G	UN0419	1.2G	None	62	None	Forbidden	Forbidden	03	25
	<i>Flares, water-activated, see</i> Contri-vances, water-activated, etc												
	Flash powder	1.1G	UN0094	1.1G	None	62	None	Forbidden	Forbidden	03	25
	Flash powder	1.3G	UN0305	1.3G	None	62	None	Forbidden	Forbidden	03	25
	<i>Flue dusts, poisonous, see</i> Arseni-cal dust												
	<i>Fluoric acid, see</i> Hydrofluoric acid, etc												
	Fluorine, compressed	2.3	UN1045		2.3, 5.1, 8	1, N86	None	302	None	Forbidden	Forbidden	D	40, 89, 90
	Fluoroacetic acid	6.1	UN2642	I	6.1	IB7, IP1, T6, TP33	None	211	242	1 kg	15 kg	E	53, 58
	Fluoroanilines	6.1	UN2941	III	6.1	IB3, T4, TP1	153	203	241	60 L	220 L	A	
	Fluorobenzene	3	UN2387	II	3	IB2, T4, TP1	150	202	242	5 L	60 L	B	
	Fluoroboric acid	8	UN1775	II	8	A7, B2, B15, IB2, N3, N34, T7, TP2	154	202	242	1 L	30 L	A	53, 58
	Fluorophosphoric acid anhydrous	8	UN1776	II	8	A7, B2, IB2, N3, N34, T8, TP2	154	202	242	1 L	30 L	A	53, 58
G	Fluorosilicates, n.o.s	6.1	UN2856	III	6.1	IB8, IP3, T1, TP33	153	213	240	100 kg	200 kg	A	52
	Fluorosilicic acid	8	UN1778	II	8	A7, B2, B15, IB2, N3, N34, T8, TP2	154	202	242	1 L	30 L	A	53, 58
	Fluorosulfonic acid	8	UN1777	I	8	A7, A10, B6, B10, N3, N36, T10, TP2	None	201	243	0.5 L	2.5 L	D	40, 53, 58
	Fluorotoluenes	3	UN2388	II	3	IB2, T4, TP1	150	202	242	5 L	60 L	B	40
	<i>Forbidden materials. See § 173.21</i>	Forbidden											
	Formaldehyde solutions, flammable	3	UN1198	III	3, 8	176, B1, IB3, T4, TP1	150	203	242	5 L	60 L	A	40

49 CFR Ch. I (10-1-23 Edition)

D	Formaldehyde solutions (with not less than 10% and less than 25% formaldehyde), see Aviation regulated liquid, n.o.s. or Other regulated substances, liquid, n.o.s.	8	UN2209	III	8	IB3, T4, TP1	154	203	241	5 L	60 L
	Formaldehyde solutions, with not less than 25 percent formaldehyde	8	UN3412	II	8	IB2, T7, TP2	154	202	242	1 L	30 L	A 40, 53, 58
	Formalin, see Formaldehyde, solutions	8	UN3412	III	8	IB3, T4, TP1	154	203	241	5 L	60 L	A 40, 53, 58
	Formic acid with not less than 10% but not more than 85% acid by mass	8	UN1779	II	8, 3	B2, B28, IB2, T7, TP2	154	202	242	1 L	30 L	A 40, 53, 58
	Formic acid with not less than 5% but less than 10% acid by mass	1.1D	UN0099	1.1D	None	62	62	Forbidden	Forbidden	03 25
	Formic acid with more than 85% acid by mass	3	UN1863	I	3	144, T11, TP1, TP8, TP28	150	201	243	1 L	30 L	E
	Fracturing devices, explosive, without detonators for oil wells	8	UN3477	II III	3 3 8	144, IB2, T4, TP1, TP8 144, B1, IB3, T2, TP1 328	150 150 230	202 203 230	242 242 230	5 L 60 L 5 kg	60 L 220 L 50 kg	B A A
	Fuel, aviation, turbine engine	3	UN3473	3	328	230	230	230	5 kg	50 kg	A
	Fuel cell cartridges or Fuel cell cartridges contained in equipment or Fuel cell cartridges packed with equipment, containing corrosive substances	2.1	UN3479	2.1	328	230	230	230	1 kg	15 kg	B
	Fuel cell cartridges or Fuel cell cartridges contained in equipment or Fuel cell cartridges packed with equipment, containing hydrogen in metal hydride	2.1	UN3478	2.1	328	230	230	230	1 kg	15 kg	B
	Fuel cell cartridges or Fuel cell cartridges contained in equipment or Fuel cell cartridges packed with equipment, containing liquefied flammable gas	4.3	UN3476	4.3	328	230	230	230	5 kg	50 kg	A 13, 148
	Fuel cell cartridges or Fuel cell cartridges contained in equipment or Fuel cell cartridges packed with equipment, containing water-reactive substances	3	NA1993	III	3	144, B1, IB3, T4, TP1, TP29	150	203	242	60 L	220 L	A

§ 172.101 HAZARDOUS MATERIALS TABLE—Continued

Sym-bols	Hazardous materials descriptions and proper shipping names	Hazard class or Division	Identi-fication Numbers	PG	Label Codes	Special provisions (§ 172.102)	(8)			(9)		(10) Vessel stowage	
							Packaging (§ 173.***)			Quantity limitations (see §§ 173.27 and 175.75)		Loca-tion	Other
							Excep-tions	Non-bulk	Bulk	Passenger aircraft/rail	Cargo air-craft only		
(1)	(2)	(3)	(4)	(5)	(6)	(7)	(8A)	(8B)	(8C)	(9A)	(9B)	(10A)	(10B)
	<i>Fuel system components (including fuel control units (FCU), carburetors, fuel lines, fuel pumps) see Dangerous Goods in Apparatus or Dangerous Goods in Articles or Dangerous Goods in Machinery</i>							
	<i>Fulminate of mercury (dry)</i>	Forbidden											
	<i>Fulminate of mercury, wet, see Mercury fulminate, etc</i>	Forbidden											
	<i>Fulminating gold</i>	Forbidden											
	<i>Fulminating mercury</i>	Forbidden											
	<i>Fulminating platinum</i>	Forbidden											
	<i>Fulminating silver</i>	Forbidden											
	<i>Fulminic acid</i>	Forbidden											
	Fumaryl chloride	8	UN1780	II	8	B2, IB2, T7, TP2	154	202	242	1 L	30 L	C	8, 40, 53, 58
	<i>Fumigated lading, see §§ 172.302(g), 173.9 and 176.76(h)</i>												
	Fumigated transport vehicle or freight container see § 173.9												
	Furaldehydes	6.1	UN1199	II	6.1, 3	IB2, T7, TP2	153	202	243	5 L	60 L	A	
	Furan	3	UN2389	I	3	T12, TP2, TP13	None	201	243	1 L	30 L	E	40
	Furfuryl alcohol	6.1	UN2874	III	6.1	IB3, T4, TP1	153	203	241	60 L	220 L	A	52, 74
	Furfurylamine	3	UN2526	III	3, 8	B1, IB3, T4, TP1	150	203	242	5 L	60 L	A	40, 52
	Fuse, detonating, <i>metal clad, see Cord, detonating, metal clad</i>												
	Fuse, detonating, mild effect, <i>metal clad, see Cord, detonating, mild effect, metal clad</i>												
	Fuse, igniter <i>tubular metal clad</i>	1.4G	UN0103	1.4G	None	62	None	Forbidden	75 kg	02	25
	Fuse, non-detonating <i>instantaneous or quickmatch</i>	1.3G	UN0101	1.3G	None	62	None	Forbidden	Forbidden	03	25
	Fuse, safety	1.4S	UN0105	1.4S	None	62	None	25 kg	100 kg	01	25
D	Fusee (<i>railway or highway</i>)	4.1	NA1325	II	4.1	381	None	184	None	15 kg	50 kg	B	
	Fusel oil	3	UN1201	II	3	IB2, T4, TP1	150	202	242	5 L	60 L	B	
				III	3	B1, IB3, T2, TP1	150	203	242	60 L	220 L	A	

§ 172.101

49 CFR Ch. I (10-1-23 Edition)

	<i>Fuzes, tracer, see Tracers for ammunition</i>													
	<i>Fuzes, combination, percussion and time, see Fuzes, detonating (UN0257, UN0367); Fuzes, igniting (UN0317, UN0368)</i>													
	1.1B	UN0106	1.1B	None	62	None	Forbidden	Forbidden	05	25		
	1.2B	UN0107	1.2B	None	62	None	Forbidden	Forbidden	05	25		
	1.4B	UN0257	1.4B	None	62	None	Forbidden	75 kg	05	25		
	1.4S	UN0367	1.4S	None	62	None	25 kg	100 kg	01	25		
	1.1D	UN0408	1.1D	None	62	None	Forbidden	Forbidden	03	25		
	1.2D	UN0409	1.2D	None	62	None	Forbidden	Forbidden	03	25		
	1.4D	UN0410	1.4D	None	62	None	Forbidden	75 kg	02	25		
	1.3G	UN0316	1.3G	None	62	None	Forbidden	Forbidden	03	25		
	1.4G	UN0317	1.4G	None	62	None	Forbidden	75 kg	02	25		
	1.4S	UN0368	1.4S	None	62	None	25 kg	100 kg	01	25		
	Galactsan trinitrate													
	Forbidden													
	8	UN2803	III	8	T1, TP33	154	162	240	20 kg	20 kg	B	25	
	2.1	UN2037	2.1	306	304	None	1 kg	15 kg	B	40, 157	
D	2.3	NA9035		2.3	6	None	194	None	Forbidden	Forbidden	D		
	3	UN1202	III	3	144, B1, IB3, T2, TP1	150	203	242	60 L	220 L	A		
G	2.1	UN3312		2.1	T75, TP5	None	316	318	Forbidden	Forbidden	D	40	
G	2.2	UN3158		2.2	T75, TP5	320	316	318	50 kg	500 kg	D		
G	2.2	UN3311		2.2, 5.1	T75, TP5, TP22	320	316	318	Forbidden	Forbidden	D		
	2.1	UN3167		2.1		306	302, 304	None	1 L	5 L	D		
	2.3	UN3168		2.3, 2.1		6	306	302	None	Forbidden	1 L	D	
	2.3	UN3169	2.3		6	306	302, 304	None	Forbidden	1 L	D	
	3	UN1203	II	3	144, 177, B1, B33, IB2, T4	150	202	242	5 L	60 L	E		
	<i>Gasoline, casinghead, see Gasoline</i>													
	<i>Gelatine, blasting, see Explosive, blasting, type A</i>													
	<i>Gelatine dynamites, see Explosive, blasting, type A</i>													
	2.3	UN2192		2.3, 2.1		2	None	302	245	Forbidden	Forbidden	D	40

§ 172.101 HAZARDOUS MATERIALS TABLE—Continued

Sym-bols (1)	Hazardous materials descriptions and proper shipping names (2)	Hazard class or Division (3)	Identi-fication Numbers (4)	PG (5)	Label Codes (6)	Special provisions (§ 172.102) (7)	(8)			(9)		(10) Vessel stowage	
							Packaging (§ 173.***)			Quantity limitations (see §§ 173.27 and 175.75)		Loca-tion (10A)	Other (10B)
							Excep-tions (8A)	Non-bulk (8B)	Bulk (8C)	Passenger aircraft/rail (9A)	Cargo air-craft only (9B)		
	Germane, adsorbed	2.3	UN3523	2.3, 2.1	2	None	302c	None	Forbidden	Forbidden	D	40
	<i>Glycerol-1,3-dinitrate</i>	Forbidden											
	<i>Glycerol gluconate trinitrate</i>	Forbidden											
	<i>Glycerol lactate trinitrate</i>	Forbidden											
	<i>Glycerol alpha-monochlorhydrin</i>	6.1	UN2689	III	6.1	IB3, T4, TP1	153	203	241	60 L	220 L	A	
	<i>Glyceryl trinitrate, see Nitroglycerin, etc</i>												
	<i>Glycidaldehyde</i>	3	UN2622	II	3, 6.1	IB2, IP8, T7, TP1	150	202	243	1 L	60 L	A	40
	<i>Grenades, hand or rifle, with burst-ing charge</i>	1.1D	UN0284	1.1D	62	62	None	Forbidden	Forbidden	03	25
	<i>Grenades, hand or rifle, with burst-ing charge</i>	1.2D	UN0285	1.2D	62	62	None	Forbidden	Forbidden	03	25
	<i>Grenades, hand or rifle, with burst-ing charge</i>	1.1F	UN0292	1.1F	62	62	None	Forbidden	Forbidden	03	25
	<i>Grenades, hand or rifle, with burst-ing charge</i>	1.2F	UN0293	1.2F	62	62	None	Forbidden	Forbidden	03	25
	<i>Grenades, illuminating, see Ammu-nition, illuminating, etc</i>												
	<i>Grenades, practice, hand or rifle</i>	1.4S	UN0110	1.4S	62	62	None	25 kg	100 kg	01	25
	<i>Grenades, practice, hand or rifle</i>	1.3G	UN0318	1.3G	62	62	None	Forbidden	Forbidden	03	25
	<i>Grenades, practice, hand or rifle</i>	1.2G	UN0372	1.2G	62	62	None	Forbidden	Forbidden	03	25
	<i>Grenades practice, hand or rifle</i>	1.4G	UN0452	1.4G	62	62	None	Forbidden	75 kg	02	25
	<i>Grenades, smoke, see Ammunition, smoke, etc</i>												
	<i>Guanidine nitrate</i>	5.1	UN1467	III	5.1	A1, IB8, IP3, T1, TP33	152	213	240	25 kg	100 kg	A	73
	<i>Guanyl nitrosaminoguanylidene hy-drazine (dry)</i>	Forbidden											
	<i>Guanyl nitrosaminoguanylidene hy-drazine, wetted with not less than 30 percent water, by mass</i>	1.1A	UN0113	1.1A	111, 117	None	62	None	Forbidden	Forbidden	05	25
	<i>Guanyl nitrosaminoguanyltetrazene (dry)</i>	Forbidden											
	<i>Guanyl nitrosaminoguanyltetrazene, wetted or Tetrazene, wetted with not less than 30 percent water or mixture of alcohol and water, by mass</i>	1.1A	UN0114	1.1A	111, 117	None	62	None	Forbidden	Forbidden	05	25

§ 172.101

49 CFR Ch. I (10-1-23 Edition)

Gunpowder, compressed or Gunpowder in pellets, see Black powder (UN 0028)													
Gunpowder, granular or as a meal, see Black powder (UN 0027)													
Hafnium powder, dry	4.2	UN2545	I	4.2	W31	None	211	242	Forbidden	Forbidden	D	13, 148	
			II	4.2	A19, A20, IB6, IP2, N34, T3, TP33, W31	None	212	241	15 kg	50 kg	D	13, 148	
			III	4.2	B135, IB8, IP21, T1, TP33, W31	None	213	241	25 kg	100 kg	D	13, 148	
Hafnium powder, wetted with not less than 25 percent water (a visible excess of water must be present) (a) mechanically produced, particle size less than 53 microns; (b) chemically produced, particle size less than 840 microns	4.1	UN1326	II	4.1	A6, A19, A20, IB6, IP2, N34, T3, TP33, W31, W40	151	212	241	15 kg	50 kg	E	74	
Hand signal device, see Signal devices, hand													
Hazardous substances, liquid or solid, n.o.s., see Environmentally hazardous substances, etc													
Hazardous waste, liquid, n.o.s.	9	NA3082	III	9	IB3, T2, TP1	155	203	241	No limit	No limit	A		
Hazardous waste, solid, n.o.s.	9	NA3077	III	9	B54, IB8, IP2, T1, TP33	155	213	240	No limit	No limit	A		
Heating oil, light	3	UN1202	III	3	B1, IB3, T2, TP1	150	203	242	60 L	220 L	A		
Helium, compressed	2.2	UN1046	2.2	306, 307	302	302, 314	75 kg	150 kg	A	85	
Helium, refrigerated liquid (cryogenic liquid)	2.2	UN1963		2.2	T75, TP5	320	316	318	50 kg	500 kg	D		
Heptafluoropropane or Refrigerant gas R 227	2.2	UN3296		2.2	T50	306	304	314, 315	75 kg	150 kg	A		
n-Heptaldehyde	3	UN3056	III	3	B1, IB3, T2, TP1	150	203	242	60 L	220 L	A		
Heptanes	3	UN1206	II	3	IB2, T4, TP2	150	202	242	5 L	60 L	B		
n-Heptene	3	UN2278	II	3	IB2, T4, TP1	150	202	242	5 L	60 L	B		
Hexachloroacetone	6.1	UN2661	III	6.1	IB3, T4, TP1	153	203	241	60 L	220 L	B	12, 40	
Hexachlorobenzene	6.1	UN2729	III	6.1	B3, IB8, IP3, T1, TP33	153	203	241	60 L	220 L	A		
Hexachlorobutadiene	6.1	UN2279	III	6.1	IB3, T4, TP1	153	203	241	60 L	220 L	A		
Hexachlorocyclopentadiene	6.1	UN2646	I	6.1	2, B9, B14, B32, B77, T20, TP2, TP13, TP38, TP45	None	227	244	Forbidden	Forbidden	D	25, 40	
Hexachlorophene	6.1	UN2875	III	6.1	IB8, IP3, T1, TP33	153	213	240	100 kg	200 kg	A		
Hexadecyltrichlorosilane	8	UN1781	II	8	A7, B2, B6, N34, T10, TP2, TP7, TP13	None	206	242	Forbidden	30 L	C	40, 53, 58	
Hexadienes	3	UN2458	II	3	IB2, T4, TP1	150	202	242	5 L	60 L	B		
Hexaethyl tetraphosphate and compressed gas mixtures	2.3	UN1612		2.3	3	None	334	None	Forbidden	Forbidden	D	40	
Hexaethyl tetraphosphate, liquid	6.1	UN1611	II	6.1	IB2, N76, T7, TP2	153	202	243	5 L	60 L	E	40	
Hexaethyl tetraphosphate, solid	6.1	UN1611	II	6.1	IB8, IP2, IP4, N76	153	212	242	25 kg	100 kg	E	40	

§ 172.101 HAZARDOUS MATERIALS TABLE—Continued

§ 172.101

49 CFR Ch. I (10-1-23 Edition)

Sym-bols (1)	Hazardous materials descriptions and proper shipping names (2)	Hazard class or Division (3)	Identi-fication Numbers (4)	PG (5)	Label Codes (6)	Special provisions (§ 172.102) (7)	(8)			(9)		(10) Vessel stowage	
							Packaging (§ 173.***)			Quantity limitations (see §§ 173.27 and 175.75)		Loca-tion (10A)	Other (10B)
							Excep-tions (8A)	Non-bulk (8B)	Bulk (8C)	Passenger aircraft/rail (9A)	Cargo air-craft only (9B)		
	Hexafluoroacetone	2.3	UN2420		2.3, 8	2, B9, B14	None	304	314, 315	Forbidden	Forbidden	D	40
	Hexafluoroacetone hydrate, liquid	6.1	UN2552	II	6.1	IB2, T7, TP2	153	202	243	5 L	60 L	B	40
	Hexafluoroacetone hydrate, solid	6.1	UN3436	II	6.1	IB8, IP2, IP4, T3, TP33	153	212	242	25 kg	100 kg	B	40
	Hexafluoroethane, or Refrigerant gas R 116	2.2	UN2193		2.2		306	304	314, 315	75 kg	150 kg	A	
	Hexafluorophosphoric acid	8	UN1782	II	8	A7, B2, IB2, N3, N34, T8, TP2	154	202	242	1 L	30 L	A	53, 58
	Hexafluoropropylene compressed or Refrigerant gas R 1216	2.2	UN1858		2.2	T50	306	304	314, 315	75 kg	150 kg	A	
	Hexaldehyde	3	UN1207	III	3	B1, IB3, T2, TP1	150	203	242	60 L	220 L	A	
	Hexamethylene diisocyanate	6.1	UN2281	II	6.1	IB2, T7, TP2, TP13	153	202	243	5 L	60 L	C	13, 40
	Hexamethylene triperoxide diamine (dry)	Forbidden											
	Hexamethylenediamine, solid	8	UN2280	III	8	IB8, IP3, T1, TP33	154	213	240	25 kg	100 kg	A	12, 25, 52
	Hexamethylenediamine solution	8	UN1783	II	8	IB2, T7, TP2	154	202	242	1 L	30 L	A	52
				III	8	IB3, T4, TP1	154	203	241	5 L	60 L	A	52
	Hexamethylenimine	3	UN2493	II	3, 8	IB2, T7, TP1	150	202	243	1 L	5 L	B	40
	Hexamethylenetetramine	4.1	UN1328	III	4.1	A1, IB8, IP3, T1, TP33	151	213	240	25 kg	100 kg	A	
	Hexamethylol benzene hexanitrate	Forbidden											
	Hexanes	3	UN1208	II	3	IB2, T4, TP2	150	202	242	5 L	60 L	E	
	2,2',4,4',6,6'-Hexanitro-3,3'-dihydroxyazobenzene (dry)	Forbidden											
	Hexanitroazoxy benzene	Forbidden											
	N,N-(hexanitrodiphenyl) ethylene dinitramine (dry)	Forbidden											
	Hexanitrodiphenyl urea	Forbidden											
	2,2',3,4,4',6'-Hexanitrodiphenylamine	Forbidden											
	Hexanitrodiphenylamine or Dipicrylamine or Hexyl 2,3',4,4',6,6'-Hexanitrodiphenylether	1.1D	UN0079	1.1D	None	62	None	Forbidden	Forbidden	04	25
	Hexanitroethane	Forbidden											
	Hexanitrooxanilide	Forbidden											
	Hexanitrostilbene	1.1D	UN0392	1.1D	None	62	None	Forbidden	Forbidden	04	25
	Hexanoic acid, see Corrosive liq-uids, n.o.s.												

234

Hexanols	3	UN2282	III	3	B1, IB3, T2, TP1	150	203	242	60 L	220 L	A	74
1-Hexene	3	UN2370	II	3	IB2, T4, TP1	150	202	242	5 L	60 L	E	
Hexogen and cyclotetramethylenetetranitramine mixtures, wetted or desensitized see RDX and HMX mixtures, wetted or desensitized etc												
Hexogen and HMX mixtures, wetted or desensitized see RDX and HMX mixtures, wetted or desensitized etc												
Hexogen and octogen mixtures, wetted or desensitized see RDX and HMX mixtures, wetted or desensitized etc												
Hexogen, see Cyclotrimethylenetrinitramine, etc												
Hexolite, or Hexotol dry or wetted with less than 15 percent water, by mass	1.1D	UN0118	1.1D	None	62	None	Forbidden	Forbidden	04	25
Hexotonal	1.1D	UN0393	1.1D	None	62	None	Forbidden	Forbidden	04	25
Hexyl, see Hexanitrodiphenylamine												
Hexyltrichlorosilane	8	UN1784	II	8	A7, B2, B6, N34, T10, TP2, TP7, TP13	None	206	242	Forbidden	30 L	C	40, 53, 58
<i>High explosives, see individual explosives' entries</i>												
HMX, see Cyclotetramethylenetetranitramine, etc												
Hydrazine, anhydrous	8	UN2029	I	8, 3, 6.1	A7, A10, B7, B16, B53	None	201	243	Forbidden	2.5 L	D	40, 52, 125, 52.
Hydrazine, aqueous solution, with not more than 37 percent hydrazine, by mass	6.1	UN3293	III	6.1	IB3, T4, TP1	153	203	241	60 L	220 L	A	
Hydrazine aqueous solution, flammable with more than 37% hydrazine, by mass	8	UN3484	I	8, 3, 6.1	B16, B53, T10, TP2, TP13	None	201	243	Forbidden	2.5 L	D	40, 52, 125
Hydrazine aqueous solution, with more than 37% hydrazine, by mass	8	UN2030	I	8, 6.1	B16, B53, T10, TP2, TP13	None	201	243	Forbidden	2.5 L	D	40, 52
			II	8, 6.1	B16, B53, IB2, T7, TP2, TP13	154	202	243	Forbidden	30 L	D	40, 52
			III	8, 6.1	B16, B53, IB3, T4, TP1	154	203	241	5 L	60 L	D	40, 52
Hydrazine azide	Forbidden											
Hydrazine chlorate	Forbidden											
Hydrazine dicarbonic acid diazide	Forbidden											
Hydrazine perchlorate	Forbidden											
Hydrazine selenate	Forbidden											
Hydriodic acid, anhydrous, see Hydrogen iodide, anhydrous												

§ 172.101 HAZARDOUS MATERIALS TABLE—Continued

Sym-bols	Hazardous materials descriptions and proper shipping names	Hazard class or Division	Identi-fication Numbers	PG	Label Codes	Special provisions (§ 172.102)	(8)			(9)		(10) Vessel stowage	
							Packaging (§ 173.***)			Quantity limitations (see §§ 173.27 and 175.75)		Loca-tion	Other
							Excep-tions	Non-bulk	Bulk	Passenger aircraft/rail	Cargo air-craft only		
(1)	(2)	(3)	(4)	(5)	(6)	(7)	(8A)	(8B)	(8C)	(9A)	(9B)	(10A)	(10B)
D	Hydriodic acid	8	UN1787	II	8	A3, B2, IB2, N41, T7, TP2	154	202	242	1 L	30 L	C	
				III	8	IB3, T4, TP1	154	203	241	5 L	60 L	C	8
	<i>Hydrobromic acid, anhydrous, see Hydrogen bromide, anhydrous</i>	8	UN1788	II	8	B2, B15, IB2, N41, T7, TP2	154	202	242	Forbidden	Forbidden	C	53, 58
	<i>Hydrobromic acid, with more than 49 percent hydrobromic acid</i>			III	8	IB3, T4, TP1	154	203	241	Forbidden	Forbidden	C	8, 53, 58
	<i>Hydrobromic acid, with not more than 49 percent hydrobromic acid</i>	8	UN1788	II	8	A3, B2, B15, IB2, N41, T7, TP2	154	202	242	1 L	30 L	C	53, 58
				III	8	A3, IB3, T4, TP1	154	203	241	5 L	60 L	C	8, 53, 58
	Hydrocarbon gas mixture, compressed, n.o.s.	2.1	UN1964		2.1		306	302	314, 315	Forbidden	150 kg	E	40
	Hydrocarbon gas mixture, liquefied, n.o.s.	2.1	UN1965		2.1	T50	306	304	314, 315	Forbidden	150 kg	E	40
	Hydrocarbons, liquid, n.o.s.	3	UN3295	I	3	144, T11, TP1, TP8, TP28	150	201	243	1 L	30 L	E	
				II	3	144, IB2, T7, TP1, TP8, TP28	150	202	242	5 L	60 L	B	
				III	3	144, B1, IB3, T4, TP1, TP29	150	203	242	60 L	220 L	A	
	<i>Hydrochloric acid, anhydrous, see Hydrogen chloride, anhydrous</i>	8	UN1789	II	8	386, A3, B3, B15, B133, IB2, N41, T8, TP2	154	202	242	1 L	30 L	C	53, 58
	<i>Hydrochloric acid</i>			III	8	A3, IB3, T4, TP1	154	203	241	5 L	60 L	C	8, 53, 58
	<i>Hydrocyanic acid, anhydrous, see Hydrogen cyanide etc</i>	6.1	UN1613	I	6.1	2, B61, B65, B77, B82, T20, TP2, TP13	None	195	244	Forbidden	Forbidden	D	40
	<i>Hydrocyanic acid, aqueous solutions or Hydrogen cyanide, aqueous solutions with not more than 20 percent hydrogen cyanide</i>												
<i>Hydrocyanic acid, aqueous solutions with less than 5 percent hydrogen cyanide</i>	6.1	NA1613	II	6.1	IB1, T14, TP2, TP13, TP27	None	195	243	Forbidden	5 L	D	40	

§ 172.101

49 CFR Ch. I (10-1-23 Edition)

<i>Hydrocyanic acid, liquefied, see Hydrogen cyanide, etc</i>													
<i>Hydrocyanic acid (prussic), unstabilized</i>	Forbidden												
Hydrofluoric acid and Sulfuric acid mixtures	8	UN1786	I	8, 6.1	A7, B15, B23, N5, N34, T10, TP2, TP13	None	201	243	Forbidden	2.5 L	D	40, 53, 58	
<i>Hydrofluoric acid, anhydrous, see Hydrogen fluoride, anhydrous</i>													
Hydrofluoric acid, with more than 60 percent strength	8	UN1790	I	8, 6.1	A7, B4, B15, B23, N5, N34, T10, TP2, TP13	None	201	243	0.5 L	2.5 L	D	12, 25, 40, 53, 58	
Hydrofluoric acid, with not more than 60 percent strength	8	UN1790	II	8, 6.1	A7, B15, IB2, N5, N34, T8, TP2	154	202	243	1 L	30 L	D	12, 25, 40, 53, 58	
<i>Hydrofluoroboric acid, see Fluoroboric acid</i>													
<i>Hydrofluorosilicic acid, see Fluorosilicic acid</i>													
Hydrogen and Methane mixtures, compressed	2.1	UN2034		2.1		N89	306	302	302, 314, 315	Forbidden	150 kg	E	40, 57
Hydrogen bromide, anhydrous	2.3	UN1048		2.3, 8		3, B14, N86, N89	None	304	314, 315	Forbidden	Forbidden	D	40
Hydrogen chloride, anhydrous	2.3	UN1050		2.3, 8		3, N86, N89	None	304	None	Forbidden	Forbidden	D	40
Hydrogen chloride, refrigerated liquid	2.3	UN2186		2.3, 8		3, B6	None	None	314, 315	Forbidden	Forbidden	B	40
Hydrogen, compressed	2.1	UN1049		2.1		N89	306	302	302, 314	Forbidden	150 kg	E	40, 57
Hydrogen cyanide, solution in alcohol with not more than 45 percent hydrogen cyanide	6.1	UN3294	I	6.1, 3		2, B9, B14, B32, T20, TP2, TP13, TP38, TP45	None	227	244	Forbidden	Forbidden	D	40
Hydrogen cyanide, stabilized with less than 3 percent water	6.1	UN1051	I	6.1, 3		1, 387, B35, B61, B65, B77, B82	None	195	244	Forbidden	Forbidden	D	25, 40
Hydrogen cyanide, stabilized, with less than 3 percent water and absorbed in a porous inert material	6.1	UN1614	I	6.1		5, 387	None	195	None	Forbidden	Forbidden	D	25, 40
Hydrogen fluoride, anhydrous	8	UN1052	I	8.6.1		3, B7, B46, B77, N86, T10, TP2	None	163	244	Forbidden	Forbidden	D	40, 53, 58
Hydrogen in a metal hydride storage system or Hydrogen in a metal hydride storage system contained in equipment or Hydrogen in a metal hydride storage system packed with equipment	2.1	UN3468	2.1		167	None	311	None	Forbidden	100 kg	D	
Hydrogen iodide, anhydrous	2.3	UN2197		2.3, 8		3, B14, N86, N89	None	304	314, 315	Forbidden	Forbidden	D	40
<i>Hydrogen iodide solution, see Hydriodic acid</i>													

§ 172.101 HAZARDOUS MATERIALS TABLE—Continued

Sym-bols (1)	Hazardous materials descriptions and proper shipping names (2)	Hazard class or Division (3)	Identi-fication Numbers (4)	PG (5)	Label Codes (6)	Special provisions (§ 172.102) (7)	(8)			(9)		(10) Vessel stowage		
							Packaging (§ 173.***)			Quantity limitations (see §§ 173.27 and 175.75)		Loca-tion (10A)	Other (10B)	
							Excep-tions (8A)	Non-bulk (8B)	Bulk (8C)	Passenger aircraft/rail (9A)	Cargo air-craft only (9B)			
	Hydrogen peroxide and peroxy-acetic acid mixtures, stabilized with acids, water, and not more than 5 percent peroxyacetic acid	5.1	UN3149	II	5.1, 8	145, A2, A3, B53, IB2, IP5, T7, TP2, TP6, TP24	152	202	243	1 L	5 L	D	25, 66, 75	
	Hydrogen peroxide, aqueous solutions with more than 40 percent but not more than 60 percent hydrogen peroxide (stabilized as necessary)	5.1	UN2014	II	5.1, 8	12, A60, B53, B80, B81, B85, IB2, IP5, T7, TP2, TP6, TP24, TP37	152	202	243	Forbidden	Forbidden	D	25, 66, 75	
	Hydrogen peroxide, aqueous solutions with not less than 20 percent but not more than 40 percent hydrogen peroxide (stabilized as necessary)	5.1	UN2014	II	5.1, 8	A2, A3, B53, IB2, IP5, T7, TP2, TP6, TP24, TP37	152	202	243	1 L	5 L	D	25, 66, 75	
	Hydrogen, peroxide, aqueous solutions with not less than 8 percent but less than 20 percent hydrogen peroxide (stabilized as necessary)	5.1	UN2984	III	5.1	A1, IB2, IP5, T4, TP1, TP6, TP24, TP37	152	203	241	2.5 L	30 L	B	25, 66, 75	
	Hydrogen peroxide, stabilized or Hydrogen peroxide aqueous solutions, stabilized with more than 60 percent hydrogen peroxide	5.1	UN2015	I	5.1, 8	12, B53, B80, B81, B85, T9, TP2, TP6, TP24, TP37	None	201	243	Forbidden	Forbidden	D	25, 66, 75.	
	Hydrogen, refrigerated liquid (cryogenic liquid)	2.1	UN1966	2.1	T75, TP5	None	316	318, 319	Forbidden	Forbidden	D	40, 57	
	Hydrogen selenide, adsorbed	2.3	UN3526	2.3, 2.1		1	None	302c	None	Forbidden	Forbidden	D	40
	Hydrogen selenide, anhydrous	2.3	UN2202		2.3, 2.1		1	None	192	245	Forbidden	Forbidden	D	40
	Hydrogen sulfate, see Sulfuric acid Hydrogen sulfide	2.3	UN1053		2.3, 2.1	2, B9, B14, N89	None	304	314, 315	Forbidden	Forbidden	D	40	
	Hydrogendifluoride, solid, n.o.s.	8	UN1740	II	8	IB8, IP2, IP4, N3, N34, T3, TP33	154	212	240	15 kg	50 kg	A	25, 40, 52, 53, 58	

§ 172.101

49 CFR Ch. I (10-1-23 Edition)

§ 172.101 HAZARDOUS MATERIALS TABLE—Continued

Sym-bols	Hazardous materials descriptions and proper shipping names	Hazard class or Division	Identi-fication Numbers	PG	Label Codes	Special provisions (§ 172.102)	(8)			(9)		(10) Vessel stowage	
							Packaging (§ 173.***)			Quantity limitations (see §§ 173.27 and 175.75)		Loca-tion	Other
							Excep-tions	Non-bulk	Bulk	Passenger aircraft/rail	Cargo air-craft only		
(1)	(2)	(3)	(4)	(5)	(6)	(7)	(8A)	(8B)	(8C)	(9A)	(9B)	(10A)	(10B)
G	Insecticide gases, toxic, flammable, n.o.s. <i>Inhalation hazard Zone C</i>	2.3	UN3355		2.3, 2.1	3, B14	None	302, 305	314, 315	Forbidden	Forbidden	D	
G	Insecticide gases, toxic, flammable, n.o.s. <i>Inhalation hazard Zone D</i>	2.3	UN3355		2.3, 2.1	4	None	302, 305	314, 315	Forbidden	Forbidden	D	
G	Insecticide gases, toxic, n.o.s. <i>Inulin trinitrate (dry)</i>	2.3	UN1967		2.3	3	None	193, 334	245	Forbidden	Forbidden	D	40
+	Iodine	Forbidden	UN3495	III	8, 6.1	IB8, IP3, T1, TP33	154	213	240	25 kg	100 kg	B	40, 55
	<i>Iodine azide (dry)</i>	Forbidden	UN3498	II	8	IB2, T7, TP2	154	202	242	1 L	30 L	D	40, 53, 58, 66, 74, 89, 90
	Iodine monochloride, liquid	8	UN3498	II	8	IB2, T7, TP2	154	202	242	1 L	30 L	D	40, 53, 58, 66, 74, 89, 90
	Iodine monochloride, solid	8	UN1792	II	8	B6, IB8, IP2, IP4, N41, T7, TP2	154	212	240	Forbidden	50 kg	D	40, 53, 58, 66, 74, 89, 90
	Iodine pentafluoride	5.1	UN2495	I	5.1, 6.1, 8	None	205	243	Forbidden	Forbidden	D	25, 40, 52, 53, 58, 66, 90
	2-Iodobutane	3	UN2390	II	3	IB2, T4, TP1	150	202	242	5 L	60 L	B	
	Iodomethylpropanes	3	UN2391	II	3	IB2, T4, TP1	150	202	242	5 L	60 L	B	
	Iodopropanes	3	UN2392	III	3	B1, IB3, T2, TP1	150	203	242	60 L	220 L	A	
	<i>Iodoxy compounds (dry)</i>	Forbidden											
	<i>Iridium nitratopentamine iridium nitrate</i>	Forbidden											
	<i>Iron chloride, see Ferric chloride</i>												
	<i>Iron oxide, spent, or Iron sponge, spent obtained from coal gas purification</i>	4.2	UN1376	III	4.2	B18, B134, IB8, IP21, T1, TP33, W100	None	213	240	Forbidden	Forbidden	E	13, 148
	<i>Iron pentacarbonyl</i>	6.1	UN1994	I	6.1, 3	1, B9, B14, B30, B77, T22, TP2, TP13, TP38, TP44	None	226	244	Forbidden	Forbidden	D	40
	<i>Iron sesquichloride, see Ferric chloride</i>												
	<i>Irritating material, see Tear gas substances, etc</i>												
	<i>Isobutane see also Petroleum gases, liquefied</i>	2.1	UN1969		2.1	19, T50	306	304	314, 315	Forbidden	150 kg	E	40

§ 172.101

49 CFR Ch. I (10-1-23 Edition)

	Isobutanol or Isobutyl alcohol	3	UN1212	III	3	B1, IB3, T2, TP1	150	203	242	60 L	220 L	A	
	Isobutyl acetate	3	UN1213	II	3	IB2, T4, TP1	150	202	242	5 L	60 L	B	
	Isobutyl acrylate, stabilized	3	UN2527	III	3	387, B1, IB3, T2, TP1	150	203	242	60 L	220 L	C	25
	Isobutyl alcohol, <i>see</i> Isobutanol												
	Isobutyl aldehyde, <i>see</i> Isobutyraldehyde												
	Isobutyl formate	3	UN2393	II	3	IB2, T4, TP1	150	202	242	5 L	60 L	B	
	Isobutyl isobutyrate	3	UN2528	III	3	B1, IB3, T2, TP1	150	203	242	60 L	220 L	A	
+	Isobutyl isocyanate	6.1	UN2486	I	6.1, 3	1, B9, B14, B30, TP0, TP2, TP13, TP27	None	226	244	Forbidden	Forbidden	D	40
	Isobutyl methacrylate, stabilized	3	UN2283	III	3	387, B1, IB3, T2, TP1	150	203	242	60 L	220 L	C	25
	Isobutyl propionate	3	UN2394	III	3	B1, IB3, T2, TP1	150	203	242	60 L	220 L	B	
	Isobutylamine	3	UN1214	II	3, 8	IB2, T7, TP1	150	202	243	1 L	5 L	B	40, 52
	Isobutylene <i>see also</i> Petroleum gases, liquefied	2.1	UN1055		2.1	19, T50	306	304	314, 315	Forbidden	150 kg	E	40
	Isobutyraldehyde or Isobutyl aldehyde	3	UN2045	II	3	IB2, T4, TP1	150	202	242	5 L	60 L	E	40
	Isobutyric acid	3	UN2529	III	3, 8	B1, IB3, T4, TP1	150	203	242	5 L	60 L	A	
	Isobutyronitrile	3	UN2284	II	3, 6.1	IB2, T7, TP2, TP13	150	202	243	1 L	60 L	E	40
	Isobutryl chloride	3	UN2395	II	3, 8	IB1, T7, TP2	150	202	243	1 L	5 L	C	40, 53, 58
G	Isocyanates, flammable, toxic, n.o.s. or Isocyanate solutions, flammable, toxic, n.o.s. <i>flash point less than 23 degrees C</i>	3	UN2478	II	3, 6.1	5, A3, A7, IB2, T11, TP2, TP13, TP27, W31	150	202	243	1 L	60 L	D	40
				III	3, 6.1	5, A3, A7, IB3, T7, TP1, TP13, TP28, W31	150	203	242	60 L	220 L	A	
G	Isocyanates, toxic, flammable, n.o.s. or Isocyanate solutions, toxic, flammable, n.o.s., <i>flash point not less than 23 degrees C but not more than 61 degrees C and boiling point less than 300 degrees C</i>	6.1	UN3080	II	6.1, 3	IB2, T11, TP2, TP13, TP27	153	202	243	5 L	60 L	B	25, 40
G	Isocyanates, toxic, n.o.s. or Isocyanate solutions, toxic, n.o.s., <i>flash point more than 61 degrees C and boiling point less than 300 degrees C</i>	6.1	UN2206	II	6.1	IB2, T11, TP2, TP13, TP27	153	202	243	5 L	60 L	E	25, 40
				III	6.1	IB3, T7, TP1, TP13, TP28	153	203	241	60 L	220 L	E	25, 40
	Isocyanatobenzotrifluorides	6.1	UN2285	II	6.1, 3	5, IB2, T7, TP2	153	202	243	5 L	60 L	D	25, 40
	Isoheptenes	3	UN2287	II	3	IB2, T4, TP1	150	202	242	5 L	60 L	B	
	Isohexenes	3	UN2288	II	3	IB2, IP8, T11, TP1	150	202	242	5 L	60 L	E	
	Isooctane, <i>see</i> Octanes												
	Isooctenes	3	UN1216	II	3	IB2, T4, TP1	150	202	242	5 L	60 L	B	
	Isopentane, <i>see</i> Pentane												
	Isopentanoic acid, <i>see</i> Corrosive liquids, n.o.s.												
	Isopentenes	3	UN2371	I	3	T11, TP2	150	201	243	1 L	30 L	E	

§ 172.101 HAZARDOUS MATERIALS TABLE—Continued

Sym-bols	Hazardous materials descriptions and proper shipping names	Hazard class or Division	Identi-fication Numbers	PG	Label Codes	Special provisions (§ 172.102)	(8)			(9)		(10) Vessel stowage	
							Packaging (§ 173.***)			Quantity limitations (see §§ 173.27 and 175.75)		Loca-tion	Other
							Excep-tions	Non-bulk	Bulk	Passenger aircraft/rail	Cargo air-craft only		
(1)	(2)	(3)	(4)	(5)	(6)	(7)	(8A)	(8B)	(8C)	(9A)	(9B)	(10A)	(10B)
	Isophorone diisocyanate	6.1	UN2290	III	6.1	IB3, T4, TP2	153	203	241	60 L	220 L	B	40
	Isophoronediamine	8	UN2289	III	8	IB3, T4, TP1	154	203	241	5 L	60 L	A	52
	Isoprene, stabilized	3	UN1218	I	3	387, T11, TP2	150	201	243	1 L	30 L	D	25
	Isopropanol or Isopropyl alcohol	3	UN1219	II	3	IB2, T4, TP1	4b, 150	202	242	5 L	60 L	B	
	Isopropenyl acetate	3	UN2403	II	3	IB2, T4, TP1	150	202	242	5 L	60 L	B	
	Isopropenylbenzene	3	UN2303	III	3	B1, IB3, T2, TP1	150	203	242	60 L	220 L	A	
	Isopropyl acetate	3	UN1220	II	3	IB2, T4, TP1	150	202	242	5 L	60 L	B	
	Isopropyl acid phosphate	8	UN1793	III	8	IB2, T4, TP1	154	213	240	25 kg	100 kg	A	53, 58
	Isopropyl alcohol, see Isopropanol												
	Isopropyl butyrate	3	UN2405	III	3	B1, IB3, T2, TP1	150	203	242	60 L	220 L	A	
	Isopropyl chloroacetate	3	UN2947	III	3	B1, IB3, T2, TP1	150	203	242	60 L	220 L	A	
	Isopropyl chloroformate	6.1	UN2407	I	6.1, 3, 8	2, B9, B14, B32, B77, T20, TP2, TP13, TP38, TP44	None	227	244	Forbidden	Forbidden	B	21, 40, 53, 58, 100
	Isopropyl 2-chloropropionate	3	UN2934	III	3	B1, IB3, T2, TP1	150	203	242	60 L	220 L	A	
	Isopropyl isobutyrate	3	UN2406	II	3	IB2, T4, TP1	150	202	242	5 L	60 L	B	
+	Isopropyl isocyanate	6.1	UN2483	I	6.1, 3	1, B9, B14, B30, T20, TP2, TP13, TP38, TP44	None	226	244	Forbidden	Forbidden	D	40
	<i>Isopropyl mercaptan, see Propanethiols</i>												
	Isopropyl nitrate	3	UN1222	II	3	IB9	150	202	None	5 L	60 L	D	
	<i>Isopropyl phosphoric acid, see Isopropyl acid phosphate</i>												
	Isopropyl propionate	3	UN2409	II	3	IB2, T4, TP1	150	202	242	5 L	60 L	B	
	Isopropylamine	3	UN1221	I	3, 8	T11, TP2	None	201	243	0.5 L	2.5 L	E	52
	Isopropylbenzene	3	UN1918	III	3	B1, IB3, T2, TP1	150	203	242	60 L	220 L	A	
	<i>Isopropylcumyl hydroperoxide, with more than 72 percent in solution</i>	Forbidden											
	<i>Isosorbide dinitrate mixture with not less than 60 percent lactose, mannose, starch or calcium hydrogen phosphate</i>	4.1	UN2907	II	4.1	IB6, IP2, N85	None	212	None	15 kg	50 kg	E	28, 36
	Isosorbide-5-mononitrate	4.1	UN3251	III	4.1	66, 159, IB8	151	223	240	Forbidden	Forbidden	D	12, 25, 40, 84
	<i>Isothiocyanic acid</i>	Forbidden											
	<i>Jet fuel, see Fuel aviation, turbine engine</i>												

§ 172.101

49 CFR Ch. I (10-1-23 Edition)

D	Jet perforating guns, charged <i>oil well with detonator</i>	1.1D	NA0124	1.1D		55, 56	None	62	None	Forbidden	Forbidden	03	25, 154
D	Jet perforating guns, charged <i>oil well, with detonator</i>	1.4D	NA0494	1.4D		55, 56	None	62	None	Forbidden	Forbidden	02	25, 154
	Jet perforating guns, charged, <i>oil well, without detonator</i>	1.4D	UN0494	1.4D		55, 114	None	62	None	Forbidden	300 kg	02	25, 154
	Jet perforating guns, charged <i>oil well without detonator</i>	1.1D	UN0124	1.1D		55	None	62	None	Forbidden	Forbidden	03	25, 154
	<i>Jet perforators, see Charges, shaped, etc</i>													
	<i>Jet tappers, without detonator, see Charges, shaped, etc</i>													
	<i>Jet thrust igniters, for rocket motors or Jato, see Igniters</i>													
	<i>Jet thrust unit (Jato), see Rocket motors</i>													
G	Kerosene	3	UN1223		III 3		144, B1, IB3, T2, TP2	150	203	242	60 L	220 L	A	
	Ketones, liquid, n.o.s.	3	UN1224		I 3		T11, TP1, TP8, TP27	None	201	243	1 L	30 L	E	
					II 3		IB2, T7, TP1, TP8, TP28	150	202	242	5 L	60 L	B	
					III 3		B1, IB3, T4, TP1, TP29	150	203	242	60 L	220 L	A	
	Krill meal	4.2	UN3497		II 4.2		155, IB6, IP2, T3, TP33	None	212	242	15 kg	50 kg	B	25, 88, 128
					III 4.2		155, IB8, IP3, T1, TP33	None	213	242	25 kg	100 kg	A	128
	Krypton, compressed	2.2	UN1056	2.2		306, 307	302	None	75 kg	150 kg	A
	Krypton, refrigerated liquid (<i>cryogenic liquid</i>)	2.2	UN1970		2.2		T75, TP5	320	None	None	50 kg	500 kg	D	
	<i>Lacquer base or lacquer chips, nitrocellulose, dry, see Nitrocellulose, etc. (UN 2557)</i>													
	<i>Lacquer base or lacquer chips, plastic, wet with alcohol or solvent, see Nitrocellulose (UN2059, UN2555, UN2556, UN2557) or Paint etc. (UN1263)</i>													
	Lead acetate	6.1	UN1616		III 6.1		IB8, IP3, T1, TP33	153	213	240	100 kg	200 kg	A	
	Lead arsenates	6.1	UN1617		II 6.1		IB8, IP2, IP4, T3, TP33	153	212	242	25 kg	100 kg	A	
	Lead arsenites	6.1	UN1618		II 6.1		IB8, IP2, IP4, T3, TP33	153	212	242	25 kg	100 kg	A	
	<i>Lead azide (dry)</i>	Forbidden												
	<i>Lead azide, wetted with not less than 20 percent water or mixture of alcohol and water, by mass</i>	1.1A	UN0129	1.1A		111, 117	None	62	None	Forbidden	Forbidden	05	25
G	Lead compounds, soluble, n.o.s	6.1	UN2291		III 6.1		138, IB8, IP3, T1, TP33	153	213	240	100 kg	200 kg	A	
	Lead cyanide	6.1	UN1620		II 6.1		IB8, IP2, IP4, T3, TP33	153	212	242	25 kg	100 kg	A	52
	Lead dioxide	5.1	UN1872		III 5.1		A1, IB8, IP3, T1, TP33	152	213	240	25 kg	100 kg	A	
	<i>Lead dross, see Lead sulfate, with more than 3 percent free acid</i>													
	Lead nitrate	5.1	UN1469		II 5.1, 6.1		IB8, IP2, IP4, T3, TP33	152	212	242	5 kg	25 kg	A	
	<i>Lead nitroresorcinate (dry)</i>	Forbidden												

§ 172.101 HAZARDOUS MATERIALS TABLE—Continued

Sym-bols (1)	Hazardous materials descriptions and proper shipping names (2)	Hazard class or Division (3)	Identi-fication Numbers (4)	PG (5)	Label Codes (6)	Special provisions (§ 172.102) (7)	(8)			(9)		(10) Vessel stowage	
							Packaging (§ 173.***)			Quantity limitations (see §§ 173.27 and 175.75)		Loca-tion (10A)	Other (10B)
							Excep-tions (8A)	Non-bulk (8B)	Bulk (8C)	Passenger aircraft/rail (9A)	Cargo air-craft only (9B)		
	Lead perchlorate, solid	5.1	UN1470	II	5.1, 6.1	IB6, IP2, T3, TP33	152	212	242	5 kg	25 kg	A	56, 58
	Lead perchlorate, solution	5.1	UN3408	II	5.1, 6.1	IB2, T4, TP1	152	202	243	1 L	5 L	A	56, 58
				III	5.1, 6.1	IB2, T4, TP1	152	203	242	2.5 L	30 L	A	56, 58
	<i>Lead peroxide, see Lead dioxide</i>												
	Lead phosphite, dibasic	4.1	UN2989	II	4.1	IB8, IP2, IP4, T3, TP33	151	212	240	15 kg	50 kg	B	34
	<i>Lead picrate (dry)</i>			III	4.1	IB8, IP3, T1, TP33	151	213	240	25 kg	100 kg	B	34
	<i>Lead styphnate (dry)</i>	Forbidden											
	Lead styphnate, wetted or Lead trinitroresorcinate, wetted with not less than 20 percent water or mixture of alcohol and water, by mass	1.1A	UN0130	1.1A	111, 117	None	62	None	Forbidden	Forbidden	05	25
	Lead sulfate with more than 3 percent free acid	8	UN1794	II	8	IB8, IP2, IP4, T3, TP33	154	212	240	15 kg	50 kg	A	53, 58
	Lead trinitroresorcinate, see Lead styphnate, etc												
	Life-saving appliances, not self inflating containing dangerous goods as equipment	9	UN3072	None	182	None	219	None	No limit	No limit	A	122
	Life-saving appliances, self inflating	9	UN2990	None	338	None	219	None	No limit	No limit	A	122
	Lighters containing flammable gas	2.1	UN1057	2.1	168	21,308	21,308	None	1 kg	15 kg	B	40
	Lighters, new or empty, purged of all residual fuel and vapors					168							
	Lighters, non-pressurized, containing flammable liquid,	3	NA1057	II	3	168	21	None	None	Forbidden	Forbidden	B	40
	Lighter refills containing flammable gas not exceeding 4 fluid ounces (7.22 cubic inches) and 65 grams of flammable gas	2.1	UN1057		2.1	169	306	306	None	1 kg	15 kg	B	40
	Lighter replacement cartridges containing liquefied petroleum gases see Lighter refills containing flammable gas. Etc.												
	Lighters, fuse	1.4S	UN0131	1.4S	None	62	None	25 kg	100 kg	01	25

§ 172.101

49 CFR Ch. I (10-1-23 Edition)

G	Lime, unslaked, see Calcium oxide Liquefied gas, flammable, n.o.s.	2.1	UN3161	2.1	T50	306	304	314, 315	Forbidden	150 kg	D	40	
G	Liquefied gas, n.o.s.	2.2	UN3163	2.2	T50	306	304	314, 315	75 kg	150 kg	A		
G	Liquefied gas, oxidizing, n.o.s.	2.2	UN3157	2.2, 5.1	A14	306	304	314, 315	75 kg	150 kg	D		
G I	Liquefied gas, toxic, corrosive, n.o.s. <i>Inhalation Hazard Zone A</i>	2.3	UN3308	2.3, 8		1	None	192	245	Forbidden	Forbidden	D	40
G I	Liquefied gas, toxic, corrosive, n.o.s. <i>Inhalation Hazard Zone B</i>	2.3	UN3308	2.3, 8	2, B9, B14		None	304	314, 315	Forbidden	Forbidden	D	40
G I	Liquefied gas, toxic, corrosive, n.o.s. <i>Inhalation Hazard Zone C</i>	2.3	UN3308	2.3, 8	3, B14		None	304	314, 315	Forbidden	Forbidden	D	40
G I	Liquefied gas, toxic, corrosive, n.o.s. <i>Inhalation Hazard Zone D</i>	2.3	UN3308	2.3, 8		4	None	304	314, 315	Forbidden	Forbidden	D	40
G I	Liquefied gas, toxic, flammable, cor- rosive, n.o.s. <i>Inhalation Hazard Zone A</i>	2.3	UN3309	2.3, 2.1, 8		1	None	192	245	Forbidden	Forbidden	D	17, 40
G I	Liquefied gas toxic, flammable, cor- rosive, n.o.s. <i>Inhalation Hazard Zone B</i>	2.3	UN3309	2.3, 2.1, 8	2, B9, B14		None	304	314, 315	Forbidden	Forbidden	D	17, 40
G I	Liquefied gas, toxic, flammable, cor- rosive, n.o.s. <i>Inhalation Hazard Zone C</i>	2.3	UN3309	2.3, 2.1, 8	3, B14		None	304	314, 315	Forbidden	Forbidden	D	17, 40
G I	Liquefied gas, toxic, flammable, cor- rosive, n.o.s. <i>Inhalation Hazard Zone D</i>	2.3	UN3309	2.3, 2.1, 8		4	None	304	314, 315	Forbidden	Forbidden	D	17, 40
G	Liquefied gas, toxic, flammable, n.o.s. <i>Inhalation Hazard Zone A</i>	2.3	UN3160	2.3, 2.1		1	None	192	245	Forbidden	Forbidden	D	40
G	Liquefied gas, toxic, flammable, n.o.s. <i>Inhalation Hazard Zone B</i>	2.3	UN3160	2.3, 2.1	2, B9, B14		None	304	314, 315	Forbidden	Forbidden	D	40
G	Liquefied gas, toxic, flammable, n.o.s. <i>Inhalation Hazard Zone C</i>	2.3	UN3160	2.3, 2.1	3, B14		None	304	314, 315	Forbidden	Forbidden	D	40
G	Liquefied gas, toxic, flammable, n.o.s. <i>Inhalation Hazard Zone D</i>	2.3	UN3160	2.3, 2.1		4	None	304	314, 315	Forbidden	Forbidden	D	40
G	Liquefied gas, toxic, n.o.s. <i>Inhalation Hazard Zone A</i>	2.3	UN3162	2.3		1	None	192	245	Forbidden	Forbidden	D	40
G	Liquefied gas, toxic, n.o.s. <i>Inhalation Hazard Zone B</i>	2.3	UN3162	2.3	2, B9, B14		None	304	314, 315	Forbidden	Forbidden	D	40
G	Liquefied gas, toxic, n.o.s. <i>Inhalation Hazard Zone C</i>	2.3	UN3162	2.3	3, B14		None	304	314, 315	Forbidden	Forbidden	D	40
G	Liquefied gas, toxic, n.o.s. <i>Inhalation Hazard Zone D</i>	2.3	UN3162	2.3		4	None	304	314, 315	Forbidden	Forbidden	D	40
G I	Liquefied gas, toxic, oxidizing, cor- rosive, n.o.s. <i>Inhalation Hazard Zone A</i>	2.3	UN3310	2.3, 5.1, 8		1	None	192	245	Forbidden	Forbidden	D	40, 89, 90
G I	Liquefied gas, toxic, oxidizing, cor- rosive, n.o.s. <i>Inhalation Hazard Zone B</i>	2.3	UN3310	2.3, 5.1, 8	2, B9, B14		None	304	314, 315	Forbidden	Forbidden	D	40, 89, 90

§ 172.101 HAZARDOUS MATERIALS TABLE—Continued

Sym-bols	Hazardous materials descriptions and proper shipping names	Hazard class or Division	Identi-fication Numbers	PG	Label Codes	Special provisions (§ 172.102)	(8)			(9)		(10) Vessel stowage	
							Packaging (§ 173.***)			Quantity limitations (see §§ 173.27 and 175.75)		Loca-tion	Other
							Excep-tions	Non-bulk	Bulk	Passenger aircraft/rail	Cargo air-craft only		
(1)	(2)	(3)	(4)	(5)	(6)	(7)	(8A)	(8B)	(8C)	(9A)	(9B)	(10A)	(10B)
G I	Liquefied gas, toxic, oxidizing, cor-rosive, n.o.s. <i>Inhalation Hazard Zone C</i>	2.3	UN3310		2.3, 5.1, 8	3, B14	None	304	314, 315	Forbidden	Forbidden	D	40, 89, 90
G I	Liquefied gas, toxic, oxidizing, cor-rosive, n.o.s. <i>Inhalation Hazard Zone D</i>	2.3	UN3310		2.3, 5.1, 8	4	None	304	314, 315	Forbidden	Forbidden	D	40, 89, 90
G	Liquefied gas, toxic, oxidizing, n.o.s. <i>Inhalation Hazard Zone A</i>	2.3	UN3307		2.3, 5.1	1	None	192	245	Forbidden	Forbidden	D	40
G	Liquefied gas, toxic, oxidizing, n.o.s. <i>Inhalation Hazard Zone B</i>	2.3	UN3307		2.3, 5.1	2, B9, B14	None	304	314, 315	Forbidden	Forbidden	D	40
G	Liquefied gas, toxic, oxidizing, n.o.s. <i>Inhalation Hazard Zone C</i>	2.3	UN3307		2.3, 5.1	3, B14	None	304	314, 315	Forbidden	Forbidden	D	40
G	Liquefied gas, toxic, oxidizing, n.o.s. <i>Inhalation Hazard Zone D</i>	2.3	UN3307		2.3, 5.1	4	None	304	314, 315	Forbidden	Forbidden	D	40
	Liquefied gases, <i>non-flammable charged with nitrogen, carbon di-oxide or air</i>	2.2	UN1058		2.2		306	304	None	75 kg	150 kg	A	
	<i>Liquefied hydrocarbon gas, see Hy-drocarbon gas mixture, liquefied, n.o.s.</i>												
	<i>Liquefied natural gas, see Methane, etc. (UN 1972)</i>												
	<i>Liquefied petroleum gas see Petro-leum gases, liquefied</i>												
	Lithium	4.3	UN1415	I	4.3	A7, A19, IB4, IP1, N45, T9, TP7, TP33, W31	151	211	244	Forbidden	15 kg	D	13, 52, 148
	<i>Lithium acetylide ethylenediamine complex, see Water reactive solid etc</i>												
	Lithium aluminum hydride	4.3	UN1410	I	4.3	A19, W31	None	211	242	Forbidden	15 kg	E	13, 52, 148
	Lithium aluminum hydride, ethereal	4.3	UN1411	I	4.3, 3	A2, A11, N34	None	201	244	Forbidden	1 L	D	13, 40, 148
	Lithium batteries installed in cargo transport unit <i>lithium ion batteries or lithium metal batteries</i>	9	UN3536		389				Forbidden	Forbidden	A	
	Lithium borohydride	4.3	UN1413	I	4.3	A19, N40, W31	None	211	242	Forbidden	15 kg	E	13, 52, 148

§ 172.101

49 CFR Ch. I (10-1-23 Edition)

Lithium ferrosilicon	4.3	UN2830	II	4.3	A19, IB7, IP2, IP21, T3, TP33, W31, W40	151	212	241	15 kg	50 kg	E	13, 40, 85, 103, 148
Lithium hydride	4.3	UN1414	I	4.3	A19, N40, W31	None	211	242	Forbidden	15 kg	E	13, 52, 148
Lithium hydride, fused solid	4.3	UN2805	II	4.3	A8, A19, A20, IB4, T3, TP33, W31, W40	151	212	241	15 kg	50 kg	E	13, 52, 148
Lithium hydroxide	8	UN2680	II	8	IB8, IP2, IP4, T3, TP33	154	212	240	15 kg	50 kg	A	52.
Lithium hydroxide, solution	8	UN2679	II	8	B2, IB2, T7, TP2	154	202	242	1 L	30 L	A	29, 52.
			III	8	IB3, T4, TP2	154	203	241	5 L	60 L	A	29, 52, 96.
Lithium hypochlorite, dry or Lithium hypochlorite mixture	5.1	UN1471	II	5.1	A9, IB8, IP2, IP4, N34, T3, TP33	152	212	240	5 kg	25 kg	A	4, 25, 52, 56, 58, 69, 106, 116
			III	5.1	IB8, IP3, N34, T1, TP33	152	213	240	25 kg	100 kg	A	4, 25, 52, 56, 58, 69, 106, 116
<i>Lithium in cartridges, see Lithium ion batteries including lithium ion polymer batteries</i>												
Lithium ion batteries contained in equipment including lithium ion polymer batteries	9	UN3480	9	388, 422, A54, A100	185	185	185	Forbidden	35 kg	A	156
Lithium ion batteries packed with equipment including lithium ion polymer batteries	9	UN3481	9	181, 360, 388, 422, A54	185	185	185	5 kg	35 kg	A	156
Lithium metal batteries including lithium alloy batteries	9	UN3090	9	388, 422, A54	185	185	185	Forbidden	35 kg	A	156
Lithium metal batteries contained in equipment including lithium alloy batteries	9	UN3091	9	181, 360, 388, 422, A54, A101	185	185	185	5 kg	35 kg	A	156
Lithium metal batteries packed with equipment including lithium alloy batteries	9	UN3091	9	181, 360, 388, 422, A54	185	185	185	5 kg	35 kg	A	156
Lithium nitrate	5.1	UN2722	III	5.1	A1, IB8, IP3, T1, TP33	152	213	240	25 kg	100 kg	A	
Lithium nitride	4.3	UN2806	I	4.3	A19, IB4, IP1, N40, W31	None	211	242	Forbidden	15 kg	E	
Lithium peroxide	5.1	UN1472	II	5.1	A9, IB6, IP2, N34, T3, TP33, W100	152	212	None	5 kg	25 kg	C	13, 52, 66, 75, 148
Lithium silicon	4.3	UN1417	II	4.3	A19, A20, IB7, IP2, IP21, T3, TP33, W31, W40	151	212	241	15 kg	50 kg	A	13, 85, 103, 148
LNG, see Methane etc. (UN 1972) London purple	6.1	UN1621	II	6.1	IB8, IP2, IP4, T3, TP33	153	212	242	25 kg	100 kg	A	

§ 172.101 HAZARDOUS MATERIALS TABLE—Continued

Sym-bols (1)	Hazardous materials descriptions and proper shipping names (2)	Hazard class or Division (3)	Identi-fication Numbers (4)	PG (5)	Label Codes (6)	Special provisions (§ 172.102) (7)	(8)			(9)		(10) Vessel stowage		
							Packaging (§ 173.***)			Quantity limitations (see §§ 173.27 and 175.75)		Loca-tion (10A)	Other (10B)	
							Excep-tions (8A)	Non-bulk (8B)	Bulk (8C)	Passenger aircraft/rail (9A)	Cargo air-craft only (9B)			
+	<i>LPG, see</i> Petroleum gases, liquefied <i>Lye, see</i> Sodium hydroxide, solutions Magnesium aluminum phosphide	4.3	UN1419	I	4.3, 6.1	A19, N34, N40, W31	None	211	242	Forbidden	15 kg	E	13, 40, 52, 85, 148	
	Magnesium arsenate <i>Magnesium bisulfite solution, see</i> Bisulfites, aqueous solutions, n.o.s.	6.1	UN1622	II	6.1	IB8, IP2, IP4, T3, TP33	153	212	242	25 kg	100 kg	A		
	Magnesium bromate	5.1	UN1473	II	5.1	A1, IB8, IP2, IP4, T3, TP33	152	212	242	5 kg	25 kg	A	56, 58	
	Magnesium chlorate	5.1	UN2723	II	5.1	IB8, IP2, IP4, T3, TP33	152	212	242	5 kg	25 kg	A	56, 58	
	Magnesium diamide	4.2	UN2004	II	4.2	A8, A19, A20, IB6, T3, TP33, W31	None	212	241	15 kg	50 kg	C	13, 148	
	<i>Magnesium dross, wet or hot</i> Magnesium fluorosilicate	Forbidden	6.1	UN2853	III	6.1	IB8, IP3, T1, TP33	153	213	240	100 kg	200 kg	A	52
	Magnesium granules, coated, particle size not less than 149 microns	4.3	UN2950	III	4.3	A1, A19, IB8, IP4, T1, TP33, W100	151	213	240	25 kg	100 kg	A	13, 52, 148	
	Magnesium hydride	4.3	UN2010	I	4.3	A19, N40, W31	None	211	242	Forbidden	15 kg	E	13, 52, 148	
	Magnesium or Magnesium alloys with more than 50 percent magnesium in pellets, turnings or ribbons	4.1	UN1869	III	4.1	A1, B134, IB8, IP21, T1, TP33, W100	151	213	240	25 kg	100 kg	A	13, 39, 52, 53, 74, 101, 147, 148	
	Magnesium nitrate	5.1	UN1474	III	5.1	332, A1, B120, IB8, IP3, T1, TP33	152	213	240	25 kg	100 kg	A		
	Magnesium perchlorate	5.1	UN1475	II	5.1	IB6, IP2, T3, TP33	152	212	242	5 kg	25 kg	A	56, 58	
	Magnesium peroxide	5.1	UN1476	II	5.1	IB6, IP2, T3, TP33, W100	152	212	242	5 kg	25 kg	C	13, 52, 66, 75, 148	
	Magnesium phosphide	4.3	UN2011	I	4.3, 6.1	A19, N40, W31	None	211	None	Forbidden	15 kg	E	13, 40, 52, 85, 148	

§ 172.101

49 CFR Ch. I (10-1-23 Edition)

Magnesium, powder or Magnesium alloys, powder	4.3	UN1418	I	4.3, 4.2	A19, B56, W31	None	211	244	Forbidden	15 kg	A	13, 39, 52, 148
			II	4.3, 4.2	A19, B56, IB5, IP2, T3, TP33, W31, W40	None	212	241	15 kg	50 kg	A	13, 39, 52, 148
			III	4.3, 4.2	A19, B56, IB8, IP4, T1, TP33, W31	None	213	241	25 kg	100 kg	A	13, 39, 52, 148
<i>Magnesium scrap, see Magnesium, etc. (UN 1869)</i>												
Magnesium silicide	4.3	UN2624	II	4.3	A19, A20, IB7, IP2, IP21, T3, TP33, W31, W40	151	212	241	15 kg	50 kg	B	13, 85, 103, 148
<i>Magnetized material, see § 173.21</i>												
Maleic anhydride	8	UN2215	III	8	IB8, IP3, T1, TP33	154	213	240	25 kg	100 kg	A	53, 58, 95, 102
Maleic anhydride, molten	8	UN2215	III	8	T4, TP3	None	213	240	Forbidden	Forbidden	A	53, 58, 95, 102
Malononitrile	6.1	UN2647	II	6.1	IB8, IP2, IP4, T3, TP33	153	212	242	25 kg	100 kg	A	12, 25
<i>Mancozeb (manganese ethylenebisdithiocarbamate complex with zinc) see Maneb</i>												
Maneb or Maneb preparations with not less than 60 percent maneb	4.2	UN2210	III	4.2, 4.3	57, A1, A19, IB6, T1, TP33, W100	None	213	242	25 kg	100 kg	A	13, 34, 148
Maneb stabilized or Maneb preparations, stabilized against self-heating	4.3	UN2968	III	4.3	54, A1, A19, IB8, IP4, T1, TP33, W100	151	213	242	25 kg	100 kg	B	13, 34, 52, 148
Manganese nitrate	5.1	UN2724	III	5.1	A1, IB8, IP3, T1, TP33	152	213	240	25 kg	100 kg	A	
Manganese resinate	4.1	UN1330	III	4.1	A1, IB6, T1, TP33	151	213	240	25 kg	100 kg	A	
Mannitan tetranitrate	Forbidden											
Mannitol hexanitrate (dry)	Forbidden											
Mannitol hexanitrate, wetted or Nitromannite, wetted with not less than 40 percent water, or mixture of alcohol and water, by mass	1.1D	UN0133	1.1D	121	None	62	None	Forbidden	Forbidden	04	25
<i>Marine pollutants, liquid or solid, n.o.s., see Environmentally hazardous substances, liquid or solid, n.o.s.</i>												
<i>Matches, block, see Matches, 'strike anywhere'</i>												
Matches, fusee	4.1	UN2254	III	4.1		186	186	None	Forbidden	Forbidden	A	
Matches, safety (book, card or strike on box)	4.1	UN1944	III	4.1		186	186	None	25 kg	100 kg	A	
Matches, strike anywhere	4.1	UN1331	III	4.1		186	186	None	Forbidden	Forbidden	B	
Matches, wax, Vesta	4.1	UN1945	III	4.1		186	186	None	25 kg	100 kg	B	
<i>Matting acid, see Sulfuric acid</i>												
Medical waste, category A, affecting humans, solid or Medical waste, category A, affecting animals only, solid	6.2	UN3549	6.2	131, 430			

§ 172.101 HAZARDOUS MATERIALS TABLE—Continued

Sym-bols (1)	Hazardous materials descriptions and proper shipping names (2)	Hazard class or Division (3)	Identi-fication Numbers (4)	PG (5)	Label Codes (6)	Special provisions (§ 172.102) (7)	(8)			(9)		(10) Vessel stowage	
							Packaging (§ 173.***)			Quantity limitations (see §§ 173.27 and 175.75)		Loca-tion (10A)	Other (10B)
							Excep-tions (8A)	Non-bulk (8B)	Bulk (8C)	Passenger aircraft/rail (9A)	Cargo air-craft only (9B)		
	Medicine, liquid, flammable, toxic, n.o.s	3	UN3248	II	3, 6.1	IB2	150	202	243	1 L	60 L	B	40
	Medicine, liquid, toxic, n.o.s	6.1	UN1851	III	3, 6.1	IB3	150	203	242	60 L	220 L	A	40
	Medicine, solid, toxic, n.o.s	6.1	UN3249	II	6.1	T3, TP33	153	202	243	5 L	60 L	C	40
	<i>Mentetrahydrophthalic anhydride, see Corrosive liquids, n.o.s.</i>			III	6.1		153	203	241	60 L	220 L	C	40
	Mercaptans, liquid, flammable, n.o.s. or Mercaptan mixture, liquid, flammable, n.o.s	3	UN3336	I	3	T3, TP33	153	212	242	25 kg	100 kg	C	40
				III	6.1	T3, TP33	153	213	240	100 kg	200 kg	C	40
	Mercaptans, liquid, flammable, toxic, n.o.s. or Mercaptan mixture, liquid, flammable, toxic, n.o.s.	3	UN1228	II	3, 6.1	T11, TP2	150	201	243	1 L	30 L	E	95, 102
				II	3	IB2, T7, TP1, TP8, TP28	150	202	242	5 L	60 L	B	95, 102
				III	3	B1, B52, IB3, T4, TP1, TP29	150	203	241	60 L	220 L	B	95, 102
				III	3, 6.1	IB2, T11, TP2, TP27	150	202	243	Forbidden	60 L	B	40, 95, 102
				III	3, 6.1	B1, IB3, T7, TP1, TP28	150	203	242	5 L	220 L	A	40, 95, 102
	Mercaptans, liquid, toxic, flammable, n.o.s. or Mercaptan mixture, liquid, toxic, flammable, n.o.s., flash point not less than 23 degrees C	6.1	UN3071	II	6.1, 3	IB2, T11, TP2, TP13, TP27	153	202	243	5 L	60 L	C	40, 102, 121
	5-Mercaptotetrazol-1-acetic acid	1.4C	UN0448	1.4C	None	62	None	Forbidden	75 kg	O2	25
	Mercuric arsenate	6.1	UN1623	II	6.1	IB8, IP2, IP4, T3, TP33	153	212	242	25 kg	100 kg	A	
	Mercuric chloride	6.1	UN1624	II	6.1	IB8, IP2, IP4, T3, TP33	153	212	242	25 kg	100 kg	A	
	<i>Mercuric compounds, see Mercury compounds, etc</i>												
	Mercuric nitrate	6.1	UN1625	II	6.1	IB8, IP2, IP4, N73, T3, TP33	153	212	242	25 kg	100 kg	A	
+	Mercuric potassium cyanide	6.1	UN1626	I	6.1	IB7, IP1, N74, N75, T6, TP33, W31	None	211	242	5 kg	50 kg	A	52
	<i>Mercuric sulfocyanate, see Mercury thiocyanate</i>												
	<i>Mercuriol, see Mercury nucleate</i>												

§ 172.101

49 CFR Ch. I (10-1-23 Edition)

	<i>Mercurous azide</i>	Forbidden															
	<i>Mercurous compounds, see Mercury compounds, etc</i>																
A W	Mercurous nitrate	6.1 UN1627	II	6.1	IB8, IP2, IP4, T3, TP33	153	212	242	25 kg	100 kg	A						
	Mercury	8 UN2809	III	8, 6.1	365	164	164	240	35 kg	35 kg	B	40, 97					
	Mercury acetate	6.1 UN1629	II	6.1	IB8, IP2, IP4, T3, TP33	153	212	242	25 kg	100 kg	A						
	<i>Mercury acetylde</i>	Forbidden															
	Mercury ammonium chloride	6.1 UN1630	II	6.1	IB8, IP2, IP4, T3, TP33	153	212	242	25 kg	100 kg	A						
	Mercury based pesticides, liquid, flammable, toxic, flash point less than 23 degrees C	3 UN2778	I	3, 6.1	T14, TP2, TP13, TP27	None	201	243	Forbidden	30 L	B	40					
			II	3, 6.1	IB2, T11, TP2, TP13, TP27	150	202	243	1 L	60 L	B	40					
	Mercury based pesticides, liquid, toxic	6.1 UN3012	I	6.1	T14, TP2, TP13, TP27	None	201	243	1 L	30 L	B	40					
			II	6.1	IB2, T11, TP2, TP13, TP27	153	202	243	5 L	60 L	B	40					
			III	6.1	IB3, T7, TP2, TP28	153	203	241	60 L	220 L	A	40					
	Mercury based pesticides, liquid, toxic, flammable, flash point not less than 23 degrees C	6.1 UN3011	I	6.1, 3	T14, TP2, TP13, TP27	None	201	243	1 L	30 L	B	40					
			II	6.1, 3	IB2, T11, TP2, TP13, TP27	153	202	243	5 L	60 L	B	40					
			III	6.1, 3	IB3, T7, TP2, TP28	153	203	242	60 L	220 L	A	40					
	Mercury based pesticides, solid, toxic	6.1 UN2777	I	6.1	IB7, IP1, T6, TP33	None	211	242	5 kg	50 kg	A	40					
			II	6.1	IB8, IP2, IP4, T3, TP33	153	212	242	25 kg	100 kg	A	40					
			III	6.1	IB8, IP3, T1, TP33	153	213	240	100 kg	200 kg	A	40					
	Mercury benzoate	6.1 UN1631	II	6.1	IB8, IP2, IP4, T3, TP33	153	212	242	25 kg	100 kg	A						
	Mercury bromides	6.1 UN1634	II	6.1	IB8, IP2, IP4, T3, TP33	153	212	242	25 kg	100 kg	A						
G	Mercury compound, liquid, n.o.s	6.1 UN2024	I	6.1		None	201	243	1 L	30 L	B	40					
			II	6.1	IB2	153	202	243	5 L	60 L	B	40					
			III	6.1	IB3	153	203	241	60 L	220 L	B	40					
G	Mercury compound, solid, n.o.s	6.1 UN2025	I	6.1	IB7, IP1, T6, TP33	None	211	242	5 kg	50 kg	A						
			II	6.1	IB8, IP2, IP4, T3, TP33	153	212	242	25 kg	100 kg	A						
			III	6.1	IB8, IP3, T1, TP33	153	213	240	100 kg	200 kg	A						
A W	Mercury contained in manufactured articles	8 UN3506	8, 6.1	A191	164	None	None	No limit	No limit	B	40, 97					
	Mercury cyanide	6.1 UN1636	II	6.1	IB8, IP2, IP4, N74, N75, T3, TP33	153	212	242	25 kg	100 kg	A	52					
	Mercury fulminate, wetted with not less than 20 percent water, or mixture of alcohol and water, by mass	1.1A UN0135	1.1A	111, 117	None	62	None	Forbidden	Forbidden	05	25					
	Mercury gluconate	6.1 UN1637	II	6.1	IB8, IP2, IP4, T3, TP33	153	212	242	25 kg	100 kg	A						
	Mercury iodide	6.1 UN1638	II	6.1	IB2, IP2, IP4, T3, TP33	153	212	242	25 kg	100 kg	A						
	<i>Mercury iodide aquabasic ammonobasic (Iodide of Millon's base)</i>	Forbidden															
	<i>Mercury nitride</i>	Forbidden															

§ 172.101 HAZARDOUS MATERIALS TABLE—Continued

§ 172.101

49 CFR Ch. I (10-1-23 Edition)

Sym-bols	Hazardous materials descriptions and proper shipping names	Hazard class or Division	Identi-fication Numbers	PG	Label Codes	Special provisions (§ 172.102)	(8)			(9)		(10) Vessel stowage												
							Packaging (§ 173.***)			Quantity limitations (see §§ 173.27 and 175.75)		Loca-tion	Other											
							Excep-tions	Non-bulk	Bulk	Passenger aircraft/rail	Cargo air-craft only													
(1)	(2)	(3)	(4)	(5)	(6)	(7)	(8A)	(8B)	(8C)	(9A)	(9B)	(10A)	(10B)											
+	Mercury nucleate	6.1	UN1639	II	6.1	IB8, IP2, IP4, T3, TP33	153	212	242	25 kg	100 kg	A	52, 91											
	Mercury oleate	6.1	UN1640	II	6.1	IB8, IP2, IP4, T3, TP33	153	212	242	25 kg	100 kg	A												
	Mercury oxide	6.1	UN1641	II	6.1	IB8, IP2, IP4, T3, TP33	153	212	242	25 kg	100 kg	A												
	Mercury oxycyanide	Forbidden	UN1642	II	6.1	IB8, IP2, IP4, T3, TP33	153	212	242	25 kg	100 kg	A												
	Mercury oxycyanide, desensitized																							
	Mercury potassium iodide																							
	Mercury salicylate																							
	Mercury sulfates																							
	Mercury thiocyanate																							
	Mesityl oxide													3	UN1229	III	3	B1, IB3, T2, TP1	150	203	242	60 L	220 L	A
G	Metal carbonyls, liquid, n.o.s.												6.1	UN3281	I	6.1	5, T14, TP2, TP13, TP27	None	201	243	1 L	30 L	B	40
G	Metal carbonyls, solid, n.o.s.												6.1	UN3466	I	6.1	IB3, T7, TP1, TP28	153	203	241	60 L	220 L	A	40
		II	6.1	IB7, IP1, T6, TP33	None	211	242	5 kg	50 kg	D	40													
G	Metal catalyst, dry	4.2	UN2881	I	4.2	IB8, IP2, IP4, T3, TP33	153	212	242	25 kg	100 kg	B	40											
														III	6.1	IB8, IP3, T1, TP33	153	213	240	100 kg	200 kg	B	40	
														II	4.2	N34, T21, TP7, TP33, W31	None	187	None	Forbidden	Forbidden	C	13, 147, 148	
G	Metal catalyst, wetted with a visible excess of liquid	4.2	UN1378	II	4.2	IB6, IP2, N34, T3, TP33, W31	None	187	242	Forbidden	50 kg	C	13, 147, 148											
														III	4.2	B135, IB8, IP21, N34, T1, TP33, W31	None	187	241	25 kg	100 kg	C	13, 147, 148	
														II	4.2	A2, A8, IB1, N34, T3, TP33, W31, W40	None	212	None	Forbidden	50 kg	C		
G	Metal hydrides, flammable, n.o.s.	4.1	UN3182	II	4.1	A1, IB4, T3, TP33, W31, W40	151	212	240	15 kg	50 kg	E												
														III	4.1	A1, IB4, T1, TP33, W31	151	213	240	25 kg	100 kg	E		
														I	4.3	A19, N34, N40, W31	None	211	242	Forbidden	15 kg	D	13, 52, 148	
G	Metal hydrides, water reactive, n.o.s.	4.3	UN1409	II	4.3	A19, IB4, N34, N40, T3, TP33, W31, W40	151	212	242	15 kg	50 kg	D	13, 52, 148											
														III	4.2	IB6, IP2, T3, TP33, W31	None	212	241	15 kg	50 kg	C	13, 148	
	Metal powder, self-heating, n.o.s.	4.2	UN3189	III	4.2	B135, IB8, IP4, T1, TP33, W31	None	213	241	25 kg	100 kg	C	13, 148											

G	Metal powders, flammable, n.o.s	4.1	UN3089	II	4.1	IB8, IP2, IP4, T3, TP33, W100	151	212	240	15 kg	50 kg	B	13, 74, 147, 148	
				III	4.1	IB8, IP2, IP4, T1, TP33, W100	151	213	240	25 kg	100 kg	B	13, 74, 147, 148	
G	<i>Metal salts of methyl nitramine (dry)</i> Metal salts of organic compounds, flammable, n.o.s	Forbidden	4.1	UN3181	II	4.1	A1, IB8, IP2, IP4, T3, TP33, W31	151	212	240	15 kg	50 kg	B	40
					III	4.1	A1, IB8, IP3, T1, TP33, W31	151	213	240	25 kg	100 kg	B	40
					III	4.1	A1, IB8, IP3, T1, TP33	151	213	240	25 kg	100 kg	B	40
G	Metaldehyde	4.1	UN1332	III	4.1	A1, IB8, IP3, T1, TP33	151	213	240	25 kg	100 kg	A	40	
				G	Metallic substance, water-reactive, n.o.s	4.3	UN3208	I	4.3	A7, IB4, W31	None	211	242	Forbidden
II	4.3	A7, IB7, IP2, IP21, T3, TP33, W31, W40	151					212	242	15 kg	50 kg	E	13, 40, 148	
G	Metallic substance, water-reactive, self-heating, n.o.s	4.3	UN3209	III	4.3	A7, IB8, IP21, T1, TP33, W31	151	213	241	25 kg	100 kg	E	13, 40, 148	
				I	4.3, 4.2	A7, W31	None	211	242	Forbidden	15 kg	E	13, 40, 148	
				II	4.3, 4.2	A7, IB5, IP2, T3, TP33, W31, W40	None	212	242	15 kg	50 kg	E	13, 40, 148	
G	Metallic substance, water-reactive, self-heating, n.o.s	4.3	UN3209	III	4.3, 4.2	A7, IB8, IP4, T1, TP33, W31	None	213	242	25 kg	100 kg	E	13, 40, 148	
				II	3, 6.1	45, 387, IB2, T7, TP1, TP13	150	202	243	1 L	60 L	D	25, 40	
				II	8	41, 387, IB2, T7, TP1, TP18, TP30	154	202	242	1 L	30 L	C	25, 40, 53, 58	
+	Methacrylonitrile, stabilized	6.1	UN3079	I	6.1, 3	2, 387, B9, B14, B32, T20, TP2, TP13, TP38, TP45	None	227	244	Forbidden	Forbidden	D	12, 25, 40	
				III	3	B1, IB3, T2, TP1	150	203	242	60 L	220 L	A		
+ I	Methallyl alcohol	3	UN2614	III	3	B1, IB3, T2, TP1	150	203	242	60 L	220 L	A		
				<i>Methane and hydrogen, mixtures, see Hydrogen and methane, mixtures, etc</i>										
D	Methane, compressed or Natural gas, compressed (with high methane content)	2.1	UN1971		2.1		306	302	302	Forbidden	150 kg	E	40	
					2.1	UN1972	2.1	T75, TP5, 440	None	None	318, 319	Forbidden	Forbidden
+ I	Methane, refrigerated liquid (cryogenic liquid) or Natural gas, refrigerated liquid (cryogenic liquid), with high methane content	6.1	UN3246	I	6.1, 8	2, B9, B14, B32, T20, TP2, TP13, TP38, TP45	None	227	244	Forbidden	Forbidden	D	40, 53, 58	
				II	3, 6.1	IB2, T7, TP2	150	202	242	1 L	60 L	B	40	
D	Methanol	3	UN1230	II	3	IB2, T7, TP2	150	202	242	1 L	60 L	B	40	
				<i>Methazoic acid</i>										
D	4-Methoxy-4-methylpentan-2-one	3	UN2293	III	3	B1, IB3, T2, TP1	150	203	242	60 L	220 L	A		
				III	3	B1, IB3, T2, TP1	150	203	242	60 L	220 L	A		
D	1-Methoxy-2-propanol	3	UN3092	III	3	B1, IB3, T2, TP1	150	203	242	60 L	220 L	A		

§ 172.101 HAZARDOUS MATERIALS TABLE—Continued

Sym-bols	Hazardous materials descriptions and proper shipping names	Hazard class or Division	Identi-fication Numbers	PG	Label Codes	Special provisions (§ 172.102)	(8)			(9)		(10) Vessel stowage	
							Packaging (§ 173.***)			Quantity limitations (see §§ 173.27 and 175.75)		Loca-tion	Other
							Excep-tions	Non-bulk	Bulk	Passenger aircraft/rail	Cargo air-craft only		
(1)	(2)	(3)	(4)	(5)	(6)	(7)	(8A)	(8B)	(8C)	(9A)	(9B)	(10A)	(10B)
+	Methoxymethyl isocyanate	6.1	UN2605	I	6.1, 3	1, B9, B14, B30, T20, TP2, TP13, TP38, TP44	None	226	244	Forbidden	Forbidden	D	40
	Methyl acetate	3	UN1231	II	3	IB2, T4, TP1	150	202	242	5 L	60 L	B	
	Methyl acetylene and propadiene mixtures, stabilized	2.1	UN1060	2.1	387, N88, T50	306	304	314, 315	Forbidden	150 kg	B	25, 40
	Methyl acrylate, stabilized	3	UN1919	II	3	387, IB2, T4, TP1, TP13	150	202	242	5 L	60 L	C	25
	Methyl alcohol, see Methanol												
	Methyl allyl chloride	3	UN2554	II	3	IB2, T4, TP1, TP13	150	202	242	5 L	60 L	E	
	Methyl amyl ketone, see Amyl methyl ketone												
	Methyl bromide	2.3	UN1062		2.3	3, B14, N86, T50	None	193	314, 315	Forbidden	Forbidden	D	40
	Methyl bromide and chloropicrin mixtures with more than 2 percent chloropicrin, see Chloropicrin and methyl bromide mixtures												
	Methyl bromide and chloropicrin mixtures with not more than 2 percent chloropicrin, see Methyl bromide												
	Methyl bromide and ethylene dibromide mixtures, liquid	6.1	UN1647	I	6.1	2, B9, B14, B32, N65, T20, TP2, TP13, TP38, TP44	None	227	244	Forbidden	Forbidden	D	40
	Methyl bromoacetate	6.1	UN2643	II	6.1	IB2, T7, TP2	153	202	243	5 L	60 L	D	40
	2-Methylbutanal	3	UN3371	II	3	IB2, T4, TP1	150	202	242	5 L	60 L	B	
	2-Methyl-1-butene	3	UN2459	I	3	T11, TP2	None	201	243	1 L	30 L	E	
	2-Methyl-2-butene	3	UN2460	II	3	IB2, IP8, T7, TP1	150	202	242	5 L	60 L	E	
	3-Methyl-1-butene	3	UN2561	I	3	T11, TP2	None	201	243	1 L	30 L	E	
	Methyl tert-butyl ether	3	UN2398	II	3	IB2, T7, TP1	150	202	242	5 L	60 L	E	
	Methyl butyrate	3	UN1237	II	3	IB2, T4, TP1	150	202	242	5 L	60 L	B	
	Methyl chloride or Refrigerant gas R 40	2.1	UN1063		2.1	N86, T50	306	304	314, 315	5 kg	100 kg	D	40
	Methyl chloride and chloropicrin mixtures, see Chloropicrin and methyl chloride mixtures												
Methyl chloride and methylene chloride mixtures	2.1	UN1912		2.1	N86, T50	306	304	314, 315	Forbidden	150 kg	D	40	
Methyl chloroacetate	6.1	UN2295	I	6.1, 3	T14, TP2, TP13	None	201	243	1 L	30 L	D		

§ 172.101

49 CFR Ch. I (10-1-23 Edition)

§ 172.101 HAZARDOUS MATERIALS TABLE—Continued

Sym-bols	Hazardous materials descriptions and proper shipping names	Hazard class or Division	Identifi-cation Numbers	PG	Label Codes	Special provisions (§ 172.102)	(8)			(9)		(10) Vessel stowage	
							Packaging (§ 173.***)			Quantity limitations (see §§ 173.27 and 175.75)		Loca-tion	Other
							Excep-tions	Non-bulk	Bulk	Passenger aircraft/rail	Cargo air-craft only		
(1)	(2)	(3)	(4)	(5)	(6)	(7)	(8A)	(8B)	(8C)	(9A)	(9B)	(10A)	(10B)
D	<i>Methyl norbornene dicarboxylic anhydride, see Corrosive liquids, n.o.s.</i> Methyl orthosilicate	6.1	UN2606	I	6.1, 3	2, B9, B14, B32, T20, TP2, TP13, TP38, TP45	None	227	244	Forbidden	Forbidden	D	40
	Methyl phosphonic dichloride	6.1	NA9206	I	6.1, 8	2, B9, B14, B32, N34, N43, T20, TP4, TP13, TP38, TP45	None	227	244	Forbidden	Forbidden	C	
D	<i>Methyl phosphonothioic dichloride, anhydrous, see Corrosive liquid, n.o.s.</i> Methyl phosphonous dichloride, pyrophoric liquid	6.1	NA2845	I	6.1, 4.2	2, B9, B14, B16, B32, T20, TP4, TP12, TP13, TP38, TP45	None	227	244	Forbidden	Forbidden	D	18
	<i>Methyl picric acid (heavy metal salts of)</i> Methyl propionate Methyl propyl ether Methyl propyl ketone <i>Methyl sulfate, see Dimethyl sulfate</i> <i>Methyl sulfide, see Dimethyl sulfide</i> Methyl trichloroacetate	Forbidden 3 3 3 3 6.1	UN1248 UN2612 UN1249 UN2533	II II II III	3 3 3 6.1	3 3 3 6.1	IB2, T4, TP1 IB2, IP8, T7, TP2 IB2, T4, TP1 IB3, T4, TP1	150 150 150 153	202 202 202 203	242 242 242 241	5 L 5 L 5 L 60 L	60 L 60 L 60 L 220 L	B E B A
	<i>Methyl trimethylol methane trinitrate</i> Methyl vinyl ketone, stabilized	Forbidden 6.1	UN1251	I	6.1, 3, 8	1, 387, B9, B14, B30, T22, TP2, TP13, TP38, TP44	None	226	244	Forbidden	Forbidden	B	21, 25, 40, 100
	Methylal Methylamine, anhydrous	3 2.1	UN1234 UN1061	II	3 2.1	IB2, IP8, T7, TP2 N87, T50	150 306	202 304	242 314, 315	5 L Forbidden	60 L 150 kg	E B	40, 52
	Methylamine, aqueous solution <i>Methylamine dinitramine and dry salts thereof</i> <i>Methylamine nitroform</i> <i>Methylamine perchlorate (dry)</i> Methylamyl acetate N-Methylaniline	3 Forbidden Forbidden 3 6.1	UN1235 UN1233 UN2294	II III III	3, 8 3 6.1	B1, IB2, T7, TP1 B1, IB3, T2, TP1 IB3, T4, TP2	150 153	202 203	243 241	1 L 60 L 60 L	5 L 220 L 220 L	E A A	52, 135.
	alpha-Methylbenzyl alcohol, liquid	6.1	UN2937	III	6.1	IB3, T4, TP1	153	203	241	60 L	220 L	A	

§ 172.101

49 CFR Ch. I (10-1-23 Edition)

D	alpha-Methylbenzyl alcohol, solid	6.1	UN3438	III	6.1	IB8, IP3, T1, TP33	153	213	240	100 kg	200 kg	A	
	3-Methylbutan-2-one	3	UN2397	II	3	IB2, T4, TP1	150	202	242	5 L	60 L	B	
	N-Methylbutylamine	3	UN2945	II	3, 8	IB2, T7, TP1	150	202	243	1 L	5 L	B	40, 52
	Methylchlorosilane	2.3	UN2534		2.3, 2.1, 8	2, B9, B14, N34	None	226	314, 315	Forbidden	Forbidden	D	17, 40
	Methylcyclohexane	3	UN2296	II	3	B1, IB2, T4, TP2	150	202	242	5 L	60 L	B	
	Methylcyclohexanols, <i>flammable</i>	3	UN2617	III	3	B1, IB3, T2, TP1	150	203	242	60 L	220 L	A	
	Methylcyclohexanone	3	UN2297	III	3	B1, IB3, T2, TP1	150	203	242	60 L	220 L	A	
	Methylcyclopentane	3	UN2298	II	3	IB2, T4, TP1	150	202	242	5 L	60 L	B	
	Methyldichloroarsine	6.1	NA1556	I	6.1	2, T20, TP4, TP13, TP38, TP45	None	192	None	Forbidden	Forbidden	D	40
	Methyldichlorosilane	4.3	UN1242	I	4.3, 8, 3	A2, A7, B6, B77, N34, T14, TP2, TP7, TP13, W31	None	201	243	Forbidden	1 L	D	21, 40, 49, 53, 58, 100
	<i>Methylene chloride</i> , see Dichloromethane												
	<i>Methylene glycol dinitrate</i>	Forbidden											
	2-Methylfuran	3	UN2301	II	3	IB2, T4, TP1	150	202	242	5 L	60 L	E	
	<i>a-Methylglucoside tetranitrate</i>	Forbidden											
	<i>a-Methylglycerol trinitrate</i>	Forbidden											
	5-Methylhexan-2-one	3	UN2302	III	3	B1, IB3, T2, TP1	150	203	242	60 L	220 L	A	
	Methylhydrazine	6.1	UN1244	I	6.1, 3, 8	1, B7, B9, B14, B30, B77, N34, T22, TP2, TP13, TP38, TP44	None	226	244	Forbidden	Forbidden	D	21, 40, 49, 52 and 100
	4-Methylmorpholine or n- methylmorpholine	3	UN2535	II	3, 8	B6, IB2, T7, TP1	150	202	243	1 L	5 L	B	40
	Methylpentadienes	3	UN2461	II	3	IB2, T4, TP1	150	202	242	5 L	60 L	E	
	2-Methylpentan-2-ol	3	UN2560	III	3	B1, IB3, T2, TP1	150	203	242	60 L	220 L	A	
	<i>Methylpentanes</i> , see Hexanes												
	Methylphenyldichlorosilane	8	UN2437	II	8	T10, TP2, TP7, TP13	None	206	242	Forbidden	30 L	C	40, 53, 58
	1-Methylpiperidine	3	UN2399	II	3, 8	IB2, T7, TP1	150	202	243	1 L	5 L	B	52.
	Methyltetrahydrofuran	3	UN2536	II	3	IB2, T4, TP1	150	202	242	5 L	60 L	B	
	Methyltrichlorosilane	3	UN1250	II	3, 8	A7, B6, B77, N34, T10, TP2, TP7, TP13	None	206	243	Forbidden	5 L	B	40, 53, 58
	alpha-Methylvaleraldehyde	3	UN2367	II	3	B1, IB2, T4, TP1	150	202	242	5 L	60 L	B	
	<i>Mine rescue equipment containing carbon dioxide</i> , see Carbon diox- ide												
	<i>Mines with bursting charge</i>	1.1F	UN0136	1.1F		62	None	Forbidden	Forbidden	03	25
	<i>Mines with bursting charge</i>	1.1D	UN0137	1.1D		62	62	Forbidden	Forbidden	03	25
	<i>Mines with bursting charge</i>	1.2D	UN0138	1.2D		62	62	Forbidden	Forbidden	03	25
<i>Mines with bursting charge</i>	1.2F	UN0294	1.2F		62	None	Forbidden	Forbidden	03	25	
<i>Mixed acid</i> , see Nitrating acid, mix- tures etc													
<i>Mobility aids</i> , see Battery powered equipment or Battery powered vehicle'													

§ 172.101 HAZARDOUS MATERIALS TABLE—Continued

§ 172.101

49 CFR Ch. I (10-1-23 Edition)

Sym-bols	Hazardous materials descriptions and proper shipping names	Hazard class or Division	Identi-fication Numbers	PG	Label Codes	Special provisions (§ 172.102)	(8)			(9)		(10) Vessel stowage	
							Packaging (§ 173.***)			Quantity limitations (see §§ 173.27 and 175.75)		Loca-tion	Other
							Excep-tions	Non-bulk	Bulk	Passenger aircraft/rail	Cargo air-craft only		
(1)	(2)	(3)	(4)	(5)	(6)	(7)	(8A)	(8B)	(8C)	(9A)	(9B)	(10A)	(10B)
D	Model rocket motor	1.4C	NA0276	1.4C	51	None	62	None	Forbidden	75 kg	02	25
D	Model rocket motor	1.4S	NA0323	1.4S	51	None	62	None	25 kg	100 kg	01	25
	Molybdenum pentachloride	8	UN2508	III	8	IB8, IP3, T1, TP33	154	213	240	25 kg	100 kg	C	40, 53, 58
	<i>Monochloroacetone (unstabilized)</i>	Forbidden											
	<i>Monochloroethylene, see Vinyl chloride, stabilized</i>												
	<i>Monoethanolamine, see Ethanol-amine, solutions</i>												
	<i>Monoethylamine, see Ethylamine</i>												
	Morpholine	8	UN2054	I	8, 3	T10, TP2	None	201	243	0.5 L	2.5 L	A	
	<i>Morpholine, aqueous, mixture, see Corrosive liquids, n.o.s.</i>												
	Motor fuel anti-knock compounds <i>see</i> Motor fuel anti-knock mixtures												
+	Motor fuel anti-knock mixture, flammable	6.1	UN3483	I	6.1, 3	14, T14, TP2, TP13	None	201	244	Forbidden	Forbidden	D	25, 40
+	Motor fuel anti-knock mixtures	6.1	UN1649	I	6.1	14, B9, B90, T14, TP2, TP13	None	201	244	Forbidden	30 L	D	25, 40
	Motor spirit, <i>see</i> Gasoline												
	<i>Muriatic acid, see Hydrochloric acid</i>												
	Musk xylene, <i>see</i> 5-tert-Butyl-2,4,6-trinitro-m-xylene												
	<i>Naphtha see</i> Petroleum distillates n.o.s.												
	Naphthalene, crude or Naphthalene, refined	4.1	UN1334	III	4.1	A1, B120,IB8, IP3, T1, TP33	151	213	240	25 kg	100 kg	A	
	<i>Naphthalene diozonide</i>	Forbidden											
	beta-Naphthylamine, solid	6.1	UN1650	II	6.1	IB8, IP2, IP4, T3, TP33	153	212	242	25 kg	100 kg	A	
	beta-Naphthylamine solution	6.1	UN3411	II	6.1	IB2, T7, TP2	153	202	243	5 L	60 L	A	
				III	6.1	IB2, T7, TP2	153	203	241	60 L	220 L	A	
	alpha-Naphthylamine	6.1	UN2077	III	6.1	IB8, IP3, T1, TP33	153	213	240	100 kg	200 kg	A	
	Naphthalene, molten	4.1	UN2304	III	4.1	IB1, T1, TP3	151	213	241	Forbidden	Forbidden	C	
	<i>Naphthylamineperchlorate</i>	Forbidden											
	Naphthylthiourea	6.1	UN1651	II	6.1	IB8, IP2, IP4, T3, TP33	153	212	242	25 kg	100 kg	A	
	Naphthylurea	6.1	UN1652	II	6.1	IB8, IP2, IP4, T3, TP33	153	212	242	25 kg	100 kg	A	

§ 172.101 HAZARDOUS MATERIALS TABLE—Continued

§ 172.101

49 CFR Ch. I (10-1-23 Edition)

Sym-bols (1)	Hazardous materials descriptions and proper shipping names (2)	Hazard class or Division (3)	Identi-fication Numbers (4)	PG (5)	Label Codes (6)	Special provisions (§ 172.102) (7)	(8)			(9)		(10) Vessel stowage		
							Packaging (§ 173.***)			Quantity limitations (see §§ 173.27 and 175.75)		Loca-tion (10A)	Other (10B)	
							Excep-tions (8A)	Non-bulk (8B)	Bulk (8C)	Passenger aircraft/rail (9A)	Cargo air-craft only (9B)			
+	Nitrating acid mixtures with not more than 50 percent nitric acid	8	UN1796	II	8	A7, B2, IB2, T8, TP2, TP13	154	158	242	Forbidden	30 L	D	40, 53, 58	
	Nitric acid other than red fuming, with at least 65 percent, but not more than 70 percent nitric acid	8	UN2031	II	8, 5.1	B2, B47, B53, IB2, IP15, T8, TP2	154	158	242	Forbidden	30 L	D	53, 58, 66, 74, 89, 90	
	Nitric acid other than red fuming, with more than 20 percent and less than 65 percent nitric acid	8	UN2031	II	8	A212, B2, B47, B53, IB2, IP15, T8, TP2	154	158	242	Forbidden	30 L	D	44, 66, 53, 58, 74, 89, 90	
	Nitric acid other than red fuming with not more than 20 percent nitric acid	8	UN2031	II	8	B2, B47, B53, IB2, T8, TP2	154	158	242	1 L	30 L	D	53, 58	
	Nitric acid, red fuming	8	UN2032	I	8, 5.1, 6.1	2, B9, B32, T20, TP2, TP13, TP38, TP45	None	227	244	Forbidden	Forbidden	D	40, 53, 58, 66, 74, 89, 90	
	Nitric acid other than red fuming, with more than 70 percent nitric acid	8	UN2031	I	8, 5.1	B47, B53, T10, TP2, TP12, TP13	None	158	243	Forbidden	2.5 L	D	44, 53, 58, 66, 89, 90, 110, 111	
	Nitric oxide, compressed	2.3	UN1660			2.3, 5.1, 8	1, B77	None	337	None	Forbidden	Forbidden	D	40, 89, 90
	Nitric oxide and dinitrogen tetroxide mixtures or Nitric oxide and nitrogen dioxide mixtures	2.3	UN1975			2.3, 5.1, 8	1, B77	None	337	None	Forbidden	Forbidden	D	40, 89, 90
G	Nitriles, flammable, toxic, n.o.s.	3	UN3273	I	3, 6.1	T14, TP2, TP13, TP27	None	201	243	Forbidden	30 L	E	40, 52	
				II	3, 6.1	IB2, T11, TP2, TP13, TP27	150	202	243	1 L	60 L	B	40, 52	
G	Nitriles, liquid, toxic, n.o.s.	6.1	UN3276	I	6.1	5, T14, TP2, TP13, TP27	None	201	243	1 L	30 L	B	52	
				II	6.1	IB2, T11, TP2, TP27	153	202	243	5 L	60 L	B	52	
				III	6.1	IB3, T7, TP1, TP28	153	203	241	60 L	220 L	A	52	
G	Nitriles, solid, toxic, n.o.s.	6.1	UN3439	I	6.1	IB7, IP1, T6, TP33	None	211	242	5 kg	50 kg	D	52	
				II	6.1	IB8, IP2, IP4, T3, TP33	153	212	242	25 kg	100 kg	B	52	
				III	6.1	IB8, IP3, T1, TP33	153	213	240	100 kg	200 kg	A	52	

260

G	Nitriles, toxic, flammable, n.o.s.	6.1	UN3275	I	6.1, 3	5, T14, TP2, TP13, TP27	None	201	243	1 L	30 L	B	40, 52
				II	6.1, 3	IB2, T11, TP2, TP13, TP27	153	202	243	5 L	60 L	B	40, 52
G	Nitrites, inorganic, aqueous solution, n.o.s	5.1	UN3219	II	5.1	148, IB1, T4, TP1	152	202	242	1 L	5 L	B	46, 56, 58, 133
				III	5.1	IB2, T4, TP1	152	203	241	2.5 L	30 L	B	46, 56, 58, 133
G	Nitrites, inorganic, n.o.s.	5.1	UN2627	II	5.1	33, IB8, IP2, IP4, T3, TP33	152	212	None	5 kg	25 kg	A	46, 56, 58, 133
				II	6.1	IB2, T7, TP2	153	202	243	5 L	60 L	A	40
	3-Nitro-4-chlorobenzotrifluoride	6.1	UN2307	II	6.1	IB2, T7, TP2	153	202	243	5 L	60 L	A	40
	6-Nitro-4-diazoluene-3-sulfonic acid (dry)	Forbidden											
	Nitro isobutane triol trinitrate	Forbidden											
	N-Nitro-N-methylglycolamide nitrate	Forbidden											
	2-Nitro-2-methylpropanol nitrate	Forbidden											
	Nitro urea	1.1D	UN0147	1.1D	None	62	None	Forbidden	Forbidden	04	25
	N-Nitroaniline	Forbidden											
+	Nitroanilines (o-; m-; p-)	6.1	UN1661	II	6.1	IB8, IP2, IP4, T3, TP33	153	212	242	25 kg	100 kg	A	
				III	6.1	IB3, T4, TP1	153	203	241	60 L	220 L	A	
	Nitroanisole, liquid	6.1	UN2730	III	6.1	IB3, T4, TP1	153	203	241	60 L	220 L	A	
	Nitroanisoles, solid	6.1	UN3458	III	6.1	IB8, IP3, T1, TP33	153	213	240	100 kg	200 kg	A	
+	Nitrobenzene	6.1	UN1662	II	6.1	IB2, T7, TP2	153	202	243	5 L	60 L	A	40
				Forbidden									
	m-Nitrobenzene diazonium perchlorate	Forbidden											
	Nitrobenzenesulfonic acid	8	UN2305	II	8	B2, B4, IB8, IP2, IP4, T3, TP33	154	202	242	1 L	30 L	A	53, 58
	Nitrobenzol, see Nitrobenzene												
	5-Nitrobenzotriazol	1.1D	UN0385	1.1D	None	62	None	Forbidden	Forbidden	04	25
	Nitrobenzotrifluorides, liquid	6.1	UN2306	II	6.1	IB2, T7, TP2	153	202	243	5 L	60 L	A	40
	Nitrobenzotrifluorides, solid	6.1	UN3431	II	6.1	IB8, IP2, IP4, T3, TP33	153	212	242	25 kg	100 kg	A	40
	Nitrobromobenzenes, liquid	6.1	UN2732	III	6.1	IB3, T4, TP1	153	203	241	60 L	220 L	A	
	Nitrobromobenzenes, solid	6.1	UN3459	III	6.1	IB8, IP3, T1, TP33	153	213	240	100 kg	200 kg	A	
	Nitrocellulose, dry or wetted with less than 25 percent water (or alcohol), by mass	1.1D	UN0340	1.1D	196	None	62	None	Forbidden	Forbidden	04	25, 27E
	Nitrocellulose, with not more than 12.6 percent nitrogen, by dry mass mixture with or without plasticizer, with or without pigment	4.1	UN2557	II	4.1	44, 197, W31	151	212	None	1 kg	15 kg	D	28, 36
	Nitrocellulose membrane filters, with not more than 12.6% nitrogen, by dry mass	4.1	UN3270	II	4.1	43, A1	151	212	240	1 kg	15 kg	D	
	Nitrocellulose, plasticized with not less than 18 percent plasticizing substance, by mass	1.3C	UN0343	1.3C	196	None	62	None	Forbidden	Forbidden	04	25
	Nitrocellulose, solution, flammable with not more than 12.6 percent nitrogen, by mass, and not more than 55 percent nitrocellulose	3	UN2059	I	3	198, T11, TP1, TP8, TP27	None	201	243	1 L	30 L	E	

§ 172.101 HAZARDOUS MATERIALS TABLE—Continued

Sym-bols (1)	Hazardous materials descriptions and proper shipping names (2)	Hazard class or Division (3)	Identi-fication Numbers (4)	PG (5)	Label Codes (6)	Special provisions (§ 172.102) (7)	(8)			(9)		(10) Vessel stowage	
							Packaging (§ 173.***)			Quantity limitations (see §§ 173.27 and 175.75)		Loca-tion (10A)	Other (10B)
							Excep-tions (8A)	Non-bulk (8B)	Bulk (8C)	Passenger aircraft/rail (9A)	Cargo air-craft only (9B)		
	Nitrocellulose, <i>unmodified or plasti-cized with less than 18 percent plasticizing substance, by mass</i>	1.1D	UN0341	II III	3 3 1.1D	198, IB2, T4, TP1, TP8 196, B1, IB3, T2, TP1 196	150 150 None	202 203 62	242 242 None	5 L 60 L Forbidden	60 L 220 L Forbidden	B A 04	25, 27E
	Nitrocellulose, <i>wetted with not less than 25 percent alcohol, by mass</i>	1.3C	UN0342	1.3C	196	None	62	None	Forbidden	Forbidden	04	25
	Nitrocellulose with alcohol <i>with not less than 25 percent alcohol by mass, and with not more than 12.6 percent nitrogen, by dry mass</i>	4.1	UN2556	II	4.1	197, W31	151	212	None	1 kg	15 kg	D	12, 25, 28, 36
	Nitrocellulose with water <i>with not less than 25 percent water, by mass</i>	4.1	UN2555	II	4.1	197, W31	151	212	None	15 kg	50 kg	E	28, 36
	<i>Nitrochlorobenzene, see Chloronitrobenzenes etc</i>												
	Nitrocresols, liquid	6.1	UN3434	III	6.1	IB3, T4, TP1	153	203	241	60 L	220 L	A	
	Nitrocresols, solid	6.1	UN2446	III	6.1	IB8, IP3, T1, TP33	153	213	240	100 kg	200 kg	A	
	Nitroethane	3	UN2842	III	3	B1, IB3, T2, TP1	150	203	242	60 L	220 L	A	
	<i>Nitroethyl nitrate</i>	Forbidden											
	<i>Nitroethylene polymer</i>	Forbidden											
	Nitrogen, compressed	2.2	UN1066		2.2		306, 307	302	314, 315	75 kg	150 kg	A	
	Nitrogen dioxide, <i>see Dinitrogen tetraoxide</i>												
	<i>Nitrogen fertilizer solution, see Fertilizer ammoniating solution etc</i>												
	<i>Nitrogen peroxide, see Dinitrogen tetraoxide</i>												
	Nitrogen, refrigerated liquid <i>cryo-genic liquid</i>	2.2	UN1977		2.2	345, 346, T75, TP5	320	316	318	50 kg	500 kg	D	
	<i>Nitrogen tetraoxide and nitric oxide mixtures, see Nitric oxide and ni-trogen tetraoxide mixtures</i>												
	<i>Nitrogen tetraoxide, see Dinitrogen tetraoxide</i>												
	<i>Nitrogen trichloride</i>	Forbidden											

§ 172.101

49 CFR Ch. I (10-1-23 Edition)

Nitrogen trifluoride	2.2	UN2451	2.2, 5.1		None	302	None	75 kg	150 kg	D	40
<i>Nitrogen triiodide</i>	Forbidden										
<i>Nitrogen triiodide monoamine</i>	Forbidden										
Nitrogen trioxide	2.3	UN2421	2.3, 5.1, 8	1	None	336	245	Forbidden	Forbidden	D	40, 89, 90
Nitroglycerin, desensitized with not less than 40 percent non-volatile water insoluble phlegmatizer, by mass	1.1D	UN0143 1.1D, 6.1	125	None	62	None	Forbidden	Forbidden	04	25, 21E
<i>Nitroglycerin, liquid, not desensitized</i>	Forbidden										
Nitroglycerin mixture, desensitized, liquid, flammable, n.o.s. with not more than 30 percent nitroglycerin, by mass	3	UN3343	3	129	None	214	None	Forbidden	Forbidden	D	
Nitroglycerin mixture, desensitized, liquid, n.o.s. with not more than 30% nitroglycerin, by mass	3	UN3357	II 3	142	None	202	243	5 L	60 L	E	
Nitroglycerin mixture, desensitized, solid, n.o.s. with more than 2 percent but not more than 10 percent nitroglycerin, by mass	4.1	UN3319	II 4.1	118	None	None	None	Forbidden	0.5 kg	E	
Nitroglycerin, solution in alcohol, with more than 1 percent but not more than 5 percent nitroglycerin	3	UN3064	II 3	N8	None	202	None	Forbidden	5 L	E	
Nitroglycerin, solution in alcohol, with more than 1 percent but not more than 10 percent nitroglycerin	1.1D	UN0144 1.1D	None	62	None	Forbidden	Forbidden	04	25, 21E
Nitroglycerin solution in alcohol with not more than 1 percent nitroglycerin	3	UN1204	II 3	IB2, N34	150	202	None	5 L	60 L	B	
<i>Nitroguanidine nitrate</i>	Forbidden										
Nitroguanidine or Picrite, dry or wetted with less than 20 percent water, by mass	1.1D	UN0282 1.1D	None	62	None	Forbidden	Forbidden	04	25
Nitroguanidine, wetted or Picrite, wetted with not less than 20 percent water, by mass	4.1	UN1336	I 4.1	23, A8, A19, A20, N41, W31	None	211	None	1 kg	15 kg	E	28, 36
<i>1-Nitrohydantoin</i>	Forbidden										
Nitrohydrochloric acid	8	UN1798	I 8	B10, N41, T10, TP2, TP13	None	201	243	Forbidden	2.5 L	D	40, 53, 58, 66, 74, 89, 90
<i>Nitromannite (dry)</i>	Forbidden										
Nitromannite, wetted, see Mannitol hexanitrate, etc											
Nitromethane	3	UN1261	II 3		150	202	None	Forbidden	60 L	A	

§ 172.101 HAZARDOUS MATERIALS TABLE—Continued

Sym-bols (1)	Hazardous materials descriptions and proper shipping names (2)	Hazard class or Division (3)	Identi-fication Numbers (4)	PG (5)	Label Codes (6)	Special provisions (§ 172.102) (7)	(8)			(9)		(10) Vessel stowage	
							Packaging (§ 173.***)			Quantity limitations (see §§ 173.27 and 175.75)		Loca-tion (10A)	Other (10B)
							Excep-tions (8A)	Non-bulk (8B)	Bulk (8C)	Passenger aircraft/rail (9A)	Cargo air-craft only (9B)		
+	<i>Nitromuriatic acid, see Nitrohydrochloric acid</i>	4.1	UN2538	III	4.1	A1, IB8, IP3, T1, TP33	151	213	240	25 kg	100 kg	A	
	Nitronaphthalene	6.1	UN1663	III	6.1	IB8, IP3, T1, TP33	153	213	240	100 kg	200 kg	A	
	Nitrophenols (o-; m-; p-; m-Nitrophenyldinitro methane)	Forbidden											
	4-Nitrophenylhydrazine, with not less than 30 percent water, by mass	4.1	UN3376	I	4.1	162, A8, A19, A20, N41, W31	None	211	None	Forbidden	15 kg	E	28, 36
	Nitropropanes	3	UN2608	III	3	B1, IB3, T2, TP1	150	203	242	60 L	220 L	A	
	p-Nitrosodimethylaniline	4.2	UN1369	II	4.2	A19, A20, IB6, IP2, N34, T3, TP33	None	212	241	15 kg	50 kg	D	34
	Nitrostarch, dry or wetted with less than 20 percent water, by mass	1.1D	UN0146	1.1D	None	62	None	Forbidden	Forbidden	04	25
	Nitrostarch, wetted with not less than 20 percent water, by mass	4.1	UN1337	I	4.1	23, A8, A19, A20, N41, W31	None	211	None	1 kg	15 kg	D	28, 36
	Nitrosugars (dry)	Forbidden											
	Nitrosyl chloride	2.3	UN1069		2.3, 8	3, B14	None	304	314, 315	Forbidden	Forbidden	D	40
	Nitrosylsulfuric acid, liquid	8	UN2308	II	8	A3, A7, B2, IB2, N34, T8, TP2	154	202	242	1 L	30 L	D	40, 53, 58, 66, 74, 89, 90
	Nitrosylsulphuric acid, solid	8	UN3456	II	8	IB8, IP2, IP4, T3, TP33	154	212	240	15 kg	50 kg	D	40, 53, 58, 66, 74, 89, 90
	Nitrotoluenes, liquid	6.1	UN1664	II	6.1	IB2, T7, TP2	153	202	243	5 L	60 L	A	
	Nitrotoluenes, solid	6.1	UN3446	II	6.1	IB8, IP2, IP4, T3, TP33	153	212	242	25 kg	100 kg	A	
	Nitrotoluidines (mono)	6.1	UN2660	III	6.1	IB8, IP3, T1, TP33	153	213	240	100 kg	200 kg	A	
	Nitrotriazolone or NTO	1.1D	UN0490	1.1D	None	62	None	Forbidden	Forbidden	04	25
	Nitrous oxide	2.2	UN1070		2.2, 5.1	A14	306	304	314, 315	75 kg	150 kg	A	40
	Nitrous oxide, refrigerated liquid	2.2	UN2201		2.2, 5.1	B6, T75, TP5, TP22	None	304	314, 315	Forbidden	Forbidden	D	40
Nitroxylenes, liquid	6.1	UN1665	II	6.1	IB2, T7, TP2	153	202	243	5 L	60 L	A		
Nitroxylenes, solid	6.1	UN3447	II	6.1	IB8, IP2, IP4, T3, TP33	153	212	242	25 kg	100 kg	A		
Nitroxylol, see Nitroxylenes													
Nonanes	3	UN1920	III	3	B1, IB3, T2, TP2	150	203	242	60 L	220 L	A		

§ 172.101

49 CFR Ch. I (10-1-23 Edition)

	<i>Non-flammable gas, n.o.s., see Compressed gas, etc. or Liquefied gas, etc</i>													
	<i>Nonliquefied gases, see Compressed gases, etc</i>													
	<i>Nonliquefied hydrocarbon gas, see Hydrocarbon gas mixture, compressed, n.o.s.</i>													
	Nonyltrichlorosilane	8	UN1799	II	8	A7, B2, B6, N34, T10, TP2, TP7, TP13	None	206	242	Forbidden	30 L	C	40, 53,	
	<i>Nordhausen acid, see Sulfuric acid, fuming etc</i>													
	<i>2,5-Norbornadiene, stabilized, see Bicyclo [2.2.1] hepta-2,5-diene, stabilized</i>													
	Octadecyltrichlorosilane	8	UN1800	II	8	A7, B2, B6, N34, T10, TP2, TP7, TP13	None	206	242	Forbidden	30 L	C	40, 53, 58	
	Octadiene	3	UN2309	II	3	B1, IB2, T4, TP1	150	202	242	5 L	60 L	B		
	<i>1,7-Octadine-3,5-diyne-1,8-dimethoxy-9-octadecynoic acid</i>	Forbidden												
	Octafluorobut-2-ene or Refrigerant gas R 1318	2.2	UN2422	2.2	306	304	314, 315	75 kg	150 kg	A		
	Octafluorocyclobutane, or Refrigerant gas RC 318	2.2	UN1976	2.2	T50	306	304	314, 315	75 kg	150 kg	A		
	Octafluoropropane or Refrigerant gas R 218	2.2	UN2424	2.2	T50	306	304	314, 315	75 kg	150 kg	A		
	Octanes etc. see Cyclotetramethylene tetranitramine, etc.	3	UN1262	II	3	IB2, T4, TP2	150	202	242	5 L	60 L	B		
	Octolite or Octol, dry or wetted with less than 15 percent water, by mass	1.1D	UN0266	1.1D	None	62	None	Forbidden	Forbidden	04	25	
	Octonal	1.1D	UN0496	1.1D	None	62	None	Forbidden	Forbidden	04	25	
	Octyl aldehydes	3	UN1191	III	3	B1, IB3, T2, TP1	150	203	242	60 L	220 L	A		
	Octyltrichlorosilane	8	UN1801	II	8	A7, B2, B6, N34, T10, TP2, TP7, TP13	None	206	242	Forbidden	30 L	C	40, 53, 58	
	Oil gas, compressed	2.3	UN1071		2.3, 2.1		6	None	304	314, 315	Forbidden	25 kg	D	40
	<i>Oleum, see Sulfuric acid, fuming</i>													
	<i>Organic peroxide type A, liquid or solid</i>	Forbidden												
G	Organic peroxide type B, liquid	5.2	UN3101	5.2, 1		53	152	225	None	Forbidden	Forbidden	D	12, 25, 52, 53
G	Organic peroxide type B, liquid, temperature controlled	5.2	UN3111	5.2, 1		53	None	225	None	Forbidden	Forbidden	D	2, 25, 52, 53
G	Organic peroxide type B, solid	5.2	UN3102	5.2, 1		53	152	225	None	Forbidden	Forbidden	D	12, 25, 52, 53
G	Organic peroxide type B, solid, temperature controlled	5.2	UN3112	5.2, 1		53	None	225	None	Forbidden	Forbidden	D	2, 25, 52, 53

§ 172.101 HAZARDOUS MATERIALS TABLE—Continued

Sym-bols	Hazardous materials descriptions and proper shipping names	Hazard class or Division	Identi-fication Numbers	PG	Label Codes	Special provisions (§ 172.102)	(8)			(9)		(10) Vessel stowage	
							Packaging (§ 173.***)			Quantity limitations (see §§ 173.27 and 175.75)		Loca-tion	Other
							Excep-tions	Non-bulk	Bulk	Passenger aircraft/rail	Cargo air-craft only		
(1)	(2)	(3)	(4)	(5)	(6)	(7)	(8A)	(8B)	(8C)	(9A)	(9B)	(10A)	(10B)
G	Organic peroxide type C, liquid	5.2	UN3103	5.2	152	225	None	5 L	10 L	D	12, 25, 52, 53
G	Organic peroxide type C, liquid, temperature controlled	5.2	UN3113	5.2	None	225	None	Forbidden	Forbidden	D	2, 25, 52, 53
G	Organic peroxide type C, solid	5.2	UN3104	5.2	152	225	None	5 kg	10 kg	D	12, 25, 52, 53
G	Organic peroxide type C, solid, temperature controlled	5.2	UN3114	5.2	None	225	None	Forbidden	Forbidden	D	2, 25, 52, 53
G	Organic peroxide type D, liquid	5.2	UN3105	5.2	152	225	None	5 L	10 L	D	12, 25, 52, 53
G	Organic peroxide type D, liquid, temperature controlled	5.2	UN3115	5.2	None	225	None	Forbidden	Forbidden	D	2, 25, 52, 53
G	Organic peroxide type D, solid	5.2	UN3106	5.2	152	225	None	5 kg	10 kg	D	12, 25, 52, 53
G	Organic peroxide type D, solid, temperature controlled	5.2	UN3116	5.2	None	225	None	Forbidden	Forbidden	D	2, 25, 52, 53
G	Organic peroxide type E, liquid	5.2	UN3107	5.2	A61	152	225	None	10 L	25 L	D	12, 25, 52, 53
G	Organic peroxide type E, liquid, temperature controlled	5.2	UN3117	5.2	None	225	None	Forbidden	Forbidden	D	2, 25, 52, 53
G	Organic peroxide type E, solid	5.2	UN3108	5.2	152	225	None	10 kg	25 kg	D	12, 25, 52, 53
G	Organic peroxide type E, solid, temperature controlled	5.2	UN3118	5.2	None	225	None	Forbidden	Forbidden	D	2, 25, 52, 53
G	Organic peroxide type F, liquid	5.2	UN3109	5.2	A61, IP5	152	225	225	10 L	25 L	D	12, 25, 52, 53
G	Organic peroxide type F, liquid, temperature controlled	5.2	UN3119	5.2	IP5	None	225	225	Forbidden	Forbidden	D	2, 25, 52, 53
G	Organic peroxide type F, solid	5.2	UN3110	5.2	TP33	152	225	225	10 kg	25 kg	D	12, 25, 52, 53
G	Organic peroxide type F, solid, temperature controlled	5.2	UN3120	5.2	TP33	None	225	225	Forbidden	Forbidden	D	2, 25, 52, 53
D	Organic phosphate, mixed with compressed gas or Organic phosphate compound, mixed with compressed gas or Organic phosphorus compound, mixed with compressed gas	2.3	NA1955		2.3	3	None	334	None	Forbidden	Forbidden	D	40

§ 172.101

49 CFR Ch. I (10-1-23 Edition)

	Organic pigments, self-heating	4.2	UN3313	II	4.2	IB8, IP2, IP4, T3, TP33	None	212	241	15 kg	50 kg	C	
				III	4.2	IB8, IP3, T1, TP33	None	213	241	25 kg	100 kg	C	
G	Organoarsenic compound, liquid, n.o.s.	6.1	UN3280	I	6.1	5, T14, TP2, TP13, TP27	None	201	242	1 L	30 L	B	
				II	6.1	IB2, T11, TP2, TP27	153	202	242	5 L	60 L	B	
				III	6.1	IB3, T7, TP1, TP28	153	203	241	60 L	220 L	A	
G	Organoarsenic compound, solid, n.o.s.	6.1	UN3465	I	6.1	IB7, IP1, T6, TP33	None	211	242	5 kg	50 kg	B	
				II	6.1	IB8, IP2, IP4, T3, TP33	153	212	242	25 kg	100 kg	B	
				III	6.1	IB8, IP3, T1, TP33	153	213	240	100 kg	200 kg	A	
	Organochlorine pesticides liquid, flammable, toxic, flash point less than 23 degrees C	3	UN2762	I	3, 6.1	T14, TP2, TP13, TP27	None	201	243	Forbidden	30 L	B	40
				II	3, 6.1	IB2, T11, TP2, TP13, TP27	150	202	243	1 L	60 L	B	40
	Organochlorine pesticides, liquid, toxic	6.1	UN2996	I	6.1	T14, TP2, TP13, TP27	None	201	243	1 L	30 L	B	40
				II	6.1	IB2, T11, TP2, TP13, TP27	153	202	243	5 L	60 L	B	40
				III	6.1	IB3, T7, TP2, TP28	153	203	241	60 L	220 L	A	40
	Organochlorine pesticides, liquid, toxic, flammable, flash point not less than 23 degrees C	6.1	UN2995	I	6.1, 3	T14, TP2, TP13, TP27	None	201	243	1 L	30 L	B	40
				II	6.1, 3	IB2, T11, TP2, TP13, TP27	153	202	243	5 L	60 L	B	40
				III	6.1, 3	B1, IB3, T7, TP2, TP28	153	203	242	60 L	220 L	A	40
	Organochlorine pesticides, solid, toxic	6.1	UN2761	I	6.1	IB7, IP1, T6, TP33	None	211	242	5 kg	50 kg	A	40
				II	6.1	IB8, IP2, IP4, T3, TP33	153	212	242	25 kg	100 kg	A	40
				III	6.1	IB8, IP3, T1, TP33	153	213	240	100 kg	200 kg	A	40
G	Organometallic compound, liquid, toxic, n.o.s	6.1	UN3282	I	6.1	T14, TP2, TP13, TP27	None	201	242	1 L	30 L	B	
				II	6.1	IB2, T11, TP2, TP27	153	202	242	5 L	60 L	B	
				III	6.1	IB3, T7, TP1, TP28	153	203	241	60 L	220 L	A	
G	Organometallic compound, solid, toxic, n.o.s	6.1	UN3467	I	6.1	IB7, IP1, T6, TP33	None	211	242	5 kg	50 kg	B	
				II	6.1	IB8, IP2, IP4, T3, TP33	153	212	242	25 kg	100 kg	B	
				III	6.1	IB8, IP3, T1, TP33	153	213	240	100 kg	200 kg	A	
G	Organometallic substance, liquid, pyrophoric	4.2	UN3392	I	4.2	B11, T21, TP2, TP7, TP36	None	181	244	Forbidden	Forbidden	D	13, 78, 148
G	Organometallic substance, liquid, pyrophoric, water-reactive	4.2	UN3394	I	4.2, 4.3	B11, T21, TP2, TP7, TP36, TP47	None	181	244	Forbidden	Forbidden	D	13, 52, 78, 148
G	Organometallic substance, liquid, water-reactive	4.3	UN3398	I	4.3	T13, TP2, TP7, TP36, TP47, W31	None	201	244	Forbidden	1 L	D	13, 40, 52, 148
				II	4.3	IB1, IP2, T7, TP2, TP7, TP36, TP47, W31	151	202	243	1 L	5 L	D	13, 40, 52, 148
				III	4.3	IB2, IP4, T7, TP2, TP7, TP36, TP47, W31	151	203	242	5 L	60 L	E	13, 40, 52, 148
G	Organometallic substance, liquid, water-reactive, flammable	4.3	UN3399	I	4.3, 3	T13, TP2, TP7, TP36, TP47, W31	None	201	244	Forbidden	1 L	D	13, 40, 52, 148

§ 172.101 HAZARDOUS MATERIALS TABLE—Continued

§ 172.101

49 CFR Ch. I (10-1-23 Edition)

Sym-bols	Hazardous materials descriptions and proper shipping names	Hazard class or Division	Identi-fication Numbers	PG	Label Codes	Special provisions (§ 172.102)	(8)			(9)		(10) Vessel stowage	
							Packaging (§ 173.***)			Quantity limitations (see §§ 173.27 and 175.75)		Loca-tion	Other
							Excep-tions	Non-bulk	Bulk	Passenger aircraft/rail	Cargo air-craft only		
(1)	(2)	(3)	(4)	(5)	(6)	(7)	(8A)	(8B)	(8C)	(9A)	(9B)	(10A)	(10B)
G	Organometallic substance, solid, pyrophoric	4.2	UN3391	II	4.3, 3	IB1, IP2, T7, TP2, TP7, TP36, TP47, W31	151	202	243	1 L	5 L	D	13, 40, 52, 148
				III	4.3, 3	IB2, IP4, T7, TP2, TP7, TP36, TP47, W31	151	203	242	5 L	60 L	E	13, 40, 52, 148
				I	4.2	T21, TP7, TP33, TP36	None	187	244	Forbidden	Forbidden	D	13, 148
G	Organometallic substance, solid, pyrophoric, water-reactive	4.2	UN3393	I	4.2, 4.3	B11, T21, TP7, TP33, TP36, TP47	None	187	244	Forbidden	Forbidden	D	13, 52, 148
G	Organometallic substance, solid, self-heating	4.2	UN3400	II	4.2	IB6, T3, TP33, TP36	None	212	242	15 kg	50 kg	C	
G	Organometallic substance, solid, water-reactive	4.3	UN3395	III	4.2	IB8, T1, TP33, TP36	None	213	242	25 kg	100 kg	C	
				I	4.3	N40, T9, TP7, TP33, TP36, TP47, W31	None	211	242	Forbidden	15 kg	E	13, 40, 52, 148
				II	4.3	IB4, T3, TP33, TP36, TP47, W31	151	212	242	15 kg	50 kg	E	13, 40, 52, 148
G	Organometallic substance, solid, water-reactive, flammable	4.3	UN3396	III	4.3	IB6, T1, TP33, TP36, TP47, W31	151	213	241	25 kg	100 kg	E	13, 40, 52, 148
				I	4.3, 4.1	N40, T9, TP7, TP33, TP36, TP47, W31	None	211	242	Forbidden	15 kg	E	13, 40, 52, 148
				II	4.3, 4.1	IB4, T3, TP33, TP36, TP47, W31	151	212	242	15 kg	50 kg	E	13, 40, 52, 148
G	Organometallic substance, solid, water-reactive, self-heating	4.3	UN3397	III	4.3, 4.1	IB6, T1, TP33, TP36, TP47, W31	151	213	241	25 kg	100 kg	E	13, 40, 52, 148
				I	4.3, 4.2	N40, T9, TP7, TP33, TP36, TP47, W31	None	211	242	Forbidden	15 kg	E	13, 40, 52, 148
				II	4.3, 4.2	IB4, T3, TP33, TP36, TP47, W31	151	212	242	15 kg	50 kg	E	13, 40, 52, 148
G	Organophosphorus compound, liquid, toxic, n.o.s	6.1	UN3279	III	4.3, 4.2	IB6, T1, TP33, TP36, TP47, W31	151	213	241	25 kg	100 kg	E	13, 40, 52, 148
				I	6.1, 3	5, T14, TP2, TP13, TP27	None	201	243	1 L	30 L	B	40
				II	6.1, 3	IB2, T11, TP2, TP13, TP27	153	202	243	5 L	60 L	B	40
G	Organophosphorus compound, liquid, toxic, n.o.s	6.1	UN3278	I	6.1	5, T14, TP2, TP13, TP27	None	201	243	1 L	30 L	B	
				II	6.1	IB2, T11, TP2, TP27	153	202	243	5 L	60 L	B	
				III	6.1	IB3, T7, TP1, TP28	153	203	241	60 L	220 L	A	

G	Organophosphorus compound, solid, toxic, n.o.s	6.1	UN3464	I	6.1	IB7, IP1, T6, TP33	None	211	242	5 kg	50 kg	B		
				II	6.1	IB8, IP2, IP4, T3, TP33	153	212	242	25 kg	100 kg	B		
	Organophosphorus pesticides, liquid, flammable, toxic, flash point less than 23 degrees C	3	UN2784	I	3, 6.1	T14, TP2, TP13, TP27	None	153	213	240	100 kg	200 kg	A	
								201	243	243	Forbidden	30 L	B	40
				II	3, 6.1	IB2, T11, TP2, TP13, TP27	150	202	243	1 L	60 L	B	40	
	Organophosphorus pesticides, liquid, toxic	6.1	UN3018	I	6.1	N76, T14, TP2, TP13, TP27	None	201	243	243	1 L	30 L	B	40
								153	202	243	5 L	60 L	B	40
	Organophosphorus pesticides, liquid, toxic, flammable, flash point not less than 23 degrees C	6.1	UN3017	I	6.1, 3	IB3, N76, T7, TP2, TP28, N76, T14, TP2, TP13, TP27	None	153	203	241	60 L	220 L	A	40
								201	243	243	1 L	30 L	B	40
								153	202	243	5 L	60 L	B	40
	Organophosphorus pesticides, solid, toxic	6.1	UN2783	I	6.1	IB7, IP1, N77, T6, TP33	None	211	242	242	5 kg	50 kg	A	40
								153	212	242	25 kg	100 kg	A	40
	Organotin compounds, liquid, n.o.s	6.1	UN2788	I	6.1	IB8, IP3, N77, T1, TP33, N33, N34, T14, TP2, TP13, TP27	None	153	213	240	100 kg	200 kg	A	40
								201	243	243	1 L	30 L	B	40
								153	202	243	5 L	60 L	A	40
	Organotin compounds, solid, n.o.s.	6.1	UN3146	I	6.1	A5, IB7, IP1, T6, TP33, IB8, IP2, IP4, T3, TP33, IB8, IP3, T1, TP33	None	153	203	241	60 L	220 L	A	40
								211	242	242	5 kg	50 kg	B	40
								153	212	242	25 kg	100 kg	A	40
	Organotin pesticides, liquid, flammable, toxic, flash point less than 23 degrees C	3	UN2787	I	3, 6.1	T14, TP2, TP13, TP27	None	153	213	240	100 kg	200 kg	A	40
								201	243	243	Forbidden	30 L	B	40
Organotin pesticides, liquid, toxic	6.1	UN3020	I	6.1	IB2, T11, TP2, TP13, TP27	None	150	202	243	1 L	60 L	B	40	
							153	202	243	5 L	60 L	B	40	
Organotin pesticides, liquid, toxic, flammable, flash point not less than 23 degrees C	6.1	UN3019	I	6.1, 3	IB3, T7, TP2, TP28, T14, TP2, TP13, TP27	None	153	203	241	60 L	220 L	A	40	
							201	243	243	1 L	30 L	B	40	
Organotin pesticides, solid, toxic	6.1	UN2786	I	6.1	IB2, T11, TP2, TP13, TP27, B1, IB3, T7, TP2, TP28, IB7, IP1, T6, TP33	None	153	203	242	60 L	220 L	A	40	
							211	242	242	5 kg	50 kg	A	40	

§ 172.101 HAZARDOUS MATERIALS TABLE—Continued

§ 172.101

49 CFR Ch. I (10-1-23 Edition)

Sym-bols	Hazardous materials descriptions and proper shipping names	Hazard class or Division	Identi-fication Numbers	PG	Label Codes	Special provisions (§ 172.102)	(8)			(9)		(10) Vessel stowage	
							Packaging (§ 173.***)			Quantity limitations (see §§ 173.27 and 175.75)		Loca-tion	Other
							Excep-tions	Non-bulk	Bulk	Passenger aircraft/rail	Cargo air-craft only		
(1)	(2)	(3)	(4)	(5)	(6)	(7)	(8A)	(8B)	(8C)	(9A)	(9B)	(10A)	(10B)
	<i>Orthonitroaniline, see Nitroanilines etc</i>			II	6.1	IB8, IP2, IP4, T3, TP33	153	212	242	25 kg	100 kg	A	40
				III	6.1	IB8, IP3, T1, TP33	153	213	240	100 kg	200 kg	A	40
	Osmium tetroxide	6.1	UN2471	I	6.1	A8, IB7, IP1, N33, N34, T6, TP33, W31	None	211	242	5 kg	50 kg	B	40
D G	Other regulated substances, liquid, n.o.s	9	NA3082	III	9	A189, IB3, T2, TP1	155	203	241	No limit	No limit	A	
D G	Other regulated substances, solid, n.o.s	9	NA3077	III	9	384, B54, IB8, IP2, T1, TP33	155	213	240	No limit	No limit	A	
G	Oxidizing liquid, corrosive, n.o.s.	5.1	UN3098	I	5.1, 8	62	None	201	244	Forbidden	2.5 L	D	13, 56, 58, 138
				II	5.1, 8	62, IB1	152	202	243	1 L	5 L	B	13, 56, 58, 138
				III	5.1, 8	62, IB2	152	203	242	2.5 L	30 L	B	13, 56, 58, 138
G	Oxidizing liquid, n.o.s	5.1	UN3139	I	5.1	62, 127, A2	None	201	243	Forbidden	2.5 L	D	56, 58, 138
				II	5.1	62, 127, 148, A2, IB2	152	202	242	1 L	5 L	B	56, 58, 138
				III	5.1	62, 127, 148, A2, IB2	152	203	241	2.5 L	30 L	B	56, 58, 138
G	Oxidizing liquid, toxic, n.o.s	5.1	UN3099	I	5.1, 6.1	62	None	201	244	Forbidden	2.5 L	D	56, 58, 138
				II	5.1, 6.1	62, IB1	152	202	243	1 L	5 L	B	56, 58, 95, 138
				III	5.1, 6.1	62, IB2	152	203	242	2.5 L	30 L	B	56, 58, 95, 138
G	Oxidizing solid, corrosive, n.o.s	5.1	UN3085	I	5.1, 8	62	None	211	242	1 kg	15 kg	D	13, 56, 58, 138
				II	5.1, 8	62, IB6, IP2, T3, TP33	152	212	242	5 kg	25 kg	B	13, 34, 56, 58, 138
				III	5.1, 8	62, IB8, IP3, T1, TP33	152	213	240	25 kg	100 kg	B	13, 34, 56, 58, 138

G	Oxidizing solid, flammable, n.o.s	5.1	UN3137	I	5.1, 4.1	62	None	214	214	Forbidden	Forbidden		13, 147, 148
G	Oxidizing solid, n.o.s.	5.1	UN1479	I	5.1	62, IB5, IP1	None	211	242	1 kg	15 kg	D	56, 58, 106, 138
				II	5.1	62, IB8, IP2, IP4, T3, TP33	152	212	240	5 kg	25 kg	B	56, 58, 106, 138
				III	5.1	62, 148, IB8, IP3, T1, TP33	152	213	240	25 kg	100 kg	B	56, 58, 106, 138
G	Oxidizing solid, self-heating, n.o.s.	5.1	UN3100	I	5.1, 4.2	62	None	214	214	Forbidden	Forbidden		
				II	5.1, 4.2	62	None	214	214	Forbidden	Forbidden		
G	Oxidizing solid, toxic, n.o.s.	5.1	UN3087	I	5.1, 6.1	62	None	211	242	1 kg	15 kg	D	56, 58, 138
				II	5.1, 6.1	62, IB6, IP2, T3, TP33	152	212	242	5 kg	25 kg	B	56, 58, 138
				III	5.1, 6.1	62, IB8, IP3, T1, TP33	152	213	240	25 kg	100 kg	B	56, 58, 138
G	Oxidizing solid, water reactive, n.o.s	5.1	UN3121	I	5.1, 4.3	62	None	214	214	Forbidden	Forbidden		13, 148
				II	5.1, 4.3	62	152	214	214	Forbidden	Forbidden		13, 148
	Oxygen, compressed	2.2	UN1072		2.2, 5.1	110, A14	306	302	314, 315	75 kg	150 kg	A	
	Oxygen difluoride, compressed	2.3	UN2190		2.3, 5.1, 8	1, N86	None	304	None	Forbidden	Forbidden	D	13, 40, 89, 90
	Oxygen generator, chemical (including when contained in associated equipment, e.g., passenger service units (PSUs), portable breathing equipment (PBE), etc)	5.1	UN3356	5.1	None	168	None	Forbidden	25 kg	D	56, 58, 69, 106
+	Oxygen generator, chemical, spent	9	NA3356	III	9	61	None	213	None	Forbidden	Forbidden	A	
	Oxygen, refrigerated liquid (cryogenic liquid)	2.2	UN1073		2.2, 5.1	T75, TP5, TP22	320	316	318	Forbidden	Forbidden	D	
	Paint (including paint, lacquer, enamel, stain, shellac solutions, varnish, polish, liquid filler and liquid lacquer base)	3	UN1263	I	3	367, T11, TP1, TP8, TP27	150	201	243	1 L	30 L	E	
				II	3	149, 367, 383, B52, B131, IB2, T4, TP1, TP8, TP28	150	173	242	5 L	60 L	B	
				III	3	367, B1, B52, B131, IB3, T2, TP1, TP29	150	173	242	60 L	220 L	A	
	Paint or Paint related material	8	UN3066	II	8	367, B2, IB2, T7, TP2, TP28	154	173	242	1 L	30 L	A	40

§ 172.101 HAZARDOUS MATERIALS TABLE—Continued

§ 172.101

49 CFR Ch. I (10-1-23 Edition)

Sym-bols (1)	Hazardous materials descriptions and proper shipping names (2)	Hazard class or Division (3)	Identi-fication Numbers (4)	PG (5)	Label Codes (6)	Special provisions (§ 172.102) (7)	(8)			(9)		(10) Vessel stowage	
							Packaging (§ 173.***)			Quantity limitations (see §§ 173.27 and 175.75)		Loca-tion (10A)	Other (10B)
							Excep-tions (8A)	Non-bulk (8B)	Bulk (8C)	Passenger aircraft/rail (9A)	Cargo air-craft only (9B)		
	Paint, corrosive, flammable (<i>including paint, lacquer, enamel, stain, shellac, varnish, polish, liquid filler, and liquid lacquer base</i>)	8	UN3470	III	8	367, B52, IB3, T4, TP1, TP29	154	173	241	5 L	60 L	A	40
II				8, 3	367, IB2, T7, TP2, TP8, TP28	154	202	243	1 L	30 L	B	40	
	Paint, flammable, corrosive, (<i>including paint, lacquer, enamel, stain, shellac, varnish, polish, liquid filler and liquid lacquer base</i>)	3	UN3469	I	3, 8	367, T11, TP2, TP27	None	201	243	0.5 L	2.5 L	E	40
II				3, 8	367, IB2, T7, TP2, TP8, TP28	150	202	243	1 L	5 L	B	40	
	Paint related material <i>including paint thinning, drying, removing, or reducing compound</i>	3	UN1263	III	3, 8	367, IB3, T4, TP1, TP29	150	203	242	5 L	60 L	A	40
I				3	367, T11, TP1, TP8, TP27	150	201	243	1 L	30 L	E		
	Paint related material <i>including paint thinning or reducing compound</i>	8	UN3470	II	3	149, 367, B52, B131, IB2, T4, TP1, TP8, TP28	150	173	242	5 L	60 L	B	40
III				3	367, B1, B52, B131, IB3, T2, TP1, TP29	150	173	242	60 L	220 L	A	40	
	Paint related material, flammable, corrosive (<i>including paint thinning or reducing compound</i>)	3	UN3469	I	3, 8	367, IB2, T7, TP2, TP8, TP28	154	202	243	1 L	30 L	B	40
II				3, 8	367, IB2, T7, TP2, TP8, TP28	150	202	243	1 L	5 L	B	40	
	Paper, unsaturated oil treated <i>incompletely dried (including carbon paper)</i>	4.2	UN1379	III	3, 8	367, IB3, T4, TP1, TP29	150	203	242	5 L	60 L	A	40
III				4.2	IB8, IP3, W31	None	213	241	Forbidden	Forbidden	A		
	Paraformaldehyde	4.1	UN2213	III	4.1	A1, B120, IB8, IP3, T1, TP33	151	213	240	25 kg	100 kg	A	
	Paraldehyde <i>Paranitroaniline, solid, see Nitroanilines etc</i>	3	UN1264	III	3	B1, IB3, T2, TP1	150	203	242	60 L	220 L	A	

D	Parathion and compressed gas mixture <i>Paris green, solid, see Copper acetoarsenite</i> PCB, <i>see Polychlorinated biphenyls</i> Pentaborane	2.3	NA1967		2.3		3	None	334	245	Forbidden	Forbidden	E	40
+	Pentachloroethane	4.2	UN1380	I	4.2, 6.1		1	None	205	245	Forbidden	Forbidden	D	13, 148
	Pentachlorophenol	6.1	UN1669	II	6.1	IB2, T7, TP2	153	202	243	243	5 L	60 L	A	40
	<i>Pentaerythrite tetranitrate (dry)</i>	Forbidden	UN3155	II	6.1	IB8, IP2, IP4, T3, TP33	153	212	242	25 kg	25 kg	100 kg	A	
	Pentaerythrite tetranitrate mixture, desensitized, solid, n.o.s. or Pentaerythritol tetranitrate mixture, desensitized, solid, n.o.s. or PETN mixture, desensitized, solid, n.o.s., with more than 10 percent but not more than 20 percent PETN, by mass	4.1	UN3344	II	4.1	118, N85	None	214	None	None	Forbidden	Forbidden	E	
	Pentaerythrite tetranitrate or Pentaerythritol tetranitrate or PETN, with not less than 7 percent wax by mass	1.1D	UN0411	1.1D		120	None	62	None	Forbidden	Forbidden	04	25
	Pentaerythrite tetranitrate, wetted or Pentaerythritol tetranitrate, wetted, or PETN, wetted with not less than 25 percent water, by mass, or Pentaerythrite tetranitrate, or Pentaerythritol tetranitrate or PETN, desensitized with not less than 15 percent phlegmatizer by mass	1.1D	UN0150	1.1D		121	None	62	None	Forbidden	Forbidden	04	25
	Pentaerythritol tetranitrate, <i>see</i> Pentaerythrite tetranitrate, <i>etc</i>													
	Pentafluoroethane or Refrigerant gas R 125	2.2	UN3220		2.2	T50	306	304	314, 315	75 kg	150 kg	A		
	Pentamethylheptane	3	UN2286	III	3	B1, IB3, T2, TP1	150	203	242	60 L	220 L	A		
	Pentane-2,4-dione	3	UN2310	III	3, 6.1	B1, IB3, T4, TP1	150	203	242	60 L	220 L	A		
	Pentanes	3	UN1265	I	3	T11, TP2	150	201	243	1 L	30 L	E		
				II	3	IB2, IP8, T4, TP1	150	202	242	5 L	60 L	E		
	<i>Pentanitroaniline (dry)</i>	Forbidden												
	Pentanol	3	UN1105	II	3	IB2, T4, TP1, TP29	150	202	242	5 L	60 L	B		
				III	3	B1, B3, IB3, T2, TP1	150	203	242	60 L	220 L	A		
	1-Pentene (<i>n</i> -amylene)	3	UN1108	I	3	T11, TP2	150	201	243	1 L	30 L	E		
	1-Pentol	8	UN2705	II	8	B2, IB2, T7, TP2	154	202	242	1 L	30 L	B	26, 27	
	Pentolite, dry or wetted with less than 15 percent water, by mass	1.1D	UN0151	1.1D	None	62	None	None	Forbidden	Forbidden	04	25
	<i>Pepper spray, see</i> Aerosols, <i>etc.</i> or Self-defense spray, non-pressurized													

§ 172.101 HAZARDOUS MATERIALS TABLE—Continued

§ 172.101

49 CFR Ch. I (10-1-23 Edition)

Sym-bols (1)	Hazardous materials descriptions and proper shipping names (2)	Hazard class or Division (3)	Identi-fication Numbers (4)	PG (5)	Label Codes (6)	Special provisions (§ 172.102) (7)	(8)			(9)		(10) Vessel stowage	
							Packaging (§ 173.***)			Quantity limitations (see §§ 173.27 and 175.75)		Loca-tion (10A)	Other (10B)
							Excep-tions (8A)	Non-bulk (8B)	Bulk (8C)	Passenger aircraft/rail (9A)	Cargo air-craft only (9B)		
	Perchlorates, inorganic, aqueous solution, n.o.s.	5.1	UN3211	II	5.1	IB2, T4, TP1	152	202	242	1 L	5 L	B	56, 58, 133
				III	5.1	IB2, T4, TP1	152	202	241	2.5 L	30 L	B	56, 58, 69, 133
	Perchlorates, inorganic, n.o.s.	5.1	UN1481	II	5.1	IB6, IP2, T3, TP33	152	212	242	5 kg	25 kg	A	56, 58
	<i>Perchloric acid, with more than 72 percent acid by mass</i>	Forbidden		III	5.1	IB8, IP3, T1, TP33	152	213	240	25 kg	100 kg	A	56, 58
	<i>Perchloric acid with more than 50 percent but not more than 72 percent acid, by mass</i>	5.1	UN1873	I	5.1, 8	A2, N41, T10, TP1	None	201	243	Forbidden	2.5 L	D	53, 58, 66
	<i>Perchloric acid with not more than 50 percent acid by mass</i>	8	UN1802	II	8, 5.1	IB2, N41, T7, TP2	154	202	243	Forbidden	30 L	C	53, 58, 66
	<i>Perchloroethylene, see Tetrachloroethylene</i>												
	Perchloromethyl mercaptan	6.1	UN1670	I	6.1	2, B9, B14, B32, N34, T20, TP2, TP13, TP38, TP45	None	227	244	Forbidden	Forbidden	D	40
	Perchloryl fluoride	2.3	UN3083		2.3, 5.1	2, B9, B14	None	302	314, 315	Forbidden	Forbidden	D	40
	<i>Percussion caps, see Primers, cap type</i>												
	<i>Perfluoro-2-butene, see Octafluorobut-2-ene</i>												
	Perfluoro(ethyl vinyl ether)	2.1	UN3154		2.1		306	302, 304, 305	314, 315	Forbidden	150 kg	E	40
	Perfluoro(methyl vinyl ether)	2.1	UN3153		2.1	T50	306	302, 304, 305	314, 315	Forbidden	150 kg	E	40
	Perfumery products with flammable solvents	3	UN1266	II	3	149, IB2, T4, TP1, TP8	150	202	242	15 L	60 L	B	
				III	3	B1, IB3, T2, TP1	150	203	242	60 L	220 L	A	
G	Permanganates, inorganic, aqueous solution, n.o.s	5.1	UN3214	II	5.1	26, 353, IB2, T4, TP1	152	202	242	1 L	5 L	D	56, 58, 133, 138
G	Permanganates, inorganic, n.o.s	5.1	UN1482	II	5.1	26, 353, A30, IB6, IP2, T3, TP33	152	212	242	5 kg	25 kg	D	56, 58, 138
				III	5.1	26, 353, A30, IB8, IP3, T1, TP33	152	213	240	25 kg	100 kg	D	56, 58, 13

	Permeation devices for calibrating air quality monitoring equipment See § 173.175													
	Peroxides, inorganic, n.o.s.	5.1	UN1483	II	5.1	A7, A20, IB6, IP2, N34, T3, TP33, W100	152	212	242	5 kg	25 kg	C	13, 52, 66, 75, 148	
				III	5.1	A7, A20, B134, IB8, IP21, N34, T1, TP33, W100	152	213	240	25 kg	100 kg	C	13, 52, 66, 75, 148	
	<i>Peroxyacetic acid, with more than 43 percent and with more than 6 percent hydrogen peroxide</i>	Forbidden												
	Persulfates, inorganic, aqueous solution, n.o.s.	5.1	UN3216	III	5.1	IB2, T4, TP1, TP29	152	203	241	2.5 L	30 L	A	56, 58, 133	
	Persulfates, inorganic, n.o.s.	5.1	UN3215	III	5.1	IB8, IP3, T1, TP33	152	213	240	25 kg	100 kg	A	56, 58	
G	Pesticides, liquid, flammable, toxic, flash point less than 23 degrees C	3	UN3021	I	3, 6.1	B5, T14, TP2, TP13, TP27	None	201	243	Forbidden	30 L	B	40	
G	Pesticides, liquid, toxic, flammable, n.o.s. flash point not less than 23 degrees C	6.1	UN2903	I	6.1, 3	T14, TP2, TP13, TP27	None	201	243	1 L	30 L	B	40	
				II	6.1, 3	IB2, T11, TP2, TP13, TP27	153	202	243	5 L	60 L	B	40	
G	Pesticides, liquid, toxic, n.o.s.	6.1	UN2902	III	6.1, 3	B1, IB3, T7, TP2	153	203	242	60 L	220 L	A	40	
				I	6.1	T14, TP2, TP13, TP27	None	201	243	1 L	30 L	B	40	
				II	6.1	IB2, T11, TP2, TP13, TP27	153	202	243	5 L	60 L	B	40	
G	Pesticides, solid, toxic, n.o.s.	6.1	UN2588	III	6.1	IB3, T7, TP2, TP28	153	203	241	60 L	220 L	A	40	
				I	6.1	IB7, T6, TP33	None	211	242	5 kg	50 kg	A	40	
				II	6.1	IB8, IP2, IP4, T3, TP33	153	212	242	25 kg	100 kg	A	40	
				III	6.1	IB8, IP3, T1, TP33	153	213	240	100 kg	200 kg	A	40	
	PETN, see Pentaerythrite tetranitrate													
	PETN/TNT, see Pentolite, etc													
	Petrol, see Gasoline													
	Petroleum crude oil	3	UN1267	I	3	144, 357, T11, TP1, TP8	150	201	243	1 L	30 L	E		
				II	3	144, 357, IB2, T4, TP1, TP8	150	202	242	5 L	60 L	B		
				III	3	144, 357, B1, IB3, T2, TP1	150	203	242	60 L	220 L	A		
	Petroleum distillates, n.o.s. or Petroleum products, n.o.s.	3	UN1268	I	3	144, T11, TP1, TP8	150	201	243	1 L	30 L	E		
				II	3	144, IB2, T7, TP1, TP8, TP28	150	202	242	5 L	60 L	B		
				III	3	144, B1, IB3, T4, TP1, TP29	150	203	242	60 L	220 L	A		
	Petroleum gases, liquefied or Liquefied petroleum gas	2.1	UN1075	2.1	T50, N95	306	304	314, 315	Forbidden	150 kg	E	40	
D	Petroleum oil	3	NA1270	I	3	144, T11, TP1	None	201	243	1 L	30 L	E		

§ 172.101 HAZARDOUS MATERIALS TABLE—Continued

Sym-bols	Hazardous materials descriptions and proper shipping names	Hazard class or Division	Identi-fication Numbers	PG	Label Codes	Special provisions (§ 172.102)	(8)			(9)		(10) Vessel stowage	
							Packaging (§ 173.***)			Quantity limitations (see §§ 173.27 and 175.75)		Loca-tion	Other
							Excep-tions	Non-bulk	Bulk	Passenger aircraft/rail	Cargo air-craft only		
(1)	(2)	(3)	(4)	(5)	(6)	(7)	(8A)	(8B)	(8C)	(9A)	(9B)	(10A)	(10B)
I + +	Petroleum sour crude oil, flammable, toxic	3	UN3494	II	3	144, IB2, T7, TP1, TP8, TP28	150	202	242	5 L	60 L	B	40
				III	3	144, B1, IB3, T4, TP1, TP29	150	203	242	60 L	220 L	A	
				I	3, 6.1	343, T14, TP2, TP13	None	201	243	Forbidden	30 L	D	
	Phenacyl bromide	6.1	UN2645	II	3, 6.1	343, IB2, T7, TP2	150	202	243	1 L	60 L	D	
				III	3, 6.1	343, IB3, T4, TP1	150	203	242	60 L	220 L	C	
	Phenetidines	6.1	UN2311	II	6.1	IB8, IP2, IP4, T3, TP33	153	212	242	25 kg	100 kg	B	
				III	6.1	IB3, T4, TP1	153	203	241	60 L	220 L	A	
	Phenol, molten	6.1	UN2312	II	6.1	B14, T7, TP3	None	202	243	Forbidden	Forbidden	B	
				I	6.1	IB8, IP2, IP4, N78, T3, TP33	153	212	242	25 kg	100 kg	A	
	Phenol, solid	6.1	UN1671	II	6.1	IB2, T7, TP2	153	202	243	5 L	60 L	A	
				III	6.1	IB3, T4, TP1	153	203	241	60 L	220 L	A	
	Phenol solutions	6.1	UN2821	II	6.1	IB2, T7, TP2	153	202	243	5 L	60 L	A	
	Phenolsulfonic acid, liquid	8	UN1803	III	6.1	IB3, T4, TP1	153	203	241	60 L	220 L	A	
				II	8	B2, IB2, N41, T7, TP2	154	202	242	1 L	30 L	C	
	Phenoxyacetic acid derivative pesticide, liquid, flammable, toxic flash point less than 23 degrees C	3	UN3346	I	3, 6.1	T14, TP2, TP13, TP27	None	201	243	Forbidden	30 L	B	
II				3, 6.1	IB2, T11, TP2, TP13, TP27	150	202	243	1 L	60 L	B		
Phenoxyacetic acid derivative pesticide, liquid, toxic	6.1	UN3348	I	6.1	T14, TP2, TP13, TP27	None	201	243	1 L	30 L	B		
			II	6.1	IB2, T11, TP2, TP27	153	202	243	5 L	60 L	B		
Phenoxyacetic acid derivative pesticide, liquid, toxic, flammable, flash point not less than 23 degrees C	6.1	UN3347	III	6.1	IB3, T7, TP2, TP28	153	203	241	60 L	220 L	A		
			I	6.1, 3	T14, TP2, TP13, TP27	None	201	243	1 L	30 L	B		
Phenoxyacetic acid derivative pesticide, solid, toxic	6.1	UN3345	II	6.1, 3	IB2, T11, TP2, TP13, TP27	153	202	243	5 L	60 L	B		
			III	6.1, 3	IB3, T7, TP2, TP28	153	203	241	60 L	220 L	A		
			I	6.1	IB7, IP1, T6, TP33	None	211	242	5 kg	50 kg	A		
II	6.1	IB8, IP2, IP4, T3, TP33	153	212	242	25 kg	100 kg	A					
III	6.1	IB8, IP3, T1, TP33	153	213	240	100 kg	200 kg	A					

§ 172.101

49 CFR Ch. I (10-1-23 Edition)

	Phenyl chloroformate	6.1	UN2746	II	6.1, 8	IB2, T7, TP2, TP13	153	202	243	1 L	30 L	A	12, 13, 25, 40, 53, 58
	Phenyl isocyanate	6.1	UN2487	I	6.1, 3	2, B9, B14, B32, B77, N33, N34, T20, TP2, TP13, TP38, TP45	None	227	244	Forbidden	Forbidden	D	40
	Phenyl mercaptan	6.1	UN2337	I	6.1, 3	2, B9, B14, B32, B77, T20, TP2, TP13, TP38, TP45	None	227	244	Forbidden	Forbidden	D	40, 52
	Phenyl phosphorus dichloride	8	UN2798	II	8	B2, B15, IB2, T7, TP2	154	202	242	Forbidden	30 L	B	40, 53, 58
	Phenyl phosphorus thiodichloride	8	UN2799	II	8	B2, B15, IB2, T7, TP2	154	202	242	Forbidden	30 L	B	40, 53, 58
	Phenyl urea pesticides, liquid, toxic	6.1	UN3002	I	6.1	T14, TP2, TP27	None	201	243	1 L	30 L	B	40
				II	6.1	T7, TP2	None	202	243	5 L	60 L	B	40
				III	6.1	T4, TP1	153	203	241	60 L	220 L	A	40
	Phenylacetone nitrile, liquid	6.1	UN2470	III	6.1	IB3, T4, TP1	153	203	241	60 L	220 L	A	52
	Phenylacetyl chloride	8	UN2577	II	8	B2, IB2, T7, TP2	154	202	242	1 L	30 L	C	40, 53, 58
	Phenylcarbylamine chloride	6.1	UN1672	I	6.1	2, B9, B14, B32, T20, TP2, TP13, TP38, TP45	None	227	244	Forbidden	Forbidden	D	40
	<i>m</i> -Phenylene diaminediperchlorate (dry)	Forbidden											
+	Phenylenediamines (<i>o</i> -; <i>m</i> -; <i>p</i> -)	6.1	UN1673	III	6.1	IB8, IP3, T1, TP33	153	213	240	100 kg	200 kg	A	
	Phenylhydrazine	6.1	UN2572	II	6.1	IB2, T7, TP2	153	202	243	5 L	60 L	A	40
	Phenylmercuric acetate	6.1	UN1674	II	6.1	IB8, IP2, IP4, T3, TP33	153	212	242	25 kg	100 kg	A	
G	Phenylmercuric compounds, n.o.s.	6.1	UN2026	I	6.1	IB7, IP1, T6, TP33	None	211	242	5 kg	50 kg	A	
				II	6.1	IB8, IP2, IP4, T3, TP33	153	212	242	25 kg	100 kg	A	
				III	6.1	IB8, IP3, T1, TP33	153	213	240	100 kg	200 kg	A	
	Phenylmercuric hydroxide	6.1	UN1894	II	6.1	IB8, IP2, IP4, T3, TP33	153	212	242	25 kg	100 kg	A	
	Phenylmercuric nitrate	6.1	UN1895	II	6.1	IB8, IP2, IP4, T3, TP33	153	212	242	25 kg	100 kg	A	
	Phenyltrichlorosilane	8	UN1804	II	8	A7, B6, N34, T10, TP2, TP7, TP13	None	206	242	Forbidden	30 L	C	40, 53, 58
	Phosgene	2.3	UN1076	2.3, 8	1, B7, B46, N86	None	192	314	Forbidden	Forbidden	D	40
	9-Phosphabicyclononanes	4.2	UN2940	II	4.2	A19, IB6, IP2, T3, TP33, W31	None	212	241	15 kg	50 kg	A	
	Cyclooctadiene phosphines												
	Phosphine	2.3	UN2199		2.3, 2.1	1	None	192	245	Forbidden	Forbidden	D	40
	Phosphine, adsorbed	2.3	UN3525	2.3, 2.1	1	None	302c	None	Forbidden	Forbidden	D	40
	Phosphoric acid solution	8	UN1805	III	8	A7, IB3, N34, T4, TP1	154	203	241	5 L	60 L	A	53, 58
	Phosphoric acid, solid	8	UN3453	III	8	IB8, IP3, T1, TP33	154	213	240	25 kg	100 kg	A	53, 58
	Phosphoric acid triethyleimine, see Tris-(1-aziridyl)phosphine oxide, solution												
	Phosphoric anhydride, see Phosphorus pentoxide												
	Phosphorous acid	8	UN2834	III	8	IB8, IP3, T1, TP33	154	213	240	25 kg	100 kg	A	25, 53, 58

§ 172.101 HAZARDOUS MATERIALS TABLE—Continued

Sym-bols (1)	Hazardous materials descriptions and proper shipping names (2)	Hazard class or Division (3)	Identi-fication Numbers (4)	PG (5)	Label Codes (6)	Special provisions (§ 172.102) (7)	(8)			(9)		(10) Vessel stowage	
							Packaging (§ 173.***)			Quantity limitations (see §§ 173.27 and 175.75)		Loca-tion (10A)	Other (10B)
							Excep-tions (8A)	Non-bulk (8B)	Bulk (8C)	Passenger aircraft/rail (9A)	Cargo air-craft only (9B)		
	Phosphorus, amorphous	4.1	UN1338	III	4.1	A1, A19, B1, B9, B26, IB8, IP3, T1, TP33	151	213	243	25 kg	100 kg	A	74
	<i>Phosphorus bromide, see Phosphorus tribromide</i>												
	<i>Phosphorus chloride, see Phosphorus trichloride</i>												
	Phosphorus heptasulfide, <i>free from yellow or white phosphorus</i>	4.1	UN1339	II	4.1	A20, IB4, N34, T3, TP33, W31	151	212	240	15 kg	50 kg	B	13, 74, 147, 148
	Phosphorus oxybromide	8	UN1939	II	8	B8, IB8, IP2, IP4, N41, N43, T3, TP33	154	212	240	Forbidden	50 kg	C	12, 25, 40, 53, 58
	Phosphorus oxybromide, molten	8	UN2576	II	8	B2, B8, IB1, N41, N43, T7, TP3, TP13	None	202	242	Forbidden	Forbidden	C	40, 53, 58
+	Phosphorus oxychloride	6.1	UN1810	I	6.1, 8	2, B9, B14, B32, B77, N34, T20, TP2, TP13, TP38, TP45	None	227	244	Forbidden	Forbidden	D	40
	Phosphorus pentabromide	8	UN2691	II	8	A7, IB8, IP2, IP4, N34, T3, TP33	154	212	240	Forbidden	50 kg	B	12, 25, 40, 53, 55, 58
	Phosphorus pentachloride	8	UN1806	II	8	A7, IB8, IP2, IP4, N34, T3, TP33	154	212	240	Forbidden	50 kg	C	40, 44, 53, 58, 89, 100, 141
	Phosphorus Pentafluoride	2.3	UN2198		2.3, 8	2, B9, B14	None	302, 304	314, 315	Forbidden	Forbidden	D	40
	Phosphorus pentafluoride, adsorbed	2.3	UN3524	2.3, 8	2, B9, B14	None	302c	None	Forbidden	Forbidden	D	40
	Phosphorus pentasulfide, <i>free from yellow or white phosphorus</i>	4.3	UN1340	II	4.3, 4.1	A20, B59, IB4, T3, TP33, W31, W40	151	212	242	15 kg	50 kg	B	13, 74, 148
	Phosphorus pentoxide	8	UN1807	II	8	A7, IB8, IP2, IP4, N34, T3, TP33	154	212	240	15 kg	50 kg	A	53, 58
	Phosphorus sesquisulfide, <i>free from yellow or white phosphorus</i>	4.1	UN1341	II	4.1	A20, IB4, N34, T3, TP33, W31	151	212	240	15 kg	50 kg	B	74
	Phosphorus tribromide	8	UN1808	II	8	A3, A7, B2, B25, IB2, N34, N43, T7, TP2	154	202	242	Forbidden	30 L	C	40, 53, 58

§ 172.101

49 CFR Ch. I (10-1-23 Edition)

Phosphorus trichloride	6.1	UN1809	I	6.1, 8	2, B9, B14, B15, B32, B77, N34, T20, TP2, TP13, TP38, TP45	None	227	244	Forbidden	Forbidden	C	40, 53, 58
Phosphorus trioxide	8	UN2578	III	8	IB8, IP3, T1, TP33	154	213	240	25 kg	100 kg	A	12, 25, 53, 58
Phosphorus trisulfide, <i>free from yellow or white phosphorus</i>	4.1	UN1343	II	4.1	A20, IB4, N34, T3, TP33, W31	151	212	240	15 kg	50 kg	B	13, 74, 147, 148
Phosphorus, white dry or Phosphorus, white, under water or Phosphorus white, in solution or Phosphorus, yellow dry or Phosphorus, yellow, under water or Phosphorus, yellow, in solution	4.2	UN1381	I	4.2, 6.1	B9, B26, N34, T9, TP3, TP31, W31	None	188	243	Forbidden	Forbidden	E	
Phosphorus white, molten	4.2	UN2447	I	4.2, 6.1	B9, B26, N34, T21, TP3, TP7, TP26	None	188	243	Forbidden	Forbidden	D	
<i>Phosphorus (white or red) and a chlorate, mixtures of</i>	Forbidden											
<i>Phosphoryl chloride, see Phosphorus oxychloride</i>												
Phthalic anhydride with more than .05 percent maleic anhydride	8	UN2214	III	8	IB8, IP3, T1, TP33	154	213	240	25 kg	100 kg	A	53, 58
Picolines	3	UN2313	III	3	B1, IB3, T4, TP1	150	203	242	60 L	220 L	A	40
Picric acid, <i>see</i> Trinitrophenol, <i>etc</i>												
Picrite, <i>see</i> Nitroguanidine, <i>etc</i>												
Picryl chloride, <i>see</i> Trinitrochlorobenzene												
Pine oil	3	UN1272	III	3	B1, IB3, T2, TP2	150	203	242	60 L	220 L	A	
alpha-Pinene	3	UN2368	III	3	B1, IB3, T2, TP2	150	203	242	60 L	220 L	A	
Piperazine	8	UN2579	III	8	IB8, IP3, T1, TP33	154	213	240	25 kg	100 kg	A	12, 25, 52
Piperidine	8	UN2401	I	8, 3	A10, T10, TP2	None	201	243	0.5 L	2.5 L	B	52
<i>Pivaloyl chloride, see Trimethylacetyl chloride</i>												
Plastic molding compound in dough, sheet or extruded rope form evolving flammable vapor	9	UN3314	III	9	32, IB8, IP3, IP7	155	221	221	100 kg	200 kg	E	21, 25, 87, 144
<i>Plastic solvent, n.o.s., see Flammable liquids, n.o.s.</i>												
Plastics, nitrocellulose-based, self-heating, n.o.s.	4.2	UN2006	III	4.2		None	213	None	Forbidden	Forbidden	C	
<i>Poisonous gases, n.o.s., see Compressed or liquefied gases, flammable or toxic, n.o.s.</i>												
<i>Polyalkylamines, n.o.s., see Amines, etc</i>												
Polyamines, flammable, corrosive, n.o.s. <i>see</i> Amines, flammable, corrosive, n.o.s												

§ 172.101 HAZARDOUS MATERIALS TABLE—Continued

Sym-bols	Hazardous materials descriptions and proper shipping names	Hazard class or Division	Identi-fication Numbers	PG	Label Codes	Special provisions (§ 172.102)	(8)			(9)		(10) Vessel stowage	
							Packaging (§ 173.***)			Quantity limitations (see §§ 173.27 and 175.75)		Loca-tion	Other
							Excep-tions	Non-bulk	Bulk	Passenger aircraft/rail	Cargo air-craft only		
(1)	(2)	(3)	(4)	(5)	(6)	(7)	(8A)	(8B)	(8C)	(9A)	(9B)	(10A)	(10B)
	Polyamines, liquid, corrosive, n.o.s. <i>see</i> Amines, liquid, corrosive, n.o.s												
	Polyamines, liquid, corrosive, flammable, n.o.s. <i>see</i> Amines, liquid, corrosive, flammable, n.o.s												
	Polychlorinated biphenyls, liquid	9	UN2315	II	9	9, 81, 140, IB3, T4, TP1	155	202	241	100 L	220 L	A	95
	Polychlorinated biphenyls, solid	9	UN3432	III	9	9, 81,140, IB8, IP2, IP4, T3, TP33	155	212	240	100 kg	200 kg	A	95
	Polyester resin kit, <i>liquid base material</i>	3	UN3269	3	40, 149	165	165	None	5 kg	5 kg	B	
	Polyester resin kit, <i>solid base material</i>	4.1	UN3527	4.1	40, 157	165	165	None	5 kg	5 kg	B	
	Polyhalogenated biphenyls, liquid or Halogenated monomethyldiphenyl-methanes, liquid or Polyhalogenated terphenyls, liquid	9	UN3151	II	9	IB2	155	204	241	100 L	220 L	A	95
	Polyhalogenated biphenyls, solid or Halogenated monomethyldiphenyl-methanes, solid or Polyhalogenated terphenyls, solid	9	UN3152	II	9	IB8, IP2, IP4, T3, TP33	155	204	241	100 kg	200 kg	A	95
	Polymeric beads expandable, <i>evolving flammable vapor</i>	9	UN2211	III	9	32, IB8, IP3, IP7, T1, TP33	155	221	221	100 kg	200 kg	E	21, 25, 87, 144
G	Polymerizing substance, liquid, stabilized, n.o.s	4.1	UN3532	III	4.1	387, 421, IB3, IP19, N92, T7, TP4, TP6	None	203	241	10 L	25 L	D	25, 52, 53
G	Polymerizing substance, liquid, temperature controlled, n.o.s	4.1	UN3534	III	4.1	387, 421, IB3, IP19, N92, T7, TP4, TP6	None	203	241	Forbidden	Forbidden	D	2, 25, 52, 53
G	Polymerizing substance, solid, stabilized, n.o.s	4.1	UN3531	III	4.1	387, 421, IB7, IP19, N92, T7, TP4, TP6, TP33	None	213	240	10 kg	25 kg	D	25, 52, 53
G	Polymerizing substance, solid, temperature controlled, n.o.s	4.1	UN3533	III	4.1	387, 421, IB7, IP19, N92, T7, TP4, TP6, TP33	None	213	240	Forbidden	Forbidden	D	2, 25, 52, 53

§ 172.101

49 CFR Ch. I (10-1-23 Edition)

Potassium	4.3	UN2257	I	4.3	A7, A19, A20, B27, IB4, IP1, N6, N34, T9, TP7, TP33, W31	151	211	244	Forbidden	15 kg	D	13, 52, 148
Potassium arsenate	6.1	UN1677	II	6.1	IB8, IP2, IP4, T3, TP33	153	212	242	25 kg	100 kg	A	
Potassium arsenite	6.1	UN1678	II	6.1	IB8, IP2, IP4, T3, TP33	153	212	242	25 kg	100 kg	A	
<i>Potassium bisulfite solution, see Bisulfites, aqueous solutions, n.o.s.</i>												
Potassium borohydride	4.3	UN1870	I	4.3	A19, N40, W31	None	211	242	Forbidden	15 kg	E	13, 52, 148
Potassium bromate	5.1	UN1484	II	5.1	IB8, IP2, IP4, T3, TP33	152	212	242	5 kg	25 kg	A	56, 58
<i>Potassium carbonyl</i>	Forbidden											
Potassium chlorate	5.1	UN1485	II	5.1	A9, IB8, IP2, IP4, N34, T3, TP33	152	212	242	5 kg	25 kg	A	56, 58
Potassium chlorate, aqueous solution	5.1	UN2427	II	5.1	A2, IB2, T4, TP1	152	202	241	1 L	5 L	B	56, 58, 133
			III	5.1	A2, IB2, T4, TP1	152	203	241	2.5 L	30 L	B	56, 58, 69, 133
<i>Potassium chlorate mixed with mineral oil, see Explosive, blasting, type C</i>												
Potassium cuprocyanide	6.1	UN1679	II	6.1	IB8, IP2, IP4, T3, TP33	153	212	242	25 kg	100 kg	A	52
Potassium cyanide, solid	6.1	UN1680	I	6.1	B69, B77, IB7, IP1, N74, N75, T6, TP33, W31	None	211	242	5 kg	50 kg	B	52
Potassium cyanide solution	6.1	UN3413	I	6.1	B69, B77, N74, N75, T14, TP2, TP13, W31	None	201	243	1 L	30 L	B	52
			II	6.1	B69, B77, IB2, N74, N75, T11, TP2, TP13, TP27, W31	153	202	243	5 L	60 L	B	52
			III	6.1	B69, B77, IB3, N74, N75, T7, TP2, TP13, TP28, W31	153	203	241	60 L	220 L	A	52
<i>Potassium dichloro isocyanurate or Potassium dichloro-s-triazinetrione, see Dichloroisocyanuric acid, dry or Dichloroisocyanuric acid salts etc</i>												
Potassium dithionite or Potassium hydrosulfite	4.2	UN1929	II	4.2	A8, A19, A20, IB6, IP2, T3, TP33, W31	None	212	241	15 kg	50 kg	E	13
Potassium fluoride, solid	6.1	UN1812	III	6.1	IB8, IP3, T1, TP33	153	213	240	100 kg	200 kg	A	52
Potassium fluoride solution	6.1	UN3422	III	6.1	IB3, T4, TP1	153	203	241	60 L	220 L	A	52
Potassium fluoroacetate	6.1	UN2628	I	6.1	IB7, IP1, T6, TP33	None	211	242	5 kg	50 kg	E	
Potassium fluorosilicate	6.1	UN2655	III	6.1	IB8, IP3, T1, TP33	153	213	240	100 kg	200 kg	A	52
<i>Potassium hydrate, see Potassium hydroxide, solid</i>												
<i>Potassium hydrogen fluoride, see Potassium hydrogen difluoride</i>												
<i>Potassium hydrogen fluoride solution, see Corrosive liquid, n.o.s.</i>												

§ 172.101 HAZARDOUS MATERIALS TABLE—Continued

Sym-bols (1)	Hazardous materials descriptions and proper shipping names (2)	Hazard class or Division (3)	Identi-fication Numbers (4)	PG (5)	Label Codes (6)	Special provisions (§ 172.102) (7)	(8)			(9)		(10) Vessel stowage	
							Packaging (§ 173.***)			Quantity limitations (see §§ 173.27 and 175.75)		Loca-tion (10A)	Other (10B)
							Excep-tions (8A)	Non-bulk (8B)	Bulk (8C)	Passenger aircraft/rail (9A)	Cargo air-craft only (9B)		
	Potassium hydrogen sulfate	8	UN2509	II	8	A7, IB8, IP2, IP4, N34, T3, TP33	154	212	240	15 kg	50 kg	A	53, 58
	Potassium hydrogendifluoride solid	8	UN1811	II	8, 6.1	IB8, IP2, IP4, N3, N34, T3, TP33	154	212	240	15 kg	50 kg	A	25, 40, 52, 53, 58
	Potassium hydrogendifluoride solution	8	UN3421	II	8, 6.1	IB2, N3, N34, T7, TP2	154	202	243	1 L	30 L	A	25, 40, 52, 53, 58
				III	8, 6.1	IB3, N3, N34, T4, TP1	154	203	241	5 L	60 L	A	40, 52, 53, 58
	Potassium hydrosulfite, <i>see</i> Potassium dithionite												
	Potassium hydroxide, liquid, <i>see</i> Potassium hydroxide solution												
	Potassium hydroxide, solid	8	UN1813	II	8	IB8, IP2, IP4, T3, TP33	154	212	240	15 kg	50 kg	A	52.
	Potassium hydroxide, solution	8	UN1814	II	8	B2, IB2, T7, TP2	154	202	242	1 L	30 L	A	52.
				III	8	IB3, T4, TP1	154	203	241	5 L	60 L	A	52.
	Potassium hypochlorite, solution, <i>see</i> Hypochlorite solutions, <i>etc</i>												
	Potassium, metal alloys, liquid	4.3	UN1420	I	4.3	A7, A19, A20, B27, W31	None	201	244	Forbidden	1 L	E	13, 40, 52, 148
	Potassium, metal alloys, solid	4.3	UN3403	I	4.3	A19, A20, B27, IB4, IP1, T9, TP7, TP33, W31	None	211	244	Forbidden	15 kg	D	13, 52, 148
	Potassium metavanadate	6.1	UN2864	II	6.1	IB8, IP2, IP4, T3, TP33	153	212	242	25 kg	100 kg	A	
	Potassium monoxide	8	UN2033	II	8	IB8, IP2, IP4, T3, TP33	154	212	240	15 kg	50 kg	A	29, 52.
	Potassium nitrate	5.1	UN1486	III	5.1	A1, A29, B120 IB8, IP3, T1, TP33, W1	152	213	240	25 kg	100 kg	A	
	Potassium nitrate and sodium nitrite mixtures	5.1	UN1487	II	5.1	B78, IB8, IP2, IP4, T3, TP33	152	212	240	5 kg	25 kg	A	56, 58
	Potassium nitrite	5.1	UN1488	II	5.1	IB8, IP2, IP4, T3, TP33	152	212	242	5 kg	25 kg	A	56, 58
	Potassium perchlorate	5.1	UN1489	II	5.1	IB6, IP2, T3, TP33	152	212	242	5 kg	25 kg	A	56, 58
	Potassium permanganate	5.1	UN1490	II	5.1	IB8, IP2, IP4, T3, TP33	152	212	240	5 kg	25 kg	D	56, 58, 138
	Potassium peroxide	5.1	UN1491	I	5.1	A20, IB6, IP1, N34	None	211	None	Forbidden	15 kg	C	13, 52, 66, 75, 148
	Potassium persulfate	5.1	UN1492	III	5.1	A1, A29, IB8, IP3, T1, TP33	152	213	240	25 kg	100 kg	A	58, 145

§ 172.101

49 CFR Ch. I (10-1-23 Edition)

Potassium phosphide	4.3	UN2012	I	4.3, 6.1	A19, N40, W31	None	211	None	Forbidden	15 kg	E	13, 40, 52, 85, 148
<i>Potassium selenate, see Selenates or Selenites</i>												
<i>Potassium selenite, see Selenates or Selenites</i>												
Potassium sodium alloys, liquid	4.3	UN1422	I	4.3	A7, A19, B27, N34, N40, T9, TP3, TP7, TP31, W31	None	201	244	Forbidden	1 L	E	13, 40, 52, 148
Potassium sodium alloys, solid	4.3	UN3404	I	4.3	A19, B27, N34, N40, T9, TP7, TP33, W31	None	211	244	Forbidden	15 kg	D	13, 52, 148
Potassium sulfide, anhydrous or Potassium sulfide with less than 30 percent water of crystallization	4.2	UN1382	II	4.2	A19, A20, B16, IB6, IP2, N34, T3, TP33, W31, W40	None	212	241	15 kg	50 kg	A	52
Potassium sulfide, hydrated with not less than 30 percent water of crystallization	8	UN1847	II	8	IB8, IP2, IP4, T3, TP33	154	212	240	15 kg	50 kg	A	52
Potassium superoxide	5.1	UN2466	I	5.1	A20, IB6, IP1	None	211	None	Forbidden	15 kg	D	13, 52, 66, 75, 148
Powder cake, wetted or Powder paste, wetted with not less than 17 percent alcohol by mass	1.1C	UN0433	1.1C	None	62	None	Forbidden	Forbidden	04	25
Powder cake, wetted or Powder paste, wetted with not less than 25 percent water, by mass	1.3C	UN0159	1.3C	None	62	None	Forbidden	Forbidden	04	25
Powder paste, see Powder cake, etc												
Powder, smokeless	1.1C	UN0160	1.1C	None	62	None	Forbidden	Forbidden	04	25, 26E
Powder, smokeless	1.3C	UN0161	1.3C	None	62	None	Forbidden	Forbidden	04	25, 26E
Powder, smokeless	1.4C	UN0509	1.4C	16	171	62	None	Forbidden	75 kg	02	25
<i>Power device, explosive, see Cartridges, power device</i>												
Primers, cap type	1.4S	UN0044	None	None	62	None	25 kg	100 kg	01	25
Primers, cap type	1.1B	UN0377	1.1B	None	62	None	Forbidden	Forbidden	05	25
Primers, cap type	1.4B	UN0378	1.4B	None	62	None	Forbidden	75 kg	05	25
<i>Primers, small arms, see Primers, cap type</i>												
Primers, tubular	1.3G	UN0319	1.3G	None	62	None	Forbidden	Forbidden	03	25
Primers, tubular	1.4G	UN0320	1.4G	None	62	None	Forbidden	75 kg	02	25
Primers, tubular	1.4S	UN0376	None	None	62	None	25 kg	100 kg	01	25
Printing ink, flammable or Printing ink related material (including printing ink thinning or reducing compound), flammable	3	UN1210	I	3	367, T11, TP1, TP8	150	173	243	1 L	30 L	E	
			II	3	149, 367, IB2, T4, TP1, TP8	150	173	242	5 L	60 L	B	

§ 172.101 HAZARDOUS MATERIALS TABLE—Continued

Sym-bols (1)	Hazardous materials descriptions and proper shipping names (2)	Hazard class or Division (3)	Identi- fication Numbers (4)	PG (5)	Label Codes (6)	Special provisions (§ 172.102) (7)	(8)			(9)		(10) Vessel stowage	
							Packaging (§ 173.***)			Quantity limitations (see §§ 173.27 and 175.75)		Loca- tion (10A)	Other (10B)
							Excep- tions (8A)	Non-bulk (8B)	Bulk (8C)	Passenger aircraft/rail (9A)	Cargo air- craft only (9B)		
	<i>Projectiles, illuminating, see Ammu- nition, illuminating, etc</i>			III	3	367, B1, IB3, T2, TP1	150	173	242	60 L	220 L	A	
	<i>Projectiles, inert with tracer</i>	1.4S	UN0345	1.4S		62	62	25 kg	100 kg	01	25
	<i>Projectiles, inert, with tracer</i>	1.3G	UN0424	1.3G		62	62	Forbidden	Forbidden	03	25
	<i>Projectiles, inert, with tracer</i>	1.4G	UN0425	1.4G		62	62	Forbidden	75 kg	02	25
	<i>Projectiles, with burster or expelling charge</i>	1.2D	UN0346	1.2D		62	62	Forbidden	Forbidden	03	25
	<i>Projectiles, with burster or expelling charge</i>	1.4D	UN0347	1.4D		62	62	Forbidden	75 kg	02	25
	<i>Projectiles, with burster or expelling charge</i>	1.2F	UN0426	1.2F		62	None	Forbidden	Forbidden	03	25
	<i>Projectiles, with burster or expelling charge</i>	1.4F	UN0427	1.4F		62	None	Forbidden	Forbidden	03	25
	<i>Projectiles, with burster or expelling charge</i>	1.2G	UN0434	1.2G		62	62	Forbidden	Forbidden	03	25
	<i>Projectiles, with burster or expelling charge</i>	1.4G	UN0435	1.4G		62	62	Forbidden	75 kg	02	25
	<i>Projectiles, with bursting charge</i>	1.1F	UN0167	1.1F		62	None	Forbidden	Forbidden	03	25
	<i>Projectiles, with bursting charge</i>	1.1D	UN0168	1.1D		62	62	Forbidden	Forbidden	03	25
	<i>Projectiles, with bursting charge</i>	1.2D	UN0169	1.2D		62	62	Forbidden	Forbidden	03	25
	<i>Projectiles, with bursting charge</i>	1.2F	UN0324	1.2F		62	None	Forbidden	Forbidden	03	25
	<i>Projectiles, with bursting charge</i>	1.4D	UN0344	1.4D		62	62	Forbidden	75 kg	02	25
	<i>Propadiene, stabilized</i>	2.1	UN2200	2.1	387	None	304	314, 315	Forbidden	150 kg	B	25, 40
	<i>Propadiene mixed with methyl acet- ylene, see Methyl acetylene and propadiene mixtures, stabilized</i>												
	<i>Propane, see also Petroleum gases, liquefied</i>	2.1	UN1978	2.1	19, T50, N95	306	304	314, 315	Forbidden	150 kg	E	40
	<i>Propanethiols</i>	3	UN2402	II	3	IB2, T4, TP1, TP13	150	202	242	5 L	60 L	E	95, 102
	<i>n-Propanol or Propyl alcohol, nor- mal</i>	3	UN1274	II	3	B1, IB2, T4, TP1	150	202	242	5 L	60 L	B	
	<i>Propellant, liquid</i>	1.3C	UN0495	1.3C	B1, IB3, T2, TP1	150	203	242	60 L	220 L	A	
	<i>Propellant, liquid</i>	1.1C	UN0497	1.1C	37	None	62	None	Forbidden	Forbidden	04	25
	<i>Propellant, solid</i>	1.1C	UN0498	1.1C	37	None	62	None	Forbidden	Forbidden	04	25, 26E

§ 172.101

49 CFR Ch. I (10-1-23 Edition)

Propellant, solid	1.3C	UN0499	1.3C	None	62	None	Forbidden	Forbidden	04	25, 26E
Propellant, solid	1.4C	UN0501	1.4C	None	62	None	Forbidden	75 kg	02	25
Propionaldehyde	3	UN1275	II	3	IB2, T7, TP1	150	202	242	5 L	60 L	E	
Propionic acid with not less than 90% acid by mass	8	UN3463	II	8, 3	IB2, T7, TP2	154	202	243	1 L	30 L	A	53, 58
Propionic acid with not less than 10% and less than 90% acid by mass	8	UN1848	III	8	IB3, T4, TP1	154	203	241	5 L	60 L	A	53, 58
Propionic anhydride	8	UN2496	III	8	IB3, T4, TP1	154	203	241	5 L	60 L	A	53, 58
Propionitrile	3	UN2404	II	3, 6.1	IB2, T7, TP1, TP13	150	202	243	Forbidden	60 L	E	40
Propionyl chloride	3	UN1815	II	3, 8	IB1, T7, TP1	150	202	243	1 L	5 L	B	40, 53, 58
n-Propyl acetate	3	UN1276	II	3	IB2, T4, TP1	150	202	242	5 L	60 L	B	
Propyl alcohol, see Propanol												
n-Propyl benzene	3	UN2364	III	3	B1, IB3, T2, TP1	150	203	242	60 L	220 L	A	
n-Propyl chloroformate	6.1	UN2740	I	6.1, 3, 8	2, B9, B14, B32, B77, N34, T20, TP2, TP13, TP38, TP44	None	227	244	Forbidden	Forbidden	B	21, 40, 53, 58, 100
<i>Propyl chloride</i> see 1-Chloropropane												
Propyl formates	3	UN1281	II	3	IB2, T4, TP1	150	202	242	5 L	60 L	B	
n-Propyl isocyanate	6.1	UN2482	I	6.1, 3	1, B9, B14, B30, T20, TP2, TP13, TP38, TP44	None	226	244	Forbidden	Forbidden	D	40
<i>Propyl mercaptan</i> , see Propanethiols												
n-Propyl nitrate	3	UN1865	II	3	IB9	150	202	None	5 L	60 L	D	44, 89, 90, 100
Propylamine	3	UN1277	II	3, 8	A7, IB2, N34, T7, TP1	150	202	243	1 L	5 L	E	40, 52
Propylene see also Petroleum gases, liquefied	2.1	UN1077		2.1	19, T50	306	304	314, 315	Forbidden	150 kg	E	40
Propylene chlorohydrin	6.1	UN2611	II	6.1, 3	IB2, T7, TP2, TP13	153	202	243	5 L	60 L	A	12, 25, 40
Propylene oxide	3	UN1280	I	3	N34, T11, TP2, TP7	None	201	243	1 L	30 L	E	40
Propylene tetramer	3	UN2850	III	3	B1, IB3, T2, TP2	150	203	242	60 L	220 L	A	
1,2-Propylenediamine	8	UN2258	II	8, 3	A3, IB2, N34, T7, TP2	154	202	243	1 L	30 L	A	40, 52
Propyleneimine, stabilized	3	UN1921	I	3, 6.1	N34, T14, TP2, TP13	None	201	243	1 L	30 L	D	40
Propyltrichlorosilane	8	UN1816	II	8, 3	A7, B2, B6, N34, T10, TP2, TP7, TP13	None	206	243	Forbidden	30 L	C	40, 53, 58
<i>Prussic acid</i> , see Hydrogen cyanide												
Pyrethroid pesticide, liquid, flammable, toxic, flash point less than 23 degrees C	3	UN3350	I	3, 6.1	T14, TP2, TP13, TP27	None	201	243	Forbidden	30 L	B	40
			II	3, 6.1	IB2, T11, TP2, TP13, TP27	150	202	243	1 L	60 L	B	40
Pyrethroid pesticide, liquid toxic	6.1	UN3352	I	6.1	T14, TP2, TP13, TP27	None	201	243	1 L	30 L	B	40
			II	6.1	IB2, T11, TP2, TP27	153	202	243	5 L	60 L	B	40
			III	6.1	IB3, T7, TP2, TP28	153	203	241	60 L	220 L	A	40

§ 172.101 HAZARDOUS MATERIALS TABLE—Continued

Sym-bols	Hazardous materials descriptions and proper shipping names	Hazard class or Division	Identi-fication Numbers	PG	Label Codes	Special provisions (§ 172.102)	(8)			(9)		(10) Vessel stowage	
							Packaging (§ 173.***)			Quantity limitations (see §§ 173.27 and 175.75)		Loca-tion	Other
							Excep-tions	Non-bulk	Bulk	Passenger aircraft/rail	Cargo air-craft only		
(1)	(2)	(3)	(4)	(5)	(6)	(7)	(8A)	(8B)	(8C)	(9A)	(9B)	(10A)	(10B)
G	Pyrethroid pesticide, liquid, toxic, flammable, flash point not less than 23 degrees C	6.1	UN3351	I	6.1, 3	T14, TP2, TP13, TP27	None	201	243	1 L	30 L	B	40
					6.1, 3	IB2, T11, TP2, TP13, TP27	153	202	243	5 L	60 L	B	40
	Pyrethroid pesticide, solid, toxic	6.1	UN3349	I	6.1	IB3, T7, TP2, TP28	153	203	241	60 L	220 L	B	40
					6.1	IB7, IP1, T6, TP33	None	211	242	5 kg	50 kg	A	40
					6.1	IB8, IP2, IP4, T3, TP33	153	212	242	25 kg	100 kg	A	40
	Pyridine Pyridine perchlorate	3	UN1282	II	6.1	IB8, IP3, T1, TP33	153	213	240	100 kg	200 kg	A	40
					3	IB2, T4, TP2	150	202	242	5 L	60 L	B	21, 100
	Pyrophoric liquid, inorganic, n.o.s	4.2	UN3194	I	4.2	None	181	244	Forbidden	Forbidden	D	13, 78, 148
	Pyrophoric liquids, organic, n.o.s	4.2	UN2845	I	4.2	B11, T22, TP2, TP7, W31	None	187	244	Forbidden	Forbidden	D	13, 78, 148
	Pyrophoric metals, n.o.s., or Pyrophoric alloys, n.o.s	4.2	UN1383	I	4.2	B11, T21, TP7, TP33, W31	None	187	242	Forbidden	Forbidden	D	13, 148
	Pyrophoric solid, inorganic, n.o.s	4.2	UN3200	I	4.2	T21, TP7, TP33, W31	None	187	242	Forbidden	Forbidden	D	13, 148
	Pyrophoric solids, organic, n.o.s	4.2	UN2846	I	4.2	W31	None	187	242	Forbidden	Forbidden	D	13, 148
	Pyrosulfuryl chloride	8	UN1817	II	8	B2, IB2, T8, TP2	154	202	242	1 L	30 L	C	40, 53, 58
Pyroxylin solution or solvent, see Nitrocellulose	Forbidden	3	UN1922	II	3, 8	IB2, T7, TP1	150	202	243	1 L	5 L	B	40, 52
Pyrrolidine Quebrachitol pentanitrate Quicklime, see Calcium oxide Quinoline													
R 12, see Dichlorodifluoromethane R 12B1, see Chlorodifluorobromomethane R 13, see Chlorotrifluoromethane R 13B1, see Bromotrifluoromethane R 14, see Tetrafluoromethane R 21, see Dichlorofluoromethane R 22, see Chlorodifluoromethane R 114, see Dichlorotetrafluoroethane	6.1	UN2656	III	6.1	IB3, T4, TP1	153	203	241	60 L	220 L	A	12, 25	

§ 172.101

49 CFR Ch. I (10-1-23 Edition)

R 115, see Chloropentafluoroethane																					
R 116, see Hexafluoroethane																					
R 124, see Chlorotetrafluoroethane																					
R 133a, see Chlorotrifluoroethane																					
R 152a, see Difluoroethane																					
R 500, see Dichlorodifluoromethane and difluoroethane, etc																					
R 502, see Chlorodifluoromethane and chloropentafluoroethane mixture, etc																					
R 503, see Chlorotrifluoromethane and trifluoromethane, etc																					
Radioactive material, excepted package-articles manufactured from natural uranium or depleted uranium or natural thorium	7	UN2909	None					422, 426	422, 426	422, 426									A		
Radioactive material, excepted package-empty packaging	7	UN2908 Empty		368			422, 428	422, 428	422, 428							A		
Radioactive material, excepted package-instruments or articles	7	UN2911	None					422, 424	422, 424											A	
Radioactive material, excepted package-limited quantity of material	7	UN2910 None		368			421, 422	421, 422	421, 422								A	
Radioactive material, low specific activity (LSA-I) non fissile or fissile-excepted	7	UN2912 7			325, A56, T5, TP4, W7		421, 422, 428	427	427								A	95, 129
Radioactive material, low specific activity (LSA-II) non fissile or fissile-excepted	7	UN3321 7			325, A56, T5, TP4, W7		421, 422, 428	427	427								A	95, 129
Radioactive material, low specific activity (LSA-III) non fissile or fissile excepted	7	UN3322 7			325, A56, T5, TP4, W7		421, 422, 428	427	427								A	95, 150
Radioactive material, surface contaminated objects (SCO-I or SCO-II) non fissile or fissile-excepted	7	UN2913 7			325, A56		421, 422, 428	427	427								A	95
Radioactive material, transported under special arrangement, non fissile or fissile excepted	7	UN2919 7			325, A56, 139												A	95, 105
Radioactive material, transported under special arrangement, fissile	7	UN3331	7			A56, 139														A	95, 105
Radioactive material, Type A package, fissile non-special form	7	UN3327	7			A56, W7, W8		453	417	417										A	95, 105, 131
Radioactive material, Type A package non-special form, non fissile or fissile-excepted	7	UN2915 7			325, A56, W7, W8		None	415, 418, 419	415, 418, 419								A	95, 130

§ 172.101 HAZARDOUS MATERIALS TABLE—Continued

Sym-bols (1)	Hazardous materials descriptions and proper shipping names (2)	Hazard class or Division (3)	Identi-fication Numbers (4)	PG (5)	Label Codes (6)	Special provisions (§ 172.102) (7)	(8)			(9)		(10) Vessel stowage	
							Packaging (§ 173.***)			Quantity limitations (see §§ 173.27 and 175.75)		Loca-tion (10A)	Other (10B)
							Excep-tions (8A)	Non-bulk (8B)	Bulk (8C)	Passenger aircraft/rail (9A)	Cargo air-craft only (9B)		
	Radioactive material, Type A pack-age, special form <i>non fissile or fissile-excepted</i>	7	UN3332		7	A56, W7, W8		415, 476	415, 476			A	95
	Radioactive material, Type A pack-age, special form, fissile	7	UN3333		7	A56, W7, W8	453	417, 476	417, 476			A	95, 105
	Radioactive material, Type B(M) package, fissile	7	UN3329		7	A56	453	417	417			A	95, 105
	Radioactive material, Type B(M) package <i>non fissile or fissile-ex-cepted</i>	7	UN2917	7	325, A56		416	416	A	95, 105
	Radioactive material, Type B(U) package, fissile	7	UN3328		7	A56	453	417	417			A	95, 105
	Radioactive material, Type B(U) package <i>non fissile or fissile-ex-cepted</i>	7	UN2916	7	325, A56		416	416	A	95, 105
	Radioactive material, uranium hexafluoride <i>non fissile or fissile-excepted</i>	7	UN2978	7, 6.1, 8	423	420, 427	420, 427	B	40, 74, 95, 132, 151, 153
	Radioactive material, uranium hexafluoride, fissile	7	UN2977	7, 6.1, 8	453	417, 420	417, 420	B	40, 74, 95, 132, 151, 153
A W	Rags, oily <i>Railway torpedo, see Signals, rail-way track, explosive</i> <i>RC 318, see Octafluorocyclobutane</i> RDX and cyclotetramethylenetetranitramin-e, wetted or desensitized see RDX and HMX mixtures, wetted or desensitized	4.2	UN1856	III	4.2		151	213	240	Forbidden	Forbidden	A	

§ 172.101

49 CFR Ch. I (10-1-23 Edition)

	RDX and HMX mixtures, wetted with not less than 15 percent water by mass or RDX and HMX mixtures, desensitized with not less than 10 percent phlegmatizer by mass	1.1D	UN0391	1.1D	None	62	None	Forbidden	Forbidden	04	25
	RDX and Octogen mixtures, wetted or desensitized see RDX and HMX mixtures, wetted or desensitized etc												
	RDX, see Cyclotrimethylene trinitramine, etc												
	Receptacles, small, containing gas or gas cartridges (flammable) without release device, not refillable and not exceeding 1 L capacity	2.1	UN2037	2.1	306	304	None	1 kg	15 kg	B	40, 157
	Receptacles, small, containing gas or gas cartridges (non-flammable) without release device, not refillable and not exceeding 1 L capacity	2.2	UN2037	2.2	306	304	None	1 kg	15 kg	B	40, 157
	Receptacles, small, containing gas or gas cartridges (oxidizing), without release device, not refillable and not exceeding 1 L capacity	2.2	UN2037	2.2, 5.1		A14 306	304	None	1 kg	15 kg	B	40, 157
	Red phosphorus, see Phosphorus, amorphous												
	Refrigerant gas R 404A	2.2	UN3337		2.2		T50 306	304	314, 315	75 kg	150 kg	A	
	Refrigerant gas R 407A	2.2	UN3338		2.2		T50 306	304	314, 315	75 kg	150 kg	A	
	Refrigerant gas R 407B	2.2	UN3339		2.2		T50 306	304	314, 315	75 kg	150 kg	A	
	Refrigerant gas R 407C	2.2	UN3340		2.2		T50 306	304	314, 315	75 kg	150 kg	A	
G	Refrigerant gases, n.o.s.	2.2	UN1078		2.2		T50 306	304	314, 315	75 kg	150 kg	A	
D	Refrigerant gases, n.o.s. or Dispersant gases, n.o.s.	2.1	NA1954		2.1		T50 306	304	314, 315	Forbidden	150 kg	D	40
	Refrigerating machines, containing flammable, non-toxic, liquefied gas	2.1	UN3358		2.1		306, 307	306	306	Forbidden	Forbidden	D	40
	Refrigerating machines, containing non-flammable, non-toxic gases, or ammonia solutions (UN2672)	2.2	UN2857		2.2		A53 306, 307	306	306, 307	450 kg	450 kg	A	

§ 172.101 HAZARDOUS MATERIALS TABLE—Continued

§ 172.101

49 CFR Ch. I (10-1-23 Edition)

Sym-bols (1)	Hazardous materials descriptions and proper shipping names (2)	Hazard class or Division (3)	Identi-fication Numbers (4)	PG (5)	Label Codes (6)	Special provisions (§ 172.102) (7)	(8)			(9)		(10) Vessel stowage	
							Packaging (§ 173.***)			Quantity limitations (see §§ 173.27 and 175.75)		Loca-tion (10A)	Other (10B)
							Excep-tions (8A)	Non-bulk (8B)	Bulk (8C)	Passenger aircraft/rail (9A)	Cargo air-craft only (9B)		
	Regulated medical waste, n.o.s. or Clinical waste, unspecified, n.o.s. or (BIO) Medical waste, n.o.s. or Biomedical waste, n.o.s., or Medical Waste n.o.s.	6.2	UN3291	6.2	41, 337, A13	134	197	197	No limit	No limit	B	40
	Release devices, explosive	1.4S	UN0173	I	1.4S	B52, T11, TP1, TP8, TP28	None	62	62	25 kg	100 kg	01	25
	Resin Solution, flammable	3	UN1866	I	3	149, B52, IB2, T4, TP1, TP8	150	201	243	1 L	30 L	E	
				II	3	B1, B52, IB3, T2, TP1, TP8	150	173	242	5 L	60 L	B	
	Resorcinol	6.1	UN2876	III	3	B1, B52, IB3, T2, TP1, IB8, IP3, T1, TP33	150	173	242	60 L	220 L	A	
	Rifle grenade, see Grenades, hand or rifle, etc			III	6.1		153	213	240	100 kg	200 kg	A	
	Rifle powder, see Powder, smokeless (UN 0160)												
	Rivets, explosive	1.4S	UN0174	1.4S	None	62	62	25 kg	100 kg	01	25
	Road asphalt or tar liquid, see Tars, liquid, etc												
	Rocket motors	1.3C	UN0186	1.3C	109	None	62	62	Forbidden	220 kg	03	25
	Rocket motors	1.1C	UN0280	1.1C	109	None	62	62	Forbidden	Forbidden	03	25
	Rocket motors	1.2C	UN0281	1.2C	109	None	62	62	Forbidden	Forbidden	04	25
	Rocket motors	1.4C	UN0510	1.4C	109	None	62	62	Forbidden	75 kg	02	25
	Rocket motors, liquid fueled	1.2J	UN0395	1.2J	109	None	62	None	Forbidden	Forbidden	05	25, 23E
	Rocket motors, liquid fueled	1.3J	UN0396	1.3J	109	None	62	None	Forbidden	Forbidden	05	25, 23E
	Rocket motors with hypergolic liquids with or without an expelling charge	1.3L	UN0250	1.3L	109	None	62	None	Forbidden	Forbidden	05	25, 14E, 15E
	Rocket motors with hypergolic liquids with or without an expelling charge	1.2L	UN0322	1.2L	109	None	62	None	Forbidden	Forbidden	05	25, 14E, 15E
	Rockets, line-throwing	1.2G	UN0238	1.2G	None	62	None	Forbidden	Forbidden	03	25
	Rockets, line-throwing	1.3G	UN0240	1.3G	None	62	None	Forbidden	75 kg	03	25
	Rockets, line-throwing	1.4G	UN0453	1.4G	None	62	None	Forbidden	75 kg	02	25
	Rockets, liquid fueled with bursting charge	1.1J	UN0397	1.1J	None	62	None	Forbidden	Forbidden	05	25, 23E

	Rockets, liquid fueled <i>with bursting charge</i>	1.2J	UN0398	1.2J	None	62	None	Forbidden	Forbidden	05	25, 23E
	Rockets, <i>with bursting charge</i>	1.1F	UN0180	1.1F	None	62	None	Forbidden	Forbidden	03	25
	Rockets, <i>with bursting charge</i>	1.1E	UN0181	1.1E	None	62	62	Forbidden	Forbidden	03	25
	Rockets, <i>with bursting charge</i>	1.2E	UN0182	1.2E	None	62	62	Forbidden	Forbidden	03	25
	Rockets, <i>with bursting charge</i>	1.2F	UN0295	1.2F	None	62	None	Forbidden	Forbidden	03	25
	Rockets, <i>with expelling charge</i>	1.2C	UN0436	1.2C	None	62	62	Forbidden	Forbidden	03	25
	Rockets, <i>with expelling charge</i>	1.3C	UN0437	1.3C	None	62	62	Forbidden	Forbidden	03	25
	Rockets, <i>with expelling charge</i>	1.4C	UN0438	1.4C	None	62	62	Forbidden	75 kg	02	25
	Rockets, <i>with inert head</i>	1.3C	UN0183	1.3C	None	62	62	Forbidden	Forbidden	03	25
	Rockets, <i>with inert head</i>	1.2C	UN0502	1.2C	None	62	62	Forbidden	Forbidden	03	25, 5E
	Rosin oil	3	UN1286	II	3	IB2, T4, TP1	150	202	242	5 L	60 L	B	
				III	3	B1, IB3, T2, TP1	150	203	242	60 L	220 L	A	
	Rubber solution	3	UN1287	II	3	149, IB2, T4, TP1, TP8	150	202	242	5 L	60 L	B	
				III	3	B1, IB3, T2, TP1	150	203	242	60 L	220 L	A	
	Rubber scrap or shoddy, powdered or granulated, not exceeding 840 microns and rubber content exceeding 45%	4.1	UN1345	II	4.1	IB8, IP2, IP4, T3, TP33	151	212	240	15 kg	50 kg	A	
	Rubidium	4.3	UN1423	I	4.3	22, A7, A19, IB4, IP1, N34, N40, N45, W31	None	211	242	Forbidden	15 kg	D	13, 52, 148
	Rubidium hydroxide	8	UN2678	II	8	IB8, IP2, IP4, T3, TP33	154	212	240	15 kg	50 kg	A	29, 52.
	Rubidium hydroxide solution	8	UN2677	II	8	B2, IB3, T7, TP2	154	202	242	1 L	30 L	A	29, 52.
				III	8	IB3, T4, TP1	154	203	241	5 L	60 L	A	29, 52.
	Safety devices, <i>electrically initiated</i>	9	UN3268	9	160, A200	166	166	166	25 kg	100 kg	A	
	Safety devices, pyrotechnic	1.4G	UN0503	1.4G	A200	None	62	None	Forbidden	75 kg	02	25
G	Safety fuse, see Fuse, safety												
	Samples, explosive, other than initiating explosives		UN0190		113	None	62	None	Forbidden	Forbidden	05	25
	Sand acid, see Fluorosilicic acid												
	Seed cake, containing vegetable oil solvent extractions and expelled seeds, with not more than 10 percent of oil and when the amount of moisture is higher than 11 percent, with not more than 20 percent of oil and moisture combined	4.2	UN1386	III	None	B136, IB8, IP3, IP7, N7	None	213	241	Forbidden	Forbidden	A	13, 25
I	Seed cake with more than 1.5 percent oil and not more than 11 percent moisture	4.2	UN1386	III	None	B136, IB8, IP3, IP7, N7	None	213	241	Forbidden	Forbidden	E	13, 25
I	Seed cake with not more than 1.5 percent oil and not more than 11 percent moisture	4.2	UN2217	III	None	B136, IB8, IP3, IP7, N7	None	213	241	Forbidden	Forbidden	A	13, 25, 120
G	Selenates or Selenites	6.1	UN2630	I	6.1	IB7, IP1, T6, TP33	None	211	242	5 kg	50 kg	E	
	Selenic acid	8	UN1905	I	8	IB7, IP1, N34, T6, TP33	None	211	242	Forbidden	25 kg	A	53, 58
G	Selenium compound, liquid, n.o.s	6.1	UN3440	I	6.1	T14, TP2, TP27	None	201	243	1 L	30 L	B	
				II	6.1	IB2, T11, TP2, TP27	153	202	243	5 L	60 L	B	
				III	6.1	IB3, T7, TP1, TP28	153	203	241	60 L	220 L	A	
G	Selenium compound, solid, n.o.s	6.1	UN3283	I	6.1	IB7, IP1, T6, TP33	None	211	242	5 kg	50 kg	B	
				II	6.1	IB8, IP2, IP4, T3, TP33	153	212	242	25 kg	100 kg	B	

§ 172.101 HAZARDOUS MATERIALS TABLE—Continued

§ 172.101

49 CFR Ch. I (10-1-23 Edition)

Sym-bols	Hazardous materials descriptions and proper shipping names	Hazard class or Division	Identi-fication Numbers	PG	Label Codes	Special provisions (§ 172.102)	(8)			(9)		(10) Vessel stowage	
							Packaging (§ 173.***)			Quantity limitations (see §§ 173.27 and 175.75)		Loca-tion	Other
							Excep-tions	Non-bulk	Bulk	Passenger aircraft/rail	Cargo air-craft only		
(1)	(2)	(3)	(4)	(5)	(6)	(7)	(8A)	(8B)	(8C)	(9A)	(9B)	(10A)	(10B)
+ A D G	Selenium disulfide	6.1 2.3 Forbidden	UN2657	III	6.1	IB8, IP3, T1, TP33	153	213	240	100 kg	200 kg	A	40
	Selenium hexafluoride		UN2194	II	6.1	IB8, IP2, IP4, T3, TP33	153	212	242	25 kg	100 kg	A	
	<i>Selenium nitride</i>						1	None	302	None	Forbidden	Forbidden	
	Selenium oxychloride	8	UN2879	I	8, 6.1	A7, N34, T10, TP2, TP13	None	201	243	0.5 L	2.5 L	E	40, 53, 58
	<i>Self-defense spray, aerosol, see Aerosols, etc</i>												
	Self-defense spray, non-pressurized	9	NA3334	III	9	A37	155	203	None	No limit	No limit	A	
	Self-heating liquid, corrosive, inorganic, n.o.s	4.2	UN3188	II	4.2, 8	IB2, W31	None	202	243	1 L	5 L	C	
	Self-heating liquid, corrosive, organic, n.o.s	4.2	UN3185	III	4.2, 8	IB2, W31	None	203	241	5 L	60 L	C	
				II	4.2, 8	IB2, W31	None	202	243	1 L	5 L	C	
	Self-heating liquid, inorganic, n.o.s	4.2	UN3186	III	4.2, 8	IB2, W31	None	203	241	5 L	60 L	C	
				II	4.2	IB2, W31	None	202	242	1 L	5 L	C	
	Self-heating liquid, organic, n.o.s	4.2	UN3183	II	4.2	IB2, W31	None	202	242	1 L	5 L	C	
				III	4.2	IB2, W31	None	203	241	5 L	60 L	C	
	Self-heating liquid, toxic, inorganic, n.o.s	4.2	UN3187	II	4.2, 6.1	IB2, W31	None	202	243	1 L	5 L	C	
				III	4.2, 6.1	IB2, W31	None	203	241	5 L	60 L	C	
Self-heating liquid, toxic, organic, n.o.s	4.2	UN3184	II	4.2, 6.1	IB2, W31	None	202	243	1 L	5 L	C		
			III	4.2, 6.1	IB2, W31	None	203	241	5 L	60 L	C		
Self-heating solid, corrosive, inorganic, n.o.s.	4.2	UN3192	II	4.2, 8	IB5, IP2, T3, TP33	None	212	242	15 kg	50 kg	C		
Self-heating solid, corrosive, organic, n.o.s	4.2	UN3126	III	4.2, 8	IB8, IP3, T1, TP33	None	213	242	25 kg	100 kg	C		
			II	4.2, 8	IB5, IP2, T3, TP33	None	212	242	15 kg	50 kg	C		
Self-heating solid, inorganic, n.o.s	4.2	UN3190	III	4.2, 8	IB8, IP3, T1, TP33	None	213	242	25 kg	100 kg	C	
			II	4.2	IB6, IP2, T3, TP33, W31	None	212	241	15 kg	50 kg	C		
Self-heating solid, organic, n.o.s	4.2	UN3088	III	4.2	IB8, IP3, T1, TP33, W31	None	213	241	25 kg	100 kg	C		
			II	4.2	IB6, IP2, T3, TP33, W31	None	212	241	15 kg	50 kg	C		
			III	4.2	B116, B130, IB8, IP3, T1, TP33, W31	None	213	241	25 kg	100 kg	C		

G	Self-heating solid, oxidizing, n.o.s.	4.2	UN3127		4.2, 5.1		None	214	214	Forbidden	Forbidden			
G	Self-heating solid, toxic, inorganic, n.o.s.	4.2	UN3191	II	4.2, 6.1	IB5, IP2, T3, TP33	None	212	242	15 kg	50 kg	C		
				III	4.2, 6.1	IB8, IP3, T1, TP33	None	213	242	25 kg	100 kg	C		
G	Self-heating solid, toxic, organic, n.o.s.	4.2	UN3128	II	4.2, 6.1	IB5, IP2, T3, TP33	None	212	242	15 kg	50 kg	C		
				III	4.2, 6.1	IB8, IP3, T1, TP33	None	213	242	25 kg	100 kg	C		
	<i>Self-propelled vehicle, see Engines or Batteries etc</i>													
G	Self-reactive liquid type B	4.1	UN3221	4.1		53	151	224	None	Forbidden	Forbidden	D	25, 52, 53, 127
G	Self-reactive liquid type B, temperature controlled	4.1	UN3231	4.1		53	None	224	None	Forbidden	Forbidden	D	2, 25, 52, 53
G	Self-reactive liquid type C	4.1	UN3223	4.1			151	224	None	5 L	10 L	D	25, 52, 53
G	Self-reactive liquid type C, temperature controlled	4.1	UN3233	4.1			None	224	None	Forbidden	Forbidden	D	2, 25, 52, 53
G	Self-reactive liquid type D	4.1	UN3225	4.1			151	224	None	5 L	10 L	D	25, 52, 53
G	Self-reactive liquid type D, temperature controlled	4.1	UN3235	4.1			None	224	None	Forbidden	Forbidden	D	2, 25, 52, 53
G	Self-reactive liquid type E	4.1	UN3227	4.1			151	224	None	10 L	25 L	D	25, 52, 53
G	Self-reactive liquid type E, temperature controlled	4.1	UN3237	4.1			None	224	None	Forbidden	Forbidden	D	2, 25, 52, 53
G	Self-reactive liquid type F	4.1	UN3229	4.1			151	224	None	10 L	25 L	D	25, 52, 53
G	Self-reactive liquid type F, temperature controlled	4.1	UN3239	4.1			None	224	None	Forbidden	Forbidden	D	2, 25, 52, 53
G	Self-reactive solid type B	4.1	UN3222	4.1		53	151	224	None	Forbidden	Forbidden	D	25, 52, 53, 127
G	Self-reactive solid type B, temperature controlled	4.1	UN3232	4.1		53	None	224	None	Forbidden	Forbidden	D	2, 25, 52, 53
G	Self-reactive solid type C	4.1	UN3224	4.1			151	224	None	5 kg	10 kg	D	25, 52, 53
G	Self-reactive solid type C, temperature controlled	4.1	UN3234	4.1			None	224	None	Forbidden	Forbidden	D	2, 25, 52, 53
G	Self-reactive solid type D	4.1	UN3226	4.1			151	224	None	5 kg	10 kg	D	25, 52, 53
G	Self-reactive solid type D, temperature controlled	4.1	UN3236	4.1			None	224	None	Forbidden	Forbidden	D	2, 25, 52, 53
G	Self-reactive solid type E	4.1	UN3228	4.1			151	224	None	10 kg	25 kg	D	25, 52, 53
G	Self-reactive solid type E, temperature controlled	4.1	UN3238	4.1			None	224	None	Forbidden	Forbidden	D	2, 25, 52, 53
G	Self-reactive solid type F	4.1	UN3230	4.1			151	224	None	10 kg	25 kg	D	25, 52, 53

§ 172.101 HAZARDOUS MATERIALS TABLE—Continued

Sym-bols	Hazardous materials descriptions and proper shipping names	Hazard class or Division	Identi-fication Numbers	PG	Label Codes	Special provisions (§ 172.102)	(8)			(9)		(10) Vessel stowage	
							Packaging (§ 173.***)			Quantity limitations (see §§ 173.27 and 175.75)		Loca-tion	Other
							Excep-tions	Non-bulk	Bulk	Passenger aircraft/rail	Cargo air-craft only		
(1)	(2)	(3)	(4)	(5)	(6)	(7)	(8A)	(8B)	(8C)	(9A)	(9B)	(10A)	(10B)
G	Self-reactive solid type F, tempera-ture controlled	4.1	UN3240	4.1	None	224	None	Forbidden	Forbidden	D	2, 25, 52, 53
	Shale oil	3	UN1288	I II III	3 3 3	T11, TP1, TP8, TP27 IB2, T4, TP1, TP8 B1, IB3, T2, TP1	None 150 150	224 201 202 203	None 243 242 242	Forbidden	1 L 30 L 5 L 60 L 60 L 220 L	B B A	
	<i>Shaped charges, see Charges, shaped, etc</i>												
	Signal devices, hand	1.4G	UN0191	1.4G	381	None	62	None	Forbidden	75 kg	02	25
	Signal devices, hand	1.4S	UN0373	1.4S	381	None	62	None	25 kg	100 kg	01	25
	Signals, distress, <i>ship</i>	1.1G	UN0194	1.1G	None	62	None	Forbidden	Forbidden	03	25
	Signals, distress, <i>ship</i>	1.3G	UN0195	1.3G	None	62	None	Forbidden	75 kg	03	25
	Signals, distress, <i>ship</i>	1.4G	UN0505	1.4G	None	62	None	Forbidden	75 kg	02	25
	Signals, distress, <i>ship</i>	1.4S	UN0506	1.4S	None	62	None	25 kg	100 kg	01	25
	<i>Signals, highway, see Signal de-vices, hand</i>												
	Signals, railway track, explosive	1.1G	UN0192	1.1G	None	62	None	Forbidden	Forbidden	03	25
	Signals, railway track, explosive	1.4S	UN0193	1.4S	381	None	62	None	25 kg	100 kg	01	25
	Signals, railway track, explosive	1.3G	UN0492	1.3G	None	62	None	Forbidden	Forbidden	03	25
	Signals, railway track, explosive	1.4G	UN0493	1.4G	None	62	None	Forbidden	75 kg	02	25
	<i>Signals, ship distress, water-acti-vated, see Contrivances, water-activated, etc</i>												
	Signals, smoke	1.1G	UN0196	1.1G	None	62	None	Forbidden	Forbidden	03	25
	Signals, smoke	1.4G	UN0197	1.4G	None	62	None	Forbidden	75 kg	02	25
	Signals, smoke	1.2G	UN0313	1.2G	None	62	None	Forbidden	Forbidden	03	25
	Signals, smoke	1.3G	UN0487	1.3G	None	62	None	Forbidden	Forbidden	03	25
	Signals, smoke	1.4S	UN0507	1.4S	None	62	None	25 kg	100 kg	01	25
Silane	2.1	UN2203			2.1	None	302	None	Forbidden	Forbidden	E	40, 57, 104
<i>Silicofluoric acid, see Fluorosilicic acid</i>													
<i>Silicon chloride, see Silicon tetra-chloride</i>													
Silicon powder, amorphous	4.1	UN1346	III	4.1	A1, IB8, IP3, T1, TP33	151	213	240	25 kg	100 kg	A	74	
Silicon tetrachloride	8	UN1818	II	8	A3, B2, B6, T10, TP2, TP7, TP13	None	202	242	Forbidden	30 L	C	40, 53, 58	
Silicon tetrafluoride	2.3	UN1859		2.3, 8	2	None	302	None	Forbidden	Forbidden	D	40	
Silicon tetrafluoride, adsorbed	2.3	UN3521	2.3, 8	2	None	302c	None	Forbidden	Forbidden	D	40	

§ 172.101

49 CFR Ch. I (10-1-23 Edition)

	<i>Silver acetylide (dry)</i>	Forbidden																	
	Silver arsenite	6.1 UN1683	II	6.1	IB8, IP2, IP4, T3, TP33	153	212	242	25 kg	100 kg	A								
	<i>Silver azide (dry)</i>	Forbidden																	
	<i>Silver chlorite (dry)</i>	Forbidden																	
	Silver cyanide	6.1 UN1684	II	6.1	IB8, IP2, IP4, T3, TP33	153	212	242	25 kg	100 kg	A	40, 52							
	<i>Silver fulminate (dry)</i>	Forbidden																	
	Silver nitrate	5.1 UN1493	II	5.1	IB8, IP2, IP4, T3, TP33	152	212	242	5 kg	25 kg	A								
	<i>Silver oxalate (dry)</i>	Forbidden																	
	<i>Silver picrate (dry)</i>	Forbidden																	
	Silver picrate, wetted with not less than 30 percent water, by mass	4.1 UN1347	I	4.1	23, W31	None	211	None	Forbidden	Forbidden	D	28, 36							
	Sludge, acid	8 UN1906	II	8	A3, A7, B2, IB2, N34, T8, TP2, TP28	154	202	242	Forbidden	30 L	C	14, 53, 58							
D	Smokeless powder for small arms (100 pounds or less)	4.1 NA3178	I	4.1	16	None	171	None	Forbidden	7.3 kg	A								
	Soda lime with more than 4 percent sodium hydroxide	8 UN1907	III	8	IB8, IP3, T1, TP33	154	213	240	25 kg	100 kg	A	52.							
	Sodium	4.3 UN1428	I	4.3	A7, A8, A19, A20, B9, B48, B68, IB4, IP1, N34, T9, TP7, TP33, TP46, W31	151	211	244	Forbidden	15 kg	D	13, 52, 148							
A	Sodium aluminate, solid	8 UN2812	III	8	IB8, IP3, T1, TP33	154	213	240	25 kg	100 kg	A								
	Sodium aluminate, solution	8 UN1819	II	8	B2, IB2, T7, TP2	154	202	242	1 L	30 L	A	52.							
			III	8	IB3, T4, TP1	154	203	241	5 L	60 L	A	52.							
	Sodium aluminum hydride	4.3 UN2835	II	4.3	A8, A19, A20, IB4, T3, TP33, W31, W40	151	212	242	Forbidden	50 kg	E	13, 52, 148							
	Sodium ammonium vanadate	6.1 UN2863	II	6.1	IB8, IP2, IP4, T3, TP33	153	212	242	25 kg	100 kg	A								
	Sodium arsenilate	6.1 UN2473	III	6.1	IB8, IP3, T1, TP33	153	213	240	100 kg	200 kg	A								
	Sodium arsenate	6.1 UN1685	II	6.1	IB8, IP2, IP4, T3, TP33	153	212	242	25 kg	100 kg	A								
	Sodium arsenite, aqueous solutions	6.1 UN1686	II	6.1	IB2, T7, TP2	153	202	243	5 L	60 L	A								
			III	6.1	IB3, T4, TP2	153	203	241	60 L	220 L	A								
	Sodium arsenite, solid	6.1 UN2027	II	6.1	IB8, IP2, IP4, T3, TP33	153	212	242	25 kg	100 kg	A								
	Sodium azide	6.1 UN1687	II	6.1	IB8, IP2, IP4	153	212	242	25 kg	100 kg	A	36, 52, 91							
	<i>Sodium bifluoride, see Sodium hydrogendifluoride</i>																		
	<i>Sodium bisulfite, solution, see Bisulfites, aqueous solutions, n.o.s.</i>																		
	Sodium borohydride	4.3 UN1426	I	4.3	N40, W31	None	211	242	Forbidden	15 kg	E	13, 52, 148							
	Sodium borohydride and sodium hydroxide solution, with not more than 12 percent sodium borohydride and not more than 40 percent sodium hydroxide by mass	8 UN3320	II	8	B2, IB2, N34, T7, TP2	154	202	242	1 L	30 L	A	52							
			III	8	B2, IB3, N34, T4, TP2	154	203	241	5 L	60 L	A	52							
	Sodium bromate	5.1 UN1494	II	5.1	IB8, IP2, IP4, T3, TP33	152	212	242	5 kg	25 kg	A	56, 58							
	Sodium cacodylate	6.1 UN1688	II	6.1	IB8, IP2, IP4, T3, TP33	153	212	242	25 kg	100 kg	A	52							

§ 172.101 HAZARDOUS MATERIALS TABLE—Continued

Sym-bols (1)	Hazardous materials descriptions and proper shipping names (2)	Hazard class or Division (3)	Identi-fication Numbers (4)	PG (5)	Label Codes (6)	Special provisions (§ 172.102) (7)	(8)			(9)		(10) Vessel stowage	
							Packaging (§ 173.***)			Quantity limitations (see §§ 173.27 and 175.75)		Loca-tion (10A)	Other (10B)
							Excep-tions (8A)	Non-bulk (8B)	Bulk (8C)	Passenger aircraft/rail (9A)	Cargo air-craft only (9B)		
	Sodium carbonate peroxyhydrate	5.1	UN3378	II	5.1	B120, IB8, IP2, IP4, T3, TP33	152	212	240	5 kg	25 kg	A	13, 25, 75
				III	5.1	B120, IB8, IP3, T1, TP33	152	213	240	25 kg	100 kg	A	13, 25, 75
	Sodium chlorate	5.1	UN1495	II	5.1	A9, IB8, IP2, IP4, N34, T3, TP33	152	212	240	5 kg	25 kg	A	56, 58
	Sodium chlorate, aqueous solution	5.1	UN2428	II	5.1	A2, IB2, T4, TP1	152	202	241	1 L	5 L	B	56, 58, 133
				III	5.1	A2, IB2, T4, TP1	152	203	241	2.5 L	30 L	B	56, 58, 69, 133
	<i>Sodium chlorate mixed with dinitro-toluene, see Explosive blasting, type C</i>												
	Sodium chlorite	5.1	UN1496	II	5.1	A9, IB8, IP2, IP4, N34, T3, TP33	152	212	242	5 kg	25 kg	A	56, 58
	Sodium chloroacetate	6.1	UN2659	III	6.1	IB8, IP3, T1, TP33	153	213	240	100 kg	200 kg	A	
	Sodium cuprocyanide, solid	6.1	UN2316	I	6.1	IB7, IP1, T6, TP33	None	211	242	5 kg	50 kg	A	52
	Sodium cuprocyanide, solution	6.1	UN2317	I	6.1	T14, TP2, TP13	None	201	243	1 L	30 L	B	40, 52
	Sodium cyanide, solid	6.1	UN1689	I	6.1	B69, B77, IB7, N74, N75, T6, TP33, W31	None	211	242	5 kg	50 kg	B	52
	Sodium cyanide solution	6.1	UN3414	I	6.1	B69, B77, N74, N75, T14, TP2, TP13, W31	None	201	243	1 L	30 L	B	52
				II	6.1	B69, B77, IB2, N74, N75, T11, TP2, TP13, TP27, W31	153	202	243	5 L	60 L	B	52
				III	6.1	B69, B77, IB3, N74, N75, T7, TP2, TP13, TP28, W31	153	203	241	60 L	220 L	A	52
	<i>Sodium dichloroisocyanurate or So-dium dichloro-s-triazinetrione, see Dichloroisocyanuric acid etc</i>												
	Sodium dinitro-o-cresolate, dry or wetted with less than 15 percent water, by mass	1.3C	UN0234	1.3C	None	62	None	Forbidden	Forbidden	04	25, 5E
	Sodium dinitro-o-cresolate, wetted with not less than 10% water, by mass	4.1	UN3369	I	4.1	162, A8, A19, N41, N84, W31	None	211	None	0.5 kg	0.5 kg	E	28, 36

§ 172.101

49 CFR Ch. I (10-1-23 Edition)

Sodium dinitro-o-cresolate, wetted with not less than 15 percent water, by mass	4.1	UN1348	I	4.1, 6.1	23, A8, A19, A20, N41, W31	None	211	None	1 kg	15 kg	E	28, 36
Sodium dithionite or Sodium hydro-sulfite	4.2	UN1384	II	4.2	A19, A20, IB6, IP2, T3, TP33, W31	None	212	241	15 kg	50 kg	E	13
Sodium fluoride, solid	6.1	UN1690	III	6.1	IB8, IP3, T1, TP33	153	213	240	100 kg	200 kg	A	52
Sodium fluoride solution	6.1	UN3415	III	6.1	IB3, T4, TP1	153	203	241	60 L	220 L	A	52
Sodium fluoroacetate	6.1	UN2629	I	6.1	IB7, IP1, T6, TP33	None	211	242	5 kg	50 kg	E	
Sodium fluorosilicate	6.1	UN2674	III	6.1	IB8, IP3, T1, TP33	153	213	240	100 kg	200 kg	A	52
<i>Sodium hydrate, see Sodium hydroxide, solid</i>												
Sodium hydride	4.3	UN1427	I	4.3	A19, N40, W31	None	211	242	Forbidden	15 kg	E	13, 52, 148
Sodium hydrogendifluoride	8	UN2439	II	8	IB8, IP2, IP4, N3, N34, T3, TP33	154	212	240	15 kg	50 kg	A	12, 25, 40, 52, 53, 58
Sodium hydrosulfide, with less than 25 percent water of crystallization	4.2	UN2318	II	4.2	A7, A19, A20, IB6, IP2, T3, TP33, W31	None	212	241	15 kg	50 kg	A	52
Sodium hydrosulfide with not less than 25 percent water of crystallization	8	UN2949	II	8	A7, IB8, IP2, IP4, T7, TP2	154	212	240	15 kg	50 kg	A	52
<i>Sodium hydrosulfite, see Sodium dithionite</i>												
Sodium hydroxide, solid	8	UN1823	II	8	IB8, IP2, IP4, T3, TP33	154	212	240	15 kg	50 kg	A	52.
Sodium hydroxide solution	8	UN1824	II	8	B2, IB2, N34, T7, TP2	154	202	242	1 L	30 L	A	52.
			III	8	IB3, N34, T4, TP1	154	203	241	5 L	60 L	A	52.
<i>Sodium hypochlorite, solution, see Hypochlorite solutions etc</i>												
<i>Sodium metal, liquid alloy, see Alkali metal alloys, liquid, n.o.s.</i>												
Sodium methylate	4.2	UN1431	II	4.2, 8	A7, A19, IB5, IP2, T3, TP33, W31	None	212	242	15 kg	50 kg	B	52
Sodium methylate solutions in alcohol	3	UN1289	II	3, 8	IB2, T7, TP1, TP8	150	202	243	1 L	5 L	B	52
			III	3, 8	B1, IB3, T4, TP1	150	203	242	5 L	60 L	A	52
Sodium monoxide	8	UN1825	II	8	IB8, IP2, IP4, T3, TP33	154	212	240	15 kg	50 kg	A	52.
Sodium nitrate	5.1	UN1498	III	5.1	A1, A29, B120, IB8, IP3, T1, TP33, W1	152	213	240	25 kg	100 kg	A	
Sodium nitrate and potassium nitrate mixtures	5.1	UN1499	III	5.1	A1, A29, B120, IB8, IP3, T1, TP33, W1	152	213	240	25 kg	100 kg	A	
Sodium nitrite	5.1	UN1500	III	5.1, 6.1	A1, A29, IB8, IP3, T1, TP33	152	213	240	25 kg	100 kg	A	56, 58
Sodium pentachlorophenate	6.1	UN2567	II	6.1	IB8, IP2, IP4, T3, TP33	153	212	242	25 kg	100 kg	A	
Sodium perborate monohydrate	5.1	UN3377	III	5.1	B120, IB8, IP3, T1, TP33	152	213	240	25 kg	100 kg	A	13, 25, 75
Sodium perchlorate	5.1	UN1502	II	5.1	IB6, IP2, T3, TP33	152	212	242	5 kg	25 kg	A	56, 58
Sodium permanganate	5.1	UN1503	II	5.1	IB6, IP2, T3, TP33	152	212	242	5 kg	25 kg	D	56, 58, 138

§ 172.101 HAZARDOUS MATERIALS TABLE—Continued

§ 172.101

49 CFR Ch. I (10-1-23 Edition)

Sym-bols (1)	Hazardous materials descriptions and proper shipping names (2)	Hazard class or Division (3)	Identi-fication Numbers (4)	PG (5)	Label Codes (6)	Special provisions (§ 172.102) (7)	(8)			(9)		(10) Vessel stowage	
							Packaging (§ 173.***)			Quantity limitations (see §§ 173.27 and 175.75)		Loca-tion (10A)	Other (10B)
							Excep-tions (8A)	Non-bulk (8B)	Bulk (8C)	Passenger aircraft/rail (9A)	Cargo air-craft only (9B)		
	Sodium peroxide	5.1	UN1504	I	5.1	A20, IB5, IP1, N34	None	211	None	Forbidden	15 kg	C	13, 52, 66, 75, 148
	Sodium peroxoborate, anhydrous	5.1	UN3247	II	5.1	IB8, IP2, IP4, T3, TP33	152	212	240	5 kg	25 kg	A	13, 25
	Sodium persulfate	5.1	UN1505	III	5.1	A1, IB8, IP3, T1, TP33	152	213	240	25 kg	100 kg	A	58, 145
	Sodium phosphide	4.3	UN1432	I	4.3, 6.1	A19, N40, W31	None	211	None	Forbidden	15 kg	E	13, 40, 52, 85, 148
	Sodium picramate, <i>dry or wetted with less than 20 percent water, by mass</i>	1.3C	UN0235	1.3C	None	62	None	Forbidden	Forbidden	04	25, 5E
	Sodium picramate, <i>wetted with not less than 20 percent water, by mass</i>	4.1	UN1349	I	4.1	23, A8, A19, N41, W31	None	211	None	Forbidden	15 kg	E	28, 36
	<i>Sodium picryl peroxide</i>	Forbidden											
	<i>Sodium potassium alloys, see Potassium sodium alloys</i>	Forbidden											
	<i>Sodium selenate, see Selenates or Selenites</i>	Forbidden											
	Sodium sulfide, anhydrous or Sodium sulfide <i>with less than 30 percent water of crystallization</i>	4.2	UN1385	II	4.2	A19, A20, IB6, IP2, N34, T3, TP33, W31, W40	None	212	241	15 kg	50 kg	A	52
	Sodium sulfide, <i>hydrated with not less than 30 percent water</i>	8	UN1849	II	8	IB8, IP2, IP4, T3, TP33	154	212	240	15 kg	50 kg	A	52.
	Sodium superoxide	5.1	UN2547	I	5.1	A20, IB6, IP1, N34	None	211	None	Forbidden	15 kg	D	13, 52, 66, 75, 148
	<i>Sodium tetranitride</i>	Forbidden											
G	Solids containing corrosive liquid, n.o.s.	8	UN3244	II	8	49, IB5, T3, TP33	154	212	240	15 kg	50 kg	B	40
G	Solids containing flammable liquid, n.o.s.	4.1	UN3175	II	4.1	47, IB6, IP2, T3, TP33	151	212	240	15 kg	50 kg	B	
G	Solids containing toxic liquid, n.o.s.	6.1	UN3243	II	6.1	48, IB2, T2, TP33	153	212	240	25 kg	100 kg	B	40
	Sounding devices, explosive	1.2F	UN0204	1.2F	None	62	62	Forbidden	Forbidden	03	25
	Sounding devices, explosive	1.1F	UN0296	1.1F	None	62	62	Forbidden	Forbidden	03	25
	Sounding devices, explosive	1.1D	UN0374	1.1D	None	62	62	Forbidden	Forbidden	03	25
	Sounding devices, explosive	1.2D	UN0375	1.2D	None	62	62	Forbidden	Forbidden	03	25
	<i>Spirits of salt, see Hydrochloric acid</i>												

	<i>Squibs, see Igniters etc</i>														
	Stannic chloride, anhydrous	8	UN1827	II	8	B2, IB2, T7, TP2	154	202	242	1 L	30 L	C	53, 58		
	Stannic chloride pentahydrate	8	UN2440	III	8	IB8, IP3, T1, TP33	154	213	240	25 kg	100 kg	A	53, 58		
	Stannic phosphide	4.3	UN1433	I	4.3, 6.1	A19, N40, W31	None	211	242	Forbidden	15 kg	E	13, 40, 52, 85, 148		
	<i>Steel swarf, see Ferrous metal borings, etc</i>														
	Stibine	2.3	UN2676		2.3, 2.1	1	None	304	None	Forbidden	Forbidden	D	40		
	<i>Storage batteries, wet, see Batteries, wet etc</i>														
	Strontium arsenite	6.1	UN1691	II	6.1	IB8, IP2, IP4, T3, TP33	153	212	242	25 kg	100 kg	A			
	Strontium chlorate	5.1	UN1506	II	5.1	A1, A9, IB8, IP2, IP4, N34, T3, TP33	152	212	242	5 kg	25 kg	A	56, 58		
	Strontium nitrate	5.1	UN1507	III	5.1	A1, A29, IB8, IP3, T1, TP33	152	213	240	25 kg	100 kg	A			
	Strontium perchlorate	5.1	UN1508	II	5.1	IB6, IP2, T3, TP33	152	212	242	5 kg	25 kg	A	56, 58		
	Strontium peroxide	5.1	UN1509	II	5.1	IB6, IP2, T3, TP33, W100	152	212	242	5 kg	25 kg	C	13, 52, 66, 75, 148		
	Strontium phosphide	4.3	UN2013	I	4.3, 6.1	A19, N40, W31	None	211	None	Forbidden	15 kg	E	13, 40, 52, 85, 148		
	Strychnine or Strychnine salts	6.1	UN1692	I	6.1	IB7, IP1, T6, TP33	None	211	242	5 kg	50 kg	A	40		
	Styphnic acid, <i>see</i> Trinitroresorcinol, etc														
G	Styrene monomer, stabilized	3	UN2055	III	3	387, B1, IB3, T2, TP1	150	203	242	60 L	220 L	C	25		
	Substances, explosive, n.o.s.	1.1L	UN0357	1.1L	101	None	62	None	Forbidden	Forbidden	05	25, 14E, 15E		
G	Substances, explosive, n.o.s.	1.2L	UN0358	1.2L	101	None	62	None	Forbidden	Forbidden	05	25, 14E, 15E		
G	Substances, explosive, n.o.s.	1.3L	UN0359	1.3L	101	None	62	None	Forbidden	Forbidden	05	25, 14E, 15E		
G	Substances, explosive, n.o.s.	1.1A	UN0473	1.1A	101, 111	None	62	None	Forbidden	Forbidden	05	25		
G	Substances, explosive, n.o.s.	1.1C	UN0474	1.1C	101	None	62	None	Forbidden	Forbidden	04	25		
G	Substances, explosive, n.o.s.	1.1D	UN0475	1.1D	101	None	62	None	Forbidden	Forbidden	04	25		
G	Substances, explosive, n.o.s.	1.1G	UN0476	1.1G	101	None	62	None	Forbidden	Forbidden	03	25		
G	Substances, explosive, n.o.s.	1.3C	UN0477	1.3C	101	None	62	None	Forbidden	Forbidden	04	25		
G	Substances, explosive, n.o.s.	1.3G	UN0478	1.3G	101	None	62	None	Forbidden	Forbidden	03	25		
G	Substances, explosive, n.o.s.	1.4C	UN0479	1.4C	101	None	62	None	Forbidden	75 kg	02	25		
G	Substances, explosive, n.o.s.	1.4D	UN0480	1.4D	101	None	62	None	Forbidden	75 kg	02	25		
G	Substances, explosive, n.o.s.	1.4S	UN0481	1.4S	101, 347	None	62	None	25 kg	75 kg	01	25		
G	Substances, explosive, n.o.s.	1.4G	UN0485	1.4G	101	None	62	None	Forbidden	75 kg	02	25		
G	Substances, explosive, very insensitive, n.o.s. or Substances, EVI, n.o.s.	1.5D	UN0482	1.5D	101	None	62	None	Forbidden	Forbidden	03	25		

§ 172.101 HAZARDOUS MATERIALS TABLE—Continued

Sym-bols (1)	Hazardous materials descriptions and proper shipping names (2)	Hazard class or Division (3)	Identi-fication Numbers (4)	PG (5)	Label Codes (6)	Special provisions (§ 172.102) (7)	(8)			(9)		(10) Vessel stowage	
							Packaging (§ 173.***)			Quantity limitations (see §§ 173.27 and 175.75)		Loca-tion (10A)	Other (10B)
							Excep-tions (8A)	Non-bulk (8B)	Bulk (8C)	Passenger aircraft/rail (9A)	Cargo air-craft only (9B)		
D I	Substituted nitrophenol pesticides, liquid, flammable, toxic, <i>flash point less than 23 degrees C</i>	3	UN2780	I	3, 6.1	T14, TP2, TP13, TP27	None	201	243	Forbidden	30 L	B	40
					3, 6.1	IB2, T11, TP2, TP13, TP27	150	202	243	1 L	60 L	B	40
	Substituted nitrophenol pesticides, liquid, toxic	6.1	UN3014	I	6.1	T14, TP2, TP13, TP27	None	201	243	1 L	30 L	B	40
					6.1	IB2, T11, TP2, TP13, TP27	153	202	243	5 L	60 L	B	40
	Substituted nitrophenol pesticides, liquid, toxic, flammable, <i>flash point not less than 23 degrees C</i>	6.1	UN3013	I	6.1	IB3, T7, TP2, TP28	153	203	241	60 L	220 L	A	40
					6.1, 3	T14, TP2, TP13, TP27	None	201	243	1 L	30 L	B	40
					6.1, 3	IB2, T11, TP2, TP13, TP27	153	202	243	5 L	60 L	B	40
	Substituted nitrophenol pesticides, solid, toxic	6.1	UN2779	I	6.1	B1, IB3, T7, TP2, TP28	153	203	242	60 L	220 L	A	40
					6.1	IB7, IP1, T6, TP33	None	211	242	5 kg	50 kg	A	40
					6.1	IB8, IP2, IP4, T3, TP33	153	212	242	25 kg	100 kg	A	40
	Sucrose octanitrate (dry)	Forbidden											
	Sulfamic acid	8	UN2967	III	8	IB8, IP3, T1, TP33	154	213	240	25 kg	100 kg	A	53, 58
	Sulfur	9	NA1350	III	9	30, B120, IB8, IP2	None	None	240	No Limit	No Limit	A	25, 74
	Sulfur	4.1	UN1350	III	4.1	30, B120, IB8, IP3, T1, TP33	151	None	240	25 kg	100 kg	A	25, 74
	Sulfur and chlorate, loose mixtures of	Forbidden											
Sulfur chlorides	8	UN1828	I	8	5, A7, A10, B10, B77, N34, T20, TP2	None	201	243	Forbidden	2.5 L	C	40, 53, 58	
Sulfur dichloride, see Sulfur chlorides													
Sulfur dioxide	2.3	UN1079			2.3, 8	3, B14, T50, TP19	None	304	314, 315	Forbidden	Forbidden	D	40
Sulfur dioxide solution, see Sulfurous acid													
Sulfur hexafluoride	2.2	UN1080			2.2		306	304	314, 315	75 kg	150 kg	A	

§ 172.101

49 CFR Ch. I (10-1-23 Edition)

D	Sulfur, molten	9	NA2448	III	9	30, B13, IB3, R1, T1, TP3	None	213	247	Forbidden	Forbidden	C	61
I	Sulfur, molten	4.1	UN2448	III	4.1	30, B13, IB1, R1, T1, TP3	None	213	247	Forbidden	Forbidden	C	74
+	Sulfur tetrafluoride	2.3	UN2418	I	2.3, 8 8, 6.1	1 2, 387, B9, B14, B32, B49, B77, N34, T20, TP4, TP13, TP25, TP26, TP38, TP45	None	302	245	Forbidden	Forbidden	D	40, 52
	Sulfur trioxide, stabilized	8	UN1829				None	227	244	Forbidden	Forbidden	A	25, 40, 53, 58
	<i>Sulfuretted hydrogen, see Hydrogen sulfide</i>												
	Sulfuric acid, fuming with less than 30 percent free sulfur trioxide	8	UN1831	I	8	A7, N34, T20, TP2, TP13	None	201	243	Forbidden	2.5 L	C	14, 40, 53, 58
	Sulfuric acid, fuming with 30 percent or more free sulfur trioxide	8	UN1831	I	8, 6.1	2, B9, B14, B32, B77, B84, N34, T20, TP2, TP12, TP13	None	227	244	Forbidden	Forbidden	C	53, 58
	Sulfuric acid, spent	8	UN1832	II	8	A3, A7, B2, B83, B84, IB2, N34, T8, TP2	154	202	242	Forbidden	30 L	C	14, 53, 58
	Sulfuric acid with more than 51 percent acid	8	UN1830	II	8	A3, A7, B3, B83, B84, IB2, N34, T8, TP2	154	202	242	1 L	30 L	C	14, 53, 58
	Sulfuric acid with not more than 51% acid	8	UN2796	II	8	386, A3, A7, B2, B15, IB2, N6, N34, T8, TP2	154	202	242	1 L	30 L	B	53, 58
	Sulfuric and hydrofluoric acid mixtures, see Hydrofluoric and sulfuric acid mixtures												
	<i>Sulfuric anhydride, see Sulfur trioxide, stabilized</i>												
	Sulfurous acid	8	UN1833	II	8	B3, IB2, T7, TP2	154	202	242	1 L	30 L	B	40, 53, 58
+	Sulfuryl chloride	6.1	UN1834	I	6.1, 8	1, B6, B9, B10, B14, B30, B77, N34, T22, TP2, TP13, TP38, TP44	None	226	244	Forbidden	Forbidden	D	40, 53, 58
	Sulfuryl fluoride	2.3	UN2191				2.3	4	None	304	314, 315	242	Forbidden
	Tars, liquid including road oils and cutback bitumens	3	UN1999	II	3	149, B13, IB2, T3, TP3, TP29	150	202	242	5 L	60 L	B	
	Tear gas candles	6.1	UN1700	6.1, 4.1	B1, B13, IB3, T1, TP3	150	203	242	60 L	220 L	A	
	<i>Tear gas cartridges, see Ammunition, tear-producing, etc</i>						None	340	None	Forbidden	50 kg	D	40
D	Tear gas devices with more than 2 percent tear gas substances, by mass	6.1	NA1693	I	6.1		None	340	None	Forbidden	Forbidden	D	40
	Tear gas devices, with not more than 2 percent tear gas substances, by mass, see Aerosols, etc			II	6.1		None	340	None	Forbidden	Forbidden	D	40

§ 172.101 HAZARDOUS MATERIALS TABLE—Continued

Sym-bols	Hazardous materials descriptions and proper shipping names	Hazard class or Division	Identi-fication Numbers	PG	Label Codes	Special provisions (§ 172.102)	(8)			(9)		(10) Vessel stowage	
							Packaging (§ 173.***)			Quantity limitations (see §§ 173.27 and 175.75)		Loca-tion	Other
							Excep-tions	Non-bulk	Bulk	Passenger aircraft/rail	Cargo air-craft only		
(1)	(2)	(3)	(4)	(5)	(6)	(7)	(8A)	(8B)	(8C)	(9A)	(9B)	(10A)	(10B)
G	<i>Tear gas grenades, see</i> Tear gas candles												
G	Tear gas substances, liquid, n.o.s	6.1	UN1693	I	6.1	W31	None	201	None	Forbidden	Forbidden	D	40
				II	6.1	IB2, W31	None	202	None	Forbidden	5 L	D	40
G	Tear gas substance, solid, n.o.s	6.1	UN3448	I	6.1	T6, TP33, W31	None	211	242	Forbidden	Forbidden	D	40
				II	6.1	IB8, IP2, IP4, T3, TP33, W31	None	212	242	Forbidden	25 kg	D	40
G	Tellurium compound, n.o.s	6.1	UN3284	I	6.1	IB7, IP1, T6, TP33	None	211	242	5 kg	50 kg	B	
				II	6.1	IB8, IP2, IP4, T3, TP33	153	212	242	25 kg	100 kg	B	
				III	6.1	IB8, IP3, T1, TP33	153	213	240	100 kg	200 kg	A	
	Tellurium hexafluoride	2.3	UN2195		2.3, 8	1	None	302	None	Forbidden	Forbidden	D	40
	Terpene hydrocarbons, n.o.s.	3	UN2319	III	3	B1, IB3, T4, TP1, TP29	150	203	242	60 L	220 L	A	
	Terpinolene	3	UN2541	III	3	B1, IB3, T2, TP1	150	203	242	60 L	220 L	A	
	<i>Tetraazido benzene quinone</i>	Forbidden											
	Tetrabromoethane	6.1	UN2504	III	6.1	IB3, T4, TP1	153	203	241	60 L	220 L	A	
	1,1,2,2-Tetrachloroethane	6.1	UN1702	II	6.1	IB2, N36, T7, TP2	153	202	243	5 L	60 L	A	40
	Tetrachloroethylene	6.1	UN1897	III	6.1	IB3, N36, T4, TP1	153	203	241	60 L	220 L	A	40
	Tetraethyl dithiopyrophosphate	6.1	UN1704	II	6.1	IB2, T7, TP2	153	212	242	25 kg	100 kg	D	40
	Tetraethyl silicate	3	UN1292	III	3	B1, IB3, T2, TP1	150	203	242	60 L	220 L	A	
	<i>Tetraethylammonium perchlorate (dry)</i>	Forbidden											
	Tetraethylenepentamine	8	UN2320	III	8	IB3, T4, TP1	154	203	241	5 L	60 L	A	52.
	1,1,1,2-Tetrafluoroethane or Refrigerant gas R 134a	2.2	UN3159		2.2	T50	306	304	314, 315	75 kg	150 kg	A	
	Tetrafluoroethylene, stabilized	2.1	UN1081	2.1	387	306	304	None	Forbidden	150 kg	E	25, 40
	Tetrafluoromethane or Refrigerant gas R 14	2.2	UN1982	2.2	306	302	None	75 kg	150 kg	A	
	1,2,3,6-Tetrahydrobenzaldehyde	3	UN2498	III	3	B1, IB3, T2, TP1	150	203	242	60 L	220 L	A	
	Tetrahydrofuran	3	UN2056	II	3	IB2, T4, TP1	150	202	242	5 L	60 L	B	
	Tetrahydrofurfurylamine	3	UN2943	III	3	B1, IB3, T2, TP1	150	203	242	60 L	220 L	A	
	Tetrahydrophthalic anhydrides with more than 0.05 percent of maleic anhydride	8	UN2698	III	8	IB8, IP3, T1, TP33	154	213	240	25 kg	100 kg	A	53, 58
	1,2,3,6-Tetrahydropyridine	3	UN2410	II	3	IB2, T4, TP1	150	202	242	5 L	60 L	B	
	Tetrahydrothiophene	3	UN2412	II	3	IB2, T4, TP1	150	202	242	5 L	60 L	B	
	Tetramethylammonium hydroxide, solid	8	UN3423	II	8	B2, IB8, IP2, IP4, T3, TP33	154	213	240	15 kg	50 kg	A	52

§ 172.101

49 CFR Ch. I (10-1-23 Edition)

	Tetramethylammonium hydroxide solution	8	UN1835	II	8	B2, IB2, T7, TP2	154	202	242	1 L	30 L	A	52
	<i>Tetramethylene dicarbamide diperoxide</i>	Forbidden		III	8	B2, IB3, T7, TP2	154	203	241	5 L	60 L	A	52
	Tetramethylsilane	3	UN2749	I	3	A7, T14, TP2	None	201	243	Forbidden	30 L	D	
	<i>Tetranitro diglycerin</i>	Forbidden											
	Tetranitroaniline	1.1D	UN0207	1.1D	None	62	None	Forbidden	Forbidden	04	25
+	Tetranitromethane	6.1	UN1510	I	6.1, 5.1	2, B32, T20, TP2, TP13, TP38, TP44	None	227	None	Forbidden	Forbidden	D	40, 66
	<i>2,3,4,6-Tetranitrophenol</i>	Forbidden											
	<i>2,3,4,6-Tetranitrophenyl methyl nitramine</i>	Forbidden											
	<i>2,3,4,6-Tetranitrophenylnitramine</i>	Forbidden											
	<i>Tetranitroresorcinol (dry)</i>	Forbidden											
	<i>2,3,5,6-Tetranitroso-1,4-dinitrobenzene</i>	Forbidden											
	<i>2,3,5,6-Tetranitroso nitrobenzene (dry)</i>	Forbidden											
	Tetrapropylorthotitanate	3	UN2413	III	3	B1, IB3, T4, TP1	150	203	242	60 L	220 L	A	
	Tetrazene, <i>see</i> Guanyl nitrosaminoguanyltetrazene												
	<i>Tetrazine (dry)</i>	Forbidden											
	Tetrazol-1-acetic acid	1.4C	UN0407	1.4C	None	62	None	Forbidden	75 kg	02	25
	1H-Tetrazole	1.1D	UN0504	1.1D	None	62	None	Forbidden	Forbidden	04	25, 5E
	<i>Tetrazolyl azide (dry)</i>	Forbidden											
	Tetryl, <i>see</i> Trinitrophenylmethylnitramine												
A I W	Textile waste, wet	4.2	UN1857	III	4.2		151	213	240	Forbidden	Forbidden	A	
	Thallium chlorate	5.1	UN2573	II	5.1, 6.1	IB6, IP2, T3, TP33	152	212	242	5 kg	25 kg	A	56, 58
G	Thallium compounds, n.o.s	6.1	UN1707	II	6.1	IB8, IP2, IP4, T3, TP33	153	212	242	25 kg	100 kg	A	
	Thallium nitrate	6.1	UN2727	II	6.1, 5.1	IB6, IP2, T3, TP33	153	212	242	5 kg	25 kg	A	
	4-Thiapentanal	6.1	UN2785	III	6.1	IB3, T4, TP1, W31	153	203	241	60 L	220 L	D	25, 49
	Thioacetic acid	3	UN2436	II	3	IB2, T4, TP1	150	202	242	5 L	60 L	B	
	Thiocarbamate pesticide, liquid, flammable, toxic, flash point less than 23 degrees C	3	UN2772	I	3, 6.1	T14, TP2, TP13, TP27	None	201	243	Forbidden	30 L	B	40
	Thiocarbamate pesticide, liquid, toxic, flammable, flash point not less than 23 degrees C	6.1	UN3005	II	3, 6.1	IB2, T11, TP13, TP27	150	202	243	1 L	60 L	B	40
				I	6.1, 3	T14, TP2, TP13	None	201	243	1 L	30 L	B	40
				II	6.1, 3	IB2, T11, TP2, TP13, TP27	153	202	243	5 L	60 L	B	40
				III	6.1, 3	IB3, T7, TP2, TP28	153	203	242	60 L	220 L	A	40
	Thiocarbamate pesticide, liquid, toxic	6.1	UN3006	I	6.1	T14, TP2, TP13	None	201	243	1 L	30 L	B	40
				II	6.1	IB2, T11, TP2, TP13, TP27	153	202	243	5 L	60 L	B	40

§ 172.101 HAZARDOUS MATERIALS TABLE—Continued

Sym-bols (1)	Hazardous materials descriptions and proper shipping names (2)	Hazard class or Division (3)	Identi-fication Numbers (4)	PG (5)	Label Codes (6)	Special provisions (§ 172.102) (7)	(8)			(9)		(10) Vessel stowage		
							Packaging (§ 173.***)			Quantity limitations (see §§ 173.27 and 175.75)		Loca-tion (10A)	Other (10B)	
							Excep-tions (8A)	Non-bulk (8B)	Bulk (8C)	Passenger aircraft/rail (9A)	Cargo air-craft only (9B)			
304 +	Thiocarbamate pesticides, solid, toxic	6.1	UN2771	III	6.1	IB3, T7, TP2, TP28	153	203	241	60 L	220 L	A	40	
				I	6.1	IB7, IP1, T6, TP33	None	211	242	5 kg	50 kg	A	40	
	<i>Thiocarbonylchloride, see Thiophosgene</i>	6.1	UN2966	II	6.1	IB8, IP2, IP4, T3, TP33	153	212	242	25 kg	100 kg	A	40	
				III	6.1	IB8, IP3, T1, TP33	153	213	240	100 kg	200 kg	A	40	
	Thioglycol Thioglycolic acid	8	UN1940	II	6.1	IB2, T7, TP2	153	202	243	5 L	60 L	A		
				II	8	A7, B2, IB2, N34, T7, TP2	154	202	242	1 L	30 L	A	53, 58	
	Thiolactic acid Thionyl chloride	8	UN1836	II	6.1	IB2, T7, TP2	153	202	243	5 L	60 L	A		
				I	8	B6, B10, N34, T10, TP2, TP13	None	201	243	Forbidden	Forbidden	C	40, 53, 58	
	Thiophene Thiophosgene	6.1	UN2474	II	3	IB2, T4, TP1	150	202	242	5 L	60 L	B	40	
				I	6.1	2, B9, B14, B32, N33, N34, T20, TP2, TP13, TP38, TP45	None	227	244	Forbidden	Forbidden	D	40, 52	
	Thiophosphoryl chloride	8	UN1837	II	8	A3, A7, B2, B8, B25, IB2, N34, T7, TP2	154	202	242	Forbidden	30 L	C	40, 53, 58	
	Thiourea dioxide	4.2	UN3341	II	4.2	IB6, IP2, T3, TP33, W31	None	212	241	15 kg	50 kg	D		
	<i>Tin chloride, fuming, see Stannic chloride, anhydrous</i>				III	4.2	IB8, IP3, T1, TP33, W31	None	213	241	25 kg	100 kg	D	
	<i>Tin perchloride or Tin tetrachloride, see Stannic chloride, anhydrous</i>													
	Tinctures, medicinal	3	UN1293	II	3	IB2, T4, TP1, TP8	150	202	242	5 L	60 L	B		
	<i>Tinning flux, see Zinc chloride</i>				III	3	B1, IB3, T2, TP1	150	203	242	60 L	220 L	A	
	Tires and tire assemblies, see Air, compressed or Nitrogen, compressed													
	Titanium disulphide	4.2	UN3174	III	4.2	IB8, IP3, T1, TP33, W31	None	213	241	25 kg	100 kg	A		
	Titanium hydride	4.1	UN1871	II	4.1	A19, A20, IB4, N34, T3, TP33, W31, W40	151	212	241	15 kg	50 kg	E		
	Titanium powder, dry	4.2	UN2546	I	4.2	W31	None	211	242	Forbidden	Forbidden	D	13, 148	
II				4.2	A19, A20, IB6, IP2, N5, N34, T3, TP33, W31	None	212	241	15 kg	50 kg	D	13, 148		

§ 172.101

49 CFR Ch. I (10-1-23 Edition)

			III	4.2	B135, IB8, IP21, T1, TP33, W31	None	213	241	25 kg	100 kg	D	13, 148
	4.1	UN1352	II	4.1	A19, A20, IB6, IP2, N34, T3, TP33, W31, W40	151	212	240	15 kg	50 kg	E	74
	4.1	UN2878	III	4.1	A1, B134, IB8, IP21, T1, TP33, W100	151	213	240	25 kg	100 kg	D	13, 74, 147, 148
+	6.1	UN1838	I	6.1, 8	2, B7, B9, B14, B32, B77, T20, TP2, TP13, TP38, TP45	None	227	244	Forbidden	Forbidden	D	40, 53, 58
	8	UN2869	II	8	A7, IB8, IP2, IP4, N34, T3, TP33	154	212	240	15 kg	50 kg	A	40, 53, 58
			III	8	A7, IB8, IP3, N34, T1, TP33	154	213	240	25 kg	100 kg	A	40, 53, 58
	4.2	UN2441	I	4.2, 8	N34, W31	None	181	244	Forbidden	Forbidden	D	13, 40, 148
	3	UN1294	II	3	IB2, T4, TP1	150	202	242	5 L	60 L	B	
+	6.1	UN2078	II	6.1	IB2, T7, TP2, TP13	153	202	243	5 L	60 L	D	25, 40
	6.1	UN1708	II	6.1	IB2, T7, TP2	153	202	243	5 L	60 L	A	
	6.1	UN3451	II	6.1	IB8, IP2, IP4, T3, TP33	153	212	242	25 kg	100 kg	A	
+	6.1	UN1709	III	6.1	IB8, IP3, T1, TP33	153	213	240	100 kg	200 kg	A	
	6.1	UN3418	III	6.1	IB3, T4, TP1	153	203	241	60 L	220 L	A	
	1.3J	UN0450	1.3J		62	None	Forbidden	Forbidden	05	25, 23E
	1.1J	UN0449	1.1J		62	None	Forbidden	Forbidden	05	25, 23E
	1.1E	UN0329	1.1E		62	62	Forbidden	Forbidden	03	25
	1.1F	UN0330	1.1F		62	None	Forbidden	Forbidden	03	25
	1.1D	UN0451	1.1D		62	62	Forbidden	Forbidden	03	25
G	6.1	UN3488	I	6.1, 3, 8	1, B9, B14, B30, T22, TP2, TP13, TP27, TP38, TP44	None	226	244	Forbidden	Forbidden	D	40, 125

§ 172.101 HAZARDOUS MATERIALS TABLE—Continued

Sym-bols	Hazardous materials descriptions and proper shipping names	Hazard class or Division	Identi-fication Numbers	PG	Label Codes	Special provisions (§ 172.102)	(8)			(9)		(10) Vessel stowage	
							Packaging (§ 173.***)			Quantity limitations (see §§ 173.27 and 175.75)		Loca-tion	Other
							Excep-tions	Non-bulk	Bulk	Passenger aircraft/rail	Cargo air-craft only		
(1)	(2)	(3)	(4)	(5)	(6)	(7)	(8A)	(8B)	(8C)	(9A)	(9B)	(10A)	(10B)
G	Toxic by inhalation liquid, flammable, corrosive, n.o.s. with an LC50 lower than or equal to 1000 ml/m ³ and saturated vapor concentration greater than or equal to 10 LC50	6.1	UN3489	I	6.1, 3, 8	2, B9, B14, B32, T20, TP2, TP13, TP27, TP38, TP45	None	227	244	Forbidden	Forbidden	D	40, 125
G	Toxic by inhalation liquid, n.o.s. with an LC50 lower than or equal to 200 ml/m ³ and saturated vapor concentration greater than or equal to 500 LC50	6.1	UN3381	I	6.1	1, B9, B14, B30, T22, TP2, TP13, TP27, TP38, TP44	None	226	244	Forbidden	Forbidden	D	40
G	Toxic by inhalation liquid, n.o.s. with an LC50 lower than or equal to 1000 ml/m ³ and saturated vapor concentration greater than or equal to 10 LC50	6.1	UN3382	I	6.1	2, B9, B14, B32, T20, TP2, TP13, TP27, TP38, TP45	None	227	244	Forbidden	Forbidden	D	40
G	Toxic by inhalation liquid, flammable, n.o.s. with an LC50 lower than or equal to 200 ml/m ³ and saturated vapor concentration greater than or equal to 500 LC50	6.1	UN3383	I	6.1, 3	1, B9, B14, B30, T22, TP2, TP13, TP27, TP38, TP44	None	226	244	Forbidden	Forbidden	D	40
G	Toxic by inhalation liquid, flammable, n.o.s. with an LC50 lower than or equal to 1000 ml/m ³ and saturated vapor concentration greater than or equal to 10 LC50	6.1	UN3384	I	6.1, 3	2, B9, B14, B32, T20, TP2, TP13, TP27, TP38, TP45	None	227	244	Forbidden	Forbidden	D	40
G	Toxic by inhalation liquid, water-reactive, n.o.s. with an LC50 lower than or equal to 200 ml/m ³ and saturated vapor concentration greater than or equal to 500 LC50	6.1	UN3385	I	6.1, 4.3	1, B9, B14, B30, T22, TP2, TP13, TP38, TP44	None	226	244	Forbidden	Forbidden	D	13, 40, 148

§ 172.101

49 CFR Ch. I (10-1-23 Edition)

G	Toxic by inhalation liquid, water-reactive, n.o.s. with an LC50 lower than or equal to 1000 ml/m ³ and saturated vapor concentration greater than or equal to 10 LC50	6.1	UN3386	I	6.1, 4.3	2, B9, B14, B32, T20, TP2, TP13, TP38, TP44	None	227	244	Forbidden	Forbidden	D	13, 40, 148
G	Toxic by inhalation liquid, water-reactive, flammable, n.o.s. with an LC50 lower than or equal to 200 ml/m ³ and saturated vapor concentration greater than or equal to 500 LC50	6.1	UN3490	I	6.1, 4.3, 3	1, B9, B14, B30, T22, TP2, TP13, TP27, TP38, TP44	None	226	244	Forbidden	Forbidden	D	13, 21, 40, 49, 148
G	Toxic by inhalation liquid, water-reactive, flammable, n.o.s. with an LC50 lower than or equal to 1000 ml/m ³ and saturated vapor concentration greater than or equal to 10 LC50	6.1	UN3491	I	6.1, 4.3, 3	2, B9, B14, B32, T20, TP2, TP13, TP27, TP38, TP45	None	227	244	Forbidden	Forbidden	D	13, 21, 28, 40, 49, 148
G	Toxic by inhalation liquid, oxidizing, n.o.s. with an LC50 lower than or equal to 200 ml/m ³ and saturated vapor concentration greater than or equal to 500 LC50	6.1	UN3387	I	6.1, 5.1	1, B9, B14, B30, T22, TP2, TP13, TP38, TP44	None	226	244	Forbidden	Forbidden	D	40
G	Toxic by inhalation liquid, oxidizing, n.o.s. with an LC50 lower than or equal to 1000 ml/m ³ and saturated vapor concentration greater than or equal to 10 LC50	6.1	UN3388	I	6.1, 5.1	2, B9, B14, B32, T20, TP2, TP13, TP38, TP44	None	227	244	Forbidden	Forbidden	D	40
G	Toxic by inhalation liquid, corrosive, n.o.s. with an LC50 lower than or equal to 200 ml/m ³ and saturated vapor concentration greater than or equal to 500 LC50	6.1	UN3389	I	6.1, 8	1, B9, B14, B30, T22, TP2, TP13, TP27, TP38, TP44	None	226	244	Forbidden	Forbidden	D	40
G	Toxic by inhalation liquid, corrosive, n.o.s. with an LC50 lower than or equal to 1000 ml/m ³ and saturated vapor concentration greater than or equal to 10 LC50	6.1	UN3390	I	6.1, 8	2, B9, B14, B32, T20, TP2, TP13, TP27, TP38, TP45	None	227	244	Forbidden	Forbidden	D	40
G	Toxic liquid, corrosive, inorganic, n.o.s	6.1	UN3289	I	6.1, 8	T14, TP2, TP13, TP27	None	201	243	0.5 L	2.5 L	A	40
G	Toxic liquid, inorganic, n.o.s	6.1	UN3287	II	6.1, 8	IB2, T11, TP2, TP27	153	202	243	1 L	30 L	A	40
				I	6.1	T14, TP2, TP13, TP27	None	201	243	1 L	30 L	A	40
				II	6.1	IB2, T11, TP2, TP27	153	202	243	5 L	60 L	A	40
G	Toxic liquids, corrosive, organic, n.o.s.	6.1	UN2927	III	6.1	IB3, T7, TP1, TP28	153	203	241	60 L	220 L	A	40
				I	6.1, 8	T14, TP2, TP13, TP27	None	201	243	0.5 L	2.5 L	B	40
G	Toxic liquids, flammable, organic, n.o.s.	6.1	UN2929	II	6.1, 8	IB2, T11, TP2, TP27	153	202	243	1 L	30 L	B	40
				I	6.1, 3	T14, TP2, TP13, TP27	None	201	243	1 L	30 L	B	40
				II	6.1, 3	IB2, T11, TP2, TP13, TP27	153	202	243	5 L	60 L	B	40

§ 172.101 HAZARDOUS MATERIALS TABLE—Continued

§ 172.101

49 CFR Ch. I (10-1-23 Edition)

Sym-bols	Hazardous materials descriptions and proper shipping names	Hazard class or Division	Identi-fication Numbers	PG	Label Codes	Special provisions (§ 172.102)	(8)			(9)		(10) Vessel stowage	
							Packaging (§ 173.***)			Quantity limitations (see §§ 173.27 and 175.75)		Loca-tion	Other
							Excep-tions	Non-bulk	Bulk	Passenger aircraft/rail	Cargo air-craft only		
(1)	(2)	(3)	(4)	(5)	(6)	(7)	(8A)	(8B)	(8C)	(9A)	(9B)	(10A)	(10B)
G	Toxic, liquids, organic, n.o.s.	6.1	UN2810	I	6.1	T14, TP2, TP13, TP27 IB2, T11, TP2, TP13, TP27	None	201	243	1 L	30 L	B	40
				II	6.1		153	202	243	5 L	60 L	B	40
G	Toxic liquids, oxidizing, n.o.s.	6.1	UN3122	III	6.1	IB3, T7, TP1, TP28 A4	153	203	241	60 L	220 L	A	40
				I	6.1, 5.1		None	201	243	Forbidden	2.5 L	C	
G	Toxic liquids, water-reactive, n.o.s.	6.1	UN3123	II	6.1, 5.1	A4	153	202	243	1 L	5 L	C	
				I	6.1, 4.3		None	201	243	Forbidden	1 L	E	13, 40, 148
G	Toxic solid, corrosive, inorganic, n.o.s.	6.1	UN3290	II	6.1, 4.3	IB2	153	202	243	1 L	5 L	E	13, 40, 148
				I	6.1, 8		None	211	242	1 kg	25 kg	A	40
G	Toxic solid, flammable, inorganic, n.o.s.	6.1	UN3535	II	6.1, 8	IB6, IP2, T3, TP33 IB6, T6, TP33	153	212	242	15 kg	50 kg	A	40
				I	6.1, 4.1		None	211	242	1 kg	15 kg	B	
G	Toxic solid, inorganic, n.o.s.	6.1	UN3288	II	6.1, 4.1	IB8, IP2, IP4, T3, TP33 IB7, T6, TP33	153	212	242	15 kg	50 kg	B	40
				I	6.1		None	211	242	5 kg	50 kg	A	40
G	Toxic solids, corrosive, organic, n.o.s.	6.1	UN2928	III	6.1	IB8, IP2, IP4, T3, TP33 IB8, IP3, T1, TP33	153	212	242	25 kg	100 kg	A	40
				I	6.1, 8		None	213	240	100 kg	200 kg	A	40
G	Toxic solids, flammable, organic, n.o.s.	6.1	UN2930	II	6.1, 8	IB7, T6, TP33	153	211	242	1 kg	25 kg	B	40
				I	6.1, 4.1		None	211	242	1 kg	15 kg	B	
G	Toxic solids, organic, n.o.s.	6.1	UN2811	II	6.1, 4.1	IB6, IP2, T3, TP33 IB6, T6, TP33	153	212	242	15 kg	50 kg	B	40
				I	6.1		None	211	242	5 kg	50 kg	B	
G	Toxic solids, oxidizing, n.o.s.	6.1	UN3086	III	6.1	IB8, IP2, IP4, T3, TP33 IB8, IP3, T1, TP33	153	212	242	25 kg	100 kg	B	
				I	6.1, 5.1		None	213	240	100 kg	200 kg	A	40
G	Toxic solids, self-heating, n.o.s.	6.1	UN3124	II	6.1, 5.1	T6, TP33	153	211	242	1 kg	15 kg	C	
				I	6.1, 4.2		None	211	242	5 kg	15 kg	D	40

			II	6.1, 4.2	IB6, IP2, T3, TP33	None	212	242	15 kg	50 kg	D	40	
G	Toxic solids, water-reactive, n.o.s	6.1	UN3125	I	6.1, 4.3	A5, T6, TP33, W100	None	211	242	5 kg	15 kg	D	13, 40, 148
G	Toxins, extracted from living sources, liquid, n.o.s	6.1	UN3172	I	6.1	141	None	201	243	1 L	30 L	B	40
G	Toxins, extracted from living sources, solid, n.o.s	6.1	UN3462	II	6.1	141, IB2	153	202	243	5 L	60 L	B	40
			III	6.1	141, IB3	153	203	241	60 L	220 L	B	40	
			I	6.1	141, IB7, IP1, T6, TP33	None	211	243	5 kg	50 kg	B		
			II	6.1	141, IB8, IP2, IP4, T3 TP33	153	212	243	25 kg	100 kg	B		
D	Toy Caps	1.4S	NA0337	III	6.1	141, IB8, IP3, T1 TP33	153	213	241	100 kg	200 kg	A	
	Tracers for ammunition	1.3G	UN0212	1.4S	382	None	62	None	25 kg	100 kg	01	25
	Tracers for ammunition	1.4G	UN0306	1.3G	None	62	None	Forbidden	Forbidden	03	25
	Tractors, see Vehicle, etc			1.4G	None	62	None	Forbidden	75 kg	02	25
	Tri-(b-nitroxyethyl) ammonium nitrate	Forbidden											
	Triallyl borate	6.1	UN2609	III	6.1	IB3	153	203	241	60 L	220 L	A	13
	Triallylamine	3	UN2610	III	3, 8	B1, IB3, T4, TP1	150	203	242	5 L	60 L	A	40, 52
	Triazine pesticides, liquid, flammable, toxic, flash point less than 23 degrees C	3	UN2764	I	3, 6.1	T14, TP2, TP13, TP27	None	201	243	Forbidden	30 L	B	40
	Triazine pesticides, liquid, toxic	6.1	UN2998	II	3, 6.1	IB2, T11, TP2, TP13, TP27	150	202	243	1 L	60 L	B	40
				I	6.1	T14, TP2, TP13, TP27	None	201	243	1 L	30 L	B	40
				II	6.1	IB2, T11, TP2, TP13, TP27	153	202	243	5 L	60 L	B	40
	Triazine pesticides, liquid, toxic, flammable, flash point not less than 23 degrees C	6.1	UN2997	III	6.1	IB3, T7, TP2, TP28	153	203	241	60 L	220 L	A	40
				I	6.1, 3	T14, TP2, TP13, TP27	None	201	243	1 L	30 L	B	40
				II	6.1, 3	IB2, T11, TP2, TP13, TP27	153	202	243	5 L	60 L	B	40
	Triazine pesticides, solid, toxic	6.1	UN2763	III	6.1, 3	IB3, T7, TP2, TP28	153	203	242	60 L	220 L	A	40
				I	6.1	IB7, IP1, T6, TP33	None	211	242	5 kg	50 kg	A	40
				II	6.1	IB8, IP2, IP4, T3, TP33	153	212	242	25 kg	100 kg	A	40
				III	6.1	IB8, IP3, T1, TP33	153	213	240	100 kg	200 kg	A	40
	Tributylamine	6.1	UN2542	II	6.1	IB2, T7, TP2	153	202	243	5 L	60 L	A	
	Tributylphosphane	4.2	UN3254	I	4.2	T21, TP7, TP33	None	211	242	Forbidden	Forbidden	D	136
	Trichloro-s-triazinetrione dry, with more than 39 percent available chlorine, see Trichloroisocyanuric acid, dry												
	Trichloroacetic acid	8	UN1839	II	8	A7, IB8, IP2, IP4, N34, T3, TP33	154	212	240	15 kg	50 kg	A	53, 58
	Trichloroacetic acid, solution	8	UN2564	II	8	A3, A7, B2, IB2, N34, T7, TP2	154	202	242	1 L	30 L	B	53, 58

§ 172.101 HAZARDOUS MATERIALS TABLE—Continued

Sym-bols	Hazardous materials descriptions and proper shipping names	Hazard class or Division	Identi-fication Numbers	PG	Label Codes	Special provisions (§ 172.102)	(8)			(9)		(10) Vessel stowage	
							Packaging (§ 173.***)			Quantity limitations (see §§ 173.27 and 175.75)		Loca-tion	Other
							Excep-tions	Non-bulk	Bulk	Passenger aircraft/rail	Cargo air-craft only		
(1)	(2)	(3)	(4)	(5)	(6)	(7)	(8A)	(8B)	(8C)	(9A)	(9B)	(10A)	(10B)
+	Trichloroacetyl chloride	8	UN2442	II	8, 6.1	A3, A7, IB3, N34, T4, TP1	154	203	241	5 L	60 L	B	8, 53, 58
	Trichlorobenzenes, liquid	6.1	UN2321	III	6.1	2, B9, B14, B32, N34, T20, TP2, TP38, TP45	None	227	244	Forbidden	Forbidden	D	40, 53, 58
	Trichlorobutene	6.1	UN2322	II	6.1	IB3, T4, TP1	153	203	241	60 L	220 L	A	
	1,1,1-Trichloroethane	6.1	UN2831	III	6.1	IB2, T7, TP2	153	202	243	5 L	60 L	A	25, 40
	Trichloroethylene	6.1	UN1710	III	6.1	IB3, N36, T4, TP1	153	203	241	60 L	220 L	A	40
	Trichloroisocyanuric acid, dry	5.1	UN2468	II	5.1	IB3, N36, T4, TP1	153	203	241	60 L	220 L	A	40
	Trichloromethyl perchlorate	Forbidden				IB8, IP2, IP4, T3, TP33	152	212	240	5 kg	25 kg	A	13
	Trichlorosilane	4.3	UN1295	I	4.3, 3, 8	N34, T14, TP2, TP7, TP13, W31	None	201	244	Forbidden	Forbidden	D	21, 40, 49, 53, 58, 100
	Tricresyl phosphate with more than 3 percent ortho isomer	6.1	UN2574	II	6.1	A3, IB2, N33, N34, T7, TP2	153	202	243	5 L	60 L	A	
	Triethyl phosphite	3	UN2323	III	3	B1, IB3, T2, TP1	150	203	242	60 L	220 L	A	
	Triethylamine	3	UN1296	II	3, 8	IB2, T7, TP1	150	202	243	1 L	5 L	B	40
	Triethylenetetramine	8	UN2259	II	8	B2, IB2, T7, TP2	154	202	242	1 L	30 L	B	40, 52
	Trifluoroacetic acid	8	UN2699	I	8	A7, B4, N3, N34, N36, T10, TP2	None	201	243	0.5 L	2.5 L	B	12, 25, 40, 53, 58
	Trifluoroacetyl chloride	2.3	UN3057			2, B7, B9, B14, T50, TP21	None	304	314, 315	Forbidden	Forbidden	D	40
	Trifluorochloroethylene, stabilized or Refrigerant gas R 1113	2.3	UN1082	2.3, 2.1	3, 387, B14, T50	None	304	314, 315	Forbidden	Forbidden	D	25, 40
	Trifluoromethane or Refrigerant gas R 23	2.2	UN1984				306	304	314, 315	75 kg	150 kg	A	
	Trifluoromethane, refrigerated liquid	2.2	UN3136			T75, TP5	306	None	314, 315	50 kg	500 kg	D	
	1,1,1-Trifluoroethane or Refrigerant gas, R 143a	2.1	UN2035			T50	306	304	314, 315	Forbidden	150 kg	B	40
	2-Trifluoromethylaniline	6.1	UN2942	III	6.1	IB3	153	203	241	60 L	220 L	A	
	3-Trifluoromethylaniline	6.1	UN2948	II	6.1	IB2, T7, TP2	153	202	243	5 L	60 L	A	40
	Triformoxime trinitrate	Forbidden											
Triisobutylene	3	UN2324	III	3	B1, IB3, T4, TP1	150	203	242	60 L	220 L	A		
Triisopropyl borate	3	UN2616	II	3	IB2, T4, TP1	150	202	242	5 L	60 L	A		

§ 172.101

49 CFR Ch. I (10-1-23 Edition)

D	Trimethoxysilane	6.1	NA9269	I	6.1, 3	2, B9, B14, B32, T20, TP4, TP13, TP38, TP45	None	227	244	Forbidden	Forbidden	E	40
	Trimethyl borate	3	UN2416	II	3	IB2, T7, TP1	150	202	242	5 L	60 L	B	
	Trimethyl phosphite	3	UN2329	III	3	B1, IB3, T2, TP1	150	203	242	60 L	220 L	A	
	1,3,5-Trimethyl-2,4,6-trinitrobenzene	Forbidden											
	Trimethylacetyl chloride	6.1	UN2438	I	6.1, 8, 3	2, B3, B9, B14, B32, N34, T20, TP2, TP13, TP38, TP45	None	227	244	Forbidden	Forbidden	D	21, 25, 40, 53, 58, 100
	Trimethylamine, anhydrous	2.1	UN1083	2.1	N87, T50	306	304	314, 315	Forbidden	150 kg	B	40, 52
	Trimethylamine, aqueous solutions with not more than 50 percent trimethylamine by mass	3	UN1297	I	3, 8	T11, TP1	None	201	243	0.5 L	2.5 L	D	40, 52, 135
				II	3, 8	B1, IB2, T7, TP1	150	202	243	1 L	5 L	B	40, 41, 52
				III	3, 8	B1, IB3, T7, TP1	150	203	242	5 L	60 L	A	40, 41, 52
	1,3,5-Trimethylbenzene	3	UN2325	III	3	B1, IB3, T2, TP2	150	203	242	60 L	220 L	A	
	Trimethylchlorosilane	3	UN1298	II	3, 8	A3, A7, B77, N34, T10, TP2, TP7, TP13	None	206	243	Forbidden	5 L	E	40, 53, 58
	Trimethylcyclohexylamine	8	UN2326	III	8	IB3, T4, TP1	154	203	241	5 L	60 L	A	52
	Trimethylene glycol diperchlorate	Forbidden											
	Trimethylhexamethylene diisocyanate	6.1	UN2328	III	6.1	IB3, T4, TP2, TP13	153	203	241	60 L	220 L	B	
	Trimethylhexamethylenediamines	8	UN2327	III	8	IB3, T4, TP1	154	203	241	5 L	60 L	A	52
	Trimethylol nitromethane trinitrate	Forbidden											
	Trinitro-m-cresol	1.1D	UN0216	1.1D	None	62	None	Forbidden	Forbidden	04	25, 5E
	2,4,6-Trinitro-1,3-diazobenzene	Forbidden											
	2,4,6-Trinitro-1,3,5-triazido benzene (dry)	Forbidden											
	Trinitroacetic acid	Forbidden											
	Trinitroacetonitrile	Forbidden											
	Trinitroamine cobalt	Forbidden											
	Trinitroaniline or Picramide	1.1D	UN0153	1.1D	None	62	None	Forbidden	Forbidden	04	25
	Trinitroanisole	1.1D	UN0213	1.1D	None	62	None	Forbidden	Forbidden	04	25
	Trinitrobenzene, dry or wetted with less than 30 percent water, by mass	1.1D	UN0214	1.1D	None	62	None	Forbidden	Forbidden	04	25
	Trinitrobenzene, wetted, with not less than 10% water, by mass	4.1	UN3367	I	4.1	162, A8, A19, N41, N84, W31	None	211	None	0.5 kg	0.5 kg	E	28, 36
	Trinitrobenzene, wetted with not less than 30 percent water, by mass	4.1	UN1354	I	4.1	23, A2, A8, A19, N41, W31	None	211	None	0.5 kg	0.5 kg	E	28, 36
	Trinitrobenzenesulfonic acid	1.1D	UN0386	1.1D	None	62	None	Forbidden	Forbidden	04	25, 5E
	Trinitrobenzoic acid, dry or wetted with less than 30 percent water, by mass	1.1D	UN0215	1.1D	None	62	None	Forbidden	Forbidden	04	25
	Trinitrobenzoic acid, wetted with not less than 10% water by mass	4.1	UN3368	I	4.1	162, A8, A19, N41, N84, W31	None	211	None	0.5 kg	0.5 kg	E	28, 36

§ 172.101 HAZARDOUS MATERIALS TABLE—Continued

Sym-bols (1)	Hazardous materials descriptions and proper shipping names (2)	Hazard class or Division (3)	Identi-fication Numbers (4)	PG (5)	Label Codes (6)	Special provisions (§ 172.102) (7)	(8)			(9)		(10) Vessel stowage	
							Packaging (§ 173.***)			Quantity limitations (see §§ 173.27 and 175.75)		Loca-tion (10A)	Other (10B)
							Excep-tions (8A)	Non-bulk (8B)	Bulk (8C)	Passenger aircraft/rail (9A)	Cargo air-craft only (9B)		
	Trinitrobenzoic acid, wetted with not less than 30 percent water, by mass	4.1	UN1355	I	4.1	23, A2, A8, A19, N41, W31	None	211	None	0.5 kg	0.5 kg	E	28, 36
	Trinitrochlorobenzene or Picryl chloride	1.1D	UN0155	1.1D	None	62	None	Forbidden	Forbidden	04	25
	Trinitrochlorobenzene (picryl chloride), wetted, with not less than 10% water by mass	4.1	UN3365	I	4.1	162, A8, A19, N41, N84, W31	None	211	None	0.5 kg	0.5 kg	E	28, 36
	Trinitroethanol	Forbidden											
	Trinitroethylnitrate	Forbidden											
	Trinitrofluorenone	1.1D	UN0387	1.1D	None	62	None	Forbidden	Forbidden	04	25
	Trinitromethane	Forbidden											
	1,3,5-Trinitronaphthalene	Forbidden											
	Trinitronaphthalene	1.1D	UN0217	1.1D	None	62	None	Forbidden	Forbidden	04	25
	Trinitrophenetole	1.1D	UN0218	1.1D	None	62	None	Forbidden	Forbidden	04	25
	Trinitrophenol (picric acid), wetted, with not less than 10 percent water by mass	4.1	UN3364	I	4.1	23, A8, A19, N41, N84, W31	None	211	None	0.5 kg	0.5 kg	E	28, 36
	Trinitrophenol or Picric acid, dry or wetted with less than 30 percent water, by mass	1.1D	UN0154	1.1D	None	62	None	Forbidden	Forbidden	04	25, 5E
	Trinitrophenol, wetted with not less than 30 percent water, by mass	4.1	UN1344	I	4.1	162, A8, A19, N41, W31	None	211	None	1 kg	15 kg	E	28, 36
	2,4,6-Trinitrophenyl guanidine (dry)	Forbidden											
	2,4,6-Trinitrophenyl nitramine	Forbidden											
	2,4,6-Trinitrophenyl trimethylol methyl nitramine trinitrate (dry)	Forbidden											
	Trinitrophenylmethylnitramine or Tetryl	1.1D	UN0208	1.1D	None	62	None	Forbidden	Forbidden	04	25
	Trinitroresorcinol or Styphnic acid, dry or wetted with less than 20 percent water, or mixture of alcohol and water, by mass	1.1D	UN0219	1.1D	None	62	None	Forbidden	Forbidden	04	25, 5E
	Trinitroresorcinol, wetted or Styphnic acid, wetted with not less than 20 percent water, or mixture of alcohol and water by mass	1.1D	UN0394	1.1D	385	None	62	None	Forbidden	Forbidden	04	25, 5E

§ 172.101

49 CFR Ch. I (10-1-23 Edition)

2,4,6-Trinitroso-3-methyl nitraminoanisole	Forbidden												
Trinitrotetramine cobalt nitrate	Forbidden												
Trinitrotoluene and Trinitrobenzene mixtures or TNT and trinitrobenzene mixtures or TNT and hexanitrostilbene mixtures or Trinitrotoluene and hexanitrostilbene mixtures	1.1D	UN0388	1.1D	None	62	None	Forbidden	Forbidden	04	25	
Trinitrotoluene mixtures containing Trinitrobenzene and Hexanitrostilbene or TNT mixtures containing trinitrobenzene and hexanitrostilbene	1.1D	UN0389	1.1D	None	62	None	Forbidden	Forbidden	04	25	
Trinitrotoluene or TNT, dry or wetted with less than 30 percent water, by mass	1.1D	UN0209	1.1D	None	62	None	Forbidden	Forbidden	04	25	
Trinitrotoluene (TNT), wetted, with not less than 10 percent water by mass	4.1	UN3366	I	4.1	162, A8, A19, N41, N84, W31	None	211	None	0.5 kg	0.5 kg	E	28, 36	
Trinitrotoluene, wetted or TNT, wetted, with not less than 30 percent water by mass	4.1	UN1356	I	4.1	23, A2, A8, A19, N41, W31	None	211	None	0.5 kg	0.5 kg	E	28, 36	
Tripropylamine	3	UN2260	III	3, 8	B1, IB3, T4, TP1	150	203	242	5 L	60 L	A	40, 52	
Tripropylene	3	UN2057	II	3	IB2, T4, TP2	150	202	242	5 L	60 L	B		
			III	3	B1, IB3, T2, TP2	150	203	242	60 L	220 L	A		
Tris-(1-aziridinyl)phosphine oxide, solution	6.1	UN2501	II	6.1	IB2, T7, TP2	153	202	243	5 L	60 L	A		
			III	6.1	IB3, T4, TP1	153	203	241	60 L	220 L	A		
Tris, bis-bifluoroamino diethoxy propane (TVOPA)	Forbidden												
Tritonal	1.1D	UN0390	1.1D	None	62	None	Forbidden	Forbidden	04	25	
Tungsten hexafluoride	2.3	UN2196		2.3, 8	2, N86	None	338	None	Forbidden	Forbidden	D	40	
Turpentine	3	UN1299	III	3	B1, IB3, T2, TP2	150	203	242	60 L	220 L	A		
Turpentine substitute	3	UN1300	I	3	T11, TP1, TP8, TP27	None	201	243	1 L	30 L	B		
			II	3	IB2, T4, TP1	150	202	242	5 L	60 L	B		
			III	3	B1, IB3, T2, TP1	150	203	242	60 L	220 L	A		
Undecane	3	UN2330	III	3	B1, IB3, T2, TP1	150	203	242	60 L	220 L	A		
Uranium hexafluoride, radioactive material, excepted package, less than 0.1 kg per package, non-fissile or fissile-excepted	6.1	UN3507	I	6.1, 7, 8	369	420	None	None	Less than .1 kg	Less than .1 kg	A	132, 152	
Urea hydrogen peroxide	5.1	UN1511	III	5.1, 8	A1, A7, A29, IB8, IP3, T1, TP33	152	213	240	25 kg	100 kg	A	13	
Urea nitrate, dry or wetted with less than 20 percent water, by mass	1.1D	UN0220	1.1D	119	None	62	None	Forbidden	Forbidden	04	25	
Urea nitrate, wetted, with not less than 10 percent water by mass	4.1	UN3370	I	4.1	162, A8, A19, N41, N84, W31	None	211	None	0.5 kg	0.5 kg	E	28, 36	
Urea nitrate, wetted with not less than 20 percent water, by mass	4.1	UN1357	I	4.1	23, 39, A8, A19, N41, W31	None	211	None	1 kg	15 kg	E	28, 36	

§ 172.101 HAZARDOUS MATERIALS TABLE—Continued

§ 172.101

49 CFR Ch. I (10-1-23 Edition)

Sym-bols (1)	Hazardous materials descriptions and proper shipping names (2)	Hazard class or Division (3)	Identi-fication Numbers (4)	PG (5)	Label Codes (6)	Special provisions (§ 172.102) (7)	(8)			(9)		(10) Vessel stowage										
							Packaging (§ 173.***)			Quantity limitations (see §§ 173.27 and 175.75)		Loca-tion (10A)	Other (10B)									
							Excep-tions (8A)	Non-bulk (8B)	Bulk (8C)	Passenger aircraft/rail (9A)	Cargo air-craft only (9B)											
G	<i>Urea peroxide, see Urea hydrogen peroxide</i>	3	UN2058	II	3	IB2, T4, TP1	150	202	242	5 L	60 L	B										
	Valeraldehyde																					
	<i>Valeric acid, see Corrosive liquids, n.o.s.</i>	8	UN2502	II	8, 3	A3, A7, B2, IB2, N34, T7, TP2	154	202	243	1 L	30 L	C	40, 53, 58									
	Valeryl chloride																					
	Vanadium compound, n.o.s.	6.1	UN3285	I	6.1	IB7, IP1, T6, TP33	None	211	242	5 kg	50 kg	B										
														III	6.1	IB8, IP2, IP4, T3, TP33	153	212	242	25 kg	100 kg	B
														III	6.1	IB8, IP3, T1, TP33	153	213	240	100 kg	200 kg	B
	Vanadium oxytrichloride	8	UN2443	II	8	A3, A7, B2, B16, IB2, N34, T7, TP2	154	202	242	Forbidden	30 L	C	40, 53, 58									
	Vanadium pentoxide, <i>non-fused form</i>																					
	Vanadium tetrachloride	8	UN2444	I	8	A7, B4, N34, T10, TP2	None	201	243	Forbidden	2.5 L	C	40, 53, 58									
	Vanadium trichloride																					
	Vanadium sulfate	6.1	UN2931	II	6.1	IB8, IP2, IP4, T3, TP33	153	212	242	25 kg	100 kg	A										
	Vehicle, flammable gas powered or Vehicle, fuel cell, flammable gas powered																					
	Vehicle, flammable liquid powered or Vehicle, fuel cell, flammable liquid powered	9	UN3166	9	135, A200	220	220	220	Forbidden	No limit	A										
	Very signal cartridge, <i>see Cartridges, signal</i>																					
	Vinyl acetate, stabilized	3	UN1301	II	3	387, IB2, T4, TP1	150	202	242	5 L	60 L	C	25									
Vinyl bromide, stabilized																						
Vinyl butyrate, stabilized	3	UN2838	II	3	387, IB2, T4, TP1	150	202	242	5 L	60 L	C	25										
Vinyl chloride, stabilized																						
Vinyl chloroacetate	6.1	UN2589	II	6.1, 3	IB2, T7, TP2	153	202	243	5 L	60 L	A											
Vinyl ethyl ether, stabilized																						
Vinyl fluoride, stabilized	2.1	UN1860	2.1	387, T11, TP2	None	201	243	1 L	30 L	D											
Vinyl isobutyl ether, stabilized																						
	3	UN1304	II	3	387, IB2, T4, TP1	150	202	242	5 L	60 L	C	25										

Vinyl methyl ether, stabilized	2.1	UN1087	2.1	387, B44, T50	306	304	314, 315	Forbidden	150 kg	B	25, 40
<i>Vinyl nitrate polymer</i>	Forbidden											
Vinylidene chloride, stabilized	3	UN1303	I	3	387, T12, TP2, TP7	150	201	243	1 L	30 L	D	25, 40
Vinylpyridines, stabilized	6.1	UN3073	II	6.1, 3, 8	387, IB1, T7, TP2, TP13	153	202	243	1 L	30 L	B	21, 25, 40, 52, 100
Vinyltoluenes, stabilized	3	UN2618	III	3	387, B1, IB3, T2, TP1	150	203	242	60 L	220 L	C	25
Vinyltrichlorosilane	3	UN1305	II	3, 8	A3, A7, B6, N34, T10, TP2, TP7, TP13	None	206	243	Forbidden	5 L	B	40, 53, 58, 25
Warheads, rocket with burster or expelling charge	1.4D	UN0370	1.4D	None	62	62	Forbidden	75 kg	02	25
Warheads, rocket with burster or expelling charge	1.4F	UN0371	1.4F	None	62	None	Forbidden	Forbidden	03	25
Warheads, rocket with bursting charge	1.1D	UN0286	1.1D	None	62	62	Forbidden	Forbidden	03	25
Warheads, rocket with bursting charge	1.2D	UN0287	1.2D	None	62	62	Forbidden	Forbidden	03	25
Warheads, rocket with bursting charge	1.1F	UN0369	1.1F	None	62	None	Forbidden	Forbidden	03	25
Warheads, torpedo with bursting charge	1.1D	UN0221	1.1D	None	62	62	Forbidden	Forbidden	03	25
G Water-reactive liquid, corrosive, n.o.s.	4.3	UN3129	I	4.3, 8	T14, TP2, TP7, TP13	None	201	243	Forbidden	1 L	D	13,148
		II	4.3, 8	IB1, T11, TP2, TP7	None	202	243	1 L	5 L	E	13, 85, 148
		III	4.3, 8	IB2, T7, TP2, TP7	None	203	242	5 L	60 L	E	13, 85, 148
G Water-reactive liquid, n.o.s.	4.3	UN3148	I	4.3	T13, TP2, TP7, W31	None	201	244	Forbidden	1 L	E	13, 40, 148
		II	4.3	IB1, T7, TP2, TP7, W31	None	202	243	1 L	5 L	E	13, 40, 148
		III	4.3	IB2, T7, TP2, TP7, W31	None	203	242	5 L	60 L	E	13, 40, 148
G Water-reactive liquid, toxic, n.o.s	4.3	UN3130	I	4.3, 6.1	A4	None	201	243	Forbidden	1 L	D	13, 148
			II	4.3, 6.1	IB1	151	202	243	1 L	5 L	E	13, 85, 148
			III	4.3, 6.1	IB2	151	203	242	5 L	60 L	E	13, 85, 148
G Water-reactive solid, corrosive, n.o.s	4.3	UN3131	I	4.3, 8	IB4, IP1, N40, T9, TP7, TP33, W31	None	211	242	Forbidden	15 kg	D	13, 148
			II	4.3, 8	IB6, IP2, T3, TP33, W31, W40	151	212	242	15 kg	50 kg	E	13, 85, 148
			III	4.3, 8	IB8, IP4, T1, TP33, W31	151	213	241	25 kg	100 kg	E	13, 85, 148
G Water-reactive solid, flammable, n.o.s.	4.3	UN3132	I	4.3, 4.1	IB4, N40, W31	None	211	242	Forbidden	15 kg	D	13, 148
		II	4.3, 4.1	IB4, T3, TP33, W31, W40	151	212	242	15 kg	50 kg	E	13, 85, 148

§ 172.101 HAZARDOUS MATERIALS TABLE—Continued

§ 172.101

49 CFR Ch. I (10-1-23 Edition)

Sym-bols	Hazardous materials descriptions and proper shipping names	Hazard class or Division	Identi-fication Numbers	PG	Label Codes	Special provisions (§ 172.102)	(8)			(9)		(10) Vessel stowage	
							Packaging (§ 173.***)			Quantity limitations (see §§ 173.27 and 175.75)		Loca-tion	Other
							Excep-tions	Non-bulk	Bulk	Passenger aircraft/rail	Cargo air-craft only		
(1)	(2)	(3)	(4)	(5)	(6)	(7)	(8A)	(8B)	(8C)	(9A)	(9B)	(10A)	(10B)
G	Water-reactive solid, n.o.s	4.3	UN2813	III	4.3, 4.1	IB6, T1, TP33, W31	151	213	241	25 kg	100 kg	E	13, 85, 148
				I	4.3	IB4, N40, T9, TP7, TP33, W31	None	211	242	Forbidden	15 kg	E	13, 40, 148
				II	4.3	B132, IB7, IP2, IP21, T3, TP33, W31, W40	151	212	242	15 kg	50 kg	E	13, 40, 148
				III	4.3	B132, IB8, IP21, T1, TP33, W31	151	213	241	25 kg	100 kg	E	13, 40, 148
G	Water-reactive, solid, oxidizing, n.o.s	4.3	UN3133	II	4.3, 5.1	151	214	214	Forbidden	Forbidden	E	13, 40, 148
				III	4.3, 5.1	151	214	214	Forbidden	Forbidden	E	13, 40, 148
G	Water-reactive solid, self-heating, n.o.s.	4.3	UN3135	I	4.3, 4.2	N40, W31	None	211	242	Forbidden	15 kg	D	13, 148
				II	4.3, 4.2	IB5, IP2, T3, TP33, W31, W40	None	212	242	15 kg	50 kg	E	13, 85, 148
G	Water-reactive solid, toxic, n.o.s	4.3	UN3134	III	4.3, 4.2	IB8, IP4, T1, TP33, W31	None	213	241	25 kg	100 kg	E	13, 85, 148
				I	4.3, 6.1	A8, IB4, IP1, N40, W31	None	211	242	Forbidden	15 kg	D	13, 148
				II	4.3, 6.1	IB5, IP2, T3, TP33, W31, W40	151	212	242	15 kg	50 kg	E	13, 85, 148
A I W	Wheelchair, electric, see Battery powered vehicle or Battery powered equipment White acid, see Hydrofluoric acid Wood preservatives, liquid	3	UN1306	II	3	149, IB2, T4, TP1, TP8	150	202	242	5 L	60 L	B	
				III	3	B1, IB3, T2, TP1	150	203	242	60 L	220 L	A	40
				III	4.2		151	213	240	Forbidden	Forbidden	A	
				II	4.2	IB6, IP2, T3, TP33, W31	None	212	241	15 kg	50 kg	D	40
				III	4.2	IB8, IP3, T1, TP33, W31	None	213	241	25 kg	100 kg	D	40
					2.2		306, 307	302	None	75 kg	150 kg	A	
					2.2	UN2591	2.2		T75, TP5	320	None	None	50 kg
	Xenon, refrigerated liquid (cryogenic liquids)	2.2	UN2591		2.2								
	Xylenes	3	UN1307	II	3	IB2, T4, TP1	150	202	242	5 L	60 L	B	

316

Xylenols, solid	6.1	UN2261	III	3	B1, IB3, T2, TP1	150	203	242	60 L	220 L	A	
Xylenols, liquid	6.1	UN3430	II	6.1	IB8, IP2, IP4, T3, TP33	153	212	242	25 kg	100 kg	A	
Xylidines, liquid	6.1	UN1711	II	6.1	IB2, T7, TP2	153	202	243	5 L	60 L	A	
Xylidines, solid	6.1	UN3452	II	6.1	IB2, T7, TP2	153	202	243	5 L	60 L	A	
Xylyl bromide, liquid	6.1	UN1701	II	6.1	IB8, IP2, IP4, T3, TP33	153	212	242	25 kg	100 kg	A	
Xylyl bromide, solid	6.1	UN3417	II	6.1	A3, A7, IB2, N33, T7, TP2, TP13, W31	None	340	None	Forbidden	60 L	D	40
<i>p</i> -Xylyl diazide	Forbidden				A3, A6, A7, IB8, IP2, IP4, N33, T3, TP33	None	340	None	25 kg	100 kg	B	40
Zinc ammonium nitrite	5.1	UN1512	II	5.1	IB8, IP4, T3, TP33	152	212	242	5 kg	25 kg	E	
Zinc arsenate or Zinc arsenite or Zinc arsenate and zinc arsenite mixtures	6.1	UN1712	II	6.1	IB8, IP2, IP4, T3, TP33	153	212	242	25 kg	100 kg	A	
Zinc ashes	4.3	UN1435	III	4.3	A1, A19, B136, IB8, IP4, T1, TP33, W100	151	213	241	25 kg	100 kg	A	13, 148
<i>Zinc bisulfite solution, see Bisulfites, aqueous solutions, n.o.s.</i>												
Zinc bromate	5.1	UN2469	III	5.1	A1, A29, IB8, IP3, T1, TP33	152	213	240	25 kg	100 kg	A	56, 58
Zinc chlorate	5.1	UN1513	II	5.1	A9, IB8, IP2, IP4, N34, T3, TP33	152	212	242	5 kg	25 kg	A	56, 58
Zinc chloride, anhydrous	8	UN2331	III	8	IB8, IP3, T1, TP33	154	213	240	25 kg	100 kg	A	53, 58
Zinc chloride, solution	8	UN1840	III	8	IB3, T4, TP2	154	203	241	5 L	60 L	A	53, 58
Zinc cyanide	6.1	UN1713	I	6.1	IB7, IP1, T6, TP33	None	211	242	5 kg	50 kg	A	52
Zinc dithionite or Zinc hydrosulfite	9	UN1931	III	None	IB8, IP3, T1, TP33	155	204	240	100 kg	200 kg	A	13, 26, 123, 123, 52
Zinc fluorosilicate	6.1	UN2855	III	6.1	IB8, IP3, T1, TP33	153	213	240	100 kg	200 kg	A	52
Zinc hydrosulfite, <i>see</i> Zinc dithionite												
<i>Zinc muriate solution, see</i> Zinc chloride, solution												
Zinc nitrate	5.1	UN1514	II	5.1	IB8, IP2, IP4, T3, TP33	152	212	240	5 kg	25 kg	A	
Zinc permanganate	5.1	UN1515	II	5.1	IB6, IP2, T3, TP33	152	212	242	5 kg	25 kg	D	56, 58, 138
Zinc peroxide	5.1	UN1516	II	5.1	IB6, IP2, T3, TP33, W100	152	212	242	5 kg	25 kg	C	13, 52, 66, 75, 148
Zinc phosphide	4.3	UN1714	I	4.3, 6.1	A19, N40, W31	None	211	None	Forbidden	15 kg	E	13, 40, 52, 85, 148
Zinc powder or Zinc dust	4.3	UN1436	I	4.3, 4.2	A19, IB4, IP1, N40, W31	None	211	242	Forbidden	15 kg	A	13, 52, 53, 148
			II	4.3, 4.2	A19, IB7, IP2, T3, TP33, W31, W40	None	212	242	15 kg	50 kg	A	13, 52, 53, 148
			III	4.3, 4.2	IB8, IP4, T1, TP33, W31	None	213	242	25 kg	100 kg	A	13, 52, 53, 148
Zinc resinate	4.1	UN2714	III	4.1	A1, IB6, T1, TP33	151	213	240	25 kg	100 kg	A	
<i>Zinc selenate, see</i> Selenates or Selenites												

§ 172.101 HAZARDOUS MATERIALS TABLE—Continued

Sym-bols (1)	Hazardous materials descriptions and proper shipping names (2)	Hazard class or Division (3)	Identi-fication Numbers (4)	PG (5)	Label Codes (6)	Special provisions (§ 172.102) (7)	(8)			(9)		(10) Vessel stowage	
							Packaging (§ 173.***)			Quantity limitations (see §§ 173.27 and 175.75)		Loca-tion (10A)	Other (10B)
							Excep-tions (8A)	Non-bulk (8B)	Bulk (8C)	Passenger aircraft/rail (9A)	Cargo air-craft only (9B)		
	<i>Zinc selenite, see Selenates or Selenites</i>												
	<i>Zinc silicofluoride, see Zinc fluorosilicate</i>												
	Zirconium, dry, <i>coiled wire, finished metal sheets, strip (thinner than 254 microns but not thinner than 18 microns)</i>	4.1	UN2858	III	4.1	A1, W100	151	213	240	25 kg	100 kg	A	13, 147, 148
	Zirconium, dry, <i>finished sheets, strip or coiled wire</i>	4.2	UN2009	III	4.2	A1, A19, W31	None	213	240	25 kg	100 kg	D	13, 148
	Zirconium hydride	4.1	UN1437	II	4.1	A19, A20, IB4, N34, T3, TP33, W31, W40	151	212	240	15 kg	50 kg	E	
	Zirconium nitrate	5.1	UN2728	III	5.1	A1, A29, IB8, IP3, T1, TP33	152	213	240	25 kg	100 kg	A	
	Zirconium picramate, <i>dry or wetted with less than 20 percent water, by mass</i>	1.3C	UN0236	1.3C	None	62	None	Forbidden	Forbidden	04	25, 5E
	Zirconium picramate, <i>wetted with not less than 20 percent water, by mass</i>	4.1	UN1517	I	4.1	23, N41, W31	None	211	None	1 kg	15 kg	D	28, 36
	Zirconium powder, dry	4.2	UN2008	I II III	4.2 4.2 4.2	T21, TP7, TP33, W31 A19, A20, IB6, IP2, N5, N34, T3, TP33, W31 B135, IB8, IP4, T1, TP33, W31	None None None	211 212 213	242 241 241	Forbidden 15 kg 25 kg	Forbidden 50 kg 100 kg	D D D	13, 148 13, 148 13, 148
	Zirconium powder, <i>wetted with not less than 25 percent water (a visible excess of water must be present) (a) mechanically produced, particle size less than 53 microns; (b) chemically produced, particle size less than 840 microns</i>	4.1	UN1358	II	4.1	A19, A20, IB6, IP2, N34, T3, TP33, W31, W40	151	212	241	15 kg	50 kg	E	13, 74, 147, 148
	Zirconium scrap	4.2	UN1932	III	4.2	B135, IB8, IP21, N34, T1, TP33, W31	None	213	240	Forbidden	Forbidden	D	13, 148
	Zirconium suspended in a liquid	3	UN1308	I II III	3 3 3 IB2 B1, IB2	None 150 150	201 202 203	243 242 242	Forbidden 5 L 60 L	Forbidden 60 L 220 L	B B B	

§ 172.101

49 CFR Ch. I (10-1-23 Edition)

Zirconium tetrachloride	8	UN2503	III	8	IB8, IP3, T1, TP33	154	213	240	25 kg	100 kg	A	53, 58
-------------------------	---	--------	-----	---	--------------------	-----	-----	-----	-------	--------	---	--------

§ 172.101

49 CFR Ch. I (10–1–23 Edition)

APPENDIX A TO § 172.101—LIST OF HAZARDOUS SUBSTANCES AND REPORTABLE QUANTITIES

1. This appendix lists materials and their corresponding reportable quantities (RQ's) that are listed or designated as "hazardous substances" under section 101(14) of the Comprehensive Environmental Response, Compensation, and Liability Act, 42 U.S.C. 9601(14) (CERCLA; 42 U.S.C. 9601 *et seq.*). This listing fulfills the requirement of CERCLA, 42 U.S.C. 9656(a), that all "hazardous substances," as defined in 42 U.S.C. 9601(14), be listed and regulated as hazardous materials under 49 U.S.C. 5101–5127. That definition includes substances listed under sections 311(b)(2)(A) and 307(a) of the Federal Water Pollution Control Act, 33 U.S.C. 1321(b)(2)(A) and 1317(a), section 3001 of the Solid Waste Disposal Act, 42 U.S.C. 6921, and section 112 of the Clean Air Act, 42 U.S.C. 7412. In addition, this list contains materials that the Administrator of the Environmental Protection Agency has determined to be hazardous substances in accordance with section 102 of CERCLA, 42 U.S.C. 9602. It should be noted that 42 U.S.C. 9656(b) provides that common and contract carriers may be held liable under laws other than CERCLA for the release of a hazardous substance as defined in that Act, during transportation that commenced before the effective date of the listing and regulating of that substance as a hazardous material under 49 U.S.C. 5101–5127.

2. This appendix is divided into two TABLES which are entitled "TABLE 1—HAZARDOUS SUBSTANCES OTHER THAN RADIONUCLIDES" and "TABLE 2—RADIONUCLIDES." A material listed in this appendix is regulated as a hazardous material and a hazardous substance under this subchapter if it meets the definition of a hazardous substance in § 171.8 of this subchapter.

3. The procedure for selecting a proper shipping name for a hazardous substance is set forth in § 172.101(c).

4. Column 1 of TABLE 1, entitled "*Hazardous substance*", contains the names of those elements and compounds that are hazardous substances. Following the listing of elements and compounds is a listing of waste streams. These waste streams appear on the list in numerical sequence and are referenced by the appropriate "D", "F", or "K" numbers. Column 2 of TABLE 1, entitled "*Reportable quantity (RQ)*", contains the report-

able quantity (RQ), in pounds and kilograms, for each hazardous substance listed in Column 1 of TABLE 1.

5. A series of notes is used throughout TABLE 1 and TABLE 2 to provide additional information concerning certain hazardous substances. These notes are explained at the end of each TABLE.

6. TABLE 2 lists radionuclides that are hazardous substances and their corresponding RQ's. The RQ's in table 2 for radionuclides are expressed in units of curies and terabecquerels, whereas those in table 1 are expressed in units of pounds and kilograms. If a material is listed in both table 1 and table 2, the lower RQ shall apply. Radionuclides are listed in alphabetical order. The RQ's for radionuclides are given in the radiological unit of measure of curie, abbreviated "Ci", followed, in parentheses, by an equivalent unit measured in terabecquerels, abbreviated "TBq".

7. For mixtures of radionuclides, the following requirements shall be used in determining if a package contains an RQ of a hazardous substance: (i) if the identity and quantity (in curies or terabecquerels) of each radionuclide in a mixture or solution is known, the ratio between the quantity per package (in curies or terabecquerels) and the RQ for the radionuclide must be determined for each radionuclide. A package contains an RQ of a hazardous substance when the sum of the ratios for the radionuclides in the mixture or solution is equal to or greater than one; (ii) if the identity of each radionuclide in a mixture or solution is known but the quantity per package (in curies or terabecquerels) of one or more of the radionuclides is unknown, an RQ of a hazardous substance is present in a package when the total quantity (in curies or terabecquerels) of the mixture or solution is equal to or greater than the lowest RQ of any individual radionuclide in the mixture or solution; and (iii) if the identity of one or more radionuclides in a mixture or solution is unknown (or if the identity of a radionuclide by itself is unknown), an RQ of a hazardous substance is present when the total quantity (in curies or terabecquerels) in a package is equal to or greater than either one curie or the lowest RQ of any known individual radionuclide in the mixture or solution, whichever is lower.

TABLE 1 TO APPENDIX A—HAZARDOUS SUBSTANCES OTHER THAN RADIONUCLIDES

Hazardous substance	Reportable quantity (RQ) pounds (kilograms)
A2213	5000 (2270)
Acenaphthene	100 (45.4)
Acenaphthylene	5000 (2270)
Acetaldehyde	1000 (454)
Acetaldehyde, chloro-	1000 (454)

TABLE 1 TO APPENDIX A—HAZARDOUS SUBSTANCES OTHER THAN RADIONUCLIDES—Continued

Hazardous substance	Reportable quantity (RQ) pounds (kilograms)
Acetaldehyde, trichloro-	5000 (2270)
Acetamide	100 (45.4)
Acetamide, N-(aminothioxomethyl)-	1000 (454)
Acetamide, N-(4-ethoxyphenyl)-	100 (45.4)
Acetamide, N-9H-fluoren-2-yl-	1 (0.454)
Acetamide, 2-fluoro-	100 (45.4)
Acetic acid	5000 (2270)
Acetic acid, (2,4-dichlorophenoxy)-, salts & esters	100 (45.4)
Acetic acid, ethyl ester	5000 (2270)
Acetic acid, fluoro-, sodium salt	10 (4.54)
Acetic acid, lead(2 +) salt	10 (4.54)
Acetic acid, thallium(1 +) salt	100 (45.4)
Acetic acid, (2,4,5-trichlorophenoxy)-	1000 (454)
Acetic anhydride	5000 (2270)
Acetone	5000 (2270)
Acetone cyanohydrin	10 (4.54)
Acetonitrile	5000 (2270)
Acetophenone	5000 (2270)
2-Acetylaminofluorene	1 (0.454)
Acetyl bromide	5000 (2270)
Acetyl chloride	5000 (2270)
1-Acetyl-2-thiourea	1000 (454)
Acrolein	1 (0.454)
Acrylamide	5000 (2270)
Acrylic acid	5000 (2270)
Acrylonitrile	100 (45.4)
Adipic acid	5000 (2270)
Aldicarb	1 (0.454)
Aldicarb sulfone	100 (45.4)
Aldrin	1 (0.454)
Allyl alcohol	100 (45.4)
Allyl chloride	1000 (454)
Aluminum phosphide	100 (45.4)
Aluminum sulfate	5000 (2270)
4-Aminobiphenyl	1 (0.454)
5-(Aminomethyl)-3-isoxazolol	1000 (454)
4-Aminopyridine	1000 (454)
Amitrole	10 (4.54)
Ammonia	100 (45.4)
Ammonium acetate	5000 (2270)
Ammonium benzoate	5000 (2270)
Ammonium bicarbonate	5000 (2270)
Ammonium bichromate	10 (4.54)
Ammonium bifluoride	100 (45.4)
Ammonium bisulfite	5000 (2270)
Ammonium carbamate	5000 (2270)
Ammonium carbonate	5000 (2270)
Ammonium chloride	5000 (2270)
Ammonium chromate	10 (4.54)
Ammonium citrate, dibasic	5000 (2270)
Ammonium dichromate ®	10 (4.54)
Ammonium fluoborate	5000 (2270)
Ammonium fluoride	100 (45.4)
Ammonium hydroxide	1000 (454)
Ammonium oxalate	5000 (2270)
Ammonium picrate	10 (4.54)
Ammonium silicofluoride	1000 (454)
Ammonium sulfamate	5000 (2270)
Ammonium sulfide	100 (45.4)
Ammonium sulfite	5000 (2270)
Ammonium tartrate	5000 (2270)
Ammonium thiocyanate	5000 (2270)
Ammonium vanadate	1000 (454)
Amyl acetate	5000 (2270)
iso-Amyl acetate.	
sec-Amyl acetate.	
tert-Amyl acetate.	
Aniline	5000 (2270)
o-Anisidine	100 (45.4)
Anthracene	5000 (2270)

TABLE 1 TO APPENDIX A—HAZARDOUS SUBSTANCES OTHER THAN RADIONUCLIDES—Continued

Hazardous substance	Reportable quantity (RQ) pounds (kilograms)
Antimony ϵ	5000 (2270)
Antimony pentachloride	1000 (454)
Antimony potassium tartrate	100 (45.4)
Antimony tribromide	1000 (454)
Antimony trichloride	1000 (454)
Antimony trifluoride	1000 (454)
Antimony trioxide	1000 (454)
Argentate(1-), bis(cyano-C)-, potassium	1 (0.454)
Aroclor 1016	1 (0.454)
Aroclor 1221	1 (0.454)
Aroclor 1232	1 (0.454)
Aroclor 1242	1 (0.454)
Aroclor 1248	1 (0.454)
Aroclor 1254	1 (0.454)
Aroclor 1260	1 (0.454)
Aroclors	1 (0.454)
Arsenic ϵ	1 (0.454)
Arsenic acid H_3AsO_4	1 (0.454)
Arsenic disulfide	1 (0.454)
Arsenic oxide As_2O_3	1 (0.454)
Arsenic oxide As_2O_5	1 (0.454)
Arsenic pentoxide	1 (0.454)
Arsenic trichloride	1 (0.454)
Arsenic trioxide	1 (0.454)
Arsenic trisulfide	1 (0.454)
Arsine, diethyl-	1 (0.454)
Arsinic acid, dimethyl-	1 (0.454)
Arsonous dichloride, phenyl-	1 (0.454)
Asbestos $\epsilon\epsilon$	1 (0.454)
Auramine	100 (45.4)
Azaserine	1 (0.454)
Aziridine	1 (0.454)
Aziridine, 2-methyl-	1 (0.454)
Azirino[2,3':3,4]pyrrolo[1,2-a]indole-4,7-dione, 6-amino-8-[[[(aminocarbonyl)oxy]methyl]-1,1a,2,8,8a,8b-hexahydro-8a-methoxy-5-methyl-, [1aS-(1a α ,8 β ,8a α ,8b α)]-	10 (4.54)
Barban	10 (4.54)
Barium cyanide	10 (4.54)
Bendiocarb	100 (45.4)
Bendiocarb phenol	1000 (454)
Benomyl	10 (4.54)
Benz[<i>j</i>]aceanthrylene, 1,2-dihydro-3-methyl-	10 (4.54)
Benz[<i>c</i>]acridine	100 (45.4)
Benzal chloride	5000 (2270)
Benzamide, 3,5-dichloro-N-(1,1-dimethyl-2-propynyl)-	5000 (2270)
Benz[<i>a</i>]anthracene	10 (4.54)
1,2-Benzanthracene	10 (4.54)
Benz[<i>a</i>]anthracene, 7,12-dimethyl-	1 (0.454)
Benzenamine	5000 (2270)
Benzenamine, 4,4'-carbonimidoylbis (N,N dimethyl-	100 (45.4)
Benzenamine, 4-chloro-	1000 (454)
Benzenamine, 4-chloro-2-methyl-, hydrochloride	100 (45.4)
Benzenamine, N,N-dimethyl-4-(phenylazo)-	10 (4.54)
Benzenamine, 2-methyl-	100 (45.4)
Benzenamine, 4-methyl-	100 (45.4)
Benzenamine, 4,4'-methylenebis[2-chloro-	10 (4.54)
Benzenamine, 2-methyl-, hydrochloride	100 (45.4)
Benzenamine, 2-methyl-5-nitro-	100 (45.4)
Benzenamine, 4-nitro-	5000 (2270)
Benzene	10 (4.54)
Benzenoacetic acid, 4-chloro- α -(4-chlorophenyl)- α -hydroxy-, ethyl ester	10 (4.54)
Benzene, 1-bromo-4-phenoxy-	100 (45.4)
Benzenobutanoic acid, 4-[bis(2-chloroethyl)amino]-	10 (4.54)
Benzene, chloro-	100 (45.4)
Benzene, (chloromethyl)-	100 (45.4)
Benzenediamine, ar-methyl-	10 (4.54)
1,2-Benzenedicarboxylic acid, bis(2-ethylhexyl) ester	100 (45.4)
1,2-Benzenedicarboxylic acid, dibutyl ester	10 (4.54)
1,2-Benzenedicarboxylic acid, diethyl ester	1000 (454)
1,2-Benzenedicarboxylic acid, dimethyl ester	5000 (2270)
1,2-Benzenedicarboxylic acid, dioctyl ester	5000 (2270)

TABLE 1 TO APPENDIX A—HAZARDOUS SUBSTANCES OTHER THAN RADIONUCLIDES—Continued

Hazardous substance	Reportable quantity (RQ) pounds (kilograms)
Benzene, 1,2-dichloro-	100 (45.4)
Benzene, 1,3-dichloro-	100 (45.4)
Benzene, 1,4-dichloro-	100 (45.4)
Benzene, 1,1'-(2,2-dichloroethylidene) bis[4-chloro-	1 (0.454)
Benzene, (dichloromethyl)-	5000 (2270)
Benzene, 1,3-diisocyanatomethyl-	100 (45.4)
Benzene, dimethyl-	100 (45.4)
1,3-Benzenediol	5000 (2270)
1,2-Benzenediol,4-[1-hydroxy-2-(methylamino) ethyl]-	1000 (454)
Benzeneethanamine, alpha,alpha-dimethyl-	5000 (2270)
Benzene, hexachloro-	10 (4.54)
Benzene, hexahydro-	1000 (454)
Benzene, methyl-	1000 (454)
Benzene, 1-methyl-2,4-dinitro-	10 (4.54)
Benzene, 2-methyl-1,3-dinitro-	100 (45.4)
Benzene, (1-methylethyl)-	5000 (2270)
Benzene, nitro-	1000 (454)
Benzene, pentachloro-	10 (4.54)
Benzene, pentachloronitro-	100 (45.4)
Benzenesulfonic acid chloride	100 (45.4)
Benzenesulfonyl chloride	100 (45.4)
Benzene,1,2,4,5-tetrachloro-	5000 (2270)
Benzenethiol	100 (45.4)
Benzene,1,1'-(2,2,2-trichloroethylidene) bis[4-chloro-	1 (0.454)
Benzene,1,1'-(2,2,2-trichloroethylidene) bis[4-methoxy-	1 (0.454)
Benzene, (trichloromethyl)-	10 (4.54)
Benzene, 1,3,5-trinitro-	10 (4.54)
Benzidine	1 (0.454)
Benzo[a]anthracene	10 (4.54)
1,3-Benzodioxole, 5-(1-propenyl)-1	100 (45.4)
1,3-Benzodioxole, 5-(2-propenyl)-	100 (45.4)
1,3-Benzodioxole, 5-propyl-	10 (4.54)
1,3-Benzodioxol-4-ol, 2,2-dimethyl-	1000 (454)
1,3-Benzodioxol-4-ol, 2,2-dimethyl-, methyl carbamate	100 (45.4)
Benzo[b]fluoranthene	1 (0.454)
Benzo[k]fluoranthene	5000 (2270)
7-Benzofuranol, 2,3-dihydro-2,2-dimethyl-	10 (4.54)
7-Benzofuranol, 2,3-dihydro-2,2-dimethyl-, methylcarbamate	10 (4.54)
Benzoic acid	5000 (2270)
Benzoic acid, 2-hydroxy-, compd. with (3aS-cis)-1,2,3,3a,8,8a-hexahydro-1,3a,8-trimethylpyrrolo [2,3-b]indol-5-yl methylcarbamate ester (1:1)	100 (45.4)
Benzonitrile	5000 (2270)
Benzo[rs]pentaphene	10 (4.54)
Benzo[ghi]perylene	5000 (2270)
2H-1-Benzopyran-2-one, 4-hydroxy-3-(3-oxo-1-phenylbutyl)-, & salts	100 (45.4)
Benzo[a]pyrene	1 (0.454)
3,4-Benzopyrene	1 (0.454)
p-Benzoquinone	10 (4.54)
Benzotrichloride	10 (4.54)
Benzoyl chloride	1000 (454)
Benzyl chloride	100 (45.4)
Beryllium ϵ	10 (4.54)
Beryllium chloride	1 (0.454)
Beryllium fluoride	1 (0.454)
Beryllium nitrate	1 (0.454)
Beryllium powder ϵ	10 (4.54)
alpha-BHC	10 (4.54)
beta-BHC	1 (0.454)
delta-BHC	1 (0.454)
gamma-BHC	1 (0.454)
2,2'-Bioxirane	10 (4.54)
Biphenyl	100 (45.4)
[1,1'-Biphenyl]-4,4'-diamine	1 (0.454)
[1,1'-Biphenyl]-4,4'-diamine,3,3'-dichloro-	1 (0.454)
[1,1'-Biphenyl]-4,4'-diamine,3,3'-dimethoxy-	100 (45.4)
[1,1'-Biphenyl]-4,4'-diamine,3,3'-dimethyl-	10 (4.54)
Bis(2-chloroethoxy) methane	1000 (454)
Bis(2-chloroethyl) ether	10 (4.54)
Bis(chloromethyl) ether	10 (4.54)
Bis(2-ethylhexyl) phthalate	100 (45.4)

TABLE 1 TO APPENDIX A—HAZARDOUS SUBSTANCES OTHER THAN RADIONUCLIDES—Continued

Hazardous substance	Reportable quantity (RQ) pounds (kilograms)
Bromoacetone	1000 (454)
Bromoform	100 (45.4)
Bromomethane	1000 (454)
4-Bromophenyl phenyl ether	100 (45.4)
Brucine	100 (45.4)
1,3-Butadiene	10 (4.54)
1,3-Butadiene, 1,1,2,3,4,4-hexachloro-	1 (0.454)
1-Butanamine, N-butyl-N-nitroso-	10 (4.54)
1-Butanol	5000 (2270)
2-Butanone	5000 (2270)
2-Butanone, 3,3-dimethyl-1(methylthio)-, O [(methylamino) carbonyl] oxime	100 (45.4)
2-Butanone peroxide	10 (4.54)
2-Butenal	100 (45.4)
2-Butene, 1,4-dichloro-	1 (0.454)
2-Butenoic acid, 2-methyl-, 7-[[2,3-dihydroxy-2-(1-methoxyethyl)-3-methyl-1-oxobutoxy] methyl]-2,3,5,7a-tetrahydro-1H-pyrrrolizin-1-yl ester, [1S-[1alpha(Z), 7(2S*,3R*), 7aalpha]-	10 (4.54)
Butyl acetate	5000 (2270)
iso-Butyl acetate.	
sec-Butyl acetate.	
tert-Butyl acetate.	
n-Butyl alcohol	5000 (2270)
Butylamine	1000 (454)
iso-Butylamine.	
sec-Butylamine.	
tert-Butylamine.	
Butyl benzyl phthalate	100 (45.4)
n-Butyl phthalate	10 (4.54)
Butyric acid	5000 (2270)
iso-Butyric acid.	
Cacodylic acid	1 (0.454)
Cadmium	10 (4.54)
Cadmium acetate	10 (4.54)
Cadmium bromide	10 (4.54)
Cadmium chloride	10 (4.54)
Calcium arsenate	1 (0.454)
Calcium arsenite	1 (0.454)
Calcium carbide	10 (4.54)
Calcium chromate	10 (4.54)
Calcium cyanamide	1000 (454)
Calcium cyanide Ca(CN) ₂	10 (4.54)
Calcium dodecylbenzenesulfonate	1000 (454)
Calcium hypochlorite	10 (4.54)
Captan	10 (4.54)
Carbamic acid, 1H-benzimidazol-2-yl, methyl ester	10 (4.54)
Carbamic acid, [1-[(butylamino)carbonyl]-1H-benzimidazol-2-yl]-, methyl ester	10 (4.54)
Carbamic acid, (3-chlorophenyl)-, 4-chloro-2-butynyl ester	10 (4.54)
Carbamic acid, [(dibutylamino)-thio]methyl-, 2,3-dihydro-2,2-dimethyl-7-benzofuranyl ester	1000 (454)
Carbamic acid, dimethyl-, 1-[(dimethyl-amino)carbonyl]-5-methyl-1H-pyrazol-3-yl ester	1 (0.454)
Carbamic acid, dimethyl-, 3-methyl-1-(1-methylethyl)-1H-pyrazol-5-yl ester	100 (45.4)
Carbamic acid, ethyl ester	100 (45.4)
Carbamic acid, methyl-, 3-methylphenyl ester	1000 (454)
Carbamic acid, methylnitroso-, ethyl ester	1 (0.454)
Carbamic acid, [1,2-phenylenebis(iminocarbonothioyl)] bis-, dimethyl ester	10 (4.54)
Carbamic acid, phenyl-, 1-methylethyl ester	1000 (454)
Carbamic chloride, dimethyl-	1 (0.454)
Carbamodithioic acid, 1,2-ethanedylbis-, salts & esters	5000 (2270)
Carbamothioic acid, bis(1-methylethyl)-, S-(2,3-dichloro-2-propenyl) ester	100 (45.4)
Carbamothioic acid, bis(1-methylethyl)-, S-(2,3,3-trichloro-2-propenyl) ester	100 (45.4)
Carbamothioic acid, dipropyl-, S-(phenylmethyl) ester	5000 (2270)
Carbaryl	100 (45.4)
Carbendazim	10 (4.54)
Carbofuran	10 (4.54)
Carbofuran phenol	10 (4.54)
Carbon disulfide	100 (45.4)
Carbonic acid, dithallium(1 +) salt	100 (45.4)
Carbonic dichloride	10 (4.54)
Carbonic difluoride	1000 (454)
Carbonochloridic acid, methyl ester	1000 (454)
Carbon oxyfluoride	1000 (454)
Carbon tetrachloride	10 (4.54)

TABLE 1 TO APPENDIX A—HAZARDOUS SUBSTANCES OTHER THAN RADIONUCLIDES—Continued

Hazardous substance	Reportable quantity (RQ) pounds (kilograms)
Carbonyl sulfide	100 (45.4)
Carbosulfan	1000 (454)
Catechol	100 (45.4)
Chloral	5000 (2270)
Chloramben	100 (45.4)
Chlorambucil	10 (4.54)
Chlordane	1 (0.454)
Chlordane, alpha & gamma isomers	1 (0.454)
CHLORDANE (TECHNICAL MIXTURE AND METABOLITES)	1 (0.454)
Chlorinated camphene	1 (0.454)
Chlorine	10 (4.54)
Chlornaphazine	100 (45.4)
Chloroacetaldehyde	1000 (454)
Chloroacetic acid	100 (45.4)
2-Chloroacetophenone	100 (45.4)
p-Chloroaniline	1000 (454)
Chlorobenzene	100 (45.4)
Chlorobenzilate	10 (4.54)
p-Chloro-m-cresol	5000 (2270)
Chlorodibromomethane	100 (45.4)
1-Chloro-2,3-epoxypropane	100 (45.4)
Chloroethane	100 (45.4)
2-Chloroethyl vinyl ether	1000 (454)
Chloroform	10 (4.54)
Chloromethane	100 (45.4)
Chloromethyl methyl ether	10 (4.54)
beta-Chloronaphthalene	5000 (2270)
2-Chloronaphthalene	5000 (2270)
2-Chlorophenol	100 (45.4)
o-Chlorophenol	100 (45.4)
4-Chlorophenyl phenyl ether	5000 (2270)
1-(o-Chlorophenyl)thiourea	100 (45.4)
Chloroprene	100 (45.4)
3-Chloropropionitrile	1000 (454)
Chlorosulfonic acid	1000 (454)
4-Chloro-o-toluidine, hydrochloride	100 (45.4)
Chlorpyrifos	1 (0.454)
Chromic acetate	1000 (454)
Chromic acid	10 (4.54)
Chromic acid H ₂ CrO ₄ , calcium salt	10 (4.54)
Chromic sulfate	1000 (454)
Chromium ϵ	5000 (2270)
Chromous chloride	1000 (454)
Chrysene	100 (45.4)
Cobaltous bromide	1000 (454)
Cobaltous formate	1000 (454)
Cobaltous sulfamate	1000 (454)
Coke Oven Emissions	1 (0.454)
Copper ϵ	5000 (2270)
Copper chloride ϵ	10 (4.54)
Copper cyanide Cu(CN)	10 (4.54)
Coumaphos	10 (4.54)
Creosote	1 (0.454)
Cresol (cresylic acid)	100 (45.4)
m-Cresol	100 (45.4)
o-Cresol	100 (45.4)
p-Cresol	100 (45.4)
Cresols (isomers and mixture)	100 (45.4)
Cresylic acid (isomers and mixture)	100 (45.4)
Crotonaldehyde	100 (45.4)
Cumene	5000 (2270)
m-Cumenyl methylcarbamate	10 (4.54)
Cupric acetate	100 (45.4)
Cupric acetoarsenite	1 (0.454)
Cupric chloride	10 (4.54)
Cupric nitrate	100 (45.4)
Cupric oxalate	100 (45.4)
Cupric sulfate	10 (4.54)
Cupric sulfate, ammoniated	100 (45.4)
Cupric tartrate	100 (45.4)

TABLE 1 TO APPENDIX A—HAZARDOUS SUBSTANCES OTHER THAN RADIONUCLIDES—Continued

Hazardous substance	Reportable quantity (RQ) pounds (kilograms)
Cyanides (soluble salts and complexes) not otherwise specified	10 (4.54)
Cyanogen	100 (45.4)
Cyanogen bromide (CN)Br	1000 (454)
Cyanogen chloride (CN)Cl	10 (4.54)
2,5-Cyclohexadiene-1,4-dione	10 (4.54)
Cyclohexane	1000 (454)
Cyclohexane, 1,2,3,4,5,6-hexachloro-, (1 α , 2 α , 3 β -, 4 α , 5 α , 6 β)	1 (0.454)
Cyclohexanone	5000 (2270)
2-Cyclohexyl-4,6-dinitrophenol	100 (45.4)
1,3-Cyclopentadiene, 1,2,3,4,5-hexachloro-	10 (4.54)
Cyclophosphamide	10 (4.54)
2,4-D Acid	100 (45.4)
2,4-D Ester	100 (45.4)
2,4-D, salts and esters	100 (45.4)
Daunomycin	10 (4.54)
DDD	1 (0.454)
4,4'-DDD	1 (0.454)
DDE (72-55-9) #	1 (0.454)
DDE (3547-04-4) #	5000 (2270)
4,4'-DDE	1 (0.454)
DDT	1 (0.454)
4,4'-DDT	1 (0.454)
DEHP	100 (45.4)
Diallate	100 (45.4)
Diazinon	1 (0.454)
Diazomethane	100 (45.4)
Dibenz[a,h]anthracene	1 (0.454)
1,2,5,6-Dibenzanthracene	1 (0.454)
Dibenzo[a,h]anthracene	1 (0.454)
Dibenzofuran	100 (45.4)
Dibenzo[a,i]pyrene	10 (4.54)
1,2-Dibromo-3-chloropropane	1 (0.454)
Dibromoethane	1 (0.454)
Dibutyl phthalate	10 (4.54)
Di-n-butyl phthalate	10 (4.54)
Dicamba	1000 (454)
Dichlobenil	100 (45.4)
Dichlone	1 (0.454)
Dichlorobenzene	100 (45.4)
1,2-Dichlorobenzene	100 (45.4)
1,3-Dichlorobenzene	100 (45.4)
1,4-Dichlorobenzene	100 (45.4)
m-Dichlorobenzene	100 (45.4)
o-Dichlorobenzene	100 (45.4)
p-Dichlorobenzene	100 (45.4)
3,3'-Dichlorobenzidine	1 (0.454)
Dichlorobromomethane	5000 (2270)
1,4-Dichloro-2-butene	1 (0.454)
Dichlorodifluoromethane	5000 (2270)
1,1-Dichloroethane	1000 (454)
1,2-Dichloroethane	100 (45.4)
1,1-Dichloroethylene	100 (45.4)
1,2-Dichloroethylene	1000 (454)
Dichloroethyl ether	10 (4.54)
Dichloroisopropyl ether	1000 (454)
Dichloromethane	1000 (454)
Dichloromethoxyethane	1000 (454)
Dichloromethyl ether	10 (4.54)
2,4-Dichlorophenol	100 (45.4)
2,6-Dichlorophenol	100 (45.4)
Dichlorophenylarsine	1 (0.454)
Dichloropropane	1000 (454)
1,1-Dichloropropane	
1,3-Dichloropropane	
1,2-Dichloropropane	1000 (454)
Dichloropropane-Dichloropropene (mixture)	100 (45.4)
Dichloropropene	100 (45.4)
2,3-Dichloropropene	
1,3-Dichloropropene	100 (45.4)
2,2-Dichloropropionic acid	5000 (2270)

TABLE 1 TO APPENDIX A—HAZARDOUS SUBSTANCES OTHER THAN RADIONUCLIDES—Continued

Hazardous substance	Reportable quantity (RQ) pounds (kilograms)
Dichlorvos	10 (4.54)
Dicofol	10 (4.54)
Dieldrin	1 (0.454)
1,2:3,4-Diepoxybutane	10 (4.54)
Diethanolamine	100 (45.4)
Diethylamine	100 (45.4)
N,N-Diethylaniline	1000 (454)
Diethylarsine	1 (0.454)
Diethylene glycol, dicarbamate	5000 (2270)
1,4-Diethyleneoxide	100 (45.4)
Diethylhexyl phthalate	100 (45.4)
N,N'-Diethylhydrazine	10 (4.54)
O,O-Diethyl S-methyl dithiophosphate	5000 (2270)
Diethyl-p-nitrophenyl phosphate	100 (45.4)
Diethyl phthalate	1000 (454)
O,O-Diethyl O-pyrazinyl phosphorothioate	100 (45.4)
Diethylstilbestrol	1 (0.454)
Diethyl sulfate	10 (4.54)
Dihydrosafrole	10 (4.54)
Diisopropylfluorophosphate (DFP)	100 (45.4)
1,4:5,8-Dimethanonaphthalene, 1,2,3,4,10,10-hexachloro-1,4,4a,5,8,8a-hexahydro-, (1alpha, 4alpha, 4beta, 5alpha, 8alpha, 8beta)-	1 (0.454)
1,4:5,8-Dimethanonaphthalene, 1,2,3,4,10,10-hexachloro-1,4,4a,5,8,8a-hexahydro-, (1alpha, 4alpha, 4beta, 5beta, 8beta, 8beta)-1 (0.454)	1 (0.454)
2,7:3,6-Dimethanonaphth[2,3-b]oxirene,3,4,5,6,9,9-hexachloro-1a,2,2a,3,6,6a,7,7a-octahydro-, (1aalpha, 2beta, 2aalpha, 3beta, 6beta, 6aalpha, 7beta, 7aalpha)-	1 (0.454)
2,7:3,6-Dimethanonaphth[2, 3-b]oxirene,3,4,5,6,9,9-hexachloro-1a,2,2a,3,6,6a,7,7a-octahydro-, (1aalpha, 2beta, 2abeta, 3alpha, 6alpha, 6abeta, 7beta, 7aalpha)-, & metabolites	1 (0.454)
Dimethoate	10 (4.54)
3,3'-Dimethoxybenzidine	100 (45.4)
Dimethylamine	1000 (454)
Dimethyl aminoazobenzene	10 (4.54)
p-Dimethylaminoazobenzene	10 (4.54)
N,N-Dimethylaniline	100 (45.4)
7,12-Dimethylbenz[a]anthracene	1 (0.454)
3,3'-Dimethylbenzidine	10 (4.54)
alpha, alpha-Dimethylbenzylhydroperoxide	10 (4.54)
Dimethylcarbomoyl chloride	1 (0.454)
Dimethylformamide	100 (45.4)
1,1-Dimethylhydrazine	10 (4.54)
1,2-Dimethylhydrazine	1 (0.454)
Dimethylhydrazine, unsymmetrical®	10 (4.54)
alpha, alpha-Dimethylphenethylamine	5000 (2270)
2,4-Dimethylphenol	100 (45.4)
Dimethyl phthalate	5000 (2270)
Dimethyl sulfate	100 (45.4)
Dimetilan	1 (0.454)
Dinitrobenzene (mixed)	100 (45.4)
m-Dinitrobenzene.	
o-Dinitrobenzene.	
p-Dinitrobenzene.	
4,6-Dinitro-o-cresol, and salts	10 (4.54)
Dinitrogen tetroxide®	10 (4.54)
Dinitrophenol	10 (4.54)
2,5-Dinitrophenol.	
2,6-Dinitrophenol.	
2,4-Dinitrophenol	10 (4.54)
Dinitrotoluene	10 (4.54)
3,4-Dinitrotoluene.	
2,4-Dinitrotoluene	10 (4.54)
2,6-Dinitrotoluene	100 (45.4)
Dinoseb	1000 (454)
Di-n-octyl phthalate	5000 (2270)
1,4-Dioxane	100 (45.4)
1,2-Diphenylhydrazine	10 (4.54)
Diphosphoramidate, octamethyl-	100 (45.4)
Diphosphoric acid, tetraethyl ester	10 (4.54)
Dipropylamine	5000 (2270)
Di-n-propylnitrosamine	10 (4.54)
Diquat	1000 (454)

TABLE 1 TO APPENDIX A—HAZARDOUS SUBSTANCES OTHER THAN RADIONUCLIDES—Continued

Hazardous substance	Reportable quantity (RQ) pounds (kilograms)
Disulfoton	1 (0.454)
Dithiobiuret	100 (45.4)
1,3-Dithiolane-2-carboxaldehyde, 2,4-dimethyl-, O-[(methylamino)-carbonyl]oxime	100 (45.4)
Diuron	100 (45.4)
Dodecylbenzenesulfonic acid	1000 (454)
Endosulfan	1 (0.454)
alpha-Endosulfan	1 (0.454)
beta-Endosulfan	1 (0.454)
Endosulfan sulfate	1 (0.454)
Endothall	1000 (454)
Endrin	1 (0.454)
Endrin aldehyde	1 (0.454)
Endrin, & metabolites	1 (0.454)
Epichlorohydrin	100 (45.4)
Epinephrine	1000 (454)
1,2-Epoxybutane	100 (45.4)
Ethanal	1000 (454)
Ethanamine, N,N-diethyl-	5000 (2270)
Ethanamine, N-ethyl-N-nitroso-	1 (0.454)
1,2-Ethanediamine, N,N-dimethyl-N'-2-pyridinyl-N'-(2-thienylmethyl)-	5000 (2270)
Ethane, 1,2-dibromo-	1 (0.454)
Ethane, 1,1-dichloro-	1000 (454)
Ethane, 1,2-dichloro-	100 (45.4)
Ethanedinitrile	100 (45.4)
Ethane, hexachloro-	100 (45.4)
Ethane, 1,1'-[methylenebis(oxy)]bis[2-chloro-	1000 (454)
Ethane, 1,1'-oxybis-	100 (45.4)
Ethane, 1,1'-oxybis[2-chloro-	10 (4.54)
Ethane, pentachloro-	10 (4.54)
Ethane, 1,1,1,2-tetrachloro-	100 (45.4)
Ethane, 1,1,2,2-tetrachloro-	100 (45.4)
Ethanethioamide	10 (4.54)
Ethane, 1,1,1-trichloro-	1000 (454)
Ethane, 1,1,2-trichloro-	100 (45.4)
Ethanimidothioic acid, 2-(dimethylamino)-N-hydroxy-2-oxo-, methyl ester	5000 (2270)
Ethanimidothioic acid, 2-(dimethylamino)-N-[[[(methylamino) carbonyl]oxy]-2-oxo-, methyl ester	100 (45.4)
Ethanimidothioic acid, N-[[[(methylamino) carbonyl]oxy]-, methyl ester	100 (45.4)
Ethanimidothioic acid, N,N'[thiobis[(methylimino)carbonyloxy]] bis-, dimethyl ester	100 (45.4)
Ethanol, 2-ethoxy-	1000 (454)
Ethanol, 2,2'-(nitrosoimino)bis-	1 (0.454)
Ethanol, 2,2'-oxybis-, dicarbamate	5000 (2270)
Ethanone, 1-phenyl-	5000 (2270)
Ethene, chloro-	1 (0.454)
Ethene, (2-chloroethoxy)-	1000 (454)
Ethene, 1,1-dichloro-	100 (45.4)
Ethene, 1,2-dichloro-(E)	1000 (454)
Ethene, tetrachloro-	100 (45.4)
Ethene, trichloro-	100 (45.4)
Ethion	10 (4.54)
Ethyl acetate	5000 (2270)
Ethyl acrylate	1000 (454)
Ethylbenzene	1000 (454)
Ethyl carbamate	100 (45.4)
Ethyl chloride	100 (45.4)
Ethyl cyanide	10 (4.54)
Ethylenebisdithiocarbamic acid, salts & esters	5000 (2270)
Ethylenediamine	5000 (2270)
Ethylenediamine-tetraacetic acid (EDTA)	5000 (2270)
Ethylene dibromide	1 (0.454)
Ethylene dichloride	100 (45.4)
Ethylene glycol	5000 (2270)
Ethylene glycol monoethyl ether	1000 (454)
Ethylene oxide	10 (4.54)
Ethylenethiourea	10 (4.54)
Ethylenimine	1 (0.454)
Ethyl ether	100 (45.4)
Ethylidene dichloride	1000 (454)
Ethyl methacrylate	1000 (454)
Ethyl methanesulfonate	1 (0.454)
Ethyl methyl ketone ®	5000 (2270)

TABLE 1 TO APPENDIX A—HAZARDOUS SUBSTANCES OTHER THAN RADIONUCLIDES—Continued

Hazardous substance	Reportable quantity (RQ) pounds (kilograms)
Famphur	1000 (454)
Ferric ammonium citrate	1000 (454)
Ferric ammonium oxalate	1000 (454)
Ferric chloride	1000 (454)
Ferric fluoride	100 (45.4)
Ferric nitrate	1000 (454)
Ferric sulfate	1000 (454)
Ferrous ammonium sulfate	1000 (454)
Ferrous chloride	100 (45.4)
Ferrous sulfate	1000 (454)
Fluoranthene	100 (45.4)
Fluorene	5000 (2270)
Fluorine	10 (4.54)
Fluoroacetamide	100 (45.4)
Fluoroacetic acid, sodium salt	10 (4.54)
Formaldehyde	100 (45.4)
Formetanate hydrochloride	100 (45.4)
Formic acid	5000 (2270)
Formparanate	100 (45.4)
Fulminic acid, mercury(2 +)salt	10 (4.54)
Fumaric acid	5000 (2270)
Furan	100 (45.4)
2-Furancarboxyaldehyde	5000 (2270)
2,5-Furandione	5000 (2270)
Furan, tetrahydro-	1000 (454)
Furfural	5000 (2270)
Furfuran	100 (45.4)
Glucopyranose, 2-deoxy-2-(3-methyl-3-nitrosoareido)-, D-	1 (0.454)
D-Glucose, 2-deoxy-2-[[[(methylnitrosoamino)-carbonyl]amino]-	1 (0.454)
Glycidylaldehyde	10 (4.54)
Guanidine, N-methyl-N'-nitro-N-nitroso-	10 (4.54)
Guthion	1 (0.454)
Heptachlor	1 (0.454)
Heptachlor epoxide	1 (0.454)
Hexachlorobenzene	10 (4.54)
Hexachlorobutadiene	1 (0.454)
Hexachlorocyclopentadiene	10 (4.54)
Hexachloroethane	100 (45.4)
Hexachlorophene	100 (45.4)
Hexachloropropene	1000 (454)
Hexaethyl tetraphosphate	100 (45.4)
Hexamethylene-1,6-diisocyanate	100 (45.4)
Hexamethylphosphoramide	1 (0.454)
Hexane	5000 (2270)
Hexone	5000 (2270)
Hydrazine	1 (0.454)
Hydrazinecarbothioamide	100 (45.4)
Hydrazine, 1,2-diethyl-	10 (4.54)
Hydrazine, 1,1-dimethyl-	10 (4.54)
Hydrazine, 1,2-dimethyl-	1 (0.454)
Hydrazine, 1,2-diphenyl-	10 (4.54)
Hydrazine, methyl-	10 (4.54)
Hydrochloric acid	5000 (2270)
Hydrocyanic acid	10 (4.54)
Hydrofluoric acid	100 (45.4)
Hydrogen chloride	5000 (2270)
Hydrogen cyanide	10 (4.54)
Hydrogen fluoride	100 (45.4)
Hydrogen phosphide	100 (45.4)
Hydrogen sulfide H2S	100 (45.4)
Hydroperoxide, 1-methyl-1-phenylethyl-	10 (4.54)
Hydroquinone	100 (45.4)
2-Imidazolidinethione	10 (4.54)
Indeno(1,2,3-cd)pyrene	100 (45.4)
Iodomethane	100 (45.4)
1,3-Isobenzofurandione	5000 (2270)
Isobutyl alcohol	5000 (2270)
Isodrin	1 (0.454)
Isolan	100 (45.4)
Isophorone	5000 (2270)

TABLE 1 TO APPENDIX A—HAZARDOUS SUBSTANCES OTHER THAN RADIONUCLIDES—Continued

Hazardous substance	Reportable quantity (RQ) pounds (kilograms)
Isoprene	100 (45.4)
Isopropanolamine dodecylbenzenesulfonate	1000 (454)
3-Isopropylphenyl N-methylcarbamate	10 (4.54)
Isosafrole	100 (45.4)
3(2H)-Isoxazolone, 5-(aminomethyl)-	1000 (454)
Kepone	1 (0.454)
Lasiocarpine	10 (4.54)
Lead ϵ	10 (4.54)
Lead acetate	10 (4.54)
Lead arsenate	1 (0.454)
Lead, bis(acetato-O)tetrahydroxytri-	10 (4.54)
Lead chloride	10 (4.54)
Lead fluoborate	10 (4.54)
Lead fluoride	10 (4.54)
Lead iodide	10 (4.54)
Lead nitrate	10 (4.54)
Lead phosphate	10 (4.54)
Lead stearate	10 (4.54)
Lead subacetate	10 (4.54)
Lead sulfate	10 (4.54)
Lead sulfide	10 (4.54)
Lead thiocyanate	10 (4.54)
Lindane	1 (0.454)
Lindane (all isomers)	1 (0.454)
Lithium chromate	10 (4.54)
Malathion	100 (45.4)
Maleic acid	5000 (2270)
Maleic anhydride	5000 (2270)
Maleic hydrazide	5000 (2270)
Malononitrile	1000 (454)
Manganese, bis(dimethylcarbamodithioato-S,S')-	10 (4.54)
Manganese dimethyldithiocarbamate	10 (4.54)
MDI	5000 (2270)
MEK	5000 (2270)
Melphalan	1 (0.454)
Mercaptodimethur	10 (4.54)
Mercuric cyanide	1 (0.454)
Mercuric nitrate	10 (4.54)
Mercuric sulfate	10 (4.54)
Mercuric thiocyanate	10 (4.54)
Mercurous nitrate	10 (4.54)
Mercury	1 (0.454)
Mercury, (acetato-O)phenyl-	100 (45.4)
Mercury fulminate	10 (4.54)
Methacrylonitrile	1000 (454)
Methanamine, N-methyl-	1000 (454)
Methanamine, N-methyl-N-nitroso-	10 (4.54)
Methane, bromo-	1000 (454)
Methane, chloro-	100 (45.4)
Methane, chloromethoxy-	10 (4.54)
Methane, dibromo-	1000 (454)
Methane, dichloro-	1000 (454)
Methane, dichlorodifluoro-	5000 (2270)
Methane, iodo-	100 (45.4)
Methane, isocyanato-	10 (4.54)
Methane, oxybis(chloro-	10 (4.54)
Methanesulfonyl chloride, trichloro-	100 (45.4)
Methanesulfonic acid, ethyl ester	1 (0.454)
Methane, tetrachloro-	10 (4.54)
Methane, tetranitro-	10 (4.54)
Methanethiol	100 (45.4)
Methane, tribromo-	100 (45.4)
Methane, trichloro-	10 (4.54)
Methane, trichlorofluoro-	5000 (2270)
Methanimidamide, N,N-dimethyl-N'-[3-[(methylamino) carbonyl] oxy]	
phenyl]-, monohydrochloride	100 (45.4)
Methanimidamide, N,N-dimethyl-N'-[2-methyl-4-[(methylamino) carbonyl] oxy]phenyl]-	100 (45.4)
6,9-Methano-2,4,3-benzodioxathiepin,6,7,8,9,10,10-hexachloro-1,5,5a,6,9,9a-hexahydro-, 3-oxide	1 (0.454)
4,7-Methano-1H-indene, 1,4,5,6,7,8,8-heptachloro-3a,4,7,7a-tetrahydro-	1 (0.454)
4,7-Methano-1H-indene, 1,2,4,5,6,7,8,8-octachloro-2,3,3a,4,7,7a-hexahydro-	1 (0.454)

TABLE 1 TO APPENDIX A—HAZARDOUS SUBSTANCES OTHER THAN RADIONUCLIDES—Continued

Hazardous substance	Reportable quantity (RQ) pounds (kilograms)
Methanol	5000 (2270)
Methapyrilene	5000 (2270)
1,3,4-Metheno-2H-cyclobuta[cd]pentalen-2-one, 1,1a,3,3a,4,5,5,5a,5b,6-decachlorooctahydro-	1 (0.454)
Methiocarb	10 (4.54)
Methomyl	100 (45.4)
Methoxychlor	1 (0.454)
Methyl alcohol	5000 (2270)
Methylamine	100 (45.4)
2-Methyl aziridine	1 (0.454)
Methyl bromide	1000 (454)
1-Methylbutadiene	100 (45.4)
Methyl chloride	100 (45.4)
Methyl chlorocarbonate	1000 (454)
Methyl chloroform	1000 (454)
Methyl chloroformate	1000 (454)
Methyl chloromethyl ether	10 (4.54)
3-Methylcholanthrene	10 (4.54)
4,4'-Methylenebis(2-chloroaniline)	10 (4.54)
Methylene bromide	1000 (454)
Methylene chloride	1000 (454)
4,4'-Methylenedianiline	10 (4.54)
Methylene diphenyl diisocyanate	5000 (2270)
Methyl ethyl ketone	5000 (2270)
Methyl ethyl ketone peroxide	10 (4.54)
Methyl hydrazine	10 (4.54)
Methyl iodide	100 (45.4)
Methyl isobutyl ketone	5000 (2270)
Methyl isocyanate	10 (4.54)
2-Methylacetonitrile	10 (4.54)
Methyl mercaptan	100 (45.4)
Methyl methacrylate	1000 (454)
Methyl parathion	100 (45.4)
4-Methyl-2-pentanone	5000 (2270)
Methyl tert-butyl ether	1000 (454)
Methylthiouracil	10 (4.54)
Metolcarb	1000 (454)
Mevinphos	10 (4.54)
Mexacarbate	1000 (454)
Mitomycin C	10 (4.54)
MNNG	10 (4.54)
Monoethylamine	100 (45.4)
Monomethylamine	100 (45.4)
Naled	10 (4.54)
5,12-Naphthacenedione, 8-acetyl-10-[(3-amino-2,3,6-trideoxy-alpha-L-lyxo-hexopyranosyl)oxy]-7,8,9,10-tetrahydro-6,8,11-trihydroxy-1-methoxy-, (8S-cis)-	10 (4.54)
1-Naphthalenamine	100 (45.4)
2-Naphthalenamine	10 (4.54)
Naphthalenamine, N,N'-bis(2-chloroethyl)-	100 (45.4)
Naphthalene	100 (45.4)
Naphthalene, 2-chloro-	5000 (2270)
1,4-Naphthalenedione	5000 (2270)
2,7-Naphthalenedisulfonic acid, 3,3'-[(3,3'-dimethyl-(1,1'-biphenyl)-4,4'-diyl)-bis(azo)]bis(5-amino-4-hydroxy)-tetrasodium salt	10 (4.54)
1-Naphthalenol, methylcarbamate	100 (45.4)
Naphthenic acid	100 (45.4)
1,4-Naphthoquinone	5000 (2270)
alpha-Naphthylamine	100 (45.4)
beta-Naphthylamine	10 (4.54)
alpha-Naphthylthiourea	100 (45.4)
Nickel	100 (45.4)
Nickel ammonium sulfate	100 (45.4)
Nickel carbonyl Ni(CO) ₄ , (T-4)-	10 (4.54)
Nickel chloride	100 (45.4)
Nickel cyanide Ni(CN) ₂	10 (4.54)
Nickel hydroxide	10 (4.54)
Nickel nitrate	100 (45.4)
Nickel sulfate	100 (45.4)
Nicotine, & salts	100 (45.4)
Nitric acid	1000 (454)
Nitric acid, thallium (1 +) salt	100 (45.4)

TABLE 1 TO APPENDIX A—HAZARDOUS SUBSTANCES OTHER THAN RADIONUCLIDES—Continued

Hazardous substance	Reportable quantity (RQ) pounds (kilograms)
Nitric oxide	10 (4.54)
p-Nitroaniline	5000 (2270)
Nitrobenzene	1000 (454)
4-Nitrobiphenyl	10 (4.54)
Nitrogen dioxide	10 (4.54)
Nitrogen oxide NO	10 (4.54)
Nitrogen oxide NO ₂	10 (4.54)
Nitroglycerine	10 (4.54)
Nitrophenol (mixed)	100 (45.4)
m-Nitrophenol.	
o-Nitrophenol	100 (45.4)
p-Nitrophenol	100 (45.4)
2-Nitrophenol	100 (45.4)
4-Nitrophenol	100 (45.4)
2-Nitropropane	10 (4.54)
N-Nitrosodi-n-butylamine	10 (4.54)
N-Nitrosodiethanolamine	1 (0.454)
N-Nitrosodiethylamine	1 (0.454)
N-Nitrosodimethylamine	10 (4.54)
N-Nitrosodiphenylamine	100 (45.4)
N-Nitroso-N-ethylurea	1 (0.454)
N-Nitroso-N-methylurea	1 (0.454)
N-Nitroso-N-methylurethane	1 (0.454)
N-Nitrosomethylvinylamine	10 (4.54)
N-Nitrosomorpholine	1 (0.454)
N-Nitrosopiperidine	10 (4.54)
N-Nitrosopyrrolidine	1 (0.454)
Nitrotoluene	1000 (454)
m-Nitrotoluene.	
o-Nitrotoluene.	
p-Nitrotoluene.	
5-Nitro-o-toluidine	100 (45.4)
Octamethylpyrophosphoramidate	100 (45.4)
Osmium oxide OsO ₄ , (T-4)	1000 (454)
Osmium tetroxide	1000 (454)
7-Oxabicyclo[2.2.1]heptane-2,3-dicarboxylic acid	1000 (454)
Oxamyl	100 (45.4)
1,2-Oxathiolane, 2,2-dioxide	10 (4.54)
2H-1,3,2-Oxazaphosphorin-2-amine, N,N-bis(2-chloroethyl) tetrahydro-, 2-oxide	10 (4.54)
Oxirane	10 (4.54)
Oxiranecarboxyaldehyde	10 (4.54)
Oxirane, (chloromethyl)-	100 (45.4)
Paraformaldehyde	1000 (454)
Paraldehyde	1000 (454)
Parathion	10 (4.54)
PCBs	1 (0.454)
PCNB	100 (45.4)
Pentachlorobenzene	10 (4.54)
Pentachloroethane	10 (4.54)
Pentachloronitrobenzene	100 (45.4)
Pentachlorophenol	10 (4.54)
1,3-Pentadiene	100 (45.4)
Perchloroethylene	100 (45.4)
Perchloromethyl mercaptan®	100 (45.4)
Phenacetin	100 (45.4)
Phenanthrene	5000 (2270)
Phenol	1000 (454)
Phenol, 2-chloro-	100 (45.4)
Phenol, 4-chloro-3-methyl-	5000 (2270)
Phenol, 2-cyclohexyl-4,6-dinitro-	100 (45.4)
Phenol, 2,4-dichloro-	100 (45.4)
Phenol, 2,6-dichloro-	100 (45.4)
Phenol, 4,4'-(1,2-diethyl-1,2-ethenediyl)bis-, (E)	1 (0.454)
Phenol, 2,4-dimethyl-	100 (45.4)
Phenol, 4-(dimethylamino)-3,5-dimethyl-, methylcarbamate (ester)	1000 (454)
Phenol, (3,5-dimethyl-4-(methylthio)-, methylcarbamate	10 (4.54)
Phenol, 2,4-dinitro-	10 (4.54)
Phenol, methyl-	100 (45.4)
Phenol, 2-methyl-4,6-dinitro-, & salts	10 (4.54)
Phenol, 2,2'-methylenebis[3,4,6-trichloro-	100 (45.4)

TABLE 1 TO APPENDIX A—HAZARDOUS SUBSTANCES OTHER THAN RADIONUCLIDES—Continued

Hazardous substance	Reportable quantity (RQ) pounds (kilograms)
Phenol, 2-(1-methylethoxy)-, methylcarbamate	100 (45.4)
Phenol, 3-(1-methylethyl)-, methyl carbamate	10 (4.54)
Phenol, 3-methyl-5-(1-methylethyl)-, methyl carbamate	1000 (454)
Phenol, 2-(1-methylpropyl)-4,6-dinitro-	1000 (454)
Phenol, 4-nitro-	100 (45.4)
Phenol, pentachloro-	10 (4.54)
Phenol, 2,3,4,6-tetrachloro-	10 (4.54)
Phenol, 2,4,5-trichloro-	10 (4.54)
Phenol, 2,4,6-trichloro-	10 (4.54)
Phenol, 2,4,6-trinitro-, ammonium salt	10 (4.54)
L-Phenylalanine, 4-[bis(2-chloroethyl)amino]-	1 (0.454)
p-Phenylenediamine	5000 (2270)
Phenyl mercaptan [®]	100 (45.4)
Phenylmercury acetate	100 (45.4)
Phenylthiourea	100 (45.4)
Phorate	10 (4.54)
Phosgene	10 (4.54)
Phosphine	100 (45.4)
Phosphoric acid	5000 (2270)
Phosphoric acid, diethyl 4-nitrophenyl ester	100 (45.4)
Phosphoric acid, lead(2 +) salt (2:3)	10 (4.54)
Phosphorodithioic acid, O,O-diethyl S-[2-(ethylthio)ethyl] ester	1 (0.454)
Phosphorodithioic acid, O,O-diethyl S-[ethylthio)methyl] ester	10 (4.54)
Phosphorodithioic acid, O,O-diethyl S-methyl ester	5000 (2270)
Phosphorodithioic acid, O,O-dimethyl S-[2-(methylamino)-2-oxoethyl] ester	10 (4.54)
Phosphorofluoric acid, bis(1-methylethyl) ester	100 (45.4)
Phosphorothioic acid, O,O-diethyl O-(4-nitrophenyl) ester	10 (4.54)
Phosphorothioic acid, O,O-diethyl O-pyrazinyl ester	100 (45.4)
Phosphorothioic acid, O-[4-[(dimethylamino) sulfonyl]phenyl] O,O-dimethyl ester	1000 (454)
Phosphorothioic acid, O,O-dimethyl O-(4-nitrophenyl) ester	100 (45.4)
Phosphorus	1 (0.454)
Phosphorus oxychloride	1000 (454)
Phosphorus pentasulfide	100 (45.4)
Phosphorus sulfide	100 (45.4)
Phosphorus trichloride	1000 (454)
Phthalic anhydride	5000 (2270)
Physostigmine	100 (45.4)
Physostigmine salicylate	100 (45.4)
2-Picoline	5000 (2270)
Piperidine, 1-nitroso-	10 (4.54)
Plumbane, tetraethyl-	10 (4.54)
POLYCHLORINATED BIPHENYLS	1 (0.454)
Potassium arsenate	1 (0.454)
Potassium arsenite	1 (0.454)
Potassium bichromate	10 (4.54)
Potassium chromate	10 (4.54)
Potassium cyanide K(CN)	10 (4.54)
Potassium hydroxide	1000 (454)
Potassium permanganate	100 (45.4)
Potassium silver cyanide	1 (0.454)
Promecarb	1000 (454)
Pronamide	5000 (2270)
Propanal, 2-methyl-2-(methyl-sulfonyl)-, O-[(methylamino)carbonyl] oxime	100 (45.4)
Propanal, 2-methyl-2-(methylthio)-, O-[(methylamino)carbonyl] oxime	1 (0.454)
1-Propanamine	5000 (2270)
1-Propanamine, N-propyl-	5000 (2270)
1-Propanamine, N-nitroso-N-propyl-	10 (4.54)
Propane, 1,2-dibromo-3-chloro-	1 (0.454)
Propane, 1,2-dichloro-	1000 (454)
Propanedinitrile	1000 (454)
Propanenitrile	10 (4.54)
Propanenitrile, 3-chloro-	1000 (454)
Propanenitrile, 2-hydroxy-2-methyl-	10 (4.54)
Propane, 2-nitro-	10 (4.54)
Propane, 2,2'-oxybis[2-chloro-	1000 (454)
1,3-Propane sultone	10 (4.54)
1,2,3-Propanetriol, trinitrate	10 (4.54)
Propanoic acid, 2-(2,4,5-trichlorophenoxy)-	100 (45.4)
1-Propanol, 2,3-dibromo-, phosphate (3:1)	10 (4.54)
1-Propanol, 2-methyl-	5000 (2270)

TABLE 1 TO APPENDIX A—HAZARDOUS SUBSTANCES OTHER THAN RADIONUCLIDES—Continued

Hazardous substance	Reportable quantity (RQ) pounds (kilograms)
2-Propanone	5000 (2270)
2-Propanone, 1-bromo-	1000 (454)
Propargite	10 (4.54)
Propargyl alcohol	1000 (454)
2-Propenal	1 (0.454)
2-Propenamide	5000 (2270)
1-Propene, 1,3-dichloro-	100 (45.4)
1-Propene, 1,1,2,3,3,3-hexachloro-	1000 (454)
2-Propenenitrile	100 (45.4)
2-Propenenitrile, 2-methyl-	1000 (454)
2-Propenoic acid	5000 (2270)
2-Propenoic acid, ethyl ester	1000 (454)
2-Propenoic acid, 2-methyl-, ethyl ester	1000 (454)
2-Propenoic acid, 2-methyl-, methyl ester	1000 (454)
2-Propen-1-ol	100 (45.4)
Propham	1000 (454)
beta-Propiolactone	10 (4.54)
Propionaldehyde	1000 (454)
Propionic acid	5000 (2270)
Propionic anhydride	5000 (2270)
Propoxur (Baygon)	100 (45.4)
n-Propylamine	5000 (2270)
Propylene dichloride	1000 (454)
Propylene oxide	100 (45.4)
1,2-Propylenimine	1 (0.454)
2-Propyn-1-ol	1000 (454)
Prosulfocarb	5000 (2270)
Pyrene	5000 (2270)
Pyrethrins	1 (0.454)
3,6-Pyridazinedione, 1,2-dihydro-	5000 (2270)
4-Pyridinamine	1000 (454)
Pyridine	1000 (454)
Pyridine, 2-methyl-	5000 (2270)
Pyridine, 3-(1-methyl-2-pyrrolidinyl)-, (S)-, & salts	100 (45.4)
2,4-(1H,3H)-Pyrimidinedione, 5-[bis(2-chloroethyl)amino]-	10 (4.54)
4(1H)-Pyrimidinone, 2,3-dihydro-6-methyl-2-thioxo-	10 (4.54)
Pyrrolidine, 1-nitroso-	1 (0.454)
Pyrrolo[2,3-b] indol-5-ol,1,2,3,3a,8,8a-hexahydro-1,3a,8-trimethyl-, methylcarbamate (ester), (3aS-cis)-	100 (45.4)
Quinoline	5000 (2270)
Quinone	10 (4.54)
Quintobenzene	100 (45.4)
RADIONUCLIDES	See Table 2
Reserpine	5000 (2270)
Resorcinol	5000 (2270)
Safrole	100 (45.4)
Selenious acid	10 (4.54)
Selenious acid, dithallium (1 +) salt	1000 (454)
Selenium e	100 (45.4)
Selenium dioxide	10 (4.54)
Selenium oxide	10 (4.54)
Selenium sulfide SeS2	10 (4.54)
Selenourea	1000 (454)
L-Serine, diazoacetate (ester)	1 (0.454)
Silver e	1000 (454)
Silver cyanide Ag(CN)	1 (0.454)
Silver nitrate	1 (0.454)
Silvex (2,4,5-TP)	100 (45.4)
Sodium	10 (4.54)
Sodium arsenate	1 (0.454)
Sodium arsenite	1 (0.454)
Sodium azide	1000 (454)
Sodium bichromate	10 (4.54)
Sodium bifluoride	100 (45.4)
Sodium bisulfite	5000 (2270)
Sodium chromate	10 (4.54)
Sodium cyanide Na(CN)	10 (4.54)
Sodium dodecylbenzenesulfonate	1000 (454)
Sodium fluoride	1000 (454)
Sodium hydrosulfide	5000 (2270)
Sodium hydroxide	1000 (454)

TABLE 1 TO APPENDIX A—HAZARDOUS SUBSTANCES OTHER THAN RADIONUCLIDES—Continued

Hazardous substance	Reportable quantity (RQ) pounds (kilograms)
Sodium hypochlorite	100 (45.4)
Sodium methylate	1000 (454)
Sodium nitrite	100 (45.4)
Sodium phosphate, dibasic	5000 (2270)
Sodium phosphate, tribasic	5000 (2270)
Sodium selenite	100 (45.4)
Streptozotocin	1 (0.454)
Strontium chromate	10 (4.54)
Strychnidin-10-one, & salts	10 (4.54)
Strychnidin-10-one, 2,3-dimethoxy-	100 (45.4)
Strychnine, & salts	10 (4.54)
Styrene	1000 (454)
Styrene oxide	100 (45.4)
Sulfur chlorides®	1000 (454)
Sulfuric acid	1000 (454)
Sulfuric acid, dimethyl ester	100 (45.4)
Sulfuric acid, dithallium (1 +) salt	100 (45.4)
Sulfur monochloride	1000 (454)
Sulfur phosphide	100 (45.4)
2,4,5-T	1000 (454)
2,4,5-T acid	1000 (454)
2,4,5-T amines	5000 (2270)
2,4,5-T esters	1000 (454)
2,4,5-T salts	1000 (454)
TCDD	1 (0.454)
TDE	1 (0.454)
1,2,4,5-Tetrachlorobenzene	5000 (2270)
2,3,7,8-Tetrachlorodibenzo-p-dioxin	1 (0.454)
1,1,1,2-Tetrachloroethane	100 (45.4)
1,1,2,2-Tetrachloroethane	100 (45.4)
Tetrachloroethylene	100 (45.4)
2,3,4,6-Tetrachlorophenol	10 (4.54)
Tetraethyl pyrophosphate	10 (4.54)
Tetraethyl lead	10 (4.54)
Tetraethyldithiopyrophosphate	100 (45.4)
Tetrahydrofuran	1000 (454)
Tetranitromethane	10 (4.54)
Tetraphosphoric acid, hexaethyl ester	100 (45.4)
Thallic oxide	100 (45.4)
Thallium e	1000 (454)
Thallium (I) acetate	100 (45.4)
Thallium (I) carbonate	100 (45.4)
Thallium chloride TlCl	100 (45.4)
Thallium (I) nitrate	100 (45.4)
Thallium oxide Tl ₂ O ₃	100 (45.4)
Thallium (I) selenite	1000 (454)
Thallium (I) sulfate	100 (45.4)
Thioacetamide	10 (4.54)
Thiodicarb	100 (45.4)
Thiodiphosphoric acid, tetraethyl ester	100 (45.4)
Thiofanox	100 (45.4)
Thioimidodicarbonic diamide [(H ₂ N)C(S)] ₂ NH	100 (45.4)
Thiomethanol	100 (45.4)
Thioperoxydicarbonic diamide [(H ₂ N)C(S)] ₂ S ₂ , tetramethyl-	10 (4.54)
Thiophanate-methyl	10 (4.54)
Thiophenol	100 (45.4)
Thiosemicarbazide	100 (45.4)
Thiourea	10 (4.54)
Thiourea, (2-chlorophenyl)-	100 (45.4)
Thiourea, 1-naphthalenyl-	100 (45.4)
Thiourea, phenyl-	100 (45.4)
Thiram	10 (4.54)
Tirpate	100 (45.4)
Titanium tetrachloride	1000 (454)
Toluene	1000 (454)
Toluenediamine	10 (4.54)
2,4-Toluene diamine	10 (4.54)
Toluene diisocyanate	100 (45.4)
2,4-Toluene diisocyanate	100 (45.4)
o-Toluidine	100 (45.4)

TABLE 1 TO APPENDIX A—HAZARDOUS SUBSTANCES OTHER THAN RADIONUCLIDES—Continued

Hazardous substance	Reportable quantity (RQ) pounds (kilograms)
p-Toluidine	100 (45.4)
o-Toluidine hydrochloride	100 (45.4)
Toxaphene	1 (0.454)
2,4,5-TP acid	100 (45.4)
2,4,5-TP esters	100 (45.4)
Triallate	100 (45.4)
1H-1,2,4-Triazol-3-amine	10 (4.54)
Trichlorfon	100 (45.4)
1,2,4-Trichlorobenzene	100 (45.4)
1,1,1-Trichloroethane	1000 (454)
1,1,2-Trichloroethane	100 (45.4)
Trichloroethylene	100 (45.4)
Trichloromethanesulfonyl chloride	100 (45.4)
Trichloromonofluoromethane	5000 (2270)
Trichlorophenol	10 (4.54)
2,3,4-Trichlorophenol	
2,3,5-Trichlorophenol	
2,3,6-Trichlorophenol	
3,4,5-Trichlorophenol	
2,4,5-Trichlorophenol	10 (4.54)
2,4,6-Trichlorophenol	10 (4.54)
Triethanolamine dodecylbenzenesulfonate	1000 (454)
Triethylamine	5000 (2270)
Trifluralin	10 (4.54)
Trimethylamine	100 (45.4)
2,2,4-Trimethylpentane	1000 (454)
1,3,5-Trinitrobenzene	10 (4.54)
1,3,5-Trioxane, 2,4,6-trimethyl-	1000 (454)
Tris(2,3-dibromopropyl) phosphate	10 (4.54)
Trypan blue	10 (4.54)
D002 Unlisted Hazardous Wastes Characteristic of Corrosivity	100 (45.4)
D001 Unlisted Hazardous Wastes Characteristic of Ignitability	100 (45.4)
D003 Unlisted Hazardous Wastes Characteristic of Reactivity	100 (45.4)
D004–D043 Unlisted Hazardous Wastes Characteristic of Toxicity:	
Arsenic (D004)	1 (0.454)
Barium (D005)	1000 (454)
Benzene (D018)	10 (4.54)
Cadmium (D006)	10 (4.54)
Carbon tetrachloride (D019)	10 (4.54)
Chlordane (D020)	1 (0.454)
Chlorobenzene (D021)	100 (45.4)
Chloroform (D022)	10 (4.54)
Chromium (D007)	10 (4.54)
o-Cresol (D023)	100 (45.4)
m-Cresol (D024)	100 (45.4)
p-Cresol (D025)	100 (45.4)
Cresol (D026)	100 (45.4)
2,4-D (D016)	100 (45.4)
1,4-Dichlorobenzene (D027)	100 (45.4)
1,2-Dichloroethane (D028)	100 (45.4)
1,1-Dichloroethylene (D029)	100 (45.4)
2,4-Dinitrotoluene (D030)	10 (4.54)
Endrin (D012)	1 (0.454)
Heptachlor (and epoxide) (D031)	1 (0.454)
Hexachlorobenzene (D032)	10 (4.54)
Hexachlorobutadiene (D033)	1 (0.454)
Hexachloroethane (D034)	100 (45.4)
Lead (D008)	10 (4.54)
Lindane (D013)	1 (0.454)
Mercury (D009)	1 (0.454)
Methoxychlor (D014)	1 (0.454)
Methyl ethyl ketone (D035)	5000 (2270)
Nitrobenzene (D036)	1000 (454)
Pentachlorophenol (D037)	10 (4.54)
Pyridine (D038)	1000 (454)
Selenium (D010)	10 (4.54)
Silver (D011)	1 (0.454)
Tetrachloroethylene (D039)	100 (45.4)
Toxaphene (D015)	1 (0.454)
Trichloroethylene (D040)	100 (45.4)

TABLE 1 TO APPENDIX A—HAZARDOUS SUBSTANCES OTHER THAN RADIONUCLIDES—Continued

Hazardous substance	Reportable quantity (RQ) pounds (kilograms)
2,4,5-Trichlorophenol (D041)	10 (4.54)
2,4,6-Trichlorophenol (D042)	10 (4.54)
2,4,5-TP (D017)	100 (45.4)
Vinyl chloride (D043)	1 (0.454)
Uracyl mustard	10 (4.54)
Uranyl acetate	100 (45.4)
Uranyl nitrate	100 (45.4)
Urea, N-ethyl-N-nitroso-	1 (0.454)
Urea, N-methyl-N-nitroso-	1 (0.454)
Urethane	100 (45.4)
Vanadic acid, ammonium salt	1000 (454)
Vanadium oxide V ₂ O ₅	1000 (454)
Vanadium pentoxide	1000 (454)
Vanadyl sulfate	1000 (454)
Vinyl acetate	5000 (2270)
Vinyl acetate monomer	5000 (2270)
Vinylamine, N-methyl-N-nitroso-	10 (4.54)
Vinyl bromide	100 (45.4)
Vinyl chloride	1 (0.454)
Vinylidene chloride	100 (45.4)
Warfarin, & salts	100 (45.4)
Xylene	100 (45.4)
m-Xylene	1000 (454)
o-Xylene	1000 (454)
p-Xylene	100 (45.4)
Xylene (mixed)	100 (45.4)
Xylenes (isomers and mixture)	100 (45.4)
Xylenol	1000 (454)
Yohimban-16-carboxylic acid, 11,17-dimethoxy-18-[(3,4,5-trimethoxybenzoyl) oxy]-, methyl ester (3beta,16beta,17alpha,18beta, 20alpha)	5000 (2270)
Zinc ϵ	1000 (454)
Zinc acetate	1000 (454)
Zinc ammonium chloride	1000 (454)
Zinc, bis(dimethylcarbamo-dithioato-S,S')-	10 (4.54)
Zinc borate	1000 (454)
Zinc bromide	1000 (454)
Zinc carbonate	1000 (454)
Zinc chloride	1000 (454)
Zinc cyanide Zn(CN) ₂	10 (4.54)
Zinc fluoride	1000 (454)
Zinc formate	1000 (454)
Zinc hydrosulfite	1000 (454)
Zinc nitrate	1000 (454)
Zinc phenolsulfonate	5000 (2270)
Zinc phosphide Zn ₃ P ₂	100 (45.4)
Zinc silicofluoride	5000 (2270)
Zinc sulfate	1000 (454)
Ziram	10 (4.54)
Zirconium nitrate	5000 (2270)
Zirconium potassium fluoride	1000 (454)
Zirconium sulfate	5000 (2270)
Zirconium tetrachloride	5000 (2270)
F001	10 (4.54)
(a) Tetrachloroethylene	100 (45.4)
(b) Trichloroethylene	100 (45.4)
(c) Methylene chloride	1000 (454)
(d) 1,1,1-Trichloroethane	1000 (454)
(e) Carbon tetrachloride	10 (4.54)
(f) Chlorinated fluorocarbons	5000 (2270)
F002	10 (4.54)
(a) Tetrachloroethylene	100 (45.4)
(b) Methylene chloride	1000 (454)
(c) Trichloroethylene	100 (45.4)
(d) 1,1,1-Trichloroethane	1000 (454)
(e) Chlorobenzene	100 (45.4)
(f) 1,1,2-Trichloro-1,2,2-trifluoroethane	5000 (2270)
(g) o-Dichlorobenzene	100 (45.4)
(h) Trichlorofluoromethane	5000 (2270)
(i) 1,1,2-Trichloroethane	100 (45.4)
F003	100 (45.4)

TABLE 1 TO APPENDIX A—HAZARDOUS SUBSTANCES OTHER THAN RADIONUCLIDES—Continued

Hazardous substance	Reportable quantity (RQ) pounds (kilograms)
(a) Xylene	1000 (454)
(b) Acetone	5000 (2270)
(c) Ethyl acetate	5000 (2270)
(d) Ethylbenzene	1000 (454)
(e) Ethyl ether	100 (45.4)
(f) Methyl isobutyl ketone	5000 (2270)
(g) n-Butyl alcohol	5000 (2270)
(h) Cyclohexanone	5000 (2270)
(i) Methanol	5000 (2270)
F004	100 (45.4)
(a) Cresols/Cresylic acid	100 (45.4)
(b) Nitrobenzene	1000 (454)
F005	100 (45.4)
(a) Toluene	1000 (454)
(b) Methyl ethyl ketone	5000 (2270)
(c) Carbon disulfide	100 (45.4)
(d) Isobutanol	5000 (2270)
(e) Pyridine	1000 (454)
F006	10 (4.54)
F007	10 (4.54)
F008	10 (4.54)
F009	10 (4.54)
F010	10 (4.54)
F011	10 (4.54)
F012	10 (4.54)
F019	10 (4.54)
F020	1 (0.454)
F021	1 (0.454)
F022	1 (0.454)
F023	1 (0.454)
F024	1 (0.454)
F025	1 (0.454)
F026	1 (0.454)
F027	1 (0.454)
F028	1 (0.454)
F032	1 (0.454)
F034	1 (0.454)
F035	1 (0.454)
F037	1 (0.454)
F038	1 (0.454)
F039	1 (0.454)
K001	1 (0.454)
K002	10 (4.54)
K003	10 (4.54)
K004	10 (4.54)
K005	10 (4.54)
K006	10 (4.54)
K007	10 (4.54)
K008	10 (4.54)
K009	10 (4.54)
K010	10 (4.54)
K011	10 (4.54)
K013	10 (4.54)
K014	5000 (2270)
K015	10 (4.54)
K016	1 (0.454)
K017	10 (4.54)
K018	1 (0.454)
K019	1 (0.454)
K020	1 (0.454)
K021	10 (4.54)
K022	1 (0.454)
K023	5000 (2270)
K024	5000 (2270)
K025	10 (4.54)
K026	1000 (454)
K027	10 (4.54)
K028	1 (0.454)
K029	1 (0.454)
K030	1 (0.454)

TABLE 1 TO APPENDIX A—HAZARDOUS SUBSTANCES OTHER THAN RADIONUCLIDES—Continued

Hazardous substance	Reportable quantity (RQ) pounds (kilograms)
K031	1 (0.454)
K032	10 (4.54)
K033	10 (4.54)
K034	10 (4.54)
K035	1 (0.454)
K036	1 (0.454)
K037	1 (0.454)
K038	10 (4.54)
K039	10 (4.54)
K040	10 (4.54)
K041	1 (0.454)
K042	10 (4.54)
K043	10 (4.54)
K044	10 (4.54)
K045	10 (4.54)
K046	10 (4.54)
K047	10 (4.54)
K048	10 (4.54)
K049	10 (4.54)
K050	10 (4.54)
K051	10 (4.54)
K052	10 (4.54)
K060	1 (0.454)
K061	10 (4.54)
K062	10 (4.54)
K064	10 (4.54)
K065	10 (4.54)
K066	10 (4.54)
K069	10 (4.54)
K071	1 (0.454)
K073	10 (4.54)
K083	100 (45.4)
K084	1 (0.454)
K085	10 (4.54)
K086	10 (4.54)
K087	100 (45.4)
K088	10 (4.54)
K090	10 (4.54)
K091	10 (4.54)
K093	5000 (2270)
K094	5000 (2270)
K095	100 (45.4)
K096	100 (45.4)
K097	1 (0.454)
K098	1 (0.454)
K099	10 (4.54)
K100	10 (4.54)
K101	1 (0.454)
K102	1 (0.454)
K103	100 (45.4)
K104	10 (4.54)
K105	10 (4.54)
K106	1 (0.454)
K107	10 (4.54)
K108	10 (4.54)
K109	10 (4.54)
K110	10 (4.54)
K111	10 (4.54)
K112	10 (4.54)
K113	10 (4.54)
K114	10 (4.54)
K115	10 (4.54)
K116	10 (4.54)
K117	1 (0.454)
K118	1 (0.454)
K123	10 (4.54)
K124	10 (4.54)
K125	10 (4.54)
K126	10 (4.54)
K131	100 (45.4)

TABLE 1 TO APPENDIX A—HAZARDOUS SUBSTANCES OTHER THAN RADIONUCLIDES—Continued

Hazardous substance	Reportable quantity (RQ) pounds (kilograms)
K132	1000 (454)
K136	1 (0.454)
K141	1 (0.454)
K142	1 (0.454)
K143	1 (0.454)
K144	1 (0.454)
K145	1 (0.454)
K147	1 (0.454)
K148	1 (0.454)
K149	10 (4.54)
K150	10 (4.54)
K151	10 (4.54)
K156	10 (4.54)
K157	10 (4.54)
K158	10 (4.54)
K159	10 (4.54)
K161	1 (0.454)
K169	10 (4.54)
K170	1 (0.454)
K171	1 (0.454)
K172	1 (0.454)
K174	1 (0.454)
K175	1 (0.454)
K176	1 (0.454)
K177	5000 (2270)
K178	1000 (454)
K181	1 (0.454)

ε The RQ for these hazardous substances is limited to those pieces of the metal having a diameter smaller than 100 micrometers (0.004 inches).

ζ The RQ for asbestos is limited to friable forms only.

⊗ Indicates that the name was added by PHMSA because (1) the name is a synonym for a specific hazardous substance and (2) the name appears in the Hazardous Materials Table as a proper shipping name.

* To provide consistency with EPA regulations, two entries with different CAS numbers are provided. Refer to the EPA Table 302.4—List of Hazardous Substances and Reportable Quantities for an explanation of the two entries.

LIST OF HAZARDOUS SUBSTANCES AND REPORTABLE QUANTITIES

TABLE 2 TO APPENDIX A—RADIONUCLIDES

(1)—Radionuclide	(2)—Atomic Number	(3)—Reportable Quantity (RQ) Ci (TBq)
Actinium-224	89	100 (3.7)
Actinium-225	89	1 (.037)
Actinium-226	89	10 (.37)
Actinium-227	89	0.001 (.00037)
Actinium-228	89	10 (.37)
Aluminum-26	13	10 (.37)
Americium-237	95	1000 (37)
Americium-238	95	100 (3.7)
Americium-239	95	100 (3.7)
Americium-240	95	10 (.37)
Americium-241	95	0.01 (.00037)
Americium-242	95	100 (3.7)
Americium-242m	95	0.01 (.00037)
Americium-243	95	0.01 (.00037)
Americium-244	95	10 (.37)
Americium-244m	95	1000 (37)
Americium-245	95	1000 (37)
Americium-246	95	1000 (37)
Americium-246m	95	1000 (37)
Antimony-115	51	1000 (37)
Antimony-116	51	1000 (3.7)
Antimony-116m	51	100 (3.7)
Antimony-117	51	1000 (37)

TABLE 2 TO APPENDIX A—RADIONUCLIDES—Continued

(1)—Radionuclide	(2)—Atomic Number	(3)—Reportable Quantity (RQ) Ci (TBq)
Antimony-118m	51	10 (.37)
Antimony-119	51	1000 (37)
Antimony-120 (16 min)	51	1000 (37)
Antimony-120 (5.76 day)	51	10 (.37)
Antimony-122	51	10 (.37)
Antimony-124	51	10 (.37)
Antimony-124m	51	1000 (37)
Antimony-125	51	10 (.37)
Antimony-126	51	10 (.37)
Antimony-126m	51	1000 (37)
Antimony-127	51	10 (.37)
Antimony-128 (10.4 min)	51	1000 (37)
Antimony-128 (9.01 hr)	51	10 (.37)
Antimony-129	51	100 (3.7)
Antimony-130	51	100 (3.7)
Antimony-131	51	1000 (37)
Argon-39	18	1000 (37)
Argon-41	18	10 (.37)
Arsenic-69	33	1000 (37)
Arsenic-70	33	100 (3.7)
Arsenic-71	33	100 (3.7)
Arsenic-72	33	10 (.37)
Arsenic-73	33	100 (3.7)
Arsenic-74	33	10 (.37)
Arsenic-76	33	100 (3.7)

TABLE 2 TO APPENDIX A—RADIONUCLIDES—
Continued

(1)—Radionuclide	(2)—Atomic Number	(3)—Reportable Quantity (RQ) Ci (TBq)
Arsenic-77	33	1000 (37)
Arsenic-78	33	100 (3.7)
Astatine-207	85	100 (3.7)
Astatine-211	85	100 (3.7)
Barium-126	56	1000 (37)
Barium-128	56	10 (.37)
Barium-131	56	10 (.37)
Barium-131m	56	1000 (37)
Barium-133	56	10 (.37)
Barium-133m	56	100 (3.7)
Barium-135m	56	1000 (37)
Barium-139	56	1000 (37)
Barium-140	56	10 (.37)
Barium-141	56	1000 (37)
Barium-142	56	1000 (37)
Berkelium-245	97	100 (3.7)
Berkelium-246	97	10 (.37)
Berkelium-247	97	0.01 (.00037)
Berkelium-249	97	1 (.037)
Berkelium-250	97	100 (3.7)
Beryllium-10	4	1 (.037)
Beryllium-7	4	100 (3.7)
Bismuth-200	83	100 (3.7)
Bismuth-201	83	100 (3.7)
Bismuth-202	83	1000 (37)
Bismuth-203	83	10 (.37)
Bismuth-205	83	10 (.37)
Bismuth-206	83	10 (.37)
Bismuth-207	83	10 (.37)
Bismuth-210	83	10 (.37)
Bismuth-210m	83	0.1 (.0037)
Bismuth-212	83	100 (3.7)
Bismuth-213	83	100 (3.7)
Bismuth-214	83	100 (3.7)
Bromine-74	35	100 (3.7)
Bromine-74m	35	100 (3.7)
Bromine-75	35	100 (3.7)
Bromine-76	35	10 (.37)
Bromine-77	35	100 (3.7)
Bromine-80	35	1000 (37)
Bromine-80m	35	1000 (37)
Bromine-82	35	10 (.37)
Bromine-83	35	1000 (37)
Bromine-84	35	100 (3.7)
Cadmium-104	48	1000 (37)
Cadmium-107	48	1000 (37)
Cadmium-109	48	1 (.037)
Cadmium-113	48	0.1 (.0037)
Cadmium-113m	48	0.1 (.0037)
Cadmium-115	48	100 (3.7)
Cadmium-115m	48	10 (.37)
Cadmium-117	48	100 (3.7)
Cadmium-117m	48	10 (.37)
Calcium-41	20	10 (.37)
Calcium-45	20	10 (.37)
Calcium-47	20	10 (.37)
Californium-244	98	1000 (37)
Californium-246	98	10 (.37)
Californium-248	98	0.1 (.0037)
Californium-249	98	0.01 (.00037)
Californium-250	98	0.01 (.00037)
Californium-251	98	0.01 (.00037)
Californium-252	98	0.1 (.0037)
Californium-253	98	10 (.37)
Californium-254	98	0.1 (.0037)
Carbon-11	6	1000 (37)
Carbon-14	6	10 (.37)
Cerium-134	58	10 (.37)

TABLE 2 TO APPENDIX A—RADIONUCLIDES—
Continued

(1)—Radionuclide	(2)—Atomic Number	(3)—Reportable Quantity (RQ) Ci (TBq)
Cerium-135	58	10 (.37)
Cerium-137	58	1000 (37)
Cerium-137m	58	100 (3.7)
Cerium-139	58	100 (3.7)
Cerium-141	58	10 (.37)
Cerium-143	58	100 (3.7)
Cerium-144	58	1 (.037)
Cesium-125	55	1000 (37)
Cesium-127	55	100 (3.7)
Cesium-129	55	100 (3.7)
Cesium-130	55	1000 (37)
Cesium-131	55	1000 (37)
Cesium-132	55	10 (.37)
Cesium-134	55	1 (.037)
Cesium-134m	55	1000 (37)
Cesium-135	55	10 (.37)
Cesium-135m	55	100 (3.7)
Cesium-136	55	10 (.37)
Cesium-137	55	1 (.037)
Cesium-138	55	100 (3.7)
Chlorine-36	17	10 (.37)
Chlorine-38	17	100 (3.7)
Chlorine-39	17	100 (3.7)
Chromium-48	24	100 (3.7)
Chromium-49	24	1000 (37)
Chromium-51	24	1000 (37)
Cobalt-55	27	10 (.37)
Cobalt-56	27	10 (.37)
Cobalt-57	27	100 (3.7)
Cobalt-58	27	10 (.37)
Cobalt-58m	27	1000 (37)
Cobalt-60	27	10 (.37)
Cobalt-60m	27	1000 (37)
Cobalt-61	27	1000 (37)
Cobalt-62m	27	1000 (37)
Copper-60	29	100 (3.7)
Copper-61	29	100 (3.7)
Copper-64	29	1000 (37)
Copper-67	29	100 (3.7)
Curium-238	96	1000 (37)
Curium-240	96	1 (.037)
Curium-241	96	10 (.37)
Curium-242	96	1 (.037)
Curium-243	96	0.01 (.00037)
Curium-244	96	0.01 (.00037)
Curium-245	96	0.01 (.00037)
Curium-246	96	0.01 (.00037)
Curium-247	96	0.01 (.00037)
Curium-248	96	0.001 (.000037)
Curium-249	96	1000 (37)
Dysprosium-155	66	100 (3.7)
Dysprosium-157	66	100 (3.7)
Dysprosium-159	66	100 (3.7)
Dysprosium-165	66	1000 (37)
Dysprosium-166	66	10 (.37)
Einsteinium-250	99	10 (.37)
Einsteinium-251	99	1000 (37)
Einsteinium-253	99	10 (.37)
Einsteinium-254	99	0.1 (.0037)
Einsteinium-254m	99	1 (.037)
Erbium-161	68	100 (3.7)
Erbium-165	68	1000 (37)
Erbium-169	68	100 (3.7)
Erbium-171	68	100 (3.7)
Erbium-172	68	10 (.37)
Europium-145	63	10 (.37)
Europium-146	63	10 (.37)
Europium-147	63	10 (.37)

§ 172.101

49 CFR Ch. I (10–1–23 Edition)

TABLE 2 TO APPENDIX A—RADIONUCLIDES—
Continued

(1)—Radionuclide	(2)—Atomic Number	(3)—Reportable Quantity (RQ) Ci (TBq)
Europium-148	63	10 (.37)
Europium-149	63	100 (3.7)
Europium-150 (12.6 hr)	63	1000 (37)
Europium-150 (34.2 yr)	63	10 (.37)
Europium-152	63	10 (.37)
Europium-152m	63	100 (3.7)
Europium-154	63	10 (.37)
Europium-155	63	10 (.37)
Europium-156	63	10 (.37)
Europium-157	63	10 (.37)
Europium-158	63	1000 (37)
Fermium-252	100	10 (.37)
Fermium-253	100	10 (.37)
Fermium-254	100	100 (3.7)
Fermium-255	100	100 (3.7)
Fermium-257	100	1 (.037)
Fluorine-18	9	1000 (37)
Francium-222	87	100 (3.7)
Francium-223	87	100 (3.7)
Gadolinium-145	64	100 (3.7)
Gadolinium-146	64	10 (.37)
Gadolinium-147	64	10 (.37)
Gadolinium-148	64	0.001 (.000037)
Gadolinium-149	64	100 (3.7)
Gadolinium-151	64	100 (3.7)
Gadolinium-152	64	0.001 (.000037)
Gadolinium-153	64	10 (.37)
Gadolinium-159	64	1000 (37)
Gallium-65	31	1000 (37)
Gallium-66	31	10 (.37)
Gallium-67	31	100 (3.7)
Gallium-68	31	1000 (37)
Gallium-70	31	1000 (37)
Gallium-72	31	10 (.37)
Gallium-73	31	100 (3.7)
Germanium-66	32	100 (3.7)
Germanium-67	32	1000 (37)
Germanium-68	32	10 (.37)
Germanium-69	32	10 (.37)
Germanium-71	32	1000 (37)
Germanium-75	32	1000 (37)
Germanium-77	32	10 (.37)
Germanium-78	32	1000 (37)
Gold-193	79	100 (3.7)
Gold-194	79	10 (.37)
Gold-195	79	100 (3.7)
Gold-198	79	100 (3.7)
Gold-198m	79	10 (.37)
Gold-199	79	100 (3.7)
Gold-200	79	1000 (37)
Gold-200m	79	10 (.37)
Gold-201	79	1000 (37)
Hafnium-170	72	100 (3.7)
Hafnium-172	72	1 (.037)
Hafnium-173	72	100 (3.7)
Hafnium-175	72	100 (3.7)
Hafnium-177m	72	1000 (37)
Hafnium-178m	72	0.1 (.0037)
Hafnium-179m	72	100 (3.7)
Hafnium-180m	72	100 (3.7)
Hafnium-181	72	10 (.37)
Hafnium-182	72	0.1 (.0037)
Hafnium-182m	72	100 (3.7)
Hafnium-183	72	100 (3.7)
Hafnium-184	72	100 (3.7)
Holmium-155	67	1000 (37)
Holmium-157	67	1000 (37)
Holmium-159	67	1000 (37)

TABLE 2 TO APPENDIX A—RADIONUCLIDES—
Continued

(1)—Radionuclide	(2)—Atomic Number	(3)—Reportable Quantity (RQ) Ci (TBq)
Holmium-161	67	1000 (37)
Holmium-162	67	1000 (37)
Holmium-162m	67	1000 (37)
Holmium-164	67	1000 (37)
Holmium-164m	67	1000 (37)
Holmium-166	67	100 (3.7)
Holmium-166m	67	1 (.037)
Holmium-167	67	100 (3.7)
Hydrogen-3	1	100 (3.7)
Indium-109	49	100 (3.7)
Indium-110 (4.9 hr)	49	10 (.37)
Indium-110 (69.1 min)	49	100 (3.7)
Indium-111	49	100 (3.7)
Indium-112	49	1000 (37)
Indium-113m	49	1000 (37)
Indium-114m	49	10 (.37)
Indium-115	49	0.1 (.0037)
Indium-115m	49	100 (3.7)
Indium-116m	49	100 (3.7)
Indium-117	49	1000 (37)
Indium-117m	49	100 (3.7)
Indium-119m	49	1000 (37)
Iodine-120	53	10 (.37)
Iodine-120m	53	100 (3.7)
Iodine-121	53	100 (3.7)
Iodine-123	53	10 (.37)
Iodine-124	53	0.1 (.0037)
Iodine-125	53	0.01 (.00037)
Iodine-126	53	0.01 (.00037)
Iodine-128	53	1000 (37)
Iodine-129	53	0.001 (.000037)
Iodine-130	53	1 (.037)
Iodine-131	53	0.01 (.00037)
Iodine-132	53	10 (.37)
Iodine-132m	53	10 (.37)
Iodine-133	53	0.1 (.0037)
Iodine-134	53	100 (3.7)
Iodine-135	53	10 (.37)
Iridium-182	77	1000 (37)
Iridium-184	77	100 (3.7)
Iridium-185	77	100 (3.7)
Iridium-186	77	10 (.37)
Iridium-187	77	100 (3.7)
Iridium-188	77	10 (.37)
Iridium-189	77	100 (3.7)
Iridium-190	77	10 (.37)
Iridium-190m	77	1000 (37)
Iridium-192	77	10 (.37)
Iridium-192m	77	100 (3.7)
Iridium-194	77	100 (3.7)
Iridium-194m	77	10 (.37)
Iridium-195	77	1000 (37)
Iridium-195m	77	100 (3.7)
Iron-52	26	100 (3.7)
Iron-55	26	100 (3.7)
Iron-59	26	10 (.37)
Iron-60	26	0.1 (.0037)
Krypton-74	36	10 (.37)
Krypton-76	36	10 (.37)
Krypton-77	36	10 (.37)
Krypton-79	36	100 (3.7)
Krypton-81	36	1000 (37)
Krypton-83m	36	1000 (37)
Krypton-85	36	1000 (37)
Krypton-85m	36	100 (3.7)
Krypton-87	36	10 (.37)
Krypton-88	36	10 (.37)
Lanthanum-131	57	1000 (37)

TABLE 2 TO APPENDIX A—RADIONUCLIDES—
Continued

(1)—Radionuclide	(2)—Atomic Number	(3)—Reportable Quantity (RQ) Ci (TBq)
Lanthanum-132	57	100 (3.7)
Lanthanum-135	57	1000 (37)
Lanthanum-137	57	10 (.37)
Lanthanum-138	57	1 (.037)
Lanthanum-140	57	10 (.37)
Lanthanum-141	57	1000 (37)
Lanthanum-142	57	100 (3.7)
Lanthanum-143	57	1000 (37)
Lead-195m	82	1000 (37)
Lead-198	82	100 (3.7)
Lead-199	82	100 (3.7)
Lead-200	82	100 (3.7)
Lead-201	82	100 (3.7)
Lead-202	82	1 (.037)
Lead-202m	82	10 (.37)
Lead-203	82	100 (3.7)
Lead-205	82	100 (3.7)
Lead-209	82	1000 (37)
Lead-210	82	0.01 (.00037)
Lead-211	82	100 (3.7)
Lead-212	82	10 (.37)
Lead-214	82	100 (3.7)
Lutetium-169	71	10 (.37)
Lutetium-170	71	10 (.37)
Lutetium-171	71	10 (.37)
Lutetium-172	71	10 (.37)
Lutetium-173	71	100 (3.7)
Lutetium-174	71	10 (.37)
Lutetium-174m	71	10 (.37)
Lutetium-176	71	1 (.037)
Lutetium-176m	71	1000 (37)
Lutetium-177	71	100 (3.7)
Lutetium-177m	71	10 (.37)
Lutetium-178	71	1000 (37)
Lutetium-178m	71	1000 (37)
Lutetium-179	71	1000 (37)
Magnesium-28	12	10 (.37)
Manganese-51	25	1000 (37)
Manganese-52	25	10 (.37)
Manganese-52m	25	1000 (37)
Manganese-53	25	1000 (37)
Manganese-54	25	10 (.37)
Manganese-56	25	100 (3.7)
Mendelevium-257	101	100 (3.7)
Mendelevium-258	101	1 (.037)
Mercury-193	80	100 (3.7)
Mercury-193m	80	10 (.37)
Mercury-194	80	0.1 (.0037)
Mercury-195	80	100 (3.7)
Mercury-195m	80	100 (3.7)
Mercury-197	80	1000 (37)
Mercury-197m	80	1000 (37)
Mercury-199m	80	1000 (37)
Mercury-203	80	10 (.37)
Molybdenum-101	42	1000 (37)
Molybdenum-90	42	100 (3.7)
Molybdenum-93	42	100 (3.7)
Molybdenum-93m	42	10 (.37)
Molybdenum-99	42	100 (3.7)
Neodymium-136	60	1000 (37)
Neodymium-138	60	1000 (37)
Neodymium-139	60	1000 (37)
Neodymium-139m	60	100 (3.7)
Neodymium-141	60	1000 (37)
Neodymium-147	60	10 (.37)
Neodymium-149	60	100 (3.7)
Neodymium-151	60	1000 (37)
Neptunium-232	93	1000 (37)

TABLE 2 TO APPENDIX A—RADIONUCLIDES—
Continued

(1)—Radionuclide	(2)—Atomic Number	(3)—Reportable Quantity (RQ) Ci (TBq)
Neptunium-233	93	1000 (37)
Neptunium-234	93	10 (.37)
Neptunium-235	93	1000 (37)
Neptunium-236 (1.2 E 5 yr)	93	0.1 (.0037)
Neptunium-236 (22.5 hr)	93	100 (3.7)
Neptunium-237	93	0.01 (.00037)
Neptunium-238	93	10 (.37)
Neptunium-239	93	100 (3.7)
Neptunium-240	93	100 (3.7)
Nickel-56	28	10 (.37)
Nickel-57	28	10 (.37)
Nickel-59	28	100 (3.7)
Nickel-63	28	100 (3.7)
Nickel-65	28	100 (3.7)
Nickel-66	28	10 (.37)
Niobium-88	41	100 (3.7)
Niobium-89 (122 min)	41	100 (3.7)
Niobium-89 (66 min)	41	100 (3.7)
Niobium-90	41	10 (.37)
Niobium-93m	41	100 (3.7)
Niobium-94	41	10 (.37)
Niobium-95	41	10 (.37)
Niobium-95m	41	100 (3.7)
Niobium-96	41	10 (.37)
Niobium-97	41	100 (3.7)
Niobium-98	41	1000 (37)
Osmium-180	76	1000 (37)
Osmium-181	76	100 (3.7)
Osmium-182	76	100 (3.7)
Osmium-185	76	10 (.37)
Osmium-189m	76	1000 (37)
Osmium-191	76	100 (3.7)
Osmium-191m	76	1000 (37)
Osmium-193	76	100 (3.7)
Osmium-194	76	1 (.037)
Palladium-100	46	100 (3.7)
Palladium-101	46	100 (3.7)
Palladium-103	46	100 (3.7)
Palladium-107	46	100 (3.7)
Palladium-109	46	1000 (37)
Phosphorus-32	15	0.1 (.0037)
Phosphorus-33	15	1 (.037)
Platinum-186	78	100 (3.7)
Platinum-188	78	100 (3.7)
Platinum-189	78	100 (3.7)
Platinum-191	78	100 (3.7)
Platinum-193	78	1000 (37)
Platinum-193m	78	100 (3.7)
Platinum-195m	78	100 (3.7)
Platinum-197	78	1000 (37)
Platinum-197m	78	1000 (37)
Platinum-199	78	1000 (37)
Platinum-200	78	100 (3.7)
Plutonium-234	94	1000 (37)
Plutonium-235	94	1000 (37)
Plutonium-236	94	0.1 (.0037)
Plutonium-237	94	1000 (37)
Plutonium-238	94	0.01 (.00037)
Plutonium-239	94	0.01 (.00037)
Plutonium-240	94	0.01 (.00037)
Plutonium-241	94	1 (.037)
Plutonium-242	94	0.01 (.00037)
Plutonium-243	94	1000 (37)
Plutonium-244	94	0.01 (.00037)
Plutonium-245	94	100 (3.7)
Polonium-203	84	100 (3.7)
Polonium-205	84	100 (3.7)
Polonium-207	84	10 (.37)

§ 172.101

49 CFR Ch. I (10-1-23 Edition)

TABLE 2 TO APPENDIX A—RADIONUCLIDES—
Continued

(1)—Radionuclide	(2)— Atomic Num- ber	(3)—Reportable Quantity (RQ) Ci (TBq)
Polonium-210	84	0.01 (.00037)
Potassium-40	19	1 (.037)
Potassium-42	19	100 (3.7)
Potassium-43	19	10 (.37)
Potassium-44	19	100 (3.7)
Potassium-45	19	1000 (37)
Praseodymium-136	59	1000 (37)
Praseodymium-137	59	1000 (37)
Praseodymium-138m	59	100 (3.7)
Praseodymium-139	59	1000 (37)
Praseodymium-142	59	100 (3.7)
Praseodymium-142m	59	1000 (37)
Praseodymium-143	59	10 (.37)
Praseodymium-144	59	1000 (37)
Praseodymium-145	59	1000 (37)
Praseodymium-147	59	1000 (37)
Promethium-141	61	1000 (37)
Promethium-143	61	100 (3.7)
Promethium-144	61	10 (.37)
Promethium-145	61	100 (3.7)
Promethium-146	61	10 (.37)
Promethium-147	61	10 (.37)
Promethium-148	61	10 (.37)
Promethium-148m	61	10 (.37)
Promethium-149	61	100 (3.7)
Promethium-150	61	100 (3.7)
Promethium-151	61	100 (3.7)
Protactinium-227	91	100 (3.7)
Protactinium-228	91	10 (.37)
Protactinium-230	91	10 (.37)
Protactinium-231	91	0.01 (.00037)
Protactinium-232	91	10 (.37)
Protactinium-233	91	100 (3.7)
Protactinium-234	91	10 (.37)
RADIONUCLIDES \$†		1 (.037)
Radium-223	88	1 (.037)
Radium-224	88	10 (.37)
Radium-225	88	1 (.037)
Radium-226 **	88	0.1 (.0037)
Radium-227	88	1000 (37)
Radium-228	88	0.1 (.0037)
Radon-220	86	0.1 (.0037)
Radon-222	86	0.1 (.0037)
Rhenium-177	75	1000 (37)
Rhenium-178	75	1000 (37)
Rhenium-181	75	100 (3.7)
Rhenium-182 (12.7 hr)	75	10 (.37)
Rhenium-182 (64.0 hr)	75	10 (.37)
Rhenium-184	75	10 (.37)
Rhenium-184m	75	10 (.37)
Rhenium-186	75	100 (3.7)
Rhenium-186m	75	10 (.37)
Rhenium-187	75	1000 (37)
Rhenium-188	75	1000 (37)
Rhenium-188m	75	1000 (37)
Rhenium-189	75	1000 (37)
Rhodium-100	45	10 (.37)
Rhodium-101	45	10 (.37)
Rhodium-101m	45	100 (3.7)
Rhodium-102	45	10 (.37)
Rhodium-102m	45	10 (.37)
Rhodium-103m	45	1000 (37)
Rhodium-105	45	100 (3.7)
Rhodium-106m	45	10 (.37)
Rhodium-107	45	1000 (37)
Rhodium-99	45	10 (.37)
Rhodium-99m	45	100 (3.7)
Rubidium-79	37	1000 (37)

TABLE 2 TO APPENDIX A—RADIONUCLIDES—
Continued

(1)—Radionuclide	(2)— Atomic Num- ber	(3)—Reportable Quantity (RQ) Ci (TBq)
Rubidium-81	37	100 (3.7)
Rubidium-81m	37	1000 (37)
Rubidium-82m	37	10 (.37)
Rubidium-83	37	10 (.37)
Rubidium-84	37	10 (.37)
Rubidium-86	37	10 (.37)
Rubidium-87	37	10 (.37)
Rubidium-88	37	1000 (37)
Rubidium-89	37	1000 (37)
Ruthenium-103	44	10 (.37)
Ruthenium-105	44	100 (3.7)
Ruthenium-106	44	1 (.037)
Ruthenium-94	44	1000 (37)
Ruthenium-97	44	100 (3.7)
Samarium-141	62	1000 (37)
Samarium-141m	62	1000 (37)
Samarium-142	62	1000 (37)
Samarium-145	62	100 (3.7)
Samarium-146	62	0.01 (.00037)
Samarium-147	62	0.01 (.00037)
Samarium-151	62	10 (.37)
Samarium-153	62	100 (3.7)
Samarium-155	62	1000 (37)
Samarium-156	62	100 (3.7)
Scandium-43	21	1000 (37)
Scandium-44	21	100 (3.7)
Scandium-44m	21	10 (.37)
Scandium-46	21	10 (.37)
Scandium-47	21	100 (3.7)
Scandium-48	21	10 (.37)
Scandium-49	21	1000 (37)
Selenium-70	34	1000 (37)
Selenium-73	34	10 (.37)
Selenium-73m	34	100 (3.7)
Selenium-75	34	10 (.37)
Selenium-79	34	10 (.37)
Selenium-81	34	1000 (37)
Selenium-81m	34	1000 (37)
Selenium-83	34	1000 (37)
Silicon-31	14	1000 (37)
Silicon-32	14	1 (.037)
Silver-102	47	100 (3.7)
Silver-103	47	1000 (37)
Silver-104	47	1000 (37)
Silver-104m	47	1000 (37)
Silver-105	47	10 (.37)
Silver-106	47	1000 (37)
Silver-106m	47	10 (.37)
Silver-108m	47	10 (.37)
Silver-110m	47	10 (.37)
Silver-111	47	10 (.37)
Silver-112	47	100 (3.7)
Silver-115	47	1000 (37)
Sodium-22	11	10 (.37)
Sodium-24	11	10 (.37)
Strontium-80	38	100 (3.7)
Strontium-81	38	1000 (37)
Strontium-83	38	100 (3.7)
Strontium-85	38	10 (.37)
Strontium-85m	38	1000 (37)
Strontium-87m	38	100 (3.7)
Strontium-89	38	10 (.37)
Strontium-90	38	0.1 (.0037)
Strontium-91	38	10 (.37)
Strontium-92	38	100 (3.7)
Sulfur-35	16	1 (.037)
Tantalum-172	73	100 (3.7)
Tantalum-173	73	100 (3.7)

TABLE 2 TO APPENDIX A—RADIONUCLIDES—
Continued

(1)—Radionuclide	(2)—Atomic Number	(3)—Reportable Quantity (RQ) Ci (TBq)
Tantalum-174	73	100 (3.7)
Tantalum-175	73	100 (3.7)
Tantalum-176	73	10 (.37)
Tantalum-177	73	1000 (37)
Tantalum-178	73	1000 (37)
Tantalum-179	73	1000 (37)
Tantalum-180	73	100 (3.7)
Tantalum-180m	73	1000 (37)
Tantalum-182	73	10 (.37)
Tantalum-182m	73	1000 (37)
Tantalum-183	73	100 (3.7)
Tantalum-184	73	10 (.37)
Tantalum-185	73	1000 (37)
Tantalum-186	73	1000 (37)
Technetium-101	43	1000 (37)
Technetium-104	43	1000 (37)
Technetium-93	43	100 (3.7)
Technetium-93m	43	1000 (37)
Technetium-94	43	10 (.37)
Technetium-94m	43	100 (3.7)
Technetium-96	43	10 (.37)
Technetium-96m	43	1000 (37)
Technetium-97	43	100 (3.7)
Technetium-97m	43	100 (3.7)
Technetium-98	43	10 (.37)
Technetium-99	43	10 (.37)
Technetium-99m	43	100 (3.7)
Tellurium-116	52	1000 (37)
Tellurium-121	52	10 (.37)
Tellurium-121m	52	10 (.37)
Tellurium-123	52	10 (.37)
Tellurium-123m	52	10 (.37)
Tellurium-125m	52	10 (.37)
Tellurium-127	52	1000 (37)
Tellurium-127m	52	10 (.37)
Tellurium-129	52	1000 (37)
Tellurium-129m	52	10 (.37)
Tellurium-131	52	1000 (37)
Tellurium-131m	52	10 (.37)
Tellurium-132	52	10 (.37)
Tellurium-133	52	1000 (37)
Tellurium-133m	52	1000 (37)
Tellurium-134	52	1000 (37)
Terbium-147	65	100 (3.7)
Terbium-149	65	100 (3.7)
Terbium-150	65	100 (3.7)
Terbium-151	65	10 (.37)
Terbium-153	65	100 (3.7)
Terbium-154	65	10 (.37)
Terbium-155	65	100 (3.7)
Terbium-156	65	10 (.37)
Terbium-156m (24.4 hr)	65	1000 (37)
Terbium-156m (5.0 hr)	65	1000 (37)
Terbium-157	65	100 (3.7)
Terbium-158	65	10 (.37)
Terbium-160	65	10 (.37)
Terbium-161	65	100 (3.7)
Thallium-194	81	1000 (37)
Thallium-194m	81	100 (3.7)
Thallium-195	81	100 (3.7)
Thallium-197	81	100 (3.7)
Thallium-198	81	10 (.37)
Thallium-198m	81	100 (3.7)
Thallium-199	81	100 (3.7)
Thallium-200	81	10 (.37)
Thallium-201	81	1000 (37)
Thallium-202	81	10 (.37)
Thallium-204	81	10 (.37)

TABLE 2 TO APPENDIX A—RADIONUCLIDES—
Continued

(1)—Radionuclide	(2)—Atomic Number	(3)—Reportable Quantity (RQ) Ci (TBq)
Thorium (Irradiated)	90	***
Thorium (Natural)	90	**
Thorium-226	90	100 (3.7)
Thorium-227	90	1 (.037)
Thorium-228	90	0.01 (.00037)
Thorium-229	90	0.001 (.000037)
Thorium-230	90	0.01 (.00037)
Thorium-231	90	100 (3.7)
Thorium-232 **	90	0.001 (.000037)
Thorium-234	90	100 (3.7)
Thulium-162	69	1000 (37)
Thulium-166	69	10 (.37)
Thulium-167	69	100 (3.7)
Thulium-170	69	10 (.37)
Thulium-171	69	100 (3.7)
Thulium-172	69	100 (3.7)
Thulium-173	69	100 (3.7)
Thulium-175	69	1000 (37)
Tin-110	50	100 (3.7)
Tin-111	50	1000 (37)
Tin-113	50	10 (.37)
Tin-117m	50	100 (3.7)
Tin-119m	50	10 (.37)
Tin-121	50	1000 (37)
Tin-121m	50	10 (.37)
Tin-123	50	10 (.37)
Tin-123m	50	1000 (37)
Tin-125	50	10 (.37)
Tin-126	50	1 (.037)
Tin-127	50	100 (3.7)
Tin-128	50	1000 (37)
Titanium-44	22	1 (.037)
Titanium-45	22	1000 (37)
Tungsten-176	74	1000 (37)
Tungsten-177	74	100 (3.7)
Tungsten-178	74	100 (3.7)
Tungsten-179	74	1000 (37)
Tungsten-181	74	100 (3.7)
Tungsten-185	74	10 (.37)
Tungsten-187	74	100 (3.7)
Tungsten-188	74	10 (.37)
Uranium (Depleted)	92	***
Uranium (Irradiated)	92	***
Uranium (Natural)	92	**
Uranium Enriched 20% or greater	92	***
Uranium Enriched less than 20%	92	***
Uranium-230	92	1 (.037)
Uranium-231	92	1000 (37)
Uranium-232	92	0.01 (.00037)
Uranium-233	92	0.1 (.0037)
Uranium-234 **	92	0.1 (.0037)
Uranium-235 **	92	0.1 (.0037)
Uranium-236	92	0.1 (.0037)
Uranium-237	92	100 (3.7)
Uranium-238 **	92	0.1 (.0037)
Uranium-239	92	1000 (37)
Uranium-240	92	1000 (37)
Vanadium-47	23	1000 (37)
Vanadium-48	23	10 (.37)
Vanadium-49	23	1000 (37)
Xenon-120	54	100 (3.7)
Xenon-121	54	10 (.37)
Xenon-122	54	100 (3.7)
Xenon-123	54	10 (.37)
Xenon-125	54	100 (3.7)
Xenon-127	54	100 (3.7)

TABLE 2 TO APPENDIX A—RADIONUCLIDES—
Continued

(1)—Radionuclide	(2)—Atomic Number	(3)—Reportable Quantity (RQ) Ci (TBq)
Xenon-129m	54	1000 (37)
Xenon-131m	54	1000 (37)
Xenon-133	54	1000 (37)
Xenon-133m	54	1000 (37)
Xenon-135	54	100 (3.7)
Xenon-135m	54	10 (3.7)
Xenon-138	54	10 (3.7)
Ytterbium-162	70	1000 (37)
Ytterbium-166	70	10 (3.7)
Ytterbium-167	70	1000 (37)
Ytterbium-169	70	10 (3.7)
Ytterbium-175	70	100 (3.7)
Ytterbium-177	70	1000 (37)
Ytterbium-178	70	1000 (37)
Yttrium-86	39	10 (3.7)
Yttrium-86m	39	1000 (37)
Yttrium-87	39	10 (3.7)
Yttrium-88	39	10 (3.7)
Yttrium-90	39	10 (3.7)
Yttrium-90m	39	100 (3.7)
Yttrium-91	39	10 (3.7)
Yttrium-91m	39	1000 (37)
Yttrium-92	39	100 (3.7)
Yttrium-93	39	100 (3.7)
Yttrium-94	39	1000 (37)
Yttrium-95	39	1000 (37)
Zinc-62	30	100 (3.7)
Zinc-63	30	1000 (37)
Zinc-65	30	10 (3.7)
Zinc-69	30	1000 (37)
Zinc-69m	30	100 (3.7)
Zinc-71m	30	100 (3.7)
Zinc-72	30	100 (3.7)
Zirconium-86	40	100 (3.7)
Zirconium-88	40	10 (3.7)
Zirconium-89	40	100 (3.7)
Zirconium-93	40	1 (.037)
Zirconium-95	40	10 (3.7)
Zirconium-97	40	10 (3.7)

§ The RQs for all radionuclides apply to chemical compounds containing the radionuclides and elemental forms regardless of the diameter of pieces of solid material.

† The RQ of one curie applies to all radionuclides not otherwise listed. Whenever the RQs in TABLE 1—HAZARDOUS SUBSTANCES OTHER THAN RADIONUCLIDES and this table conflict, the lowest RQ shall apply. For example, uranyl acetate and uranyl nitrate have RQs shown in TABLE 1 of 100 pounds, equivalent to about one-tenth the RQ level for uranium-238 in this table.

** The method to determine the RQs for mixtures or solutions of radionuclides can be found in paragraph 7 of the note preceding TABLE 1 of this appendix. RQs for the following four common radionuclide mixtures are provided: radium-226 in secular equilibrium with its daughters (0.053 curie); natural uranium (0.1 curie); natural uranium in secular equilibrium with its daughters (0.052 curie); and natural thorium in secular equilibrium with its daughters (0.011 curie).

*** Indicates that the name was added by PHMSA because it appears in the list of radionuclides in 49 CFR 173.435. The reportable quantity (RQ), if not specifically listed elsewhere in this appendix, shall be determined in accordance with the procedures in paragraph 7 of this appendix.

APPENDIX B TO § 172.101—LIST OF MARINE POLLUTANTS

1. See §171.4 of this subchapter for applicability to marine pollutants. This appendix lists potential marine pollutants as defined in §171.8 of this subchapter.

2. Marine pollutants listed in this appendix are not necessarily listed by name in the §172.101 Table. If a marine pollutant not listed by name or by synonym in the §172.101 Table meets the definition of any hazard Class 1 through 8, then you must determine the class and division of the material in accordance with §173.2a of this subchapter. You must also select the most appropriate hazardous material description and proper shipping name. If a marine pollutant not listed by name or by synonym in the §172.101 Table does not meet the definition of any Class 1 through 8, then you must offer it for transportation under the most appropriate of the following two Class 9 entries: “Environmentally hazardous substances, liquid, n.o.s.” UN3082, or “Environmentally hazardous substances, solid, n.o.s.” UN3077.

3. This appendix contains two columns. The first column, entitled “S.M.P.” (for severe marine pollutants), identifies whether a material is a severe marine pollutant. If the letters “PP” appear in this column for a material, the material is a severe marine pollutant, otherwise it is not. The second column, entitled “Marine Pollutant”, lists the marine pollutants.

4. If a material is not listed in this appendix and meets the criteria for a marine pollutant as provided in Chapter 2.9 of the IMDG Code, (incorporated by reference; see §171.7 of this subchapter), the material may be transported as a marine pollutant in accordance with the applicable requirements of this subchapter.

5. If a material or a solution meeting the definition of a marine pollutant in §171.8 of this subchapter does not meet the criteria for a marine pollutant as provided in section 2.9.3.3 and 2.9.3.4 of the IMDG Code, (incorporated by reference; see §171.7 of this subchapter), it may be excepted from the requirements of this subchapter as a marine pollutant if that exception is approved by the Associate Administrator.

LIST OF MARINE POLLUTANTS

S.M.P. (1)	Marine pollutant (2)
	Acetone cyanohydrin, stabilized
	Acetylene tetrabromide
	Acetylene tetrachloride
	Acraldehyde, inhibited
	Acroleic acid, stabilized
	Acrolein, inhibited
	Acrolein, stabilized
	Acrylic acid, stabilized
	Acrylic aldehyde, inhibited
	Alcohol C-12 - C-16 poly(1-6) ethoxylate
	Alcohol C-6 - C-17 (secondary)poly(3-6) ethoxylate
	Aldicarb
PP	Aldrin
	Alkyl (c12-c14) dimethylamine
	Alkyl (c7-c9) nitrates
	Alkybenzenesulphonates, branched and straight chain (excluding C11–C13 straight chain or branched chain homologues)

LIST OF MARINE POLLUTANTS—Continued		LIST OF MARINE POLLUTANTS—Continued	
S.M.P. (1)	Marine pollutant (2)	S.M.P. (1)	Marine pollutant (2)
	Allyl alcohol		Calcium hypochlorite, hydrated, corrosive <i>with not less than 5.5% but not more than 16% water</i>
	Allyl bromide		Calcium hypochlorite, hydrated mixture <i>with not less than 5.5% but not more than 16% water</i>
	ortho-Aminoanisole		Calcium hypochlorite, hydrated mixture, corrosive <i>with not less than 5.5% but not more than 16% water</i>
	Aminobenzene		Campechlor
	Aminocarb	PP	Carbaryl
	Ammonia, anhydrous (l)		Carbendazim
	Ammonia solution, <i>relative density less than 0.880 at 15 degrees C in water, with more than 50 percent ammonia</i>		Carbofuran
	Ammonia solution <i>relative density less than 0.880 at 15 degrees C in water, with more than 35% but not more than 50% ammonia</i>		Carbon tetrabromide
	Ammonia solution, <i>relative density between 0.880 and 0.957 at 15 degrees C in water, with more than 10 percent but not more than 35 percent ammonia, by mass</i>	PP	Carbon tetrachloride
	Ammonium dinitro-o-cresolate	PP	Carbophenothion
	n-Amylbenzene	PP	Cartap hydrochloride
	Aniline	PP	Chlordane
	Aniline oil		Chlorfenvinphos
PP	Azinphos-ethyl		Chlorinated paraffins (C-10 - C-13)
PP	Azinphos-methyl		Chlorinated paraffins (C14–C17), with more than 1% shorter chain length
	Barium cyanide		Chlorine
	Bendiocarb		Chlorine cyanide, inhibited
	Benomyl		Chlormephos
	Benquinox		Chloroacetone, stabilized
	Benzyl chlorocarbonate		1-Chloro-2,3-Epoxypropane
	Benzyl chloroformate		2-Chloro-6-nitrotoluene
PP	Binapacryl		4-Chloro-2-nitrotoluene
	<i>N,N-Bis (2-hydroxyethyl) oleamide (LOA)</i>		Chloro-ortho-nitrotoluene
	Bleaching powder		2-Chloro-5-trifluoromethylnitrobenzene
PP	Brodifacoum		para-Chlorobenzyl chloride, liquid or solid
	Bromine cyanide		Chlorodinitrobenzenes, liquid or solid
	Bromoacetone		1-Chloroheptane
	Bromoallylene		1-Chlorohexane
	Bromobenzene		Chloronitroanilines
	ortho-Bromobenzyl cyanide		Chloronitrotoluenes, <i>liquid</i>
	Bromocyan	PP	Chloronitrotoluenes, <i>solid</i>
	Bromoform	PP	1-Chlorooctane
PP	Bromophos-ethyl		Chlorophenolates, liquid
	3-Bromopropene		Chlorophenolates, solid
	Bromoxnil		Chlorophenyltrichlorosilane
	Butanedione		Chloropicrin
	2-Butenal, stabilized	PP	alpha-Chloropropylene
	Butyl benzyl phthalate	PP	ortho-Chlorotoluene
	Butylbenzenes		Chlorpyrifos
	<i>N-tert-butyl-N-cyclopropyl-6-methylthio-1,3,5-triazine-2,4-diamine</i>		Chlorthiophos
	2,4-Di-tert-butylphenol		Cocculus
PP	2, 6-Di-tert-Butylphenol	PP	Coconitrile
	para-tertiary-butyltoluene	PP	Copper acetoarsenite
PP	Cadmium compounds	PP	Copper arsenite
	Cadmium sulphide	PP	Copper chloride
	Calcium arsenate	PP	Copper chloride solution
	Calcium arsenate and calcium arsenite, mixtures, solid	PP	Copper cyanide
	Calcium cyanide	PP	Copper metal powder
	Calcium hypochlorite, dry <i>with more than 39% available chlorine (8.8% available oxygen)</i>	PP	Copper sulphate, anhydrous, hydrates
	Calcium hypochlorite mixture, dry <i>with more than 10% but not more than 39% available chlorine</i>		Coumachlor
	Calcium hypochlorite mixture, dry <i>with more than 39% available chlorine (8.8% available oxygen)</i>	PP	Coumaphos
	Calcium hypochlorite mixture, dry, corrosive <i>with more than 10% but not more than 39% available chlorine</i>	PP	Creosote salts
	Calcium hypochlorite mixture, dry, corrosive <i>with more than 39% available chlorine (8.8% available oxygen)</i>	PP	Cresyl diphenyl phosphate
	Calcium hypochlorite, hydrated <i>with not less than 5.5% but not more than 16% water</i>	PP	Crotonaldehyde, stabilized
			Crotonic aldehyde, stabilized
			Crotoxypfos
			Cupric arsenite
		PP	Cupric chloride
		PP	Cupric cyanide
		PP	Cupric sulfate
		PP	Cupriethylenediamine solution
		PP	Cuprous chloride
			Cyanide mixtures
			Cyanide solutions
			Cyanides, inorganic, n.o.s.
			Cyanogen bromide

§ 172.101

49 CFR Ch. I (10–1–23 Edition)

LIST OF MARINE POLLUTANTS—Continued

S.M.P. (1)	Marine pollutant (2)
	Cyanogen chloride, inhibited
	Cyanogen chloride, stabilized
	Cyanophos
PP	1,5,9-Cyclododecatriene
	Cycloheptane
PP	Cyhexatin
PP	Cymenes (o-;m-;p-)
PP	Cypermethrin
	Decyl acrylate
PP	DDT
	Decycloxytetrahydrothiophene dioxide
	DEF
	Desmedipham
	Di-allate
	Di-n-Butyl phthalate
PP	Dialifos
	4,4'-Diaminodiphenylmethane
PP	Diazinon
	1,3-Dibromobenzene
PP	Dichlofenthion
	Dichloroanilines
	1,3-Dichlorobenzene
	1,4-Dichlorobenzene
	Dichlorobenzene (meta-; para-)
	2,2-Dichlorodiethyl ether
	Dichlorodimethyl ether, symmetrical
	Di-(2-chloroethyl) ether
	1,1-Dichloroethylene, inhibited
	1,6-Dichlorohexane
	2,4-Dichlorophenol
	Dichlorophenyltrichlorosilane
	1,3-Dichloropropene
PP	Dichlorvos
PP	Diclofop-methyl
	Dicrotophos
PP	Dieldrin
	Diisopropylbenzenes
	Diisopropyl-naphthalenes, mixed isomers
PP	Dimethoate
	Dimethyl disulphide
PP	N,N-Dimethyldodecylamine
	Dimethylhydrazine, symmetrical
	Dimethylhydrazine, unsymmetrical
	Dinitro-o-cresol, <i>solid</i>
	Dinitro-o-cresol, <i>solution</i>
	Dinitrochlorobenzenes, liquid or solid
	Dinitrophenol, <i>dry or wetted with less than 15 per cent water, by mass</i>
	Dinitrophenol solutions
	Dinitrophenol, <i>wetted with not less than 15 per cent water, by mass</i>
	Dinitrophenolates <i>alkali metals, dry or wetted with less than 15 per cent water, by mass</i>
	Dinitrophenolates, <i>wetted with not less than 15 per cent water, by mass</i>
	Dinitrotoluenes, liquid
	Dinitrotoluenes, molton
	Dintrotoluenes, solid
	Dinobuton
	Dinoseb
	Dinoseb acetate
	Dioxacarb
	Dioxathion
	Dipentene
	Diphacinone
	Diphenyl
PP	Diphenylamine chloroarsine
PP	Diphenylchloroarsine, solid or liquid
	Disulfoton
	1,4-Di-tert-butylbenzene
	DNOC

LIST OF MARINE POLLUTANTS—Continued

S.M.P. (1)	Marine pollutant (2)
	DNOC (pesticide)
	Dodecene (except 1-dodecene)
	Dodecyl diphenyl oxide disulphonate
PP	Dodecyl hydroxypropyl sulfide
	1-Dodecylamine
PP	Dodecylphenol
	Drazoxolon
	Edifenphos
PP	Endosulfan
PP	Endrin
	Epibromohydrin
	Epichlorohydrin
PP	EPN
PP	Esfenvalerate
PP	Ethion
	Ethoprophos
	Ethyl fluid
	Ethyl mercaptan
	2-Ethylhexyl nitrate
	2-Ethyl-3-propylacrolein
	Ethyl tetraphosphate
	Ethylchloroarsine
	Ethylene dibromide and methyl bromide mixtures, liquid
	2-Ethylhexaldehyde
	Fenamiphos
PP	Fenbutatin oxide
PP	Fenchlorazole-ethyl
PP	Fenitrothion
PP	Fenoxapro-ethyl
PP	Fenoxaprop-P-ethyl
PP	Fenpropathrin
	Fensulfthion
PP	Fenthion
PP	Fentin acetate
PP	Fentin hydroxide
	Ferric arsenate
	Ferric arsenite
	Ferrous arsenate
PP	Fonofos
	Formetanate
PP	Furathiocarb (ISO)
PP	gamma-BHC
	Gasoline, leaded
PP	Heptachlor
	Heptanes
	Heptenophos
	n-Heptaldehyde
	n-Heptylbenzene
	normal-Heptyl chloride
PP	Hexachlorobutadiene
PP	1,3-Hexachlorobutadiene
	Hexaethyl tetraphosphate <i>liquid</i>
	Hexaethyl tetraphosphate, <i>solid</i>
	Hexane
	normal-Hexyl chloride
	n-Hexylbenzene
	Hydrocyanic acid, anhydrous, stabilized, containing less than 3% water
	Hydrocyanic acid, anhydrous, stabilized, containing less than 3% water and absorbed in a porous inert material
	Hydrocyanic acid, aqueous solutions <i>not more than 20% hydrocyanic acid</i>
	Hydrogen cyanide solution in alcohol, <i>with not more than 45% hydrogen cyanide</i>
	Hydrogen cyanide, stabilized <i>with less than 3% water</i>
	Hydrogen cyanide, stabilized <i>with less than 3% water and absorbed in a porous inert material</i>
	Hydroxydimethylbenzenes, liquid or solid

LIST OF MARINE POLLUTANTS—Continued		LIST OF MARINE POLLUTANTS—Continued	
S.M.P. (1)	Marine pollutant (2)	S.M.P. (1)	Marine pollutant (2)
	Hypochlorite solutions	PP	Mercury benzoate
	loxynil	PP	Mercury bichloride
	Isobenzan	PP	Mercury bisulphates
	Isobutyl butyrate	PP	Mercury bromides
	Isobutylbenzene	PP	Mercury compounds, liquid, n.o.s.
	Isodecyl acrylate	PP	Mercury compounds, solid, n.o.s.
	Isodecyl diphenyl phosphate	PP	Mercury cyanide
	Isofenphos	PP	Mercury gluconate
	Isooctane	PP	Mercury (I) (mercurous) compounds (pesticides)
	Isooctyl nitrate	PP	Mercury (II) (mercuric) compounds (pesticides)
	Isoprene, stabilized		Mercury iodide
	Isoprocarb	PP	Mercury nucleate
	Isotetramethylbenzene	PP	Mercury oleate
PP	Isoxathion	PP	Mercury oxide
	Lead acetate	PP	Mercury oxycyanide, desensitized
	Lead arsenates	PP	Mercury potassium cyanide
	Lead arsenites	PP	Mercury potassium iodide
	Lead compounds, soluble, n.o.s.	PP	Mercury salicylate
	Lead cyanide	PP	Mercury sulfates
	Lead nitrate	PP	Mercury thiocyanate
	Lead perchlorate, solid or solution		Mesitylene
	Lead tetraethyl		Metam-sodium
	Lead tetramethyl		Methamidophos
PP	Lindane		Methanethiol
	Linuron		Methidathion
	London Purple		Methomyl
	Magnesium arsenate		ortho-Methoxyaniline
	Malathion		Methyl bromide and ethylene dibromide mixtures, liq- uid
	Mancozeb (ISO)		Methyl disulphide
	Maneb		Methyl mercaptan
	Maneb preparations with not less than 60% maneb		2-Methyl-2-phenylpropane
	Maneb preparation, stabilized against self-heating		3-Methylacroleine, stabilized
	Maneb stabilized or Maneb preparations, stabilized against self-heating		N-Methylaniline
	Manganese ethylene-1,2-bis dithiocarbamate		Methylchlorobenzenes
	Manganese ethylene-1,2-bis-dithiocarbamate, sta- bilized against self-heating		Methylcyclohexane
	Mecarbam		Methyldinitrobenzenes, liquid
	Mephostolan		Methyldinitrobenzenes, molten
	Mercaptodimethur		Methyldinitrobenzenes, solid
PP	Mercuric acetate		Methyldithiomethane
PP	Mercuric ammonium chloride		2-Methylheptane
PP	Mercuric arsenate		Methylnitrophenols
PP	Mercuric benzoate		2-Methylpentane
PP	Mercuric bisulphate		3-Methylpyradine
PP	Mercuric bromide		Methyltrithion
PP	Mercuric chloride	PP	Methylvinylbenzenes, inhibited
PP	Mercuric cyanide		Mevinphos
PP	Mercuric gluconate		Mexacarbate
	Mercuric iodide		Mirex
PP	Mercuric nitrate		Monocrotophos
PP	Mercuric oleate		Motor fuel anti-knock mixtures
PP	Mercuric oxide		Motor fuel anti-knock mixtures or compounds
PP	Mercuric oxycyanide, desensitized		Nabam
PP	Mercuric potassium cyanide		Naled
PP	Mercuric Sulphate	PP	Naphthalene, crude or Naphthalene, refined
PP	Mercuric thiocyanate	PP	Napthalene, molten
PP	Mercuriol	PP	Nickel carbonyl
PP	Mercurous acetate	PP	Nickel cyanide
PP	Mercurous bisulphate		Nickel tetracarbonyl
PP	Mercurous bromide		3-Nitro-4-chlorobenzotrifluoride
PP	Mercurous chloride		Nitrobenzene
PP	Mercurous nitrate		Nitrobenzotrifluorides, liquid or solid
PP	Mercurous salicylate		Nonanes
PP	Mercurous sulphate		Nonylphenol
PP	Mercury acetates		normal-Octaldehyde
PP	Mercury ammonium chloride		Octanes
PP	Mercury based pesticide, liquid, flammable, toxic	PP	Oleylamine
PP	Mercury based pesticides, liquid, toxic, flammable	PP	Organotin compounds, liquid, n.o.s.
PP	Mercury based pesticides, liquid, toxic	PP	Organotin compounds (pesticides)
PP	Mercury based pesticides, solid, toxic	PP	Organotin compounds, solid, n.o.s.
		PP	Organotin pesticides, liquid, flammable, toxic, n.o.s., flash point less than 23deg C

§ 172.101

49 CFR Ch. I (10–1–23 Edition)

LIST OF MARINE POLLUTANTS—Continued

S.M.P. (1)	Marine pollutant (2)
PP	Organotin pesticides, liquid, toxic, flammable, n.o.s.
PP	Organotin pesticides, liquid, toxic, n.o.s.
PP	Organotin pesticides, solid, toxic, n.o.s.
PP	Orthoarsenic acid
PP	Osmium tetroxide
	Oxamyl
	Oxydisulfoton
	Paraoxon
PP	Parathion
PP	Parathion-methyl
PP	PCBs.
	Pentachloroethane
PP	Pentachlorophenol
	Pentalin
	n-Pentylbenzene
	Perchloroethylene
	Perchloromethylmercaptan
	Petrol, leaded
PP	Phenarsazine chloride
	d-Phenothrin
PP	Phenthoate
	Phenylamine
	1-Phenylbutane
	2-Phenylbutane
	Phenylcyclohexane
PP	Phenylmercuric acetate
PP	Phenylmercuric compounds, n.o.s.
PP	Phenylmercuric hydroxide
PP	Phenylmercuric nitrate
PP	Phorate
PP	Phosalone
PP	Phosmet
PP	Phosphamidon
PP	Phosphorus, white, molten
PP	Phosphorus, white or yellow dry or under water or in solution
PP	Phosphorus white, or yellow, molten
PP	Phosphorus, yellow, molten
	Pindone (and salts of)
	Pine Oil
	alpha-Pinene
	Pirimicarb
PP	Pirimiphos-ethyl
PP	Polychlorinated biphenyls
PP	Polyhalogenated biphenyls, liquid or Terphenyls liquid
PP	Polyhalogenated biphenyls, solid or Terphenyls, solid
PP	Potassium cuprocyanide
	Potassium cyanide, solid
	Potassium cyanide, solution
PP	Potassium cyanocuprate (I)
PP	Potassium cyanomercurate
PP	Potassium mercuric iodide
	Promecarb
	Propachlor
	Propaphos
	Propenal, inhibited
	Propenoic acid, stabilized
	Propenyl alcohol
	Propoxur
	Propylene tetramer
	Prothoate
	Prussic acid, anhydrous, stabilized
	Prussic acid, anhydrous, stabilized, absorbed in a porous inert material
PP	Pyrazophos
	Quinalphos
PP	Quizalofop
PP	Quizalofop-p-ethyl
	Rotenone

LIST OF MARINE POLLUTANTS—Continued

S.M.P. (1)	Marine pollutant (2)
PP	Salithion
PP	Silafluofen
	Silver arsenite
	Silver cyanide
	Silver orthoarsenite
PP	Sodium copper cyanide, solid
PP	Sodium copper cyanide solution
PP	Sodium cuprocyanide, solid
PP	Sodium cuprocyanide, solution
	Sodium cyanide, solid
	Sodium cyanide, solution
	Sodium dinitro-o-cresolate, dry or wetted with less than 15 per cent water, by mass
	Sodium dinitro-ortho-cresolate, wetted with not less than 15 per cent water, by mass
	Sodium hypochlorite solution
PP	Sodium pentachlorophenate
	Strychnine or Strychnine salts
	Sulfotep
PP	Sulprophos
	Tallow nitrile
	Temephos
	TEPP
PP	Terbufos
	Tetrabromoethane
	Tetrabromomethane
	1,1,2,2-Tetrachloroethane
	Tetrachloroethylene
	Tetrachloromethane
	Tetraethyl dithiopyrophosphate
PP	Tetraethyl lead, liquid
	Tetramethrin
	Tetramethyllead
	Tetrapropylene
	Thallium chlorate
	Thallium compounds, n.o.s.
	Thallium compounds (pesticides)
	Thallium nitrate
	Thallium sulfate
	Thallos chlorate
	Thiocarbonyl tetrachloride
	Toluidines, liquid
	Toluidines, solid
	Triaryl phosphates, isopropylated
PP	Triaryl phosphates, n.o.s.
	Triazophos
	Tribromomethane
PP	Tributyltin compounds
	Trichlorfon
PP	1,2,3-Trichlorobenzene
	Trichlorobenzenes, liquid
	Trichlorobutene
	Trichlorobutylene
	Trichloromethane sulphuryl chloride
	Trichloromethyl sulphochloride
	Trichloronat
	Tricresyl phosphate (less than 1% ortho-isomer)
PP	Tricresyl phosphate, not less than 1% ortho-isomer but not more than 3% orthoisomer
PP	Tricresyl phosphate with more than 3 per cent ortho isomer
	Triethylbenzene
	Triisopropylated phenyl phosphates
	1,3,5-Trimethylbenzene
	Trimethylene dichloride
	2,2,4-Trimethylpentane
PP	Triphenylphosphate
	Triphenyl phosphate/tert-butylated triphenyl phosphates mixtures containing 5% to 10% triphenyl phosphates

Pipeline and Haz. Mats. Safety Admin., DOT

§ 172.101, Nt.

LIST OF MARINE POLLUTANTS—Continued

S.M.P. (1)	Marine pollutant (2)
PP	Triphenyl phosphate/tert-butylated triphenyl phosphates mixtures containing 10% to 48% triphenyl phosphates
PP	Triphenyltin compounds
PP	Tripropylene
PP	Tritolyl phosphate (less than 1% ortho-isomer)
PP	Tritolyl phosphate (not less than 1% ortho-isomer)
PP	Trixylenyl phosphate
PP	Turpentine
PP	Vinylidene chloride, stabilized
PP	Warfarin (and salts of)
PP	White phosphorus, dry
PP	White phosphorus, wet
PP	White spirit, low (15-20%) aromatic
PP	Yellow phosphorus, dry
PP	Yellow phosphorus, wet
PP	Zinc bromide
PP	Zinc chloride, anhydrous
PP	Zinc chloride solution
PP	Zinc cyanide

[Amdt. 172-173, 55 FR 52474, Dec. 21, 1990]

EDITORIAL NOTE: For FEDERAL REGISTER citations affecting § 172.101, see the List of CFR Sections Affected, which appears in the Finding Aids section of the printed volume and at www.govinfo.gov.

EFFECTIVE DATE NOTE: At 88 FR 60373, Sept. 1, 2023, the Hazardous Materials Table in § 172.101 was amended by revising the entry for “Methane, refrigerated liquid (*cryogenic liquid*) or Natural gas, refrigerated liquid (*cryogenic liquid*), with high methane content”, effective Oct. 31, 2023. For the convenience of the user, the revised text is set forth as follows:

§ 172.101 Purpose and use of the hazardous materials table.

* * * * *

§ 172.101 HAZARDOUS MATERIALS TABLE

Sym-bols (1)	Hazardous materials descriptions and proper shipping names (2)	Hazard class or division (3)	Identi-fication Nos. (4)	PG (5)	Label codes (6)	Special provisions (§ 172.102) (7)	(8)			(9)		(10)	
							Packaging (§ 173.***)			Quantity limitations (see §§ 173.27 and 175.75)		Vessel stow-age	
							Excep-tions (8A)	Non-bulk (8B)	Bulk (8C)	Passenger aircraft/rail (9A)	Cargo aircraft only (9B)	Loca-tion (10A)	Other (10B)
	* Methane, refrigerated liquid (<i>cryogenic liquid</i>) or Natural gas, re- frigerated liquid (<i>cryogenic liquid, with high methane content</i>) *	* 2.1 *	UN1972	* *	2.1	* T75, TP5, 439, 440 *	* None *	None	* 318, 319 *	* Forbidden *	Forbidden	D	40

* * * * *

§ 172.101, NH.

49 CFR Ch. I (10-1-23 Edition)

§ 172.102 Special provisions.

(a) *General.* When column 7 of the §172.101 table refers to a special provision for a hazardous material, the meaning and requirements of that provision are as set forth in this section. When a special provision specifies packaging or packaging requirements—

(1) The special provision is in addition to the standard requirements for all packagings prescribed in §173.24 of this subchapter and any other applicable packaging requirements in subparts A and B of part 173 of this subchapter; and

(2) To the extent a special provision imposes limitations or additional requirements on the packaging provisions set forth in column 8 of the §172.101 table, packagings must conform to the requirements of the special provision.

(b) *Description of codes for special provisions.* Special provisions contain packaging provisions, prohibitions, exceptions from requirements for particular quantities or forms of materials and requirements or prohibitions applicable to specific modes of transportation, as follows:

(1) A code consisting only of numbers (for example, “11”) is multi-modal in application and may apply to bulk and non-bulk packagings.

(2) A code containing the letter “A” refers to a special provision which applies only to transportation by aircraft.

(3) A code containing the letter “B” refers to a special provision that applies only to bulk packaging requirements. Unless otherwise provided in this subchapter, these special provisions do not apply to UN, IM Specification portable tanks or IBCs.

(4) A code containing the letters “IB” or “IP” refers to a special provision that applies only to transportation in IBCs.

(5) A code containing the letter “N” refers to a special provision which applies only to non-bulk packaging requirements.

(6) A code containing the letter “R” refers to a special provision which applies only to transportation by rail.

(7) A code containing the letter “T” refers to a special provision which ap-

plies only to transportation in UN or IM Specification portable tanks.

(8) A code containing the letters “TP” refers to a portable tank special provision for UN or IM Specification portable tanks that is in addition to those provided by the portable tank instructions or the requirements in part 178 of this subchapter.

(9) A code containing the letter “W” refers to a special provision that applies only to transportation by water.

(c) *Tables of special provisions.* The following tables list, and set forth the requirements of, the special provisions referred to in column 7 of the §172.101 table.

(1) *Numeric provisions.* These provisions are multi-modal and apply to bulk and non-bulk packagings:

Code/Special Provisions

- 1 This material is poisonous by inhalation (see §171.8 of this subchapter) in Hazard Zone A (see §173.116(a) or §173.133(a) of this subchapter), and must be described as an inhalation hazard under the provisions of this subchapter.
- 2 This material is poisonous by inhalation (see §171.8 of this subchapter) in Hazard Zone B (see §173.116(a) or §173.133(a) of this subchapter), and must be described as an inhalation hazard under the provisions of this subchapter.
- 3 This material is poisonous by inhalation (see §171.8 of this subchapter) in Hazard Zone C (see §173.116(a) of this subchapter), and must be described as an inhalation hazard under the provisions of this subchapter.
- 4 This material is poisonous by inhalation (see §171.8 of this subchapter) in Hazard Zone D (see §173.116(a) of this subchapter), and must be described as an inhalation hazard under the provisions of this subchapter.
- 5 If this material meets the definition for a material poisonous by inhalation (see §171.8 of this subchapter), a shipping name must be selected which identifies the inhalation hazard, in Division 2.3 or Division 6.1, as appropriate.
- 6 This material is poisonous-by-inhalation and must be described as an inhalation hazard under the provisions of this subchapter.
- 8 A hazardous substance that is not a hazardous waste may be shipped under the shipping description “Other regulated substances, liquid or solid, n.o.s.”, as appropriate. In addition, for solid materials, special provision B54 applies.

§ 172.102

49 CFR Ch. I (10–1–23 Edition)

- 9 Packaging for certain PCBs for disposal and storage is prescribed by EPA in 40 CFR 761.60 and 761.65.
- 11 The hazardous material must be packaged as either a liquid or a solid, as appropriate, depending on its physical form at 55 °C (131 °F) at atmospheric pressure.
- 12 In concentrations greater than 40 percent, this material has strong oxidizing properties and is capable of starting fires in contact with combustible materials. If appropriate, a package containing this material must conform to the additional labeling requirements of §172.402 of this subchapter.
- 13 The words “Inhalation Hazard” shall be entered on each shipping paper in association with the shipping description, shall be marked on each non-bulk package in association with the proper shipping name and identification number, and shall be marked on two opposing sides of each bulk package. Size of marking on bulk package must conform to §172.302(b) of this subchapter. The requirements of §§172.203(m) and 172.505 of this subchapter do not apply.
- 14 Motor fuel antiknock mixtures are:
 - a. Mixtures of one or more organic lead mixtures (such as tetraethyl lead, triethylmethyl lead, diethyldimethyl lead, ethyltrimethyl lead, and tetramethyl lead) with one or more halogen compounds (such as ethylene dibromide and ethylene dichloride), hydrocarbon solvents or other equally efficient stabilizers; or
 - b. tetraethyl lead.
- 15 This entry applies to “Chemical kits” and “First aid kits” containing one or more compatible items of hazardous materials in boxes, cases, *etc.* that, for example, are used for medical, analytical, diagnostic, testing, or repair purposes. Kits that are carried on board transport vehicles for first aid or operating purposes are not subject to the requirements of this subchapter.
- 16 This description applies to smokeless powder and other solid propellants that are used as powder for small arms and have been classed as Division 1.3C, 1.4C and Division 4.1 in accordance with §173.56 of this subchapter.
- 19 For domestic transportation only, the identification number “UN1075” may be used in place of the identification number specified in column (4) of the §172.101 table. The identification number used must be consistent on package markings, shipping papers and emergency response information.
- 21 This material must be stabilized by appropriate means (e.g., addition of chemical inhibitor, purging to remove oxygen) to prevent dangerous polymerization (see §173.21(f) of this subchapter).
- 22 If the hazardous material is in dispersion in organic liquid, the organic liquid must have a flash point above 50 °C (122 °F).
- 23 This material may be transported under the provisions of Division 4.1 only if it is so packed that the percentage of diluent will not fall below that stated in the shipping description at any time during transport. Quantities of not more than 500 g per package with not less than 10 percent water by mass may also be classed in Division 4.1, provided a negative test result is obtained when tested in accordance with test series 6(c) of the UN Manual of Tests and Criteria (IBR, see §171.7 of this subchapter).
- 24 Alcoholic beverages containing more than 70 percent alcohol by volume must be transported as materials in Packing Group II. Alcoholic beverages containing more than 24 percent but not more than 70 percent alcohol by volume must be transported as materials in Packing Group III.
- 26 This entry does not include ammonium permanganate, the transport of which is prohibited except when approved by the Associate Administrator.
- 28 The dihydrated sodium salt of dichloroisocyanuric acid does not meet the criteria for inclusion in Division 5.1 (Oxidizer) and is not subject to the requirements of this subchapter unless meeting the criteria for inclusion in another class or division.
- 30 Sulfur is not subject to the requirements of this subchapter if transported in a non-bulk packaging or if formed to a specific shape (for example, prills, granules, pellets, pastilles, or flakes). A bulk packaging containing sulfur is not subject to the placarding requirements of subpart F of this part, if it is marked with the appropriate identification number as required by subpart D of this part. Molten sulfur must be marked as required by §172.325 of this subchapter.
- 31 Materials which have undergone sufficient heat treatment to render them non-hazardous are not subject to the requirements of this subchapter.
- 32 Polymeric beads and molding compounds may be made from polystyrene, poly(methyl methacrylate) or other polymeric material.
- 33 Ammonium nitrites and mixtures of an inorganic nitrite with an ammonium salt are prohibited.
- 34 The commercial grade of calcium nitrate fertilizer, when consisting mainly of a double salt (calcium nitrate and ammonium nitrate) containing not more than 10 percent ammonium nitrate and at least 12 percent water of crystallization, is not subject to the requirements of this subchapter.
- 35 Antimony sulphides and oxides which do not contain more than 0.5 percent of arsenic calculated on the total mass do not meet the definition of Division 6.1.

- 37 Unless it can be demonstrated by testing that the sensitivity of the substance in its frozen state is no greater than in its liquid state, the substance must remain liquid during normal transport conditions. It must not freeze at temperatures above -15°C (5°F).
- 38 If this material shows a violent effect in laboratory tests involving heating under confinement, the labeling requirements of Special Provision 53 apply, and the material must be packaged in accordance with packing method OP6 in §173.225 of this subchapter. If the SADT of the technically pure substance is higher than 75°C , the technically pure substance and formulations derived from it are not self-reactive materials and, if not meeting any other hazard class, are not subject to the requirements of this subchapter.
- 39 This substance may be carried under provisions other than those of Class 1 only if it is so packed that the percentage of water will not fall below that stated at any time during transport. When phlegmatized with water and inorganic inert material, the content of urea nitrate must not exceed 75 percent by mass and the mixture should not be capable of being detonated by test 1(a)(i) or test 1(a)(ii) in the UN Manual of Tests and Criteria (IBR, see §171.7 of this subchapter).
- 40 Polyester resin kits consist of two components: A base material (either Class 3 or Division 4.1, Packing Group II or III) and an activator (organic peroxide), each separately packed in an inner packaging. The organic peroxide must be type D, E, or F, not requiring temperature control. The components may be placed in the same outer packaging provided they will not interact dangerously in the event of leakage. The Packing Group assigned will be II or III, according to the classification criteria for either Class 3 or Division 4.1, as appropriate, applied to the base material. Additionally, unless otherwise excepted in this subchapter, polyester resin kits must be packaged in specification combination packagings based on the performance level of the base material contained within the kit.
- 41 This material at the Packing Group II hazard criteria level may be transported in Large Packagings.
- 43 The membrane filters, including paper separators and coating or backing materials, that are present in transport, must not be able to propagate a detonation as tested by one of the tests described in the UN Manual of Tests and Criteria, Part I, Test series 1(a) (IBR, see §171.7 of this subchapter). On the basis of the results of suitable burning rate tests, and taking into account the standard tests in the UN Manual of Tests and Criteria, Part III, subsection 33.2.1 (IBR, see §171.7 of this subchapter), nitrocellulose membrane filters in the form in which they are to be transported that do not meet the criteria for a Division 4.1 material are not subject to the requirements of this subchapter. Packagings must be so constructed that explosion is not possible by reason of increased internal pressure. Nitrocellulose membrane filters covered by this entry, each with a mass not exceeding 0.5 g, are not subject to the requirements of this subchapter when contained individually in an article or a sealed packet.
- 44 The formulation must be prepared so that it remains homogenous and does not separate during transport. Formulations with low nitrocellulose contents and neither showing dangerous properties when tested for their ability to detonate, deflagrate or explode when heated under defined confinement by the appropriate test methods and criteria in the UN Manual of Tests and Criteria (IBR, see §171.7 of this subchapter), nor classed as a Division 4.1 (flammable solid) when tested in accordance with the procedures specified in §173.124 of this subchapter (chips, if necessary, crushed and sieved to a particle size of less than 1.25 mm), are not subject to the requirements of this subchapter.
- 45 Temperature should be maintained between 18°C (64.4°F) and 40°C (104°F). Tanks containing solidified methacrylic acid must not be reheated during transport.
- 46 This material must be packed in accordance with packing method OP6 (see §173.225 of this subchapter). During transport, it must be protected from direct sunshine and stored (or kept) in a cool and well-ventilated place, away from all sources of heat.
- 47 Mixtures of solids that are not subject to this subchapter and flammable liquids may be transported under this entry without first applying the classification criteria of Division 4.1, provided there is no free liquid visible at the time the material is loaded or at the time the packaging or transport unit is closed. Except when the liquids are fully absorbed in solid material contained in sealed bags, for single packagings, each packaging must correspond to a design type that has passed a leakproofness test at the Packing Group II level. Sealed packets and articles containing less than 10 mL of a Class 3 liquid in Packing Group II or III absorbed onto a solid material are not subject to this subchapter provided there is no free liquid in the packet or article.
- 48 Mixtures of solids that are not subject to this subchapter and toxic liquids may be transported under this entry without first applying the classification criteria of Division 6.1, provided there is no free liquid visible at the time the material is loaded or at the time the packaging or transport

- unit is closed. For single packagings, each packaging must correspond to a design type that has passed a leakproofness test at the Packing Group II level. This entry may not be used for solids containing a Packing Group I liquid.
- 49 Mixtures of solids that are not subject to this subchapter and corrosive liquids may be transported under this entry without first applying the classification criteria of Class 8, provided there is no free liquid visible at the time the material is loaded or at the time the packaging or transport unit is closed. For single packagings, each packaging must correspond to a design type that has passed a leakproofness test at the Packing Group II level.
- 50 Cases, cartridge, empty with primer which are made of metallic or plastic casings and meeting the classification criteria of Division 1.4 are not regulated for domestic transportation.
- 51 This description applies to items previously described as “Toy propellant devices, Class C” and includes reloadable kits. Model rocket motors containing 30 grams or less propellant are classed as Division 1.4S and items containing more than 30 grams of propellant but not more than 62.5 grams of propellant are classed as Division 1.4C.
- 52 This entry may only be used for substances that are too insensitive for acceptance into Class 1 (explosive) when tested in accordance with Test Series 2 in the UN Manual of Tests and Criteria, Part I (incorporated by reference; see §171.7 of this subchapter).
- 53 Packages of these materials must bear the subsidiary risk label, “EXPLOSIVE”, and the subsidiary hazard class/division must be entered in parentheses immediately following the primary hazard class in the shipping description, unless otherwise provided in this subchapter or through an approval issued by the Associate Administrator, or the competent authority of the country of origin. A copy of the approval shall accompany the shipping papers.
- 54 Maneb or maneb preparations not meeting the definition of Division 4.3 or any other hazard class are not subject to the requirements of this subchapter when transported by motor vehicle, rail car, or aircraft.
- 55 This device must be approved in accordance with §173.56 of this subchapter by the Associate Administrator.
- 56 A means to interrupt and prevent detonation of the detonator from initiating the detonating cord must be installed between each electric detonator and the detonating cord ends of the jet perforating guns before the charged jet perforating guns are offered for transportation.
- 57 Maneb or Maneb preparations stabilized against self-heating need not be classified in Division 4.2 when it can be demonstrated by testing that a volume of 1 m³ of substance does not self-ignite and that the temperature at the center of the sample does not exceed 200 °C, when the sample is maintained at a temperature of not less than 75 °C ±2 °C for a period of 24 hours, in accordance with procedures set forth for testing self-heating materials in the UN Manual of Tests and Criteria (IBR, see §171.7 of this subchapter).
- 58 Aqueous solutions of Division 5.1 inorganic solid nitrate substances are considered as not meeting the criteria of Division 5.1 if the concentration of the substances in solution at the minimum temperature encountered in transport is not greater than 80% of the saturation limit.
- 59 Ferrocium, stabilized against corrosion, with a minimum iron content of 10 percent is not subject to the requirements of this subchapter.
- 61 A chemical oxygen generator is spent if its means of ignition and all or a part of its chemical contents have been expended.
- 62 Oxygen generators (see §171.8 of this subchapter) are not authorized for transportation under this entry.
- 64 The group of alkali metals includes lithium, sodium, potassium, rubidium, and caesium.
- 65 The group of alkaline earth metals includes magnesium, calcium, strontium, and barium.
- 66 Formulations of these substances containing not less than 30 percent non-volatile, non-flammable phlegmatizer are not subject to this subchapter.
- 70 Black powder that has been classed in accordance with the requirements of §173.56 of this subchapter may be reclassified and offered for domestic transportation as a Division 4.1 material if it is offered for transportation and transported in accordance with the limitations and packaging requirements of §173.170 of this subchapter.
- 74 During transport, this material must be protected from direct sunshine and stored or kept in a cool and well-ventilated place, away from all sources of heat.
- 78 This entry may not be used to describe compressed air which contains more than 23.5 percent oxygen. Compressed air containing greater than 23.5 percent oxygen must be shipped using the description “Compressed gas, oxidizing, n.o.s., UN3156.”
- 79 This entry may not be used for mixtures that meet the definition for oxidizing gas.
- 81 Polychlorinated biphenyl items, as defined in 40 CFR 761.3, for which specification packagings are impractical, may be packaged in non-specification packagings meeting the general packaging requirements of subparts A and B of part 173 of

- this subchapter. Alternatively, the item itself may be used as a packaging if it meets the general packaging requirements of subparts A and B of part 173 of this subchapter.
- 101 The name of the particular substance or article must be specified.
- 102 The ends of the detonating cord must be tied fast so that the explosive cannot escape. The articles may be transported as in Division 1.4 Compatibility Group D (1.4D) if all of the conditions specified in §173.63(a) of this subchapter are met.
- 105 The word "Agents" may be used instead of "Explosives" when approved by the Associate Administrator.
- 106 The recognized name of the particular explosive may be specified in addition to the type.
- 107 The classification of the substance is expected to vary especially with the particle size and packaging but the border lines have not been experimentally determined; appropriate classifications should be verified following the test procedures in §§173.57 and 173.58 of this subchapter.
- 108 Fireworks must be so constructed and packaged that loose pyrotechnic composition will not be present in packages during transportation.
- 109 Rocket motors must be nonpropulsive in transportation unless approved in accordance with §173.56 of this subchapter. A rocket motor to be considered "nonpropulsive" must be capable of unrestrained burning and must not appreciably move in any direction when ignited by any means.
- 110 Fire extinguishers transported under UN1044 and oxygen cylinders transported for emergency use under UN1072 may include installed actuating cartridges (cartridges, power device of Division 1.4C or 1.4S), without changing the classification of Division 2.2, provided the aggregate quantity of deflagrating (propellant) explosives does not exceed 3.2 grams per cylinder. Oxygen cylinders with installed actuating cartridges as prepared for transportation must have an effective means of preventing inadvertent activation.
- 111 Explosive substances of Division 1.1 Compatibility Group A (1.1A) are forbidden for transportation if dry or not desensitized, unless incorporated in a device.
- 113 The sample must be given a tentative approval by an agency or laboratory in accordance with §173.56 of this subchapter.
- 114 Jet perforating guns, charged, oil well, without detonator may be reclassified to Division 1.4 Compatibility Group D (1.4D) if the following conditions are met:
- a. The total weight of the explosive contents of the shaped charges assembled in the guns does not exceed 90.5 kg (200 pounds) per vehicle; and
 - b. The guns are packaged in accordance with Packing Method US 1 as specified in §173.62 of this subchapter.
- 115 Boosters with detonator, detonator assemblies and boosters with detonators in which the total explosive charge per unit does not exceed 25 g, and which will not mass detonate and undergo only limited propagation in the shipping package may be assigned to 1.4B classification code. Mass detonate means more than 90 percent of the devices tested in a package explode practically simultaneously. Limited propagation means that if one booster near the center of the package is exploded, the aggregate weight of explosives, excluding ignition and delay charges, in this and all additional boosters in the outside packaging that explode may not exceed 25 g.
- 116 Fuzes, detonating may be classed in Division 1.4 if the fuzes do not contain more than 25 g of explosive per fuze and are made and packaged so that they will not cause functioning of other fuzes, explosives or other explosive devices if one of the fuzes detonates in a shipping packaging or in adjacent packages.
- 117 If shipment of the explosive substance is to take place at a time that freezing weather is anticipated, the water contained in the explosive substance must be mixed with denatured alcohol so that freezing will not occur.
- 118 This substance may not be transported under the provisions of Division 4.1 unless specifically authorized by the Associate Administrator (see UN0143 or UN0150 as appropriate).
- 119 This substance, when in quantities of not more than 11.5 kg (25.3 pounds), with not less than 10 percent water, by mass, also may be classed as Division 4.1, provided a negative test result is obtained when tested in accordance with test series 6(c) of the UN Manual of Tests and Criteria (IBR, see §171.7 of this subchapter).
- 120 The phlegmatized substance must be significantly less sensitive than dry PETN.
- 121 This substance, when containing less alcohol, water or phlegmatizer than specified, may not be transported unless approved by the Associate Administrator.
- 123 Any explosives, blasting, type C containing chlorates must be segregated from explosives containing ammonium nitrate or other ammonium salts.
- 125 Lactose or glucose or similar materials may be used as a phlegmatizer provided that the substance contains not less than 90%, by mass, of phlegmatizer. These mixtures may be classified in Division 4.1 when tested in accordance with test series 6(c) of the UN Manual of Tests and Criteria (IBR, see §171.7 of this subchapter) and approved by the Associate Administrator. Testing must be conducted on at least three packages as prepared for transport. Mixtures

containing at least 98%, by mass, of phlegmatizer are not subject to the requirements of this subchapter. Packages containing mixtures with not less than 90% by mass, of phlegmatizer need not bear a POISON subsidiary risk label.

127 Mixtures containing oxidizing and organic materials transported under this entry may not meet the definition and criteria of a Class 1 material. (See §173.50 of this subchapter.)

128 Regardless of the provisions of §172.101(c)(12), aluminum smelting by-products and aluminum remelting by-products described under this entry, meeting the definition of Class 8, Packing Group II and III may be classed as a Division 4.3 material and transported under this entry. The presence of a Class 8 hazard must be communicated as required by this part for subsidiary hazards.

129 These materials may not be classified and transported unless authorized by the Associate Administrator on the basis of results from Series 2 Test and a Series 6(c) Test from the UN Manual of Tests and Criteria (IBR, see §171.7 of this subchapter) on packages as prepared for transport. The packing group assignment and packaging must be approved by the Associate Administrator for Hazardous Materials Safety on the basis of the criteria in §173.21 of this subchapter and the package type used for the Series 6(c) test.

130 “Batteries, dry, sealed, n.o.s.,” commonly referred to as dry batteries, are hermetically sealed and generally utilize metals (other than lead) and/or carbon as electrodes. These batteries are typically used for portable power applications. The rechargeable (and some non-rechargeable) types have gelled alkaline electrolytes (rather than acidic) making it difficult for them to generate hydrogen or oxygen when overcharged and therefore, differentiating them from non-spillable batteries. Dry batteries specifically covered by another entry in the §172.101 Table must be transported in accordance with the requirements applicable to that entry. For example, nickel-metal hydride batteries transported by vessel in certain quantities are covered by another entry (*see* Batteries, nickel-metal hydride, UN3496). Dry batteries not specifically covered by another entry in the §172.101 Table are covered by this entry (*i.e.*, Batteries, dry, sealed, n.o.s.) and are not subject to requirements of this subchapter except for the following:

(a) *Incident reporting.* For transportation by aircraft, a telephone report in accordance with §171.15(a) is required if a fire, violent rupture, explosion or dangerous evolution of heat (*i.e.*, an amount of heat sufficient to be dangerous to packaging or personal safety to include charring of packaging, melting of packaging, scorch-

ing of packaging, or other evidence) occurs as a direct result of a dry battery. For all modes of transportation, a written report submitted, retained, and updated in accordance with §171.16 is required if a fire, violent rupture, explosion or dangerous evolution of heat occurs as a direct result of a dry battery or battery-powered device.

(b) *Preparation for transport.* Batteries and battery-powered device(s) containing batteries must be prepared and packaged for transport in a manner to prevent:

- (1) A dangerous evolution of heat;
- (2) Short circuits, including but not limited to the following methods:

(i) Packaging each battery or each battery-powered device when practicable, in fully enclosed inner packagings made of non-conductive material;

(ii) Separating or packaging batteries in a manner to prevent contact with other batteries, devices or conductive materials (*e.g.*, metal) in the packagings; or

(iii) Ensuring exposed terminals or connectors are protected with non-conductive caps, non-conductive tape, or by other appropriate means; and

(3) Damage to terminals. If not impact resistant, the outer packaging should not be used as the sole means of protecting the battery terminals from damage or short circuiting. Batteries must be securely cushioned and packed to prevent shifting which could loosen terminal caps or reorient the terminals to produce short circuits. Batteries contained in devices must be securely installed. Terminal protection methods include but are not limited to the following:

(i) Securely attaching covers of sufficient strength to protect the terminals;

(ii) Packaging the battery in a rigid plastic packaging; or

(iii) Constructing the battery with terminals that are recessed or otherwise protected so that the terminals will not be subjected to damage if the package is dropped.

(c) *Additional air transport requirements.* For a battery whose voltage (electrical potential) exceeds 9 volts—

(1) When contained in a device, the device must be packaged in a manner that prevents unintentional activation or must have an independent means of preventing unintentional activation (*e.g.*, packaging restricts access to activation switch, switch caps or locks, recessed switches, trigger locks, temperature sensitive circuit breakers, *etc.*); and

(2) An indication of compliance with this special provision must be provided by marking each package with the words “not restricted” or by including the words “not restricted” on a transport

document such as an air waybill accompanying the shipment.

- (d) *Used or spent battery exception.* Used or spent dry batteries of both non-rechargeable and rechargeable designs, with a marked rating up to 9-volt that are combined in the same package and transported by highway or rail for recycling, reconditioning, or disposal are not subject to this special provision or any other requirement of the HMR. Note that batteries utilizing different chemistries (*i.e.*, those battery chemistries specifically covered by another entry in the §172.101 Table) as well as dry batteries with a marked rating greater than 9-volt may not be combined with used or spent batteries in the same package. Note also that this exception does not apply to batteries that have been reconditioned for reuse.
- 131 This material may not be offered for transportation unless approved by the Associate Administrator.
- 132 This description may only be used for ammonium nitrate-based compound fertilizers. They must be classified in accordance with the procedure as set out in the Manual of Tests and Criteria, part III, section 39 (IBR, *see* §171.7 of this subchapter). Fertilizers meeting the criteria for this identification number are only subject to the requirements of this subchapter when offered for transportation and transported by air or vessel.
- 134 This entry applies only to vehicles powered by wet batteries, sodium batteries, lithium metal batteries or lithium ion batteries, and equipment powered by wet batteries or sodium batteries that are transported with these batteries installed. Lithium batteries installed in a cargo transport unit, designed only to provide power external to the transport unit must use the proper shipping name "Lithium batteries installed in cargo transport unit" found in the §172.101 Hazardous Materials Table.
- a. For the purpose of this special provision, vehicles are self-propelled apparatus designed to carry one or more persons or goods. Examples of such vehicles are electrically-powered cars, motorcycles, scooters, three- and four-wheeled vehicles or motorcycles, trucks, locomotives, bicycles (pedal cycles with an electric motor) and other vehicles of this type (*e.g.*, self-balancing vehicles or vehicles not equipped with at least one seating position), lawn tractors, self-propelled farming and construction equipment, boats, aircraft, wheelchairs and other mobility aids. This includes vehicles transported in a packaging. In this case, some parts of the vehicle may be detached from its frame to fit into the packaging.
- b. Examples of equipment are lawnmowers, cleaning machines, or model boats and model aircraft. Equipment powered by lithium metal batteries or lithium ion batteries must be described using the entries "Lithium metal batteries contained in equipment" or "Lithium metal batteries packed with equipment" or "Lithium ion batteries contained in equipment" or "Lithium ion batteries packed with equipment," as appropriate.
- c. Self-propelled vehicles or equipment that also contain an internal combustion engine must be described using the entries "Engine, internal combustion, flammable gas powered" or "Engine, internal combustion, flammable liquid powered" or "Vehicle, flammable gas powered" or "Vehicle, flammable liquid powered," as appropriate. These entries include hybrid electric vehicles powered by both an internal combustion engine and batteries. Additionally, self-propelled vehicles or equipment that contain a fuel cell engine must be described using the entries "Engine, fuel cell, flammable gas powered" or "Engine, fuel cell, flammable liquid powered" or "Vehicle, fuel cell, flammable gas powered" or "Vehicle, fuel cell, flammable liquid powered," as appropriate. These entries include hybrid electric vehicles powered by a fuel cell engine, an internal combustion engine, and batteries.
- 135 Internal combustion engines installed in a vehicle must be described using "Vehicle, flammable gas powered" or "Vehicle, flammable liquid powered," as appropriate. If a vehicle is powered by a flammable liquid and a flammable gas internal combustion engine, it must be described using "Vehicle, flammable gas powered." This includes hybrid electric vehicles powered by both an internal combustion engine and wet, sodium or lithium batteries installed. If a fuel cell engine is installed in a vehicle, the vehicle must be described using "Vehicle, fuel cell, flammable gas powered" or "Vehicle, fuel cell, flammable liquid powered," as appropriate. This includes hybrid electric vehicles powered by a fuel cell, an internal combustion engine, and wet, sodium or lithium batteries installed. For the purpose of this special provision, vehicles are self-propelled apparatus designed to carry one or more persons or goods. Examples of such vehicles are cars, motorcycles, trucks, locomotives, scooters, three- and four-wheeled vehicles or motorcycles, lawn tractors, self-propelled farming and construction equipment, boats, and aircraft. Furthermore, lithium batteries installed in a cargo transport unit, designed only to provide power external to the transport unit must be described using the proper shipping name "Lithium batteries installed in cargo transport unit"

found in the §172.101 Hazardous Materials Table.

- 136 This entry applies only to articles, machinery, and apparatus containing hazardous materials as an integral element of the article, machinery, or apparatus. It may not be used to describe articles, machinery, or apparatus for which a proper shipping name exists in the §172.101 Table. Except when approved by the Associate Administrator, these items may only contain hazardous materials for which exceptions are referenced in Column (8) of the §172.101 Table and are provided in part 173, subparts D and G, of this subchapter. Hazardous materials shipped under this entry are excepted from the labeling requirements of this subchapter unless offered for transportation or transported by aircraft and are not subject to the placarding requirements of subpart F of this part. Orientation markings as described in §172.312(a)(2) are required when liquid hazardous materials may escape due to incorrect orientation. The article, machinery, or apparatus, if unpackaged, or the packaging in which it is contained shall be marked “Dangerous goods in articles” or “Dangerous goods in machinery” or “Dangerous goods in apparatus” as appropriate, with the identification number UN3363. For transportation by aircraft, articles, machinery, or apparatus, may not contain any material forbidden for transportation by passenger or cargo aircraft. The Associate Administrator may except from the requirements of this subchapter articles, machinery, and apparatus provided:
- It is shown that it does not pose a significant risk in transportation;
 - The quantities of hazardous materials do not exceed those specified in §173.4a of this subchapter; and
 - The equipment, and machinery or apparatus articles conforms with §173.222 of this subchapter.
- 137 Cotton, dry; flax, dry; sisal, dry; and tampico fiber, dry are not subject to the requirements of this subchapter when they are baled in accordance with ISO 8115, “Cotton Bales—Dimensions and Density” (IBR, see §171.7 of this subchapter) to a density of not less than 360 kg/m³ (22.1 lb/ft³) for cotton, 400 kg/m³ (24.97 lb/ft³) for flax, 620 kg/m³ (38.71 lb/ft³) for sisal and 360 kg/m³ (22.1 lb/ft³) for tampico fiber and transported in a freight container or closed transport vehicle.
- 138 This entry applies to lead compounds which, when mixed in a ratio of 1:1,000 with 0.07 M (Molar concentration) hydrochloric acid and stirred for one hour at a temperature of 23 °C ±2 °C, exhibit a solubility of more than 5%. Lead compounds which, when mixed in a ratio of 1:1,000 with 0.07 M (Molar concentration) hydrochloric acid and stirred for one hour at a temperature

of 23 °C ±2 °C, exhibit a solubility of 5% or less are not subject to the requirements of this subchapter unless they meet criteria as another hazard class or division. Lead compounds that have a solubility of 5% or less in accordance with this special provision are not subject to the requirements of this subchapter that pertain to Marine Pollutants.

- 139 Use of the “special arrangement” proper shipping names for international shipments must be made under an IAEA Certificate of Competent Authority issued by the Associate Administrator in accordance with the requirements in §173.471, §173.472, or §173.473 of this subchapter. Use of these proper shipping names for domestic shipments may be made only under a DOT special permit, as defined in, and in accordance with the requirements of subpart B of part 107 of this subchapter.
- 140 This material is regulated only when it meets the defining criteria for a hazardous substance or a marine pollutant. In addition, the column 5 reference is modified to read “III” on those occasions when this material is offered for transportation or transported by highway or rail.
- 141 A toxin obtained from a plant, animal, or bacterial source containing an infectious substance, or a toxin contained in an infectious substance, must be classed as Division 6.2, described as an infectious substance, and assigned to UN 2814 or UN 2900, as appropriate.
- 142 These hazardous materials may not be classified and transported unless authorized by the Associate Administrator. The Associate Administrator will base the authorization on results from Series 2 tests and a Series 6(c) test from the UN Manual of Tests and Criteria (IBR, see §171.7 of this subchapter) on packages as prepared for transport in accordance with the requirements of this subchapter.
- 144 If transported as a residue in an underground storage tank (UST), as defined in 40 CFR 280.12, that has been cleaned and purged or rendered inert according to the American Petroleum Institute (API) Standard 1604 (IBR, see §171.7 of this subchapter), then the tank and this material are not subject to any other requirements of this subchapter. However, sediments remaining in the tank that meet the definition for a hazardous material are subject to the applicable regulations of this subchapter.
- 145 This entry applies to formulations that neither detonate in the cavitated state nor deflagrate in laboratory testing, show no effect when heated under confinement, exhibit no explosive power, and are thermally stable (self-accelerating decomposition temperature (SADT) at 60 °C (140 °F) or higher for a 50 kg (110.2 lbs.) package). Formulations not meeting these criteria

must be transported under the provisions applicable to the appropriate entry in the Organic Peroxide Table in §173.225 of this subchapter.

- 146 This description may be used for a material that poses a hazard to the environment but does not meet the definition for a hazardous waste or a hazardous substance, as defined in §171.8 of this subchapter, or any hazard class, as defined in part 173 of this subchapter, if it is designated as environmentally hazardous by another Competent Authority. This provision may be used for both domestic and international shipments.
- 147 This entry applies to non-sensitized emulsions, suspensions, and gels consisting primarily of a mixture of ammonium nitrate and fuel, intended to produce a Type E blasting explosive only after further processing prior to use. The mixture for emulsions typically has the following composition: 60–85% ammonium nitrate; 5–30% water; 2–8% fuel; 0.5–4% emulsifier or thickening agent; 0–10% soluble flame suppressants; and trace additives. Other inorganic nitrate salts may replace part of the ammonium nitrate. The mixture for suspensions and gels typically has the following composition: 60–85% ammonium nitrate; 0–5% sodium or potassium perchlorate; 0–17% hexamine nitrate or monomethylamine nitrate; 5–30% water; 2–15% fuel; 0.5–4% thickening agent; 0–10% soluble flame suppressants; and trace additives. Other inorganic nitrate salts may replace part of the ammonium nitrate. These substances must satisfy the criteria for classification as an ammonium nitrate emulsion of Test Series 8 of the UN Manual of Tests and Criteria, Part I, Section 18 (IBR, see §171.7 of this subchapter), and may not be classified and transported unless approved by the Associate Administrator.
- 148 For domestic transportation, this entry directs to §173.66 for:
- The standards for transporting a single bulk hazardous material for blasting by cargo tank motor vehicles (CTMV); and
 - The standards for CTMVs capable of transporting multiple hazardous materials for blasting in bulk and non-bulk packagings (*i.e.*, a multipurpose bulk truck (MBT)).
- 149 When transported as a limited quantity or a consumer commodity, the maximum net capacity specified in §173.150(b)(2) of this subchapter for inner packagings may be increased to 5 L (1.3 gallons).
- 150 This description may only be used for ammonium nitrate-based fertilizers. They must be classified in accordance with the procedure as set out in the Manual of Tests and Criteria, part III, section 39 (IBR, see §171.7 of this subchapter).
- 151 If this material meets the definition of a flammable liquid in §173.120 of this subchapter, a FLAMMABLE LIQUID label is also required and the basic description on the shipping paper must indicate the Class 3 subsidiary hazard.
- 152 Fish meal, fish scrap and krill meal may not be transported if the temperature at the time of loading either exceeds 35 °C (95 °F), or exceeds 5 °C (41 °F) above the ambient temperature, whichever is higher.
- 153 Asbestos that is immersed or fixed in a natural or artificial binder material, such as cement, plastic, asphalt, resins or mineral ore, or contained in manufactured products is not subject to the requirements of this subchapter.
- 154 When transported as a limited quantity or a consumer commodity, the maximum net capacity specified in §173.151(b)(1)(i) of this subchapter for inner packagings may be increased to 5 kg (11 pounds).
- 155 This material must be protected from direct sunshine and kept in a cool, well-ventilated place away from sources of heat.
- 156 This entry applies to safety devices for vehicles, vessels or aircraft, *e.g.* air bag inflators, air bag modules, seat-belt pretensioners, and pyromechanical devices containing Class 1 (explosive) materials or materials of other hazard classes. These articles must be tested in accordance with Test series 6(c) of Part I of the UN Manual of Tests and Criteria (incorporated by reference; see §171.7 of this subchapter), with no explosion of the device, no fragmentation of device casing or pressure vessel, and no projection hazard or thermal effect that would significantly hinder fire-fighting or other emergency response efforts in the immediate vicinity. If the air bag inflator unit satisfactorily passes the series 6(c) test, it is not necessary to repeat the test on the air bag module. This entry does not apply to life saving appliances described in §173.219 (UN2990 and UN3072).
- 157 This material may be transported under the provisions of Division 4.1 only if it is packed so that at no time during transport will the percentage of diluent fall below the percentage that is stated in the shipping description.
- 158 Substances must satisfactorily pass Test Series 8 of the UN Manual of Tests and Criteria, Part I, Section 18 (IBR, see §171.7 of this subchapter).
- 159 Substances must not be transported under this entry unless approved by the Associate Administrator on the basis of the results of appropriate tests according to Part I of the UN Manual of Tests and Criteria (IBR, see §171.7 of this subchapter). The material must be packaged so that the percentage of diluent does not fall below that stated in the approval at any time during transportation.

- 165 These substances are susceptible to exothermic decomposition at elevated temperatures. Decomposition can be initiated by heat, moisture or by impurities (e.g., powdered metals (iron, manganese, cobalt, magnesium)). During the course of transportation, these substances must be shaded from direct sunlight and all sources of heat and be placed in adequately ventilated areas.
- 166 When transported in non-friable tablet form, calcium hypochlorite, dry, may be transported as a Packing Group III material.
- 167 These storage systems must always be considered as containing hydrogen. A metal hydride storage system installed in or intended to be installed in a vehicle or equipment or in vehicle or equipment components must be approved for transport by the Associate Administrator. A copy of the approval must accompany each shipment.
- 168 For lighters containing a Division 2.1 gas (see §171.8 of this subchapter), representative samples of each new lighter design must be examined and successfully tested as specified in §173.308(b)(3). For criteria in determining what is a new lighter design, see §173.308(b)(1). For transportation of new lighter design samples for examination and testing, see §173.308(b)(2). The examination and testing of each lighter design must be performed by a person authorized by the Associate Administrator under the provisions of subpart E of part 107 of this chapter, as specified in §173.308(a)(4). For continued use of approvals dated prior to January 1, 2012, see §173.308(b)(5).
- For non-pressurized lighters containing a Class 3 (flammable liquid) material, its design, description, and packaging must be approved by the Associate Administrator prior to being offered for transportation or transported in commerce. In addition, a lighter design intended to contain a non-pressurized Class 3 material is excepted from the examination and testing criteria specified in §173.308(b)(3). An unused lighter or a lighter that is cleaned of residue and purged of vapors is not subject to the requirements of this subchapter.
- 169 This entry applies to lighter refills (see §171.8 of this subchapter) that contain a Division 2.1 (flammable) gas but do not contain an ignition device. Lighter refills offered for transportation under this entry may not exceed 4 fluid ounces capacity (7.22 cubic inches) or contain more than 65 grams of fuel. A lighter refill exceeding 4 fluid ounces capacity (7.22 cubic inches) or containing more than 65 grams of fuel must be classed as a Division 2.1 material, described with the proper shipping name appropriate for the material, and packaged in the packaging specified in part 173 of this subchapter for the flammable gas contained therein. In addition, a container exceeding 4 fluid ounces volumetric capacity (7.22 cubic inches) or containing more than 65 grams of fuel may not be connected or manifolded to a lighter or similar device and must also be described and packaged according to the fuel contained therein. For transportation by passenger-carrying aircraft, the net mass of lighter refills may not exceed 1 kg per package, and, for cargo-only aircraft, the net mass of lighter refills may not exceed 15 kg per package. See §173.306(h) of this subchapter.
- 170 Air must be eliminated from the vapor space by nitrogen or other means.
- 171 This entry may only be used when the material is transported in non-friable tablet form or for granular or powdered mixtures that have been shown to meet the PG III criteria in §173.127.
- 172 This entry includes alcohol mixtures containing up to 5% petroleum products.
- 173 For adhesives, printing inks, printing ink-related materials, paints, paint-related materials, and resin solutions which are assigned to UN3082, and do not meet the definition of another hazard class, metal or plastic packaging for substances of packing groups II and III in quantities of 5 L (1.3 gallons) or less per packaging are not required to meet the UN performance package testing when transported:
- Except for transportation by aircraft, in palletized loads, a pallet box or unit load device (e.g. individual packaging placed or stacked and secured by strapping, shrink or stretch-wrapping or other suitable means to a pallet). For vessel transport, the palletized loads, pallet boxes or unit load devices must be firmly packed and secured in closed cargo transport units; or
 - Except for transportation by aircraft, as an inner packaging of a combination packaging with a maximum net mass of 40 kg (88 pounds). For transportation by aircraft, as an inner packaging of a combination packaging with a maximum gross mass of 30 kg when packaged as a limited quantity in accordance with §173.27(f).
- 175 This substance must be stabilized when in concentrations of not more than 99%.
- 176 This entry must be used for formaldehyde solutions containing methanol as a stabilizer. Formaldehyde solutions not containing methanol and not meeting the Class 3 flammable liquid criteria must be described using a different proper shipping name.
- 177 Gasoline, or, ethanol and gasoline mixtures, for use in internal combustion engines (e.g., in automobiles, stationary engines and other engines) must be assigned to Packing Group II regardless of variations in volatility.

- 181 When a package contains a combination of lithium batteries contained in equipment and lithium batteries packed with equipment, the following requirements apply:
- a. The shipper must ensure that all applicable requirements of §173.185 of this subchapter are met. The total mass of lithium batteries contained in any package must not exceed the quantity limits in columns (9A) and (9B) for passenger aircraft or cargo aircraft, as applicable;
 - b. Except as provided in §173.185(c)(3) of this subchapter, the package must be marked "UN 3091 Lithium metal batteries packed with equipment", or "UN 3481 Lithium ion batteries packed with equipment," as appropriate. If a package contains both lithium metal batteries and lithium ion batteries packed with and contained in equipment, the package must be marked as required for both battery types. However, button cell batteries installed in equipment (including circuit boards) need not be considered; and
 - c. The shipping paper must indicate "UN 3091 Lithium metal batteries packed with equipment" or "UN 3481 Lithium ion batteries packed with equipment," as appropriate. If a package contains both lithium metal batteries and lithium ion batteries packed with and contained in equipment, then the shipping paper must indicate both "UN 3091 Lithium metal batteries packed with equipment" and "UN 3481 Lithium ion batteries packed with equipment."
- 182 Equipment containing only lithium batteries must be classified as either UN 3091 or UN 3481.
- 196 The nitrocellulose must meet the criteria of the Bergmann-Junk test or methyl violet paper test in the UN Manual of Tests and Criteria, Appendix 10 (IBR, *see* §171.7 of this subchapter). Test of type 3(c) is not required.
- 197 The nitrocellulose must meet the criteria of the Bergmann-Junk test or methyl violet paper test in the UN Manual of Tests and Criteria, Appendix 10 (IBR, *see* §171.7 of this subchapter).
- 198 Nitrocellulose solutions containing not more than 20% nitrocellulose may be transported as paint, perfumery products, or printing ink, as applicable, provided the nitrocellulose contains no more 12.6% nitrogen (by dry mass). *See* UN1210, UN1263, UN1266, UN3066, UN3469, and UN3470.
- 200 Division 1.4G consumer fireworks may be certified for transportation by a DOT-approved Fireworks Certification Agency in accordance with the provisions of §173.65 of this subchapter.
- 237 "Batteries, dry, containing potassium hydroxide solid, *electric storage*" must be prepared and packaged in accordance with the requirements of §173.159(a) and (c). For transportation by aircraft, the provisions of §173.159(b)(2) apply. This entry may only be used for the transport of non-activated batteries that contain dry potassium hydroxide and that are intended to be activated prior to use by the addition of an appropriate amount of water to the individual cells.
- 238 Neutron radiation detectors: Neutron radiation detectors containing non-pressurized boron trifluoride gas in excess of 1 gram (0.035 ounces) and radiation detection systems containing such neutron radiation detectors as components may be transported by highway, rail, vessel, or cargo aircraft in accordance with the following:
- a. Each radiation detector must meet the following conditions:
 - (1) The pressure in each neutron radiation detector must not exceed 105 kPa absolute at 20 °C (68 °F);
 - (2) The amount of gas must not exceed 13 grams (0.45 ounces) per detector; and
 - (3) Each neutron radiation detector must be of welded metal construction with brazed metal to ceramic feed through assemblies. These detectors must have a minimum burst pressure of 1800 kPa as demonstrated by design type qualification testing; and
 - (4) Each detector must be tested to a 1×10^{-10} cm³/s leaktightness standard before filling.
 - b. Radiation detectors transported as individual components must be transported as follows:
 - (1) They must be packed in a sealed intermediate plastic liner with sufficient absorbent or adsorbent material to absorb or adsorb the entire gas contents.
 - (2) They must be packed in strong outer packagings and the completed package must be capable of withstanding a 1.8 meter (5.9 feet) drop without leakage of gas contents from detectors.
 - (3) The total amount of gas from all detectors per outer packaging must not exceed 52 grams (1.83 ounces).
 - c. Completed neutron radiation detection systems containing detectors meeting the conditions of paragraph a of this special provision must be transported as follows:
 - (1) The detectors must be contained in a strong sealed outer casing;
 - (2) The casing must contain sufficient absorbent or adsorbent material to absorb or adsorb the entire gas contents;
 - (3) The completed system must be packed in strong outer packagings capable of withstanding a 1.8 meter (5.9 feet) drop test without leakage unless a system's outer casing affords equivalent protection.

- d. Except for transportation by aircraft, neutron radiation detectors and radiation detection systems containing such detectors transported in accordance with paragraph a of this special provision are not subject to the labeling and placarding requirements of part 172 of this subchapter.
- e. When transported by highway, rail, vessel, or as cargo on an aircraft, neutron radiation detectors containing not more than 1 gram of boron trifluoride, including those with solder glass joints are not subject to any other requirements of this subchapter provided they meet the requirements in paragraph a of this special provision and are packed in accordance with paragraph b of this special provision. Radiation detection systems containing such detectors are not subject to any other requirements of this subchapter provided they are packed in accordance with paragraph c of this special provision.
- 325 In the case of non-fissile or fissile-accepted uranium hexafluoride, the material must be classified under UN 2978.
- 328 When lithium metal or lithium ion batteries are contained in the fuel cell system, the item must be described under this entry and the appropriate entries for "Lithium metal batteries contained in equipment" or "Lithium ion batteries contained in equipment".
- 332 Magnesium nitrate hexahydrate is not subject to the requirements of this subchapter.
- 335 Mixtures of solids that are not subject to this subchapter and environmentally hazardous liquids or solids may be classified as "Environmentally hazardous substances, solid, n.o.s." UN3077 and may be transported under this entry, provided there is no free liquid visible at the time the material is loaded or at the time the packaging or transport unit is closed. Each transport unit must be leakproof when used as bulk packaging.
- 336 The use of UN1H1 drums, UN3H1 jerricans, and UN6HA1 composite packagings which meet the requirements of part 178 of the HMR at the Packing Group I or II performance level. These packagings are not required to: (1.) meet the venting requirements in §173.24(g) or (2.) be marked with the hydrostatic pressure test marking specified in §173.24a(b)(4). Shipment of packages under this special provision must be made by private or contract motor carrier. Transportation of these packages also requires the door of each van trailer to be marked with "Warning trailer may contain chemical vapor. Do not enter until vapors have dissipated." The driver of the transport vehicle and the consignee(s) must be trained not to enter the transport vehicle until the ammonia vapors have dissipated, and the emergency response information on the shipping paper must indicate that the vehicle contains ammonia vapors. This training must be documented in training records required by §172.704(d). Transport vehicles must be vented to prevent accumulation of vapors at a poisonous or flammable concentration.
- 337 Authorizes the use of regulated waste containers manufactured prior to October 1, 2006 to be marked with the alternative shipping name of Regulated medical waste, UN3291 and arrows that deviate as prescribed in §172.312(a)(2) in that they may be black or white.
- 338 Life Saving appliances, self-inflating transported by motor vehicle only between an U.S. Coast Guard approved inflatable life raft servicing facility and a vessel are only subject to the following requirements:
- Prior to repacking into the life-saving appliance, an installed inflation cylinder must successfully meet and pass all inspection and test criteria and standards of the raft manufacturer and the vessel Flag State requirements for cylinders installed as part of life-saving appliances, self-inflating (UN2990) used on marine vessels. Additionally, each cylinder must be visually inspected in accordance with CGA pamphlet, CGA C-6 (incorporated by reference, see §171.7). A current copy of CGA pamphlet, CGA C-6 must be available at the facility servicing the life-saving appliance.
 - An installed inflation cylinder that requires recharging must be filled in accordance with §173.301(1).
 - Every installed inflation cylinder, as associated equipment of the life-saving appliance, must be packed within the protective packaging of the life raft and the life raft itself must otherwise be in compliance with §173.219.
 - The serial number for each cylinder must be recorded as part of the life-saving appliance service record by the U.S. Coast Guard-approved servicing facility.
- 340 This entry applies only to the vessel transportation of nickel-metal hydride batteries as cargo. Nickel-metal hydride button cells or nickel-metal hydride cells or batteries packed with or contained in battery-powered devices transported by vessel are not subject to the requirements of this special provision. See "Batteries, dry, sealed, n.o.s." in the §172.101 Hazardous Materials Table (HMT) of this part for transportation requirements for nickel-metal hydride batteries transported by other modes and for nickel-metal hydride button cells or nickel-metal hydride cells or batteries packed with or contained in battery-powered devices transported by vessel. Nickel-metal hydride batteries subject to this special provision are subject only to the following requirements: (1) The

batteries must be prepared and packaged for transport in a manner to prevent a dangerous evolution of heat, short circuits, and damage to terminals; and are subject to the incident reporting in accordance with §171.16 of this subchapter if a fire, violent rupture, explosion or dangerous evolution of heat (*i.e.*, an amount of heat sufficient to be dangerous to packaging or personal safety to include charring of packaging, melting of packaging, scorching of packaging, or other evidence) occurs as a direct result of a nickel metal hydride battery; and (2) when loaded in a cargo transport unit in a total quantity of 100 kg gross mass or more, the shipping paper requirements of Subpart C of this part, the manifest requirements of §176.30 of this subchapter, and the vessel stowage requirements assigned to this entry in Column (10) of the §172.101 Hazardous Materials Table.

342 Glass inner packagings (such as ampoules or capsules) intended only for use in sterilization devices, when containing less than 30 mL of ethylene oxide per inner packaging with not more than 300 mL per outer packaging, may be transported in accordance with §173.4a of this subchapter, irrespective of the restriction of §173.4a(b) and the indication of "forbidden" in columns (9A) and (9B) of the §172.101 table provided that:

- a. After filling, each glass inner packaging must be determined to be leak-tight by placing the glass inner packaging in a hot water bath at a temperature and for a period of time sufficient to ensure that an internal pressure equal to the vapor pressure of ethylene oxide at 55 °C is achieved. Any glass inner packaging showing evidence of leakage, distortion or other defect under this test must not be transported under the terms of this special provision;
- b. In addition to the packaging required in §173.4a, each glass inner packaging must be placed in a sealed plastic bag compatible with ethylene oxide and capable of containing the contents in the event of breakage or leakage of the glass inner packaging; and
- c. Each glass inner packaging is protected by a means of preventing puncture of the plastic bag (*e.g.*, sleeves or cushioning) in the event of damage to the packaging (*e.g.*, by crushing).

343 A bulk packaging that emits hydrogen sulfide in sufficient concentration that vapors evolved from the sour crude oil can present an inhalation hazard must be marked as specified in §172.327.

345 "Nitrogen, refrigerated liquid (*cryogenic liquid*), UN1977" transported in open cryogenic receptacles with a maximum capacity of 1 L are not subject to the requirements of this subchapter. The receptacles

must be constructed with glass double walls having the space between the walls vacuum insulated and each receptacle must be transported in an outer packaging with sufficient cushioning and absorbent materials to protect the receptacle from damage.

346 "Nitrogen, refrigerated liquid (*cryogenic liquid*), UN1977" transported in accordance with the requirements for open cryogenic receptacles in §173.320 and this special provision are not subject to any other requirements of this subchapter. The receptacle must contain no hazardous materials other than the liquid nitrogen which must be fully absorbed in a porous material in the receptacle.

347 Effective July 1, 2011, for transportation by aircraft, this entry may only be used if the results of Test series 6(d) of Part I of the UN Manual of Tests and Criteria (IBR, *see* §171.7 of this subchapter) have demonstrated that any hazardous effects from accidental functioning are confined to within the package. Effective January 1, 2012, for transportation by vessel, this entry may only be used if the results of Test Series 6(d) of Part I of the UN Manual of Tests and Criteria (IBR, *see* §171.7 of this subchapter) have demonstrated that any hazardous effects from accidental functioning are confined to within the package. Effective January 1, 2014, for transportation domestically by highway or rail, this entry may only be used if the results of Test Series 6(d) of Part I of the UN Manual of Tests and Criteria (IBR, *see* §171.7 of this subchapter) have demonstrated that any hazardous effects from accidental functioning are confined to within the package. Testing must be performed or witnessed by a person who is approved by the Associate Administrator (*see* §173.56(b) of this subchapter). All successfully conducted tests or reassignment to another compatibility group require the issuance of a new or revised approval by the Associate Administrator prior to transportation on or after the dates specified for each authorized mode of transport in this special provision.

349 Mixtures of hypochlorite with an ammonium salt are forbidden for transport. A hypochlorite solution, UN1791, is a Class 8 corrosive material.

350 Ammonium bromate, ammonium bromate aqueous solutions, and mixtures of a bromate with an ammonium salt are forbidden for transport.

351 Ammonium chlorate, ammonium chlorate aqueous solutions, and mixtures of a chlorate with an ammonium salt are forbidden for transport.

352 Ammonium chlorite, ammonium chlorite aqueous solutions, and mixtures of a chlorite with an ammonium salt are forbidden for transport.

§ 172.102

49 CFR Ch. I (10–1–23 Edition)

353 Ammonium permanganate, ammonium permanganate aqueous solutions, and mixtures of a permanganate with an ammonium salt are forbidden for transport.

357 A bulk packaging that emits hydrogen sulfide in sufficient concentration that vapors evolved from the crude oil can present an inhalation hazard must be marked as specified in §172.327 of this part.

360 Vehicles powered only by lithium batteries must be described using “UN3171, Battery-powered vehicle.” Lithium batteries installed in a cargo transport unit, designed only to provide power external to the transport unit, must be described using “UN3536, Lithium batteries installed in a cargo transport unit.”

361 Capacitors with an energy storage capacity of 0.3 Wh or less are not subject to the requirements of this subchapter. Energy storage capacity means the energy held by a capacitor, as calculated using the nominal voltage and capacitance. This entry does not apply to capacitors that by design maintain a terminal voltage (e.g., asymmetrical capacitors.)

362 This entry applies to liquids, pastes or powders, pressurized with a propellant that meets the definition of a gas in §173.115. A chemical under pressure packaged in an aerosol dispenser must be transported under UN1950. The chemical under pressure must be classed based on the hazard characteristics of the components in the propellant; the liquid; or the solid. The following provisions also apply:

a. If one of the components, which can be a pure substance or a mixture, is classed as flammable, the chemical under pressure must be classed as flammable in Division 2.1. Flammable components are flammable liquids and liquid mixtures, flammable solids and solid mixtures or flammable gases and gas mixtures meeting the following criteria:

- (1) A flammable liquid is a liquid having a flashpoint of not more than 93 °C (200 °F);
- (2) A flammable solid is a solid that meets the criteria in §173.124 of this subchapter; or
- (3) A flammable gas is a gas that meets the criteria in §173.115 of this subchapter.

b. Gases of Division 2.3 and gases with a subsidiary risk of 5.1 must not be used as a propellant in a chemical under pressure.

c. Where the liquid or solid components are classed as Division 6.1, Packing Group II or III, or Class 8, Packing Group II or III, the chemical under pressure must be assigned a subsidiary risk of Division 6.1 or Class 8 and the appropriate identification number must be assigned. Components classed as Division 6.1, Packing Group I, or Class 8, Packing Group I, must not be offered for transportation and transported under this description.

d. A chemical under pressure with components meeting the properties of: Class 1 (explosives); Class 3 (liquid desensitized explosives); Division 4.1 (self-reactive substances and solid desensitized explosives); Division 4.2 (substances liable to spontaneous combustion); Division 4.3 (substances which, in contact with water, emit flammable gases or toxic gases); Division 5.1 (oxidizing substances); Division 5.2 (organic peroxides); Division 6.2 (Infectious substances); or, Class 7 (Radioactive material), must not be offered for transportation under this description.

e. A description to which special provision 170 or TP7 is assigned in Column 7 of the §172.101 Hazardous Materials Table, and therefore requires air to be eliminated from the package vapor space by nitrogen or other means, must not be offered for transportation under this description.

f. Chemicals under pressure containing components forbidden for transport on both passenger and cargo aircraft in Columns (9A) and (9B) of the §172.101 Hazardous Materials Table must not be transported by air.

365 For manufactured instruments and articles containing mercury, see UN3506.

367 For the purposes of documentation and package marking:

a. The proper shipping name “Paint related material” may be used for consignments of packages containing “Paint” and “Paint related material” in the same package;

b. The proper shipping name “Paint related material, corrosive, flammable” may be used for consignments of packages containing “Paint, corrosive, flammable” and “Paint related material, corrosive, flammable” in the same package;

c. The proper shipping name “Paint related material, flammable, corrosive” may be used for consignments of packages containing “Paint, flammable, corrosive” and “Paint related material, flammable, corrosive” in the same package; and

d. The proper shipping name “Printing ink related material” may be used for consignments of packages containing “Printing ink” and “Printing ink related material” in the same package.

368 In the case of non-fissile or fissile-accepted uranium hexafluoride, the material must be classified under UN3507 or UN2978.

369 In the case of non-fissile or fissile-accepted uranium hexafluoride, the material must be classified under UN 2978. Uranium hexafluoride may be classified under this entry only if the conditions of §§173.420(a)(4) and (6) and (d) and 173.421(b) and (d) of this subchapter, and, for fissile-accepted material, the conditions of §173.453 of this subchapter are met. In addition to the provisions applicable to the

transport of Division 6.1 substances, the provisions of §§173.421(c) and 173.443(a) of this subchapter apply. In addition, packages shall be legibly and durably marked with an identification of the consignor, the consignee, or both. No Class 7 label is required to be displayed. The consignor shall be in possession of a copy of each applicable certificate when packages include fissile material excepted by competent authority approval. When a consignment is undeliverable, the consignment shall be placed in a safe location and the appropriate competent authority shall be informed as soon as possible and a request made for instructions on further action. If it is evident that a package of radioactive material, or conveyance carrying unpackaged radioactive material, is leaking, or if it is suspected that the package, or conveyance carrying unpackaged material, may have leaked, the requirements of §173.443(e) of this subchapter apply.

370 This entry also applies to ammonium nitrate with not more than 0.2% combustible substances, including any organic substance calculated as carbon, to the exclusion of any added substance, that gives a positive result when tested in accordance with Test Series 2 of the UN Manual of Tests and Criteria, Part I (IBR; see §171.7 of this subchapter). *See also* UN1942 in the §172.101 Hazardous Materials Table. This entry may not be used for ammonium nitrate for which a proper shipping name already exists in the §172.101 Hazardous Materials Table, including ammonium nitrate mixed with fuel oil or any other commercial grade of ammonium nitrate (*e.g.*, ammonium nitrate fertilizer).

371 a. This entry also applies to articles not conforming to the requirements of §§173.302, 173.304, or 173.306 of this subchapter, containing a small pressure receptacle with a release device. Such articles must comply with the following requirements:

- (1) The water capacity of the pressure receptacle must not exceed 0.5 L and the working pressure must not exceed 25 bar at 15 °C (59 °F);
- (2) The minimum burst pressure of the pressure receptacle must be at least four times the pressure of the gas at 15 °C (59 °F);
- (3) Each article must be manufactured in such a way that unintentional firing or release is avoided under normal conditions of handling, packing, transport and use. This may be fulfilled by an additional locking device linked to the activator;
- (4) Each article must be manufactured in such a way as to prevent hazardous projections of the pressure receptacle or parts of the pressure receptacle;

(5) Each pressure receptacle must be manufactured from material which will not fragment upon rupture;

(6) The design type of the article must be subjected to a fire test. For this test, the provisions of paragraphs 16.6.1.2 except letter g, 16.6.1.3.1 to 16.6.1.3.6, 16.6.1.3.7(b) and 16.6.1.3.8 of the UN Manual of Tests and Criteria must be applied. It must be demonstrated that the article relieves its pressure by means of a fire degradable seal or other pressure relief device, in such a way that the pressure receptacle will not fragment and that the article or fragments of the article do not rocket more than 10 meters; and

(7) The design type of the article must be subjected to the following test. A stimulating mechanism must be used to initiate one article in the middle of the packaging. There must be no hazardous effects outside the package such as disruption of the package, metal fragments or a receptacle which passes through the packaging.

b. The manufacturer must produce technical documentation of the design type, manufacture as well as the tests and their results. The manufacturer must apply procedures to ensure that articles produced in series are made of good quality, conform to the design type and are able to meet the requirements in (a). The manufacturer must provide such information to a representative of the Department upon request.

372 This entry applies to asymmetric capacitors with an energy storage capacity greater than 0.3 Wh. Capacitors with an energy storage capacity of 0.3 Wh or less are not subject to the requirements of this subchapter.

Energy storage capacity means the energy stored in a capacitor, as calculated according to the following equation,

$$Wh = 1/2C_N(U_R^2 - U_L^2) \times (1/3600)$$

Using the nominal capacitance (C_N), rated voltage (U_R) and the rated lower limit voltage (U_L).

Nickel-carbon asymmetric capacitors containing Class 8 alkaline electrolytes must be transported as UN2795, Batteries, wet, filled with alkali, electric storage.

379 When offered for transport by highway, rail, or cargo vessel, anhydrous ammonia adsorbed or absorbed on a solid contained in ammonia dispensing systems or receptacles intended to form part of such systems is not subject to the requirements of this subchapter if the following conditions in this provision are met. In addition to meeting the conditions in this provision, transport on cargo aircraft only may be authorized with prior approval of the Associate Administrator.

- a. The adsorption or absorption presents the following properties:
- (1) The pressure at a temperature of 20 °C (68 °F) in the receptacle is less than 0.6 bar (60 kPa);
 - (2) The pressure at a temperature of 35 °C (95 °F) in the receptacle is less than 1 bar (100 kPa);
 - (3) The pressure at a temperature of 85 °C (185 °F) in the receptacle is less than 12 bar (1200 kPa).
- b. The adsorbent or absorbent material shall not meet the definition or criteria for inclusion in Classes 1 to 8;
- c. The maximum contents of a receptacle shall be 10 kg of ammonia; and
- d. Receptacles containing adsorbed or absorbed ammonia shall meet the following conditions:
- (1) Receptacles shall be made of a material compatible with ammonia as specified in ISO 11114-1:2012(E) and ISO 11114-1:2012/Amd 1:2017(E) (IBR, *see* §171.7 of this subchapter);
 - (2) Receptacles and their means of closure shall be hermetically sealed and able to contain the generated ammonia;
 - (3) Each receptacle shall be able to withstand the pressure generated at 85 °C (185 °F) with a volumetric expansion no greater than 0.1%;
 - (4) Each receptacle shall be fitted with a device that allows for gas evacuation once pressure exceeds 15 bar (1500 kPa) without violent rupture, explosion or projection; and
 - (5) Each receptacle shall be able to withstand a pressure of 20 bar (2000 kPa) without leakage when the pressure relief device is deactivated.
- e. When offered for transport in an ammonia dispenser, the receptacles shall be connected to the dispenser in such a way that the assembly is guaranteed to have the same strength as a single receptacle.
- f. The properties of mechanical strength mentioned in this special provision shall be tested using a prototype of a receptacle and/or dispenser filled to nominal capacity, by increasing the temperature until the specified pressures are reached.
- g. The test results shall be documented, shall be traceable, and shall be made available to a representative of the Department upon request.
- 380 For transportation by private carrier in a motor carrier only, this material is not subject to the segregation requirements of §177.848(d) of this subchapter under the following conditions:
- a. The material is packaged in a DOT Specification 4BW240 cylinder, or in a DOT-51 portable tank.
 - b. The material may only be loaded with Class 3, Class 8, and Division 4.1 materials in Packing Group II or III.
 - c. The motor carrier must maintain a satisfactory safety rating as prescribed in 49 CFR part 385.
- 381 For railroad flagging kits, *see* §173.184 (c) of this subchapter.
- 382 Packages containing toy plastic or paper caps for toy pistols described as “UN0349, Articles, explosive, n.o.s. (Toy caps), 1.4S” or “NA0337, Toy caps, 1.4S” are not subject to the subpart E (labeling) requirements of this part when offered for transportation by motor vehicle, rail freight, cargo vessel, and cargo aircraft and, notwithstanding the packing method assigned in §173.62 of this subchapter, in conformance with the following conditions:
- a. The toy plastic or paper caps must be in the form of sheets, strips, rolls, or individual caps;
 - b. The caps must not contain more than an average of twenty-five hundredths of a grain of explosive composition per cap;
 - c. The caps must be packed inside packagings constructed of cardboard not less than 0.013-inch in thickness, metal not less than 0.008-inch in thickness, non-combustible plastic not less than 0.015-inch in thickness, or a composite blister package consisting of cardboard not less than 0.013-inch in thickness and non-combustible plastic not less than 0.005-inch in thickness that completely encloses the caps;
 - d. The minimum dimensions of each side and each end of the cardboard packaging must be 1/8th inch in height or more;
 - e. The number of caps inside each packaging must be limited so that not more than 10 grains of explosives composition may be packed into one cubic inch of space, and not more than 17.5 grains of the explosive composition of toy caps may be packed in any inner packaging;
 - f. Inner packagings must be packed in outer packagings meeting PG II performance criteria;
 - g. Toy caps may be packed with non-explosive or non-flammable articles provided the outer packagings are marked as prescribed in this paragraph;
 - h. Toy paper caps of any kind must not be packed in the same packaging with fireworks;
 - i. The outside of each package must be plainly marked “ARTICLES, EXPLOSIVES, N.O.S. (TOY CAPS)—HANDLE CAREFULLY” OR “TOY CAPS—HANDLE CAREFULLY”; and
 - j. Explosives shipped in conformance with this paragraph must have been examined in accordance with §173.56 of this subchapter and approved by the Associate Administrator.
- 383 For transportation by motor vehicle, substances meeting the conditions for high viscosity flammable liquids as prescribed

in §173.121(b)(1)(i), (b)(1)(ii), and (b)(1)(iv) of this subchapter, may be reassigned to Packing Group III under the following conditions:

- a. Packaging must be UN standard metal drums attached with heavy duty steel strapping to a pallet; and
- b. The capacity of each drum must not exceed 220 L (58 gallons).

384 For green graphite electrodes and shapes that are large single component solid objects not subject to shifting, transport in open rail flat cars, open bed motor vehicles, and intermodal containers is also authorized. The objects must be secured to the flat car, motor vehicle, intermodal container, or unitized by steel banding to wooden runners or pallets and the units secured to the flat car, motor vehicle, or freight container to prevent shifting, including relative motion between the objects, under conditions normally incident to transportation. Stacking is permitted two or more levels high to achieve maximum allowable utilization of the designated vehicle, rail car weight, or intermodal freight container weight or vessel hold volume.

385 Notwithstanding the provisions of §177.834(1) of this subchapter, cargo heaters may be used when weather conditions are such that the freezing of a wetted explosive material is likely. Shipments must be made by private, leased or contract carrier vehicles under exclusive use of the offeror. Cargo heaters must be reverse refrigeration (heat pump) units. Shipments made in accordance with this Special provision are excepted from the requirements of §173.60(b)(4) of this subchapter.

386 When transported by private motor carrier only, the following corrosive liquids may be packaged in polyethylene bottles with a capacity no greater than 3.785 L (one gallon), further packed inside an open-top, heavy wall, high density polyethylene box (*i.e.*, crate) in a manner that the polyethylene bottles are not subjected to any superimposed weight, and the boxes must be reasonably secured against shifting within the transport vehicle and loaded so as to minimize the possibility of coming in contact with other lading:

- Compounds, cleaning liquid, NA1760, PG II or III;
- Corrosive liquid, acidic, inorganic, n.o.s., UN3264, PG II;
- Corrosive liquid, acidic, organic, n.o.s., UN3265, PG III;
- Corrosive liquid, basic, inorganic, n.o.s., UN3266, PG II;
- Hypochlorite solutions, UN1791, PG III;
- Hydrochloric acid solution, UN1789, PG II; and
- Sulfuric acid, UN2796, PG II.

a. No more than four bottles, securely closed with threaded caps, may be packed in each box.

b. Each empty bottle must have a minimum weight of not less than 140 grams and a minimum wall thickness of not less than 0.020 inch (0.508 mm).

c. The completed package must meet the Packing Group II performance level, as applicable for combination packagings with a plastic box outer packaging, in accordance with subpart M of part 178 of this subchapter.

(i) Tests must be performed on each type and size of bottle, for each manufacturing location. Samples taken at random must withstand the prescribed tests without breakage or leakage.

(ii) One bottle for every two hours of production, or for every 2,500 bottles produced, must be tested by dropping a bottle filled to 98 percent capacity with water from a height of 1.2 meters (3.9 feet) onto solid concrete directly on the closure.

(iii) A copy of the test results must be kept on file at each facility where packagings are offered for transportation, and must be made available to a representative of the Department upon request.

(iv) The name or symbol of the bottle producer, and the month and year of manufacture, must be marked by embossing, ink-jet printing of permanent ink, or other permanent means on the face or bottom of each bottle, in letters and numbers at least 6 mm (0.2 inch) high. Symbols, if used, must be registered with the Associate Administrator.

(v) The box must be constructed from high-density polyethylene in the density range 0.950-0.962, and be capable of holding liquid when in the upright position.

387 When materials are stabilized by temperature control, the provisions of §173.21(f) of this subchapter apply. When chemical stabilization is employed, the person offering the material for transport shall ensure that the level of stabilization is sufficient to prevent the material as packaged from dangerous polymerization at 50 °C(122 °F). If chemical stabilization becomes ineffective at lower temperatures within the anticipated duration of transport, temperature control is required and is forbidden by aircraft. In making this determination factors to be taken into consideration include, but are not limited to, the capacity and geometry of the packaging and the effect of any insulation present, the temperature of the material when offered for transport, the duration of the journey, and the ambient temperature conditions typically encountered in the journey (considering also the season of

year), the effectiveness and other properties of the stabilizer employed, applicable operational controls imposed by regulation (*e.g.*, requirements to protect from sources of heat, including other cargo carried at a temperature above ambient) and any other relevant factors. The provisions of this special provision will be effective until January 2, 2023, unless we terminate them earlier or extend them beyond that date by notice of a final rule in the FEDERAL REGISTER.

- 388 a. Lithium batteries containing both primary lithium metal cells and rechargeable lithium ion cells that are not designed to be externally charged, must meet the following conditions:
- i. The rechargeable lithium ion cells can only be charged from the primary lithium metal cells;
 - ii. Overcharge of the rechargeable lithium ion cells is precluded by design;
 - iii. The battery has been tested as a primary lithium battery; and
 - iv. Component cells of the battery must be of a type proved to meet the respective testing requirements of the Manual of Tests and Criteria, part III, subsection 38.3 (IBR, see §171.7 of this subchapter).
- b. Lithium batteries conforming to paragraph a. of this special provision must be assigned to UN Nos. 3090 or 3091, as appropriate. When such batteries are transported in accordance with §173.185(c), the total lithium content of all lithium metal cells contained in the battery must not exceed 1.5 g and the total capacity of all lithium ion cells contained in the battery must not exceed 10 Wh.
- 389 This entry only applies to lithium ion batteries or lithium metal batteries installed in a cargo transport unit and designed only to provide power external to the cargo transport unit. The lithium batteries must meet the requirements of §173.185(a) and contain the necessary systems to prevent overcharge and over discharge between the batteries. The batteries must be securely attached to the interior structure of the cargo transport unit (*e.g.*, by means of placement in racks, cabinets, etc.) in such a manner as to prevent short circuits, accidental operation, and significant movement relative to the cargo transport unit under the shocks, loadings, and vibrations normally incident to transport. Hazardous materials necessary for the safe and proper operation of the cargo transport unit (*e.g.*, fire extinguishing systems and air conditioning systems), must be properly secured to or installed in the cargo transport unit and are not otherwise subject to this subchapter. Hazardous materials not necessary for the safe and proper operation of the cargo transport unit must not be transported within the cargo transport unit. The batteries inside the

cargo transport unit are not subject to marking or labelling requirements of part 172 subparts D and E of this subchapter. The cargo transport unit shall display the UN number in a manner in accordance with §172.332 of this subchapter and be placarded on two opposing sides. For transportation by aircraft, cargo transport units may only be offered for transportation and transported under conditions approved by the Associate Administrator.

- 391 Except for articles being transported by motor vehicle as a material of trade in accordance with §173.6 of this subchapter, articles containing hazardous materials of Division 2.3, or Division 4.2, or Division 4.3, or Division 5.1, or Division 5.2, or Division 6.1 (substances with an inhalation toxicity of Packing Group I) and articles containing more than one of the following hazards: (1) Gases of Class 2; (2) Liquid desensitized explosives of Class 3; or (3) Self-reactive substances and solid desensitized explosives of Division 4.1, may only be offered for transportation and transported under conditions approved by the Associate Administrator.
- 420 This entry does not apply to manufactured articles (such as table tennis balls).
- 421 This entry will no longer be effective on January 2, 2023, unless we terminate it earlier or extend it beyond that date by notice of a final rule in the FEDERAL REGISTER.
- 422 When labelling is required, the label to be used must be the label shown in §172.447. When a placard is displayed, the placard must be the placard shown in §172.560.
- 430 This entry shall only be used for solid medical waste of Category A transported for disposal.
- 440 When this material is transported by tank car, the offeror must ensure each tank car is remotely monitored for pressure and location. Additionally, the offeror must notify the carrier if the tank pressure rise exceeds 3 psig over any 24-hour period.
- 441 For marine pollutants transported under “UN3077, Environmentally hazardous substance, solid, n.o.s.” or “UN3082, Environmentally hazardous substance, liquid, n.o.s.” and for purposes of shipping paper and package marking requirements, the technical name used in association with the basic description may be a proper shipping name listed in the §172.101 Hazardous Material Table; provided that the name chosen is not also an entry that includes “n.o.s.” as a part of the name or one that has a “G” in column (1) of the table.

(2) “A” codes. These provisions apply only to transportation by aircraft:

Code/Special Provisions

- A1 Single packagings are not permitted on passenger aircraft.

- A2 Single packagings are not permitted on aircraft.
- A3 For combination packagings, if glass inner packagings (including ampoules) are used, they must be packed with absorbent material in tightly closed rigid and leak-proof receptacles before packing in outer packagings.
- A4 Liquids having an inhalation toxicity of Packing Group I are not permitted on aircraft.
- A5 Solids having an inhalation toxicity of Packing Group I are not permitted on passenger aircraft and may not exceed a maximum net quantity per package of 15 kg (33 pounds) on cargo aircraft.
- A6 For combination packagings, if plastic inner packagings are used, they must be packed in tightly closed metal receptacles before packing in outer packagings.
- A7 Steel packagings must be corrosion-resistant or have protection against corrosion.
- A8 For combination packagings, if glass inner packagings (including ampoules) are used, they must be packed with cushioning material in tightly closed metal receptacles before packing in outer packagings.
- A9 For combination packagings, if plastic bags are used, they must be packed in tightly closed metal receptacles before packing in outer packagings.
- A10 When aluminum or aluminum alloy construction materials are used, they must be resistant to corrosion.
- A11 For combination packagings, when metal inner packagings are permitted, only specification cylinders constructed of metals which are compatible with the hazardous material may be used.
- A13 Bulk packagings are not authorized for transportation by aircraft.
- A14 This material is not authorized to be transported as a limited quantity or consumer commodity in accordance with §173.306 of this subchapter when transported aboard an aircraft.
- A19 Combination packagings consisting of outer fiber drums or plywood drums, with inner plastic packagings, are not authorized for transportation by aircraft.
- A20 Plastic bags as inner receptacles of combination packagings are not authorized for transportation by aircraft.
- A29 Combination packagings consisting of outer expanded plastic boxes with inner plastic bags are not authorized for transportation by aircraft.
- A30 Ammonium permanganate is not authorized for transportation on aircraft.
- A34 Aerosols containing a corrosive liquid in Packing Group II charged with a gas are not permitted for transportation by aircraft.
- A35 This includes any material which is not covered by any of the other classes but which has an anesthetic, narcotic, noxious or other similar properties such that, in the event of spillage or leakage on an aircraft, extreme annoyance or discomfort could be caused to crew members so as to prevent the correct performance of assigned duties.
- A37 This entry applies only to a material meeting the definition in §171.8 of this subchapter for self-defense spray.
- A51 For aircraft batteries, irrespective of the quantity limitations specified in Column (9A) of the §172.101 Table or §175.75(c), wet cell batteries, UN2794 or UN2795, up to a limit of 100 kg net mass per package may be transported aboard passenger aircraft. Transport in accordance with this special provision must be noted on the shipping paper.
- A53 Refrigerating machines and refrigerating machine components are not subject to the requirements of this subchapter when containing less than 12 kg (26.4 pounds) of a non-flammable gas or when containing 12 L (3 gallons) or less of ammonia solution (UN2672) (see §173.307 of this subchapter).
- A54 Irrespective of the quantity limits in Column 9B of the §172.101 table, a lithium battery, including a lithium battery packed with, or contained in, equipment that otherwise meets the applicable requirements of §173.185, may have a mass exceeding 35 kg if approved by the Associate Administrator prior to shipment.
- A56 Radioactive material with a subsidiary hazard of Division 4.2, Packing Group I, must be transported in Type B packages when offered for transportation by aircraft. Where the subsidiary hazard material is "Forbidden" in column (9A) or (9B) of the §172.101 Table, the radioactive material may only be offered for transportation and transported by aircraft under conditions approved by the Associate Administrator.
- A60 Sterilization devices, when containing less than 30 mL per inner packaging with not more than 150 mL per outer packaging, may be transported in accordance with the provisions in §173.4a, irrespective of §173.4a(b), provided such packagings were first subjected to comparative fire testing. Comparative fire testing between a package as prepared for transport (including the substance to be transported) and an identical package filled with water must show that the maximum temperature measured inside the packages during testing does not differ by more than 200 °C (392 °F). Packagings may include a vent to permit the slow escape of gas (i.e. not more than 0.1 mL/hour per 30 mL inner packaging at 20 °C (68 °F) produced from gradual decomposition. The requirements of §§173.24(g)(1) and 173.27(c) do not apply.
- A61 a. When used for purposes such as sterilization, inner packagings of peroxyacetic

acid, stabilized, classified as UN 3107 Organic peroxide type E, liquid or UN 3109 Organic peroxide type F, liquid may be fitted with a vent consisting of hydrophobic membrane, provided:

- (1) Each inner packaging contains not more than 70 mL;
 - (2) The inner packaging is designed so that the vent is not immersed in liquid in any orientation;
 - (3) Each inner packaging is enclosed in an intermediate rigid plastic packaging with a small opening to permit release of gas and contains a buffer that neutralizes the contents of the inner packaging in the event of leakage;
 - (4) Intermediate packagings are packed in a fiberboard box (4G) outer packaging;
 - (5) Each outer packaging contains not more than 1.4 L of liquid; and
 - (6) The rate of oxygen release from the outer packaging does not exceed 15 mL per hour.
- b. Such packages must be transported on cargo aircraft only. The requirements of §§173.24(g)(1) and 173.27(c) do not apply.

A82 The quantity limits in columns (9A) and (9B) do not apply to human or animal body parts, whole organs or whole bodies known to contain or suspected of containing an infectious substance.

A100 Lithium ion cells and batteries must be offered for transport at a state of charge not exceeding 30 percent of their rated capacity. Lithium ion cells and batteries at a state of charge greater than 30 percent of their rated capacity may only be transported under conditions approved by the Associate Administrator in accordance with the requirements in 49 CFR part 107, subpart H. Guidance and methodology for determining the rated capacity can be found in sub-section 38.3.2.3 of the UN Manual of Tests and Criteria (IBR, see §171.7 of this subchapter).

A101 In addition to the applicable requirements of §173.185, the quantity of lithium metal in the batteries contained in any piece of equipment must not exceed 12 g per cell and 500 g per battery.

A105 a. This entry applies to machinery or apparatus containing hazardous materials as a residue or as an integral element of the machinery or apparatus. It must not be used for machinery or apparatus for which a proper shipping name already exists in the §172.101 Table.

- b. Where the quantity of hazardous materials contained as an integral element in machinery or apparatus exceeds the limits permitted by §173.222(c)(2), and the hazardous materials meet the provisions of §173.222(c), the machinery or apparatus may be transported by aircraft only with the prior approval of the Associate Administrator.

A112 Notwithstanding the quantity limits shown in Column (9A) and (9B) for this entry, the following IBCs are authorized for transportation aboard passenger and cargo-only aircraft. Each IBC may not exceed a maximum net quantity of 1,000 kg:

- a. Metal: 11A, 11B, 11N, 21A, 21B and 21N
- b. Rigid plastics: 11H1, 11H2, 21H1 and 21H2
- c. Composite with plastic inner receptacle: 11HZ1, 11HZ2, 21HZ1 and 21HZ2
- d. Fiberboard: 11G
- e. Wooden: 11C, 11D and 11F (with inner liners)
- f. Flexible: 13H2, 13H3, 13H4, 13H5, 13L2, 13L3, 13L4, 13M1 and 13M2 (flexible IBCs must be sift-proof and water resistant or must be fitted with a sift-proof and water resistant liner).

A189 Except where the defining criteria of another class or division are met, concentrations of formaldehyde solution:

- a. With less than 25 percent but not less than 10 percent formaldehyde, must be described as UN3334, Aviation regulated liquid, n.o.s.; and
- b. With less than 10 percent formaldehyde, are not subject to this subchapter.

A191 Notwithstanding the Division 6.1 subsidiary risk for this description, the toxic subsidiary risk label and the requirement to indicate the subsidiary risk on the shipping paper are not required for manufactured articles containing less than 5 kg (11 pounds) of mercury.

A200 These articles must be transported as cargo and may not be carried aboard an aircraft by passengers or crewmembers in carry-on baggage, checked baggage, or on their person unless specifically authorized in §175.10.

A210 This substance is forbidden for transport by air. It may be transported on cargo aircraft only with the prior approval of the Associate Administrator.

A212 “UN 2031, Nitric acid, *other than red fuming, with more than 20% and less than 65% nitric acid*” intended for use in sterilization devices only, may be transported on passenger aircraft irrespective of the indication of “forbidden” in columns (9A) of the §172.101 table provided that:

- a. Each inner packaging contains not more than 30 mL;
- b. Each inner packaging is contained in a sealed leak-proof intermediate packaging with sufficient absorbent material capable of containing the contents of the inner packaging;
- c. Intermediate packagings are securely packed in an outer packaging of a type permitted by §173.158(g) of this subchapter which meet the requirements of part 178 of this subchapter at the Packing Group I performance level;
- d. The maximum quantity of nitric acid in the package does not exceed 300 mL; and

e. Transport in accordance with this special provision must be noted on the shipping paper.

(3) “B” codes. These provisions apply only to bulk packagings. Except as otherwise provided in this subchapter, these special provisions do not apply to UN portable tanks or IBCs:

Code/Special Provisions

- B1 If the material has a flash point at or above 38 °C (100 °F) and below 93 °C (200 °F), then the bulk packaging requirements of §173.241 of this subchapter are applicable. If the material has a flash point of less than 38 °C (100 °F), then the bulk packaging requirements of §173.242 of this subchapter are applicable.
- B2 MC 300, MC 301, MC 302, MC 303, MC 305, and MC 306 and DOT 406 cargo tanks are not authorized.
- B3 MC 300, MC 301, MC 302, MC 303, MC 305, and MC 306 and DOT 406 cargo tanks and DOT 57 portable tanks are not authorized.
- B4 MC 300, MC 301, MC 302, MC 303, MC 305, and MC 306 and DOT 406 cargo tanks are not authorized.
- B5 Only ammonium nitrate solutions with 35 percent or less water that will remain completely in solution under all conditions of transport at a maximum lading temperature of 116 °C (240 °F) are authorized for transport in the following bulk packagings: MC 307, MC 312, DOT 407 and DOT 412 cargo tanks with at least 172 kPa (25 psig) design pressure. The packaging shall be designed for a working temperature of at least 121 °C (250 °F). Only Specifications MC 304, MC 307 or DOT 407 cargo tank motor vehicles are authorized for transportation by vessel.
- B6 Packagings shall be made of steel.
- B7 Safety relief devices are not authorized on multi-unit tank car tanks. Openings for safety relief devices on multi-unit tank car tanks shall be plugged or blank flanged.
- B8 Packagings shall be made of nickel, stainless steel, or steel with nickel, stainless steel, lead or other suitable corrosion resistant metallic lining.
- B9 Bottom outlets are not authorized.
- B10 MC 300, MC 301, MC 302, MC 303, MC 305, and MC 306 and DOT 406 cargo tanks, and DOT 57 portable tanks are not authorized.
- B11 Tank car tanks must have a test pressure of at least 2,068.5 kPa (300 psig). Cargo and portable tanks must have a design pressure of at least 1,207 kPa (175 psig).
- B13 A nonspecification cargo tank motor vehicle authorized in §173.247 of this subchapter must be at least equivalent in design and in construction to a DOT 406 cargo tank or MC 306 cargo tank (if constructed before August 31, 1995), except as follows:

- a. Packagings equivalent to MC 306 cargo tanks are excepted from the certification, venting, and emergency flow requirements of the MC 306 specification.
- b. Packagings equivalent to DOT 406 cargo tanks are excepted from §§178.345-7(d)(5), circumferential reinforcements; 178.345-10, pressure relief; 178.345-11, outlets; 178.345-14, marking, and 178.345-15, certification.
- c. Packagings are excepted from the design stress limits at elevated temperatures, as described in Section VIII of the ASME Code (IBR, see §171.7 of this subchapter). However, the design stress limits may not exceed 25 percent of the stress for 0 temper at the maximum design temperature of the cargo tank, as specified in the Aluminum Association’s “Aluminum Standards and Data” (IBR, see §171.7 of this subchapter).
- B14 Each bulk packaging, except a tank car or a multi-unit-tank car tank, must be insulated with an insulating material so that the overall thermal conductance at 15.5 °C (60 °F) is no more than 1.5333 kilojoules per hour per square meter per degree Celsius (0.075 Btu per hour per square foot per degree Fahrenheit) temperature differential. Insulating materials must not promote corrosion to steel when wet.
- B15 Packagings must be protected with non-metallic linings impervious to the lading or have a suitable corrosion allowance.
- B16 The lading must be completely covered with nitrogen, inert gas or other inert materials.
- B18 Open steel hoppers or bins are authorized.
- B23 Tanks must be made of steel that is rubber lined or unlined. Unlined tanks must be passivated before being placed in service. If unlined tanks are washed out with water, they must be repassivated prior to return to service. Lading in unlined tanks must be inhibited so that the corrosive effect on steel is not greater than that of hydrofluoric acid of 65 percent concentration.
- B25 Packagings must be made from monel or nickel or monel-lined or nickel-lined steel.
- B26 Tanks must be insulated. Insulation must be at least 100 mm (3.9 inches) except that the insulation thickness may be reduced to 51 mm (2 inches) over the exterior heater coils. Interior heating coils are not authorized. The packaging may not be loaded with a material outside of the packaging’s design temperature range. In addition, the material also must be covered with an inert gas or the container must be filled with water to the tank’s capacity. After unloading, the residual material also must be covered with an inert gas or the container must be filled with water to the tank’s capacity.

§ 172.102

49 CFR Ch. I (10–1–23 Edition)

B27 Tanks must have a service pressure of 1,034 kPa (150 psig). Tank car tanks must have a test pressure rating of 1,379 kPa (200 psig). Lading must be blanketed at all times with a dry inert gas at a pressure not to exceed 103 kPa (15 psig).

B28 Packagings must be made of stainless steel.

B30 MC 312, MC 330, MC 331 and DOT 412 cargo tanks and DOT 51 portable tanks must be made of stainless steel, except that steel other than stainless steel may be used in accordance with the provisions of §173.24b(b) of this subchapter. Thickness of stainless steel for tank shell and heads for cargo tanks and portable tanks must be the greater of 7.62 mm (0.300 inch) or the thickness required for a tank with a design pressure at least equal to 1.5 times the vapor pressure of the lading at 46 °C (115 °F). In addition, MC 312 and DOT 412 cargo tank motor vehicles must:

- a. Be ASME Code (U) stamped for 100% radiography of all pressure-retaining welds;
- b. Have accident damage protection which conforms with §178.345–8 of this subchapter;
- c. Have a MAWP or design pressure of at least 87 psig; and
- d. Have a bolted manway cover.

B32 MC 312, MC 330, MC 331, DOT 412 cargo tanks and DOT 51 portable tanks must be made of stainless steel, except that steel other than stainless steel may be used in accordance with the provisions of §173.24b(b) of this subchapter. Thickness of stainless steel for tank shell and heads for cargo tanks and portable tanks must be the greater of 6.35 mm (0.250 inch) or the thickness required for a tank with a design pressure at least equal to 1.3 times the vapor pressure of the lading at 46 °C (115 °F). In addition, MC 312 and DOT 412 cargo tank motor vehicles must:

- a. Be ASME Code (U) stamped for 100% radiography of all pressure-retaining welds;
- b. Have accident damage protection which conforms with §178.345–8 of this subchapter;
- c. Have a MAWP or design pressure of at least 87 psig; and
- d. Have a bolted manway cover.

B33 MC 300, MC 301, MC 302, MC 303, MC 305, MC 306, and DOT 406 cargo tanks equipped with a 1 psig normal vent used to transport gasoline must conform to Table I of this Special Provision. Based on the volatility class determined by using ASTM D 439 and the Reid vapor pressure (RVP) of the particular gasoline, the maximum lading pressure and maximum ambient temperature permitted during the loading of gasoline may not exceed that listed in Table I.

TABLE I—MAXIMUM AMBIENT TEMPERATURE—GASOLINE

ASTM D439 volatility class	Maximum lading and ambient temperature (see note 1)
A (RVP ≤ 9.0 psia)	131 °F
B (RVP ≤ 10.0 psia)	124 °F
C (RVP ≤ 11.5 psia)	116 °F
D (RVP ≤ 13.5 psia)	107 °F
E (RVP ≤ 15.0 psia)	100 °F

NOTE 1: Based on maximum lading pressure of 1 psig at top of cargo tank.

B35 Tank cars containing hydrogen cyanide may be alternatively marked “Hydrocyanic acid, liquefied” if otherwise conforming to marking requirements in subpart D of this part. Tank cars marked “HYDROCYANIC ACID” prior to October 1, 1991 do not need to be remarked.

B42 Tank cars constructed before March 16, 2009, must have a test pressure of 34.47 Bar (500 psig) or greater and conform to Class 105J. Each tank car must have a reclosing pressure relief device having a start-to-discharge pressure of 10.34 Bar (150 psig). The tank car specification may be marked to indicate a test pressure of 13.79 Bar (200 psig).

B44 All parts of valves and safety relief devices in contact with lading must be of a material which will not cause formation of acetylides.

B45 Each tank must have a reclosing combination pressure relief device equipped with stainless steel or platinum rupture discs approved by the AAR Tank Car Committee.

B46 The detachable protective housing for the loading and unloading valves of multi-unit tank car tanks must withstand tank test pressure and must be approved by the Associate Administrator.

B47 Each tank may have a reclosing pressure relief device having a start-to-discharge pressure setting of 310 kPa (45 psig).

B48 Portable tanks in sodium metal service may be visually inspected at least once every 5 years instead of being retested hydrostatically. Date of the visual inspection must be stenciled on the tank near the other required markings.

B49 Tanks equipped with interior heater coils are not authorized. Single unit tank car tanks must have a reclosing pressure relief device having a start-to-discharge pressure set at no more than 1551 kPa (225 psig).

B52 Notwithstanding the provisions of §173.24b of this subchapter, non-reclosing pressure relief devices are authorized on DOT 57 portable tanks.

- B53 Packagings must be made of either aluminum or steel.
- B54 Open-top, sift-proof rail cars are also authorized.
- B55 Water-tight, sift-proof, closed-top, metal-covered hopper cars, equipped with a venting arrangement (including flame arrestors) approved by the Associate Administrator are also authorized.
- B56 Water-tight, sift-proof, closed-top, metal-covered hopper cars are also authorized if the particle size of the hazardous material is not less than 149 microns.
- B57 Class 115A tank car tanks used to transport chloroprene must be equipped with a non-reclosing pressure relief device of a diameter not less than 305 mm (12 inches) with a maximum rupture disc pressure of 310 kPa (45 psig).
- B59 Water-tight, sift-proof, closed-top, metal-covered hopper cars are also authorized provided that the lading is covered with a nitrogen blanket.
- B61 Written procedures covering details of tank car appurtenances, dome fittings, safety devices, and marking, loading, handling, inspection, and testing practices must be approved by the Associate Administrator before any single unit tank car tank is offered for transportation.
- B65 Tank cars constructed before March 16, 2009, must have a test pressure of 34.47 Bar (500 psig) or greater and conform to Class 105A. Each tank car must have a reclosing pressure relief device having a start-to-discharge pressure of 15.51 Bar (225 psig). The tank car specification may be marked to indicate a test pressure of 20.68 Bar (300 psig).
- B66 Each tank must be equipped with gas tight valve protection caps. Outage must be sufficient to prevent tanks from becoming liquid full at 55 °C (130 °F). Specification 110A500W tanks must be stainless steel.
- B67 All valves and fittings must be protected by a securely attached cover made of metal not subject to deterioration by the lading, and all valve openings, except safety valve, must be fitted with screw plugs or caps to prevent leakage in the event of valve failure.
- B68 Sodium must be in a molten condition when loaded and allowed to solidify before shipment. Outage must be at least 5 percent at 98 °C (208 °F). Bulk packagings must have exterior heating coils fusion welded to the tank shell which have been properly stress relieved. The only tank car tanks authorized are Class DOT 105 tank cars having a test pressure of 2,069 kPa (300 psig) or greater.
- B69 Dry sodium cyanide or potassium cyanide may be shipped in the following sift-proof and weather-resistant packagings: metal covered hopper cars, covered motor vehicles, portable tanks, or non-specification bins.
- B70 If DOT 103ANW tank car tank is used: All cast metal in contact with the lading must have 96.7 percent nickel content; and the lading must be anhydrous and free from any impurities.
- B76 Tank cars constructed before March 16, 2009, must have a test pressure of 20.68 Bar (300 psig) or greater and conform to Class 105S, 112J, 114J or 120S. Each tank car must have a reclosing pressure relief device having a start-to-discharge pressure of 10.34 Bar (150 psig). The tank car specification may be marked to indicate a test pressure of 13.79 Bar (200 psig).
- B77 Other packaging are authorized when approved by the Associate Administrator.
- B78 Tank cars must have a test pressure of 4.14 Bar (60 psig) or greater and conform to Class 103, 104, 105, 109, 111, 112, 114 or 120. Heater pipes must be of welded construction designed for a test pressure of 500 psig. A 25 mm (1 inch) woven lining of asbestos or other approved material must be placed between the bolster slabbing and the bottom of the tank. If a tank car tank is equipped with a non-reclosing pressure relief device, the rupture disc must be perforated with a 3.2 mm (0.13 inch) diameter hole. If a tank car tank is equipped with a reclosing pressure relief valve, the tank must also be equipped with a vacuum relief valve.
- B80 Each cargo tank must have a minimum design pressure of 276 kPa (40 psig).
- B81 Venting and pressure relief devices for tank car tanks and cargo tanks must be approved by the Associate Administrator.
- B82 Cargo tanks and portable tanks are not authorized.
- B83 Bottom outlets are prohibited on tank car tanks transporting sulfuric acid in concentrations over 65.25 percent.
- B84 Packagings must be protected with non-metallic linings impervious to the lading or have a suitable corrosion allowance for sulfuric acid or spent sulfuric acid in concentration up to 65.25 percent.
- B85 Cargo tanks must be marked with the name of the lading in accordance with the requirements of §172.302(b).
- B90 Steel tanks conforming or equivalent to ASME specifications which contain solid or semisolid residual motor fuel anti-knock mixture (including rust, scale, or other contaminants) may be shipped by rail freight or highway. The tank must have been designed and constructed to be capable of withstanding full vacuum. All openings must be closed with gasketed blank flanges or vapor tight threaded closures.
- B115 Rail cars, highway trailers, roll-on/roll-off bins, or other non-specification bulk packagings are authorized. Packagings must be sift-proof, prevent liquid

water from reaching the hazardous material, and be provided with sufficient venting to preclude dangerous accumulation of flammable, corrosive, or toxic gaseous emissions such as methane, hydrogen, and ammonia. The material must be loaded dry.

B116 The use of non specification, sift-proof dump or hopper type vehicles, and sift-proof roll-on/roll-off bulk bins, which must be covered by a tarpaulin, metal cover, or equivalent means is authorized for the transportation of spent bleaching earth by motor vehicle. The material is also be subject to operational controls which include not exceeding a temperature of 55C (130F) at the time it is offered or during transportation, not exceeding a transportation time of 24 hours, and drivers transporting spent bleaching earth must be trained in the properties and hazards of the spent bleaching earth. This training must be documented in training records required by §172.704(d).

B120 The use of flexible bulk containers conforming to the requirements in subpart R and subpart S of part 178 of this subchapter is permitted.

B130 When transported by motor vehicle, used diatomaceous earth filter material is not subject to any other requirements of this subchapter except for the shipping paper requirements of subpart C of part 172 of this subchapter; emergency response information as required by §172.602(a)(2) through (a)(7) of this subchapter; and the marking requirements of §172.302 of this subchapter, if the following requirements are met:

- a. Packagings are non-DOT specification sift-proof motor vehicles or sift-proof roll-on/roll-off bulk bins, which are covered by a tarpaulin or other equivalent means.
- b. The temperature of the material at the time it is offered for transport and during transportation may not exceed 55 °C (130 °F).
- c. The time between offering the material for transportation at the point of origin, and unloading the material at the destination does not exceed 48 hours.
- d. In addition to the training requirements prescribed in §§172.700 through 172.704, each driver must be trained regarding the properties and hazards of diatomaceous earth filter material, precautions to ensure safe transport of the material, and actions to be taken in the event of an emergency during transportation, or a substantial delay in transit.

B131 When transported by highway, rail, or cargo vessel, waste Paint and Paint related material (UN1263; PG II and PG III), when in plastic or metal inner packagings of not more than 26.5 L (7 gallons), are excepted from the marking requirements in

§172.301(a) and (c) and the labeling requirements in §172.400(a), when further packed in the following specification and non-specification bulk outer packagings and under the following conditions:

- a. Primary receptacles must conform to the general packaging requirements of subpart B of part 173 of this subchapter and may not leak. If they do leak, they must be overpacked in packagings conforming to the specification requirements of part 178 of this subchapter or in salvage packagings conforming to the requirements in §173.12 of this subchapter.
- b. Primary receptacles must be further packed in non-specification bulk outer packagings such as cubic yard boxes, plastic rigid-wall bulk containers, dump trailers, and roll-off containers. Bulk outer packagings must be liquid tight through design or by the use of lining materials.
- c. Primary receptacles may also be further packed in specification bulk outer packagings. Authorized specification bulk outer packagings are UN11G fiberboard intermediate bulk containers (IBC) and UN13H4 woven plastic, coated and with liner flexible intermediate bulk containers (FIBCs) meeting the Packing Group II performance level and lined with a plastic liner of at least 6 mil thickness.
- d. All inner packagings placed inside bulk outer packagings must be blocked and braced to prevent shifting during transportation that could cause the container to open or fall over. Specification IBCs and FIBCs are to be secured to a pallet.

B132 Except for transportation by aircraft, UN2813, Water reactive solid, n.o.s. (contains magnesium, magnesium nitrides) in PG II or III may be packaged in sift-proof bulk packagings that prevent liquid from reaching the hazardous material with sufficient venting to preclude dangerous accumulation of flammable, corrosive or toxic gaseous emissions such as methane, hydrogen and ammonia.

B133 Hydrochloric acid concentration not exceeding 38%, in Packing Group II, is authorized to be packaged in UN31H1 or UN31HH1 intermediate bulk containers when loaded in accordance with the requirements of §173.35(h) of this subchapter.

B134 For Large Packagings offered for transport by vessel, flexible or fibre inner packagings shall be sift-proof and water-resistant or shall be fitted with a sift-proof and water-resistant liner.

B135 For Large Packagings offered for transport by vessel, flexible or fibre inner packagings shall be hermetically sealed.

B136 Non-specification closed bulk bins are authorized.

(4) *IB Codes and IP Codes.* These provisions apply only to transportation in IBCs and Large Packagings. Table 1 authorizes IBCs for specific proper shipping names through the use of IB Codes assigned in the §172.101 table of this subchapter. Table 2 defines IP Codes on the use of IBCs that are assigned to specific commodities in the §172.101 Table of this subchapter. Table 3 authorizes Large Packagings for specific proper shipping names through the use of IB Codes assigned in the §172.101 table of this subchapter. Large Packagings are authorized for the Packing Group III entries of specific proper shipping names when either special

provision IB3 or IB8 is assigned to that entry in the §172.101 Table. When no IB code is assigned in the §172.101 Table for a specific proper shipping name, or in §173.185 or §173.225(e) Organic Peroxide Table for Type F organic peroxides, use of an IBC or Large Packaging for the material may be authorized when approved by the Associate Administrator. The letter “Z” shown in the marking code for composite IBCs must be replaced with a capital code letter designation found in §178.702(a)(2) of this subchapter to specify the material used for the other packaging. Tables 1, 2, and 3 follow:

TABLE 1—IB CODES (IBC CODES)

IBC code	Authorized IBCs
IB1	<i>Authorized IBCs:</i> Metal (31A, 31B and 31N). <i>Additional Requirement:</i> Only liquids with a vapor pressure less than or equal to 110 kPa at 50 °C (1.1 bar at 122 °F), or 130 kPa at 55 °C (1.3 bar at 131 °F) are authorized.
IB2	<i>Authorized IBCs:</i> Metal (31A, 31B and 31N); Rigid plastics (31H1 and 31H2); Composite (31HZ1). <i>Additional Requirement:</i> Only liquids with a vapor pressure less than or equal to 110 kPa at 50 °C (1.1 bar at 122 °F), or 130 kPa at 55 °C (1.3 bar at 131 °F) are authorized.
IB3	<i>Authorized IBCs:</i> Metal (31A, 31B and 31N); Rigid plastics (31H1 and 31H2); Composite (31HZ1 and 31HA2, 31HB2, 31HN2, 31HD2 and 31HH2). <i>Additional Requirement:</i> Only liquids with a vapor pressure less than or equal to 110 kPa at 50 °C (1.1 bar at 122 °F), or 130 kPa at 55 °C (1.3 bar at 131 °F) are authorized, except for UN2672 (also see special provision IP8 in Table 2 for UN2672).
IB4	<i>Authorized IBCs:</i> Metal (11A, 11B, 11N, 21A, 21B, 21N, 31A, 31B and 31N).
IB5	<i>Authorized IBCs:</i> Metal (11A, 11B, 11N, 21A, 21B, 21N, 31A, 31B and 31N); Rigid plastics (11H1, 11H2, 21H1, 21H2, 31H1 and 31H2); Composite (11HZ1, 21HZ1 and 31HZ1).
IB6	<i>Authorized IBCs:</i> Metal (11A, 11B, 11N, 21A, 21B, 21N, 31A, 31B and 31N); Rigid plastics (11H1, 11H2, 21H1, 21H2, 31H1 and 31H2); Composite (11HZ1, 11HZ2, 21HZ1, 21HZ2 and 31HZ1). <i>Additional Requirement:</i> Composite IBCs 11HZ2 and 21HZ2 may not be used when the hazardous materials being transported may become liquid during transport.
IB7	<i>Authorized IBCs:</i> Metal (11A, 11B, 11N, 21A, 21B, 21N, 31A, 31B and 31N); Rigid plastics (11H1, 11H2, 21H1, 21H2, 31H1 and 31H2); Composite (11HZ1, 11HZ2, 21HZ1, 21HZ2 and 31HZ1); Wooden (11C, 11D and 11F). <i>Additional Requirement:</i> Liners of wooden IBCs must be sift-proof.
IB8	<i>Authorized IBCs:</i> Metal (11A, 11B, 11N, 21A, 21B, 21N, 31A, 31B and 31N); Rigid plastics (11H1, 11H2, 21H1, 21H2, 31H1 and 31H2); Composite (11HZ1, 11HZ2, 21HZ1, 21HZ2 and 31HZ1); Fiberboard (11G); Wooden (11C, 11D and 11F); Flexible (13H1, 13H2, 13H3, 13H4, 13H5, 13L1, 13L2, 13L3, 13L4, 13M1 or 13M2).
IB9	IBCs are only authorized if approved by the Associate Administrator.

TABLE 2—IP CODES

IP code	
IP1	IBCs must be packed in closed freight containers or a closed transport vehicle.
IP2	When IBCs other than metal or rigid plastics IBCs are used, they must be offered for transportation in a closed freight container or a closed transport vehicle.
IP3	Flexible IBCs must be sift-proof and water-resistant or must be fitted with a sift-proof and water-resistant liner.
IP4	Flexible, fiberboard or wooden IBCs must be sift-proof and water-resistant or be fitted with a sift-proof and water-resistant liner.
IP5	IBCs must have a device to allow venting. The inlet to the venting device must be located in the vapor space of the IBC under maximum filling conditions.
IP6	Non-specification bulk bins are authorized.
IP7	For UN identification numbers 1327, 1363, 1364, 1365, 1386, 1408, 1841, 2211, 2217, 2793 and 3314, IBCs are not required to meet the IBC performance tests specified in part 178, subpart N, of this subchapter.
IP8	Ammonia solutions may be transported in rigid or composite plastic IBCs (31H1, 31H2 and 31HZ1) that have successfully passed, without leakage or permanent deformation, the hydrostatic test specified in § 178.814 of this subchapter at a test pressure that is not less than 1.5 times the vapor pressure of the contents at 55 °C (131 °F).

TABLE 2—IP CODES—Continued

IP code	
IP13	Transportation by vessel in IBCs is prohibited.
IP14	Air must be eliminated from the vapor space by nitrogen or other means.
IP15	For UN2031 with more than 55% nitric acid, rigid plastic IBCs and composite IBCs with a rigid plastic inner receptacle are authorized for two years from the date of IBC manufacture.
IP16	IBCs of type 31A and 31N are only authorized if approved by the Associate Administrator.
IP19	For UN identification numbers 3531, 3532, 3533, and 3534, IBCs must be designed and constructed to permit the release of gas or vapor to prevent a build-up of pressure that could rupture the IBCs in the event of loss of stabilization.
IP20	Dry sodium cyanide or potassium cyanide is also permitted in siftproof, water-resistant, fiberboard IBCs when transported in closed freight containers or transport vehicles.
IP21	When transported by vessel, flexible, fiberboard or wooden IBCs must be sift-proof and water-resistant or be fitted with a sift-proof and water-resistant liner.

TABLE 3—IB CODES
[Large packaging authorizations]

IB3	Authorized Large Packagings (LIQUIDS) (PG III materials only) ²	
Inner packagings: Glass 10 liter Plastics 30 liter Metal 40 liter	Large outer packagings: steel (50A). aluminum (50B). metal other than steel or aluminum (50N). rigid plastics (50H). natural wood (50C). plywood (50D). reconstituted wood (50F). rigid fiberboard (50G).	
IB8	Authorized Large Packagings (SOLIDS) (PG III materials only) ²	
Inner packagings: Glass 10 kg Plastics 50 kg Metal 50 kg Paper 50 kg Fiber 50 kg	Large outer packagings: steel (50A). aluminum (50B). metal other than steel or aluminum (50N). flexible plastics (51H). ¹ rigid plastics (50H). natural wood (50C). plywood (50D). reconstituted wood (50F). rigid fiberboard (50G).	

¹ Flexible plastic (51H) Large Packagings are only authorized for use with flexible inner packagings.
² Except when authorized under Special Provision 41.

(5) “N” codes. These provisions apply only to non-bulk packagings:

Code/Special Provisions

- N3 Glass inner packagings are permitted in combination or composite packagings only if the hazardous material is free from hydrofluoric acid.
- N4 For combination or composite packagings, glass inner packagings, other than ampoules, are not permitted.
- N5 Glass materials of construction are not authorized for any part of a packaging which is normally in contact with the hazardous material.
- N6 Battery fluid packaged with electric storage batteries, wet or dry, must conform to the packaging provisions of §173.159 (g) or (h) of this subchapter.
- N7 The hazard class or division number of the material must be marked on the pack-

- age in accordance with §172.302 of this subchapter. However, the hazard label corresponding to the hazard class or division may be substituted for the marking.
- N8 Nitroglycerin solution in alcohol may be transported under this entry only when the solution is packed in metal cans of not more than 1 L capacity each, overpacked in a wooden box containing not more than 5 L. Metal cans must be completely surrounded with absorbent cushioning material. Wooden boxes must be completely lined with a suitable material impervious to water and nitroglycerin.
- N11 This material is excepted for the specification packaging requirements of this subchapter if the material is packaged in strong, tight non-bulk packaging meeting the requirements of subparts A and B of part 173 of this subchapter.
- N12 Plastic packagings are not authorized.

- N20 A 5M1 multi-wall paper bag is authorized if transported in a closed transport vehicle.
- N25 Steel single packagings are not authorized.
- N32 Aluminum materials of construction are not authorized for single packagings.
- N33 Aluminum drums are not authorized.
- N34 Aluminum construction materials are not authorized for any part of a packaging which is normally in contact with the hazardous material.
- N36 Aluminum or aluminum alloy construction materials are permitted only for halogenated hydrocarbons that will not react with aluminum.
- N37 This material may be shipped in an integrally-lined fiber drum (1G) which meets the general packaging requirements of subpart B of part 173 of this subchapter, the requirements of part 178 of this subchapter at the packing group assigned for the material and to any other special provisions of column 7 of the §172.101 table.
- N40 This material is not authorized in the following packagings:
- A combination packaging consisting of a 4G fiberboard box with inner receptacles of glass or earthenware;
 - A single packaging of a 4C2 sift-proof, natural wood box; or
 - A composite packaging 6PG2 (glass, porcelain or stoneware receptacles within a fiberboard box).
- N41 Metal construction materials are not authorized for any part of a packaging which is normally in contact with the hazardous material.
- N42 1A1 drums made of carbon steel with thickness of body and heads of not less than 1.3 mm (0.050 inch) and with a corrosion-resistant phenolic lining are authorized for stabilized benzyl chloride if tested and certified to the Packing Group I performance level at a specific gravity of not less than 1.8.
- N43 Metal drums are permitted as single packagings only if constructed of nickel or monel.
- N45 Copper cartridges are authorized as inner packagings if the hazardous material is not in dispersion.
- N65 Outage must be sufficient to prevent cylinders or spheres from becoming liquid full at 55 °C (130 °F). The vacant space (outage) may be charged with a nonflammable nonliquefied compressed gas if the pressure in the cylinder or sphere at 55 °C (130 °F) does not exceed 125 percent of the marked service pressure.
- N73 Packagings consisting of outer wooden or fiberboard boxes with inner glass, metal or other strong containers; metal or fiber drums; kegs or barrels; or strong metal cans are authorized and need not conform to the requirements of part 178 of this subchapter.
- N74 Packages consisting of tightly closed inner containers of glass, earthenware, metal or polyethylene, capacity not over 0.5 kg (1.1 pounds) securely cushioned and packed in outer wooden barrels or wooden or fiberboard boxes, not over 15 kg (33 pounds) net weight, are authorized and need not conform to the requirements of part 178 of this subchapter.
- N75 Packages consisting of tightly closed inner packagings of glass, earthenware or metal, securely cushioned and packed in outer wooden barrels or wooden or fiberboard boxes, capacity not over 2.5 kg (5.5 pounds) net weight, are authorized and need not conform to the requirements of part 178 of this subchapter.
- N76 For materials of not more than 25 percent active ingredient by weight, packages consisting of inner metal packagings not greater than 250 mL (8 ounces) capacity each, packed in strong outer packagings together with sufficient absorbent material to completely absorb the liquid contents are authorized and need not conform to the requirements of part 178 of this subchapter.
- N77 For materials of not more than two percent active ingredients by weight, packagings need not conform to the requirements of part 178 of this subchapter, if liquid contents are absorbed in an inert material.
- N78 Packages consisting of inner glass, earthenware, or polyethylene or other non-fragile plastic bottles or jars not over 0.5 kg (1.1 pounds) capacity each, or metal cans not over five pounds capacity each, packed in outer wooden boxes, barrels or kegs, or fiberboard boxes are authorized and need not conform to the requirements of part 178 of this subchapter. Net weight of contents in fiberboard boxes may not exceed 29 kg (64 pounds). Net weight of contents in wooden boxes, barrels or kegs may not exceed 45 kg (99 pounds).
- N79 Packages consisting of tightly closed metal inner packagings not over 0.5 kg (1.1 pounds) capacity each, packed in outer wooden or fiberboard boxes, or wooden barrels, are authorized and need not conform to the requirements of part 178 of this subchapter. Net weight of contents may not exceed 15 kg (33 pounds).
- N80 Packages consisting of one inner metal can, not over 2.5 kg (5.5 pounds) capacity, packed in an outer wooden or fiberboard box, or a wooden barrel, are authorized and need not conform to the requirements of part 178 of this subchapter.
- N82 See §173.115 of this subchapter for classification criteria for flammable aerosols.
- N83 This material may not be transported in quantities of more than 11.5 kg (25.4 lbs) per package.
- N84 The maximum quantity per package is 500 g (1.1 lbs.).

- N85 Packagings certified at the Packing Group I performance level may not be used.
- N86 UN pressure receptacles made of aluminum alloy are not authorized.
- N87 The use of copper valves on UN pressure receptacles is prohibited.
- N88 Any metal part of a UN pressure receptacle in contact with the contents may not contain more than 65% copper, with a tolerance of 1%.
- N89 When steel UN pressure receptacles are used, only those bearing the “H” mark are authorized.
- N90 Metal packagings are not authorized. Packagings of other material with a small amount of metal, for example metal closures or other metal fittings such as those mentioned in part 178 of this subchapter, are not considered metal packagings. Packagings of other material constructed with a small amount of metal must be designed such that the hazardous material does not contact the metal.
- N91 The use of a non specification sift-proof, non-bulk, metal can with or without lid, or a non specification sift-proof, non-bulk fiber drum, with or without lid is authorized when transporting coal tar pitch compounds by motor vehicle or rail freight. The fiber drum must be fabricated with a three ply wall, as a minimum. The coal tar pitch compound must be in a solid mass during transportation.
- N92 Notwithstanding the provisions of §173.24(g) of this subchapter, packagings shall be designed and constructed to permit the release of gas or vapor to prevent a build-up of pressure that could rupture the packagings in the event of loss of stabilization.
- N95 UN1075, Liquefied petroleum gas and UN1978, Propane authorized for transport in DOT 4BA240 cylinders is not subject to the UN identification number and proper shipping name marking or the label requirements of this part subject to the following conditions:
- The cylinder must be transported in a closed motor vehicle displaying FLAMMABLE GAS placards in accordance with subpart F of part 172 of this subchapter.
 - Shipping papers at all times must reflect a correct current accounting of all cylinders both full and expended.
 - The cylinders are collected and transported by a private or a contract carrier for reconditioning, reuse or disposal.

(6) “R” codes. These provisions apply only to transportation by rail.

R1 A person who offers for transportation tank cars containing sulfur, molten or residue of sulfur, molten may reference the Sulfur Institute’s, “Molten Sulphur Rail Tank Car Guidance document” (see §171.7 of this subchapter) to identify tank cars that may pose a risk in transportation due to the accumulation of formed, solid sulfur on the outside of the tank.

(7) “T” codes. (i) These provisions apply to the transportation of hazardous materials in UN portable tanks. Portable tank instructions specify the requirements applicable to a portable tank when used for the transportation of a specific hazardous material. These requirements must be met in addition to the design and construction specifications in part 178 of this subchapter. Portable tank instructions T1 through T22 specify the applicable minimum test pressure, the minimum shell thickness (in reference steel), bottom opening requirements and pressure relief requirements. Liquefied compressed gases are assigned to portable tank instruction T50. Refrigerated liquefied gases that are authorized to be transported in portable tanks are specified in tank instruction T75.

(ii) The following table specifies the portable tank requirements applicable to “T” Codes T1 through T22. Column 1 specifies the “T” Code. Column 2 specifies the minimum test pressure, in bar (1 bar = 14.5 psig), at which the periodic hydrostatic testing required by §180.605 of this subchapter must be conducted. Column 3 specifies the section reference for minimum shell thickness or, alternatively, the minimum shell thickness value. Column 4 specifies the applicability of §178.275(g)(3) of this subchapter for the pressure relief devices. When the word “Normal” is indicated, §178.275(g)(3) of this subchapter does not apply. Column 5 references applicable requirements for bottom openings in part 178 of this subchapter. “Prohibited” means bottom openings are prohibited, and “Prohibited for liquids” means bottom openings are authorized for solid material only. The table follows:

TABLE OF PORTABLE TANK T CODES T1–T22

[Portable tank codes T1–T22 apply to liquid and solid hazardous materials of Classes 3 through 9 which are transported in portable tanks.]

Portable tank instruction (1)	Minimum test pressure (bar) (2)	Minimum shell thickness (in mm-reference steel) (See § 178.274(d)) (3)	Pressure-relief requirements (See § 178.275(g)) (4)	Bottom opening requirements (See § 178.275(d)) (5)
T1	1.5	§ 178.274(d)(2)	Normal	§ 178.275(d)(2)
T2	1.5	§ 178.274(d)(2)	Normal	§ 178.275(d)(3)
T3	2.65	§ 178.274(d)(2)	Normal	§ 178.275(d)(2)
T4	2.65	§ 178.274(d)(2)	Normal	§ 178.275(d)(3)
T5	2.65	§ 178.274(d)(2)	§ 178.275(g)(3)	Prohibited
T6	4	§ 178.274(d)(2)	Normal	§ 178.275(d)(2)
T7	4	§ 178.274(d)(2)	Normal	§ 178.275(d)(3)
T8	4	§ 178.274(d)(2)	Normal	Prohibited
T9	4	6 mm	Normal	Prohibited for liquids.
T10	4	6 mm	§ 178.275(g)(3)	Prohibited
T11	6	§ 178.274(d)(2)	Normal	§ 178.275(d)(3)
T12	6	§ 178.274(d)(2)	§ 178.275(g)(3)	§ 178.275(d)(3)
T13	6	6 mm	Normal	Prohibited
T14	6	6 mm	§ 178.275(g)(3)	Prohibited
T15	10	§ 178.274(d)(2)	Normal	§ 178.275(d)(3)
T16	10	§ 178.274(d)(2)	§ 178.275(g)(3)	§ 178.275(d)(3)
T17	10	6 mm	Normal	§ 178.275(d)(3)
T18	10	6 mm	§ 178.275(g)(3)	§ 178.275(d)(3)
T19	10	6 mm	§ 178.275(g)(3)	Prohibited
T20	10	8 mm	§ 178.275(g)(3)	Prohibited
T21	10	10 mm	Normal	Prohibited for liquids.
T22	10	10 mm	§ 178.275(g)(3)	§ 178.275(d)(2). Prohibited

(iii) T50 When portable tank instruction T50 is indicated in Column (7) of the §172.101 Hazardous Materials Table, the applicable liquefied compressed gas and chemical under pressure descriptions are authorized to be transported in portable tanks in accordance with the requirements of §173.313 of this subchapter.

(iv) T75. When portable tank instruction T75 is referenced in Column (7) of the §172.101 Table, the applicable refrigerated liquefied gases are authorized to be transported in portable tanks in accordance with the requirements of §178.277 of this subchapter.

(v) *UN and IM portable tank codes/special provisions.* When a specific portable tank instruction is specified by a “T” Code in Column (7) of the §172.101 Table for a specific hazardous material, a specification portable tank conforming to an alternative tank instruction may be used if:

(A) The alternative portable tank has a higher or equivalent test pressure (for example, 4 bar when 2.65 bar is specified);

(B) The alternative portable tank has greater or equivalent wall thickness (for example, 10 mm when 6 mm is specified);

(C) The alternative portable tank has a pressure relief device as specified in the “T” Code. If a frangible disc is required in series with the reclosing pressure relief device for the specified portable tank, the alternative portable tank must be fitted with a frangible disc in series with the reclosing pressure relief device; and

(D) With regard to bottom openings—

(1) When two effective means are specified, the alternative portable tank is fitted with bottom openings having two or three effective means of closure or no bottom openings; or

(2) When three effective means are specified, the portable tank has no bottom openings or three effective means of closure; or

(3) When no bottom openings are authorized, the alternative portable tank must not have bottom openings.

(vi) Except when an organic peroxide is authorized under §173.225(g), if a hazardous material is not assigned a portable tank “T” Code, the hazardous material may not be transported in a portable tank unless approved by the Associate Administrator.

§ 172.102

49 CFR Ch. I (10–1–23 Edition)

(8) “TP” codes. (i) These provisions apply to the transportation of hazardous materials in IM and UN Specification portable tanks. Portable tank special provisions are assigned to certain hazardous materials to specify requirements that are in addition to those provided by the portable tank instructions or the requirements in part 178 of this subchapter. Portable tank special provisions are designated with the abbreviation TP (tank provision) and are assigned to specific hazardous materials in Column (7) of the §172.101 Table.

(ii) The following is a list of the portable tank special provisions:

Code/Special Provisions

TP1 The maximum degree of filling must not exceed the degree of filling determined by the following:

$$\left(\text{Degree of filling} = \frac{97}{1 + \alpha(t_r - t_f)} \right).$$

Where:

t_r is the maximum mean bulk temperature during transport, and t_f is the temperature in degrees celsius of the liquid during filling.

TP2 a. The maximum degree of filling must not exceed the degree of filling determined by the following:

$$\left(\text{Degree of filling} = \frac{95}{1 + \alpha(t_r - t_f)} \right).$$

Where:

t_r is the maximum mean bulk temperature during transport,

t_f is the temperature in degrees celsius of the liquid during filling, and

α is the mean coefficient of cubical expansion of the liquid between the mean temperature of the liquid during filling (t_f) and the maximum mean bulk temperature during transportation (t_r) both in degrees celsius.

b. For liquids transported under ambient conditions α may be calculated using the formula:

$$\alpha = \frac{d_{15} - d_{50}}{35 d_{50}}$$

Where:

d_{15} and d_{50} are the densities (in units of mass per unit volume) of the liquid at 15 °C (59 °F) and 50 °C (122 °F), respectively.

TP3 The maximum degree of filling (in %) for solids transported above their melting points and for elevated temperature liquids shall be determined by the following:

$$\left(\text{Degree of filling} = 95 \frac{d_r}{d_f} \right).$$

Where: d_r and d_f are the mean densities of the liquid at the mean temperature of the liquid during filling and the maximum mean bulk temperature during transport respectively.

TP4 The maximum degree of filling for portable tanks must not exceed 90%.

TP5 For a portable tank used for the transport of flammable refrigerated liquefied gases or refrigerated liquefied oxygen, the maximum rate at which the portable tank may be filled must not exceed the liquid flow capacity of the primary pressure relief system rated at a pressure not exceeding 120 percent of the portable tank’s design pressure. For portable tanks used for the transport of refrigerated liquefied helium and refrigerated liquefied atmospheric gas (except oxygen), the maximum rate at which the tank is filled must not exceed the liquid flow capacity of the pressure relief device rated at 130 percent of the portable tank’s design pressure. Except for a portable tank containing refrigerated liquefied helium, a portable tank shall have an outage of at least two percent below the inlet of the pressure relief device or pressure control valve, under conditions of incipient opening, with the portable tank in a level attitude. No outage is required for helium.

TP6 The tank must be equipped with a pressure release device which prevent a tank from bursting under fire engulfment conditions (the conditions prescribed in CGA pamphlet S-1.2 (see §171.7 of this subchapter) or alternative conditions approved by the Associate Administrator may be used to consider the fire engulfment condition), taking into account the properties of the hazardous material to be transported.

TP7 The vapor space must be purged of air by nitrogen or other means.

TP8 A portable tank having a minimum test pressure of 1.5 bar (150 kPa) may be used when the flash point of the hazardous material transported is greater than 0 °C (32 °F).

TP9 A hazardous material assigned to special provision TP9 in Column (7) of the §172.101 Table may only be transported in a portable tank if approved by the Associate Administrator.

TP10 A lead lining, not less than 5 mm thick, which shall be tested annually, or another suitable lining material approved by the competent authority, is required. A portable tank may be offered for transport after the date of expiry of the last lining inspection for a period not to exceed three months for purposes of performing the next required

test or inspection, after emptying but before cleaning.

TP12 This material is considered highly corrosive to steel.

TP13 Self-contained breathing apparatus must be provided when this hazardous material is transported by sea.

TP16 The portable tank must be protected against over and under pressurization which may be experienced during transportation. The means of protection must be approved by the approval agency designated to approve the portable tank in accordance with the procedures in part 107, subpart E, of this subchapter. The pressure relief device must be preceded by a frangible disk in accordance with the requirements in §178.275(g)(3) of this subchapter to prevent crystallization of the product in the pressure relief device.

TP17 Only inorganic non-combustible materials may be used for thermal insulation of the tank.

TP18 The temperature of this material must be maintained between 18 °C (64.4 °F) and 40 °C (104 °F) while in transportation. Portable tanks containing solidified methacrylic acid must not be reheated during transportation.

TP19 The calculated wall thickness must be increased by 3 mm at the time of construction. Wall thickness must be verified ultrasonically at intervals midway between periodic hydraulic tests (every 2.5 years). The portable tank must not be used if the wall thickness is less than that prescribed by the applicable T code in Column (7) of the Table for this material.

TP20 This hazardous material must only be transported in insulated tanks under a nitrogen blanket.

TP21 The wall thickness must not be less than 8 mm. Portable tanks must be hydraulically tested and internally inspected at intervals not exceeding 2.5 years.

TP22 Lubricants for portable tank fittings (for example, gaskets, shut-off valves, flanges) must be oxygen compatible.

TP24 The portable tank may be fitted with a device to prevent the build up of excess pressure due to the slow decomposition of the hazardous material being transported. The device must be in the vapor space when the tank is filled under maximum filling conditions. This device must also prevent an unacceptable amount of leakage of liquid in the case of overturning.

TP25 Sulphur trioxide 99.95% pure and above may be transported in tanks without an inhibitor provided that it is maintained at a temperature equal to or above 32.5 °C (90.5 °F).

TP26 The heating device must be exterior to the shell. For UN 3176, this requirement only applies when the hazardous material reacts dangerously with water.

TP27 A portable tank having a minimum test pressure of 4 bar (400 kPa) may be used provided the calculated test pressure is 4 bar or less based on the MAWP of the hazardous material, as defined in §178.275 of this subchapter, where the test pressure is 1.5 times the MAWP.

TP28 A portable tank having a minimum test pressure of 2.65 bar (265 kPa) may be used provided the calculated test pressure is 2.65 bar or less based on the MAWP of the hazardous material, as defined in §178.275 of this subchapter, where the test pressure is 1.5 times the MAWP.

TP29 A portable tank having a minimum test pressure of 1.5 bar (150.0 kPa) may be used provided the calculated test pressure is 1.5 bar or less based on the MAWP of the hazardous materials, as defined in §178.275 of this subchapter, where the test pressure is 1.5 times the MAWP.

TP30 This hazardous material may only be transported in insulated tanks.

TP31 This hazardous material may only be transported in tanks in the solid state.

TP32 Portable tanks may be used subject to the following conditions:

a. Each portable tank constructed of metal must be fitted with a pressure-relief device consisting of a reclosing spring loaded type, a frangible disc or a fusible element. The set to discharge for the spring loaded pressure relief device and the burst pressure for the frangible disc, as applicable, must not be greater than 2.65 bar for portable tanks with minimum test pressures greater than 4 bar;

b. The suitability for transport in tanks must be demonstrated using test 8(d) in Test Series 8 (see UN Manual of Tests and Criteria, Part 1, Sub-section 18.7) (IBR, see §171.7 of this subchapter) or an alternative means approved by the Associate Administrator.

TP33 The portable tank instruction assigned for this substance applies for granular and powdered solids and for solids which are filled and discharged at temperatures above their melting point which are cooled and transported as a solid mass. Solid substances transported or offered for transport above their melting point are authorized for transportation in portable tanks conforming to the provisions of portable tank instruction T4 for solid substances of packing group III or T7 for solid substances of packing group II, unless a tank with more stringent requirements for minimum shell thickness, maximum allowable working pressure, pressure-relief devices or bottom outlets are assigned in which case the more stringent tank instruction and special provisions shall apply. Filling limits must be in accordance with portable tank special provision TP3. Solids meeting the definition of an elevated temperature material must be transported in accordance with the applicable requirements of this subchapter.

§ 172.102, Nf.

49 CFR Ch. I (10–1–23 Edition)

TP36 For material assigned this portable tank special provision, portable tanks used to transport such material may be equipped with fusible elements in the vapor space of the portable tank.

TP37 IM portable tanks are only authorized for the shipment of hydrogen peroxide solutions in water containing 72% or less hydrogen peroxide by weight. Pressure relief devices shall be designed to prevent the entry of foreign matter, the leakage of liquid and the development of any dangerous excess pressure. In addition, the portable tank must be designed so that internal surfaces may be effectively cleaned and passivated. Each tank must be equipped with pressure relief devices conforming to the following requirements:

Concentration of hydrogen peroxide solution	Total ¹
52% or less	11
Over 52%, but not greater than 60%	22
Over 60%, but not greater than 72%	32

¹Total venting capacity in standard cubic feet hour (S.C.F.H.) per pound of hydrogen peroxide solution.

TP38 Each portable tank must be insulated with an insulating material so that the overall thermal conductance at 15.5 °C (60 °F) is no more than 1.5333 kilojoules per hour per square meter per degree Celsius (0.075 Btu per hour per square foot per degree Fahrenheit) temperature differential. Insulating materials may not promote corrosion to steel when wet.

TP39 [Reserved]

TP40 The portable tank must not be transported when connected with spray application equipment.

TP41 [Reserved]

TP44 Each portable tank must be made of stainless steel, except that steel other than stainless steel may be used in accordance with the provisions of §173.24b(b) of this subchapter. Thickness of stainless steel for tank shell and heads must be the greater of 7.62 mm (0.300 inch) or the thickness required for a portable tank with a design pressure at least equal to 1.5 times the vapor pressure of the hazardous material at 46 °C (115 °F).

TP45 Each portable tank must be made of stainless steel, except that steel other than stainless steel may be used in accordance with the provisions of 173.24b(b) of this subchapter. Thickness of stainless steel for portable tank shells and heads must be the greater of 6.35 mm (0.250 inch) or the thickness required for a portable tank with a design pressure at least equal to 1.3 times the vapor pressure of the hazardous material at 46 °C (115 °F).

TP46 Portable tanks in sodium metal service are not required to be hydrostatically retested.

TP47 The 2.5 year internal examination may be waived or substituted by other test methods or inspection procedures specified

by the competent authority or its authorized body, provided that the portable tank is dedicated to the transport of the organometallic substances to which this tank special provision is assigned. However this examination is required when the conditions of §180.605(f) are met.

(9) “W” codes. These provisions apply only to transportation by water:

Code/Special Provisions

W1 This substance in a non friable prill or granule form is not subject to the requirements of this subchapter when tested in accordance with the UN Manual of Test and Criteria (IBR, see §171.7 of this subchapter) and is found to not meet the definition or criteria for inclusion in Division 5.1.

W7 Vessel stowage category for uranyl nitrate hexahydrate solution is “D” as defined in §172.101(k)(4).

W8 Vessel stowage category for pyrophoric thorium metal or pyrophoric uranium metal is “D” as defined in §172.101(k)(4).

W9 When offered for transportation by water, the following Specification packagings are not authorized unless approved by the Associate Administrator: woven plastic bags, plastic film bags, textile bags, paper bags, IBCs and bulk packagings.

W10 When offered for transportation by vessel, the use of Large Packagings (see §171.8 of this subchapter) is prohibited.

W31 Non-bulk packagings must be hermetically sealed.

W40 Non-bulk bags are not allowed.

W41 When offered for transportation by water, this material must be packaged in bales and be securely and tightly bound with rope, wire or similar means.

W100 Non-bulk flexible, fibreboard or wooden packagings must be sift-proof and water-resistant or must be fitted with a sift-proof and water-resistant liner.

[Amdt. 172–123, 55 FR 52582, Dec. 21, 1990]

EDITORIAL NOTE: For FEDERAL REGISTER citations affecting §172.102, see the List of CFR Sections Affected, which appears in the Finding Aids section of the printed volume and at www.govinfo.gov.

EFFECTIVE DATE NOTE: At 88 FR 60375, Sept. 1, 2023, in §172.102, paragraph (c)(1) was amended by adding special provision 439, effective Oct. 31, 2023. For the convenience of the user, the added text is set forth as follows:

§ 172.102 Special provisions.

* * * * *

(c) * * *

(1) * * *

439 UN1972 is not authorized for transportation by rail tank car until either issuance of a final rule concluding the rulemaking action proceeding under RIN 2137-AF54, or June 30, 2025, whichever occurs first. For information and the status of RIN 2137-AF54, please refer to the Office of Management and Budget's Office of Information and Regulatory Affairs at www.reginfo.gov.

* * * * *

Subpart C—Shipping Papers

§ 172.200 Applicability.

(a) *Description of hazardous materials required.* Except as otherwise provided in this subpart, each person who offers a hazardous material for transportation shall describe the hazardous material on the shipping paper in the manner required by this subpart.

(b) This subpart does not apply to any material, other than a hazardous substance, hazardous waste or marine pollutant, that is—

(1) Identified by the letter “A” in column 1 of the § 172.101 table, except when the material is offered or intended for transportation by air; or

(2) Identified by the letter “W” in column 1 of the § 172.101 table, except when the material is offered or intended for transportation by water; or

(3) A limited quantity package unless the material is offered for transportation by aircraft or vessel.

(4) Category B infectious substances prepared in accordance with § 173.199.

[Amdt. 172-29A, 41 FR 40677, Sept. 20, 1976, as amended by Amdt. 172-58, 45 FR 34697, May 22, 1980; Amdt. 172-74, 47 FR 43065, Sept. 30, 1982; Amdt. 172-112, 53 FR 17160, May 13, 1988; Amdt. 172-127, 57 FR 52938, Nov. 5, 1992; 71 FR 32258, June 2, 2006; 76 FR 3365, Jan. 19, 2011; 78 FR 1112, Jan. 7, 2013; 87 FR 79772, Dec. 27, 2022]

§ 172.201 Preparation and retention of shipping papers.

(a) *Contents.* When a description of hazardous material is required to be included on a shipping paper, that description must conform to the following requirements:

(1) When a hazardous material and a material not subject to the requirements of this subchapter are described on the same shipping paper, the hazardous material description entries re-

quired by § 172.202 and those additional entries that may be required by § 172.203:

(i) Must be entered first, or

(ii) Must be entered in a color that clearly contrasts with any description on the shipping paper of a material not subject to the requirements of this subchapter, except that a description on a reproduction of a shipping paper may be highlighted, rather than printed, in a contrasting color (the provisions of this paragraph apply only to the basic description required by § 172.202(a)(1), (2), (3), and (4)), or

(iii) Must be identified by the entry of an “X” placed before the basic shipping description required by § 172.202 in a column captioned “HM.” (The “X” may be replaced by “RQ,” if appropriate.)

(2) The required shipping description on a shipping paper and all copies of the shipping paper used for transportation purposes must be legible and printed (manually or mechanically) in English.

(3) Unless it is specifically authorized or required in this subchapter, the required shipping description may not contain any code or abbreviation.

(4) A shipping paper may contain additional information concerning the material provided the information is not inconsistent with the required description. Unless otherwise permitted or required by this subpart, additional information must be placed after the basic description required by § 172.202(a).

(5) *Electronic shipping papers.* For transportation by rail, a rail carrier may accept shipping paper information either telephonically (i.e., voice communications and facsimiles) or electronically (EDI) from an offeror of a hazardous materials shipment in accordance with the provisions in paragraphs (a)(5)(i)–(a)(5)(iv) of this section. See § 171.8 for the EDI definition.

(i) When the information applicable to the consignment is provided under this requirement the information must be available to the offeror and carrier at all times during transport, and the carrier must have and maintain a printed copy of this information until delivery of the hazardous materials on the shipping paper is complete. When a

§ 172.202

49 CFR Ch. I (10–1–23 Edition)

paper document is produced, the data must be presented as required by this subpart.

(ii) The offeror must forward the shipping paper (record) for a loaded movement to the carrier prior to shipment unless the carrier prepares the shipping paper on behalf of the offeror. The offeror is only relieved of the duty to forward the shipping paper once the offeror has received a copy of the shipping paper from the carrier;

(iii) A carrier that generates a residue shipping paper using information from the previous loaded movement of a hazardous materials packaging must ensure the description of the hazardous material that accompanies the shipment complies with the offeror's request; and

(iv) *Verification.* The carrier and the offeror must have a procedure by which the offeror can verify accuracy of the transmitted hazard communication information that will accompany the shipment.

(b) [Reserved]

(c) *Continuation page.* A shipping paper may consist of more than one page, if each page is consecutively numbered and the first page bears a notation specifying the total number of pages included in the shipping paper. For example, "Page 1 of 4 pages."

(d) *Emergency response telephone number.* Except as provided in §172.604(d), a shipping paper must contain an emergency response telephone number and, if utilizing an emergency response information telephone number service provider, identify the person (by name or contract number) who has a contractual agreement with the service provider, as prescribed in subpart G of this part.

(e) *Retention and Recordkeeping.* Each person who provides a shipping paper must retain a copy of the shipping paper required by §172.200(a), or an electronic image thereof, that is accessible at or through its principal place of business and must make the shipping paper available, upon request, to an authorized official of a Federal, State, or local government agency at reasonable times and locations. For a hazardous waste, the shipping paper copy must be retained for three years after the material is accepted by the

initial carrier. For all other hazardous materials, the shipping paper must be retained for two years after the material is accepted by the initial carrier. Each shipping paper copy must include the date of acceptance by the initial carrier, except that, for rail, vessel, or air shipments, the date on the shipment waybill, airbill, or bill of lading may be used in place of the date of acceptance by the initial carrier. A motor carrier (as defined in §390.5 of subchapter B of chapter III of subtitle B) using a shipping paper without change for multiple shipments of one or more hazardous materials having the same shipping name and identification number may retain a single copy of the shipping paper, instead of a copy for each shipment made, if the carrier also retains a record of each shipment made, to include shipping name, identification number, quantity transported, and date of shipment.

[Amdt. 172–29A, 41 FR 40677, Sept. 20, 1976]

EDITORIAL NOTE: For FEDERAL REGISTER citations affecting §172.201, see the List of CFR Sections Affected, which appears in the Finding Aids section of the printed volume and at www.govinfo.gov.

§ 172.202 Description of hazardous material on shipping papers.

(a) The shipping description of a hazardous material on the shipping paper must include:

(1) The identification number prescribed for the material as shown in Column (4) of the §172.101 table;

(2) The proper shipping name prescribed for the material in Column (2) of the §172.101 table;

(3) The hazard class or division number prescribed for the material, as shown in Column (3) of the §172.101 table. The subsidiary hazard class or division number is not required to be entered when a corresponding subsidiary hazard label is not required. Except for combustible liquids, the subsidiary hazard class(es) or subsidiary division number(s) must be entered in parentheses immediately following the primary hazard class or division number. In addition—

(i) The words "Class" or "Division" may be included preceding the primary and subsidiary hazard class or division numbers.

(ii) The hazard class need not be included for the entry "Combustible liquid, n.o.s."

(iii) For domestic shipments, primary and subsidiary hazard class or division names may be entered following the numerical hazard class or division, or following the basic description.

(4) The packing group in Roman numerals, as designated for the hazardous material in Column (5) of the §172.101 table, Class 1 (explosives) materials; self-reactive substances; Division 5.2 materials; and entries that are not assigned a packing group (e.g., Class 7) are excepted from this requirement. The packing group may be preceded by the letters "PG" (for example, "PG II"); and

(5) Except for transportation by aircraft, the total quantity of hazardous materials covered by the description must be indicated (by mass or volume, or by activity for Class 7 materials) and must include an indication of the applicable unit of measurement, for example, "200 kg" (440 pounds) or "50 L" (13 gallons). The following provisions also apply:

(i) For Class 1 materials, the quantity must be the net explosive mass. For an explosive that is an article, such as Cartridges, small arms, the net explosive mass may be expressed in terms of the net mass of either the article or the explosive materials contained in the article.

(ii) For hazardous materials in salvage packaging, an estimate of the total quantity is acceptable.

(iii) The following are excepted from the requirements of paragraph (a)(5) of this section:

(A) Bulk packages, provided some indication of the total quantity is shown, for example, "1 cargo tank" or "2 IBCs."

(B) Cylinders, provided some indication of the total quantity is shown, for example, "10 cylinders."

(C) Packages containing only residue.

(6) For transportation by aircraft, the total net mass per package, must be shown unless a gross mass is indicated in Columns (9A) or (9B) of the §172.101 table in which case the total gross mass per package must be shown; or, for Class 7 materials, the quantity of radioactive material must be shown

by activity. The following provisions also apply:

(i) For empty uncleaned packaging, only the number and type of packaging must be shown;

(ii) For chemical kits and first aid kits, the total net mass of hazardous materials must be shown. Where the kits contain only liquids, or solids and liquids, the net mass of liquids within the kits is to be calculated on a 1 to 1 basis, i.e., 1 L (0.3 gallons) equals 1 kg (2.2 pounds);

(iii) For dangerous goods in machinery or apparatus, the individual total quantities or an estimate of the individual total quantities of dangerous goods in solid, liquid or gaseous state, contained in the article must be shown;

(iv) For dangerous goods transported in a salvage packaging, an estimate of the quantity of dangerous goods per package must be shown;

(v) For cylinders, total quantity may be indicated by the number of cylinders, for example, "10 cylinders;"

(vi) For items where "No Limit" is shown in Column (9A) or (9B) of the §172.101 table, the quantity shown must be the net mass or volume of the material. For articles (e.g., UN2800 and UN3166) the quantity must be the gross mass, followed by the letter "G"; and

(vii) For hazardous materials in limited quantities, the total net quantity per package must be shown unless a gross mass is indicated in Column 4 of §173.27 Table 3, in which case the total gross mass per package must be shown. Where different hazardous materials in limited quantities are packed together in the same outer packaging, when a gross mass is indicated Column 4 of §173.27 Table 3, the net quantity of each hazardous material must be shown in addition to the gross mass of the completed package.

(viii) For authorized consumer commodities, the information provided may be either the gross mass of each package or the average gross mass of the packages.

(7) The number and type of packages must be indicated. The type of packages must be indicated by description of the package (for example, "12 drums"). Indication of the packaging specification number ("1H1") may be

§ 172.203

included in the description of the package (for example, “12 1H1 drums” or “12 drums (UN 1A1)”). Abbreviations may be used for indicating packaging types (for example, “cyl.” for “cylinder”) provided the abbreviations are commonly accepted and recognizable.

(b) Except as provided in this subpart, the basic description specified in paragraphs (a)(1), (2), (3), and (4) of this section must be shown in sequence with no additional information interspersed. For example, “UN2744, Cyclobutyl chloroformate, 6.1, (8, 3), PG II.” Shipping descriptions for hazardous materials offered or intended for transportation by rail that contain all the information required in this subpart and that are formatted and ordered in accordance with recognized electronic data interchange standards and, to the extent possible, in the order and manner required by this subpart are deemed to comply with this paragraph.

(c)(1) The total quantity of the material covered by one description must appear before or after, or both before and after, the description required and authorized by this subpart. The type of packaging and destination marks may be entered in any appropriate manner before or after the basic description. Abbreviations may be used to express units of measurement and types of packagings.

(2) Hazardous materials and hazardous substances transported by highway considered “household wastes” as defined in 40 CFR 261.4, and not subject to the Environmental Protection Agency’s hazardous waste regulations in 40 CFR parts 262 and 263, are excepted from the requirements of this paragraph.

(d) Technical and chemical group names may be entered in parentheses between the proper shipping name and hazard class or following the basic description. An appropriate modifier, such as “contains” or “containing,” and/or the percentage of the technical constituent may also be used. For example: “UN 1993, Flammable liquids, n.o.s. (contains Xylene and Benzene), 3, II”.

(e) Except for those materials in the UN Recommendations, the ICAO Technical Instructions, or the IMDG Code

49 CFR Ch. I (10–1–23 Edition)

(IBR, see §171.7 of this subchapter), a material that is not a hazardous material according to this subchapter may not be offered for transportation or transported when its description on a shipping paper includes a hazard class or an identification number specified in the §172.101 Table.

[Amdt. 172–101, 45 FR 74665, Nov. 10, 1980]

EDITORIAL NOTE: For FEDERAL REGISTER citations affecting §172.202, see the List of CFR Sections Affected, which appears in the Finding Aids section of the printed volume and at www.govinfo.gov.

§ 172.203 Additional description requirements.

(a) *Special permits.* Except as provided in §173.23 of this subchapter, each shipping paper issued in connection with a shipment made under a special permit must bear the notation “DOT-SP” followed by the special permit number assigned and located so that the notation is clearly associated with the description to which the special permit applies. Each shipping paper issued in connection with a shipment made under an exemption or special permit issued prior to October 1, 2007, may bear the notation “DOT-E” followed by the number assigned and so located that the notation is clearly associated with the description to which it applies.

(b) *Limited quantities.* When a shipping paper is required by this subchapter, the description for a material offered for transportation as “limited quantity,” as authorized by this subchapter, must include the words “Limited Quantity” or “Ltd Qty” following the basic description.

(c) *Hazardous substances.* (1) Except for Class 7 (radioactive) materials described in accordance with paragraph (d) of this section, if the proper shipping name for a material that is a hazardous substance does not identify the hazardous substance by name, the name of the hazardous substance must be entered in parentheses in association with the basic description. If the material contains two or more hazardous substances, at least two hazardous substances, including the two with the lowest reportable quantities (RQs), must be identified. For a hazardous waste, the waste code (e.g.,

D001), if appropriate, may be used to identify the hazardous substance.

(2) The letters "RQ" must be entered on the shipping paper either before or after the basic description required by § 172.202 for each hazardous substance (see definition in § 171.8 of this subchapter). For example: "RQ, UN 1098, Allyl alcohol, 6.1, I, Toxic-inhalation hazard, Zone B"; or "UN 3077, Environmentally hazardous substances, solid, n.o.s., 9, III, RQ (Adipic acid)".

(d) *Radioactive material.* The description for a shipment of a Class 7 (radioactive) material must include the following additional entries as appropriate:

(1) The name of each radionuclide in the Class 7 (radioactive) material that is listed in § 173.435 of this subchapter. For mixtures of radionuclides, the radionuclides required to be shown must be determined in accordance with § 173.433(g) of this subchapter. Abbreviations, *e.g.*, "⁹⁹Mo," are authorized.

(2) A description of the physical and chemical form of the material:

(i) For special form materials, the words "special form" unless the words "special form" already appear in the proper shipping name; or

(ii) If the material is not in special form, a description of the physical and chemical form of the material (generic chemical descriptions are permitted).

(3) The maximum activity of the radioactive contents contained in each package during transport in terms of the appropriate SI units (*e.g.*, Becquerels (Bq), Terabecquerels (TBq)). The activity may also be stated in appropriate customary units (*e.g.*, Curies (Ci), milliCuries (mCi), microCuries (uCi)) in parentheses following the SI units. Abbreviations are authorized. Except for plutonium-239 and plutonium-241, the weight in grams or kilograms of fissile radionuclides (or the mass of each fissile nuclide for mixtures when appropriate) may be inserted instead of activity units. For plutonium-239 and plutonium-241, the weight in grams of fissile radionuclides (or the mass of each fissile nuclide for mixtures when appropriate) may be inserted in addition to the activity units.

(4) The category of label applied to each package in the shipment. For ex-

ample: "RADIOACTIVE WHITE-I," or "WHITE-I."

(5) The transport index assigned to each package in the shipment bearing RADIOACTIVE YELLOW-II or RADIOACTIVE YELLOW-III labels.

(6) For a package containing fissile Class 7 (radioactive) material:

(i) The words "Fissile Excepted" if the package is excepted pursuant to § 173.453 of this subchapter; or otherwise

(ii) The criticality safety index for that package.

(7) For a package approved by the U.S. Department of Energy (DOE) or U.S. Nuclear Regulatory Commission (NRC), a notation of the package identification marking as prescribed in the applicable DOE or NRC approval (see § 173.471 of the subchapter).

(8) For an export shipment or a shipment in a foreign made package, a notation of the package identification marking as prescribed in the applicable International Atomic Energy Agency (IAEA) Certificate of Competent Authority which has been issued for the package (see § 173.473 of the subchapter).

(9) For a shipment required by this subchapter to be consigned as exclusive use:

(i) An indication that the shipment is consigned as exclusive use; or

(ii) If all the descriptions on the shipping paper are consigned as exclusive use, then the statement "Exclusive Use Shipment" may be entered only once on the shipping paper in a clearly visible location.

(10) For the shipment of a package containing a highway route controlled quantity of Class 7 (radioactive) materials (see § 173.403 of this subchapter) the words "Highway route controlled quantity" or "HRCQ" must be entered in association with the basic description.

(e) *Empty packagings.* (1) The description on the shipping paper for a packaging containing the residue of a hazardous material may include the words "RESIDUE: Last Contained * * *" immediately before or after the basic shipping description on the shipping paper.

(2) The description on the shipping paper for a tank car containing the residue of a hazardous material must include the phrase, “RESIDUE: Last Contained * * *” immediately before or after the basic shipping description or immediately preceding the proper shipping name of the material on the shipping paper.

(f) *Transportation by air.* A statement indicating that the shipment is within the limitations prescribed for either passenger and cargo aircraft or cargo aircraft only must be entered on the shipping paper.

(g) *Transportation by rail.* (1) A shipping paper prepared by a rail carrier for a rail car, freight container, transport vehicle or portable tank that contains hazardous materials must include the reporting mark and number when displayed on the rail car, freight container, transport vehicle or portable tank.

(2) The shipping paper for each DOT-113 tank car containing a Division 2.1 material or its residue must contain an appropriate notation, such as “DOT 113”, and the statement “Do not hump or cut off car while in motion.”

(3) When shipments of elevated temperature materials are transported under the exception permitted in §173.247(h)(3) of this subchapter, the shipping paper must contain an appropriate notation, such as “Maximum operating speed 15 mph.”

(h) *Transportation by highway.* Following the basic description for a hazardous material in a Specification MC 330 or MC 331 cargo tank, there must be entered for—

(1) *Anhydrous ammonia.* (i) The words “0.2 PERCENT WATER” to indicate the suitability for shipping anhydrous ammonia in a cargo tank made of quenched and tempered steel as authorized by §173.315(a), Note 14 of this subchapter, or

(ii) The words “NOT FOR Q and T TANKS” when the anhydrous ammonia does not contain 0.2 percent or more water by weight.

(2) *Liquefied petroleum gas.* (i) The word “NONCORROSIVE” or “NONCOR” to indicate the suitability for shipping “Noncorrosive” liquefied petroleum gas in a cargo tank made of quenched and tempered steel as author-

ized by §173.315(a), Note 15 of this subchapter, or

(ii) The words “NOT FOR Q and T TANKS” for grades of liquefied petroleum gas other than “Noncorrosive”.

(i) *Transportation by water.* Each shipment by water must have the following additional shipping paper entries:

(1) The name of the shipper.

(2) A minimum flashpoint, if 60 °C (140 °F) or below (in °C closed cup (c.c.)), in association with the basic description, for Class 3 flammable liquid materials (as a primary or subsidiary hazard). For lab packs packaged in conformance with §173.12(b) of this subchapter, an indication that the lowest flashpoint of all hazardous materials contained in the lab pack is below 23 °C or that the flash point is not less than 23 °C but not more than 60 °C must be identified on the shipping paper in lieu of the minimum flashpoint.

(3) For a hazardous material consigned under an “n.o.s.” entry not included in the segregation groups listed in section 3.1.4 of the IMDG Code (IBR see §171.7 of this subchapter) but belonging, in the opinion of the consignor, to one of these groups, the appropriate segregation group must be shown in association with the basic description (for example, IMDG Code segregation group—1 Acids). When no segregation group is applicable, there is no requirement to indicate that condition.

(4) For lithium cells or batteries transported in accordance with §173.185(f), “DAMAGED/DEFECTIVE”; and for lithium cells or batteries transported for purposes of disposal or recycling, “LITHIUM BATTERIES FOR DISPOSAL” or “LITHIUM BATTERIES FOR RECYCLING”, as appropriate.

(j) [Reserved]

(k) *Technical names for “n.o.s.” and other generic descriptions.* Unless otherwise excepted, if a material is described on a shipping paper by one of the proper shipping names identified by the letter “G” in column (1) of the §172.101 Table, the technical name of the hazardous material must be entered in parentheses in association with the basic description. For example “UN 1760, Corrosive liquid, n.o.s., (Octanoyl chloride), 8, II”, or “UN 1760,

Corrosive liquid, n.o.s., 8, II (contains Octanoyl chloride)". The word "contains" may be used in association with the technical name, if appropriate. For organic peroxides which may qualify for more than one generic listing depending on concentration, the technical name must include the actual concentration being shipped or the concentration range for the appropriate generic listing. For example, "UN 3102, Organic peroxide type B, solid, 5.2, (dibenzoyl peroxide, 52-100%)" or "UN 3108, Organic peroxide type E, solid, 5.2, (dibenzoyl peroxide, paste, <52%)". Shipping descriptions for toxic materials that meet the criteria of Division 6.1, PG I or II (as specified in §173.132(a) of this subchapter) or Division 2.3 (as specified in §173.115(c) of this subchapter) and are identified by the letter "G" in column (1) of the §172.101 Table, must have the technical name of the toxic constituent entered in parentheses in association with the basic description. A material classed as Division 6.2 and assigned identification number UN 2814 or UN 2900 that is suspected to contain an unknown Category A infectious substance must have the words "suspected Category A infectious substance" entered in parentheses in place of the technical name as part of the proper shipping description. For additional technical name options, see the definition for "Technical name" in §171.8. A technical name should not be marked on the outer package of a Division 6.2 material (see §172.301(b)).

(1) If a hazardous material is a mixture or solution of two or more hazardous materials, the technical names of at least two components most predominately contributing to the hazards of the mixture or solution must be entered on the shipping paper as required by paragraph (k) of this section. For example, "UN 2924, Flammable liquid, corrosive, n.o.s., 3 (8), II (contains Methanol, Potassium hydroxide)".

(2) The provisions of this paragraph do not apply—

(i) To a material that is a hazardous waste and described using the proper shipping name "Hazardous waste, liquid or solid, n.o.s.", classed as a miscellaneous Class 9, provided the EPA hazardous waste number is included on

the shipping paper in association with the basic description, or provided the material is described in accordance with the provisions of §172.203(c) of this part.

(ii) To a material for which the hazard class is to be determined by testing under the criteria in §172.101(c)(11).

(iii) If the n.o.s. description for the material (other than a mixture of hazardous materials of different classes meeting the definitions of more than one hazard class) contains the name of the chemical element or group which is primarily responsible for the material being included in the hazard class indicated.

(iv) If the n.o.s. description for the material (which is a mixture of hazardous materials of different classes meeting the definition of more than one hazard class) contains the name of the chemical element or group responsible for the material meeting the definition of one of these classes. In such cases, only the technical name of the component that is not appropriately identified in the n.o.s. description shall be entered in parentheses.

(1) *Marine pollutants.* (1) For a proper shipping name used to describe a hazardous material that is a marine pollutant, either assigned the letter "G" in column (1) of the §172.101 hazardous materials table, or that contains the text "n.o.s.", the name of the component that makes the material a marine pollutant must appear in parentheses in association with the basic description. Where two or more components that make the material a marine pollutant are present, the names of at least two of the components most predominately contributing to the marine pollutant designation must appear in parentheses in association with the basic description. For material described using "UN3077, Environmentally hazardous substance, solid, n.o.s." and "UN3082, Environmentally hazardous substance, liquid, n.o.s.," see §172.102(c)(1), special provision 441 for additional provisions.

(2) The words "Marine Pollutant" shall be entered in association with the basic description for a material which is a marine pollutant.

(3) Except for transportation by vessel, marine pollutants subject to the

provisions of 49 CFR 130.11 are excepted from the requirements of paragraph (1) of this section if a phrase indicating the material is an oil is placed in association with the basic description.

(4) Except when all or part of transportation is by vessel, marine pollutants in non-bulk packagings are not subject to the requirements of paragraphs (1)(1) and (1)(2) of this section (see § 171.4 of this subchapter).

(m) *Poisonous Materials*. Notwithstanding the hazard class to which a material is assigned, for materials that are poisonous by inhalation (see § 171.8 of this subchapter), the words “Poison-Inhalation Hazard” or “Toxic-Inhalation Hazard” and the words “Zone A”, “Zone B”, “Zone C”, or “Zone D” for gases or “Zone A” or “Zone B” for liquids, as appropriate, shall be entered on the shipping paper immediately following the shipping description. The word “Poison” or “Toxic” need not be repeated if it otherwise appears in the shipping description.

(n) *Elevated temperature materials*. If a liquid material in a package meets the definition of an elevated temperature material in § 171.8 of this subchapter, and the fact that it is an elevated temperature material is not disclosed in the proper shipping name (for example, when the words “Molten” or “Elevated temperature” are part of the proper shipping name), the word “HOT” must immediately precede the proper shipping name of the material on the shipping paper.

(o) *Organic peroxides, polymerizing substances, and self-reactive materials*. The description on a shipping paper for a Division 4.1 (polymerizing substance and self-reactive) material or a Division 5.2 (organic peroxide) material must include the following additional information, as appropriate:

(1) If notification or competent authority approval is required, the shipping paper must contain a statement of approval of the classification and conditions of transport.

(2) For Division 4.1 (polymerizing substance and self-reactive) and Division 5.2 (organic peroxide) materials that require temperature control during transport, the words “TEMPERATURE CONTROLLED” must be added as part of the proper shipping name,

unless already part of the proper shipping name. The control and emergency temperature must be included on the shipping paper.

(3) The word “SAMPLE” must be included in association with the basic description when a sample of a Division 4.1 (self-reactive) material (see § 173.224(c)(3) of this subchapter) or Division 5.2 (organic peroxide) material (see § 173.225(b)(2) of this subchapter) is offered for transportation.

(p) *Liquefied petroleum gas (LPG)*. The word “non-odorized” or “not-odorized” must be included in association with the proper shipping description on a shipping paper when non-odorized liquefied petroleum gas is offered for transportation.

(q) *Holding time*. The date at which the actual holding time ends, as calculated in accordance with § 178.338–9, must be provided on the shipping paper in association with the basic description for refrigerated liquefied gases transported in a portable tank.

[Amdt. 172–29A, 41 FR 40677, Sept. 20, 1976]

EDITORIAL NOTE: For FEDERAL REGISTER citations affecting § 172.203, see the List of CFR Sections Affected, which appears in the Finding Aids section of the printed volume and at www.govinfo.gov.

§ 172.204 Shipper's certification.

(a) *General*. Except as provided in paragraphs (b) and (c) of this section, each person who offers a hazardous material for transportation shall certify that the material is offered for transportation in accordance with this subchapter by printing (manually or mechanically) on the shipping paper containing the required shipping description the certification contained in paragraph (a)(1) of this section or the certification (declaration) containing the language contained in paragraph (a)(2) of this section. For transportation by rail only, the certification may be received verbally or with an electronic signature in conformance with paragraphs (a)(3)(i) and (a)(3)(ii) of this section.

(1) “This is to certify that the above-named materials are properly classified, described, packaged, marked and labeled, and are in proper condition for

transportation according to the applicable regulations of the Department of Transportation.”

NOTE: In line one of the certification the words “herein-named” may be substituted for the words “above-named”.

(2) “I hereby declare that the contents of this consignment are fully and accurately described above by the proper shipping name, and are classified, packaged, marked and labeled/placarded, and are in all respects in proper condition for transport according to applicable international and national governmental regulations.”

NOTE TO PARAGRAPH (a)(2): In the certification the word “above” may be substituted for the word “below” as appropriate.

(3) *Rail only certifications.* For transportation by rail, the shipping paper certification may also be accomplished by one of the following methods:

(i) *Verbal Certification.* When received telephonically, by the carrier reading the complete shipping description that will accompany the shipment back to the offeror and receiving verbal acknowledgment that the description is as required. This verbal acknowledgment must be recorded, either on the shipping document or in a separate record, e.g., the waybill, in accordance with §174.24, and must include the date and name of the person who provided this information; or

(ii) *Electronic certification.* When transmitted electronically, by completing the field designated for the shipper’s signature with the name of the principal person, partner, officer, or employee of the offeror or their agent, the shipper is also certifying its compliance with the certification specified in this paragraph (a).

(b) *Exceptions.* (1) Except for a hazardous waste, no certification is required for a hazardous material offered for transportation by motor vehicle and transported:

(i) In a cargo tank supplied by the carrier, or

(ii) By the shipper as a private carrier except for a hazardous material that is to be reshipped or transferred from one carrier to another.

(2) No certification is required for the return of an empty tank car which previously contained a hazardous material

and which has not been cleaned or purged.

(c) *Transportation by air—(1) General.* Certification containing the following language may be used in place of the certification required by paragraph (a) of this section:

I hereby certify that the contents of this consignment are fully and accurately described above by proper shipping name and are classified, packaged, marked and labeled, and in proper condition for carriage by air according to applicable national governmental regulations.

NOTE TO PARAGRAPH (c)(1): In the certification, the word “packed” may be used instead of the word “packaged” until October 1, 2010.

(2) *Certificate in duplicate.* Each person who offers a hazardous material to an aircraft operator for transportation by air shall provide two copies of the certification required in this section. (See §175.30 of this subchapter.)

(3) *Additional certification requirements.* Effective October 1, 2006, each person who offers a hazardous material for transportation by air must add to the certification required in this section the following statement:

“I declare that all of the applicable air transport requirements have been met.”

(i) Each person who offers any package or overpack of hazardous materials for transport by air must ensure that:

(A) The articles or substances are not prohibited for transport by air (see the §172.101 Table);

(B) The articles or substances are properly classed, marked and labeled and otherwise in a condition for transport as required by this subchapter;

(C) The articles or substances are packaged in accordance with all the applicable air transport requirements, including appropriate types of packaging that conform to the packing requirements and the “A” Special Provisions in §172.102; inner packaging and maximum quantity per package limits; the compatibility requirements (see, for example, §173.24 of this subchapter); and requirements for closure for both inner and outer packagings, absorbent materials, and pressure differential in

§ 172.205

49 CFR Ch. I (10–1–23 Edition)

§173.27 of this subchapter. Other requirements may also apply. For example, single packagings may be prohibited, inner packaging may need to be packed in intermediate packagings, and certain materials may be required to be transported in packagings meeting a more stringent performance level.

(ii) [Reserved]

(4) *Radioactive material.* Each person who offers any radioactive material for transportation aboard a passenger-carrying aircraft shall sign (mechanically or manually) a printed certificate stating that the shipment contains radioactive material intended for use in, or incident to, research, or medical diagnosis or treatment.

(d) *Signature.* The certifications required by paragraph (a) or (c) of this section:

(1) Must be legibly signed by a principal, officer, partner, or employee of the shipper or his agent; and

(2) May be legibly signed manually, by typewriter, or by other mechanical means.

(3) For transportation by rail, when transmitted by telephone or electronically, the signature must be in one of the following forms: The name of the principal person, partner, officer, or employee of the offeror or his agent in a computer field defined for that purpose.

[Amdt. 172–29A, 41 FR 40677, Sept. 20, 1976]

EDITORIAL NOTE: For FEDERAL REGISTER citations affecting §172.204, see the List of CFR Sections Affected, which appears in the Finding Aids section of the printed volume and at www.govinfo.gov.

§ 172.205 Hazardous waste manifest.

(a) No person may offer, transport, transfer, or deliver a hazardous waste (waste) unless an EPA Form 8700–22 and 8700–22A (when necessary) hazardous waste manifest (manifest) is prepared in accordance with 40 CFR 262.20 and is signed, carried, and given as required of that person by this section.

(b) The shipper (generator) shall prepare the manifest in accordance with 40 CFR part 262.

(c) The original copy of the manifest must be dated by, and bear the hand-

written signature of, the person representing:

(1) The shipper (generator) of the waste at the time it is offered for transportation, and

(2) The initial carrier accepting the waste for transportation.

(d) A copy of the manifest must be dated by, and bear the handwritten signature of the person representing:

(1) Each subsequent carrier accepting the waste for transportation, at the time of acceptance, and

(2) The designated facility receiving the waste, upon receipt.

(e) A copy of the manifest bearing all required dates and signatures must be:

(1) Given to a person representing each carrier accepting the waste for transportation,

(2) Carried during transportation in the same manner as required by this subchapter for shipping papers,

(3) Given to a person representing the designated facility receiving the waste,

(4) Returned to the shipper (generator) by the carrier that transported the waste from the United States to a foreign destination with a notation of the date of departure from the United States, and

(5) Retained by the shipper (generator) and by the initial and each subsequent carrier for three years from the date the waste was accepted by the initial carrier. Each retained copy must bear all required signatures and dates up to and including those entered by the next person who received the waste.

(f) *Transportation by rail.* Notwithstanding the requirements of paragraphs (d) and (e) of this section, the following requirements apply:

(1) When accepting hazardous waste from a non-rail transporter, the initial rail transporter must:

(i) Sign and date the manifest acknowledging acceptance of the hazardous waste;

(ii) Return a signed copy of the manifest to the non-rail transporter;

(iii) Forward at least three copies of the manifest to:

(A) The next non-rail transporter, if any;

(B) The designated facility, if the shipment is delivered to that facility by rail; or

(C) The last rail transporter designated to handle the waste in the United States; and

(iv) Retain one copy of the manifest and rail shipping paper in accordance with 40 CFR 263.22.

(2) Rail transporters must ensure that a shipping paper containing all the information required on the manifest (excluding the EPA identification numbers, generator certification and signatures) and, for exports, an EPA Acknowledgment of Consent accompanies the hazardous waste at all times. Intermediate rail transporters are not required to sign either the manifest or shipping paper.

(3) When delivering hazardous waste to the designated facility, a rail transporter must:

(i) Obtain the date of delivery and handwritten signature of the owner or operator of the designated facility on the manifest or the shipping paper (if the manifest has not been received by the facility); and

(ii) Retain a copy of the manifest or signed shipping paper in accordance with 40 CFR 263.22.

(4) When delivering hazardous waste to a non-rail transporter, a rail transporter must:

(i) Obtain the date of delivery and the handwritten signature of the next non-rail transporter on the manifest; and

(ii) Retain a copy of the manifest in accordance with 40 CFR 263.22.

(5) Before accepting hazardous waste from a rail transporter, a non-rail transporter must sign and date the manifest and provide a copy to the rail transporter.

(g) The person delivering a hazardous waste to an initial rail carrier shall send a copy of the manifest, dated and signed by a representative of the rail carrier, to the person representing the designated facility.

(h) A hazardous waste manifest required by 40 CFR part 262, containing all of the information required by this subpart, may be used as the shipping paper required by this subpart.

(i) The shipping description for a hazardous waste must be modified as required by §172.101(c)(9).

(j) Electronic manifests that are obtained, completed, and transmitted in

accordance with 40 CFR 262.20(a)(3), and used in accordance with 40 CFR 262.24 in lieu of EPA Forms 8700-22 and 8700-22A are the legal equivalent of paper manifest forms bearing handwritten signatures, and satisfy for all purposes any requirements in these regulations to obtain, complete, sign, provide, use, or retain a manifest. Electronic signatures in conformance with 40 CFR 262.25 are therefore acceptable in lieu of handwritten signatures required by paragraphs (c) and (d) of this section provided one printed copy of the electronic manifest bearing the electronic signature is provided to the initial transporter as required by 40 CFR 262.24(d). A copy of the electronic manifest would satisfy the 3-year retention requirement for maintaining a copy of the manifest.

[Amdt. 172-58, 45 FR 34698, May 22, 1980, as amended by Amdt. 172-90, 49 FR 10510, Mar. 20, 1984; 49 FR 11184, Mar. 26, 1984; Amdt. 172-248, 61 FR 28675, June 5, 1996; 70 FR 34075, June 13, 2005; 83 FR 55806, Nov. 7, 2018]

Subpart D—Marking

§ 172.300 Applicability.

(a) Each person who offers a hazardous material for transportation shall mark each package, freight container, and transport vehicle containing the hazardous material in the manner required by this subpart.

(b) When assigned the function by this subpart, each carrier that transports a hazardous material shall mark each package, freight container, and transport vehicle containing the hazardous material in the manner required by this subpart.

(c) Unless otherwise provided in a specific rule, stocks of preprinted packagings marked in accordance with this subpart prior to the effective date of a final rule may be continued in use, in the manner previously authorized, until depleted or for a one-year period subsequent to the compliance date of the marking amendment, whichever is less.

[Amdt. 172-101, 45 FR 74666, Nov. 10, 1980, as amended at 76 FR 3365, Jan. 19, 2011]

§ 172.301 General marking requirements for non-bulk packagings.

(a) *Proper shipping name and identification number.* (1) Except as otherwise provided by this subchapter, each person who offers a hazardous material for transportation in a non-bulk packaging must mark the package with the proper shipping name and identification number (preceded by “UN”, “NA” or “ID,” as appropriate), as shown in the §172.101 Hazardous Materials Table. The identification number marking preceded by “UN”, “NA”, or “ID” as appropriate must be marked in characters at least 12 mm (0.47 inches) high. Packages with a maximum capacity of 30 liters (8 gallons) or less, 30 kg (66 pounds) maximum net mass, or cylinders with a water capacity of 60 liters (16 gallons) or less must be marked with characters at least 6 mm (0.24 inches) high. Packages with a maximum capacity of 5 liters (1.32 gallons) or less or 5 kg maximum net mass (11 pounds) or less must be marked in a size appropriate for the size of the package.

(i) *Transitional exception.* For domestic transportation, until January 1, 2017, the identification number markings are not subject to the minimum size requirements specified in this paragraph (a)(1).

(ii) Exception for permanently marked packagings. For domestic transportation, a packaging manufactured prior to January 1, 2017 and permanently marked (e.g., by embossing or through a heat stamp process) with the appropriate identification number marking may continue in service until the end of its useful life regardless of whether the identification number markings meet the minimum size requirements specified in this paragraph (a)(1).

(2) The proper shipping name for a hazardous waste (as defined in §171.8 of this subchapter) is not required to include the word “waste” if the package bears the EPA marking prescribed by 40 CFR 262.32.

(3) *Large quantities of a single hazardous material in non-bulk packages.* A transport vehicle or freight container containing only a single hazardous material in non-bulk packages must be marked, on each side and each end as

specified in the §172.332 or §172.336, with the identification number specified for the hazardous material in the §172.101 Table, subject to the following provisions and limitations:

(i) Each package is marked with the same proper shipping name and identification number;

(ii) The aggregate gross weight of the hazardous material is 4,000 kg (8,820 pounds) or more;

(iii) All of the hazardous material is loaded at one loading facility;

(iv) The transport vehicle or freight container contains no other material, hazardous or otherwise; and

(v) The identification number marking requirement of this paragraph (a)(3) does not apply to Class 1, Class 7, or to non-bulk packagings for which identification numbers are not required.

(b) *Technical names.* In addition to the marking required by paragraph (a) of this section, each non-bulk packaging containing a hazardous material subject to the provisions of §172.203(k) of this part, except for a Division 6.2 material, must be marked with the technical name in parentheses in association with the proper shipping name in accordance with the requirements and exceptions specified for display of technical descriptions on shipping papers in §172.203(k) of this part. A technical name should not be marked on the outer package of a Division 6.2 material.

(c) *Special permit packagings.* Except as provided in §173.23 of this subchapter, the outside of each package authorized by a special permit must be plainly and durably marked “DOT-SP” followed by the special permit number assigned. Packages authorized by an exemption issued prior to October 1, 2007, may be plainly and durably marked “DOT-E” in lieu of “DOT-SP” followed by the number assigned as specified in the most recent version of that exemption.

(d) *Consignee’s or consignor’s name and address.* Each person who offers for transportation a hazardous material in a non-bulk package shall mark that package with the name and address of the consignor or consignee except when the package is—

(1) Transported by highway only and will not be transferred from one motor carrier to another; or

(2) Part of a carload lot, truckload lot or freight container load, and the entire contents of the rail car, truck or freight container are shipped from one consignor to one consignee.

(e) *Previously marked packagings.* A package which has been previously marked as required for the material it contains and on which the marking remains legible, need not be remarked. (For empty packagings, see §173.29 of this subchapter.)

(f) *NON-ODORIZED marking on cylinders containing LPG.* No person may offer for transportation or transport a specification cylinder, except a Specification 2P or 2Q container or a Specification 39 cylinder, containing unodorized liquefied petroleum gas (LPG) unless it is legibly marked NON-ODORIZED or NOT ODORIZED in letters not less than 6.3 mm (0.25 inches) in height near the marked proper shipping name required by paragraph (a) of this section. The NON-ODORIZED or NOT ODORIZED marking may appear on a cylinder used for both unodorized and odorized LPG.

[Amdt. 172-123, 55 FR 52590, Dec. 21, 1990, as amended by Amdt. 172-151, 62 FR 1227, Jan. 8, 1997; 62 FR 39404, July 22, 1997; 63 FR 16075, Apr. 1, 1998; 66 FR 45182, Aug. 28, 2001; 68 FR 45030, July 31, 2003; 69 FR 64471, Nov. 4, 2004; 70 FR 73164, Dec. 9, 2005; 71 FR 32258, June 2, 2006; 76 FR 3365, Jan. 19, 2011; 76 FR 56314, Sept. 13, 2011; 78 FR 1072, Jan. 7, 2013; 78 FR 65478, Oct. 31, 2013; 81 FR 35540, June 2, 2016; 87 FR 44990, July 26, 2022]

§ 172.302 General marking requirements for bulk packagings.

(a) *Identification numbers.* Except as otherwise provided in this subpart, no person may offer for transportation or transport a hazardous material in a bulk packaging unless the packaging is marked as required by §172.332 with the identification number specified for the material in the §172.101 table—

(1) On each side and each end, if the packaging has a capacity of 3,785 L (1,000 gallons) or more;

(2) On two opposing sides, if the packaging has a capacity of less than 3,785 L (1,000 gallons); or

(3) For cylinders permanently installed on a tube trailer motor vehicle,

on each side and each end of the motor vehicle.

(b) *Size of markings.* Except as otherwise provided, markings required by this subpart on bulk packagings must—

(1) Have a width of at least 6.0 mm (0.24 inch) and a height of at least 100 mm (3.9 inches) for rail cars;

(2) Have a width of at least 4.0 mm (0.16 inch) and a height of at least 12 mm (0.47 inch) for portable tanks with capacities of less than 3,785 L (1,000 gallons) and a width of at least 4.0 mm (0.16 inch) and a height of 25 mm (one inch) for IBCs; and

(3) Have a width of at least 6.0 mm (0.24 inch) and a height of at least 50 mm (2.0 inches) for cargo tanks and other bulk packagings.

(c) *Special permit packagings.* Except as provided in §173.23 of this subchapter, the outside of each package used under the terms of a special permit must be plainly and durably marked “DOT-SP” followed by the special permit number assigned. Packages authorized by an exemption issued prior to October 1, 2007 may be plainly and durably marked “DOT-E” in lieu of “DOT-SP” followed by the number assigned as specified in the most recent version of that exemption.

(d) Each bulk packaging marked with a proper shipping name, common name or identification number as required by this subpart must remain marked when it is emptied unless it is—

(1) Sufficiently cleaned of residue and purged of vapors to remove any potential hazard; or

(2) Refilled, with a material requiring different markings or no markings, to such an extent that any residue remaining in the packaging is no longer hazardous.

(e) Additional requirements for marking portable tanks, cargo tanks, tank cars, multi-unit tank car tanks, and other bulk packagings are prescribed in §§172.326, 172.328, 172.330, and 172.331, respectively, of this subpart.

(f) A bulk packaging marked prior to October 1, 1991, in conformance to the regulations of this subchapter in effect on September 30, 1991, need not be remarked if the key words of the proper shipping name are identical to those currently specified in the §172.101

§ 172.303

table. For example, a tank car marked “NITRIC OXIDE” need not be re-marked “NITRIC OXIDE, COM-PRESSED”.

(g) A rail car, freight container, truck body or trailer in which the lading has been fumigated with any hazardous material, or is undergoing fumigation, must be marked as specified in § 173.9 of this subchapter.

[Amdt. 172-123, 55 FR 52591, Dec. 21, 1990, as amended at 56 FR 66254, Dec. 20, 1991; Amdt. 172-150, 61 FR 50624, Sept. 26, 1996; Amdt. 172-151, 62 FR 1228, Jan. 8, 1997; 62 FR 39398, July 22, 1997; 66 FR 45379, Aug. 28, 2001; 70 FR 73164, Dec. 9, 2005; 72 FR 55692, Oct. 1, 2007; 85 FR 75712, Nov. 25, 2020]

§ 172.303 Prohibited marking.

(a) No person may offer for transportation or transport a package which is marked with the proper shipping name, the identification number of a hazardous material or any other markings indicating that the material is hazardous (e.g., RQ, INHALATION HAZARD) unless the package contains the identified hazardous material or its residue.

(b) This section does not apply to—

(1) Transportation of a package in a transport vehicle or freight container if the package is not visible during transportation and is loaded by the shipper and unloaded by the shipper or consignee.

(2) Markings on a package which are securely covered in transportation.

(3) The marking of a shipping name on a package when the name describes a material not regulated under this subchapter.

[Amdt. 172-123, 55 FR 52591, Dec. 21, 1990, as amended at 56 FR 66254, Dec. 20, 1991; 72 FR 55692, Oct. 1, 2007]

§ 172.304 Marking requirements.

(a) The marking required in this subpart—

(1) Must be durable, in English and printed on or affixed to the surface of a package or on a label, tag, or sign.

(2) Must be displayed on a background of sharply contrasting color;

(3) Must be unobscured by labels or attachments; and

(4) Must be located away from any other marking (such as advertising)

49 CFR Ch. I (10-1-23 Edition)

that could substantially reduce its effectiveness.

(b) [Reserved]

[Amdt. 172-29, 41 FR 15996, Apr. 15, 1976, as amended by Amdt. 172-29B, 41 FR 57067, Dec. 30, 1976]

§ 172.306 [Reserved]

§ 172.308 Authorized abbreviations.

(a) Abbreviations may not be used in a proper shipping name marking except as authorized in this section.

(b) The abbreviation “ORM” may be used in place of the words “Other Regulated Material.”

(c) Abbreviations which appear as authorized descriptions in column 2 of the § 172.101 table (e.g., “TNT” and “PCB”) are authorized.

[Amdt. 172-123, 55 FR 52591, Dec. 21, 1990, as amended by Amdt. 172-145, 60 FR 49110, Sept. 21, 1995]

§ 172.310 Class 7 (radioactive) materials.

In addition to any other markings required by this subpart, each package containing Class 7 (radioactive) materials must be marked as follows:

(a) Each package with a gross mass greater than 50 kg (110 lb) must have its gross mass including the unit of measurement (which may be abbreviated) marked on the outside of the package.

(b) Each industrial, Type A, Type B(U), or Type B(M) package must be legibly and durably marked on the outside of the packaging, in letters at least 12 mm (0.47 in) high, with the words “TYPE IP-1,” “TYPE IP-2,” “TYPE IP-3,” “TYPE A,” “TYPE B(U)” or “TYPE B(M),” as appropriate. A package which does not conform to Type IP-1, Type IP-2, Type IP-3, Type A, Type B(U) or Type B(M) requirements may not be so marked.

(c) Each package which conforms to an IP-1, IP-2, IP-3 or a Type A package design must be legibly and durably marked on the outside of the packaging with the international vehicle registration code of the country of origin of the design. The international vehicle registration code for packages designed by a United States company or agency is the symbol “USA.”

(d) Each package which conforms to a Type B(U) or Type B(M) package design must have the outside of the outermost receptacle, which is resistant to the effects of fire and water, plainly marked by embossing, stamping or other means resistant to the effects of fire and water with a radiation symbol that conforms to the requirements of appendix B of this part.

(e) Each Type B(U), Type B(M) or fissile material package destined for export shipment must also be marked "USA" in conjunction with the specification marking, or other package certificate identification. (See §§173.471, 173.472, and 173.473 of this subchapter.)

[Doc. No. RSPA-99-6283 (HM-230), 69 FR 3668, Jan. 26, 2004, as amended at 79 FR 40609, July 11, 2014]

§ 172.312 Liquid hazardous materials in non-bulk packagings.

(a) Except as provided in this section, each non-bulk combination package having inner packagings containing liquid hazardous materials, single packaging fitted with vents, or open cryogenic receptacle intended for the transport of refrigerated liquefied gases must be:

- (1) Packed with closures upward, and
- (2) Legibly marked with package orientation markings that are similar to the illustration shown in this paragraph, on two opposite vertical sides of the package with the arrows pointing in the correct upright direction. The arrows must be either black or red on white or other suitable contrasting background and commensurate with the size of the package. Depicting a rectangular border around the arrows is optional.

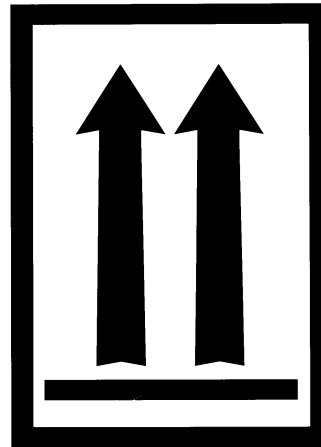

Package orientation

(b) Arrows for purposes other than indicating proper package orientation may not be displayed on a package containing a liquid hazardous material.

(c) The requirements of paragraph (a) of this section do not apply to—

- (1) A non-bulk package with inner packagings which are cylinders.
- (2) Except when offered or intended for transportation by aircraft, packages containing flammable liquids in inner packagings of 1 L or less prepared in accordance with §173.150 (b) or (c) of this subchapter.
- (3) When offered or intended for transportation by aircraft, packages containing liquid hazardous materials in inner packagings of 120 mL (4 fluid oz.) or less when packed with sufficient absorption material between the inner and outer packagings to completely absorb the liquid contents.
- (4) Liquids contained in manufactured articles (e.g., alcohol or mercury in thermometers) which are leak-tight in all orientations.
- (5) A non-bulk package with hermetically sealed inner packagings not exceeding 500 mL each.
- (6) Packages containing liquid infectious substances in primary receptacles not exceeding 50 mL (1.7 oz.).

§ 172.313

(7) Class 7 radioactive material in Type A, IP-2, IP-3, Type B(U), or Type B(M) packages.

[Amdt. 172-123, 55 FR 52591, Dec. 21, 1990, as amended at 56 FR 66254, Dec. 20, 1991; 57 FR 45458, Oct. 1, 1992; 64 FR 51918, Sept. 27, 1999; 66 FR 45379, Aug. 28, 2001; 68 FR 45030, July 31, 2003; 71 FR 54395, Sept. 14, 2006; 71 FR 78627, Dec. 29, 2006; 76 FR 3365, Jan. 19, 2011; 78 FR 1073, Jan. 7, 2013]

§ 172.313 Poisonous hazardous materials.

In addition to any other markings required by this subpart:

(a) A material poisonous by inhalation (see § 171.8 of this subchapter) shall be marked "Inhalation Hazard" in association with the required labels or placards, as appropriate, and shipping name when required. The marking must be on two opposing sides of a bulk packaging. (See § 172.302(b) of this subpart for size of markings on bulk packages.) When the words "Inhalation Hazard" appear on the label, as prescribed in §§ 172.416 and 172.429, or placard, as prescribed in §§ 172.540 and 172.555, the "Inhalation Hazard" marking is not required on the package.

(b) Each non-bulk plastic outer packaging used as a single or composite packaging for materials meeting the definition of Division 6.1 (in § 173.132 of this subchapter) shall be permanently marked, by embossment or other durable means, with the word "POISON" in letters at least 6.3 mm (0.25 inch) in height. Additional text or symbols related to hazard warning may be included in the marking. The marking shall be located within 150 mm (6 inches) of the closure of the packaging.

(c) A transport vehicle or freight container containing a material poisonous by inhalation in non-bulk packages shall be marked, on each side and each end as specified in § 172.332 or § 172.336, with the identification number specified for the hazardous material in the § 172.101 table, subject to the following provisions and limitations:

(1) The material is in Hazard Zone A or B;

(2) The transport vehicle or freight container is loaded at one facility with 1,000 kg (2,205 pounds) or more aggregate gross weight of the material in non-bulk packages marked with the

49 CFR Ch. I (10-1-23 Edition)

same proper shipping name and identification number; and

(3) If the transport vehicle or freight container contains more than one material meeting the provisions of this paragraph (c), it shall be marked with the identification number for one material, determined as follows:

(i) For different materials in the same hazard zone, with the identification number of the material having the greatest aggregate gross weight; and

(ii) For different materials in both Hazard Zones A and B, with the identification number for the Hazard Zone A material.

(d) For a packaging containing a Division 6.1 PG III material, "PG III" may be marked adjacent to the POISON label. (See § 172.405(c).)

[Amdt. 172-123, 55 FR 52592, Dec. 21, 1990, as amended at 57 FR 46624, Oct. 9, 1992; Amdt. 172-151, 62 FR 1228, Jan. 8, 1997; 62 FR 39398, 39405, July 22, 1997; 63 FR 16075, Apr. 1, 1998; 64 FR 10776, Mar. 5, 1999]

§ 172.315 Limited quantities.

(a) *Modes other than air transport.* Except for an article or substance of Class 7 prepared in accordance with subpart I of part 173, a package prepared in accordance with applicable limited quantity requirements in part 173 of this subchapter and offered for transportation by a mode other than air must display the limited quantity marking shown in paragraph (a)(1) of this section. A package displaying this mark is not subject to the marking requirements of § 172.301 of this subpart unless the limited quantity package also contains a hazardous substance or a hazardous waste. Required markings need not be duplicated if already marked as prescribed elsewhere in this subpart. As an alternative, a packaging may display the limited quantity "Y" mark shown in paragraph (b) of this section if the package conforms to authorized substance and article provisions and the inner and outer package quantity limits in § 173.27(f) of this subchapter.

(1) *Marking description.* The top and bottom portions of the square-on-point and the border forming the square-on-point must be black and the center white or of a suitable contrasting background as follows:

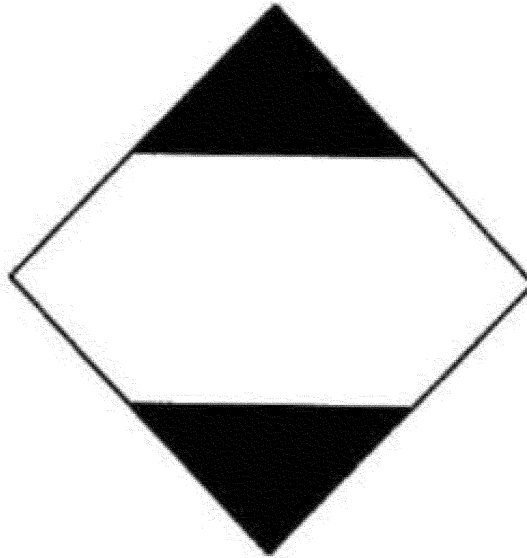

(2) The square-on-point must be durable, legible and of a size relative to the packaging, readily visible, and must be applied on at least one side or one end of the outer packaging. The width of the border forming the square-on-point must be at least 2 mm and the minimum dimension of each side, as measured from the outside of the lines forming the border, must be 100 mm unless the packaging size requires a reduced size marking that must be no less than 50 mm on each side and the width of the border forming the square on point may be reduced to a minimum of 1 mm. Where dimensions are not specified, all features shall be in approximate proportion to those shown. When intended for transportation by vessel, a cargo transport unit (see §176.2 of this subchapter) containing packages of hazardous materials in only limited quantities must be marked once on each side and once on each end of the exterior of the unit with an identical mark which must have minimum dimensions of 250 mm on each side.

(i) *Transitional exception.* A marking in conformance with the requirements of this paragraph in effect on December 31, 2014, may continue to be used until December 31, 2016.

(ii) For domestic transportation, a packaging marked prior to January 1, 2017 and in conformance with the requirements of this paragraph in effect on December 31, 2014, may continue in service until the end of its useful life.

(3) Except for Class 1 and 7, and Division 6.1 and 6.2 materials, for highway transportation by private motor carrier, the limited quantity marking is not required to be displayed on a package containing materials assigned to Packing Group II and III prepared in accordance with the limited quantity requirements in subpart B of part 173 of this subchapter provided:

(i) Inner packagings for liquid hazardous materials do not exceed 1.0 L (0.3 gallons) net capacity each;

(ii) Inner packagings for solid hazardous materials do not exceed 1.0 kg (2.2 pounds) net capacity each;

(iii) No more than 2 L (0.6 gallons) or 2 kg (4.4 pounds) aggregate net quantity of any one hazardous material is transported per vehicle;

(iv) The total gross weight of all the limited quantity packages per vehicle does not exceed 60 kg (132 pounds); and

(v) Each package is marked with the name and address of the offeror, a 24-hour emergency response telephone number and the statement "Contains

§ 172.315

49 CFR Ch. I (10–1–23 Edition)

Chemicals” in letters at least 25 mm (one-inch) high on a contrasting background.

(b) *Air transport.* Except for an article or substance of Class 7 prepared in accordance with subpart I of part 173, a package prepared in accordance with air-specific limited quantity requirements prescribed in §173.27 of this subchapter and intended for transportation by air must display the limited quantity mark prescribed in paragraph (b)(1) of this section in addition to other markings required by this sub-

part (*e.g.*, “RQ”, proper shipping name, identification number, as appropriate). Required markings need not be duplicated if already marked as prescribed elsewhere in this subpart.

(1) *Marking Description.* The top and bottom portions of the square-on-point and the border forming the square-on-point must be black and the center white or of a suitable contrasting background and the symbol “Y” must be black and located in the center of the square-on-point and be clearly visible as follows:

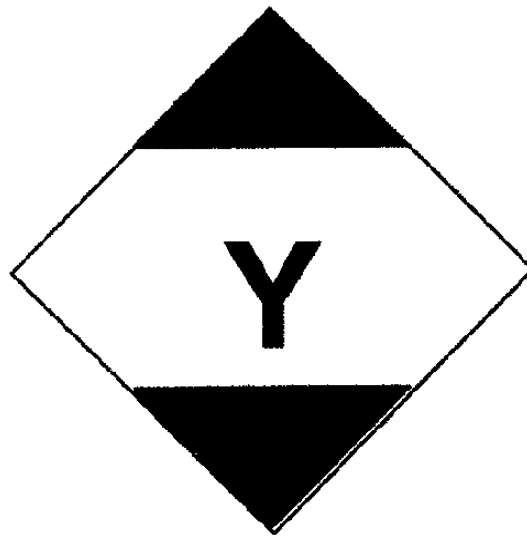

(2) The square-on-point must be durable, legible and of a size relative to the package as to be readily visible. The square-on-point must be applied on at least one side or one end of the outer packaging. The width of the border forming the square-on-point must be at least 2 mm and the minimum dimension of each side, as measured from the outside of the lines forming the border, must be 100 mm unless the package size requires a reduced size marking that must be no less than 50 mm on each side and the width of the border forming the square on point may be reduced to a minimum of 1 mm. Where dimensions are not specified, all features

shall be in approximate proportion to those shown.

(i) *Transitional exception.* A marking in conformance with the requirements of this paragraph in effect on December 31, 2014, may continue to be used until December 31, 2016.

(ii) For domestic transportation, a packaging marked prior to January 1, 2017 and in conformance with the requirements of this paragraph in effect on December 31, 2014, may continue in service until the end of its useful life.

(3) For transportation by aircraft, the entire mark must appear on one side of the package.

(c) Limited quantity markings prescribed in paragraphs (a) and (b) of this

section may use the packaging itself as the contrasting background for the center portion of the marking if the color sufficiently contrasts so that the black border, top and bottom portions of the square-on-point, and the “Y” symbol, if applicable, are clearly recognizable.

(d) [Reserved]

[76 FR 82174, Dec. 30, 2011, as amended at 78 FR 1073, Jan. 7, 2013; 78 FR 65478, Oct. 31, 2013; 80 FR 1149, Jan. 8, 2015; 81 FR 3671, Jan. 21, 2016; 87 FR 44990, July 26, 2022; 87 FR 79772, Dec. 27, 2022]

§ 172.316 [Reserved]

§ 172.317 KEEP AWAY FROM HEAT handling mark.

(a) *General.* For transportation by aircraft, each package containing self-reactive substances of Division 4.1 or organic peroxides of Division 5.2 must be marked with the KEEP AWAY FROM HEAT handling mark specified in this section.

(b) *Location and design.* The marking must be a rectangle measuring at least 105 mm (4.1 inches) in height by 74 mm (2.9 inches) in width as measured from the outside of the lines forming the border. Markings with not less than half this dimension are permissible where the dimensions of the package can only bear a smaller mark.

(1) *Transitional exception.* A marking in conformance with the requirements of this paragraph in effect on December 31, 2014, may continue to be used until December 31, 2016.

(2) For domestic transportation, a packaging marked prior to January 1, 2017 and in conformance with the requirements of this paragraph in effect on December 31, 2014, may continue in service until the end of its useful life.

(c) *KEEP AWAY FROM HEAT handling mark.* The KEEP AWAY FROM HEAT handling mark must conform to the following:

(1) Except for size, the KEEP AWAY FROM HEAT handling mark must appear as follows:

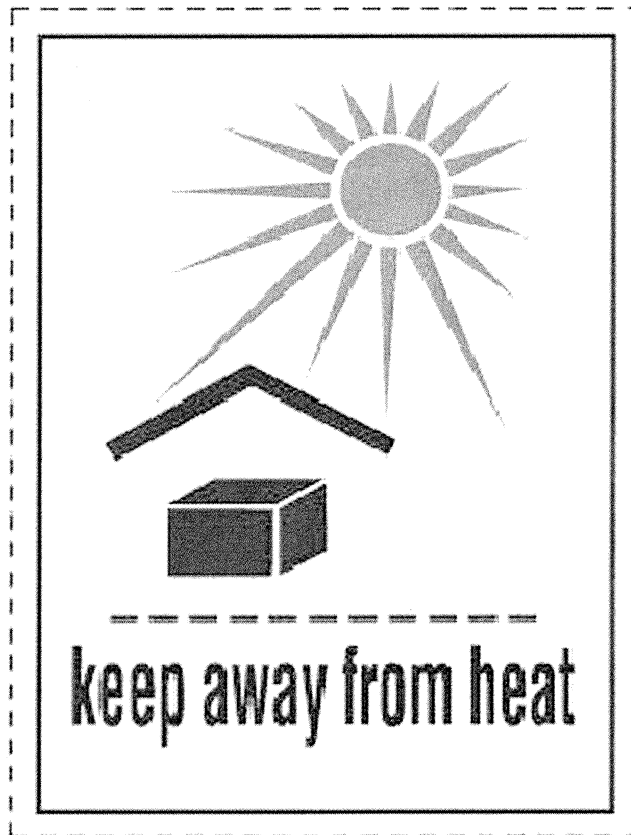

(2) The symbol, letters and border must be black and the background white, except for the starburst which must be red.

(3) The KEEP AWAY FROM HEAT handling marking required by paragraph (a) of this section must be durable, legible and displayed on a background of contrasting color.

[69 FR 76153, Dec. 20, 2004, as amended at 80 FR 1150, Jan. 8, 2015]

§ 172.320 Explosive hazardous materials.

(a) Except as otherwise provided in paragraphs (b), (c), (d) and (e) of this section, each package containing a Class 1 material must be marked with the EX-number for each substance, article or device contained therein.

(b) Except for fireworks approved in accordance with §173.64 of this subchapter, a package of Class 1 materials may be marked as follows, in lieu of the EX number required by paragraph (a) of this section:

(1) With a national stock number issued by the Department of Defense or identifying information, such as a product code required by regulations for commercial explosives specified in 27 CFR part 555, if the national stock number or identifying information can be specifically associated with the EX number assigned; or

(2) For Division 1.4G consumer fireworks reviewed by a Fireworks Certification Agency approved in accordance with 49 CFR part 107 subpart E and certified in accordance with §173.65, with

the FC number assigned by a DOT-approved Fireworks Certification Agency.

(c) When more than five different Class 1 materials are packed in the same package, the package may be marked with only five of the EX-numbers, national stock numbers, product codes, or combination thereof.

(d) The requirements of this section do not apply if the EX number, FC number, product code or national stock number of each explosive item described under a proper shipping description is shown in association with the shipping description required by §172.202(a). Product codes and national stock numbers must be traceable to the specific EX number assigned by the Associate Administrator or FC number assigned by a DOT-approved Fireworks Certification Agency.

(e) The requirements of this section do not apply to the following Class 1 materials:

(1) Those being shipped to a testing agency in accordance with §173.56(d) of this subchapter;

(2) Those being shipped in accordance with §173.56(e) of this subchapter, for the purposes of developmental testing;

(3) Those which meet the requirements of §173.56(h) of this subchapter and therefore are not subject to the approval process of §173.56 of this subchapter;

(4) [Reserved];

(5) Those that are transported in accordance with §173.56(c)(2) of this subchapter and, therefore, are covered by a national security classification currently in effect.

[Amdt. 172-123, 56 FR 66254, Dec. 20, 1991, as amended by Amdt. 172-139, 59 FR 67487, Dec. 29, 1994; 66 FR 45379, Aug. 28, 2001; 74 FR 53188, Oct. 16, 2009; 78 FR 42477, July 16, 2013]

§ 172.322 Marine pollutants.

(a) For vessel transportation of each non-bulk packaging that contains a marine pollutant—

(1) For a proper shipping name used to describe a hazardous material that is a marine pollutant and assigned the letter “G” in column (1) of the §172.101 hazardous materials table or that contains the text “n.o.s.,” the name of the component which makes the material a marine pollutant must be marked on

the package in parentheses in association with the marked proper shipping name unless the proper shipping name identifies by name the component which makes the material a marine pollutant. Where two or more components that make a material a marine pollutant are present, the names of at least two of the components most predominantly contributing to the marine pollutant designation must appear in parentheses in association with the marked proper shipping name. For materials described using “UN3077, Environmentally hazardous substance, solid, n.o.s.” and “UN3082, Environmentally hazardous substance, liquid, n.o.s.,” see §172.102(c)(1), special provision 441 for additional provisions; and

(2) Except as otherwise provided in this subchapter, the MARINE POLLUTANT mark shall be placed in association with the hazard warning labels required by subpart E of this part or, in the absence of any labels, in association with the marked proper shipping name.

(b) Except as otherwise provided in this subchapter, a bulk packaging that contains a marine pollutant must—

(1) Be marked with the MARINE POLLUTANT mark on at least two opposing sides or two ends other than the bottom if the packaging has a capacity of less than 3,785 L (1,000 gallons). The mark must be visible from the direction it faces. The mark may be displayed in black lettering on a square-on-point configuration having the same outside dimensions as a placard; or

(2) Be marked on each end and each side with the MARINE POLLUTANT mark if the packaging has a capacity of 3,785 L (1,000 gallons) or more. The mark must be visible from the direction it faces. The mark may be displayed in black lettering on a square-on-point configuration having the same outside dimensions as a placard.

(c) A transport vehicle or freight container that contains a package subject to the marking requirements of paragraph (a) or (b) of this section must be marked with the MARINE POLLUTANT mark. The mark must appear on each side and each end of the transport vehicle or freight container, and must be visible from the direction it faces. This requirement may be met by the

§ 172.323

49 CFR Ch. I (10–1–23 Edition)

marking displayed on a freight container or portable tank loaded on a motor vehicle or rail car. This mark may be displayed in black lettering on a white square-on-point configuration having the same outside dimensions as a placard.

(d) The MARINE POLLUTANT mark is not required—

(1) On single packagings or combination packagings where each single package or each inner packaging of combination packagings has:

(i) A net quantity of 5 L (1.3 gallons) or less for liquids; or

(ii) A net mass of 5 kg (11 pounds) or less for solids

(2) On a combination packaging containing a marine pollutant, other than a severe marine pollutant, in inner packagings each of which contains:

(i) 5 L (1.3 gallons) or less net capacity for liquids; or

(ii) 5 kg (11 pounds) or less net capacity for solids.

(3) Except for transportation by vessel, on a bulk packaging, freight container or transport vehicle that bears a label or placard specified in subparts E or F of this part.

(4) On a package of limited quantity material marked in accordance with §172.315 of this part.

(e) MARINE POLLUTANT mark. The MARINE POLLUTANT mark must conform to the following:

(1) Except for size, the MARINE POLLUTANT mark must appear as follows:

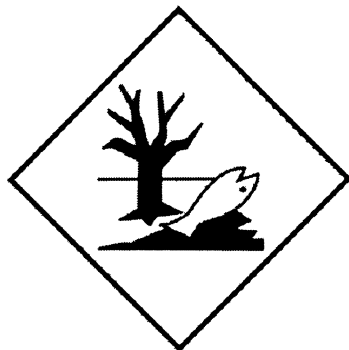

Symbol (fish and tree): Black on white or suitable contrasting background.

(2) The marking must be in the form of a square-on-point. The symbol and border must be black on a white or

suitable contrasting background. The width of the border forming the square-on-point marking must be at least 2 mm. Each side of the mark must be—

(i) At least 100 mm (3.9 inches) as measured from the outside of the lines forming the border for marks applied to:

(A) Non-bulk packages, except in the case of packages which, because of their size, can only bear smaller marks. If the size of the package so requires, the dimensions/line thickness may be reduced, provided the marking remains clearly visible. Where dimensions are not specified, all features shall be in approximate proportion to those shown.

(B) Bulk packages with a capacity of less than 3,785 L (1,000 gallons); or

(ii) At least 250 mm (9.8 inches) for marks applied to all other bulk packages.

(3) Transitional exception. A marking in conformance with the requirements of this paragraph in effect on December 31, 2014, may continue to be used until December 31, 2016.

(4) For domestic transportation, a packaging marked prior to January 1, 2017 and in conformance with the requirements of this paragraph in effect on December 31, 2014, may continue in service until the end of its useful life.

(f) Exceptions. See §171.4(c).

[Amdt. 172-127, 57 FR 52938, Nov. 5, 1992, as amended by Amdt. 172-136, 59 FR 38064, July 26, 1994; Amdt. 172-145, 60 FR 49110, Sept. 21, 1995; 66 FR 45379, Aug. 28, 2001; 70 FR 56098, Sept. 23, 2005; 74 FR 2252, Jan. 14, 2009; 76 FR 3367, Jan. 19, 2011; 80 FR 1150, Jan. 8, 2015; 85 FR 83380, Dec. 21, 2020; 87 FR 44990, July 26, 2022]

§ 172.323 Infectious substances.

(a) In addition to other requirements of this subpart, a bulk packaging containing a regulated medical waste, as defined in §173.134(a)(5) of this subchapter, must be marked with a BIOHAZARD marking conforming to 29 CFR 1910.1030(g)(1)(i)—

(1) On two opposing sides or two ends other than the bottom if the packaging has a capacity of less than 3,785 L (1,000 gallons). The BIOHAZARD marking must measure at least 152.4 mm (6 inches) on each side and must be visible from the direction it faces.

(2) On each end and each side if the packaging has a capacity of 3,785 L (1,000 gallons) or more. The BIOHAZARD marking must measure at least 152.4 mm (6 inches) on each side and must be visible from the direction it faces.

(b) For a bulk packaging contained in or on a transport vehicle or freight container, if the BIOHAZARD marking on the bulk packaging is not visible,

the transport vehicle or freight container must be marked as required by paragraph (a) of this section on each side and each end.

(c) The background color for the BIOHAZARD marking required by paragraph (a) of this section must be orange and the symbol and letters must be black. Except for size the BIOHAZARD marking must appear as follows:



§ 172.324

(d) The BIOHAZARD marking required by paragraph (a) of this section must be displayed on a background of contrasting color. It may be displayed on a plain white square-on-point configuration having the same outside dimensions as a placard, as specified in § 172.519(c) of this part.

[67 FR 53135, Aug. 14, 2002, as amended at 76 FR 56314, Sept. 13, 2011]

§ 172.324 Hazardous substances in non-bulk packagings.

For each non-bulk package that contains a hazardous substance—

(a) Except for packages of radioactive material labeled in accordance with § 172.403, if the proper shipping name of a material that is a hazardous substance does not identify the hazardous substance by name, the name of the hazardous substance must be marked on the package, in parentheses, in association with the proper shipping name. If the material contains two or more hazardous substances, at least two hazardous substances, including the two with the lowest reportable quantities (RQs), must be identified. For a hazardous waste, the waste code (e.g., D001), if appropriate, may be used to identify the hazardous substance.

(b) The letters “RQ” must be marked on the package in association with the proper shipping name.

(c) A package of limited quantity material marked in accordance with § 172.315 must also be marked in accord-

49 CFR Ch. I (10–1–23 Edition)

ance with the applicable requirements of this section.

[73 FR 4716, Jan. 28, 2008, as amended at 76 FR 3367, Jan. 19, 2011]

§ 172.325 Elevated temperature materials.

(a) Except as provided in paragraph (b) of this section, a bulk packaging containing an elevated temperature material must be marked on two opposing sides with the word “HOT” in black or white Gothic lettering on a contrasting background. The marking must be displayed on the packaging itself or in black lettering on a plain white square-on-point configuration having the same outside dimensions as a placard. (See § 172.302(b) for size of markings on bulk packagings.)

(b) Bulk packagings containing molten aluminum or molten sulfur must be marked “MOLTEN ALUMINUM” or “MOLTEN SULFUR”, respectively, in the same manner as prescribed in paragraph (a) of this section.

(c) If the identification number is displayed on a white-square-on-point display configuration, as prescribed in § 172.336(b), the word “HOT” may be displayed in the upper corner of the same white-square-on-point display configuration. The word “HOT” must be in black letters having a height of at least 50 mm (2.0 inches). Except for size, these markings shall be as illustrated for an Elevated temperature material, liquid, n.o.s.:



[Amdt. 172-125, 58 FR 3348, Jan. 8, 1993, as amended by Amdt. 172-139, 59 FR 67487, Dec. 29, 1994]

§ 172.326 Portable tanks.

(a) *Shipping name.* No person may offer for transportation or transport a portable tank containing a hazardous material unless it is legibly marked on two opposing sides with the proper shipping name specified for the material in the §172.101 table. For transportation by vessel, the minimum height for a proper shipping name marked on a portable tank is 65 mm (2.5 inches); except that portable tanks with a capacity of less than 3,000 L (792.52 gallons) may reduce the marking size to not less than 12 mm (0.47 inches).

(b) *Owner's name.* The name of the owner or of the lessee, if applicable,

must be displayed on a portable tank that contains a hazardous material.

(c) *Identification numbers.* (1) If the identification number markings required by §172.302(a) are not visible, a transport vehicle or freight container used to transport a portable tank containing a hazardous material must be marked on each side and each end as required by §172.332 with the identification number specified for the material in the §172.101 table.

(2) Each person who offers a portable tank containing a hazardous material to a motor carrier, for transportation in a transport vehicle or freight container, shall provide the motor carrier

§ 172.327

49 CFR Ch. I (10–1–23 Edition)

with the required identification numbers on placards, orange panels, or the white square-on-point configuration, as appropriate, for each side and each end of the transport vehicle or freight container from which identification numbers on the portable tank are not visible.

(d) *NON-ODORIZED marking on portable tanks containing LPG.* No person may offer for transportation or transport a portable tank containing unodorized liquefied petroleum gas (LPG) as authorized in §173.315(b)(1) of this subchapter unless it is legibly marked NON-ODORIZED or NOT ODORIZED on two opposing sides near the marked proper shipping name required by paragraph (a) of this section, or near the placards. The NON-ODORIZED or NOT ODORIZED marking may appear on a portable tank used for both unodorized and odorized LPG.

[Amdt. 172–123, 55 FR 52592, Dec. 21, 1990, as amended at 56 FR 66255, Dec. 20, 1991; 69 FR 64471, Nov. 4, 2004; 76 FR 3367, Jan. 19, 2011; 80 FR 1150, Jan. 8, 2015; 81 FR 35540, June 2, 2016]

§ 172.327 Petroleum sour crude oil in bulk packaging.

A Bulk packaging used to transport petroleum crude oil containing hydrogen sulfide (*i.e.*, sour crude oil) in sufficient concentration that vapors evolved from the crude oil may present

an inhalation hazard must include a marking, label, tag, or sign to warn of the toxic hazard as follows:

(a) The marking must be durable, legible and of a size relative to the package as to be readily visible and similar to the illustration shown in this paragraph with the minimum dimension of each side of the marking at least 100 mm (3.9 inches) as measured from the outside of the lines forming the border. The width of the border forming the square-on-point marking must be at least 5 mm. The marking must be displayed at each location (*e.g.*, manhole, loading head) where exposure to hydrogen sulfide vapors may occur.

(1) *Transitional exception*—A marking in conformance with the requirements of this paragraph in effect on December 31, 2014, may continue to be used until December 31, 2016.

(2) For domestic transportation, a packaging marked prior to January 1, 2017 and in conformance with the requirements of this paragraph in effect on December 31, 2014, may continue in service until the end of its useful life.

(b) The border of the square-on-point must be black or red on a white or other suitable contrasting background. The symbol must be black and located in the center of the square-on-point and be clearly visible as follows:



(c) As an alternative to the marking required in (a) and (b) of this section, a label, tag, or sign may be displayed at each location (*e.g.*, manhole, loading head) where exposure to hydrogen sulfide vapors may occur. The label, tag, or sign must be durable, in English, and printed legibly and of a size relative to the package with a warning statement such as “Danger, Possible Hydrogen Sulfide Inhalation Hazard” to communicate the possible risk of exposure to harmful concentrations of hydrogen sulfide gas.

[76 FR 3367, Jan. 19, 2011, as amended at 80 FR 1150, Jan. 8, 2015]

§ 172.328 Cargo tanks.

(a) *Providing and affixing identification numbers.* Unless a cargo tank is already marked with the identification numbers required by this subpart, the identification numbers must be provided or affixed as follows:

(1) A person who offers a hazardous material to a motor carrier for transportation in a cargo tank shall provide the motor carrier the identification numbers on placards or shall affix orange panels containing the required identification numbers, prior to or at the time the material is offered for transportation.

§ 172.330

49 CFR Ch. I (10–1–23 Edition)

(2) A person who offers a cargo tank containing a hazardous material for transportation shall affix the required identification numbers on panels or placards prior to or at the time the cargo tank is offered for transportation.

(3) For a cargo tank transported on or in a transport vehicle or freight container, if the identification number marking on the cargo tank required by §172.302(a) would not normally be visible during transportation—

(i) The transport vehicle or freight container must be marked as required by §172.332 on each side and each end with the identification number specified for the material in the §172.101 table; and

(ii) When the cargo tank is permanently installed within an enclosed cargo body of the transport vehicle or freight container, the identification number marking required by §172.302(a) need only be displayed on each side and end of a cargo tank that is visible when the cargo tank is accessed.

(b) *Required markings: Gases.* Except for certain nurse tanks which must be marked as specified in §173.315(m) of this subchapter, each cargo tank transporting a Class 2 material subject to this subchapter must be marked, in lettering no less than 50 mm (2.0 inches), on each side and each end with—

(1) The proper shipping name specified for the gas in the §172.101 table; or

(2) An appropriate common name for the material (e.g., “Refrigerant Gas”).

(c) *QT/NQT markings.* Each MC 330 and MC 331 cargo tank must be marked near the specification plate, in letters no less than 50 mm (2.0 inches) in height, with—

(1) “QT”, if the cargo tank is constructed of quenched and tempered steel; or

(2) “NQT”, if the cargo tank is constructed of other than quenched and tempered steel.

(d) After October 3, 2005, each on-vehicle manually-activated remote shut-off device for closure of the internal self-closing stop valve must be identified by marking “Emergency Shutoff” in letters at least 0.75 inches in height, in a color that contrasts with its background, and located in an area immediately adjacent to the means of closure.

diately adjacent to the means of closure.

(e) *NON-ODORIZED marking on cargo tanks containing LPG.* No person may offer for transportation or transport a cargo tank containing unodorized liquefied petroleum gas (LPG) as authorized in §173.315(b)(1) of this subchapter unless it is legibly marked NON-ODORIZED or NOT ODORIZED on two opposing sides near the marked proper shipping name as specified in paragraph (b)(1) of this section, or near the placards. The NON-ODORIZED or NOT ODORIZED marking may appear on a cargo tank used for both unodorized and odorized LPG.

[Amdt. 172–123, 55 FR 52592, Dec. 21, 1990, as amended at 56 FR 66255, Dec. 20, 1991; Amdt. 172–151, 62 FR 1228, Jan. 8, 1997; 62 FR 39045, July 22, 1997; 68 FR 19277, Apr. 18, 2003; 69 FR 64471, Nov. 4, 2004; 81 FR 35540, June 2, 2016]

§ 172.330 Tank cars and multi-unit tank car tanks.

(a) *Shipping name and identification number.* No person may offer for transportation or transport a hazardous material—

(1) In a tank car unless the following conditions are met:

(i) The tank car must be marked on each side and each end as required by §172.302 with the identification number specified for the material in the §172.101 table; and

(ii) A tank car containing any of the following materials must be marked on each side with the key words of the proper shipping name specified for the material in the §172.101 table, or with a common name authorized for the material in this subchapter (e.g., “Refrigerant Gas”):

- Acrolein, stabilized
- Ammonia, anhydrous
- Ammonia solutions (more than 50% ammonia)
- Bromine or Bromine solutions
- Bromine chloride
- Chloroprene, stabilized
- Dispersant gas or Refrigerant gas (as defined in §173.115 of this subchapter)
- Division 2.1 materials
- Division 2.2 materials (in Class DOT 107 tank cars only)
- Division 2.3 materials
- Formic acid
- Hydrocyanic acid, aqueous solutions
- Hydrofluoric acid, solution

Hydrogen cyanide, stabilized (less than 3% water)
 Hydrogen fluoride, anhydrous
 Hydrogen peroxide, aqueous solutions (greater than 20% hydrogen peroxide)
 Hydrogen peroxide, stabilized
 Hydrogen peroxide and peroxyacetic acid mixtures
 Nitric acid (other than red fuming)
 Phosphorus, amorphous
 Phosphorus, white dry *or* Phosphorus, white, under water *or* Phosphorus white, in solution, *or* Phosphorus, yellow dry *or* Phosphorus, yellow, under water *or* Phosphorus, yellow, in solution
 Phosphorus white, molten
 Potassium nitrate and sodium nitrate mixtures
 Potassium permanganate
 Sulfur trioxide, stabilized
 Sulfur trioxide, uninhibited

(2) In a multi-unit tank car tank, unless the tank is marked on two opposing sides, in letters and numerals no less than 50 mm (2.0 inches) high—

(i) With the proper shipping name specified for the material in the §172.101 table or with a common name authorized for the material in this subchapter (e.g., “Refrigerant Gas”); and

(ii) With the identification number specified for the material in the §172.101 table, unless marked in accordance with §§172.302(a) and 172.332 of this subpart.

(b) A motor vehicle or rail car used to transport a multi-unit tank car tank containing a hazardous material must be marked on each side and each end, as required by §172.332, with the identification number specified for the material in the §172.101 table.

(c) No person may offer for transportation or transport a tank car or multi-unit tank car tank containing unodorized liquefied petroleum gas (LPG) unless it is legibly marked NON-ODORIZED or NOT ODORIZED on two opposing sides near the marked proper shipping name required by paragraphs (a)(1) and (2) of this section, or near the placards. The NON-ODORIZED or NOT ODORIZED marking may appear on a tank car or multi-unit tank car tank

used for both unodorized and odorized LPG.

[Amdt. 172-123, 55 FR 52593, Dec. 21, 1990, as amended at 56 FR 66255, Dec. 20, 1991; 57 FR 45458, Oct. 1, 1992; Amdt. 172-148, 61 FR 28676, June 5, 1996; Amdt. 172-148, 61 FR 50254, Sept. 25, 1996; 66 FR 33425, June 21, 2001; 69 FR 64471, Nov. 4, 2004; 81 FR 35540, June 2, 2016; 85 FR 83380, Dec. 21, 2020]

§ 172.331 Bulk packagings other than portable tanks, cargo tanks, tank cars and multi-unit tank car tanks.

(a) Each person who offers a hazardous material to a motor carrier for transportation in a bulk packaging shall provide the motor carrier with the required identification numbers on placards or plain white square-on-point display configurations, as authorized, or shall affix orange panels containing the required identification numbers to the packaging prior to or at the time the material is offered for transportation, unless the packaging is already marked with the identification number as required by this subchapter.

(b) Each person who offers a bulk packaging containing a hazardous material for transportation shall affix to the packaging the required identification numbers on orange panels, square-on-point configurations or placards, as appropriate, prior to, or at the time the packaging is offered for transportation unless it is already marked with identification numbers as required by this subchapter.

(c) For a bulk packaging contained in or on a transport vehicle or freight container, if the identification number marking on the bulk packaging (e.g., an IBC) required by §172.302(a) is not visible, the transport vehicle or freight container must be marked as required by §172.332 on each side and each end with the identification number specified for the material in the §172.101 table.

[Amdt. 172-123, 55 FR 52593, Dec. 21, 1994, as amended by Amdt. 172-151, 62 FR 1228, Jan. 8, 1997; 62 FR 39398, July 22, 1997]

§ 172.332 Identification number markings.

(a) *General.* When required by §172.301, §172.302, §172.313, §172.326,

§ 172.332

49 CFR Ch. I (10–1–23 Edition)

§ 172.328, § 172.330, or § 172.331, identification number markings must be displayed on orange panels or placards as specified in this section, or on white square-on-point configurations as prescribed in § 172.336(b).

(b) *Orange panels.* Display of an identification number on an orange panel shall be in conformance with the following:

(1) The orange panel must be 160 mm (6.3 inches) high by 400 mm (15.7 inches) wide with a 15 mm (0.6 inches) black outer border. The identification number shall be displayed in 100 mm (3.9 inches) black Helvetica Medium numerals on the orange panel. Measurements may vary from those specified plus or minus 5 mm (0.2 inches).

(2) The orange panel may be made of any durable material prescribed for placards in § 172.519, and shall be of the orange color specified for labels or placards in appendix A to this part.

(3) The name and hazard class of a material may be shown in the upper left border of the orange panel in letters not more than 18 points (0.25 in.) high.

(4) Except for size and color, the orange panel and identification numbers shall be as illustrated for Liquefied petroleum gas:



(c) *Placards.* Display of an identification number on a hazard warning

placard shall be in conformance with the following:

(1) The identification number shall be displayed across the center area of the placard in 88 mm (3.5 inches) black Alpine Gothic or Alternate Gothic No. 3 numerals on a white background 100 mm (3.9 inches) high and approximately 215 mm (8.5 inches) wide and may be outlined with a solid or dotted line border.

(2) The top of the 100 mm (3.9 inches) high white background shall be approximately 40 mm (1.6 inches) above the placard horizontal center line.

(3) An identification number may be displayed only on a placard corresponding to the primary hazard class of the hazardous material.

(4) For a COMBUSTIBLE placard used to display an identification number, the entire background below the white background for the identification number must be white during transportation by rail and may be white during transportation by highway.

(5) The name of the hazardous material and the hazard class may be shown in letters not more than 18 points high immediately within the upper border of the space on the placard bearing the identification number of the material.

(6) If an identification number is placed over the word(s) on a placard, the word(s) should be substantially covered to maximize the effectiveness of the identification number.

(d) *Example.* Except for size and color, the display of an identification number on a placard shall be as illustrated for Acetone:



[Amdt. 172-101, 45 FR 74667, Nov. 10, 1980, as amended by Amdt. 172-81, 48 FR 28099, June 20, 1983; Amdt. 172-110, 52 FR 29527, Aug. 10, 1987; Amdt. 172-123, 55 FR 52593, Dec. 21, 1990; 56 FR 66255, Dec. 20, 1991; Amdt. 172-151, 62 FR 1228, Jan. 8, 1997; 65 FR 50459, Aug. 18, 2000; 68 FR 57632, Oct. 6, 2003; 87 FR 79772, Dec. 27, 2022]

§ 172.334 Identification numbers; prohibited display.

(a) No person may display an identification number on a RADIOACTIVE, EXPLOSIVES 1.1, 1.2, 1.3, 1.4, 1.5 or 1.6, DANGEROUS, or subsidiary hazard placard.

(b) No person may display an identification number on a placard, orange panel or white square-on-point display configuration unless—

(1) The identification number is specified for the material in §172.101;

(2) The identification number is displayed on the placard, orange panel or white square-on-point configuration authorized by §172.332 or §172.336(b), as appropriate, and any placard used for display of the identification number corresponds to the hazard class of the material specified in §172.504;

(3) Except as provided under §172.336 (c)(4) or (c)(5), the package, freight container, or transport vehicle on which the number is displayed contains the hazardous material associated with that identification number in §172.101.

(c) Except as required by §172.332(c)(4) for a combustible liquid, the identification number of a material may be displayed only on the placards required by the tables in §172.504.

(d) Except as provided in §172.336, a placard bearing an identification number may not be used to meet the requirements of subpart F of this part unless it is the correct identification number for all hazardous materials of the same class in the transport vehicle or freight container on which it is displayed.

(e) Except as specified in §172.338, an identification number may not be displayed on an orange panel on a cargo tank unless affixed to the cargo tank by the person offering the hazardous material for transportation in the cargo tank.

(f) If a placard is required by §172.504, an identification number may not be

§ 172.336

displayed on an orange panel unless it is displayed in proximity to the placard.

(g) No person shall add any color, number, letter, symbol, or word other than as specified in this subchapter, to any identification number marking display which is required or authorized by this subchapter.

[Amdt. 172–101, 45 FR 74667, Nov. 10, 1980, as amended by Amdt. 172–104, 51 FR 23078, June 25, 1986; Amdt. 172–110, 52 FR 29528, Aug. 10, 1987; Amdt. 172–123, 55 FR 52593, Dec. 21, 1990; 56 FR 66255, Dec. 20, 1991; Amdt. 172–127, 59 FR 49133, Sept. 26, 1994]

§ 172.336 Identification numbers; special provisions.

(a) When not required or prohibited by this subpart, identification numbers may be displayed on a transport vehicle or a freight container in the manner prescribed by this subpart.

(b) Identification numbers, when required, must be displayed on either orange panels (see §172.332(b)) or on a plain white square-on-point display configuration having the same outside dimensions as a placard. In addition, for materials in hazard classes for which placards are specified and identification number displays are required, but for which identification numbers may not be displayed on the placards authorized for the material (see §172.334(a)), identification numbers must be displayed on orange panels or on the plain white square-on-point display configuration in association with the required placards. An identification number displayed on a white square-on-point display configuration is not considered to be a placard.

(1) The 100 mm (3.9 inch) by 215 mm (8.5 inches) area containing the identification number shall be located as prescribed by §172.332 (c)(1) and (c)(2) and may be outlined with a solid or dotted line border.

(2) [Reserved]

(c) Identification Numbers are not required:

<i>Packaging:</i>	<i>When:</i>	<i>Then the alternative marking requirement is:</i>
On the ends of portable tanks, cargo tanks, or tank cars.	They have more than one compartment and hazardous materials with different identification numbers are being transported therein.	The identification numbers on the sides of the tank are displayed in the same sequence as the compartments containing the materials they identify.
On cargo tanks	They contain only gasoline.	The tank is marked "Gasoline" on each side and rear in letters no less than 50 mm (2 inches) high, or is placarded in accordance with § 172.542(c).
On cargo tanks	They contain only fuel oil.	The cargo tank is marked "Fuel Oil" on each side and rear in letters no less than 50 mm (2 inches) high, or is placarded in accordance with § 172.544(c).
On one end of nurse tanks if that end contains valves, fittings, regulators or gauges when those appurtenances prevent the markings and placard from being properly placed and visible.	They meet the provisions of § 173.315(m) of this subchapter.	N/A.
On cargo tanks, including compartmented cargo tanks, or tank cars.	They contain more than one petroleum distillate fuel.	The identification number for the liquid petroleum distillate fuel having the lowest flash point is displayed. If the cargo tank also contains gasoline and alcohol fuel blends consisting of more than 10% ethanol the identification number "3475" or "1987," as appropriate, must also be displayed.

(d) When a bulk packaging is labeled instead of placarded in accordance with §172.514(c) of this subchapter, identification number markings may be displayed on the package in accordance

with the marking requirements of § 172.301(a)(1) of this subchapter.

[Amdt. 172-101, 45 FR 74667, Nov. 10, 1980, as amended by Amdt. 172-74, 47 FR 40365, Sept. 30, 1982; Amdt. 172-109, 52 FR 13038, Apr. 20, 1987; Amdt. 172-110, 52 FR 29528, Aug. 10, 1987; Amdt. 172-123, 55 FR 52593, Dec. 21, 1990; 56 FR 66255, Dec. 20, 1991; 65 FR 50459, Aug. 18, 2000; 73 FR 4716, Jan. 28, 2008; 76 FR 43527, July 20, 2011; 78 FR 14714, Mar. 7, 2013; 78 FR 65478, Oct. 31, 2013]

§ 172.338 Replacement of identification numbers.

If more than one of the identification number markings on placards, orange panels, or white square-on-point display configurations that are required to be displayed are lost, damaged or destroyed during transportation, the carrier shall replace all the missing or damaged identification numbers as soon as practicable. However, in such a case, the numbers may be entered by hand on the appropriate placard, orange panel or white square-on-point display configuration providing the correct identification numbers are entered legibly using an indelible marking material. When entered by hand, the identification numbers must be located in the white display area specified in § 172.332. This section does not preclude required compliance with the placarding requirements of subpart F of this subchapter.

[Amdt. 172-110, 52 FR 29528, Aug. 10, 1987]

Subpart E—Labeling

§ 172.400 General labeling requirements.

(a) Except as specified in § 172.400a, each person who offers for transportation or transports a hazardous material in any of the following packages or containment devices, shall label the package or containment device with labels specified for the material in the § 172.101 table and in this subpart:

- (1) A non-bulk package;
- (2) A bulk packaging, other than a cargo tank, portable tank, or tank car, with a volumetric capacity of less than 18 m³ (640 cubic feet), unless placarded in accordance with subpart F of this part;
- (3) A portable tank of less than 3785 L (1000 gallons) capacity, unless placarded in accordance with subpart F of this part;
- (4) A DOT Specification 106 or 110 multi-unit tank car tank, unless placarded in accordance with subpart F of this part; and
- (5) An overpack, freight container or unit load device, of less than 18 m³ (640 cubic feet), which contains a package for which labels are required, unless placarded or marked in accordance with § 172.512 of this part.

(b) Labeling is required for a hazardous material which meets one or more hazard class definitions, in accordance with column 6 of the § 172.101 table and the following table:

TABLE 1 TO PARAGRAPH (b)

Hazard class or division	Label name	Label design or section reference
1.1	EXPLOSIVES 1.1	172.411
1.2	EXPLOSIVES 1.2	172.411
1.3	EXPLOSIVES 1.3	172.411
1.4	EXPLOSIVES 1.4	172.411
1.5	EXPLOSIVES 1.5	172.411
1.6	EXPLOSIVES 1.6	172.411
2.1	FLAMMABLE GAS	172.417
2.2	NON-FLAMMABLE GAS	172.415
2.3	POISON GAS	172.416
3 Flammable Liquid (Combustible liquid)	FLAMMABLE LIQUID (none)	172.419
4.1	FLAMMABLE SOLID	172.420
4.2	SPONTANEOUSLY COMBUSTIBLE	172.422
4.3	DANGEROUS WHEN WET	172.423
5.1	OXIDIZER	172.426
5.2	ORGANIC PEROXIDE	172.427
6.1 (material poisonous by inhalation (see § 171.8 of this subchapter)).	POISON INHALATION HAZARD	172.429
6.1 (other than a material poisonous by inhalation)	POISON	172.430
6.1 (inhalation hazard, Zone A or B)	POISON INHALATION HAZARD	172.429

TABLE 1 TO PARAGRAPH (b)—Continued

Hazard class or division	Label name	Label design or section reference
6.1 (other than inhalation hazard, Zone A or B)	POISON	172.430
6.2	INFECTIOUS SUBSTANCE	172.432
7 (see § 172.403)	RADIOACTIVE WHITE-I	172.436
7	RADIOACTIVE YELLOW-II	172.438
7	RADIOACTIVE YELLOW-III	172.440
7 (fissile radioactive material; see § 172.402)	FISSILE	172.441
7 (empty packages, see § 173.428 of this subchapter) ..	EMPTY	172.450
8	CORROSIVE	172.442
9	CLASS 9	172.446

[Amdt. 172–123, 55 FR 52593, Dec. 21, 1990, as amended at 56 FR 66255, Dec. 20, 1991; Amdt. 172–151, 62 FR 1228, Jan. 8, 1997; 64 FR 10776, Mar. 5, 1999; 64 FR 51918, Sept. 27, 1999; 69 FR 3668, Jan. 26, 2004; 69 FR 64471, Nov. 4, 2004; 78 FR 60753, Oct. 2, 2013; 85 FR 83381, Dec. 21, 2020; 87 FR 79773, Dec. 27, 2022]

§ 172.400a Exceptions from labeling.

(a) Notwithstanding the provisions of § 172.400, a label is not required on—

(1) A Dewar flask meeting the requirements in §173.320 of this subchapter or a cylinder containing a Division 2.1, 2.2, or 2.3 material that is durably and legibly marked in accordance with CGA C–7, Appendix A (IBR; see §171.7 of this subchapter). Notwithstanding this exception, overpacks must be labeled (see §173.25 of this subchapter).

(2) A package or unit of military explosives (including ammunition) shipped by or on behalf of the DOD when in—

(i) Freight containerload, carload or truckload shipments, if loaded and unloaded by the shipper or DOD; or

(ii) Unitized or palletized break-bulk shipments by cargo vessel under charter to DOD if at least one required label is displayed on each unitized or palletized load.

(3) A package containing a hazardous material other than ammunition that is—

(i) Loaded and unloaded under the supervision of DOD personnel, and

(ii) Escorted by DOD personnel in a separate vehicle.

(4) A compressed gas cylinder permanently mounted in or on a transport vehicle.

(5) A freight container, aircraft unit load device or portable tank, which—

(i) Is placarded in accordance with subpart F of this part, or

(ii) Conforms to paragraph (a)(3) or (b)(3) of §172.512.

(6) An overpack or unit load device in or on which labels representative of each hazardous material in the overpack or unit load device are visible.

(7) A package of low specific activity radioactive material and surface contaminated objects, when transported under §173.427(a)(6)(vi) of this subchapter.

(8) Packages containing toy plastic or paper caps for toy pistols described as “UN0349, Articles, explosive, n.o.s. (Toy caps), 1.4S” or “NA0337, Toy caps, 1.4S” when offered in conformance with the conditions of §172.102(c)(1), Special provision 382.

(b) Certain exceptions to labeling requirements are provided for small quantities and limited quantities in applicable sections in part 173 of this subchapter.

(c) Notwithstanding the provisions of §172.402(a), a Division 6.1 subsidiary hazard label is not required on a package containing a Class 8 (corrosive) material which has a subsidiary hazard of Division 6.1 (poisonous) if the toxicity of the material is based solely on the corrosive destruction of tissue rather than systemic poisoning. In addition, a Division 4.1 subsidiary hazard label is not required on a package bearing a Division 4.2 label.

(d) A package containing a material poisonous by inhalation (see §171.8 of this subchapter) in a closed transport vehicle or freight container may be exempted from the POISON INHALATION

HAZARD or POISON GAS label or placard, under the conditions set forth in §171.23(b)(10) of this subchapter.

[Amdt. 172-123, 55 FR 52594, Dec. 21, 1990]

EDITORIAL NOTE: For FEDERAL REGISTER citations affecting §172.400a, see the List of CFR Sections Affected, which appears in the Finding Aids section of the printed volume and at *www.govinfo.gov*.

§ 172.401 Prohibited labeling.

(a) Except as otherwise provided in this section, no person may offer for transportation and no carrier may transport a package bearing a label specified in this subpart unless:

(1) The package contains a material that is a hazardous material, and

(2) The label represents a hazard of the hazardous material in the package.

(b) No person may offer for transportation and no carrier may transport a package bearing any marking or label which by its color, design, or shape could be confused with or conflict with a label prescribed by this part.

(c) The restrictions in paragraphs (a) and (b) of this section, do not apply to packages labeled in conformance with:

(1) The UN Recommendations (IBR, see §171.7 of this subchapter);

(2) The IMDG Code (IBR, see §171.7 of this subchapter);

(3) The ICAO Technical Instructions (IBR, see §171.7 of this subchapter);

(4) The TDG Regulations (IBR, see §171.7 of this subchapter).

(5) The Globally Harmonized System of Classification and Labelling of Chemicals (GHS) (IBR, see §171.7 of this subchapter).

(d) The provisions of paragraph (a) of this section do not apply to a packaging bearing a label if that packaging is:

(1) Unused or cleaned and purged of all residue;

(2) Transported in a transport vehicle or freight container in such a manner that the packaging is not visible during transportation; and

(3) Loaded by the shipper and unloaded by the shipper or consignee.

[Amdt. 172-9, 41 FR 15996, Apr. 15, 1976, as amended by Amdt. 172-75, 47 FR 44471, Oct. 7, 1982; Amdt. 172-77, 47 FR 54822, Dec. 6, 1982; Amdt. 172-94, 49 FR 38134, Sept. 27, 1984; Amdt. 172-100, 50 FR 41521, Oct. 11, 1985; Amdt. 172-123, 55 FR 52594, Dec. 21, 1990; Amdt. 172-132, 58 FR 50501, Sept. 27, 1993; 66 FR 8647, Feb. 1, 2001; 66 FR 45379, Aug. 28, 2001; 68 FR 75741, 75742, Dec. 31, 2003; 74 FR 2252, Jan. 14, 2009]

§ 172.402 Additional labeling requirements.

(a) *Subsidiary hazard labels.* Each package containing a hazardous material—

(1) Shall be labeled with primary and subsidiary hazard labels as specified in column 6 of the §172.101 table (unless excepted in paragraph (a)(2) of this section); and

(2) For other than Class 1 or Class 2 materials (for subsidiary labeling requirements for Class 1 or Class 2 materials see paragraph (e) or paragraphs (f) and (g), respectively, of this section), if not already labeled under paragraph (a)(1) of this section, shall be labeled with subsidiary hazard labels in accordance with the following table:

SUBSIDIARY HAZARD LABELS

Subsidiary hazard level (packing group)	Subsidiary Hazard (Class or Division)						
	3	4.1	4.2	4.3	5.1	6.1	8
I	X	***	***	X	X	X	X
II	X	X	X	X	X	X	X
III	*	X	X	X	X	X	X

X—Required for all modes.

*—Required for all modes, except for a material with a flash point at or above 38 °C (100 °F) transported by rail or highway.

**—Reserved

***—Impossible as subsidiary hazard.

(b) *Display of hazard class on labels.* The appropriate hazard class or division number must be displayed in the lower corner of a primary hazard label and a subsidiary hazard label.

(c) *Cargo Aircraft Only label.* Each person who offers for transportation or transports by aircraft a package containing a hazardous material which is authorized on cargo aircraft only shall label the package with a CARGO AIRCRAFT ONLY label specified in §172.448 of this subpart.

§ 172.403

49 CFR Ch. I (10–1–23 Edition)

(d) *Class 7 (Radioactive) Materials.* Except as otherwise provided in this paragraph, each package containing a Class 7 material that also meets the definition of one or more additional hazard classes must be labeled as a Class 7 material as required by §172.403 and for each additional hazard.

(1) A subsidiary label is not required for a package containing material that satisfies all of the criteria in §173.4, §173.4a, or §173.4b applicable to the subsidiary hazard class.

(2) Each package or overpack containing fissile material, other than fissile-excepted material (see §173.453 of this subchapter) must bear two FISSILE labels, affixed to opposite sides of the package or overpack, which conforms to the figure shown in §172.441; such labels, where applicable, must be affixed adjacent to the labels for radioactive materials.

(e) *Class 1 (explosive) Materials.* In addition to the label specified in column 6 of the §172.101 table, each package of Class 1 material that also meets the definition for:

(1) Division 6.1, Packing Groups I or II, shall be labeled POISON or POISON INHALATION HAZARD, as appropriate.

(2) Class 7, shall be labeled in accordance with §172.403 of this subpart.

(f) *Division 2.2 materials.* In addition to the label specified in column 6 of the §172.101 table, each package of Division 2.2 material that also meets the definition for an oxidizing gas (see §171.8 of this subchapter) must be labeled OXIDIZER.

(g) *Division 2.3 materials.* In addition to the label specified in column 6 of the §172.101 table, each package of Division

2.3 material that also meets the definition for:

(1) Division 2.1, must be labeled Flammable Gas;

(2) Division 5.1, must be labeled Oxidizer; and

(3) Class 8, must be labeled Corrosive.

[Amdt. 172–123, 55 FR 52594, Dec. 21, 1990, as amended at 56 FR 66255, Dec. 20, 1991; Amdt. 172–139, 59 FR 67490, Dec. 29, 1994; Amdt. 172–140, 60 FR 26805, May 18, 1995; Amdt. 172–149, 61 FR 27173, May 30, 1996; 62 FR 39405, July 22, 1997; 66 FR 33425, June 21, 2001; 69 FR 3668, Jan. 26, 2004; 74 FR 2252, Jan. 14, 2009; 76 FR 56314, Sept. 13, 2011; 79 FR 40609, July 11, 2014]

§ 172.403 Class 7 (radioactive) material.

(a) Unless excepted from labeling by §§173.421 through 173.427 of this subchapter, each package of radioactive material must be labeled as provided in this section.

(b) The proper label to affix to a package of Class 7 (radioactive) material is based on the radiation level at the surface of the package and the transport index. The proper category of label must be determined in accordance with paragraph (c) of this section. The label to be applied must be the highest category required for any of the two determining conditions for the package. RADIOACTIVE WHITE-I is the lowest category and RADIOACTIVE YELLOW-III is the highest. For example, a package with a transport index of 0.8 and a maximum surface radiation level of 0.6 millisievert (60 millirem) per hour must bear a RADIOACTIVE YELLOW-III label.

(c) Category of label to be applied to Class 7 (radioactive) materials packages:

Transport index	Maximum radiation level at any point on the external surface	Label category ¹
0 ²	Less than or equal to 0.005 mSv/h (0.5 mrem/h).	WHITE-I.
More than 0 but not more than 1	Greater than 0.005 mSv/h (0.5 mrem/h) but less than or equal to 0.5 mSv/h (50 mrem/h).	YELLOW-II.
More than 1 but not more than 10	Greater than 0.5 mSv/h (50 mrem/h) but less than or equal to 2 mSv/h (200 mrem/h).	YELLOW-III.
More than 10	Greater than 2 mSv/h (200 mrem/h) but less than or equal to 10 mSv/h (1,000 mrem/h).	YELLOW-III (Must be shipped under exclusive use provisions; see 173.441(b) of this subchapter).

¹ Any package containing a “highway route controlled quantity” (§173.403 of this subchapter) must be labelled as RADIOACTIVE YELLOW-III.

² If the measured TI is not greater than 0.05, the value may be considered to be zero.

(d) *EMPTY label.* See §173.428(e) of this subchapter for EMPTY labeling requirements.

(e) *FISSILE label.* For packages required in §172.402 to bear a FISSILE label, each such label must be completed with the criticality safety index (CSI) assigned in the NRC or DOE package design approval, or in the certificate of approval for special arrangement or the certificate of approval for the package design issued by the Competent Authority for import and export shipments. For overpacks and freight containers required in §172.402 to bear a FISSILE label, the CSI on the label must be the sum of the CSIs for all of the packages contained in the overpack or freight container.

(f) Each package required by this section to be labeled with a RADIOACTIVE label must have two of these labels, affixed to opposite sides of the package. (See §172.406(e)(3) for freight container label requirements).

(g) The following applicable items of information must be entered in the blank spaces on the RADIOACTIVE label by legible printing (manual or mechanical), using a durable weather resistant means of marking:

(1) *Contents.* Except for LSA-1 material, the names of the radionuclides as taken from the listing of radionuclides in §173.435 of this subchapter (symbols which conform to established radiation protection terminology are authorized, *i.e.*, ⁹⁹Mo, ⁶⁰Co, etc.). For mixtures of radionuclides, with consideration of space available on the label, the radionuclides that must be shown must be determined in accordance with §173.433(g) of this subchapter. For LSA-I material, the term "LSA-I" may be used in place of the names of the radionuclides.

(2) *Activity.* The maximum activity of the radioactive contents in the package during transport must be expressed in appropriate SI units (*e.g.*, Becquerels (Bq), Terabecquerels (TBq)). The activity may also be stated in appropriate customary units (*e.g.*, Curies (Ci), milliCuries (mCi), microCuries (uCi)) in parentheses following the SI units. Abbreviations are authorized. Except for plutonium-239 and plutonium-241, the weight in grams or kilograms of fissile radionuclides (or the mass of

each fissile nuclide for mixtures when appropriate) may be inserted instead of activity units. For plutonium-239 and plutonium-241, the weight in grams of fissile radionuclides (or the mass of each fissile nuclide for mixtures when appropriate) may be inserted in addition to the activity units.

(3) *Transport index.* (see §173.403 of this subchapter.)

(h) When one or more packages of Class 7 (radioactive) material are placed within an overpack, the overpack must be labeled as prescribed in this section, except as follows:

(1) The "contents" entry on the label may state "mixed" in place of the names of the radionuclides unless each inside package contains the same radionuclide(s).

(2) The "activity" entry on the label must be determined by adding together the number of becquerels of the Class 7 (radioactive) materials packages contained therein.

(3) For an overpack, the transport index (TI) must be determined by adding together the transport indices of the Class 7 (radioactive) materials packages contained therein, except that for a rigid overpack, the transport index (TI) may alternatively be determined by direct measurement as prescribed in §173.403 of this subchapter under the definition for "transport index," taken by the person initially offering the packages contained within the overpack for shipment.

(4) The category of Class 7 label for the overpack must be determined from the table in §172.403(c) using the TI derived according to paragraph (h)(3) of this section, and the maximum radiation level on the surface of the overpack.

(5) The category of the Class 7 label of the overpack, and not that of any of the packages contained therein, must be used in accordance with Table 1 of §172.504(e) to determine when the transport vehicle must be placarded.

(6) For fissile material, the criticality safety index which must be entered on the overpack FISSILE label is the sum of the criticality safety indices of the individual packages in the overpack, as stated in the certificate of approval for the package design issued

§ 172.404

by the NRC or the U.S. Competent Authority.

[Amdt. 172–29, 41 FR 15996, Apr. 15, 1976]

EDITORIAL NOTE: For FEDERAL REGISTER citations affecting § 172.403, see the List of CFR Sections Affected, which appears in the Finding Aids section of the printed volume and at www.govinfo.gov.

§ 172.404 Labels for mixed and consolidated packaging.

(a) *Mixed packaging.* When compatible hazardous materials having different hazard classes are packed within the same packaging, or within the same outside container or overpack as described in § 173.25, the packaging, outside container or overpack must be labeled as required for each class of hazardous material contained therein.

(b) *Consolidated packaging.* When two or more packages containing compatible hazardous materials are placed within the same outside container or overpack, the outside container or overpack must be labeled as required for each class of hazardous material contained therein, unless labels representative of each hazardous material in the outside container or overpack are visible.

(c) *Consolidation bins used by a single motor carrier.* Notwithstanding the provisions of paragraph (b) of this section, labeling of a consolidation bin is not required under the following conditions:

(1) The consolidation bin must be reusable, made of materials such as plastic, wood, or metal and must have a capacity of 64 cubic feet or less;

(2) Hazardous material packages placed in the consolidation bin must be properly labeled in accordance with this subpart;

(3) Packages must be compatible as specified in § 177.848 of this subchapter;

(4) Packages may only be placed within the consolidation bin and the bin be loaded on a motor vehicle by an employee of a single motor carrier;

(5) Packages must be secured within the consolidation bin by other packages or by other suitable means in such a manner as to prevent shifting of, or significant relative motion between, the packages that would likely compromise the integrity of any package;

49 CFR Ch. I (10–1–23 Edition)

(6) The consolidation bin must be clearly and legibly marked on a tag or fixed display device with an indication of each hazard class or division contained within the bin;

(7) The consolidation bin must be properly blocked and braced within the transport vehicle; and

(8) Consolidation bins may only be transported by a single motor carrier, or on railcars transporting such vehicles.

[76 FR 43527, July 20, 2011]

§ 172.405 Authorized label modifications.

(a) For Classes 1, 2, 3, 4, 5, 6, and 8, text indicating a hazard (for example FLAMMABLE LIQUID) is not required on a primary or subsidiary label.

(b) For a package containing Oxygen, compressed, or Oxygen, refrigerated liquid, the OXIDIZER label specified in § 172.426 of this subpart, modified to display the word “OXYGEN” instead of “OXIDIZER”, and the class number “2” instead of “5.1”, may be used in place of the NON-FLAMMABLE GAS and OXIDIZER labels. Notwithstanding the provisions of paragraph (a) of this section, the word “OXYGEN” must appear on the label.

(c) For a package containing a Division 6.1, Packing Group III material, the POISON label specified in § 172.430 may be modified to display the text “PG III” instead of “POISON” or “TOXIC” below the mid line of the label. Also see § 172.313(d).

[Amdt. 172–123, 55 FR 52594, Dec. 21, 1990, as amended at 56 FR 66255, Dec. 20, 1991; 57 FR 45458, Oct. 1, 1992; 64 FR 10776, Mar. 5, 1999; 66 FR 33425, June 21, 2001]

§ 172.406 Placement of labels.

(a) *General.* (1) Except as provided in paragraphs (b) and (e) of this section, each label required by this subpart must—

(i) Be printed on or affixed to a surface (other than the bottom) of the package or containment device containing the hazardous material;

(ii) Be located on the same surface of the package and near the proper shipping name marking, if the package dimensions are adequate; and

(iii) For transportation by aircraft, the entire label(s) must appear on one

side of the package. For cylindrical packages, the label must be of such dimensions that it will not overlap itself. In the case of cylindrical packages containing radioactive materials, which require two identical labels, these labels must be centered on opposite points of the circumference and must not overlap each other. If the dimensions of the package are such that two identical labels cannot be affixed without overlapping each other, one label is acceptable provided it does not overlap itself.

(2) Except as provided in paragraph (e) of this section, duplicate labeling is not required on a package or containment device (such as to satisfy redundant labeling requirements).

(b) *Exceptions.* A label may be printed on or placed on a securely affixed tag, or may be affixed by other suitable means to:

(1) A package that contains no radioactive material and which has dimensions less than those of the required label;

(2) A cylinder; and

(3) A package which has such an irregular surface that a label cannot be satisfactorily affixed.

(c) *Placement of multiple labels.* When primary and subsidiary hazard labels are required, they must be displayed next to each other. Placement conforms to this requirement if labels are within 150 mm (6 inches) of one another.

(d) *Contrast with background.* Each label must be printed on or affixed to a background color contrasting to the color specification of the label as required by §172.407(d)(1), or must have a dotted or solid line outer border, to enhance the visibility of the label. However, the dotted or solid line outer border may also be used for backgrounds of contrasting color.

(e) *Duplicate labeling.* Generally, only one of each different required label must be displayed on a package. However, duplicate labels must be displayed on at least two sides or two ends (other than the bottom) of—

(1) Each package or overpack having a volume of 1.8 m³ (64 cubic feet) or more;

(2) Each non-bulk package containing a radioactive material;

(3) Each DOT 106 or 110 multi-unit tank car tank. Labels must be displayed on each end;

(4) Each portable tank of less than 3,785 L (1000 gallons) capacity;

(5) Each freight container or aircraft unit load device having a volume of 1.8 m³ (64 cubic feet) or more, but less than 18 m³ (640 cubic feet). One of each required label must be displayed on or near the closure; and

(6) An IBC having a volume of 1.8 m³ (64 cubic feet) or more.

(f) *Visibility.* A label must be clearly visible and may not be obscured by markings or attachments.

[Amdt. 172-123, 55 FR 52594, Dec. 21, 1990, as amended at 56 FR 66255, Dec. 20, 1991; Amdt. 172-130, 58 FR 51531, Oct. 1, 1993; 73 FR 4716, Jan. 28, 2008; 81 FR 35540, June 2, 2016; 87 FR 44991, July 26, 2022]

§ 172.407 Label specifications.

(a) *Durability.* Each label, whether printed on or affixed to a package, must be durable and weather resistant. A label on a package must be able to withstand, without deterioration or a substantial change in color, a 30-day exposure to conditions incident to transportation that reasonably could be expected to be encountered by the labeled package.

(b) *Design.* (1) Except for size and color, the printing, inner border, and symbol on each label must be as shown in §§172.411 through 172.448 of this subpart, as appropriate.

(2) The dotted line border shown on each label is not part of the label specification, except when used as an alternative for the solid line outer border to meet the requirements of §172.406(d) of this subpart.

(c) *Size.* (1) Each diamond (square-on-point) label prescribed in this subpart must be at least 100 mm (3.9 inches) on each side with each side having a solid line inner border approximately 5 mm (.2 inches) inside and parallel to the edge. The 5 mm (.2 inches) measurement is from the outside edge of the label to the outside of the solid line forming the inner border.

(i) If the size of the package so requires, the dimensions of the label and

its features may be reduced proportionally provided the symbol and other elements of the label remain clearly visible.

(ii) Where dimensions are not specified, all features shall be in approximate proportion to those shown in §§172.411 through 172.448 of this subpart, as appropriate.

(iii) [Reserved]

(iv) For domestic transportation, a packaging labeled prior to January 1, 2017, and in conformance with the requirements of this paragraph in effect on December 31, 2014, may continue in service until the end of its useful life.

(2) The CARGO AIRCRAFT ONLY label must be a rectangle measuring at least 110 mm (4.3 inches) in height by 120 mm (4.7 inches) in width. The words “CARGO AIRCRAFT ONLY” must be shown in letters measuring at least 6.3 mm (0.25 inches) in height.

(3) Except as otherwise provided in this subpart, the hazard class number, or division number, as appropriate, must be at least 6.3 mm (0.25 inches) and not greater than 12.7 mm (0.5 inches).

(4) When text indicating a hazard is displayed on a label, the label name must be shown in letters measuring at least 7.6 mm (0.3 inches) in height. For SPONTANEOUSLY COMBUSTIBLE or DANGEROUS WHEN WET labels, the words “Spontaneously” and “When Wet” must be shown in letters measuring at least 5.1 mm (0.2 inches) in height.

(5) The symbol on each label must be proportionate in size to that shown in the appropriate section of this subpart.

(d) *Color.* (1) The background color on each label must be as prescribed in §§172.411 through 172.448 of this subpart, as appropriate.

(2) The symbol, text, numbers, and border must be shown in black on a label except that—

(i) White may be used on a label with a one color background of green, red or blue.

(ii) White must be used for the text and class number for the CORROSIVE label.

(iii) White may be used for the symbol for the ORGANIC PEROXIDE label.

(A) If white is used for the symbol for the ORGANIC PEROXIDE label then

the solid line forming the inner border on the upper half of the label must also be white.

(B) *Transitional exception.* A label in conformance with the requirements of this paragraph in effect on December 31, 2014, may continue to be used until December 31, 2016.

(C) For domestic transportation, a packaging labeled prior to January 1, 2017 and in conformance with the requirements of this paragraph in effect on December 31, 2014, may continue in service until the end of its useful life.

(iv) The FLAMMABLE GAS label displayed on cylinders and gas cartridges for liquefied petroleum gases may be shown in the background color of the receptacle if adequate contrast is provided.

(3) Black and any color on a label must be able to withstand, without substantial change, a 72-hour fadeometer test (for a description of equipment designed for this purpose, see ASTM G 23–69 (1975) or ASTM G 26–70).

(4)(i) A color on a label, upon visual examination, must fall within the color tolerances—

(A) Displayed on color charts conforming to the technical specifications for charts set forth in table 1 or 2 in appendix A to this part; or

(B) For labels printed on packaging surfaces, specified in table 3 in appendix A to this part.

(ii) Color charts conforming to appendix A to this part are on display at the Standards and Rulemaking Division, Pipeline and Hazardous Materials Safety Administration, U.S. Department of Transportation, East Building, 2nd Floor, 1200 New Jersey Avenue SE., Washington, DC 20590–0001.

(5) The following color standards in the PANTONE® formula guide coated/uncoated (see §171.7(b) of this subchapter) may be used to achieve the required colors on markings and hazard warning labels and placards:

(i) For Red—Use PANTONE® 186 U

(ii) For Orange—Use PANTONE® 151 U

(iii) For Yellow—Use PANTONE® 109 U

(iv) For Green—Use PANTONE® 335 U

(v) For Blue—Use PANTONE® 285 U

(vi) For Purple—Use PANTONE® 259 U

(6) Where specific colors from the PANTONE MATCHING SYSTEM® are applied as opaque coatings, such as paint, enamel, or plastic, or where labels are printed directly on the surface of a packaging, a spectrophotometer or other instrumentation must be used to ensure a proper match with the color standards in the PANTONE® formula guide coated/uncoated for colors prescribed in paragraph (d)(5) of this section. PANTONE® is the property of Pantone, Inc.

(7) The specified label color must extend to the edge of the label in the area designated on each label, except for the CORROSIVE, RADIOACTIVE YELLOW-II, and RADIOACTIVE YELLOW-III labels on which the color must extend only to the inner border.

(e) *Form identification.* A label may contain form identification information, including the name of its maker, provided that information is printed outside the solid line inner border in no larger than 10-point type.

(f) *Exceptions.* Except for materials poisonous by inhalation (see §171.8 of this subchapter), a label conforming to specifications in the UN Recommendations, the ICAO Technical Instructions, the IMDG Code, or the Transport Canada TDG Regulations (IBR, see §171.7 of this subchapter) may be used in place of a corresponding label that conforms to the requirements of this subpart.

(g) *Trefoil symbol.* The trefoil symbol on the RADIOACTIVE WHITE-I, RADIOACTIVE YELLOW-II, and RADIOACTIVE YELLOW-III labels must meet the appropriate specifications in appendix B of this part.

[Amdt. 172-123, 55 FR 52595, Dec. 21, 1990]

EDITORIAL NOTE: For FEDERAL REGISTER citations affecting §172.407, see the List of CFR Sections Affected, which appears in the Finding Aids section of the printed volume and at www.govinfo.gov.

§ 172.411 EXPLOSIVE 1.1, 1.2, 1.3, 1.4, 1.5 and 1.6 labels, and EXPLOSIVE Subsidiary label.

(a) Except for size and color, the EXPLOSIVE 1.1, EXPLOSIVE 1.2 and EXPLOSIVE 1.3 labels must be as follows:



(b) In addition to complying with §172.407, the background color on the EXPLOSIVE 1.1, EXPLOSIVE 1.2 and EXPLOSIVE 1.3 labels must be orange. The “**” must be replaced with the appropriate division number and compatibility group letter. The compatibility group letter must be the same size as the division number and must be shown as a capitalized Roman letter.

(c) Except for size and color, the EXPLOSIVE 1.4, EXPLOSIVE 1.5 and EXPLOSIVE 1.6 labels must be as follows:

EXPLOSIVE 1.4:



§ 172.415

49 CFR Ch. I (10-1-23 Edition)

EXPLOSIVE 1.5:

hazard label. Except for size and color, the EXPLOSIVE subsidiary label must be as follows:

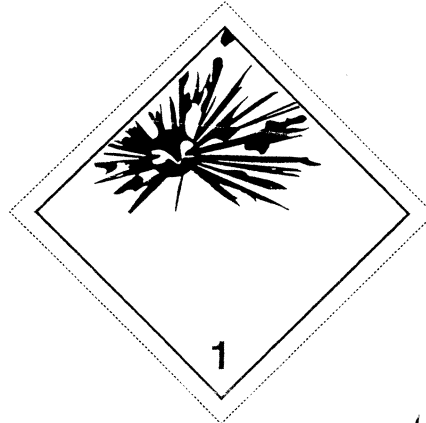

EXPLOSIVE 1.6:

(f) The EXPLOSIVE subsidiary label must comply with §172.407.



[Amdt. 172-123, 56 FR 66256, Dec. 20, 1991, as amended by Amdt. 172-139, 59 FR 67490, Dec. 29, 1994; 66 FR 33425, June 21, 2001; 68 FR 45031, July 31, 2003]

§ 172.415 NON-FLAMMABLE GAS label.

(a) Except for size and color, the NON-FLAMMABLE GAS label must be as follows:

(d) In addition to complying with §172.407, the background color on the EXPLOSIVE 1.4, EXPLOSIVE 1.5 and EXPLOSIVE 1.6 label must be orange. The “*” must be replaced with the appropriate compatibility group. The compatibility group letter must be shown as a capitalized Roman letter. Division numbers must measure at least 30 mm (1.2 inches) in height and at least 5 mm (0.2 inches) in width.

(e) An EXPLOSIVE subsidiary label is required for materials identified in Column (6) of the HMT as having an explosive subsidiary hazard. The division number or compatibility group letter may be displayed on the subsidiary

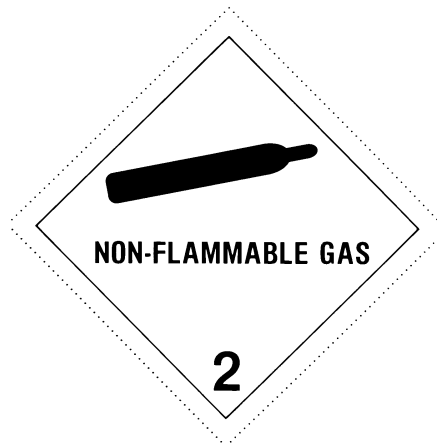

(b) In addition to complying with §172.407, the background color on the

NON-FLAMMABLE GAS label must be green.

[Amdt. 172-123, 56 FR 66256, Dec. 20, 1991]

§ 172.416 POISON GAS label.

(a) Except for size and color, the POISON GAS label must be as follows:



(b) In addition to complying with §172.407, the background on the POISON GAS label and the symbol must be white. The background of the upper diamond must be black and the lower point of the upper diamond must be 14 mm (0.54 inches) above the horizontal center line.

[62 FR 39405, July 22, 1997]

§ 172.417 FLAMMABLE GAS label.

(a) Except for size and color, the FLAMMABLE GAS label must be as follows:

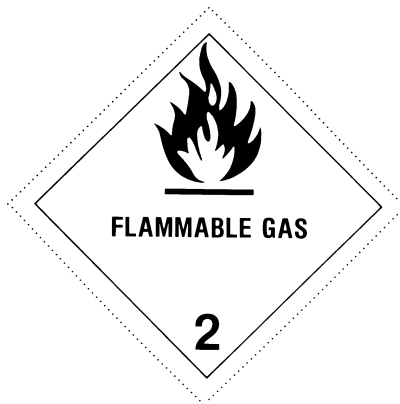

(b) In addition to complying with §172.407, the background color on the FLAMMABLE GAS label must be red.

[Amdt. 172-123, 56 FR 66257, Dec. 20, 1991]

§ 172.419 FLAMMABLE LIQUID label.

(a) Except for size and color the FLAMMABLE LIQUID label must be as follows:

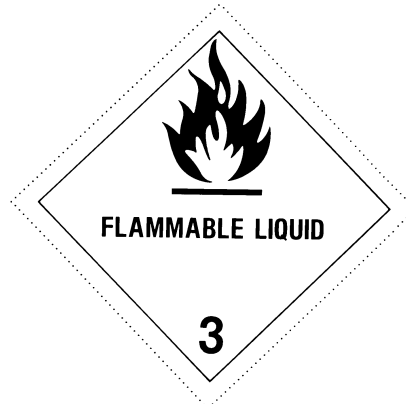

(b) In addition to complying with §172.407, the background color on the FLAMMABLE LIQUID label must be red.

[Amdt. 172-123, 56 FR 66257, Dec. 20, 1991]

§ 172.420 FLAMMABLE SOLID label.

(a) Except for size and color, the FLAMMABLE SOLID label must be as follows:



§ 172.422

(b) In addition to complying with §172.407, the background on the FLAMMABLE SOLID label must be white with vertical red stripes equally spaced on each side of a red stripe placed in the center of the label. The red vertical stripes must be spaced so that, visually, they appear equal in width to the white spaces between them. The symbol (flame) and text (when used) must be overprinted. The text "FLAMMABLE SOLID" may be placed in a white rectangle.

[Amdt. 172-123, 56 FR 66257, Dec. 20, 1991]

§ 172.422 SPONTANEOUSLY COMBUSTIBLE label.

(a) Except for size and color, the SPONTANEOUSLY COMBUSTIBLE label must be as follows:



(b) In addition to complying with §172.407, the background color on the lower half of the SPONTANEOUSLY COMBUSTIBLE label must be red and the upper half must be white.

[Amdt. 172-123, 56 FR 66257, Dec. 20, 1991, as amended at 57 FR 45458, Oct. 1, 1992]

§ 172.423 DANGEROUS WHEN WET label.

(a) Except for size and color, the DANGEROUS WHEN WET label must be as follows:

49 CFR Ch. I (10-1-23 Edition)



(b) In addition to complying with §172.407, the background color on the DANGEROUS WHEN WET label must be blue.

[Amdt. 172-123, 56 FR 66257, Dec. 20, 1991]

§ 172.426 OXIDIZER label.

(a) Except for size and color, the OXIDIZER label must be as follows:



(b) In addition to complying with §172.407, the background color on the OXIDIZER label must be yellow.

[Amdt. 172-123, 56 FR 66257, Dec. 20, 1991]

§ 172.427 ORGANIC PEROXIDE label.

(a) Except for size and color, the ORGANIC PEROXIDE label must be as follows:



§ 172.429

(b) In addition to complying with §172.407, the background on the ORGANIC PEROXIDE label must be red in the top half and yellow in the lower half.

[71 FR 78627, Dec. 29, 2006]

§ 172.429 POISON INHALATION HAZARD label.

(a) Except for size and color, the POISON INHALATION HAZARD label must be as follows:



(b) In addition to complying with §172.407, the background on the POISON INHALATION HAZARD label and the symbol must be white. The background of the upper diamond must be black and the lower point of the upper diamond must be 14 mm (0.54 inches) above the horizontal center line.

[62 FR 39406, July 22, 1997]

§ 172.430 POISON label.

(a) Except for size and color, the POISON label must be as follows:

49 CFR Ch. I (10–1–23 Edition)



(b) In addition to complying with §172.407, the background on the POISON label must be white. The word "TOXIC" may be used in lieu of the word "POISON".

[Amdt. 172–123, 56 FR 66258, Dec. 20, 1991, as amended by Amdt. 172–139, 59 FR 67490, Dec. 29, 1994]

§ 172.431 [Reserved]

§ 172.432 INFECTIOUS SUBSTANCE label.

(a) Except for size and color, the INFECTIOUS SUBSTANCE label must be as follows:



(b) In addition to complying with §172.407, the background on the INFECTIOUS SUBSTANCE label must be white.

(c) Labels conforming to requirements in place on August 18, 2011 may

continue to be used until October 1, 2014.

[Amdt. 172-123, 56 FR 66258, Dec. 20, 1991, as amended at 67 FR 53136, Aug. 14, 2002; 76 FR 43527, July 20, 2011; 76 FR 56314, Sept. 13, 2011; 76 FR 81400, Dec. 28, 2011]

§ 172.436 RADIOACTIVE WHITE-I label.

(a) Except for size and color, the RADIOACTIVE WHITE-I label must be as follows:



(b) In addition to complying with § 172.407, the background on the RADIOACTIVE WHITE-I label must be white. The printing and symbol must be black, except for the “I” which must be red.

[Amdt. 172-123, 56 FR 66259, Dec. 20, 1991]

§ 172.438 RADIOACTIVE YELLOW-II label.

(a) Except for size and color, the RADIOACTIVE YELLOW-II must be as follows:



(b) In addition to complying with § 172.407, the background color on the RADIOACTIVE YELLOW-II label must be yellow in the top half and white in the lower half. The printing and symbol must be black, except for the “II” which must be red.

[Amdt. 172-123, 56 FR 66259, Dec. 20, 1991]

§ 172.440 RADIOACTIVE YELLOW-III label.

(a) Except for size and color, the RADIOACTIVE YELLOW-III label must be as follows:



(b) In addition to complying with § 172.407, the background color on the RADIOACTIVE YELLOW-III label must be yellow in the top half and white in the lower half. The printing

§ 172.441

49 CFR Ch. I (10-1-23 Edition)

and symbol must be black, except for the "III" which must be red.

[Amdt. 172-123, 56 FR 66259, Dec. 20, 1991]

§ 172.441 FISSILE label.

(a) Except for size and color, the FISSILE label must be as follows:

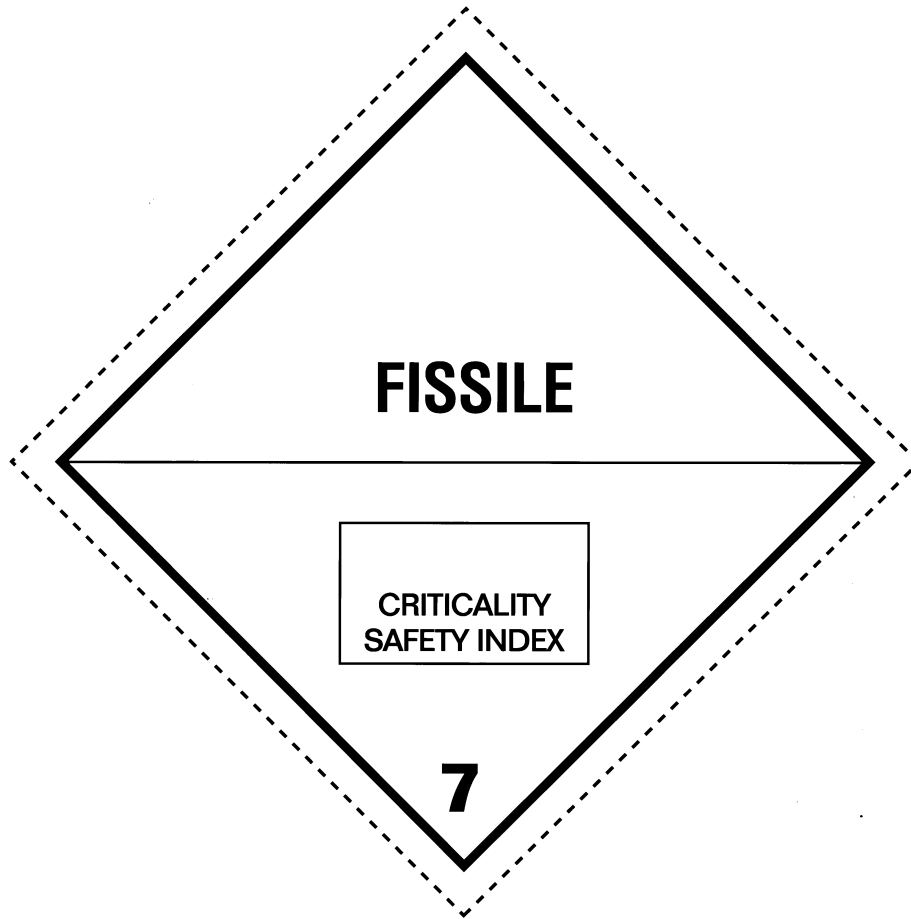

(b) In addition to complying with §172.407, the background color on the FISSILE label must be white.

[69 FR 3669, Jan. 26, 2004]

§ 172.442 CORROSIVE label.

(a) Except for size and color, the CORROSIVE label must be as follows:

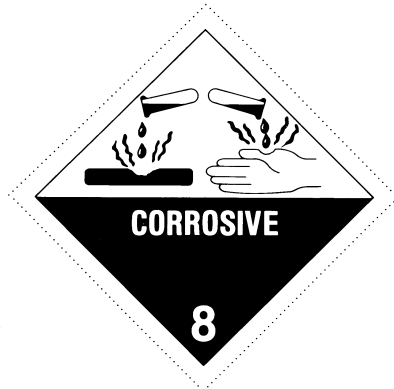

(b) In addition to complying with §172.407, the background on the CORROSIVE label must be white in the top half and black in the lower half.

[Amdt. 172-123, 56 FR 66259, Dec. 20, 1991]

§ 172.444 [Reserved]

§ 172.446 CLASS 9 label.

(a) Except for size and color, the "CLASS 9" (miscellaneous hazardous materials) label must be as follows:



(b) In addition to complying with §172.407, the background on the CLASS 9 label must be white with seven black vertical stripes on the top half. The black vertical stripes must be spaced, so that, visually, they appear equal in width to the six white spaces between them. The lower half of the label must be white with the class number "9" underlined and centered at the bottom.

[Amdt. 172-123, 56 FR 66259, Dec. 20, 1991, as amended at 74 FR 2252, Jan. 14, 2009; 76 FR 43528, July 20, 2011; 76 FR 56314, Sept. 13, 2011; 76 FR 81400, Dec. 28, 2011; 85 FR 83381, Dec. 21, 2020]

§ 172.447 LITHIUM BATTERY label.

(a) Except for size and color, the LITHIUM BATTERY label must be as follows:



(b) In addition to complying with §172.407, the background on the LITHIUM BATTERY label must be white with seven black vertical stripes on the top half. The black vertical stripes must be spaced, so that, visually, they appear equal in width to the six white spaces between them. The lower half of the label must be white with the symbol (battery group, one broken and emitting flame) and class number “9”

underlined and centered at the bottom in black.

[82 FR 15873, Mar. 30, 2017, as amended at 87 FR 44991, July 26, 2022]

§ 172.448 CARGO AIRCRAFT ONLY label.

(a) Except for size and color, the CARGO AIRCRAFT ONLY label must be as follows:



(b) The CARGO AIRCRAFT ONLY label must be black on an orange background.

(c) A CARGO AIRCRAFT ONLY label conforming to the specifications in this section and in §172.407(c)(2) in effect on October 1, 2008, may be used until January 1, 2013.

[74 FR 2252, Jan. 14, 2009, as amended at 75 FR 72, Jan. 4, 2010]

§ 172.450 EMPTY label.

(a) Each EMPTY label, except for size, must be as follows:

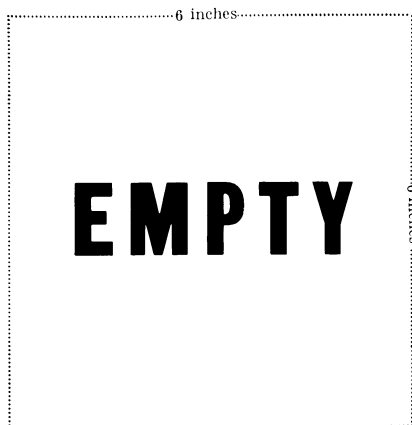

(1) Each side must be at least 6 inches (152 mm.) with each letter at least 1 inch (25.4 mm.) in height.

(2) The label must be white with black printing.

(b) [Reserved]

Subpart F—Placarding

§ 172.500 Applicability of placarding requirements.

(a) Each person who offers for transportation or transports any hazardous material subject to this subchapter shall comply with the applicable placarding requirements of this subpart.

(b) This subpart does not apply to—

(1) Infectious substances;

(2) Hazardous materials authorized by this subchapter to be offered for transportation as a limited quantity when identified as such on a shipping paper in accordance with §172.203(b) or when marked as such in accordance with §172.315.

(3) Hazardous materials prepared in accordance with §173.13 of this subchapter;

(4) Hazardous materials which are packaged as small quantities under the provisions of §§173.4, 173.4a, 173.4b of this subchapter; and

§ 172.502

(5) Combustible liquids in non-bulk packagings.

[Amdt. 172-123, 55 FR 52599, Dec. 21, 1990, as amended by Amdt. 172-149, 61 FR 27173, May 30, 1996; 74 FR 2253, Jan. 14, 2009; 76 FR 3367, Jan. 19, 2011; 87 FR 79773, Dec. 27, 2022]

§ 172.502 Prohibited and permissive placarding.

(a) *Prohibited placarding.* Except as provided in paragraph (b) of this section, no person may affix or display on a packaging, freight container, unit load device, motor vehicle or rail car—

(1) Any placard described in this subpart unless—

(i) The material being offered or transported is a hazardous material;

(ii) The placard represents a hazard of the hazardous material being offered or transported; and

(iii) Any placarding conforms to the requirements of this subpart.

(2) Any sign, advertisement, slogan (such as “Drive Safely”), or device that, by its color, design, shape or content, could be confused with any placard prescribed in this subpart.

(b) *Exceptions.* (1) The restrictions in paragraph (a) of this section do not apply to a bulk packaging, freight container, unit load device, transport vehicle or rail car which is placarded in conformance with TDG Regulations, the IMDG Code or the UN Recommendations (IBR, see §171.7 of this subchapter).

(2) The restrictions of paragraph (a) of this section do not apply to the display of a BIOHAZARD marking, a “HOT” marking, a sour crude oil hazard marking, or an identification number on a white square-on-point configuration in accordance with §172.323(c), §172.325(c), §172.327(a), or §172.336(b) of this part, respectively.

(c) *Permissive placarding.* Placards may be displayed for a hazardous material, even when not required, if the placarding otherwise conforms to the requirements of this subpart.

[Amdt. 172-123, 55 FR 52599, Dec. 21, 1990, as amended at 56 FR 66259, Dec. 20, 1991; Amdt. 172-151, 62 FR 1230, Jan. 8, 1997; 62 FR 39389, 39407, July 22, 1997; 66 FR 8647, Feb. 1, 2001; 66 FR 33426, June 21, 2001; 67 FR 53137, Aug. 14, 2002; 68 FR 75741, Dec. 31, 2003; 76 FR 3367, Jan. 19, 2011; 80 FR 72923, Nov. 23, 2015]

49 CFR Ch. I (10-1-23 Edition)

§ 172.503 Identification number display on placards.

For procedures and limitations pertaining to the display of identification numbers on placards, see §172.334.

[Amdt. 172-58, 45 FR 34701, May 22, 1980]

§ 172.504 General placarding requirements.

(a) *General.* Except as otherwise provided in this subchapter, each bulk packaging, freight container, unit load device, transport vehicle or rail car containing any quantity of a hazardous material must be placarded on each side and each end with the type of placards specified in tables 1 and 2 of this section and in accordance with other placarding requirements of this subpart, including the specifications for the placards named in the tables and described in detail in §§172.519 through 172.560.

(b) *DANGEROUS placard.* A freight container, unit load device, transport vehicle, or rail car which contains non-bulk packages with two or more categories of hazardous materials that require different placards specified in table 2 of paragraph (e) of this section may be placarded with a DANGEROUS placard instead of the separate placarding specified for each of the materials in table 2 of paragraph (e) of this section. However, when 1,000 kg (2,205 pounds) aggregate gross weight or more of one category of material is loaded therein at one loading facility on a freight container, unit load device, transport vehicle, or rail car, the placard specified in table 2 of paragraph (e) of this section for that category must be applied.

(c) *Exception for less than 454 kg (1,001 pounds).* Except for bulk packagings and hazardous materials subject to §172.505, when hazardous materials covered by table 2 of this section are transported by highway or rail, placards are not required on—

(1) A transport vehicle or freight container which contains less than 454 kg (1001 pounds) aggregate gross weight of hazardous materials covered by table 2 of paragraph (e) of this section; or

(2) A rail car loaded with transport vehicles or freight containers, none of which is required to be placarded.

The exceptions provided in paragraph (c) of this section do not prohibit the display of placards in the manner prescribed in this subpart, if not otherwise prohibited (see §172.502), on transport vehicles or freight containers which are not required to be placarded.

(d) *Exception for empty non-bulk packages.* Except for hazardous materials

subject to §172.505, a non-bulk packaging that contains only the residue of a hazardous material covered by Table 2 of paragraph (e) of this section need not be included in determining placarding requirements.

(e) *Placarding tables.* Placards are specified for hazardous materials in accordance with the following tables:

TABLE 1 TO PARAGRAPH (e)

Category of material (Hazard class or division number and additional description, as appropriate)	Placard name	Placard design section reference (§)
1.1	EXPLOSIVES 1.1	172.522
1.2	EXPLOSIVES 1.2	172.522
1.3	EXPLOSIVES 1.3	172.522
2.3	POISON GAS	172.540
4.3	DANGEROUS WHEN WET	172.548
5.2 (Organic peroxide, Type B, liquid or solid, temperature controlled).	ORGANIC PEROXIDE	172.552
6.1 (material poisonous by inhalation (see § 171.8 of this subchapter)).	POISON INHALATION HAZARD	172.555
7 (Radioactive Yellow III label only)	RADIOACTIVE ¹	172.556

¹ RADIOACTIVE placards are also required for: All shipments of unpackaged LSA-I material or SCO-I; all shipments required by §§ 173.427, 173.441, and 173.457 of this subchapter to be operated under exclusive use; and all closed vehicles used in accordance with § 173.443(d).

TABLE 2 TO PARAGRAPH (e)

Category of material (hazard class or division number and additional description, as appropriate)	Placard name	Placard design section reference (§)
1.4	EXPLOSIVES 1.4	172.523
1.5	EXPLOSIVES 1.5	172.524
1.6	EXPLOSIVES 1.6	172.525
2.1	FLAMMABLE GAS	172.532
2.2	NON-FLAMMABLE GAS	172.528
3	FLAMMABLE	172.542
Combustible liquid	COMBUSTIBLE	172.544
4.1	FLAMMABLE SOLID	172.546
4.2	SPONTANEOUSLY COMBUSTIBLE	172.547
5.1	OXIDIZER	172.550
5.2 (Other than organic peroxide, Type B, liquid or solid, temperature controlled).	ORGANIC PEROXIDE	172.552
6.1 (other than material poisonous by inhalation)	POISON	172.554
6.2	NONE.	
8	CORROSIVE	172.558
9	CLASS 9 (see § 172.504(f)(9))	172.560

(f) *Additional placarding exceptions.* (1) When more than one division placard is required for Class 1 materials on a transport vehicle, rail car, freight container or unit load device, only the placard representing the lowest division number must be displayed.

(2) A FLAMMABLE placard may be used in place of a COMBUSTIBLE placard on—

(i) A cargo tank or portable tank.

(ii) A compartmented tank car which contains both flammable and combustible liquids.

(3) A NON-FLAMMABLE GAS placard is not required on a transport vehicle which contains non-flammable gas if the transport vehicle also contains flammable gas or oxygen and it is placarded with FLAMMABLE GAS or OXYGEN placards, as required.

(4) OXIDIZER placards are not required for Division 5.1 materials on

freight containers, unit load devices, transport vehicles or rail cars which also contain Division 1.1 or 1.2 materials and which are placarded with EXPLOSIVES 1.1 or 1.2 placards, as required.

(5) For transportation by transport vehicle or rail car only, an OXIDIZER placard is not required for Division 5.1 materials on a transport vehicle, rail car or freight container which also contains Division 1.5 explosives and is placarded with EXPLOSIVES 1.5 placards, as required.

(6) The EXPLOSIVE 1.4 placard is not required for those Division 1.4 Compatibility Group S (1.4S) materials that are not required to be labeled 1.4S.

(7) For domestic transportation of oxygen, compressed or oxygen, refrigerated liquid, the OXYGEN placard in §172.530 of this subpart may be used in place of a NON-FLAMMABLE GAS placard.

(8) For domestic transportation, a POISON INHALATION HAZARD placard is not required on a transport vehicle or freight container that is already placarded with the POISON GAS placard.

(9) For Class 9, a CLASS 9 placard is not required for domestic transportation, including that portion of international transportation, defined in §171.8 of this subchapter, which occurs within the United States. However, a bulk packaging must be marked with the appropriate identification number on a CLASS 9 placard, an orange panel, or a white square-on-point display configuration as required by subpart D of this part.

(10) For Division 6.1, PG III materials, a POISON placard may be modified to display the text “PG III” below the mid line of the placard.

(11) For domestic transportation, a POISON placard is not required on a transport vehicle or freight container required to display a POISON INHALATION HAZARD or POISON GAS placard.

(g) For shipments of Class 1 (explosive materials) by aircraft or vessel, the applicable compatibility group letter must be displayed on the placards, or labels when applicable, required by this section. When more than one compatibility group placard is required for

Class 1 materials, only one placard is required to be displayed, as provided in paragraphs (g)(1) through (g)(4) of this section. For the purposes of paragraphs (g)(1) through (g)(4), there is a distinction between the phrases *explosive articles* and *explosive substances*. *Explosive article* means an article containing an explosive substance; examples include a detonator, flare, primer or fuse. *Explosive substance* means a substance contained in a packaging that is not contained in an article; examples include black powder and smokeless powder.

(1) Explosive articles of compatibility groups C, D or E may be placarded displaying compatibility group E.

(2) Explosive articles of compatibility groups C, D, or E, when transported with those in compatibility group N, may be placarded displaying compatibility group D.

(3) Explosive substances of compatibility groups C and D may be placarded displaying compatibility group D.

(4) Explosive articles of compatibility groups C, D, E or G, except for fireworks, may be placarded displaying compatibility group E.

[Amdt. 172–123, 55 FR 52600, Dec. 21, 1990]

EDITORIAL NOTE: For FEDERAL REGISTER citations affecting §172.504, see the List of CFR Sections Affected, which appears in the Finding Aids section of the printed volume and at www.govinfo.gov.

§ 172.505 Placarding for subsidiary hazards.

(a) Each transport vehicle, freight container, portable tank, unit load device, or rail car that contains a poisonous material subject to the “Poison Inhalation Hazard” shipping description of §172.203(m) must be placarded with a POISON INHALATION HAZARD or POISON GAS placard, as appropriate, on each side and each end, in addition to any other placard required for that material in §172.504. Duplication of the POISON INHALATION HAZARD or POISON GAS placard is not required.

(b) In addition to the RADIOACTIVE placard which may be required by §172.504(e), each transport vehicle, portable tank or freight container that

contains 454 kg (1,001 pounds) or more gross weight of non-fissile, fissile-excepted, or fissile uranium hexafluoride must be placarded with a CORROSIVE placard and a POISON placard on each side and each end.

(c) Each transport vehicle, portable tank, freight container or unit load device that contains a material which has a subsidiary hazard of being dangerous when wet, as defined in §173.124 of this subchapter, shall be placarded with DANGEROUS WHEN WET placards, on each side and each end, in addition to the placards required by §172.504.

(d) Hazardous materials that possess secondary hazards may exhibit subsidiary placards that correspond to the placards described in this part, even when not required by this part (see also §172.519(b) (4) of this subpart).

[Amdt. 172-123, 55 FR 52601, Dec. 21, 1990, as amended at 56 FR 66260, Dec. 20, 1991; 57 FR 45460, Oct. 1, 1992; Amdt. 172-127, 59 FR 49133, Sept. 26, 1994; Amdt. 172-151, 62 FR 1231, Jan. 8, 1997; 62 FR 39398, July 22, 1997; 65 FR 58626, Sept. 29, 2000; 72 FR 55692, Oct. 1, 2007; 79 FR 40610, July 11, 2014; 82 FR 15874, Mar. 30, 2017]

§ 172.506 Providing and affixing placards: Highway.

(a) Each person offering a motor carrier a hazardous material for transportation by highway shall provide to the motor carrier the required placards for the material being offered prior to or at the same time the material is offered for transportation, unless the carrier's motor vehicle is already placarded for the material as required by this subpart.

(1) No motor carrier may transport a hazardous material in a motor vehicle, unless the placards required for the hazardous material are affixed thereto as required by this subpart.

(2) [Reserved]

(b) [Reserved]

[Amdt. 172-29, 41 FR 15996, Apr. 15, 1976, as amended by Amdt. 172-29A, 41 FR 40679, Sept. 20, 1976]

§ 172.507 Special placarding provisions: Highway.

(a) Each motor vehicle used to transport a package of highway route controlled quantity Class 7 (radioactive) materials (see §173.403 of this sub-

chapter) must have the required RADIOACTIVE warning placard placed on a square background as described in §172.527.

(b) A nurse tank, meeting the provisions of §173.315(m) of this subchapter, is not required to be placarded on an end containing valves, fittings, regulators or gauges when those appurtenances prevent the markings and placard from being properly placed and visible.

[Amdt. 172-103, 51 FR 5971, Feb. 18, 1986, as amended by Amdt. 172-143, 60 FR 50305, Sept. 28, 1995]

§ 172.508 Placarding and affixing placards: Rail.

(a) Each person offering a hazardous material for transportation by rail shall affix to the rail car containing the material, the placards specified by this subpart. Placards displayed on motor vehicles, transport containers, or portable tanks may be used to satisfy this requirement, if the placards otherwise conform to the provisions of this subpart.

(b) No rail carrier may accept a rail car containing a hazardous material for transportation unless the placards for the hazardous material are affixed thereto as required by this subpart.

[Amdt. 172-29, 41 FR 15996, Apr. 15, 1976, as amended by Amdt. 172-123, 55 FR 52601, Dec. 21, 1990]

§ 172.510 Special placarding provisions: Rail.

(a) *White square background.* The following must have the specified placards placed on a white square background, as described in §172.527:

(1) Division 1.1 and 1.2 (explosive) materials which require EXPLOSIVES 1.1 or EXPLOSIVES 1.2 placards affixed to the rail car;

(2) Materials classed in Division 2.3 Hazard Zone A or 6.1 Packing Group I Hazard Zone A which require POISON GAS or POISON placards affixed to the rail car, including tank cars containing only a residue of the material; and

(3) Class DOT 113 tank cars used to transport a Division 2.1 (flammable gas) material, including tank cars containing only a residue of the material.

§ 172.512

49 CFR Ch. I (10–1–23 Edition)

(b) *Chemical ammunition.* Each rail car containing Division 1.1 or 1.2 (explosive) ammunition which also meets the definition of a material poisonous by inhalation (see §171.8 of this subchapter) must be placarded EXPLOSIVES 1.1 or EXPLOSIVES 1.2 and POISON GAS or POISON INHALATION HAZARD.

[Amdt. 172–29, 41 FR 15996, Apr. 15, 1976, as amended by Amdt. 172–103, 51 FR 5971, Feb. 18, 1986; Amdt. 172–110, 52 FR 29528, Aug. 10, 1987; Amdt. 172–111, 52 FR 36671, Sept. 30, 1987; Amdt. 172–123, 55 FR 52601, Dec. 21, 1990; 56 FR 66260, Dec. 20, 1991; 57 FR 45460, Oct. 1, 1992; Amdt. 172–248, 61 FR 28676, June 5, 1996; Amdt. 172–151, 62 FR 1231, Jan. 8, 1997; 62 FR 39398, July 22, 1997]

§ 172.512 Freight containers and aircraft unit load devices.

(a) *Capacity of 640 cubic feet or more.* Each person who offers for transportation, and each person who loads and transports, a hazardous material in a freight container or aircraft unit load device having a capacity of 640 cubic feet or more shall affix to the freight container or aircraft unit load device the placards specified for the material in accordance with §172.504. However:

(1) The placarding exception provided in §172.504(c) applies to motor vehicles transporting freight containers and aircraft unit load devices,

(2) The placarding exception provided in §172.504(c) applies to each freight container and aircraft unit load device being transported for delivery to a consignee immediately following an air or water shipment, and,

(3) Placarding is not required on a freight container or aircraft unit load device if it is only transported by air and is identified as containing a hazardous material in the manner provided in part 7, chapter 2, section 2.8, of the ICAO Technical Instructions (IBR, see §171.7 of this subchapter).

(b) *Capacity less than 18 m³ (640 cubic feet).* (1) Each person who offers for transportation by air, and each person who loads and transports by air, a hazardous material in a freight container or aircraft unit load device having a capacity of less than 18 m³ (640 cubic feet) shall affix one placard of the type specified by paragraph (a) of this section unless the freight container or aircraft unit load device:

(i) Is labeled in accordance with subpart E of this part, including §172.406(e);

(ii) Contains radioactive materials requiring the Radioactive Yellow III label and is placarded with one Radioactive placard and is labeled in accordance with subpart E of this part, including §172.406(e); or,

(iii) Is identified as containing a hazardous material in the manner provided in part 7; chapter 2, section 2.8, of the ICAO Technical Instructions (IBR, see §171.7 of this subchapter).

(2) When hazardous materials are offered for transportation, not involving air transportation, in a freight container having a capacity of less than 640 cubic feet the freight container need not be placarded. However, if not placarded, it must be labeled in accordance with subpart E of this part.

(c) Notwithstanding paragraphs (a) and (b) of this section, packages containing hazardous materials offered for transportation by air in freight containers are subject to the inspection requirements of §175.30 of this chapter.

[Amdt. 172–29, 41 FR 15996, Apr. 15, 1976]

EDITORIAL NOTE: For FEDERAL REGISTER citations affecting §172.513, see the List of CFR Sections Affected, which appears in the Finding Aids section of the printed volume and at www.govinfo.gov.

§ 172.514 Bulk packagings.

(a) Except as provided in paragraphs (c) and (d) of this section, each person who offers for transportation a bulk packaging which contains a hazardous material, shall affix the placards specified for the material in §§172.504 and 172.505.

(b) Each bulk packaging that is required to be placarded when it contains a hazardous material, must remain placarded when it is emptied, unless it—

(1) Is sufficiently cleaned of residue and purged of vapors to remove any potential hazard;

(2) Is refilled, with a material requiring different placards or no placards, to such an extent that any residue remaining in the packaging is no longer hazardous; or

(3) Contains the residue of a hazardous substance in Class 9 in a quantity less than the reportable quantity,

and conforms to §173.29(b)(1) of this subchapter.

(c) *Exceptions.* The following packagings may be placarded on only two opposite sides or, alternatively, may be labeled instead of placarded in accordance with subpart E of this part:

(1) A portable tank having a capacity of less than 3,785 L (1000 gallons);

(2) A DOT 106 or 110 multi-unit tank car tank;

(3) A bulk packaging other than a portable tank, cargo tank, flexible bulk container, or tank car (*e.g.*, a bulk bag or box) with a volumetric capacity of less than 18 cubic meters (640 cubic feet);

(4) *An IBC.* For an IBC labeled in accordance with subpart E of this part, the IBC may display the proper shipping name and UN identification number markings in accordance with §172.301(a)(1) in place of the UN number on an orange panel, placard or white square-on-point configuration as prescribed in §172.336(d); and

(5) A Large Packaging as defined in §171.8 of this subchapter.

(d) A flexible bulk container may be placarded in two opposing positions.

[Amdt. 172-136, 59 FR 38064, July 26, 1994; Amdt. 172-148, 61 FR 50255, Sept. 25, 1996, as amended by 66 FR 45379, Aug. 28, 2001; 69 FR 64473, Nov. 4, 2004; 75 FR 5392, Feb. 2, 2010; 76 FR 43528, July 20, 2011; 77 FR 60942, Oct. 5, 2012; 81 FR 35540, June 2, 2016; 85 FR 27878, May 11, 2020]

§ 172.516 Visibility and display of placards.

(a) Each placard on a motor vehicle and each placard on a rail car must be clearly visible from the direction it faces, except from the direction of another transport vehicle or rail car to which the motor vehicle or rail car is coupled. This requirement may be met by the placards displayed on the freight containers or portable tanks loaded on a motor vehicle or rail car.

(b) The required placarding of the front of a motor vehicle may be on the front of a truck-tractor instead of or in addition to the placarding on the front of the cargo body to which a truck-tractor is attached.

(c) Each placard on a transport vehicle, bulk packaging, freight container or aircraft unit load device must—

(1) Be securely attached or affixed thereto or placed in a holder thereon. (See appendix C to this part.);

(2) Be located clear of appurtenances and devices such as ladders, pipes, doors, and tarpaulins;

(3) So far as practicable, be located so that dirt or water is not directed to it from the wheels of the transport vehicle;

(4) Be located away from any marking (such as advertising) that could substantially reduce its effectiveness, and in any case at least 3 inches (76.0 mm.) away from such marking;

(5) Have the words or identification number (when authorized) printed on it displayed horizontally, reading from left to right;

(6) Be maintained by the carrier in a condition so that the format, legibility, color, and visibility of the placard will not be substantially reduced due to damage, deterioration, or obscurement by dirt or other matter;

(7) Be affixed to a background of contrasting color, or must have a dotted or solid line outer border which contrasts with the background color.

(d) Recommended specifications for a placard holder are set forth in appendix C of this part. Except for a placard holder similar to that contained in appendix C to this part, the means used to attach a placard may not obscure any part of its surface other than the borders.

(e) A placard or placard holder may be hinged provided the required format, color, and legibility of the placard are maintained.

[Amdt. 172-29, 41 FR 15996, Apr. 15, 1976, as amended by Amdt. 172-101, 45 FR 74668, Nov. 10, 1980; Amdt. 172-123, 55 FR 52601, Dec. 21, 1990; 65 FR 50460, Aug. 18, 2000]

§ 172.519 General specifications for placards.

(a) *Strength and durability.* Placards must conform to the following:

(1) A placard may be made of any plastic, metal or other material capable of withstanding, without deterioration or a substantial reduction in effectiveness, a 30-day exposure to open weather conditions.

(2) A placard made of tagboard must be at least equal to that designated

§ 172.519

49 CFR Ch. I (10–1–23 Edition)

commercially as white tagboard. Tagboard must have a weight of at least 80 kg (176 pounds) per ream of 610 by 910 mm (24 by 36-inch) sheets, waterproofing materials included. In addition, each placard made of tagboard must be able to pass a 414 kPa (60 p.s.i.) Mullen test.

(3) Reflective or retroreflective materials may be used on a placard if the prescribed colors, strength and durability are maintained.

(b) *Design.* (1) Except as provided in §172.332 of this part, each placard must be as described in this subpart, and except for size and color, the printing, inner border and symbol must be as shown in §§172.521 through 172.560 of this subpart, as appropriate.

(2) The dotted line border shown on each placard is not part of the placard specification. However, a dotted or solid line outer border may be used when needed to indicate the full size of a placard that is part of a larger format or is on a background of a non-contrasting color.

(3) For other than Class 7 or the DANGEROUS placard, text indicating a hazard (for example, “FLAMMABLE”) is not required. Text may be omitted from the OXYGEN placard only if the specific identification number is displayed on the placard.

(4) For a placard corresponding to the primary or subsidiary hazard class of a material, the hazard class or division number must be displayed in the lower corner of the placard. However, a permanently affixed subsidiary placard meeting the specifications of this section which were in effect on October 1, 2001, (such as, a placard without the hazard class or division number displayed in the lower corner of the placard) and which was installed prior to September 30, 2001, may continue to be used as a subsidiary placard in domestic transportation by rail or highway, provided the color tolerances are maintained and are in accordance with the display requirements in this subchapter.

(c) *Size.* (1) Each diamond (square-on-point) placard prescribed in this subpart must measure at least 250 mm (9.84 inches) on each side and must have a solid line inner border approximately 12.5 mm inside and parallel to

the edge. The 12.5 mm measurement is from the outside edge of the placard to the outside of the solid line forming the inner border. For domestic transportation, a placard manufactured prior to January 1, 2017, in conformance with the requirements of this paragraph in effect on December 31, 2014, may continue in service until the end of its useful life provided the color tolerances are maintained and are in accordance with the display requirements of this subchapter.

(2) Except as otherwise provided in this subpart, the hazard class or division number, as appropriate, must be shown in numerals measuring at least 41 mm (1.6 inches) in height.

(3) Except as otherwise provided in this subpart, when text indicating a hazard is displayed on a placard, the printing must be in letters measuring at least 41 mm (1.6 inches) in height.

(d) *Color.* (1) The background color, symbol, text, numerals and inner border on a placard must be as specified in §§172.521 through 172.560 of this subpart, as appropriate.

(2) Black and any color on a placard must be able to withstand, without substantial change—

(i) A 72-hour fadeometer test (for a description of equipment designed for this purpose, see ASTM G 23–69 or ASTM G 26–70); and

(ii) A 30-day exposure to open weather.

(3) Upon visual examination, a color on a placard must fall within the color tolerances displayed on the appropriate Hazardous Materials Label and Placard Color Tolerance Chart (see §172.407(d)(4)). As an alternative, the PANTONE® formula guide coated/uncoated as specified for colors in §172.407(d)(5) may be used.

(4) The placard color must extend to the inner border and may extend to the edge of the placard in the area designated on each placard except the color on the CORROSIVE and RADIOACTIVE placards (black and yellow, respectively) must extend only to the inner border.

(e) *Form identification.* A placard may contain form identification information, including the name of its maker, provided that information is printed

outside of the solid line inner border in no larger than 10-point type.

(f) *Exceptions.* When hazardous materials are offered for transportation or transported under the provisions of subpart C of part 171 of this subchapter, a placard conforming to the specifications in the UN Recommendations, the ICAO Technical Instructions, the IMDG Code, or the Transport Canada TDG Regulations (IBR, see §171.7 of this subchapter) may be used in place of a corresponding placard conforming to the requirements of this subpart. However, a bulk packaging, transport vehicle, or freight container containing a material poisonous by inhalation (see §171.8 of this subchapter) must be placarded in accordance with this subpart (see §171.23(b)(10) of this subchapter).

(g) *Trefoil symbol.* The trefoil symbol on the RADIOACTIVE placard must meet the appropriate specification in appendix B of this part.

[Amdt. 172-123, 55 FR 52601, Dec. 21, 1990, as amended at 56 FR 66260, Dec. 20, 1991; 57 FR 45460, Oct. 1, 1992; Amdt. 172-143, 60 FR 50305, Sept. 28, 1995; 65 FR 50460, Aug. 18, 2000; 66 FR 33426, June 21, 2001; 66 FR 44255, Aug. 22, 2001; 67 FR 15743, Apr. 3, 2002; 70 FR 34075, June 13, 2005; 69 FR 64473, Nov. 4, 2004; 72 FR 25176, May 3, 2007; 76 FR 43528, July 20, 2011; 76 FR 56314, Sept. 13, 2011; 80 FR 1151, Jan. 8, 2015; 83 FR 55807, Nov. 7, 2018; 87 FR 79774, Dec. 27, 2022]

§ 172.521 DANGEROUS placard.

(a) Except for size and color, the DANGEROUS placard must be as follows:



(b) In addition to meeting the requirements of §172.519, and appendix B to this part, the DANGEROUS placard must have a red upper and lower triangle. The placard center area and ½-inch (12.7 mm.) border must be white. The inscription must be black with the ½-inch (3.2 mm.) border marker in the white area at each end of the inscription red.

[Amdt. 172-29, 41 FR 15996, Apr. 15, 1976, as amended by Amdt. 172-29A, 41 FR 40630, Sept. 20, 1976]

§ 172.522 EXPLOSIVES 1.1, EXPLOSIVES 1.2 and EXPLOSIVES 1.3 placards.

(a) Except for size and color, the EXPLOSIVES 1.1, EXPLOSIVES 1.2 and EXPLOSIVES 1.3 placards must be as follows:



(b) In addition to complying with §172.519 of this subpart, the background color on the EXPLOSIVES 1.1, EXPLOSIVES 1.2, and EXPLOSIVES 1.3 placards must be orange. The “*” shall be replaced with the appropriate division number and, when required, appropriate compatibility group letter. The symbol, text, numerals and inner border must be black.

[Amdt. 172-123, 55 FR 52602, Dec. 21, 1990, as amended at 56 FR 66260, Dec. 20, 1991]

§ 172.523 EXPLOSIVES 1.4 placard.

(a) Except for size and color, the EXPLOSIVES 1.4 placard must be as follows:

§ 172.524

49 CFR Ch. I (10–1–23 Edition)



(b) In addition to complying with § 172.519 of this subpart, the background color on the EXPLOSIVES 1.4 placard must be orange. The “*” shall be replaced, when required, with the appropriate compatibility group letter. The division numeral, 1.4, must measure at least 64 mm (2.5 inches) in height. The text, numerals and inner border must be black.

[Amdt. 172–123, 55 FR 52602, Dec. 21, 1990, as amended at 56 FR 66261, Dec. 20, 1991]

§ 172.524 EXPLOSIVES 1.5 placard.

(a) Except for size and color, the EXPLOSIVES 1.5 placard must be as follows:



(b) In addition to complying with the § 172.519 of this subpart, the background color on EXPLOSIVES 1.5 placard

must be orange. The “*” shall be replaced, when required, with the appropriate compatibility group letter. The division numeral, 1.5, must measure at least 64 mm (2.5 inches) in height. The text, numerals and inner border must be black.

[Amdt. 172–123, 55 FR 52602, Dec. 21, 1990, as amended at 56 FR 66261, Dec. 20, 1991]

§ 172.525 EXPLOSIVES 1.6 placard.

(a) Except for size and color the EXPLOSIVES 1.6 placard must be as follows:



(b) In addition to complying with § 172.519 of this subpart, the background color on the EXPLOSIVES 1.6 placard must be orange. The “*” shall be replaced, when required, with the appropriate compatibility group letter. The division numeral, 1.6, must measure at least 64 mm (2.5 inches) in height. The text, numerals and inner border must be black.

[Amdt. 172–123, 55 FR 52603, Dec. 21, 1990, as amended at 56 FR 66261, Dec. 20, 1991; Amdt. 172–130, 58 FR 51531, Oct. 1, 1993]

§ 172.526 [Reserved]

§ 172.527 Background requirements for certain placards.

(a) Except for size and color, the square background required by § 172.510(a) for certain placards on rail cars, and § 172.507 for placards on motor vehicles containing a package of highway route controlled quantity radioactive materials, must be as follows:

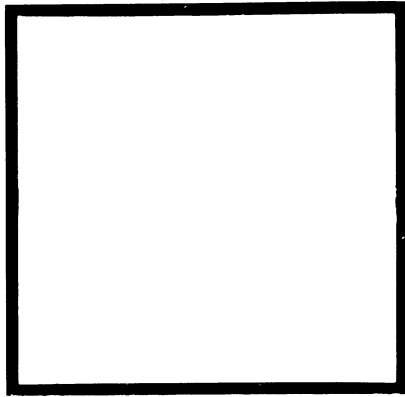

(b) In addition to meeting the requirements of §172.519 for minimum durability and strength, the square background must consist of a white square measuring 14¼ inches (362.0 mm.) on each side surrounded by a black border extending to 15¼ inches (387.0 mm.) on each side.

[Amdt. 172-29, 41 FR 15996, Apr. 15, 1976, as amended by Amdt. 172-64, 46 FR 5316, Jan. 19, 1981; Amdt. 172-78, 48 FR 10226, Mar. 10, 1983]

§ 172.528 NON-FLAMMABLE GAS placard.

(a) Except for size and color, the NON-FLAMMABLE GAS placard must be as follows:



(b) In addition to complying with §172.519, the background color on the NON-FLAMMABLE GAS placard must be green. The letters in both words must be at least 38 mm (1.5 inches)

high. The symbol, text, class number and inner border must be white.

[Amdt. 172-123, 56 FR 66261, Dec. 20, 1991]

§ 172.530 OXYGEN placard.

(a) Except for size and color, the OXYGEN placard must be as follows:



(b) In addition to complying with §172.519 of this subpart, the background color on the OXYGEN placard must be yellow. The symbol, text, class number and inner border must be black.

[Amdt. 172-123, 56 FR 66262, Dec. 20, 1991]

§ 172.532 FLAMMABLE GAS placard.

(a) Except for size and color, the FLAMMABLE GAS placard must be as follows:



(b) In addition to complying with §172.519, the background color on the

§ 172.536

FLAMMABLE GAS placard must be red. The symbol, text, class number and inner border must be white.

[Amdt. 172-123, 56 FR 66262, Dec. 20, 1991]

§ 172.536 [Reserved]

§ 172.540 POISON GAS placard.

(a) Except for size and color, the POISON GAS placard must be as follows:



(b) In addition to complying with §172.519, the background on the POISON GAS placard and the symbol must be white. The background of the upper diamond must be black and the lower point of the upper diamond must be 65 mm (2½ inches) above the horizontal center line. The text, class number, and inner border must be black.

[62 FR 39408, July 22, 1997]

§ 172.542 FLAMMABLE placard.

(a) Except for size and color, the FLAMMABLE placard must be as follows:

49 CFR Ch. I (10-1-23 Edition)



(b) In addition to complying with §172.519, the background color on the FLAMMABLE placard must be red. The symbol, text, class number and inner border must be white.

(c) The word "GASOLINE" may be used in place of the word "FLAMMABLE" on a placard that is displayed on a cargo tank or a portable tank being used to transport gasoline by highway. The word "GASOLINE" must be shown in white.

[Amdt. 172-123, 56 FR 66262, Dec. 20, 1991]

§ 172.544 COMBUSTIBLE placard.

(a) Except for size and color, the COMBUSTIBLE placard must be as follows:



(b) In addition to complying with §172.519, the background color on the COMBUSTIBLE placard must be red.

The symbol, text, class number and inner border must be white. On a COMBUSTIBLE placard with a white bottom as prescribed by §172.332(c)(4), the class number must be red or black.

(c) The words "FUEL OIL" may be used in place of the word "COMBUSTIBLE" on a placard that is displayed on a cargo tank or portable tank being used to transport by highway fuel oil that is not classed as a flammable liquid. The words "FUEL OIL" must be white.

[Amdt. 172-123, 56 FR 66262, Dec. 20, 1991]

§ 172.546 FLAMMABLE SOLID placard.

(a) Except for size and color, the FLAMMABLE SOLID placard must be as follows:



(b) In addition to complying with §172.519, the background on the FLAMMABLE SOLID placard must be white with seven vertical red stripes. The stripes must be equally spaced, with one red stripe placed in the center of the label. Each red stripe and each white space between two red stripes must be 25 mm (1.0 inches) wide. The letters in the word "SOLID" must be at least 38.1 mm (1.5 inches) high. The symbol, text, class number and inner border must be black.

[Amdt. 172-123, 56 FR 66263, Dec. 20, 1991]

§ 172.547 SPONTANEOUSLY COMBUSTIBLE placard.

(a) Except for size and color, the SPONTANEOUSLY COMBUSTIBLE placard must be as follows:



(b) In addition to complying with §172.519, the background color on the SPONTANEOUSLY COMBUSTIBLE placard must be red in the lower half and white in upper half. The letters in the word "SPONTANEOUSLY" must be at least 12 mm (0.5 inch) high. The symbol, text, class number and inner border must be black.

[Amdt. 172-123, 56 FR 66263, Dec. 20, 1991, as amended by Amdt. 172-139, 59 FR 67490, Dec. 29, 1994]

§ 172.548 DANGEROUS WHEN WET placard.

(a) Except for size and color, the DANGEROUS WHEN WET placard must be as follows:



(b) In addition to complying with §172.519, the background color on the DANGEROUS WHEN WET placard must be blue. The letters in the words

§ 172.550

“WHEN WET” must be at least 25 mm (1.0 inches) high. The symbol, text, class number and inner border must be white.

[Amdt. 172-123, 56 FR 66263, Dec. 20, 1991]

§ 172.550 OXIDIZER placard.

(a) Except for size and color, the OXIDIZER placard must be as follows:



49 CFR Ch. I (10-1-23 Edition)

(b) In addition to complying with §172.519, the background color on the OXIDIZER placard must be yellow. The symbol, text, division number and inner border must be black.

[Amdt. 172-123, 56 FR 66263, Dec. 20, 1991]

§ 172.552 ORGANIC PEROXIDE placard.

(a) Except for size and color, the ORGANIC PEROXIDE placard must be as follows:

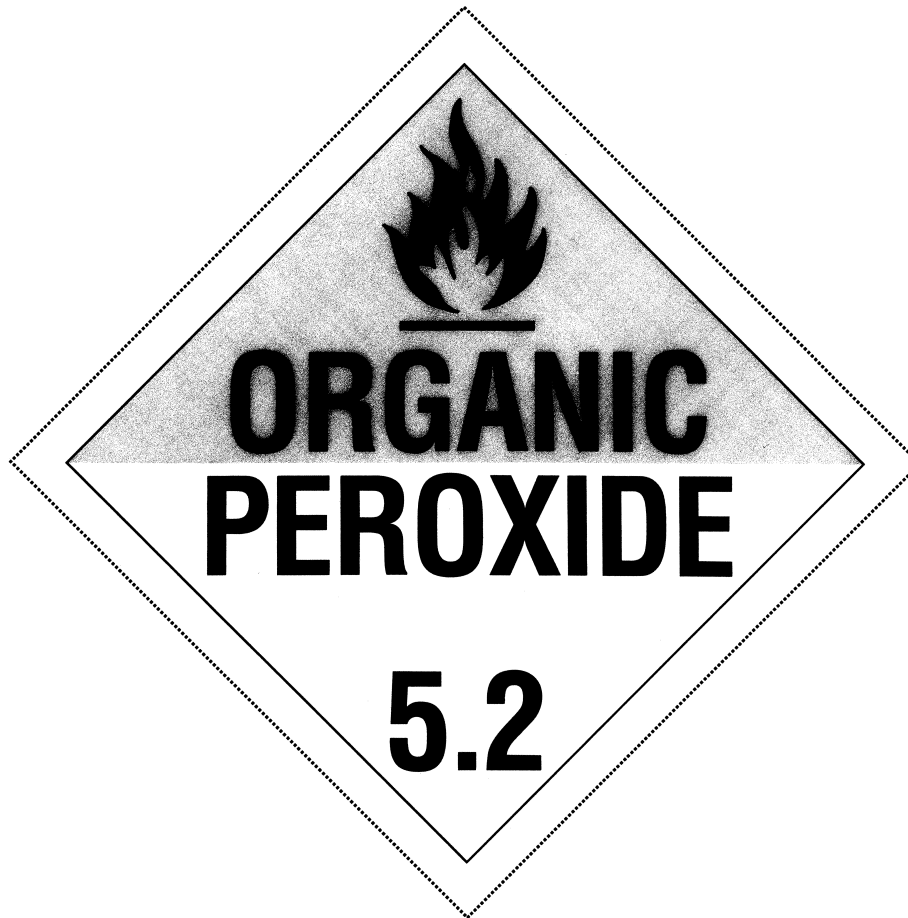

(b) In addition to complying with §172.519, the background on the ORGANIC PEROXIDE placard must be red in the top half and yellow in the lower half. The text, division number and inner border must be black; the symbol may be either black or white.

(c) For transportation by highway, a Division 5.2 placard conforming to the specifications in this section in effect

on December 31, 2006 may continue to be used until January 1, 2014.

[71 FR 78628, Dec. 29, 2006, as amended at 76 FR 43528, July 20, 2011]

§ 172.553 [Reserved]

§ 172.554 POISON placard.

(a) Except for size and color, the POISON placard must be as follows:



(b) In addition to complying with §172.519, the background on the POISON placard must be white. The symbol, text, class number and inner border must be black. The word “TOXIC” may be used in lieu of the word “POISON”.

[Amdt. 172-123, 56 FR 66264, Dec. 20, 1991, as amended by Amdt. 172-139, 59 FR 67490, Dec. 29, 1994]

§ 172.555 POISON INHALATION HAZARD placard.

(a) Except for size and color, the POISON INHALATION HAZARD placard must be as follows:



(b) In addition to complying with §172.519, the background on the POISON INHALATION HAZARD placard and the symbol must be white. The background of the upper diamond must be black and the lower point of the upper diamond must be 65 mm (2½ inches) above the horizontal center line. The text, class number, and inner border must be black.

[62 FR 39409, July 22, 1997]

§ 172.556 RADIOACTIVE placard.

(a) Except for size and color, the RADIOACTIVE placard must be as follows:



(b) In addition to complying with §172.519, the background color on the RADIOACTIVE placard must be white in the lower portion with a yellow triangle in the upper portion. The base of the yellow triangle must be 29 mm ±5 mm (1.1 inches ±0.2 inches) above the placard horizontal center line. The

symbol, text, class number and inner border must be black.

[Amdt. 172-123, 56 FR 66264, Dec. 20, 1991; Amdt. 172-130, 58 FR 51531, Oct. 1, 1993; 65 FR 58627, Sept. 29, 2000]

§ 172.558 CORROSIVE placard.

(a) Except for size and color, the CORROSIVE placard must be as follows:



(b) In addition to complying with §172.519, the background color on the CORROSIVE placard must be black in the lower portion with a white triangle in the upper portion. The base of the white triangle must be 38 mm ±5 mm (1.5 inches ±0.2 inches) above the placard horizontal center line. The text and class number must be white. The symbol and inner border must be black.

[Amdt. 172-123, 56 FR 66264, Dec. 20, 1991, as amended at 65 FR 58627, Sept. 29, 2000]

§ 172.560 CLASS 9 placard.

(a) Except for size and color the CLASS 9 (miscellaneous hazardous materials) placard must be as follows:

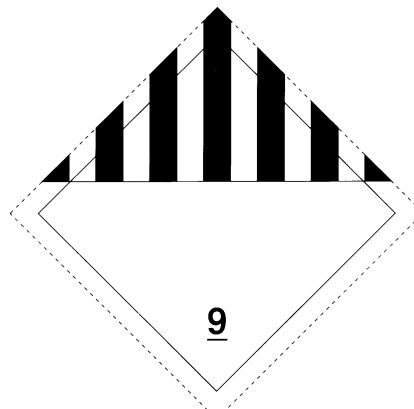

(b) In addition to conformance with § 172.519, the background on the CLASS 9 placard must be white with seven black vertical stripes on the top half extending from the top of the placard to one inch above the horizontal centerline. The black vertical stripes must be spaced so that, visually, they appear equal in width to the six white spaces between them. The space below the vertical lines must be white with the class number 9 underlined and centered at the bottom.

[Amdt. 172-123, 56 FR 66264, Dec. 20, 1991, as amended at 57 FR 45460, Oct. 1, 1992]

Subpart G—Emergency Response Information

§ 172.600 Applicability and general requirements.

(a) *Scope.* Except as provided in paragraph (d) of this section, this subpart prescribes requirements for providing and maintaining emergency response information during transportation and at facilities where hazardous materials are loaded for transportation, stored incidental to transportation or otherwise handled during any phase of transportation.

(b) *Applicability.* This subpart applies to persons who offer for transportation, accept for transportation, transfer or otherwise handle hazardous materials during transportation.

(c) *General requirements.* No person to whom this subpart applies may offer for transportation, accept for transportation, transfer, store or otherwise handle during transportation a hazardous material unless:

(1) Emergency response information conforming to this subpart is immediately available for use at all times the hazardous material is present; and

(2) Emergency response information, including the emergency response telephone number, required by this subpart is immediately available to any person who, as a representative of a Federal, State or local government agency, responds to an incident involving a hazardous material, or is conducting an investigation which involves a hazardous material.

(d) *Exceptions.* The requirements of this subpart do not apply to hazardous material which is excepted from the

shipping paper requirements of this subchapter.

[Amdt. 172-116, 54 FR 27145, June 27, 1989; 54 FR 28750, July 5, 1989, as amended at 55 FR 33712, Aug. 17, 1990; Amdt. 172-127, 59 FR 49133, Sept. 26, 1994; Amdt. 172-149, 61 FR 27173, May 30, 1996; 87 FR 79774, Dec. 27, 2022]

§ 172.602 Emergency response information.

(a) *Information required.* For purposes of this subpart, the term “emergency response information” means information that can be used in the mitigation of an incident involving hazardous materials and, as a minimum, must contain the following information:

(1) The basic description and technical name of the hazardous material as required by §§ 172.202 and 172.203(k), the ICAO Technical Instructions, the IMDG Code, or the TDG Regulations, as appropriate (IBR, see § 171.7 of this subchapter);

(2) Immediate hazards to health;

(3) Risks of fire or explosion;

(4) Immediate precautions to be taken in the event of an accident or incident;

(5) Immediate methods for handling fires;

(6) Initial methods for handling spills or leaks in the absence of fire; and

(7) Preliminary first aid measures.

(b) *Form of information.* The information required for a hazardous material by paragraph (a) of this section must be:

(1) Printed legibly in English;

(2) Available for use away from the package containing the hazardous material; and

(3) Presented—

(i) On a shipping paper;

(ii) In a document, other than a shipping paper, that includes both the basic description and technical name of the hazardous material as required by §§ 172.202 and 172.203(k), the ICAO Technical Instructions, the IMDG Code, or the TDG Regulations, as appropriate, and the emergency response information required by this subpart (e.g., a material safety data sheet); or

(iii) Related to the information on a shipping paper, a written notification to pilot-in-command, or a dangerous cargo manifest, in a separate document (e.g., an emergency response guidance

document), in a manner that cross-references the description of the hazardous material on the shipping paper with the emergency response information contained in the document. Aboard aircraft, the ICAO “Emergency Response Guidance for Aircraft Incidents Involving Dangerous Goods” and, aboard vessels, the IMO “Emergency Procedures for Ships Carrying Dangerous Goods”, or equivalent documents, may be used to satisfy the requirements of this section for a separate document.

(c) *Maintenance of information.* Emergency response information shall be maintained as follows:

(1) *Carriers.* Each carrier who transports a hazardous material shall maintain the information specified in paragraph (a) of this section and §172.606 of this part in the same manner as prescribed for shipping papers, except that the information must be maintained in the same manner aboard aircraft as the notification of pilot-in-command, and aboard vessels in the same manner as the dangerous cargo manifest. This information must be immediately accessible to train crew personnel, drivers of motor vehicles, flight crew members, and bridge personnel on vessels for use in the event of incidents involving hazardous materials.

(2) *Facility operators.* Each operator of a facility where a hazardous material is received, stored or handled during transportation, shall maintain the information required by paragraph (a) of this section whenever the hazardous material is present. This information must be in a location that is immediately accessible to facility personnel in the event of an incident involving the hazardous material.

[Amdt. 172–116, 54 FR 27146, June 27, 1989; 54 FR 28750, July 5, 1989, as amended by Amdt. 172–116, 55 FR 875, Jan. 10, 1990; Amdt. 172–151, 62 FR 1234, Jan. 8, 1997; 66 FR 45379, Aug. 28, 2001; 68 FR 75741, Dec. 31, 2003]

§ 172.604 Emergency response telephone number.

(a) A person who offers a hazardous material for transportation must provide a numeric emergency response telephone number, including the area code, for use in an emergency involving the hazardous material. For telephone

numbers outside the United States, the international access code or the “+” (plus) sign, country code, and city code, as appropriate, that are needed to complete the call must be included. The telephone number must be—

(1) Monitored at all times the hazardous material is in transportation, including storage incidental to transportation;

(2) The telephone number of a person who is either knowledgeable of the hazardous material being shipped and has comprehensive emergency response and incident mitigation information for that material, or has immediate access to a person who possesses such knowledge and information. A telephone number that requires a call back (such as an answering service, answering machine, or beeper device) does not meet the requirements of paragraph (a) of this section; and

(3) Entered on a shipping paper, as follows:

(i) Immediately following the description of the hazardous material required by subpart C of this part; or

(ii) Entered once on the shipping paper in the manner prescribed in paragraph (b) of this section in a prominent, readily identifiable, and clearly visible manner that allows the information to be easily and quickly found, such as by highlighting, use of a larger font or a font that is a different color from other text and information, or otherwise setting the information apart to provide for quick and easy recognition. The offeror may use one of the methods prescribed in this paragraph only if the telephone number applies to each hazardous material entered on the shipping paper, and if it is indicated that the telephone number is for emergency response information (for example: “EMERGENCY CONTACT: * * *”).

(b) The telephone number required by paragraph (a) of this section must be —

(1) The number of the person offering the hazardous material for transportation when that person is also the emergency response information provider (ERI provider). The name of the person, or contract number or other unique identifier assigned by an ERI provider, identified with the emergency response telephone number must

be entered on the shipping paper immediately before, after, above, or below the emergency response telephone number unless the name is entered elsewhere on the shipping paper in a prominent, readily identifiable, and clearly visible manner that allows the information to be easily and quickly found; or

(2) The number of an agency or organization capable of, and accepting responsibility for, providing the detailed information required by paragraph (a)(2) of this section. The person who is registered with the ERI provider must ensure that the agency or organization has received current information on the material before it is offered for transportation. The person who is registered with the ERI provider must be identified by name, or contract number or other unique identifier assigned by the ERI provider, on the shipping paper immediately before, after, above, or below the emergency response telephone number in a prominent, readily identifiable, and clearly visible manner that allows the information to be easily and quickly found, unless the name or identifier is entered elsewhere in a prominent manner as provided in paragraph (b)(1) of this section.

(c) A person preparing shipping papers for continued transportation in commerce must include the information required by this section. If the person preparing shipping papers for continued transportation in commerce elects to assume responsibility for providing the emergency response telephone number required by this section, the person must ensure that all the requirements of this section are met.

(d) The requirements of this section do not apply to—

(1) Hazardous materials that are offered for transportation under the provisions applicable to limited quantities or excepted quantities; or

(2) Materials properly described under the following shipping names:

- (i) Battery powered equipment.
- (ii) Battery powered vehicle.
- (iii) Carbon dioxide, solid.
- (iv) Castor bean.
- (v) Castor flake.
- (vi) Castor meal.
- (vii) Castor pomace.
- (viii) Consumer commodity.

(ix) Dry ice.

(x) Engine, fuel cell, flammable gas powered.

(xi) Engine, fuel cell, flammable liquid powered.

(xii) Engine, internal combustion.

(xiii) Engine, internal combustion, flammable gas powered.

(xiv) Engine, internal combustion, flammable liquid powered.

(xv) Fish meal, stabilized.

(xvi) Fish scrap, stabilized.

(xvii) Krill Meal, PG III.

(xviii) Machinery, internal combustion.

(xix) Machinery, fuel cell, flammable gas powered.

(xx) Machinery, fuel cell, flammable liquid powered.

(xxi) Machinery, internal combustion, flammable gas powered.

(xxii) Machinery, internal combustion, flammable liquid powered.

(xxiii) Refrigerating machine.

(xxiv) Vehicle, flammable gas powered.

(xxv) Vehicle, flammable liquid powered.

(xxvi) Wheelchair, electric.

(3) Transportation vehicles or freight containers containing lading that has been fumigated and displaying the FUMIGANT marking (see §172.302(g)) as required by §173.9 of this subchapter, unless other hazardous materials are present in the cargo transport unit.

[74 FR 53422, Oct. 19, 2009, as amended at 75 FR 53596, Sept. 1, 2010; 77 FR 37984, June 25, 2012; 78 FR 1073, Jan. 7, 2013; 78 FR 60753, Oct. 1, 2013; 81 FR 35541, June 2, 2016; 83 FR 55807, Nov. 7, 2018; 85 FR 27878, May 11, 2020]

§ 172.606 Carrier information contact.

(a) Each carrier who transports or accepts for transportation a hazardous material for which a shipping paper is required shall instruct the operator of a motor vehicle, train, aircraft, or vessel to contact the carrier (e.g., by telephone or mobile radio) in the event of an incident involving the hazardous material.

(b) For transportation by highway, if a transport vehicle, (e.g., a semi-trailer or freight container-on-chassis) contains hazardous material for which a shipping paper is required and the vehicle is separated from its motive power and parked at a location other than a

§ 172.700

facility operated by the consignor or consignee or a facility (e.g., a carrier's terminal or a marine terminal) subject to the provisions of §172.602(c)(2), the carrier shall—

(1) Mark the transport vehicle with the telephone number of the motor carrier on the front exterior near the brake hose and electrical connections or on a label, tag, or sign attached to the vehicle at the brake hose or electrical connection; or

(2) Have the shipping paper and emergency response information readily available on the transport vehicle.

(c) The requirements specified in paragraph (b) of this section do not apply to an unattended motor vehicle separated from its motive power when the motor vehicle is marked on an orange panel, a placard, or a plain white square-on-point configuration with the identification number of each hazardous material loaded therein, and the marking or placard is visible on the outside of the motor vehicle.

[Amdt. 172-151, 62 FR 1234, Jan. 8, 1997, as amended at 62 FR 39398, 39409, July 22, 1997; 63 FR 16076, Apr. 1, 1998]

Subpart H—Training

SOURCE: Amdt. 172-126, 57 FR 20952, May 15, 1992, unless otherwise noted.

§ 172.700 Purpose and scope.

(a) *Purpose.* This subpart prescribes requirements for training hazmat employees.

(b) *Scope.* Training as used in this subpart means a systematic program that ensures a hazmat employee has familiarity with the general provisions of this subchapter, is able to recognize and identify hazardous materials, has knowledge of specific requirements of this subchapter applicable to functions performed by the employee, and has knowledge of emergency response information, self-protection measures and accident prevention methods and procedures (see §172.704).

(c) *Modal-specific training requirements.* Additional training requirements for the individual modes of transportation are prescribed in parts 174, 175, 176, and 177 of this subchapter.

49 CFR Ch. I (10-1-23 Edition)

§ 172.701 Federal-State relationship.

This subpart and the parts referenced in §172.700(c) prescribe minimum training requirements for the transportation of hazardous materials. For motor vehicle drivers, however, a State may impose more stringent training requirements only if those requirements—

(a) Do not conflict with the training requirements in this subpart and in part 177 of this subchapter; and

(b) Apply only to drivers domiciled in that State.

§ 172.702 Applicability and responsibility for training and testing.

(a) A hazmat employer shall ensure that each of its hazmat employees is trained in accordance with the requirements prescribed in this subpart.

(b) Except as provided in §172.704(c)(1), a hazmat employee who performs any function subject to the requirements of this subchapter may not perform that function unless instructed in the requirements of this subchapter that apply to that function. It is the duty of each hazmat employer to comply with the applicable requirements of this subchapter and to thoroughly instruct each hazmat employee in relation thereto.

(c) Training may be provided by the hazmat employer or other public or private sources.

(d) A hazmat employer shall ensure that each of its hazmat employees is tested by appropriate means on the training subjects covered in §172.704.

[Amdt. 172-126, 57 FR 20952, May 15, 1992; 57 FR 22182, May 27, 1992, as amended by Amdt. 172-149, 61 FR 27173, May 30, 1996]

§ 172.704 Training requirements.

(a) Hazmat employee training must include the following:

(1) *General awareness/familiarization training.* Each hazmat employee shall be provided general awareness/familiarization training designed to provide familiarity with the requirements of this subchapter, and to enable the employee to recognize and identify hazardous materials consistent with the hazard communication standards of this subchapter.

(2) *Function-specific training.* (i) Each hazmat employee must be provided function-specific training concerning requirements of this subchapter, or exemptions or special permits issued under subchapter A of this chapter, that are specifically applicable to the functions the employee performs.

(ii) As an alternative to function-specific training on the requirements of this subchapter, training relating to the requirements of the ICAO Technical Instructions and the IMDG Code may be provided to the extent such training addresses functions authorized by subpart C of part 171 of this subchapter.

(3) *Safety training.* Each hazmat employee shall receive safety training concerning—

(i) Emergency response information required by subpart G of part 172;

(ii) Measures to protect the employee from the hazards associated with hazardous materials to which they may be exposed in the work place, including specific measures the hazmat employer has implemented to protect employees from exposure; and

(iii) Methods and procedures for avoiding accidents, such as the proper procedures for handling packages containing hazardous materials.

(4) *Security awareness training.* Each hazmat employee must receive training that provides an awareness of security risks associated with hazardous materials transportation and methods designed to enhance transportation security. This training must also include a component covering how to recognize and respond to possible security threats. New hazmat employees must receive the security awareness training required by this paragraph within 90 days after employment.

(5) *In-depth security training.* Each hazmat employee of a person required to have a security plan in accordance with subpart I of this part who handles hazardous materials covered by the plan, performs a regulated function related to the hazardous materials covered by the plan, or is responsible for implementing the plan must be trained concerning the security plan and its implementation. Security training must include company security objectives, organizational security struc-

ture, specific security procedures, specific security duties and responsibilities for each employee, and specific actions to be taken by each employee in the event of a security breach.

(b) *OSHA, EPA, and other training.* Training conducted by employers to comply with the hazard communication programs required by the Occupational Safety and Health Administration of the Department of Labor (29 CFR 1910.120 or 1910.1200) or the Environmental Protection Agency (40 CFR 311.1), or training conducted by employers to comply with security training programs required by other Federal or international agencies, may be used to satisfy the training requirements in paragraph (a) of this section to the extent that such training addresses the training components specified in paragraph (a) of this section.

(c) *Initial and recurrent training.*—(1) *Initial training.* A new hazmat employee, or a hazmat employee who changes job functions may perform those functions prior to the completion of training provided—

(i) The employee performs those functions under the direct supervision of a properly trained and knowledgeable hazmat employee; and

(ii) The training is completed within 90 days after employment or a change in job function.

(2) *Recurrent training.* A hazmat employee must receive the training required by this subpart at least once every three years. For in-depth security training required under paragraph (a)(5) of this section, a hazmat employee must be trained at least once every three years or, if the security plan for which training is required is revised during the three-year recurrent training cycle, within 90 days of implementation of the revised plan.

(3) *Relevant Training.* Relevant training received from a previous employer or other source may be used to satisfy the requirements of this subpart provided a current record of training is obtained from hazmat employees' previous employer.

(4) *Compliance.* Each hazmat employer is responsible for compliance with the requirements of this subchapter regardless of whether the

§ 172.800

training required by this subpart has been completed.

(d) *Recordkeeping.* Each hazmat employer must create and retain a record of current training of each hazmat employee, inclusive of the preceding three years, in accordance with this section for as long as that employee is employed by that employer as a hazmat employee and for 90 days thereafter. A hazmat employer must make a hazmat employee's record of current training available upon request, at a reasonable time and location, to an authorized official of the Department of Transportation or of an entity explicitly granted authority to enforce the HMR. The record must include:

- (1) The hazmat employee's name;
- (2) The most recent training completion date of the hazmat employee's training;
- (3) A description, copy, or the location of the training materials used to meet the requirements in paragraph (a) of this section;
- (4) The name and address of the person providing the training; and
- (5) Certification that the hazmat employee has been trained and tested, as required by this subpart.

(e) *Limitations.* The following limitations apply:

- (1) A hazmat employee who repairs, modifies, reconditions, or tests packagings, as qualified for use in the transportation of hazardous materials, and who does not perform any other function subject to the requirements of this subchapter, is not subject to the training requirement of paragraph (a)(3) of this section.
- (2) A railroad maintenance-of-way employee or railroad signalman, who does not perform any function subject to the requirements of this subchapter, is not subject to the training requirements of paragraphs (a)(2), (a)(4), or (a)(5) of this section.

[Amdt. 172-126, 57 FR 20952, May 15, 1992, as amended by Amdt. 172-126, 58 FR 5851, Jan. 22, 1993; Amdt. 172-145, 60 FR 49110, Sept. 21, 1995; Amdt. 172-149, 61 FR 27173, May 30, 1996; 65 FR 50460, Aug. 18, 2000; 68 FR 14521, Mar. 25, 2003; 70 FR 73164, Dec. 9, 2005; 73 FR 4716, Jan. 28, 2008; 73 FR 57005, Oct. 1, 2008; 75 FR 10988, Mar. 9, 2010; 76 FR 56314, Sept. 13, 2011; 78 FR 15326, Mar. 11, 2013; 80 FR 72923, Nov. 23, 2015]

49 CFR Ch. I (10-1-23 Edition)

Subpart I—Safety and Security Plans

SOURCE: 68 FR 14521, Mar. 25, 2003, unless otherwise noted.

§ 172.800 Purpose and applicability.

(a) *Purpose.* This subpart prescribes requirements for development and implementation of plans to address security risks related to the transportation of hazardous materials in commerce.

(b) *Applicability.* Each person who offers for transportation in commerce or transports in commerce one or more of the following hazardous materials must develop and adhere to a transportation security plan for hazardous materials that conforms to the requirements of this subpart. As used in this section, "large bulk quantity" refers to a quantity greater than 3,000 kg (6,614 pounds) for solids or 3,000 liters (792 gallons) for liquids and gases in a single packaging such as a cargo tank motor vehicle, portable tank, tank car, or other bulk container.

(1) Any quantity of a Division 1.1, 1.2, or 1.3 material.

(2) A quantity of a Division 1.4, 1.5, or 1.6 material requiring placarding in accordance with subpart F of this part.

(3) A large bulk quantity of Division 2.1 material.

(4) A large bulk quantity of Division 2.2 material with a subsidiary hazard of 5.1.

(5) Any quantity of a material poisonous by inhalation, as defined in § 171.8 of this subchapter.

(6) A large bulk quantity of a Class 3 material meeting the criteria for Packing Group I or II.

(7) A quantity of desensitized explosives meeting the definition of Division 4.1 or Class 3 material requiring placarding in accordance with subpart F of this part.

(8) A large bulk quantity of a Division 4.2 material meeting the criteria for Packing Group I or II.

(9) A quantity of a Division 4.3 material requiring placarding in accordance with subpart F of this part.

(10) A large bulk quantity of a Division 5.1 material in Packing Groups I and II; perchlorates; or ammonium nitrate, ammonium nitrate fertilizers, or

ammonium nitrate emulsions, suspensions, or gels.

(11) Any quantity of organic peroxide, Type B, liquid or solid, temperature controlled.

(12) A large bulk quantity of Division 6.1 material (for a material poisonous by inhalation see paragraph (5) above).

(13) A select agent or toxin regulated by the Centers for Disease Control and Prevention under 42 CFR part 73 or the U.S. Department of Agriculture under 9 CFR part 121.

(14) A quantity of uranium hexafluoride requiring placarding under § 172.505(b).

(15) International Atomic Energy Agency Code of Conduct (IBR, see § 171.7) Category 1 and 2 materials, Nuclear Regulatory Commission, Category 1 and Category 2 radioactive materials as listed in Table 1, appendix A to 10 CFR part 37, and Highway Route Controlled quantities as defined in 49 CFR 173.403.

(16) A large bulk quantity of Class 8 material meeting the criteria for Packing Group I.

(c) *Exceptions.* Transportation activities of a farmer, who generates less than \$500,000 annually in gross receipts from the sale of agricultural commodities or products, are not subject to this subpart if such activities are:

(1) Conducted by highway or rail;

(2) In direct support of their farming operations; and

(3) Conducted within a 150-mile radius of those operations.

[68 FR 14521, Mar. 25, 2003, as amended at 70 FR 73164, Dec. 9, 2005; 71 FR 32258, June 2, 2006; 75 FR 10988, Mar. 9, 2010; 75 FR 53597, Sept. 1, 2010; 76 FR 56314, Sept. 13, 2011; 85 FR 27878, May 11, 2020; 85 FR 83381, Dec. 21, 2020]

§ 172.802 Components of a security plan.

(a) The security plan must include an assessment of transportation security risks for shipments of the hazardous materials listed in § 172.800, including site-specific or location-specific risks associated with facilities at which the hazardous materials listed in § 172.800 are prepared for transportation, stored, or unloaded incidental to movement, and appropriate measures to address the assessed risks. Specific measures put into place by the plan may vary

commensurate with the level of threat at a particular time. At a minimum, a security plan must include the following elements:

(1) *Personnel security.* Measures to confirm information provided by job applicants hired for positions that involve access to and handling of the hazardous materials covered by the security plan. Such confirmation system must be consistent with applicable Federal and State laws and requirements concerning employment practices and individual privacy.

(2) *Unauthorized access.* Measures to address the assessed risk that unauthorized persons may gain access to the hazardous materials covered by the security plan or transport conveyances being prepared for transportation of the hazardous materials covered by the security plan.

(3) *En route security.* Measures to address the assessed security risks of shipments of hazardous materials covered by the security plan en route from origin to destination, including shipments stored incidental to movement.

(b) The security plan must also include the following:

(1) Identification by job title of the senior management official responsible for overall development and implementation of the security plan;

(2) Security duties for each position or department that is responsible for implementing the plan or a portion of the plan and the process of notifying employees when specific elements of the security plan must be implemented; and

(3) A plan for training hazmat employees in accordance with § 172.704 (a)(4) and (a)(5) of this part.

(c) The security plan, including the transportation security risk assessment developed in accordance with paragraph (a) of this section, must be in writing and must be retained for as long as it remains in effect. The security plan must be reviewed at least annually and revised and/or updated as necessary to reflect changing circumstances. The most recent version of the security plan, or portions thereof, must be available to the employees who are responsible for implementing it, consistent with personnel security clearance or background investigation

§ 172.804

49 CFR Ch. I (10–1–23 Edition)

restrictions and a demonstrated need to know. When the security plan is updated or revised, all employees responsible for implementing it must be notified and all copies of the plan must be maintained as of the date of the most recent revision.

(d) Each person required to develop and implement a security plan in accordance with this subpart must maintain a copy of the security plan (or an electronic file thereof) that is accessible at, or through, its principal place of business and must make the security plan available upon request, at a reasonable time and location, to an authorized official of the Department of Transportation or the Department of Homeland Security.

[68 FR 14521, Mar. 25, 2003, as amended at 75 FR 10989, Mar. 9, 2010]

§ 172.804 Relationship to other Federal requirements.

To avoid unnecessary duplication of security requirements, security plans that conform to regulations, standards, protocols, or guidelines issued by other Federal agencies, international organizations, or industry organizations may be used to satisfy the requirements in this subpart, provided such security plans address the requirements specified in this subpart.

§ 172.820 Additional planning requirements for transportation by rail.

(a) *General.* Each rail carrier transporting in commerce one or more of the following materials is subject to the additional safety and security planning requirements of this section:

(1) More than 2,268 kg (5,000 lbs.) in a single carload of a Division 1.1, 1.2 or 1.3 explosive;

(2) A quantity of a material poisonous by inhalation in a single bulk packaging;

(3) A highway route-controlled quantity of a Class 7 (radioactive) material, as defined in §173.403 of this subchapter;

(4) A high-hazard flammable train (HHFT) as defined in §171.8 of this subchapter; or

(5) A quantity of UN1972 (Methane, refrigerated liquid or Natural gas, refrigerated liquid) when transported in a rail tank car.

(b) Not later than 90 days after the end of each calendar year, a rail carrier must compile commodity data for the previous calendar year for the materials listed in paragraph (a) of this section. The following stipulations apply to data collected:

(1) Commodity data must be collected by route, a line segment or series of line segments as aggregated by the rail carrier. Within the rail carrier selected route, the commodity data must identify the geographic location of the route and the total number of shipments by UN identification number for the materials specified in paragraph (a) of this section.

(i) A rail carrier subject to additional planning requirements of this section based on paragraph (a)(5) of this section that has yet to transport UN 1972, must factor in planned shipments of UN 1972 to the commodity data for use in the paragraph (c) route analysis prior to initial transport of the material.

(ii) [Reserved]

(2) A carrier may compile commodity data, by UN number, for all Class 7 materials transported (instead of only highway route controlled quantities of Class 7 materials) and for all Division 6.1 materials transported (instead of only Division 6.1 poison inhalation hazard materials).

(c) *Rail transportation route analysis.* For each calendar year, a rail carrier must analyze the safety and security risks for the transportation route(s), identified in the commodity data collected as required by paragraph (b) of this section. The route analysis must be in writing and include the factors contained in appendix D to this part, as applicable.

(1) The safety and security risks present must be analyzed for the route and railroad facilities along the route. For purposes of this section, railroad facilities are railroad property including, but not limited to, classification and switching yards, storage facilities, and non-private sidings. This term does not include an offeror's facility, private track, private siding, or consignee's facility.

(2) In performing the analysis required by this paragraph, the rail carrier must seek relevant information

from state, local, and tribal officials, as appropriate, regarding security risks to high-consequence targets along or in proximity to the route(s) utilized. If a rail carrier is unable to acquire relevant information from state, local, or tribal officials, then it must document that in its analysis. For purposes of this section, a high-consequence target means a property, natural resource, location, area, or other target designated by the Secretary of Homeland Security that is a viable terrorist target of national significance, the attack of which by railroad could result in catastrophic loss of life, significant damage to national security or defense capabilities, or national economic harm.

(d) *Alternative route analysis.* (1) For each calendar year, a rail carrier must identify practicable alternative routes over which it has authority to operate, if an alternative exists, as an alternative route for each of the transportation routes analyzed in accordance with paragraph (c) of this section. The carrier must perform a safety and security risk assessment of the alternative routes for comparison to the route analysis prescribed in paragraph (c) of this section. The alternative route analysis must be in writing and include the criteria in appendix D of this part. When determining practicable alternative routes, the rail carrier must consider the use of interchange agreements with other rail carriers. The written alternative route analysis must also consider:

(i) Safety and security risks presented by use of the alternative route(s);

(ii) Comparison of the safety and security risks of the alternative(s) to the primary rail transportation route, including the risk of a catastrophic release from a shipment traveling along each route;

(iii) Any remediation or mitigation measures implemented on the primary or alternative route(s); and

(iv) Potential economic effects of using the alternative route(s), including but not limited to the economics of the commodity, route, and customer relationship.

(2) In performing the analysis required by this paragraph, the rail carrier should seek relevant information

from state, local, and tribal officials, as appropriate, regarding security risks to high-consequence targets along or in proximity to the alternative routes. If a rail carrier determines that it is not appropriate to seek such relevant information, then it must explain its reasoning for that determination in its analysis.

(e) *Route Selection.* A carrier must use the analysis performed as required by paragraphs (c) and (d) of this section to select the route to be used in moving the materials covered by paragraph (a) of this section. The carrier must consider any remediation measures implemented on a route. Using this process, the carrier must at least annually review and select the practicable route posing the least overall safety and security risk. The rail carrier must retain in writing all route review and selection decision documentation and restrict the distribution, disclosure, and availability of information contained in the route analysis to covered persons with a need-to-know, as described in parts 15 and 1520 of this title. This documentation should include, but is not limited to, comparative analyses, charts, graphics or rail system maps.

(f) *Completion of route analysis.* (1) The rail transportation route analysis, alternative route analysis, and route selection process required under paragraphs (c), (d), and (e) of this section must be completed no later than the end of the calendar year following the year to which the analyses apply.

(2) The initial analysis and route selection determinations required under paragraphs (c), (d), and (e) of this section must include a comprehensive review of the entire system. Subsequent analyses and route selection determinations required under paragraphs (c), (d), and (e) of this section must include a comprehensive, system-wide review of all operational changes, infrastructure modifications, traffic adjustments, changes in the nature of high-consequence targets located along, or in proximity to, the route, and any other changes affecting the safety or security of the movements of the materials specified in paragraph (a) of this section that were implemented during the calendar year.

(3) A rail carrier need not perform a rail transportation route analysis, alternative route analysis, or route selection process for any hazardous material other than the materials specified in paragraph (a) of this section.

(g) *Rail carrier point of contact on routing issues.* Each rail carrier must identify a point of contact (including the name, title, phone number and e-mail address) on routing issues involving the movement of materials covered by this section in its security plan and provide this information to:

(1) State and/or regional Fusion Centers that have been established to coordinate with state, local and tribal officials on security issues and which are located within the area encompassed by the rail carrier's rail system; and

(2) State, local, and tribal officials in jurisdictions that may be affected by a rail carrier's routing decisions and who directly contact the railroad to discuss routing decisions.

(h) *Storage, delays in transit, and notification.* With respect to the materials specified in paragraph (a) of this section, each rail carrier must ensure the safety and security plan it develops and implements under this subpart includes all of the following:

(1) A procedure under which the rail carrier must consult with offerors and consignees in order to develop measures for minimizing, to the extent practicable, the duration of any storage of the material incidental to movement (see §171.8 of this subchapter).

(2) Measures to prevent unauthorized access to the materials during storage or delays in transit.

(3) Measures to mitigate risk to population centers associated with in-transit storage.

(4) Measures to be taken in the event of an escalating threat level for materials stored in transit.

(5) Procedures for notifying the consignee in the event of a significant delay during transportation; such notification must be completed within 48 hours after the carrier has identified the delay and must include a revised delivery schedule. A significant delay is one that compromises the safety or security of the hazardous material or delays the shipment beyond its normal expected or planned shipping time. No-

tification should be made by a method acceptable to both the rail carrier and consignee.

(i) *Recordkeeping.* (1) Each rail carrier must maintain a copy of the information specified in paragraphs (b), (c), (d), (e), and (f) of this section (or an electronic image thereof) that is accessible at, or through, its principal place of business and must make the record available upon request, at a reasonable time and location, to an authorized official of the Department of Transportation or the Department of Homeland Security. Records must be retained for a minimum of two years.

(2) Each rail carrier must restrict the distribution, disclosure, and availability of information collected or developed in accordance with paragraphs (c), (d), (e), and (f) of this section to covered persons with a need-to-know, as described in parts 15 and 1520 of this title.

(j) *Compliance and enforcement.* If the carrier's route selection documentation and underlying analyses are found to be deficient, the carrier may be required to revise the analyses or make changes in route selection. If DOT finds that a chosen route is not the safest and most secure practicable route available, the FRA Associate Administrator for Safety, in consultation with TSA, may require the use of an alternative route. Prior to making such a determination, FRA and TSA will consult with the Surface Transportation Board (STB) regarding whether the contemplated alternative route(s) would be economically practicable.

[73 FR 20771, Apr. 16, 2008, as amended at 73 FR 72193, Dec. 26, 2008; 76 FR 56314, Sept. 13, 2011; 80 FR 26746, May 8, 2015; 85 FR 45029, July 24, 2020]

§ 172.822 Limitation on actions by states, local governments, and Indian tribes.

A law, order, or other directive of a state, political subdivision of a state, or an Indian tribe that designates, limits, or prohibits the use of a rail line (other than a rail line owned by a state, political subdivision of a state, or an Indian tribe) for the transportation of hazardous materials, including, but not limited to, the materials

specified in §172.820(a), is preempted. 49 U.S.C. 5125, 20106.

[73 FR 20772, Apr. 16, 2008]

APPENDIX A TO PART 172—OFFICE OF HAZARDOUS MATERIALS TRANSPORTATION COLOR TOLERANCE CHARTS AND TABLES

The following are Munsell notations and Commission Internationale de L'Eclairage (CIE) coordinates which describe the Office of Hazardous Materials Transportation Label and Placard Color Tolerance Charts in tables 1 and 2, and the CIE coordinates for the color tolerances specified in table 3. Central colors

and tolerances described in table 2 approximate those described in table 1 while allowing for differences in production methods and materials used to manufacture labels and placards surfaced with printing inks. Primarily, the color charts based on table 1 are for label or placard colors applied as opaque coatings such as paint, enamel or plastic, whereas color charts based on table 2 are intended for use with labels and placards surfaced only with inks.

For labels printed directly on packaging surfaces, table 3 may be used, although compliance with either table 1 or table 2 is sufficient. However, if visual reference indicates that the colors of labels printed directly on package surfaces are outside the table 1 or 2 tolerances, a spectrophotometer or other instrumentation may be required to insure compliance with table 3.

TABLE 1—SPECIFICATIONS FOR COLOR TOLERANCE CHARTS FOR USE WITH LABELS AND PLACARDS SURFACED WITH PAINT, LACQUER, ENAMEL, PLASTIC, OTHER OPAQUE COATINGS, OR INK¹

Color	Munsell notations	CIE data for source C		
		Y	x	y
Red:				
Central color	7.5R 4.0/14	12.00	.5959	.3269
Orange	8.5R 4.0/14	12.00	.6037	.3389
Purple and vivid	6.5R 4.0/14	12.00	.5869	.3184
Grayish	7.5R 4.0/12	12.00	.5603	.3321
Vivid	7.5R 4.0/16	12.00	.6260	.3192
Light	7.5R 4.5/14	15.57	.5775	.3320
Dark	7.5R 3.5/14	09.00	.6226	.3141
Orange:				
Central color	5.OYR 6.0/15	30.05	.5510	.4214
Yellow and Grayish	6.25YR 6.0/15	30.05	.5452	.4329
Red and vivid	3.75YR 6.0/15	30.05	.5552	.4091
Grayish	5.OYR 6.0/13	30.05	.5311	.4154
Vivid	5.OYR 6.0/16	30.05	.5597	.4239
Light	5.OYR 6.5/15	36.20	.5427	.4206
Dark	5.OYR 5.5/15	24.58	.5606	.4218
Yellow:				
Central color	5.OY 8.0/12	59.10	.4562	.4788
Green	6.5Y 8.0/12	59.10	.4498	.4865
Orange and vivid	3.5Y 8.0/12	59.10	.4632	.4669
Grayish	5.OY 8.0/10	59.10	.4376	.4601
Vivid	5.OY 8.0/14	59.10	.4699	.4920
Light	5.OY 8.5/12	68.40	.4508	.4754
Dark	5.OY 7.5/12	50.68	.4620	.4823
Green:				
Central color	7.5G 4.0/9	12.00	.2111	.4121
Bluish	0.5BG 4.0/9	12.00	.1974	.3809
Green-yellow	5.0G 4.0/9	12.00	.2237	.4399
Grayish A	7.5G 4.0/7	12.00	.2350	.3922
Grayish B ²	7.5G 4.0/6	12.00	.2467	.3822
Vivid	7.5G 4.0/11	12.00	.1848	.4319
Light	7.5G 4.5/9	15.57	.2204	.4060
Dark	7.5G 3.5/9	09.00	.2027	.4163
Blue:				
Central color	2.5PB 3.5/10	09.00	.1691	.1744
Purple	4.5PB 3.5/10	09.00	.1796	.1711
Green and vivid	10.0B 3.5/10	09.00	.1557	.1815
Grayish	2.5PB 3.5/8	09.00	.1888	.1964
Vivid	2.5PB 3.5/12	09.00	.1516	.1547
Light	2.5PB 4.0/10	12.00	.1805	.1888
Dark	2.5PB 3.0/10	06.55	.1576	.1600
Purple:				
Central color	10.0P 4.5/10	15.57	.3307	.2245
Reddish purple	2.5RP 4.5/10	15.57	.3584	.2377
Blue purple	7.5P 4.5/10	15.57	.3068	.2145
Reddish gray	10.0P 4.5/8	15.57	.3280	.2391

TABLE 1—SPECIFICATIONS FOR COLOR TOLERANCE CHARTS FOR USE WITH LABELS AND PLACARDS SURFACED WITH PAINT, LACQUER, ENAMEL, PLASTIC, OTHER OPAQUE COATINGS, OR INK¹—Continued

Color	Munsell notations	CIE data for source C		
		Y	x	y
Gray ²	10.0P 4.5/6.5	15.57	.3254	.2519
Vivid	10.0P 4.5/12	15.57	.3333	.2101
Light	10.0P 5.0/10	19.77	.3308	.2328
Dark	10.0P 4.0/10	12.00	.3306	.2162

¹ Maximum chroma is not limited.
² For the colors green and purple, the minimum saturation (chroma) limits for porcelain enamel on metal are lower than for most other surface coatings. Therefore, the minimum chroma limits of these two colors as displayed on the Charts for comparison to porcelain enamel on metal is low, as shown for green (grayish B) and purple (gray).
 NOTE: CIE = Commission Internationale de L'Eclairage.

TABLE 2—SPECIFICATIONS FOR COLOR TOLERANCE CHARTS FOR USE WITH LABELS AND PLACARDS SURFACED WITH INK

Color/series	Munsell notation	CIE data for source C		
		Y	x	y
Red:				
Central series:				
Central color	6.8R 4.47/12.8	15.34	.5510	.3286
Grayish	7.2R 4.72/12.2	17.37	.5368	.3348
Purple	6.4R 4.49/12.7	15.52	.5442	.3258
Purple and vivid	6.1R 4.33/13.1	14.25	.5529	.3209
Vivid	6.7R 4.29/13.2	13.99	.5617	.3253
Orange	7.3R 4.47/12.8	15.34	.5572	.3331
Orange and grayish	7.65R 4.70/12.4	17.20	.5438	.3382
Light series:				
Light	7.0R 4.72/13.2	17.32	.5511	.3322
Light and orange	7.4R 4.96/12.6	19.38	.5365	.3382
Light and purple	6.6R 4.79/12.9	17.94	.5397	.3289
Dark series:				
Dark A	6.7R 4.19/12.5	13.30	.5566	.3265
Dark B	7.0R 4.25/12.35	13.72	.5522	.3294
Dark and purple	7.5R 4.23/12.4	13.58	.5577	.3329
Orange:				
Central series:				
Central color	5.0YR 6.10/12.15	31.27	.5193	.4117
Yellow and grayish A	5.8YR 6.22/11.7	32.69	.5114	.4155
Yellow and grayish B	6.1YR 6.26/11.85	33.20	.5109	.4190
Vivid	5.1YR 6.07/12.3	30.86	.5226	.4134
Red and vivid A	3.9YR 5.87/12.75	28.53	.5318	.4038
Red and vivid B	3.6YR 5.91/12.6	29.05	.5291	.4021
Grayish	4.9YR 6.10/11.9	31.22	.5170	.4089
Light series:				
Light and vivid A	5.8YR 6.78/12.7	39.94	.5120	.4177
Light and yellow	6.0YR 6.80/12.8	40.20	.5135	.4198
Light and vivid B	4.9YR 6.60/12.9	37.47	.5216	.4126
Dark series:				
Dark and yellow	5.8YR 5.98/11.0	29.87	.5052	.4132
Dark A	5.1YR 5.80/11.1	27.80	.5127	.4094
Dark B	5.0YR 5.80/11.0	27.67	.5109	.4068
Yellow:				
Central series:				
Central color	4.3Y 7.87/10.3	56.81	.4445	.4589
Vivid A	4.5Y 7.82/10.8	55.92	.4503	.4658
Vivid B	3.3Y 7.72/11.35	54.24	.4612	.4624
Vivid and orange	3.2Y 7.72/10.8	54.25	.4576	.4572
Grayish A	4.1Y 7.95/9.7	58.18	.4380	.4516
Grayish B	5.1Y 8.06/9.05	60.12	.4272	.4508
Green-yellow	5.2Y 7.97/9.9	58.53	.4356	.4605
Light series:				
Light	5.4Y 8.59/10.5	70.19	.4351	.4628
Light and green-yellow	5.4Y 8.56/11.2	69.59	.4414	.4692
Light and vivid	4.4Y 8.45/11.4	67.42	.4490	.4662
Dark series:				
Dark and green-yellow	4.4Y 7.57/9.7	51.82	.4423	.4562
Dark and orange A	3.4Y 7.39/10.4	48.86	.4584	.4590
Dark and orange B	3.5Y 7.41/10.0	49.20	.4517	.4544

TABLE 2—SPECIFICATIONS FOR COLOR TOLERANCE CHARTS FOR USE WITH LABELS AND PLACARDS SURFACED WITH INK—Continued

Color/series	Munsell notation	CIE data for source C		
		Y	x	y
Green:				
Central series:				
Central color	9.75G 4.26/7.75	13.80	.2214	.3791
Grayish	10G 4.46/7.5	15.25	.2263	.3742
Blue A	1.4BG 4.20/7.4	13.36	.2151	.3625
Blue B	1.0BG 4.09/7.75	12.60	.2109	.3685
Vivid	8.4G 4.09/8.05	12.59	.2183	.3954
Vivid green-yellow	7.0G 4.23/8.0	13.54	.2292	.4045
Green-yellow	7.85G 4.46/7.7	15.23	.2313	.3914
Light series:				
Light and vivid	9.5G 4.45/8.8	15.21	.2141	.3863
Light and blue	0.2BG 4.31/8.8	14.12	.2069	.3814
Light and green-yellow	8.3G 4.29/9.05	14.01	.2119	.4006
Dark series:				
Dark and green-yellow	7.1G 4.08/7.1	12.55	.2354	.3972
Dark and grayish	9.5G 4.11/6.9	12.70	.2282	.3764
Dark	8.5G 3.97/7.2	11.78	.2269	.3874
Blue:				
Central series:				
Central color	3.5PB 3.94/9.7	11.58	.1885	.1911
Green and grayish A	2.0PB 4.35/8.7	14.41	.1962	.2099
Green and grayish B	1.7PB 4.22/9.0	13.50	.1898	.2053
Vivid	2.9PB 3.81/9.7	10.78	.1814	.1852
Purple and vivid A	4.7PB 3.53/10.0	9.15	.1817	.1727
Purple and vivid B	5.0PB 3.71/9.9	10.20	.1888	.1788
Grayish	3.75PB 4.03/9.1	12.17	.1943	.1961
Light series:				
Light and green A	1.7PB 4.32/9.2	14.22	.1904	.2056
Light and green B	1.5PB 4.11/9.6	12.72	.1815	.1971
Light and vivid	3.2PB 3.95/10.05	11.70	.1831	.1868
Dark series:				
Dark and grayish	3.9PB 4.01/8.7	12.04	.1982	.1992
Dark and purple A	4.8PB 3.67/9.3	9.95	.1918	.1831
Dark and purple B	5.2PB 3.80/9.05	10.76	.1985	.1885
Purple:				
Central series:				
Central color	9.5P 4.71/11.3	17.25	.3274	.2165
Red	1.0RP 5.31/10.8	22.70	.3404	.2354
Red and vivid A	1.4RP 5.00/11.9	19.78	.3500	.2274
Red and vivid B	0.2RP 4.39/12.5	14.70	.3365	.2059
Vivid	8.0P 4.04/12.0	12.23	.3098	.1916
Blue	7.0P 4.39/10.8	14.71	.3007	.2037
Grayish	8.8P 5.00/10.3	19.73	.3191	.2251
Light series:				
Light and red A	0.85RP 5.56/11.1	25.18	.3387	.2356
Light and red B	1.1RP 5.27/12.3	22.27	.3460	.2276
Light and vivid	9.2P 4.94/11.95	19.24	.3247	.2163
Dark series:				
Dark and grayish	9.6P 4.70/10.9	17.19	.3283	.2204
Dark and vivid	8.4P 4.05/11.6	12.35	.3144	.1970
Dark and blue	7.5P 4.32/10.5	14.19	.3059	.2078

TABLE 3—SPECIFICATION FOR COLORS FOR USE WITH LABELS PRINTED ON PACKAGINGS SURFACES

CIE data for source C	Red	Orange	Yellow	Green	Blue	Purple
x424	.460	.417	.228	.200	.377
y306	.370	.392	.354	.175	.205
x571	.543	.490	.310	.255	.377
y306	.400	.442	.354	.250	.284
x424	.445	.390	.228	.177	.342
y350	.395	.430	.403	.194	.205
x571	.504	.440	.310	.230	.342
y350	.430	.492	.403	.267	.284
Y (high)	23.0	41.6	72.6	20.6	15.9	21.2
Y (low)	7.7	19.5	29.1	7.4	6.5	8.2

[Amdt. 172-50, 44 FR 9757, Feb. 15, 1979; Amdt. 172-50, 44 FR 10984, Feb. 26, 1979, as amended by Amdt. 172-50, 44 FR 22467, Apr. 16, 1979; 50 FR 45731, Nov. 1, 1985; Amdt. 172-127, 59 FR 49133, Sept. 26, 1994]

APPENDIX B TO PART 172—TREFOIL SYMBOL

1. Except as provided in paragraph 2 of this appendix, the trefoil symbol required for RADIOACTIVE labels and placards and required to be marked on certain packages of Class 7

materials must conform to the design and size requirements of this appendix.

2. RADIOACTIVE labels and placards that were printed prior to April 1, 1996, in conformance with the requirements of this subchapter in effect on March 30, 1996, may continue to be used.

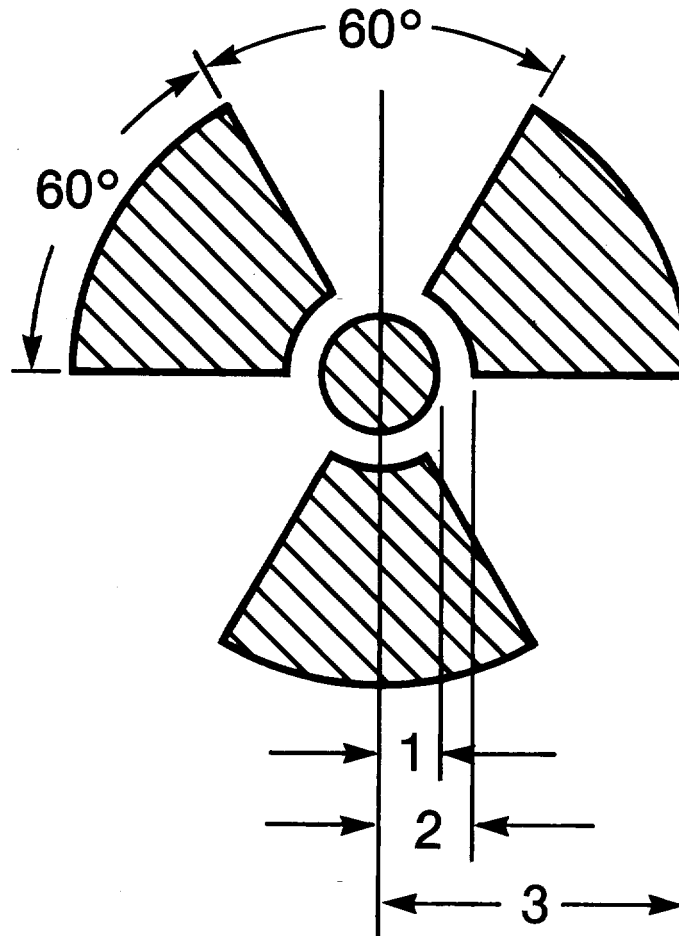

1 = Radius of Circle—
 Minimum dimensions
 4 mm (0.16 inch) for markings and labels
 12.5 mm (0.5 inch) for placards

2 = $1\frac{1}{2}$ Radii
 3 = 5 radii for markings and labels

4½ radii for placards.

[60 FR 50306, Sept. 28, 1995, as amended by
Amdt. 172-143, 61 FR 20750, May 8, 1996]

APPENDIX C TO PART 172—DIMENSIONAL SPECIFICATIONS FOR RECOMMENDED
PLACARD HOLDER

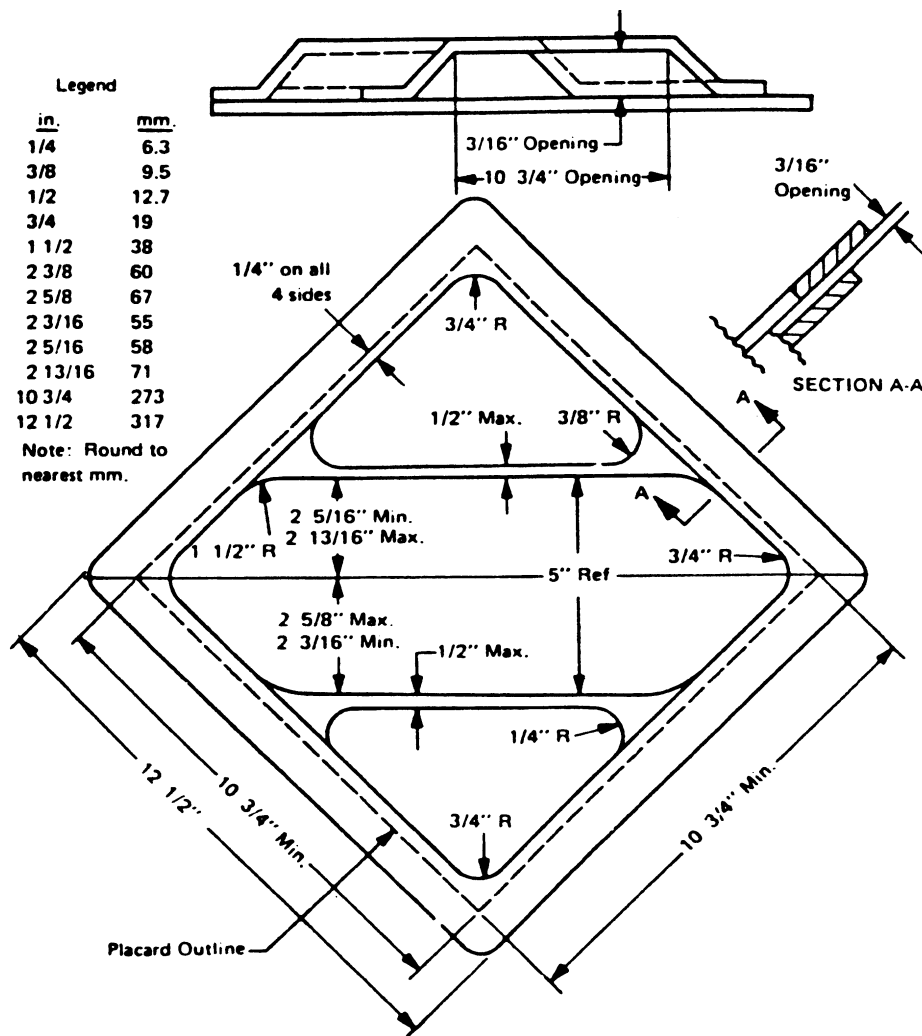

APPENDIX D TO PART 172—RAIL RISK
ANALYSIS FACTORS

A. This appendix sets forth the minimum criteria that must be considered by rail carriers when performing the safety and secu-

rity risk analyses required by §172.820. The risk analysis to be performed may be quantitative, qualitative, or a combination of both. In addition to clearly identifying the hazardous material(s) and route(s) being analyzed, the analysis must provide a thorough

description of the threats, identified vulnerabilities, and mitigation measures implemented to address identified vulnerabilities.

B. In evaluating the safety and security of hazardous materials transport, selection of the route for transportation is critical. For the purpose of rail transportation route analysis, as specified in §172.820(c) and (d), a route may include the point where the carrier takes possession of the material and all track and railroad facilities up to the point where the material is relinquished to another entity. Railroad facilities are railroad property including, but not limited to, classification and switching yards, storage facilities, and non-private sidings; however, they do not include an offeror's facility, private track, private siding, or consignee's facility. Each rail carrier must use best efforts to communicate with its shippers, consignees, and interlining partners to ensure the safety and security of shipments during all stages of transportation.

C. Because of the varying operating environments and interconnected nature of the rail system, each carrier must select and document the analysis method/model used and identify the routes to be analyzed.

D. The safety and security risk analysis must consider current data and information as well as changes that may reasonably be anticipated to occur during the analysis year. Factors to be considered in the performance of this safety and security risk analysis include:

1. Volume of hazardous material transported;
2. Rail traffic density;
3. Trip length for route;
4. Presence and characteristics of railroad facilities;
5. Track type, class, and maintenance schedule;
6. Track grade and curvature;
7. Presence or absence of signals and train control systems along the route ("dark" versus signaled territory);
8. Presence or absence of wayside hazard detectors;
9. Number and types of grade crossings;
10. Single versus double track territory;
11. Frequency and location of track turn-outs;
12. Proximity to iconic targets;
13. Environmentally sensitive or significant areas;
14. Population density along the route;
15. Venues along the route (stations, events, places of congregation);
16. Emergency response capability along the route;
17. Areas of high consequence along the route, including high consequence targets as defined in §172.820(c);
18. Presence of passenger traffic along route (shared track);

19. Speed of train operations;
20. Proximity to en-route storage or repair facilities;
21. Known threats, including any non-public threat scenarios provided by the Department of Homeland Security or the Department of Transportation for carrier use in the development of the route assessment;
22. Measures in place to address apparent safety and security risks;
23. Availability of practicable alternative routes;
24. Past incidents;
25. Overall times in transit;
26. Training and skill level of crews; and
27. Impact on rail network traffic and congestion.

[73 FR 20772, Apr. 16, 2008]

PART 173—SHIPPERS—GENERAL REQUIREMENTS FOR SHIPMENTS AND PACKAGINGS

Subpart A—General

Sec.

- 173.1 Purpose and scope.
- 173.2 Hazardous material classes and index to hazard class definitions.
- 173.2a Classification of a material having more than one hazard.
- 173.3 Packaging and exceptions.
- 173.4 Small quantity exceptions.
- 173.4a Excepted quantities.
- 173.5 Agricultural operations.
- 173.5a Oilfield service vehicles, mechanical displacement meter provers, and roadway striping vehicles exceptions.
- 173.5b Portable and mobile refrigeration systems.
- 173.6 Materials of trade exceptions.
- 173.7 Government operations and materials.
- 173.8 Exceptions for non-specification packagings used in intrastate transportation.
- 173.9 Transport vehicles or freight containers containing lading which has been fumigated.
- 173.10 Tank car shipments.
- 173.11 Exceptions for shipment of light bulbs containing hazardous materials.
- 173.12 Exceptions for shipment of waste materials.
- 173.13 Exceptions for Class 3, Divisions 4.1, 4.2, 4.3, 5.1, 6.1, and Classes 8 and 9 materials.
- 173.14 Hazardous materials in equipment in use or intended for use during transport.
- ### Subpart B—Preparation of Hazardous Materials for Transportation
- 173.21 Forbidden materials and packages.
- 173.22 Shipper's responsibility.
- 173.22a Use of packagings authorized under special permits.