

**TEA-21 OVERSIGHT: INTELLIGENT
TRANSPORTATION SYSTEMS**

HEARING
BEFORE THE
SUBCOMMITTEE ON TRANSPORTATION,
INFRASTRUCTURE, AND NUCLEAR SAFETY
OF THE
COMMITTEE ON
ENVIRONMENT AND PUBLIC WORKS
UNITED STATES SENATE
ONE HUNDRED SEVENTH CONGRESS
FIRST SESSION

SEPTEMBER 10, 2001

Printed for the use of the Committee on Environment and Public Works



U.S. GOVERNMENT PRINTING OFFICE

80-652 PDF

WASHINGTON : 2003

For sale by the Superintendent of Documents, U.S. Government Printing Office
Internet: bookstore.gpo.gov Phone: toll free (866) 512-1800; DC area (202) 512-1800
Fax: (202) 512-2250 Mail: Stop SSOP, Washington, DC 20402-0001

COMMITTEE ON ENVIRONMENT AND PUBLIC WORKS¹

ONE HUNDRED SEVENTH CONGRESS

FIRST SESSION

JAMES M. JEFFORDS, Vermont, *Chairman*

MAX BAUCUS, Montana	BOB SMITH, New Hampshire
HARRY REID, Nevada	JOHN W. WARNER, Virginia
BOB GRAHAM, Florida	JAMES M. INHOFE, Oklahoma
JOSEPH I. LIEBERMAN, Connecticut	CHRISTOPHER S. BOND, Missouri
BARBARA BOXER, California	GEORGE V. VOINOVICH, Ohio
RON WYDEN, Oregon	MICHAEL D. CRAPO, Idaho
THOMAS R. CARPER, Delaware	LINCOLN CHAFEE, Rhode Island
HILLARY RODHAM CLINTON, New York	ARLEN SPECTER, Pennsylvania
JON S. CORZINE, New Jersey	BEN NIGHTHORSE CAMPBELL, Colorado

KEN CONNOLLY, *Democratic Staff Director*

DAVE CONOVER, *Republican Staff Director*

SUBCOMMITTEE ON TRANSPORTATION, INFRASTRUCTURE AND NUCLEAR SAFETY

HARRY REID, Nevada, *Chairman*

MAX BAUCUS, Montana	JAMES M. INHOFE, Oklahoma
BOB GRAHAM, Florida	JOHN W. WARNER, Virginia
JOSEPH I. LIEBERMAN, Connecticut	CHRISTOPHER S. BOND, Missouri
BARBARA BOXER, California	GEORGE V. VOINOVICH, Ohio
RON WYDEN, Oregon	LINCOLN CHAFEE, Rhode Island

C O N T E N T S

	Page
SEPTEMBER 10, 2001	
OPENING STATEMENTS	
Graham, Hon. Bob, U.S. Senator from the State of Florida	4
Inhofe, Hon. James M., U.S. Senator from the State of Oklahoma	5
Reid, Hon. Harry, U.S. Senator from the State of Nebraska	1
Smith, Hon. Bob, U.S. Senator from the State of New Hampshire	6
Warner, Hon. John W., U.S. Senator from the Commonwealth of Virginia	3
WITNESSES	
Albert, Steve, director, Western Transportation Institute, Bozeman, MT	22
Prepared statement	208
Beall, James, Jr., chairman, Santa Clara Board of Supervisors, San Francisco Bay Area Metropolitan Transportation Commission, San Jose, CA	17
Details, High-Tech Transportation Applications	201-206
Prepared statement	197
Johnson, Christine, director, Intelligent Transportation Systems Joint Program, Office, U.S. Department of Transportation, Washington, DC	7
Prepared statement	26
Report, Intelligent Transportation Systems Benefits, 2001 Update.....	31-118
Manning, Martin, director, Clark County Department of Public Works, Las Vegas, NV	19
Prepared statement	207
Tinklenberg, Elwyn, commissioner, Minnesota Department of Transportation, St. Paul, MN	9
Prepared statement	119
Yermack, Larry, chairman, Intelligent Transportation Society of America, Washington, DC	10
Prepared statement	124
Report, Tracking the Deployment of the Integrated Metropolitan Intel- ligent Transportation Systems Infrastructure in the USA: Fiscal Year 2000 Results.....	130-191
Responses to additional questions from:	
Senator Reid	192
Senator Smith	194

TEA-21 OVERSIGHT: INTELLIGENT TRANSPORTATION SYSTEMS

MONDAY, SEPTEMBER 10, 2001

U.S. SENATE,
COMMITTEE ON ENVIRONMENT AND PUBLIC WORKS,
SUBCOMMITTEE ON TRANSPORTATION, INFRASTRUCTURE,
AND NUCLEAR SAFETY,
Washington, DC.

The subcommittee met, pursuant to notice, at 3:36 p.m. in room 406, Dirksen Senate Office Building, Hon. Harry Reid, (chairman of the subcommittee) presiding.

Present: Senators Reid and Warner.

OPENING STATEMENT OF HON. HARRY REID, U.S. SENATOR FROM THE STATE OF NEBRASKA

Senator REID. The hearing will come to order.

We welcome everyone to today's hearing on the Intelligent Transportation Systems Programs. We're almost two-thirds of the way through the 6-year authorization of the Transportation Equity Act for the 21st Century, or TEA-21, and it's time to start thinking about the next transportation bill. Senator Warner, that time moves fast, doesn't it?

Senator WARNER. It sure does.

Senator REID. The ever-increasing gap between the demand for transportation and the capacity of our infrastructure is one of our biggest challenges as we look to the future. Virtually every American depends upon our Nation's transportation infrastructure to get to work, run errands, go to school and deliver the products which keep our economy going. Transportation for better or worse is a vital part of everyone's life and the backbone of our economy.

This is why our next transportation bill is so vitally important. People are tired of spending so much time stuck in traffic. The quality of life suffers, productivity declines, and air pollution worsens the system when the system doesn't function effectively.

With limited resources and limited space available for new roads, we increasingly need to look to innovative solutions. That's why I'm pleased we're here today to discuss this Intelligent Transportation Systems program. The ITS program can make important contribution to safety through the Intelligent Vehicle Initiative and to advance communications and traveler information systems in rural areas. ITS initiatives are also improving the efficiency and safety of commercial vehicles through new high-tech communications and information systems.

Perhaps the most exciting aspect of ITS involves deploying infrastructure-based technologies to improve the operations of congested metropolitan roadways. Often building new capacity in metropolitan areas is not an option due to the high cost of right-of-way acquisition, the lack of available space, environmental concerns or clean air conformity issues. The only way to alleviate congestion in such instances is to encourage the use of alternative transportation modes and to make existing roadways operate much more efficiently.

I'm pleased today that Marty Manning, the Public Works Director for Clark County, NV—that's where Las Vegas is located—is able to join us today to discuss some of the intelligent transportation initiatives the Las Vegas region is employing to address the tremendous growth that has taken place there.

In a fast-growing State like Nevada, particularly the Las Vegas region where current road infrastructure is overwhelmed, we need to use every resource available to address this problem. We need to improve and expand our existing road infrastructure. We need to provide more and better mass transit options for commuters and visitors. We need to take advantage of new technologies to ensure that we make the most efficient use of our existing infrastructure.

More and more, we will have to shift our focus from the construction of new roads to improving the operations of existing roads. We will have a hearing next year focused on the management and operation of our regional transportation systems, but the Intelligent Transportation Systems program is a vital piece of the operations puzzle, and I look forward to hearing from our witnesses on the status of our future.

We're going to begin today to raise a concern about the mid-session review released by the Administration in August. The mid-session review estimated that highway trust fund revenues are falling so quickly that highway spending could be reduced by some \$6 billion next year. Given the needs of our transportation system and the slowing economy, this could have substantial negative impact in terms of foregone infrastructure improvements and lost construction jobs.

The last thing a slower economy needs is for the Federal Government to cut back on infrastructure investments and good construction jobs.

So I look forward to receiving a full briefing from the Administration on these new projections, and keep a close eye on this issue.

I say to my friend—he and I have worked so closely together on this committee all the time that I've been in the Senate, Senator Warner—that southern Nevada is much like northern Virginia; tremendous growth; real difficulty keeping up with the growth options.

Senator WARNER. Fastest-growing in America, is it not, Mr. Chairman? Yes.

Senator REID. But northern Virginia is much like Las Vegas in many respects. So I welcome your statement here, Mr.—I should always call you “Mr. Chairman”—because we've gone back and forth on who is running this subcommittee, and I still don't know who's running it for sure.

Senator WARNER. Oh, I do. You are.

[Laughter.]

Senator REID. Anyway, so I certainly welcome a statement by you, Senator Warner.

**OPENING STATEMENT OF HON. JOHN W. WARNER,
U.S. SENATOR FROM THE COMMONWEALTH OF VIRGINIA**

Senator WARNER. Thank you, Mr. Chairman.

Indeed, we have worked together all these many years, and this is a particularly interesting subcommittee. I was privileged to be chairman of it some years ago, and Senator Inhofe, the ranking member—speaking of transportation, his plane was canceled, so he's on a follow-up flight and will soon be here.

So, I join you in welcoming our witnesses today. I want to commend you, Mr. Leader, for finding the time. As Assistant Majority Leader, you'll go down in history as one of the more effective, certainly in the 23 years that I've been in the Senate. But having found the time to come over and fulfill other responsibilities such as this in the Senate is a great value to the institution. All too often, our leaders are just preempted by necessity from actively participating in hearings like this.

But I think back today as I visited with Ms. Johnson, of 1991 when our distinguished colleague Senator Moynihan was the chairman of the full committee. I worked with him, and indeed Ms. Johnson, you were there when we laid the cornerstone for this program. I expect you will allude to that in your testimony.

The program, as you said, Mr. Chairman, is designed to promote research and development of advanced communications technologies that could be utilized in our Nation's highways, rail and transit systems. We have a phrase in the Armed Services Committee, where I do a little labor from time to time, called "force multiplier." In other words, to the extent we can improve our intelligence and the other things, we can better utilize the entire force that we have. I look upon this concept as a force multiplier because, as the distinguished chairman said, we can only lay down so much asphalt and concrete. We've got to move ahead. But there are certain areas, like yours in Las Vegas and mine in northern Virginia, where there is just no more room to take concrete, but the transportation is gridlocked.

This enables us to take that infrastructure in place today and multiply it so that we get higher and better utilization for the investors who put in the money—the taxpayers—and the current users today.

So I remember when I was chairman of the committee in 1998, TEA-21, we had seen how from 1991 to 1998, it was a research program. We finally said, let's fish or cut bait and go forward and begin to deploy these technologies. And that we did. If I may say with some modesty, I think my State has been in the forefront of those States that have utilized these systems. I think the purpose of this hearing is to incentivize other States to do the same.

So I will put the balance of my statement into the record, and look forward to receiving testimony, Mr. Chairman.

[The prepared statement of Senator Warner follows:]

STATEMENT OF HON. JOHN WARNER, U.S. SENATOR FROM THE COMMONWEALTH OF VIRGINIA

Mr. Chairman, I join in welcoming the witnesses before the subcommittee today to provide testimony on the deployment of Intelligent Transportation Systems and ongoing research efforts under the program.

I remember very well back in 1991 that it was this committee that promoted the new Intelligent Vehicle Highway System, or IVHS as it was then known, as part of the ISTEA authorization bill.

That program was designed to promote the research and development of advanced communication technologies that could be utilized in our Nation's highways, rail and transit systems.

In 1998, TEA-21 took the next step and revised the ITS program to focus on deployment of these new technologies.

As we continue to examine how we can reduce congestion on our urban highways and increase emergency responses on our rural highways, ITS technologies are becoming part of the solution.

There will always be a need for new highway construction projects, but in urban areas it is clear that new construction alone is not the solution.

Incentives to increase transit ridership, telework programs and new ITS applications are important components of any transportation plan to improve the mobility of people commuting to work, or in moving American products across the country.

I look forward today to hearing how the program is advancing. Are States implementing ITS technologies into their routine project planning process? Is the Commercial Vehicle Information Systems and Network being deployed?

I would also like to hear from the panels today about the Intelligent Vehicle Initiative. Many of these technologies, such as computer navigation aids, are designed to help drivers with directions and emergency response. Safety experts, however, are concerned about the increasing driver distractions with these navigation aids, as well as increased cell phone use.

Senator REID. Thank you, Senator Warner.

I would also note that Senator Inhofe is a very diligent member of this subcommittee. He always does his very best to attend these hearings. I know he would be here today had his plane not been canceled.

Senator WARNER. He called me and asked if I would do the best to stand in for him. I said I was pleased to do so.

Senator REID. I would ask unanimous consent that the statement of Senator Bob Graham be made part of the record as if given here today.

Senator WARNER. And likewise, could I put one in for Senator Inhofe, Mr. Chairman.

Senator REID. That will be the order.

Senator WARNER. Thank you.

[The prepared statements of Senators Graham and Inhofe follow:]

STATEMENT OF HON. BOB GRAHAM, U.S. SENATOR FROM THE STATE OF FLORIDA

Mr. Chairman, I'd like to thank you for calling this hearing. Intelligent Transportation Systems have long been an interest of mine. I take a different job every month, and one of my more recent transportation jobs was a day spent with the Orlando, Florida's ITS experts. It was a hands-on experience that helped me understand the tremendous potential of technology in transportation, and where we still have work to do to better integrate it into our existing infrastructure.

When we last reauthorized the surface transportation bill, I was pleased that ITS received such a focus in TEA-21. Since ITS, at that time, was an evolving component of our transportation universe, I felt then that we had a lot to learn about it.

I thought we took steps in TEA-21 to make sure that the Department of Transportation and the authorizing committees could get the best information about uses of ITS in our communities. I have been troubled over the past several appropriations cycles that money that was to have been distributed by the Secretary of Transportation on a competitive basis has been consistently earmarked to various communities without much thought or rationale.

I understand that the Department of Transportation is trying to make the best of these circumstances by collecting ITS information from the communities that received earmarks that we can use during the next reauthorization cycle. But, I would like us to be even more vigilant during the appropriations process to make sure that money that is being earmarked for ITS is consistent with the goals and purposes that we outlined in TEA-21.

In many areas in our country, I believe that ITS will be an answer to congestion and frustration on our highways. We have reached a point in places that it's physically impossible to add a lane of highway—meaning we need to use our existing infrastructure in a more efficient manner. I believe ITS will allow us to do this—but I would like to be able to say that conclusively when we next look at a surface transportation bill.

If we lose the chance now to collect and analyze ITS data, explore “lessons learned,” and deploy this technology in a rational, scientific manner, we will all be less able to make informed decisions when the time comes for reauthorization.

Mr. Chairman, thank you again for holding this hearing. I look forward to learning from these witnesses, and working with you on ITS issues in the future.

STATEMENT OF HON. JAMES M. INHOFE, U.S. SENATOR FROM THE STATE
OF OKLAHOMA

Thank you Mr. Chairman. I would like to join you in welcoming our distinguished witnesses. I appreciate the time and effort they have taken to be here today, and I look forward to hearing their views on the status of Intelligent Transportation Systems (ITS).

I was on the House Public Works and Transportation Committee when ITS was first discussed in ISTEA. Back then we called it IVHS for Intelligent Vehicle Highway Systems. The focus of the discussion at that time seemed to be more on driver less cars rather than the applications we will learn about today. To be frank, I was a little weary of the claims and promises of the IVHS imitative because it seemed a little far fetched to me. However, the research vision of ISTEA has resulted in some very practical innovations which are now referred to as ITS. Although I understand the Intelligent Vehicle Initiative (IVI) is working on some of those “geewiz” gadgetry of IVHS, I am more intrigued by the advances in traffic operations that is now being deployed.

My State of Oklahoma has been on the cutting edge of this technology. As one of the first States in the Nation to implement Electronic Toll Collection (ETC) or the PIKE PASS we in Oklahoma have enjoyed for many years now the convenience of driving through a toll booth instead stopping, waiting in line only to find our you don't either have enough or the right change.

The national 511 initiative is very exciting. As the backbone of a national infrastructure, consumers will be able to get travel information regardless of their location and will not only be able to communicate more easily with emergency personnel, but will be easier to locate in emergency. Certainly this is a very positive development, yet it raises some very troubling concerns, namely privacy, particularly with any tracking or geolocation devices. I hope Christine Johnson, Director, Intelligent Transportation Systems Joint Program Office, U.S. Department of Transportation will be able to give us some level of comfort as to how we can enjoy the benefits of ITS innovation without sacrificing our right to personal privacy.

Oklahoma is at the crossroads of north/south and east/west freight movement. As such I have an interest in hearing how the intermodal logistics and commercial vehicle initiatives are progressing and will be especially interested in learning from Mr. Lawrence Yermack, Chairman of Intelligent Transportation Society of America about commercial applications of ITS technology.

Despite the presence of two major metropolitan cities . . . Tulsa and Oklahoma City, OK is still a rural State and I understand ITS technology has some real safety benefits for smaller communities and sparsely populated areas. I understand Steve Albert from the Western Transportation Institute will discuss rural applications and I look forward to his testimony.

Finally, I understand that Elwyn Tinklenberg, commissioner, Minnesota Department of Transportation will discuss ITS technology from a State level prospective; James Beall, Jr., chairman Santa Clara Board of Supervisors, will provide the local prospective; and Martin Manning, director, Clark County Department of Public Works will discuss how ITS can be used to address problems associated with the rapid population growth.

Again, thank you Mr. Chairman for giving me the opportunity to personally welcome our witnesses and I look forward to hearing what they have to share with us.

Senator REID. I would tell the members of the two panels—we have two panels today. The first is going to have Christine Johnson from the U.S. Department of Transportation; Elwyn Tinklenberg, commissioner of the Minnesota Department of Transportation, here representing the American Association of State Highway and Transportation Officials; and Larry Yermack, the chairman of the Intelligent Transportation Society of America—the first panel.

The second panel will give an update on how the Intelligent Transportation Program is working in specific metropolitan and rural regions. Marty Manning, who is here representing Clark County, NV and the American Public Works Association; Jim Beall is representing the San Francisco Bay Area Metropolitan Transportation Commission; and Steve Albert is here from the Western Transportation Institute at Montana State University.

We look forward to hearing your testimony today, but we have a vote scheduled this afternoon. So we need to be out of here as close to 5 o'clock as we can. So for each of you, let me just say this. Your testimony, of course, is taken down by a court reporter. It is transcribed and available to every Senator. This is the foundation that we're laying for next year's very important transportation bill that we do every 5 years.

We have to have Intelligent Transportation as part of the mix. It's been part of the mix before, but we have to start putting some money there, because we'll hear from Mr. Manning. I mean, people don't know whether to get on the I-15. Is it too busy? You never know until you get on it, and by then it's too late. You can't get off. This is the way it is all over America. We need some simple things to allow people more intelligence as to what, where and how they should go.

So we look forward to your testimony. We would ask each of you to hold your statements to 5 minutes, and then we will ask some questions and go on to the next series of witnesses.

We are going to first hear from you, Mrs. Johnson.

Senator WARNER. Mr. Chairman, if she would yield momentarily. The ranking member of the committee, Mr. Smith, is now on the floor with an amendment to the pending legislation. Otherwise, he would be present, and therefore I ask that his statement be made a part of today's record.

Senator REID. I visited with Senator Smith. I should have mentioned that just before coming over here. His amendment will be voted on this afternoon.

[The prepared statement of Senator Smith follows:]

STATEMENT OF HON. BOB SMITH, U.S. SENATOR FROM THE STATE OF
NEW HAMPSHIRE

Thank you Mr. Chairman for holding this hearing on the Intelligent Transportation Systems Program. I would say that Federal investment in the ITS program over the last 10 years has yielded a large and broad array of research and products. I think it is now time to assess what has been learned, and to better focus the ITS program on putting the effective and successful applications on the ground.

For instance, officials in New Hampshire are interested in several proven ITS applications. One proposal is for variable speed limit signs along I-95 where weather conditions often change the driving conditions. Another application is for remote rural weather information systems. Better weather forecasting is essential to planning personal and commercial vehicle travel and for proper salt application rates where salt is laid before a storm hits to avoid icy road conditions. Finally, with the construction of a traffic operations center, New Hampshire's interstates and turn-

pikes could incorporate traveler information, changeable message signs and incident management systems to improve safety and efficiency on major routes. New Hampshire has none of these systems and very little related infrastructure in place, and with limited transportation funds, the State cannot afford to get started toward the \$30 million cost of these proposals.

Mr. Chairman, I am concerned about the progress of ITS deployment in both metropolitan and rural areas. In the Transportation Equity Act for the 21st Century (TEA-21), Congress directed approximately half of the \$1.3 billion ITS program funding to research and implementation and the other half to specific deployment activities. Less than 10 percent of the research and implementation funds have gone for assistance to States in developing ITS projects. Congress further directed the Secretary of Transportation to competitively award deployment funds to encourage advanced integration of existing ITS systems. Instead, these funds have been earmarked in appropriations bills to fund a variety of ITS activities across the country. ITS projects are also eligible for Federal funding from the States' TEA-21 formula apportionments but must compete with other project needs. With these funding options, ITS deployment has gone from just 6 percent of metropolitan transportation system coverage to only 22 percent coverage. This experience teaches us that neither a discretionary program nor a passive eligibility program will result in significant deployment of ITS applications. I look forward to working with my colleagues during the reauthorization of TEA-21 to restructure the ITS program to get these systems on the ground where they can benefit the traveling public.

Thank you, Mr. Chairman.

STATEMENT OF CHRISTINE JOHNSON, DIRECTOR, INTELLIGENT TRANSPORTATION SYSTEMS JOINT PROGRAM OFFICE, U.S. DEPARTMENT OF TRANSPORTATION, WASHINGTON, DC

Ms. JOHNSON. Mr. Chairman, members of the subcommittee, thank you very much for this opportunity to appear before you today and report on the ITS program. In my written testimony, I have detailed the progress of the four main ITS provisions in TEA-21.

Today, much as you have done, I would like to focus my remarks on the Secretary's own priority of deployment. Secretary Mineta has committed the Department to advancing ITS to the next level, and has stated that during his tenure the benchmark for that success will be deployment. In order for our efforts to be truly successful, the public must know that we are investing our tax dollars in programs that work for them. He has said, "We must deliver the practical, usable transportation systems that can benefit the public today. Deployment is all about delivering the solutions that will provide the public with real transportation alternatives."

So what I would like to do is look at some of the questions that tend to surround ITS deployment. Is it being deployed? Is it going fast enough? Is it making a difference? Finally, one that we often hear, can't we do better than "congestion ahead" signs that we see on our freeways?

As we look across the United States, we see solid evidence that ITS is, in fact, being deployed. Nearly three-quarters of the largest metropolitan areas have ITS deployment underway. There are more than 50 traffic control centers in operation, with many more on the drawing boards. Thirty-one percent of the fixed-route buses have some form of ITS tracking technology; seventy percent of all the toll facilities use ITS for toll collection; and finally, there are now more than 1 million vehicles equipped with ITS crash notification technology.

This deployment is making a difference. I'll give you two examples—one in northern Virginia. We did an evaluation that found if ITS had not been deployed on I-66, we would be experiencing 25 percent worse congestion. The second is in San Jose, where ITS location technology on the paratransit system there has reduced the per-passenger cost nearly 25 percent.

These are but two examples. There are many, many more, and every year we take evaluations of these kinds of projects and catalogue them in an annual report that we would be willing to submit for the record.

The question is: Is this level of deployment enough? The Secretary says no. Very few States or metropolitan areas have a complete system in place. Over the last decade, we have moved from about 6 percent of our major metropolitan areas being instrumented, to about 22 percent today. Hence, we don't have enough information about what is happening on the road to say much more than "congestion ahead."

I don't know that we would be terribly comfortable with having an air traffic control system, for example, that only had 22 percent radar coverage. Yet, that is what we are dealing with on the surface transportation system. By contrast, in Paris, they offer on overhead signs and other media, very detailed information on travel time and alternative routes.

Although Intelligent Transportation Systems are eligible for most Federal aid funding categories, these projects are competing with traditional construction needs for available funds. Most State DOTs do not have a primary mission of operating the system in the same way that they recognize a mission of constructing or maintaining the physical infrastructure. If funds are limited, as they often are, the primary mission of physical infrastructure, either construction or renewal, will tend to take priority.

Indeed, we have begun to realize that no institution has congestion management as a primary mission, except on those rare occasions when a special event such as the Olympics or another large special event comes to town. Except for those special events, no one has enough of a stake in the daily performance of the system to insist on a level of ITS deployment that would enable operating the system at its peak performance.

If we are going to move to the next level of deployment, as Secretary Mineta has called for, it will require us to do more than fit ITS into the existing funding mechanisms, into the existing institutional structures, or into the existing regulations. It will require us to transcend the existing transportation culture that has been created around constructing projects, and to develop a new culture that is focused on the performance of the system, the way the customer actually experiences that performance—door-to-door—regardless of who owns the road, regardless of who owns the bus, regardless of who owns the parking lot.

In closing, I thank you again for this opportunity to address where we are going in the ITS program, and what things we need to do.

I am happy to answer any questions that you may have.

Senator REID. We look forward to working with the Secretary on our new bill next year. Let me just say this—I was just handed

this. Nevada's largest newspaper has an e-briefing they put out by a man by the name of Steve Sebelius. Here's what he says today: "The Subcommittee on Transportation of the Senate's Environment and Public Works Committee today will hold a hearing chaired by our own U.S. Senator Harry Reid on Intelligent Transportation Systems. The systems use technology to reduce congestion on highways, and that's something we all need, especially after this morning's little-stroll-through-hell commute, in which cars on the Summerlin Parkway were backed up to Rampart Boulevard. Clark County Public Works Chief Marty Manning will testify at this hearing."

Mr. Tinklenberg, please proceed.

**STATEMENT OF ELWYN TINKLENBERG, COMMISSIONER,
MINNESOTA DEPARTMENT OF TRANSPORTATION, ST. PAUL,
MN**

Mr. TINKLENBERG. Thank you, Mr. Chairman and members.

My name is Elwyn Tinklenberg. I am the commissioner of the Minnesota Department of Transportation, and chair of the Advanced Transportation System Subcommittee of AASHTO. Thank you for this opportunity to share with you a major transportation success story—the progress made in deploying ITS. My written testimony, which I request be made part of the record, details the ITS benefits that have resulted from your vision and foresight in including ITS as a key component of our Federal highway and transit programs.

I can speak from personal experience in Minnesota when I say that ITS deployments have made significant improvements in rural, urban, transit and commercial vehicle applications. Not only that, they have produced new partnerships never before envisioned, transferred advanced technology from NASA and the defense industries, and enabled us to stretch the use of our transportation systems in new ways.

We will have to stretch to accommodate the travel needs of another 100 million people over the next 40 years, as well as the doubling in freight volumes over the next 20 years. ITS technologies have already proven their effectiveness in improving our operations, while increasing our safety. In the Twin Cities, adaptive signal systems, combined with ramp metering, have improved freeway travel time 22 percent, reduced crashes by 24 percent, and improved freeway throughput by 14 percent. Use of our road/weather information system provides motorists with real-time information and improves winter maintenance, significantly reducing accidents on highways and bridges. A computer-aided dispatching system for emergency vehicles is saving lives.

Those kinds of successes are mirrored across the Nation. E-Zpass electronic toll collections are saving both money and time. Incident management systems are reducing travel delays by up to 2 million hours per year. Automated crash notification, or Mayday systems, means safer travel. Reduced delay and congestion also mean cleaner air.

Transit systems benefit from ITS through the use of automatic vehicle locators, scheduling software, and automatic dispatching. From Transportation Management Centers to the cooperative de-

velopment of 511 traveler information deployment, ITS has fostered unique and effective partnerships between Federal, State and local agencies, industry and national associations such as AASHTO.

Is the picture all rosy? I would have to say, not completely. Of the 75 largest urban areas in the country, 24 have a high level of integrated ITS tools. Twenty-two percent of their freeways have real-time data collection. Thirty-one percent of their transit facilities have vehicle locator technology.

The progress is substantial, but there is much to achieve. ITS technology is a key component of a new focus on transportation systems operation, and will be highlighted at the upcoming National Summit on Operations this October 16–18.

As we look to the future, there is a vital need for continuing a strong Federal presence in a number of areas. First, research and operational testing is needed for priorities such as crash avoidance technology, advanced transportation system management, vehicle monitoring and enhanced data collection. Second, training and technology-sharing is essential to develop the skilled technical workforce needed at the State and local levels. Third, looking to the next generation of ITS, the development of open, flexible and uniform standards by associations such as AASHTO is required to ensure systems will be integrated and easy to use. Fourth, continued funding of an ITS deployment category will stimulate the use and integration of new technologies that might otherwise not be tried. Finally, we need to simplify project approvals and find solutions to administrative, regulatory or statutory hurdles that can slow down deployment.

In the last 10 years, ITS has turned the corner from a vision to a reality, and has demonstrated its powerful potential for transforming our transportation system.

Mr. Chairman, I would be pleased to answer any questions you may have at the conclusion of the hearing.

Thank you.

Senator REID. Mr. Yermack.

STATEMENT OF LARRY YERMACK, CHAIRMAN, INTELLIGENT TRANSPORTATION SOCIETY OF AMERICA, WASHINGTON, DC

Mr. YERMACK. Chairman Reid, Senator Warner, thanks for the opportunity to discuss the Intelligent Transportation Systems with you today.

My name is Larry Yermack. I'm the chairman of the board of the Intelligent Transportation Society of America, a not-for-profit 501(c)(3) organization with over 600 members, including State Departments of Transportation, other associations, not-for-profits, and private companies. ITS America is the Federal Advisory Committee to the U.S. Department of Transportation, dedicated solely to intelligent transportation systems. I also serve as the president of PB Farradyne, a transportation engineering company.

My message to you today is this. The significant investment that the Federal Government has made in ITS has been money well spent, delivering significant benefits to the American people. Not only is travel safer and more efficient, but the ITS program has also laid a foundation for an explosion in consumer-oriented tech-

nologies. To date, 55 of the largest 75 metropolitan areas have met the goal of medium-to-high deployment of ITS. Traffic Management Centers have been established in two-thirds of the areas, monitoring freeway traffic and providing early notification of incidents. Over 384 public transit systems nationwide have installed or are installing components of ITS to provide the public with safer and more effective public transportation.

Computer-aided dispatch has been installed in 67 percent of the emergency management vehicles, and 36 percent have in-vehicle route guidance. Telematics devices, advanced in-vehicle communications technologies, allow for automated crash notification, remote diagnostics and a variety of mobile commerce applications. Onstar, one of the more recognized telematics brand names, currently has 1.2 million subscribers. Eight million cars worldwide have been equipped with navigation units.

The trucking industry has begun to adopt three ITS technologies in an attempt to enhance the safety, efficiency and productivity of the movement of goods on America's roads: transponders, Commercial Vehicle Information Systems and Networks, otherwise known as CVISN, and intelligent vehicle technologies for heavy trucks.

Transponders have the ability to monitor drivers, vehicles and loads to ensure safe and efficient trucking operations. The goal is the deployment of a single, multi-purpose transponder that can handle toll payment, weigh in motion, credentialling and other applications.

Currently, 30 States use transponders to pre-clear trucks through roadside inspections. The Federal Commercial Vehicle Information Systems and Networks architecture provides a uniform framework for electronic credentialling. Thirty-four States are in the process of initiating CVISN, and eight States have completed the initiation, resulting in a 75 percent reduction in the current cost of credential administration for both the States and industry. Intelligent vehicle devices for heavy trucks such as rollover and collision warning systems continue to make trucking safer.

The benefits of ITS are abundantly evident, and ITS infrastructure results in a smoother traffic flow and fewer stops, which enhances safety by providing less speed variance and fewer opportunities for crashes. Ramp metering alone has been proven to reduce crashes by up to 50 percent. Road/weather information systems have proven effective at lowering speeds and increasing safety during adverse driving conditions. Adaptive signal controls and incident management programs have significantly reduced traffic delays, while Traffic Management Centers collect data on accidents and road conditions advance traveler information systems deliver this information directly to the driver and empower drivers to make optimum route selection and shorten travel time.

ITS also helps to protect the environment by reducing the negative environmental impacts of congestion, crashes and emissions. It has been estimated that incident response and clearing programs save as much as 2,600 gallons of gas per major incident.

In the future, the initial investment in ITS infrastructure and in-vehicle devices may be seen as the first wave of a technology revolution. In the second wave of the ITS technology revolution, we ex-

pect to see the integration of localized Intelligent Transportation Systems into larger and more integrated networks of information.

Communications from vehicle to infrastructure and from infrastructure to vehicle will become richer. Both the quality and quantity of data transmission will increase. As a result of network integration, not only will we see greater efficiencies in America's transportation system, we will see a fundamental shift in how America does business.

GPS and other vehicle-identifying technologies inherent in ITS are already enabling businesses to offer consumers location-specific goods and services. The advent of mobile commerce will be a part of the fundamental shift in how Americans do business through the use of ITS.

We look forward to working with you to design a continuing ITS program that will fulfill the dreams of the American traveling public.

Thank you.

Senator REID. Mr. Yermack, you say there are 8 million navigation units on vehicles? Is that right?

Mr. YERMACK. That's worldwide.

Senator REID. Worldwide.

The last car I purchased, they tried to talk me into buying one of those. What in the world good would it do me to have that on a car?

Mr. YERMACK. I have, from my own experience, used them very often on rental cars. I find that in traveling to areas I'm not familiar with, it's a tremendous boon because what a navigation system will do is it will identify, when you put in where you are and where you're going, it will identify a route. It will display the route on the navigation system, and it will give you directions to the location, both verbally through speakers, as well as on the screen.

I've also used it in areas that I'm familiar, and I find that simply having the map up on the screen as I travel makes it a lot easier to know where I'm going.

Senator REID. Now, you carry it with you wherever you go, so to speak? Rental cars don't have it on them when you get the rental car.

Mr. YERMACK. There are navigation systems available from some rental companies as an additional fee.

Senator REID. So you try to get that?

Mr. YERMACK. I always try to get that.

Senator REID. OK. That's very interesting. That helps me a lot. I didn't see the practicality of it, but I can see your explanation makes it quite clear.

Your organization's membership includes many private companies. Which areas of ITS have the highest levels of private sector participation?

Mr. YERMACK. It's hard to answer the question as to which have the highest levels of participation. Members of ITS America are involved in the engineering and design of intelligent transportation systems for Government, for State Departments of Transportation, as well as for public transit agencies, as well as our members include the vehicle manufacturers—Ford, General Motors, Chrysler—

so they're also involved in the deployment of in-vehicle equipment on their vehicles.

Senator REID. I have a couple of other questions I'll submit to you in writing. Would you mind getting back to us—the subcommittee—with those answers?

Mr. YERMACK. It would be our pleasure. Thank you, sir.

Senator REID. I appreciate it.

Mr. Tinklenberg, are there new technologies or other tools in the pipeline that will radically, in your opinion, improve the impact of ITS on managing traffic congestion?

Mr. TINKLENBERG. Mr. Chairman, there are a number of areas of technology development that hold potential. But we think that the emphasis that you have placed on deployment is an emphasis that has served the industry and the advancement of ITS very well in taking those things that we know work already and getting them out into the systems, and supporting a deployment effort of those things.

In Minnesota, for example—maybe some of you have heard—not too long ago, a shut-down of our entire ramp metering system, and we have an extensive ramp metering system in the Twin Cities. When we shut that down, we were able to test in a very comprehensive way what the benefits were of that system. We found the statistics that I mentioned in my testimony, that in terms of travel time, in terms of capacity, in terms of crashes, those things that already exist were working very well and making an incredible impact when integrated through a Traffic Management Center—that kind of technology. What we need to be doing is deploying it—things that we already have in place, getting them out into the system where they can have the kind of impact that we believe they could.

Senator REID. I have a view that when we do our next highway bill, as we refer to it, that we're going to have to do things different than we've ever done it in the past; have a different mix of moneys, incentives, because we are limited how much money we can spend building roads. But I'm concerned, and this is what I would like either you or Ms. Johnson to respond to this, I'm concerned that the directors of most State Departments of Transportation, so I'm told, are only concerned about highway dollars. You know, that's kind of a niche in the barrel of their gun—I should say, it wouldn't be in the barrel.

Senator WARNER. The stock.

Senator REID. Yes, stock. That's what I was trying to find, John. Thank you.

As to how much money they can get for road construction—how are we going to change the mind-set of some of the State Departments of Transportation to be involved in other things? If we do this right, it's going to cost money. It's not cheap to do what we want to do. But when highway departments want to spend more money on roads, how do we convince them that they could do better?

Mr. TINKLENBERG. Mr. Chairman, I think that's a very important discussion that's going on right now within the industry as a whole. We have been very involved with the U.S. Department of

Transportation to look at operations, and I know you'll be looking more at that as you move toward reauthorization.

But moving from the question of "How is this project going?" to "How is the system operating?" and "How is it working for the public?"—I think that discussion is taking place as more and more people are seeing the clear benefits. Again, when it was just a research project, people were wondering what good does it really do for me in moving people in my State. But now we're seeing that it really does some important things, as we have seen in Minnesota in our ramp metering program and in our road/weather information systems, and as we're seeing as we're moving toward the deployment of 511 and advance traveler information systems.

I think as those experiences become more widely understood, people will begin to see how much capacity can be gained by these kind of investments and then are able to make good choices in comparison to other investments they might make.

Clearly, a part of the solution is going to be infrastructure in terms of the traditional sense. But more and more, I think people are understanding that another part is going to be investments in the use of technology that can expand the capacity of our infrastructure without having to take more homes, without having to take more businesses, without having to pour more concrete.

Senator REID. So as I understand it, what you've said is ISTEA, we had money for research on Intelligent Transportation Systems. TEA-21, we implemented a few of them—not much money was spent on this—but a few dollars spent. What you're saying, with the few dollars we've spent in TEA-21, this may be an incentive for State Departments of Transportation to realize that they can do a lot better job in their States by having a mix of not only construction dollars for regular highway construction, put some of their construction money into these Intelligent Transportation Systems. Is that what you're saying?

Mr. TINKLENBERG. Absolutely, Mr. Chairman. I believe that we've demonstrated some of the practical benefit that can be gained by these kind of investments. I think that was a huge accomplishment of TEA-21. And now we have the basis on which to build from that into further deployment of these kind of technologies.

Senator REID. Do the other two witnesses have any comments in this regard?

Ms. JOHNSON. I think from our observation there are two points of leverage that you should be considering in going into the next reauthorization. The first one is what I would call an information system or an ITS network, in the sense that underlying almost everything we do in ITS you've got to be able to know what is going on on the road or on the bus. While we have put pieces in place in many, many places across the United States, when you look at it as a network, we're only about 22 percent instrumented.

Getting a complete system that can tell you what is going on on the roadway or on the bus system, I think is essential to achieving the vision we all share.

The second point of leverage would be institutions. ITS adds a mission that we have never had traditionally, and that is operating the system. We do not have institutions that bring the players to-

gether to execute that mission. So worrying about building an institution with a mission of operating the system, I think will be an important point of leverage.

Mr. YERMACK. Mr. Chairman, as late as the late 1990s, I continually heard the debate. We have all these computers, why do we still have so much paper? In fact, at that time we were at a stage of pre-network. The computers were not networked together in what we now know as the Internet. We haven't heard that question for the last 10 years about what are these computers doing for us. We know the instant access to information that it gets us and the communication that it gets us.

I think we're at a similar stage with Intelligent Transportation Systems in the sense that we have many isolated examples of ITS systems that work and work very effectively. We don't really know. We don't have an experience of how effective they can be as they become inter-networked and when the operators begin to gather information not just on one city or one part of the city, but on entire regions and States and multi-State areas. It would have a dramatic impact on the operations of the system.

Senator REID. Thank you.

Dr. Johnson, last year, the Federal Communications Commission approved 511 as a nationwide telephone number for traveler information. What's the department's timeframe for implementing this number?

Ms. JOHNSON. The FCC has given us a timeframe which is 5 years. They're going to review what we have done with this incredibly valuable resource.

Senator REID. Five years from when?

Ms. JOHNSON. Excuse me?

Senator REID. When is the 5 years up?

Ms. JOHNSON. My belief would be about 4 years from now. We have already had the first 511 telephone call, in the Cincinnati-Northern Kentucky metropolitan area. That will be followed by four more early deployment sites. We are providing grants to States to do the transition planning that is needed to kind of carve up the States in a way that allows them to work with the wireless community on routing calls and that type of thing.

Right now, ITS America, APTA and AASHTO under the chairmanship of Mr. Tinklenberg are putting together a set of guidelines that will go out to States and localities on essentially how to do this. We look at this as a very popular service that will be demanded by the citizens.

Senator REID. Thank you very much.

Senator WARNER.

Senator WARNER. Mr. Chairman, you just brought up the key question. What can we do to incentivize more application of this technology? I've only got fragments of the story, but staff advises me that while we have put out under TEA-21 certain amounts of money for these programs, the appropriators—somehow there's some earmarking going on and the projects don't exactly parallel the goals of ITS. Am I correct in that, Dr. Johnson?

Ms. JOHNSON. In TEA-21, you laid out a set of criteria that were to be followed with this set of money.

Senator WARNER. That's correct. I've got them right here in front of me.

Ms. JOHNSON. The primary purpose was for integration. It was essentially to serve as a bridge between a research program, and ultimately using Federal-aid funds to use ITS. Every dollar, and sometimes more, that was authorized has been earmarked. To date—and there's some question this year—but to date, we have been successful in working with each earmark in requiring them to meet the criteria set forth in TEA-21. While we think the program would have been substantially more effective in leveraging more deployment if it had not been earmarked, we believe that those projects that have been funded have achieved the goals of the authorized program.

Senator WARNER. Your answer is skillfully given, but clearly I think the chairman and I and others have some homework to do with our highly esteemed colleagues on another committee.

But, I believe as we address—as the chairman pointed out—the next item here, we've got to put in a stronger and more rigid set of incentives to help get this force multiplier out to the public. I hope that other segments of the highway industry—I mean, the builders are among the most responsible, really, in my State. I have a high personal regard for them. I just don't think they should view this as a threat to putting down more concrete and asphalt. I know members of the local governing bodies in my State, whether it's the cities or the counties, want to point to “that's my road.” But I think legislators can point with equal pride to “that's my system” and that road is now far more efficient than it was before we put in this system.

So anyway, we've got to work on that.

Mr. Yermack, a question—I have followed with great interest—and I don't doubt that Congress is going to look into this legitimate debate on cell phones, and whether or not it distracts. The chairman asked you about the navigation equipment. I think that's a first cousin to the cell phone issue, and we better be prepared to address it.

But I'd like to also bring to your attention one other thing, and this applies to everybody here. I deal a great deal with senior citizens—I'm not too far distant from being one myself—but, you know, I'm still active, fully. But they talk about when they, for instance on the Dulles Highway, are rushed into these chutes to pay their tolls or to put their Smart Tag in, or to do other things. They've got a microsecond to make a decision which lane they go in. Sometimes it's not clear visually to help these folks, particularly strangers, get in. You hear the screech of wheels and brakes and everything as people suddenly realize they're trapped in the wrong lane. Let's help out a little bit in that system.

Do you want to comment on the cell phone thing? Is that a first cousin? Do you want to say a few words on that?

Mr. YERMACK. I'd be happy to, sir. I think that the cell phone debate in many ways highlights an issue that we have been living with for a long time, and that is the issue of keeping drivers focused on their job and not having them distracted by other devices in the car. While the cell phone debate is the latest in the list of issues that provide distraction, I think really changing the station

on a radio or being distracted by a baby in the backseat, or changing a CD can be equally distracting. I think finally we are now beginning to get a significant amount of research being done by the members of ITS America and by the automobile companies to determine what, in fact, are the effects of those devices on driver reflex.

Senator WARNER. OK. We've got to concentrate on that. You know, your passenger conversation, or all kinds of things that begin to build and add up. I think your area here is so key to greater utilization of our roadways that we've got to somehow meet, address and resolve that dispute in a very responsible way.

Mr. Tinklenberg, first, AASHTO has just been of great value to this committee and those of us who have been active in highway legislation for years. You're fortunate to be associated with such a marvelous group of advisers. But do you have a comment on the incentives—what we might do, start working on?

Mr. TINKLENBERG. I think, Mr. Chairman, Senator, I think as Dr. Johnson indicated, that there are a number of things in terms of bringing the institutional support together to look at operational issues within an entire region. I'm sure our region is like many others in the country, that there are many governmental units operating different pieces of the system, and somehow bringing them together in a way that maximizes the opportunities on all of that is an important one.

It's interesting, Mr. Chairman, you raised the issue of 511 a moment ago. One of the side things that's happening with the development of 511 is that as the public begins to be more familiar with that system and use it more often, they're going to be expecting that that information will be available in their State and in their region. They're going to be asking why it isn't if it isn't. Part of our deployment is going to be driven by the public's expectation that good information be available.

Senator WARNER. You're right on target. I think the best leverage we can get is to get the general public to talk to their State legislators and a few others. But Mr. Chairman, I think to expedite things, I'll put the rest of my questions in, if I may, for the record.

Senator REID. I will do the same.

Senator WARNER. I thank the chair. This is an excellent hearing. I think you're achieving your goals.

Senator REID. Thank you, Senator Warner.

This panel is excused. Thank you very much for your time and effort.

Our first witness in the second panel is James Beall, San Francisco Bay Area Metropolitan Transportation Commission. Mr. Beall, as soon as they get a seat there for you.

STATEMENT OF JAMES BEALL, JR., CHAIRMAN, SANTA CLARA BOARD OF SUPERVISORS, SAN FRANCISCO BAY AREA METROPOLITAN TRANSPORTATION COMMISSION, SAN JOSE, CA

Mr. BEALL. Good afternoon, Mr. Chairman. My name is Jim Beall, and I've been a commissioner for the Bay Area Metropolitan Transportation Commission for about 15 years, and currently am chairman of the Santa Clara County Board of Supervisors in San Jose.

The Metropolitan Transportation Commission is the metropolitan planning organization for the nine-county Bay Area. We have 6.8 million people in our 9 counties and 100 cities, and 7,000 square miles including San Francisco, San Jose and Oakland.

I want to talk today about some of the things we're doing in our area. The first example I wanted to bring to your attention is in Santa Clara County—my county—we have a multi-agency team led by the city of San Jose and the county, and we're working to coordinate the "Smart Corridor" along freeways, expressways, local streets, with public transit in a 15-mile corridor. We're having fiber-optic cables carrying data, video images, traffic signals, cameras and computers into a single network, enabling our traffic managers to spot accidents, congestion, changed timing patterns, instantaneously alert drivers to problems, and dispatch emergency services.

We have also in the Bay Area implemented fast-track electronic toll collection on all Bay Area toll bridges, and that's nine bridges, to let drivers pre-pay tolls without stopping, and they can use the same device in southern California toll roads 500 miles away.

In the Bay Area, we have also installed roadway detectors and closed-circuit televisions to collect up-to-date minute data on what's happening on our roads. The Bay Area Traffic Management Center uses these high-tech tools to monitor traffic conditions and dispatch help as needed. We also use that for coordination of special events in the Bay Area.

Some of the examples of results in the transit area include what we have now have instituted in the Bay Area a test. We're starting to implement the one car TransLink card. This is a smart card to pay their bus, train, ferry fare under a pilot program coordinated with 21 separate transit agencies, so one card for all 21 transit agencies in the Bay Area. The universal transit ticket stores the value and deducts the cost of a trip when the card is passed near a reader on board the vehicles or at fare gates.

The Bay Area also, as you mentioned earlier, the Bay Area is also involved in—we have a single region-wide phone number for up-to-date traffic information on the freeways, as well as direct connections to all the public transit operators, ride sharing and other services. MTC is implementing the effort in the Bay Area to become the first region in California to offer this service through the national designated transit information number, the 511. So we're leading the charge on that.

What are the results? Well, the California Department of Transportation estimates the travel time savings of over 25,000 hours per year, and fuel savings of more than 55,000 gallons during the initial phase of the electronic toll collection system that is now in place on all nine Bay Area toll bridges. Each month in the Bay Area, 50,000 Bay Area residents call our TravInfo—the regional transportation information phone number—for traffic, public transit and travel information.

A survey evaluating the service indicate that 45 percent of the callers change their travel behavior after receiving the information. Also, more than 10,000 Bay Area drivers per month use one of the 3,500 wireless telephone call boxes installed by MTC along the region's highways. The call boxes are a direct line to dispatchers who

can then send the police, fire, paramedics, towing or other assistance.

We have our roving tow trucks, the Freeway Service Patrol, that MTC operates, and this covers 400 miles of Bay Area freeways. We respond to 9,000 incidents per month. In addition, increasing the travelers' safety and reducing air pollution, the tow trucks cut congestion-related delay by 3.5 million hours and fuel consumption by 1.4 million gallons annually.

Mr. Chairman, as you can see, we think that TEA-21 is working in the San Francisco Bay Area. It is important to note that our Bay Area ITS programs have been funded by the flexible features you have in TEA-21, and we encourage continued mainstreaming for such projects as a further commitment by the Federal Transportation Policy to better manage the transportation system we have.

Our experience with the ITS confirms that we believe that the Federal initiative in sponsoring a national ITS program was a far-sighted move and will continue to pay positive dividends far into the future. We urge you to renew the national commitment.

We have the attachment. We have the packet and the information, and I'd be happy to answer questions—along with my staff who has come with me, Melody Crody. She is the manager of our Transportation Coordination and Access Program at MTC.

Thank you for your time, Senator.

Senator REID. Mr. Beall, if we accomplish nothing else today in listening to your statement it would have been worth the hearing, because it gives us as legislators the incentive to work more on this idea that started out as kind of an idea that Pat Moynihan had, and people kind of laughed at him when he first talked about it. I certainly wish Senator Moynihan were here to hear what you had to say, because it certainly to me indicates that we have made some progress and can make a lot more progress.

Mr. Manning.

STATEMENT OF MARTIN MANNING, DIRECTOR, CLARK COUNTY DEPARTMENT OF PUBLIC WORKS, LAS VEGAS, NV

Mr. MANNING. Senator Reid, thank you very much for allowing me to be here today in front of your subcommittee.

I am Marty Manning and I'm the president-elect of the American Public Works Association, as well as the Public Works Director for Clark County, NV.

My comments are going to be about as brief as I can make them, and basically the things I'm here to talk about today is a little bit about—

Senator REID. You never have a bad speech if it's short, you know.

Mr. MANNING. Yes, sir.

I'm going to talk a little bit about the American Public Works Association, and certainly the kinds of experiences that we've had with ITS in Clark County, which have been very positive.

Our association, APWA, serves more than 26,000 members, and it is concerned with the operation, maintenance, renewal and improvement of the Nation's infrastructure by promoting professional excellent and public awareness through education, advocacy and the exchange of knowledge. We have a vital interest in the reau-

thorization of TEA-21, and in fact, we have a reauthorization task force currently in place that is working diligently to develop and promote some APWA recommendations for reauthorization.

Additionally, APWA is teamed up with other organizations to comprise a local officials transportation working group, which is made up of organizations representing elected county and city officials, as well as development organizations, technology and city/county managers. APWA also serves as a member of the steering committee for the Federal Highway Administration's national dialogue on operations.

We hope that you will look to APWA as a valuable resource as you and your staff members proceed through the reauthorization process. With so many unmet transportation funding needs, APWA believes that it is imperative to maintain the basic goals of TEA-21 by protecting the funding firewalls and allowing for as much local funding flexibility as it is possible to give.

Further, as our members deal directly on a daily basis with system users, we have a strong understanding of how it is to best address some of our local problems in transportation issues within our communities. The deployment of ITS tools, in conjunction with the construction of needed improvements, would assure that existing transportation infrastructure may operate at higher capacity and that new improvements would also operate more efficiently, and also to be more economical to build.

As you know, Clark County is one of the most rapidly growing areas in the Nation. We've come to expect new residents at a rate of 3-5,000 a month, and we also expect to welcome the arrival of as many as 35 million visitors this year to the Las Vegas destination resort areas.

This continuing growth puts a lot of pressure on our transportation systems—our networks of highways, streets and roads. In Clark County, NV, we're becoming true advocates of the management tool products that ITS offers, and the capacity and safety benefits that they represent to us. Existing intelligent transportation systems are being improved and integrated with new system tools that are now being installed. The installation of ITS products in the urbanized Las Vegas Valley has only been possible—and this is important to us—by the creation of hard, real, meaningful partnerships among Federal, State, local governments, as well as our private sector partners.

As an example, the Las Vegas-Area Computer Traffic System provides computerized traffic signal control in all of the jurisdictions in the Las Vegas Valley. The system is operating under an agreement among the Nevada Department of Transportation, our Southern Nevada Regional Transportation Commission. Our three incorporated cities in the county provide substantial travel time improvements through a growing urbanized area with a population approaching 1.4 million people. It also has provided some significant real benefits in air quality.

While our system was originally installed with a Federal grant and NDOT assistance, the incorporated cities in the country pay for its continued operation and maintenance. The Las Vegas-Area Computer Traffic System was an initial step into ITS for us, but recently, further steps are now underway. Additional improve-

ments to the system have been added which provide new computer hardware and software, high-speed telecommunications facilities between our traffic signals and our computers, television observation at critical intersections, and high-tech local traffic signal controllers.

In addition, the Nevada Department of Transportation is proceeding on additional ITS projects to create a highway management system that will provide the functions of traffic control, incident management and route and pre-trip traveler information, and a user service for archived data. The highway management system is called FAST and it will be integrated with the arterial management system under the Las Vegas-Area Computer Traffic System, and they will both be located at a common location that is going to be shared with the Nevada Highway Patrol's dispatching center.

So we're bringing the pieces together to make a management system. Each system will operate with a common staff and an operating agreement among, again, NDOT, the Regional Transportation Commission, our three cities and the county.

Construction of this, the initial phase of the FAST highway management system is going to begin before the end of this year, and it will be completed in 2 years. The construction will encompass the installation of ramp meters at selected locations, as well as high-occupancy vehicle bypass ramps, arrangements with the Nevada Highway Department to make sure that traffic enforcement secures those things, a dynamic message signage at selected locations to provide road information and incident information to motorists, and the construction of an arterial and highway management operations center which will bring all of those agencies together. Upon completion of the project, the Las Vegas urban area will be well on the way to the creation of an integrated arterial and highway management system.

As a county public works director, I can appreciate the value that ITS brings to us. The management tools and technologies we've already installed and the potential values in the extension of this management system will provide real system improvements in our area.

In conclusion, we recommend the continued support of the ITS program, and certainly the recognition of its value in identifying and developing transportation system management technologies that we think are needed to improve the capacity and efficiency of the Nation's highways, our roads and our streets. In addition, we recommend that the overall goals of promoting safety, efficiency and economy and enhancing mobility, providing accessibility to transportation, as well as improving the productivity of travel, the safeguarding of the environment and reducing energy consumption certainly are a very solid basis for the development of the ITS program of the future.

That concludes my remarks, but I have a couple of other things to say, Senator Reid.

Senator REID. We'll have to have you say that a little later, OK?

Mr. Albert, it's your time to testify. Do you teach at the University of Montana?

Mr. ALBERT. I teach, but I direct a research center there.

Senator REID. But also part of your duties are teaching?

Mr. ALBERT. Correct.

Senator REID. I was reading your resume, and I couldn't determine that. I saw you were associated with Montana State, but I didn't know if you taught also.

Please proceed.

**STATEMENT OF STEVE ALBERT, DIRECTOR, WESTERN
TRANSPORTATION INSTITUTE, BOZEMAN, MT**

Mr. ALBERT. Good afternoon, Chairman Reid.

I'd like to begin by thanking you for this opportunity to share our views and perspectives on Intelligent Transportation Systems, and specifically rural ITS, which is quite often overlooked.

My name is Steve Albert. I'm the director of the Western Transportation Institute at Montana State University. WTI's mission is to make rural travel and transportation safer, more convenient and more accessible. WTI is the Nation's leading research center focusing on rural transportation issues, with projects in over 30 States, 10 national parks, and WTI was recognized by ITS America for outstanding achievement in rural ITS.

In addition to serving as WTI's director, I also serve as the Rocky Mountain ITS America Chapter president and various National Academy of Sciences positions.

My testimony today was developed in partnership with constituents from around the country, not just from one organization, and I will address the following three areas: the magnitude and severity of rural transportation challenges, specific examples and benefits of ITS deployment, and future focus areas where additional emphasis and resources should be placed.

For the last 10 years, rural constituents have heard our transportation leaders highlight congestion as our Nation's leading challenge. Programs such as Operation Timesaver, Model Deployment Initiative and other urban initiatives have been the showcase of administrations. However, these showcase programs have little, if any, application to approximately 80 percent of our Nation's roadways, or roughly 4 million miles. Unlike urban areas that have congestion as a primary single issue, rural needs are more diverse, complex and only tangentially related to congestion.

So what are some of those rural statistics? Sixty percent of the fatal crashes happen in rural America. Crash rates are 2.5 times greater in rural America. Local roads are three times less safe than our Interstate system. Limited communication coverage, specifically wireless, causes notification to be twice as great as urban areas. Weather is a deadly factor in rural America. Tourism is our economic engine. National parks, which get 266 million visitors a year, are expected to increase by 500 percent over the next 40 years. Native Americans die at six times the national average in motor vehicle crashes. Animal-vehicle collisions, which are about 726,000 each year, cost \$2,000 each, or about \$1 billion being wasted in annual expenditures. Thirty-eight percent of our rural population has no transit service.

While these statistics do paint a picture, there are some success stories in rural ITS, and I'd like to go through a couple of those examples. To prevent crashes, the Colorado Department of Transportation has implemented a downhill speed advisory system that

advises truckers outside the I-70 Eisenhower Tunnel outside Denver of the appropriate speed they should be going based on axle configurations, speed and weight. It has reduced travel speeds of trucks by 20 miles an hour and eliminated fatalities the last 3 years. California DOT has a similar system.

To respond to emergency services, the Virginia Department of Transportation has used hand-held portable digital assistance to transfer patient care information between ambulance drivers and the doctors so that we can do a better job of responding to patient care.

To enhance travel and tourism, Yellowstone National Park is implementing a Smart Pass system similar to what you heard today in San Francisco, that will allow for frequent users to have a transponder on their vehicle and be enter and bypass gate congestion.

Surface transportation and weather—what are we doing? Through the Greater Yellowstone Travel and Weather Information System, North Dakota, South Dakota, Montana and Minnesota are implementing one system that will allow travelers to call in and hit pound-safe on their cellular phone and get weather information on the road that they're on 60 miles in advance, or 1 to 1½ hours that will give them specific information about what they're about to encounter.

So what are some of the future needs, even though we have some success stories? One of the things that we are beginning to realize in rural America and that needs to be spread around the country is that the highest use is not necessarily the highest need.

Some of the things that we see that are really a need is to conduct additional outreach, to have rural stakeholders understand what does ITS mean to them; what are the benefits; integrate funding across Federal and State agencies. Rural transportation is really much more than just transportation. What we commonly find is that Federal and State agencies are stovepiped. Health and Human Services only look at their issues. DOTs only look at their issues. But when you look at transportation, it goes across those agencies. A blue ribbon committee needs to be looked at to address how do we create a one-stop shopping for rural transportation.

Improved communication coverage—response times are twice as great in rural areas. We need to have better cellular communication and some basic level of detection on our roadways. Develop projects that are more multi-State in nature. Travelers do not care about jurisdictional boundaries. What they want is information on multi-State opportunities. Create a rural model deployment initiative that while similar to the metropolitan initiative, but make it on multi-State basis; identify tourism opportunities, given that tourism means jobs in rural America. It's the economic engine. Work closer with tourism organizations.

In closing, while there are isolated success stories that can be highlighted, there are still many challenges yet to be addressed. In keeping with the rural spirit, the subcommittee and the U.S. Department of Transportation have the opportunity to become pioneers in making a renewed commitment to rural ITS. As we like to say in the West, our forefathers are pioneers, not settlers.

Senator REID. Mr. Albert, the point is that the people that are injured and killed on rural highways are not necessarily people who live in rural America.

Mr. ALBERT. That's correct, especially when you look at truckers.

Senator REID. I think that's a point we have to make. So improving the Intelligent Transportation Systems in rural America helps us all, not just those who live in rural America.

You had something more you wanted to say, Martin?

Mr. MANNING. I just had some observations, Senator Reid, and that is that we wanted to be able to express our appreciation for the direct help that you've provided us for our Smart Bus program.

Senator REID. Don't be spreading all that stuff around here, you know, all the stuff I've—

Mr. MANNING. In addition Senator, you'll be happy to know that the bus rapid transit demonstration now has five CIVUS buses under order.

Senator REID. You see, what you need to do is tell everybody that's at home, but not back here.

Mr. MANNING. OK.

Senator REID. I'm only kidding.

[Laughter.]

Mr. MANNING. These are really kind of wonderful because it gives us an opportunity to have transit vehicles that have a very good chance with some preemption of signals of being able to go down an advanced guidance system and to be able to preempt signals and actually deliver people to the places that they want to go before vehicular traffic does. They have the capacity of carrying as many as 178 people.

Then finally, I wanted to thank you personally for the very successful transportation summit that you sponsored. We appreciated very much the opportunity of joining with other officials to be able to address the question of transportation needs and priorities in the Silver State. We appreciate the leadership that you really demonstrated in putting that together.

Senator REID. We have all that it takes to be a poster person, community for problems that develop with mass—I shouldn't say "mass"—with rapid growth. We've had so much growth there, and Clark County's done a remarkable job paying money without any Federal help doing a lot of roadbuilding on their own. So I think it's the least the Federal Government can do is to try to help with some new innovations for rapidly growing Clark County.

So thank you very much for representing your association, but also representing Clark County here today.

Mr. Beall, you've painted a good picture, as I've said, but where do you go from where we now are? What's next?

Mr. BEALL. Well, I think, like you said earlier, we're in a—

Senator REID. I also want to say this, you're the first elected official we've had here today. You're elected to the position you hold.

Mr. BEALL. Twenty years now.

Senator REID. So we're proud that you're doing such a good job as an elected official, and they had the confidence to send you here to represent this important entity that you represent.

Mr. BEALL. Well, the one thing I wanted to respond to you by is, we have to get in the operational phase now. There has been a lot

of challenges in terms of development, and now we're getting into operational. So that's what we're doing right now.

I wanted to add also regarding fast-growing areas, the Silicon Valley had been growing fast and it still is, really, in terms of the traffic congestion and the traffic. Despite what people see in the economy, we're still growing. This kind of stuff is quick. It gets done fast and it responds to that fast-growing economy. So one of the aspects of the Intelligent Transportation System programs is you can do it quick. You can get some if the stuff done quickly and it can expand your traffic system's capacity to respond to those quick-growing economies that are out there in our country. I think that's something to consider when you look at this at a national level. That was very important to us. It really saved us in a lot of areas.

Senator REID. I have to be at the Senate floor by 5 o'clock, but here's a question that I have. There has been testimony, and others have talked about the fact that ITS deployment funds since 1998 when we started the program, really, have been earmarked by Appropriations Committee, rather than giving discretion to the Department of Transportation. Do any of you have any problems with any of these earmarks? Have they caused any problems or have they delayed or impaired deployment of other Intelligent Transportation Systems that any of the three of you are aware of?

Mr. BEALL. I don't believe we've had an earmark.

Senator REID. OK. You know of no reason the earmarks have interfered with any of the work you're doing?

Mr. BEALL. No, sir.

Mr. ALBERT. Senator Reid.

Senator REID. Yes?

Mr. ALBERT. I've been a receiver of those earmarks, so let me try to respond. Many of the earmarks that we have gotten either in working with Senator Burns or Senator Baucus have been to deploy solutions in rural America. It hasn't, from a University standpoint, it hasn't been just to produce reports. About 70 percent of the funds that we have actually secured have gone to putting something in the ground, whether those be electronic kiosks and rest areas or an AVI system in Yellowstone National Park, or traveler information.

But the reason that we have been doing earmarks is because there was no rural funding. We could not get it, so that we had to use political constituents. I don't know what percent of those earmarks were actually rural.

Senator REID. Well, I want to express my appreciation for the committee for your testimony here today. I am anxious to put together the bill next week. In fact, I'm meeting with Senator Moynihan this Friday to get his views. He has done so much for transportation in this country, and get his views as to what we should do. I'm happy to be able to report to him on what has transpired at this hearing.

This hearing stands in adjournment.

[Whereupon, at 4:47 p.m. the hearing was adjourned.]

[Additional statements submitted for the record follow:]

STATEMENT OF CHRISTINE JOHNSON, DIRECTOR, INTELLIGENT TRANSPORTATION
SYSTEMS JOINT PROGRAM OFFICE

Mr. Chairman, Members of the Subcommittee, thank you for the opportunity to appear before you today to discuss some of the challenges that face our Nation's transportation system and the role of Intelligent Transportation Systems (ITS) in meeting these challenges.

As Secretary Mineta has said, transportation is key to our Nation's well-being, whether measured as economic growth, as international competitiveness, or as quality of life. On the whole, our system of highways and bridges works well in maintaining the strong economic performance of the country, and a recent Federal Highway Administration (FHWA) survey of surface transportation customers shows increasing levels of satisfaction with the physical condition of our infrastructure.

However, the same survey shows traffic congestion and highway safety are growing concerns for the traveling public. The survey also reveals that the public is reluctant to turn to capacity expansion as a first alternative to alleviate congestion because of the costs in taxes, environmental impacts, and space. Survey respondents favored solutions that minimize delays associated with roadwork and make our existing system function better—operational solutions, many of which are underpinned by ITS infrastructure. Through application of modern information technology and communications, ITS can improve the quality, safety, and effective capacity of our existing infrastructure. While good operation does not replace construction, it can certainly enhance it.

ITS PROGRAM UNDER TEA-21

With the passage of the Transportation Equity Act for the 21st Century (TEA-21), Congress reaffirmed the role of the U.S. Department of Transportation (DOT) in development and integrated deployment of ITS technologies. Authorization of \$1.3 billion through Fiscal Year 2003 has made possible significant advances in the ITS program, and I would like to highlight some of the accomplishments.

The ITS Program under TEA-21 has four primary features: (1) research and development funding providing for significant research; (2) incentive grants to States and cities to foster integrated ITS deployment; (3) a requirement that all ITS projects carried out using Federal-aid highway trust funds use nationally established ITS standards and be consistent with a national architecture; and finally, (4) in an attempt to "mainstream" ITS into regular transportation investments, TEA-21 makes clear that many categories of Federal-aid highway funds can be used for the purchase and operation of ITS technology. In my testimony today, I would like to provide a status report on each of these areas.

ITS Research and Development

Let me begin by discussing our research and development efforts. TEA-21 authorized a total of \$603 million in ITS research and development funds for fiscal years 1998–2003. For fiscal years 1998–2001, after specific statutory reductions, \$342 million have been made available in approximately the following proportions:

60 percent for research and field tests; 14 percent for development of standards and maintenance of the National Architecture; 9 percent for training and technical assistance to States, local governments, and transit properties; 7 percent for evaluation; and 10 percent to provide technical support for the administration of the program.

These resources have been used to advance the state-of-the-art in ITS through research and development, demonstrate new technologies through operational tests, promote integration through the National ITS Architecture and ITS Standards, and foster deployment by providing technical assistance and training to State and local governments.

ITS research and development is a very complex program that is roughly equivalent in size to FHWA's Surface Transportation Research Program. I would like to highlight some of the major initiatives that are underway in the ITS research and development program as a result of TEA-21.

Intelligent Vehicle Initiative (IVI)

The IVI is focused on reducing motor vehicle crashes by enhancing driver performance through technology while, at the same time, mitigating the distracting impacts that the introduction of vehicle-based technology can have on the driver. This is a multi-modal effort within the Department, carried out by the Federal Transit Administration (FTA) on transit buses, by the Federal Motor Carrier Safety Administration (FMCSA) which has the lead and works with the National Highway Traffic Safety Administration (NHTSA) on trucks and motor coaches, and in FHWA on spe-

cialty vehicles like snow plows. The majority of the program, however, is focused on passenger vehicles and is carried out primarily by NHTSA. Our research indicates that, when fully deployed, approximately 1.1 million or about 17 percent of all passenger vehicle crashes could be prevented using three of the simpler warning systems—rear-end collision, road departure, and lane collision warning systems. This would represent a savings of about \$20 billion in annual economic costs due to automobile crashes. In order to seek a full range of views on IVI program priorities and directions from major stakeholders and the scientific community, we have asked a panel of experts from the National Academy of Sciences to provide periodic guidance and assessment of the work underway.

Early IVI research has already contributed to the emergence of a number of vehicle-based safety systems that are available in the U.S. market today, including rear-end collision and rollover warning for heavy trucks, night vision systems for passenger cars, and adaptive cruise control and lane departure warning for both cars and heavy trucks. However, recognizing that these technologies, in combination with other in-vehicle devices, can have a distracting influence on the driver, decreasing safety rather than improving it, we are also conducting research on driver distraction, independently and in cooperation with automobile manufacturers and others. In addition, we are advancing concepts which enhance communication between the vehicle and roadway infrastructure to address problem areas such as intersection and run-off-the-road crashes.

Intelligent Infrastructure

Metropolitan and Rural Operational Test Program. Under the Intermodal Surface Transportation Efficiency Act of 1991 (ISTEA), the ITS program funded over 80 operational tests that demonstrated the effectiveness of numerous advanced traffic management technologies that have become a part of the deployment program. Through focusing resources on a priority set of field operational tests under TEA-21, we are greatly widening the original vision of ITS. For example, we are working closely with:

The Department of the Interior, to examine the potential of ITS for reducing congestion in National Parks; Police, fire and emergency medical service (EMS) communities, to implement use of ITS for quicker identification of crashes and improved coordination of the emergency response; The National Weather Service, to obtain better surface weather information for winter maintenance and to better inform travelers during major weather evacuations; Highway agencies interested in applying variable speed limits within work zones as a way to increase the safety and reduce overall delays in construction areas; and Local communities, to examine ways ITS can be used to improve the safety of pedestrians.

Commercial Vehicle Operations. The goal of this program is to improve the safety and productivity of commercial vehicle operations by using electronic clearance of trucks through weigh stations, using e-government technology to streamline the credentialing process and, most importantly, by making carrier safety information available to inspectors at the roadside.

The program also has great potential for streamlining border crossings. Work is underway in more than 40 States to plan, design, and implement these technologies. Complete systems are in place in four States, with three more States scheduled for completion by the end of this year.

Support for Deployment. Deploying ITS at the State and local levels requires a change in transportation culture and the development of new skills among the staff. It requires a shift in thinking, from primarily construction and rehabilitation of infrastructure, to active management of the transportation system to assure smooth operation and maximum safety. It requires a broadening of the traditional civil engineering skill base to include systems engineering, computer science, and electrical engineering. To meet these challenges, we have implemented an aggressive training and workshop program for Federal, State, and local transit, public safety, and highway officials. Topics being addressed range from architecture and systems engineering, to communications design and software procurement. We currently offer over 25 training courses in various aspects of ITS planning, development, deployment, and operations. Our course on the National ITS Architecture has been provided to over 2,600 Federal, State, and local officials and consultants. In addition, we have also provided extensive technical assistance to States and local governments through our field and headquarters staff, and through a peer-to-peer technical assistance program. One of the most effective programs involves ITS scanning tours for local officials which allow them to see ITS deployments and talk directly to other officials on why the decision was made to deploy ITS.

Intelligent Railroad Systems. The Federal Railroad Administration (FRA) and the FTA are working together on the development of Intelligent Railroad Systems, a

subset of ITS. Intelligent Railroad Systems will incorporate new sensor, computer, and digital communications technologies into train control, braking systems, grade crossings, and defect detection, and into planning and scheduling systems as well, and will apply to freight, intercity passenger, and commuter railroads. Work has begun on the development of the architecture for Intelligent Railroad Systems.

ITS Deployment Incentives Program

The second major provision for ITS in TEA-21 is the Deployment Incentives Program. TEA-21 provided \$679 million in Deployment Incentives funds. These funds serve as a bridge between the research program and, ultimately, the mainstreaming of ITS. A particular focus was integrating legacy, or pre-existing, systems. The belief was that, while the States could purchase hardware with non-ITS Federal-aid highway funds, a Federal incentive was needed to encourage them to go the “extra mile” in making systems talk to one another. An additional objective of the program is to advance the deployment of the Commercial Vehicle Information Systems and Network (CVISN). In fact, Congress set a goal to have a majority of the States deploy CVISN by September 30, 2003.

The ITS Deployment Incentives Program has been fully earmarked by the Appropriations Committees each year since 1998. These earmarks have directed the funds to specific State and local jurisdictions, but have also specifically required that the funds be used in accordance with the provisions contained in TEA-21. As the attached chart reveals, the number of projects relative to available dollars has been steadily increasing. While the Department believes that the program would be most effective if the funds were competitively awarded, we have worked closely with the recipients to ensure that the funds are being used to advance the goals of TEA-21. However, because of the earmarking, it is doubtful that we will meet the congressional goal of CVISN in a majority of the States by the end of 2003.

A mid-term assessment of the Deployment Incentives Program conducted by the Department in 2000 showed that this program was fostering deployment and integration across almost all of the key elements of ITS infrastructure.

National ITS Architecture and Standards

Architecture Conformity

The third focus of the ITS program in TEA-21 is on the National ITS Architecture and Standards. TEA-21 included a provision that all ITS projects funded out of the Highway Trust Fund had to conform with the National Architecture. The goal was to foster integration and interoperability.

We have worked closely with our State and local partners to develop an approach for implementing this requirement that would give States and metropolitan areas freedom to develop their own architectures, that fit their unique needs, but with key elements compatible with the National Architecture. By taking this approach—that “one size does not fit all”—we have received broad support from the transportation community on the National Architecture requirement.

We are now in the process of rolling out an aggressive program of training, workshops, and direct technical assistance to highway, transit, and public safety agencies to help them develop architectures. In addition, there are comprehensive workshops for States to develop their own CVISN architecture based on the National Architecture and Standards. To date, approximately 100 State, regional, or project architectures are underway and 34 States have completed CVISN architecture. Thirteen regions have completed architectures.

Standards

TEA-21 calls on the Department to develop and implement standards on a very aggressive schedule. It then requires recipients of funds to use these standards when purchasing ITS technology.

We have partnered with industry standards-setting groups for development of more than 80 standards. The Secretary of Transportation has identified 18 ITS standards to be critical to national interoperability. To date, nearly 55 standards have been completed and all but two of the standards that are critical for national interoperability have been completed. Work is also progressing on the development of ITS standards at highway-rail intersections.

We are now shifting our attention to the implementation of these standards. Working with State and local governments we are testing the standards, using the ITS Deployment Incentives program to provide early field demonstrations of the standards, and working through our field staff to provide training and technical assistance in the procurement and use of the standards. We believe this is a critical step before we officially adopt these standards, in order to insure that they are robust and well accepted by users.

Mainstreaming

The last ITS element in TEA-21 that I would like to address is “mainstreaming” and, in doing so, answer a few questions that I know surround the program. Why isn’t ITS deployment more visible? Is it working? Why don’t we see more of it? And, can’t we do better than overhead message signs that say “Congestion Ahead”?

TEA-21 clarified that non-ITS Federal-aid highway funding sources (National Highway System (NHS), Surface Transportation Program (STP), Congestion Mitigation and Air Quality Program (CMAQ)) could be used to purchase and operate ITS infrastructure. As we look across the United States, we see many encouraging signs that ITS Deployment is happening: More than 40 States are planning, designing, or deploying a part of CVISN; 55 of our 75 largest metropolitan areas have begun significant deployment of ITS; nearly 70 percent of all toll facilities use electronic toll collection; more than 50 traffic control centers are in operation and many more are planned; more than 31 percent of fixed-route buses in our larger metropolitan areas are equipped with automatic vehicle location technologies; and more than one million vehicles are equipped with automatic crash notification. More than 700 traveler information websites have been created (over 500 exclusively transit sites, nearly 200 exclusively traffic sites, and several multimodal sites); and now, with the allocation of the 511 telephone number, traveler information will soon be a telephone call away. The first 511 call took place in the Cincinnati/Northern Kentucky metropolitan area in June of this year, and work is underway to implement 511 in Virginia, Arizona, California, Nebraska, Minnesota, and Utah.

These deployments are making a difference in reducing crashes, managing congestion, and improving the quality of life in communities. For example:

A study in Virginia illustrated that if ITS had NOT been deployed on I-66, congestion would have been 25 percent worse!

The Ramp Metering Test in Minneapolis demonstrated that ramp metering improved freeway travel time 22 percent, reduced crashes 24 percent, and improved freeway throughput 14 percent.

Automated Vehicle Location (AVL) reduced paratransit expenses in San Jose, California, from \$4.88 to \$3.72 per passenger.

Evaluations of adaptive traffic signal control systems have demonstrated reduction in delays of 14 percent to 44 percent, and a similar reduction in stops of 10 percent to 41 percent.

Studies in 3 cities (Los Angeles, Rochester, and Phoenix) showed that pedestrian detection devices that automatically activate traffic and crosswalk signals at intersections reduced pedestrian and vehicle safety conflicts by 40 percent for some types of conflicts to as much as 89 percent for certain others.

In a study of 40,000 inspections, safety inspectors increased the number of unsafe commercial drivers and vehicles removed from the highway from 8,000 to 12,000 by using advanced safety information systems instead of traditional methods.

Further, as President Bush’s energy policy recognizes, in reducing congestion ITS is a valuable strategy for fuel conservation.

Every year we catalog results of the studies on ITS deployment in an annual report on ITS benefits.

While we are encouraged by these examples of deployment, and the benefits they have demonstrated, there are very few places where a complete metropolitan system could be considered to be in place, let alone a Statewide or National system. One recent estimate suggested that over the last decade we have moved from about 6 percent of our major metropolitan systems being instrumented to about 22 percent today. Not bad, but a long way from complete! Hence, we still face “Congestion Ahead” signs, as opposed to signs that give us detailed information on travel times and alternate routes—as they do in Paris.

Although ITS solutions are eligible for most Federal-aid funding categories, these projects are competing with traditional construction needs for the available funds. This may negate the effectiveness of the TEA-21 provisions making non-ITS funds available and may be slowing deployment. FHWA is conducting interviews and surveys to determine if this is a valid assessment.

Our experience suggests that some of the issues may be deeper than money. The institutions that we have today, particularly at the State level, were organized around constructing projects or enforcing the law. Those missions are quite different from the mission of managing or operating a road system to a particular performance level. Historically, adding capacity was the solution to congestion issues. Today, however, we need to focus more broadly on how to improve safety, productivity, and the operations of the specific highway and of the transportation system through ITS techniques.

For example, we have begun to realize that no institution “owns” the congestion or safety problem at the local level or State level, and no institution has the right

players around the table such that they could be accountable for the daily performance of the system. The exception is the rare occasion when a major special event, such as the Olympic Games, comes to town. Except for those special events, no institution has enough of a stake in the performance of the system on a daily basis to insist on developing the electronic network that would enable the effective operation of the system.

And so, deployment is occurring at the margins, as budgets or earmarks permit, or major special events demand.

THE ROAD AHEAD

In many ways, the nationwide deployment of ITS mirrors the creation of the Interstate System, both in its potential for profoundly changing the delivery of transportation in the United States and in the magnitude of the challenge in getting it accomplished.

If we are going to move from spots of deployment to a full “electronic” national system of smart vehicles and smart roadways for safety, savings, and productivity, it will require the same type of programmatic commitment and institution building that we undertook for the Interstate system in the 1960’s and 1970’s. It will require us to do more than try to fit ITS into existing funding mechanisms, Federal regulations, and a transportation culture that has been created around a construction mission. It will require us to step back and think as boldly and as creatively as our predecessors did when they created the blueprint for the Interstate System.

As we begin to look toward the reauthorization of the surface transportation program, it will be important to consider what needs to be done to create an environment where we have the funding, institutions, and policies that will support the achievement of this vision.

In closing, thank you again for this opportunity to describe the status of the ITS program. I would be pleased to respond to any questions you might have.

CHART

ITS Deployment Program

Fiscal Year	No. of Projects	Funding Available (In millions of dollars)
1998	44	83.9
1999	71	92.7
2000	79	98.4
2001	96	103.5

Intelligent Transportation Systems Benefits:

2001 Update

Prepared by
Mitretek Systems
600 Maryland Avenue SW, Suite 755
Washington, D.C. 20024

Under Contract to the Federal Highway Administration
United States Department of Transportation
Washington, D.C.

June 2001

1. Report No. FHWA-OP-01-024	2. Government Accession No.	3. Recipient's Catalog No.	
4. Title and Subtitle Intelligent Transportation Systems Benefits: 2001 Update		5. Report Date June 2001	
		6. Performing Organization Code	
7. Author(s) Allen T. Proper, Robert P. Maccubbin, Lynette C. Goodwin		8. Performing Organization Report No.	
9. Performing Organization Name and Address Mitretek Systems Inc. 600 Maryland Ave, SW, Suite 755 Washington D.C. 20024		10. Work Unit No. (TRAINS)	
		11. Contract or Grant No. DTFH61-00-C-00001	
12. Sponsoring Agency Name and Address Department of Transportation Intelligent Transportation Systems Joint Program Office 400 Seventh Street, SW - Room 3416 Washington, D.C. 20590		13. Type of Report and Period Covered	
		14. Sponsoring Agency Code HOIT	
15. Supplementary Notes Joseph I. Peters - Task Manager			
16. Abstract This report continues the series of reports that document evaluation results of ITS user services and the benefits these services provide to the surface transportation system. The organization of this report differs from that of the previous ITS Benefits reports. While previous reports were cumulative, this report only summarizes major findings of data included in previous reports in the series. More detailed discussion is included for data collected since the 1999 report. Referenced data are classified into a structure that reflects individual ITS program areas. These program areas include metropolitan and rural infrastructure, ITS for Commercial Vehicle Operations (TS/CVO), and Intelligent Vehicle user services. Data within the report reflect empirical results from field operations of deployed systems, supplemented with benefits information based upon modeling studies and statistical studies. This is a reference report. It provides a snapshot of the information contained in the ITS Benefits Database (www.benefitcost.its.dot.gov), as of February 15, 2001. The online database is updated more frequently and provides more detail on specific references than this report. Both the report and database highlight benefits identified by other authors and refer the reader to information sources. The interested reader is encouraged to obtain source documents in order to appreciate the assumptions and constraints placed upon interpretation of results. It is the intent of the ITS Joint Program Office to update this report periodically.			
17. Key Words Intelligent Transportation Systems, ITS, Benefits		18. Distribution Statement No Restrictions This document is available to the public	
19. Security Classif. (of this report) Unclassified	20. Security Classif. (of this page) Unclassified	21. No. of Pages 88	22. Price NA

PREFACE

Since December of 1994, the United States Department of Transportation's (U.S. DOT's) ITS Joint Program Office (JPO) has been actively collecting information regarding the impact of ITS projects on the surface transportation network. In support of this effort the JPO sponsored the development of the National ITS Benefits Database. The database, updated quarterly, is available to the public at www.benefitcost.its.dot.gov and contains the most recent data collected by the JPO. Its purpose is to provide the JPO with a tool to transmit existing knowledge of the benefits of ITS products and services to transportation professionals. The database also provides the research community with information on ITS areas where further analysis may be required.

This document is a compendium of reported impacts of ITS collected for this effort. It builds on previous ITS Benefits reports, and is intended to be used as a reference report. It highlights benefits identified by other authors and refers the reader to information sources. The interested reader is encouraged to visit the ITS Benefits Database to obtain the most recent information and to obtain source documents in order to appreciate the assumptions and constraints placed upon interpretation of results. This report concentrates on summarizing data collected since the last update report, published in May 1999. However, general conclusions and summary information are developed using all data available in the database.

To aid the distribution of this report, it has been placed in the U.S. DOT's ITS Electronic Document Library at www.its.dot.gov/itsweb/welcome.htm as document number 13463.

Many ITS efforts initiated by states, local governments, and private enterprises do not have their benefits or costs documented in the database or this report. Readers who are aware of important ITS benefits and cost information from these and other sources are encouraged to submit them using the online database or to send reference documents to:

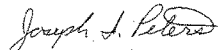

Joseph I. Peters, Ph.D.
Manager, ITS Program Assessment
ITS Joint Program Office
Federal Highway Administration (HOIT)
400 Seventh Street, SW
Washington, D.C. 20590

TABLE OF CONTENTS

PREFACE	i
TABLE OF CONTENTS	ii-iii
LISTING OF TABLES	iv
LISTING OF FIGURES	iv-v
EXECUTIVE SUMMARY	vii
1.0 INTRODUCTION	1
1.1 GOALS OF THE ITS BENEFITS REPORT AND DATABASE	1
1.2 ORGANIZATION OF THIS REPORT	2
1.3 A FEW GOOD MEASURES	4
1.4 IMPACTS OF ITS	6
2.0 BENEFITS OF METROPOLITAN ITS INFRASTRUCTURE	7
2.1 ARTERIAL MANAGEMENT SYSTEMS	9
2.1.1 Summary of Arterial Management System Impacts	10
2.1.2 Summary of Most Recent Evaluations	12
2.2 FREEWAY MANAGEMENT SYSTEMS	16
2.2.1 Summary of Freeway Management Impacts	16
2.2.2 Summary of Most Recent Evaluations	18
2.3 TRANSIT MANAGEMENT SYSTEMS	21
2.3.1 Summary of Transit Management System Impacts	22
2.3.2 Summary of Most Recent Evaluations	22
2.4 INCIDENT MANAGEMENT SYSTEMS	24
2.4.1 Summary of Incident Management Impacts	24
2.4.2 Summary of Most Recent Evaluations	26
2.5 EMERGENCY MANAGEMENT	28
2.5.1 Summary of Emergency Management Impacts	28
2.6 ELECTRONIC TOLL COLLECTION	30
2.6.1 Summary of Most Recent Evaluations	30
2.7 ELECTRONIC FARE PAYMENT	32
2.7.1 Summary of Most Recent Evaluations	32
2.8 HIGHWAY-RAIL INTERSECTIONS	33
2.8.1 Summary of Most Recent Evaluations	34
2.9 REGIONAL MULTIMODAL TRAVELER INFORMATION	35
2.9.1 Summary of Multimodal Traveler Information System Impacts	35
2.9.2 Summary of Most Recent Evaluations	35
2.10 INFORMATION MANAGEMENT	40

2.11 IMPACTS OF OTHER ITS APPLICATIONS IN METROPOLITAN AREAS	40
2.11.1 Summary of Most Recent Evaluations	40
3.0 BENEFITS OF RURAL ITS INFRASTRUCTURE	41
3.1 CRASH PREVENTION AND SECURITY	42
3.1.1 Summary of Most Recent Evaluations	42
3.2 EMERGENCY SERVICES	43
3.2.1 Summary of Most Recent Evaluations	43
3.3 TRAVEL AND TOURISM	44
3.4 TRAFFIC MANAGEMENT	45
3.5 TRANSIT AND MOBILITY	46
3.5.1 Summary of Most Recent Evaluations	46
3.6 OPERATIONS AND MAINTENANCE	47
3.7 ROAD WEATHER MANAGEMENT	48
3.7.1 Summary of Most Recent Evaluations	48
4.0 BENEFITS OF ITS FOR COMMERCIAL VEHICLE OPERATIONS	51
4.1 SAFETY ASSURANCE	51
4.1.1 Summary of Most Recent Evaluations	52
4.2 CREDENTIALS ADMINISTRATION	53
4.2.1 Summary of Most Recent Evaluations	53
4.3 ELECTRONIC SCREENING	55
4.3.1 Summary of Electronic Screening Impacts	55
4.3.2 Summary of Most Recent Evaluations	55
4.4 CARRIER OPERATIONS	57
4.4.1 Summary of Carrier Operations Impacts	57
4.4.2 Summary of Most Recent Evaluations	57
5.0 BENEFITS OF INTELLIGENT VEHICLES	58
5.1 DRIVER ASSISTANCE	58
5.1.1 Summary of Most Recent Evaluations	58
5.2 COLLISION AVOIDANCE AND WARNING	60
5.2.1 Summary of Most Recent Evaluations	60
6.0 SUMMARY	63
APPENDIX 1: REFERENCE LIST	70
APPENDIX 2: LIST OF ACRONYMS	76

LISTING OF TABLES

Table ES-1: Summary of Available Data by Benefit Measure	viii
Table ES-2: Benefits Database Desk Reference	x
Table 2-1: Summary of Ramp Metering Impacts	17
Table 2-2: Summary of Incident Management Data	25
Table 2-3: Results of Service Patrol Benefit-Cost Studies	27
Table 6-1: Summary of Available Data by Benefit Measure	64
Table 6-2: Number of Metropolitan ITS References in the Database	65
Table 6-3: Number of Rural ITS References in the Database	66
Table 6-4: Number of ITS/CVO References in the Database	67
Table 6-5: Number of Intelligent Vehicle References in the Database	67
Table 6-6: Number of Metropolitan Integration References in the Database	68

LISTING OF FIGURES

Figure 1-0: Intelligent Infrastructure Taxonomy for Reporting ITS Benefits	2
Figure 1-1: Intelligent Vehicles Taxonomy for Reporting ITS Benefits	3
Figure 2-0: Metropolitan ITS Components	7
Figure 2-1: Integration of Metropolitan ITS Components	8
Figure 2-2: Arterial to Incident Management Integration Icon	8
Figure 2-3: Taxonomy for Arterial Management System Benefits	9
Figure 2-4: Reported Values of Stop Reductions under Improved Traffic Signal Control	11
Figure 2-5: Travel Time Reduction with Improved Traffic Signal Control	11
Figure 2-6: Delay Reduction with Improved Traffic Signal Control	11
Figure 2-7: Fuel Consumption Reductions Due to Improved Traffic Signal Control	11
Figure 2-8: Reduction in Signal Violations Due to Automated Enforcement	12
Figure 2-9: Taxonomy for Freeway Management Systems	16
Figure 2-10: Percent Crash Reduction Due to Ramp Metering	17
Figure 2-11: Percent Reduction in Crash Rate Due to Ramp Metering	18
Figure 2-12: Percent Increase in Speed Due to Ramp Metering	18
Figure 2-13: Taxonomy of Transit Management Systems	21

Figure 2-14: Improvement in On-Time Performance with CAD/AVL	22
Figure 2-15: Taxonomy for Incident Management Systems	24
Figure 2-16: Reported Cost Savings Values for Incident Management	25
Figure 2-17: Reported Delay Savings Values for Incident Management	25
Figure 2-18: Taxonomy of Emergency Management	28
Figure 2-19: Taxonomy of Electronic Toll Collection	30
Figure 2-20: Taxonomy of Electronic Fare Payment	32
Figure 2-21: Taxonomy for Highway-Rail Intersections	33
Figure 2-22: Taxonomy for Regional Multimodal Traveler Information	35
Figure 3-0: Rural ITS Program Areas	41
Figure 3-1: Taxonomy for Crash Prevention and Security Applications	42
Figure 3-2: Taxonomy of Rural Emergency Services	43
Figure 3-3: Taxonomy of Travel and Tourism Information	44
Figure 3-4: Taxonomy of Rural Traffic Management	45
Figure 3-5: Taxonomy for Transit and Mobility	46
Figure 3-6: Taxonomy for Operation and Maintenance	47
Figure 3-7: Taxonomy for Road Weather Management	48
Figure 4-0: ITS/CVO Program Areas	51
Figure 4-1: Taxonomy for Safety Assurance	51
Figure 4-2: Taxonomy for Credentials Administration	53
Figure 4-3: Taxonomy for classifying Electronic Screening benefits.	55
Figure 4-4: Taxonomy for Classification of Carrier Operations Benefits	57
Figure 5-1: Taxonomy for Driver Assistance	58
Figure 5-2: Taxonomy for Collision Avoidance and Warning Benefits	60

EXECUTIVE SUMMARY

Since December of 1994, the United States Department of Transportation's (U.S. DOT's) ITS Joint Program Office (JPO) has been actively collecting information on the impacts that ITS and related projects have on the operation and management of the nation's surface transportation system. The evaluation of ITS is an ongoing process. Significant knowledge is available for many ITS services, but gaps in knowledge also exist.

The purpose of this report is to provide a summary of data available in the ITS Benefits Database. It is a compendium of reported impacts of ITS that have been collected from a number of sources, and builds upon a history of similar summary reports that have been authored over the last six years. Intended to be a reference report, this report highlights benefits identified by other authors. The purpose of this report is to provide the JPO with an additional tool to transmit existing knowledge of ITS benefits to the transportation professional who may not be well versed in ITS products and services. This report can also provide the research community with information about where further analysis is required in the ITS program. It demonstrates that in general all ITS services have shown some positive benefit and that negative impacts are usually outweighed by other positive results. For example, higher speeds and improved traffic flow result in increases in Nitrous Oxides, while other measures which indicate increased emissions, such as fuel consumption, travel time, and delay, are reduced.

General conclusions and results are developed throughout the body of the report. Due to the nature of the data, it is often difficult to compare data from one project to another. This is because of the differences in context or conditions between different ITS implementations. Thus, statistical analysis of the data is not done across data points. In several cases, ranges of reported impacts are presented and general trends can be discussed. These cases include traffic signal systems, automated enforcement, ramp metering, and incident management.

As indicated in Table ES-1, most of the data collected to date are concentrated within metropolitan areas. The heaviest concentrations of data in the metropolitan area are in arterial management systems, freeway management, incident management, transit management, and regional multimodal traveler information. Most of the available data on traffic signal control systems are from adaptive traffic control. For freeway management, most data are concentrated around benefits related to ramp metering. There are also now several studies on the benefits of ITS at highway rail intersections, which differs from the 1999 report when no evaluations were available.

www.benefitscost.its.dot.gov

		Number of References											
		0 -	1 to 3 -	4 to 6 -	7 to 10 -	>10 -	Safety	Time & Delay	Capacity/Throughput	Cost	Customer Satisfaction	Energy & Environment	Other
Metropolitan	Arterial Management Systems	●	●	●	●	●	●	●	●	●	●	●	○
	Freeway Management	●	●	●	●	●	●	●	●	●	●	●	○
	Transit Management	●	●	●	●	●	●	●	●	●	●	●	○
	Incident Management	●	●	●	●	●	●	●	●	●	●	●	○
	Emergency Management	○	○	○	○	○	○	○	○	○	○	○	○
	Electronic Toll Collection	○	○	○	○	○	○	○	○	○	○	○	○
	Electronic Fare Payment	○	○	○	○	○	○	○	○	○	○	○	○
	Highway-Rail Intersection	○	○	○	○	○	○	○	○	○	○	○	○
	Regional Multimodal Travel Information	○	○	○	○	○	○	○	○	○	○	○	○
	Information Management	○	○	○	○	○	○	○	○	○	○	○	○
Rural	Traveler Safety and Security	○	○	○	○	○	○	○	○	○	○	○	○
	Emergency Services	○	○	○	○	○	○	○	○	○	○	○	○
	Tourism and Travel Information	○	○	○	○	○	○	○	○	○	○	○	○
	Public Transit and Mobility Services	○	○	○	○	○	○	○	○	○	○	○	○
	Infrastructure Operation and Maintenance	○	○	○	○	○	○	○	○	○	○	○	○
ITS/CVO	Road Weather Management	○	○	○	○	○	○	○	○	○	○	○	○
	Safety Assurance	○	○	○	○	○	○	○	○	○	○	○	○
	Credentials Administration	○	○	○	○	○	○	○	○	○	○	○	○
	Electronic Screening	○	○	○	○	○	○	○	○	○	○	○	○
I.V.	Carrier Operations	○	○	○	○	○	○	○	○	○	○	○	○
	Driver Assistance	○	○	○	○	○	○	○	○	○	○	○	○
	Platform Specific	○	○	○	○	○	○	○	○	○	○	○	○

Table ES-1: Summary of Available Data by Benefit Measure (as of 15 February 2001)

In past reports, rural applications have had few data points, but an increase in the implementation and evaluation of rural ITS has changed this. Several state and national parks are now examining and implementing improved tourism and travel information systems and several rural areas are implementing public travel services. Also, many states are now examining the benefits of incorporating ITS, specifically weather information, into the operation and maintenance of facilities and equipment. Much of the data reported for rural ITS are concentrated in the areas of crash prevention and security. Also, a significant amount of information is available for road weather management activities, including winter weather-related maintenance, pavement condition monitoring, and dissemination of road weather information.

ITS for Commercial Vehicle Operations (ITS/CVO) continues to provide benefits to both carriers and state agencies. ITS/CVO program areas usually report benefits data from directly measurable effects. Therefore, it might be expected that these data are accurate and only a few data points would be necessary to convince carriers, states, and local authorities of the possible benefits of implementing these systems. To date, most of the data collected for ITS/CVO are for cost, travel time, and delay savings for carrier operations.

ITS program areas and user services associated with driver assistance and specific vehicle classes are still being developed and planned. Although a few of these services are available in the marketplace, much of the data currently associated with these services are predicted or projected based on how systems are expected to perform. As market penetrations increase and improved systems are developed, there will be ample opportunity to measure and report data based on actual measurements.

The Benefits Database Desk Reference, Table ES-2 on the following page, also provides a brief summary of the metropolitan data available in the online database. The desk reference is updated regularly and is also available at the database website.

Given the continued investment in ITS that is occurring at the national, state, and local levels, there will continue to be opportunities to measure and report more data on the impacts of ITS. As these data become available, it may be possible to perform more detailed analyses for particular program areas or benefits measures, for example, through the use of meta-analysis techniques. These analyses are expected to assist in improving the estimated ranges of impact, and the level of confidence in those ranges.

www.benefitcost.its.dot.gov

Metropolitan Benefits By Program Area		
Program Area/Benefit Measure	Summary	
Arterial Management Systems	Safety Improvements Delay Savings Throughput Customer Satisfaction Cost Savings Environmental Other	Automated enforcement of traffic signals has reduced violations 20% to 75% Adaptive Signal Control has reduced delay from 14% to 44% 72% of surveyed drivers felt "better off" after signal control improvements in Michigan Transit Signal Priority on Toronto transit line allowed same service with one less vehicle Improvements to traffic signal control have reduced fuel consumption 2% to 13% Adaptive Control has reduced stops from 10% to 41%
Freeway Management Systems	Safety Improvements Delay Savings Throughput Customer Satisfaction Cost Savings Environmental Other	Ramp Metering has shown 15% to 50% reduction in crashes 11 to 93.1 vehicle hours reduced due to ramp metering I-494; Minneapolis Systemwide study in Minneapolis - St. Paul found 16.3% increase in throughput After Twin Cities shutdown, 69% of surveyed travelers support modified continued operation Georgia Navigator \$44.6 million/year in incident delay reduction (integrated system) Ramp Metering has shown 8% to 60% increases in speed on freeways
Transit Management Systems	Safety Improvements Delay Savings Throughput Customer Satisfaction Cost Savings Environmental Other	AVL with silent alarm supported 33% reduction in passenger assaults on Denver System Reported improvements in on-time performance from 9% to 23% with CAD/AVL Customer complaints decreased 26% after Denver installed CAD/AVL AVL reduced San Jose paratransit expenses from \$4.88 to \$3.72 per passenger Reductions in fleet size from 4% to 9% due to more efficient bus utilization
Incident Management Systems	Safety Improvements Delay Savings Throughput Customer Satisfaction Cost Savings Environmental Other	San Antonio, TX reports reduced crash rate of 41% Reductions range from 95 thousand to 2 million hours per year Customers very satisfied with service patrols (hundreds of letters) Cost Savings from \$1 to \$45 million per year, varying with extent of system TransGuide reduced fuel consumption up to 2600 gal/major incident
Emergency Management Systems	Safety Improvements Delay Savings Throughput Customer Satisfaction Cost Savings Environmental Other	95% of drivers equipped with PushMe Mayday system felt more secure
Electronic Toll Collection	Safety Improvements Delay Savings Throughput Customer Satisfaction Cost Savings Environmental Other	Carquinez Bridge, CA: Increase in crashes (27 to 30) and injuries between 1996 and 1997 Carquinez Bridge, CA: person time savings of 79,919 hours (per year) or about \$1.07 million Tappan Zee Bridge: Manual lane 400-450 vph, ETC lane 1000 vph Roadway Maintenance can be reduced 14% Florida: Reduced CO 7.3%, HC 7.2%, increased NO _x 34% with 40% ETC usage Value pricing using ETC in Florida resulted in 20% of travelers adjusting departure time
Electronic Fare Payment	Safety Improvements Delay Savings Throughput Customer Satisfaction Cost Savings Environmental Other	In Europe, 71% to 87% user acceptance of coordinated smart cards for transit/city services New Jersey Transit estimates \$2.7 million cash handling reduction annually
Highway-Rail Intersections	Safety Improvements Delay Savings Throughput Customer Satisfaction Cost Savings Environmental Other	92% of train engineers felt safety equal or greater with automated horn warning system School bus drivers felt in-vehicle warning devices enhanced awareness of crossings Automated horn warning system reduced noise impact area by 97%
Regional Multimodal Traveler Information	Safety Improvements Delay Savings Throughput Customer Satisfaction Cost Savings Environmental Other	Crash rate for drivers using web traveler information in San Antonio reduced 0.5% San Antonio modeling results indicate a 5.4% reduction in delay for web site users 38% of TravTek Users found in-vehicle navigation useful in unfamiliar areas ROUTES (London): estimated 1.3 million pounds sterling due to increased transit ridership SmartTraveler Boston: estimated reductions NO _x 1.5%, CO 33%

Source: www.benefitcost.its.dot.gov

*Database also includes negative impacts of ITS.

Date: 3/14/2001

Table ES-2: Benefits Database Desk Reference

1.0 INTRODUCTION

Americans drive more than 2.6 trillion miles a year on our nation's roadways. Transit ridership reached nine billion trips in 1999, the highest level in 40 years. The increasing demand for transportation caused by our expanding economy is causing the transportation system to reach the limits of its existing capacity. Intelligent Transportation Systems (ITS) can help ease this strain through the application of modern information technology and communications.

The goal of ITS is to improve the transportation system to make it more effective, more efficient, and safer. Building new transportation infrastructure is expensive and environmentally risky. In most urban areas where more capacity is needed, it is becoming physically impossible to build enough new roads or new lanes to meet transportation demand. By applying the latest technological advancements to our transportation system, ITS can help meet increasing demand for transportation by improving the quality, safety, and effective capacity of our existing infrastructure.

ITS represents a wide collection of applications, from advanced signal control systems to ramp meters to collision warning systems. In order to apply ITS technologies most effectively, it is important to know which technologies are most effectively addressing the issues of congestion and safety. Some technologies provide more cost-effective benefits than others, and as technology evolves, the choices to deployers change. Often, several technologies are combined in a single integrated system, providing synergistic benefits that exceed the benefits of any single technology. It is important to know which technologies and technology combinations provide the greatest benefits, so that transportation investments can be applied most effectively to meet the growing transportation demands of our expanding economy.¹

1.1 GOALS OF THE ITS BENEFITS REPORT AND DATABASE

1.1.1 The ITS Benefits Database

To expand the understanding of ITS benefits, the United States Department of Transportation's (U.S. DOT's) ITS Joint Program Office (JPO) has been actively collecting information regarding the impact of ITS implementations. In support of this effort, the JPO sponsored the development of the National ITS Benefits Database. The database is available to the public at www.benefitcost.its.dot.gov. The database contains the most recent data collected by the JPO. Its purpose is to provide the JPO with a tool to transmit existing knowledge of ITS benefits to the transportation professional who may not be well versed in ITS products and services. The database also provides the research community with information on ITS areas where further analysis may be required.

The Benefits Database website contains detailed summaries of each of the ITS evaluation reports reviewed by the JPO. Summaries on the web pages provide additional background on the context of the evaluations, the evaluation methodologies used, and links to the source documentation, if available online. While the JPO publishes reports such as this periodically, the online database is updated quarterly to reflect the most recent reports reviewed. The online database also provides several capabilities to simplify access to information relevant to a researcher's purpose. In addition to using the classification system in this report, interested researchers can access document summaries classified by the location of the implementation, the performance measures reported for the projects, or

¹ *The Changing Face of Transportation*. U.S. Dept. of Transportation, Bureau of Transportation Statistics (BTS00-007). 2000.

www.benefits.its.dot.gov

relevant keywords. These capabilities of the online database simplify access to the most recently available data on ITS benefits identified by the JPO. The website also contains a discussion of the criteria and sources used to determine whether or not a report should be added to the ITS Benefits Database.

1.1.2 Purpose of this Report

This periodically updated report is a compendium of reported impacts of ITS that have been collected from a number of sources. Its purpose is to provide a summary of data available in the ITS Benefits Database. The report builds upon a history of similar summary reports that have been authored over the last six years. The last report, titled *ITS Benefits: 1999 Update*,² was published in May of 1999. For this June 2001 report, a concentrated effort was made to include and highlight recent data. However, this report also references and contains data included in previous versions. Older data points are primarily used to develop general conclusions about the impacts of ITS services and are not described in as much detail as the more recent data. This report is intended to be a reference report; it highlights benefits identified by other authors. The interested reader is encouraged to obtain source information to appreciate the assumptions and constraints placed upon interpretation of results.

1.2 ORGANIZATION OF THIS REPORT

This report follows a taxonomy for reporting ITS benefits data. The ITS taxonomy used in this report groups benefits data into two major components: Intelligent Infrastructure and Intelligent Vehicles. These components are then divided into program areas and specific ITS application areas. While this taxonomy was not intended to reflect the official structure of the ITS program, it has proven useful in promoting discussion within the ITS community and has been used to demonstrate the breadth of the ITS program. An overview of this taxonomy is represented in Figures 1-0 and 1-1. A more detailed version of the taxonomy is available at the ITS Benefits Database website cited in the header of pages within this document.

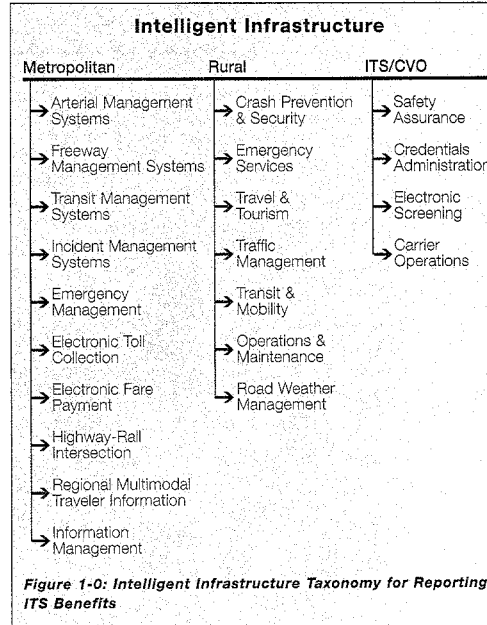

² Proper, Allen T. *Intelligent Transportation Systems Benefits: 1999 Update*. U.S. Department of Transportation, ITS Joint Program Office (FHWA-OP-99-012). May 1999.

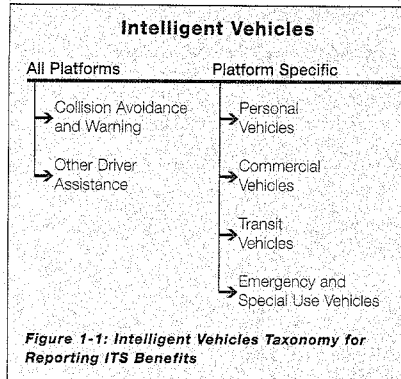

It is realized that the taxonomy cannot represent all aspects of ITS. For example, many of the program areas can be dependent on or heavily influenced by other areas. This dependency is not well shown in the taxonomy. It is also understood that many ITS program areas share information and operate in a cooperative manner which is difficult to capture in this form. For example, incident management systems can directly influence emergency response by providing timely and accurate information on incident location and severity. Additionally, in-vehicle systems, such as route guidance, require a cooperative infrastructure that can provide routing and/or travel time information to vehicle systems.

It is also known that the taxonomy for classification of data by geographic setting (i.e., metropolitan, rural) may not be best suited for some data. For example, tourist

information is generally classified in rural ITS infrastructure. However, most metropolitan areas also have tourism concerns. Therefore, this classification of data does not imply that systems are not implemented in or do not impact other geographic settings. In this report, data are classified by those settings most often associated with the current deployment of the ITS program area or service.

Classification of ITS benefits was based on the geographic setting (e.g., metropolitan) or functionality (e.g., ITS/CVO) of the ITS services referenced in the source documentation. This report attempts to account for the influences and cooperative aspects of ITS. In the case of integrated deployments, data are classified in this report under the program area that the implementation most directly supports. In some cases, source documents did not provide enough detailed information to classify referenced data. When this occurred, the authors made a judgment to determine how these data should be classified.

Sections within chapters of this report discuss each program area for which benefit data are available. Each section begins with a brief description of the ITS application and the current state of knowledge. Following this are overviews of all data and general conclusions that can be made about the ITS application. Finally, recent data, including what the authors consider to be the most important or interesting results collected since the 1999 report, are discussed.

1.3 A FEW GOOD MEASURES

In the spring of 1996, the ITS Joint Program Office (JPO) established a set of ITS Program goal areas directly related to the ITS strategic plan.³ The goal areas include improving traveler safety, improving traveler mobility, improving system efficiency, increasing the productivity of transportation providers and conserving energy while protecting the environment. The JPO also identified several measures of effectiveness to evaluate the performance of ITS services in each goal area. The measures are known as the "Few Good Measures" and are intended to enable project managers to gauge the effects and impacts of ITS.

The remainder of this section is an overview of the various measures of effectiveness within each goal area. Throughout the document, icons are placed next to each summary to reflect the measures reported. Benefits that are not included in the set of measures are also included in the report, without using icons to reference them.



SAFETY

An explicit objective of the transportation system is to provide a safe environment for travel while continuing to strive to improve the performance of the system. Although undesirable, crashes and fatalities are inevitable occurrences. Several ITS services aim to minimize the risk of crash occurrence. This goal area focuses on reducing the number of crashes, and lessening the probability of a fatality should a crash occur. Typical measures of effectiveness used to quantify safety performance include the overall crash rate, fatality crash rate, and injury crash rate.

ITS services should also strive to reduce the crash rate of a facility or system. Crash rates are typically calculated in terms of crashes per year or crashes per million vehicle miles of travel.



MOBILITY

Improving mobility by reducing delay and travel time is a major goal of many ITS components. To highlight this goal, in 1996 the Secretary of Transportation launched a new metropolitan ITS integration initiative, "Operation TimeSaver." Measures of effectiveness typically used to evaluate the performance of such goal-oriented projects include the amount of delay or the variability in travel time.

Delay can be measured in many different ways, depending on the type of transportation system being analyzed. Delay of a system is typically measured in seconds or minutes of delay per vehicle. Also, delay for users of the system may be measured in person-hours. Delay for freight shipments could be measured in time past scheduled arrival time of the shipment. Delay can also be measured by observing the number of stops experienced by drivers before and after a project is deployed or implemented.

Travel time variability indicates the variability in overall travel time from an origin to a destination in the system, including any modal transfers or en-route stops. This measure of effectiveness can readily be applied to intermodal freight (goods) movement as well as personal travel. Reducing the variability of travel time improves the reliability of arrival time estimates that travelers or companies use to make planning and scheduling decisions. By improving operations, improving incident response, and providing information on delays, ITS services can reduce the variability of travel time in transportation networks. For example, traveler information products can be used in trip planning to help re-route commercial drivers around congested areas resulting in less variability in travel time.

³ *Strategic Plan for Intelligent Vehicle Highway Systems in the United States*. ITS America Report (IVHS-Amer-92-3). Washington, DC: May 20, 1992.



EFFICIENCY

Many ITS components seek to optimize the efficiency of existing facilities and use of rights-of-way so that mobility and commerce needs can be met while reducing the need to construct or expand facilities. This is accomplished by increasing the effective capacity of the transportation system. Effective capacity is the “maximum potential rate at which persons or vehicles may traverse a link, node, or network under a representative composite of roadway conditions,” including “weather, incidents, and variation in traffic demand patterns.”⁴ Capacity, as defined by the *Highway Capacity Manual*, is the “maximum hourly rate at which persons or vehicles can reasonably be expected to traverse a given point or uniform section of a lane or roadway during a given time period under prevailing roadway, traffic and control conditions.”⁵ The major difference between effective capacity and capacity is that capacity is generally measured under typical conditions for the facility, such as good weather and pavement conditions, with no incidents affecting the system, while effective capacity can vary depending upon these conditions and the use of management and operational strategies. Throughput is defined as the number of persons, goods, or vehicles traversing a roadway section or network per unit time. Increases in throughput are sometimes realizations of increases in effective capacity. Under certain conditions, it may reflect the maximum number of travelers that can be accommodated by a transportation system. Throughput is more easily measured than effective capacity and therefore can be used as a surrogate measure when analyzing the performance of an ITS project.



PRODUCTIVITY

ITS implementation frequently reduces operating costs and allows productivity improvements. In addition, ITS alternatives may have lower acquisition costs and life cycle costs compared to traditional transportation improvement techniques. The measure of effectiveness for this goal area is cost savings as a result of implementing ITS. Another way to view the cost savings is to quantify the cost savings between traditional and ITS solutions to addressing problems.



ENERGY AND ENVIRONMENT

The air quality and energy impacts of ITS services are very important considerations, particularly for non-attainment areas. In most cases, environmental benefits can only be estimated by the use of analysis and simulation. The problems related to regional measurement include the small impact of individual projects and large numbers of exogenous variables including weather, contributions from non-mobile sources or other regions, and the time-evolving nature of ozone pollution. Small-scale studies generally show positive impacts on the environment. These impacts result from smoother and more efficient flows in the transportation system. However, environmental impacts of travelers reacting to large-scale deployment in the long term are not well understood.

Decreases in emission levels and energy consumption have been identified as measures of effectiveness for this goal area. Specific measures of effectiveness for emission levels and fuel use include:

- Emission levels (CO, NO_x and HC) (kg or tons of pollutant)
- Fuel use (liters or gallons)
- Fuel economy (km/L or miles/gal)

⁴ McGurrin, Michael and Karl Wunderlich. “Running at Capacity.” *Traffic Technology International*. April/May 1999.

⁵ *Highway Capacity Manual 2000*. Transportation Research Board, National Research Council. Washington, DC: 2000.

www.BenefitsCosts.com



CUSTOMER SATISFACTION

Given that many ITS projects and programs were specifically developed to serve the public, it is important to ensure that user (i.e., customer) expectations are being met or surpassed. Customer satisfaction measures and characterizes the distance between users' expectations and experiences in relation to a service or product. The central question in a customer satisfaction evaluation is, "Does the product deliver sufficient value (or benefits) in exchange for the customer's investment, whether the investment is measured in money or time?" Typical results reported in evaluating the impacts of customer satisfaction with a product or service include product awareness, expectations of product benefit(s), product use, response (decision-making or behavior change), realization of benefits, and assessment of value. Although satisfaction is difficult to measure directly, measures related to satisfaction can be observed including amount of travel in various modes, mode choices, and the quality of service as well as the volume of complaints and/or compliments received by the service provider.

In addition to user or customer satisfaction, it is necessary to evaluate the satisfaction of the transportation system provider or manager. For example, many ITS projects are implemented to better coordinate between various stakeholders in the transportation arena. In such projects, it is important to measure the satisfaction of the transportation provider to ensure the best use of limited funding. One way to measure the performance of such a project is to survey transportation providers before and after a project was implemented to see if coordination was improved. It may also be possible to bring together providers from each of the stakeholder groups to evaluate their satisfaction with the system before and after the implementation of an ITS project.

1.4 IMPACTS OF ITS

This report includes both the positive and negative reported impacts of ITS implementations. The majority of available references demonstrate positive benefits. This is true both for actual deployments and for analytical studies predicting future benefits. The number of cases reporting negative results is fairly small. It is also recognized that negative impacts may be under-reported in the literature.

2.0 BENEFITS OF METROPOLITAN ITS INFRASTRUCTURE

Metropolitan ITS consist of those program areas that are primarily implemented in urban and suburban geographic locations. This does not imply that these systems are not implemented in or do not impact other geographic settings. However, they are more often associated with urban areas.

The metropolitan ITS infrastructure is classified into 10 major components. These components are summarized in Figure 2-0, below.

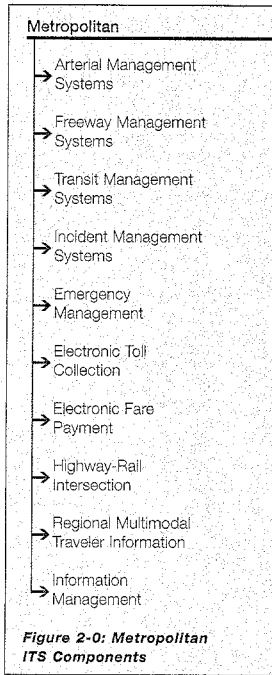

Several metropolitan areas are implementing ITS services that are very highly integrated. Integration is accomplished by creating a number of interfaces or "links" between components, systems, services, or program areas. These links are used to share operational information and allow for sharing of infrastructure. Figure 2-1 demonstrates a set of metropolitan integration links. A number is used to refer to the specific linkage made between each program area. For example, link number two represents the sharing of arterial traffic condition information originating from a traffic signal system with a freeway management system. To highlight the impact of the interaction between services on system benefits, data regarding integrated systems are highlighted in this chapter by icons with a connecting line that depicts the flow of information between systems. The example in Figure 2-2 represents integration between arterial management and incident management systems.

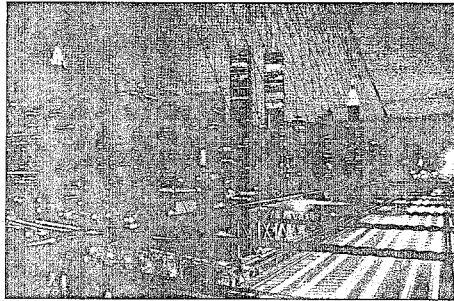

www.benefitscosts.gov

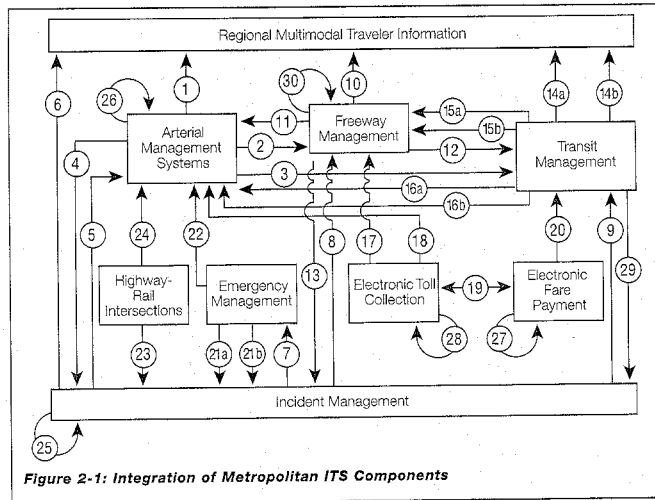

Figure 2-1: Integration of Metropolitan ITS Components

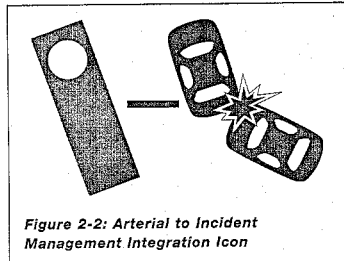
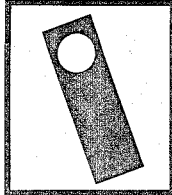

Figure 2-2: Arterial to Incident Management Integration Icon

For a more complete understanding of these components and how they are integrated, the reader is referred to the following documents:

- *Tracking the Deployment of Integrated Metropolitan Intelligent Transportation Systems Infrastructure in the USA: FY99 Results.* FHWA Report (FHWA-OP-00-016). March 2000. Electronic Document Number 13159.
- "Measuring ITS Deployment and Integration." Prepared for the FHWA ITS JPO, January 1999. Electronic Document Number 4372.

Both documents are electronically available on the FHWA electronic document library at www.its.dot.gov/itsweb/welcome.htm. The JPO-sponsored deployment tracking website, www.itsdeployment.its.dot.gov, contains updated information on ITS deployment in the United States. Results of the FY 2000 surveys are expected to be available at the deployment tracking website by Summer 2001.



2.1 ARTERIAL MANAGEMENT SYSTEMS

Arterial management systems are used to manage traffic by employing various detection and control devices along arterial roadways. Included in this program area are arterial traffic management systems that provide surveillance and traffic signal control, and some systems that provide travelers with audio or visual information on arterial roadway travel conditions.

Traffic signal control systems are upgraded for a number of reasons, primarily to improve traffic flow and simplify system maintenance. Adaptive control systems coordinate control of traffic signals across metropolitan areas, adjusting the lengths of signal phases based on prevailing traffic conditions. Information collected by detectors associated with arterial management systems may be shared between jurisdictional boundaries and with other components of metropolitan ITS infrastructure. Many jurisdictions have implemented traffic signal control systems that provide signal priority and preemption for transit and emergency vehicles, respectively. Arterial management systems may also include automated enforcement programs that increase compliance with speed limits and traffic signals. Figure 2-3 shows the format for the classification of benefits used in the taxonomy for arterial management systems.

For a summary of arterial management systems deployment in 78 of the largest U.S. cities, refer to www.itsdeployment.its.dot.gov.

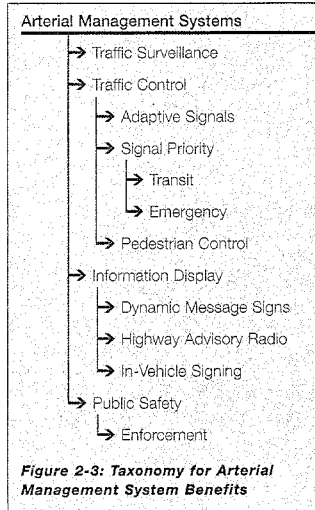
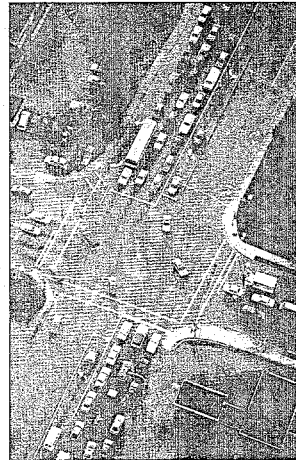

2.1.1 Summary of Arterial Management System Impacts

Based on the results of published evaluations, it appears that advanced traffic signal control systems, such as those providing adaptive control, provide a significant positive benefit. However, it is difficult to generalize an expected benefit for these services. Benefits for an individual area depend on a number of operational variables that are unique to each implementation. Variables may include the number of intersections or signals in a corridor, spacing of intersections, size of study area, corridor lengths, vehicle demand patterns, etc. It is possible to make some general conclusions based on reported results that should be useful to decision-makers.

Figure 2-4 presents the measured values for percent reduction in the number of stops due to improved traffic signal control as detailed in previous reports and in the following section of this report. Studies evaluated systems implemented in Toronto, Canada;⁶ Paris, France;⁷ Oakland County, Michigan;⁸ Los Angeles, California;⁹ and Madrid, Spain.¹⁰ Many of the cited studies evaluated the performance of adaptive control systems, while others investigated the impact of systems automating the selection of signal timing plans appropriate for particular time periods. As one would expect, if the flow of green bands in a corridor can be maintained as traffic patterns change, the number of stops can be reduced. The reported benefit of these systems ranges from a 10% to 41% reduction in stops; however, the small number of evaluations precludes statistical analysis of the results. Larger benefits are achieved when comparing improved signal control systems to systems using previously fixed timing plans in study corridors where significant variations in traffic patterns exist.

Figures 2-5 and 2-6 provide an overview of the impact of improved traffic signal operations on travel time and delay. The charts are based on evaluations of implemented systems discussed in the following section, as well as several discussed in previous ITS Benefits reports.^{11, 12, 13, 14, 15, 16, 17, 18} As expected, the reductions in travel time are far less than those reported for delay avoided. Furthermore, there is an apparent large range of possible values for each measure. A likely contributing factor to this range is that individual studies may define or measure travel time and delay differently. Travel time may be defined as the time required for an entire trip or the time needed to traverse a corridor or fraction of the trip. Delay may be defined as stopped time due to signals only or as the time exceeding a predetermined base travel time. Depending on the definitions used, and other operational conditions, estimated changes in travel time range from a 6% increase in travel time and 20% decrease. Likewise, reductions in delay due to adaptive control may range between 14% and 44%.

Reports evaluating the impacts of arterial management systems on energy consumption and the environment indicate that the impacts are generally positive, though relatively minor. Figure 2-7 depicts the impact of improved traffic signal control on fuel consumption, as described in evaluations of systems in Phoenix, Arizona;¹⁹ Paris, France;²⁰ Toronto, Canada;²¹ and Los Angeles, California.²² A few reports discuss the impacts of arterial management systems on motor vehicle emissions. The impact appears to be positive, with the exception of

⁶ Siemens Automotive, USA. "SCOOT in Toronto." *Traffic Technology International*. Spring 1995.

⁷ Betteille, J. and Briet, G. "Making Waves in Traffic Control." *Traffic Technology International*. Annual Review, 1997.

⁸ Barbaresso, James C. *Preliminary Findings and Lessons Learned From The Fast-Trac IVHS Program*. Road Commission for Oakland County. Beverly Hills, MI, 1994.

⁹ City of Los Angeles Department of Transportation. *Automated Traffic Surveillance and Control (ATSAC) Evaluation Study*. June 1994.

¹⁰ Peck, C., M. Blanco and J. Lopez. "Learning from the User: Next Steps for ITAC's Adaptive Control." *Traffic Technology International*. Annual Review, 1999. p. 135-158

¹¹ Zhou, Wei-Wu, et al. "Fuzzy Flows." *ITS: Intelligent Transportation Systems*. May/June 1997.

¹² Betteille, et al. 1997.

¹³ Siemens Automotive 1995.

¹⁴ Glasco, R, et al. *Studies of Potential Intelligent Transportation System Benefits Using Traffic Simulation Modeling*. Mitretek Systems Report (MP96W0000101). June 1996.

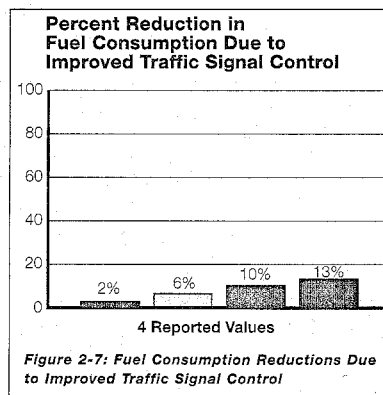
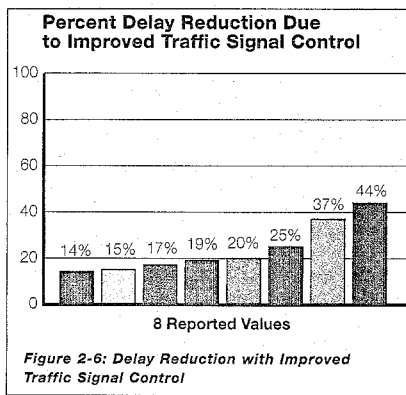
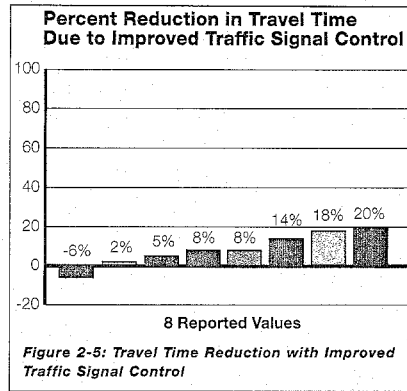
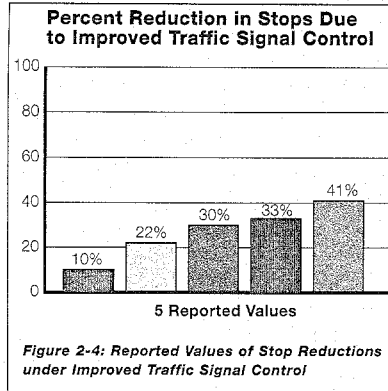

¹⁵ Glasco, R., et al. *Studies of Potential Intelligent Transportation System Benefits Using Traffic Simulation Modeling: Volume 2*. Mitretek Systems Report (MTR 1997-31), June 1997.

¹⁶ City of Los Angeles Department of Transportation 1994.

¹⁷ Abdel-Rahim, Ahmed, William C. Taylor and Ashok Bangia. "The Impact of SCATS on Travel Time and Delay". Eighth ITS America Annual Meeting, Detroit Michigan, 4-7 May 1998.

¹⁸ Peck, C., et al. 1999.

¹⁹ Zimmerman, C., et al. *Phoenix Metropolitan Model Deployment Initiative Evaluation Report*. FHWA Report (FHWA OP-00-015). Washington, DC: 2000.

²⁰ Beteille, et al. 1997.

²¹ Siemens Automotive 1995.

²² City of Los Angeles Department of Transportation 1994.

www.benefitcost.its.dot.gov

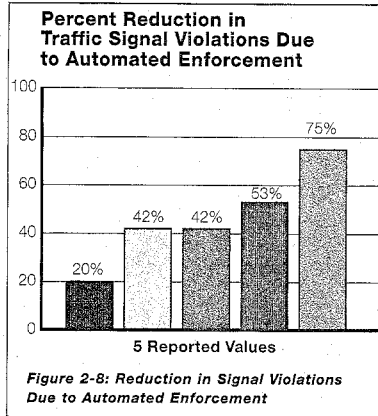

emissions of nitrous oxides. This is expected because increases in average vehicle speeds due to improved traffic flows lead to increased production of nitrous oxides while decreasing other harmful emissions.

Figure 2-8 illustrates the reduction in violations recorded by several cities that have implemented automated enforcement of traffic signals. While violation reductions cannot be directly translated into safety impacts of the enforcement systems, reductions in the number of vehicles violating the signal do indicate a positive impact on safety at the enforcement locations. The wide variety of violation reductions represented in the figure below is likely due to both differences in individual enforcement programs as well as measurement differences between areas. The following section discusses most recent evaluations of implementations of arterial management systems.

2.1.2 Summary of Most Recent Evaluations



The City of Sao Paulo, Brazil, installed an adaptive signal control system along the commuter, commercial, and service route on the Av. Lins de Vasconcelos. The system resulted in an average reduction in delay of 14.4% for a 15-hour period while speeds improved 14%. Mid-day average speeds improved 25%. Floating vehicle analysis of a similar implementation at 107 intersections in Madrid, Spain, found a decrease in average travel time of 5%. Flow through the area was improved by reducing the number of stops by 10% and delay by 19%.²³



A computer modeling effort investigated the potential impact of coordinating traffic signal timing plans among several jurisdictions along a congested arterial corridor leading into Seattle. The results of the model determined that coordinating the fixed signal timing plans along the corridor would result in a 7% reduction in vehicle delay, with no adverse impacts to cross-streets. The model also indicated that there would be no statistically significant change in vehicle emissions, the expected number of crashes along the corridor would fall by 2.5%, and the expected number of fatal crashes in a ten-year period would fall by 1.1%.²⁴



Anaheim, California, implemented the SCOOT adaptive signal control system within a three-square-mile area of the city containing four major event centers. Notably, this implementation required the SCOOT system to use existing mid-block vehicle detectors rather than detectors at the preferred locations near upstream intersections. A before-and-after evaluation of five test routes through the area found that the change in travel times ranged from a decrease of 10% to an increase of 15%. More circuitous routes involving more of the SCOOT system saw travel time changes from a 2% reduction up to an increase of 6%. The relative performance against the baseline system was better when there were no events at the centers being studied.²⁵

²³ Peck, C. et al. 1999.

²⁴ Jensen, M., et al. *Metropolitan Model Deployment Initiative Seattle Evaluation Report: Final Draft*. Federal Highway Administration Report (FHWA-OP-00-020). Washington, DC: May 2000.

²⁵ McNally, M.G., et al. *Evaluation of the Anaheim Advanced Traffic Control System Field Operational Test: Executive Summary*. California PATH Research Report (Report No. UCB-ITS-PRR-99-18). Berkeley, CA: July 1999.

These results indicate inconsistent performance of the SCOOT system with vehicle detectors in non-standard locations. Also, as implemented in Anaheim, the system appears to have more difficulty adapting to the extreme variations in traffic volume that occur during major events than the more minor variations present in daily operation.



A study at the busiest intersection along a transit route in Eindhoven, the Netherlands, investigated the impact of several transit signal priority strategies on the delay experienced by buses and private vehicle traffic. The study found that average total vehicular delay experienced during the three busiest hours at the intersection increased by 40 seconds per vehicle under absolute priority. There was no significant change in delay with the buses operating under conditional priority, which only provides a green signal for buses running behind schedule. This pattern held true for all of the surveyed hours, with absolute priority causing large delays to other traffic, while conditional priority caused little, if any, additional delay. Buses experienced an average of 27 seconds of delay without priority. This figure dropped to 3 seconds per bus with absolute priority. During conditional priority, the bus delay fell between these values. Ninety percent of all buses received zero-delay service under absolute priority. Only 74% of the late buses experienced zero-delay service under conditional priority, indicating a need to improve the system's determination of a vehicle's on-time status.²⁶ These results indicate that additional control of on-time schedule performance provided to transit operators by conditional priority causes little additional delay to other traffic.



A second study in Eindhoven investigated the impact of the signal priority system on the deviation of transit vehicles from schedule. Field measurements of vehicle schedule adherence before and after a major intersection found a 28-second difference in the change in average schedule deviation as vehicles traversed the intersection. Vehicles traveling through the intersection under conditional priority achieved a 17-second improvement in the average absolute value of schedule deviation, while vehicles traveling without the benefit of conditional priority generally increased the average value of schedule deviation by 11 seconds. Simulation to investigate the impact of various priority strategies along a four-stop hypothetical transit route also indicated that conditional priority had a positive impact on schedule reliability as measured through deviations from scheduled running times.²⁷ The improvements in schedule reliability for buses at the intersection studied and along the simulated route indicate the enhanced control of on-time schedule performance that conditional signal priority can provide to transit operators.



A simulation of emergency vehicle signal preemption at three intersections near a suburban hospital outside Washington, DC found that the average travel times of other vehicles using the intersections increased a minimal, though statistically significant, 2.4% when signals were preempted for emergency vehicles.²⁸

Studies at intersections in Los Angeles, California; Rochester, New York; and Phoenix, Arizona; indicate that automated pedestrian detection at traffic signals can improve safety. In general, there was an 81% decrease in the number of pedestrians crossing during a DON'T WALK with the addition of automated detection to intersections with operational push buttons. Conflicts encountered by pedestrians during the first half of the crossing were reduced 89% while conflicts for the second half were reduced 42%. Conflicts associated with right-turning vehicles were reduced 40%. All other conflicts were reduced 76%. Most of these reductions are attributed to reliable detection and signal extension for pedestrians in the process of crossing, not those waiting at the curb to

²⁶ Furth, Peter G. and Theo H.J. Muller. "Conditional Bus Priority at Signalized Intersections." 79th Annual Meeting of the Transportation Research Board. Washington, DC. 9-13 January 2000.

²⁷ Muller, Theo and Peter Furth. "Integrating Bus Service Planning with Analysis, Operational Control, and Performance Monitoring." ITS America 2000 Annual Meeting. Boston, Massachusetts. 1-4 May 2000.

²⁸ Bullock, Darcy, J. Morales, B. Sanderson. *Evaluation of Emergency Vehicle Signal Preemption on the Route 7 Virginia Corridor*. Federal Highway Administration Report (Publication No. FHWA-RD-99-070). Washington, DC. July 1999.

www.benefitcost.its.dot.gov

cross. In Los Angeles, using automated detection only with the push-button taped over, there was a 7% to 17% increase in conflicts, likely due to pedestrians not realizing that the signal was automatically detecting their presence.²⁹

 Floating-car studies of the coordination of traffic signals across two jurisdictions in the Phoenix, Arizona, metropolitan area found a 6.2% increase in vehicle speeds, 1.6% reduction in fuel consumption, a 1.2% increase in CO emissions and no significant change in HC or NO_x emissions, and a reduction in the crash risk along the mainline of 6.7%. The field trial and floating-car data collection, included coordination of signal cycle lengths for 8 of the 21 signals along the corridor. Simulation studies of traffic along the entire corridor indicated that the benefits experienced by test vehicles at the coordinated intersections could be counteracted by delays experienced at earlier signals along the corridor. Simulation of signal coordination along the full length of the corridor indicated potential benefits of a 21% reduction in AM peak delay. Results for independent optimizations without coordination indicated a potential for a 16% reduction in AM peak delay.³⁰

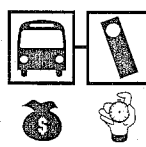
 Three European projects investigated the impacts of public transit priority systems. Each of the projects demonstrated significant delay or travel time reductions for transit vehicles. Travel time reductions ranged from 5 to 15% in the QUARTET PLUS and TABASCO projects, with field trials in Toulouse, France; Turin, Italy; Gothenburg, Sweden; and Munich, Germany. The project in Valencia, Spain, found a 30% reduction in delay for vehicles already behind schedule. These reductions led to improvements in operating efficiency, which in turn provide significant cost reductions for operators.³¹

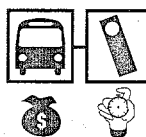
 After implementing traffic signal priority for a light-rail transit (LRT) line along an urban arterial in Toronto, Canada, system operators were able to remove one vehicle from service and maintain the same level of service to passengers along the corridor, reducing operating expenses. The system operators have some concern over the operation of the system at LRT stops just prior to signalized intersections and have also received complaints regarding increases in pedestrian delay due to the signal priority system.³²

 A transit priority system implemented on a bus line along an urban arterial in Vancouver, British Columbia, has reduced the variability of travel time experienced by buses along the route by 29% in the AM peak and 59% during the PM peak. The system uses conditional priority permitting transit vehicles to obtain signal priority if they are behind schedule as the vehicle approaches the intersection.³³

 The automated red-light enforcement system in New York, N.Y. began operation in 1993 with enforcement at 15 intersections; by 1998, 30 intersections were included in the program.³⁴ A 1997 Urban Transportation Monitor article cited a 20% reduction in violations over the life of the program.³⁵

²⁹ Hughes, Ronald, H. Huang, & C. Zeger. "ITS and Pedestrian Safety at Signalized Intersections." *ITS Quarterly*. Vol. VII, No. 2. Washington DC: ITS America, Spring/Summer 1999.

³⁰ Zimmerman 2000.

³¹ *Telematics Applications Programme - Transport Areas' Results (4th Funding Programme)*. European Commission Report. July 2000. [<http://www.trentel.org/transport/frame1.htm>]

³² Cima, Bart, et al. "Transit Signal Priority: A Comparison of Recent and Future Implementations." ITE 2000 Annual Meeting. Nashville, Tennessee. 6-10 August 2000.

³³ Cima 2000.

³⁴ Institute of Transportation Engineers. *Automated Enforcement in Transportation*. ITE Report (Publication No. IR-100). Washington, DC: ITE, December 1999.

³⁵ "Cameras Reduce Red Light Running Violations by 20-30%." *The Urban Transportation Monitor*. May 23, 1997.

 Howard County, Maryland, deployed red-light enforcement cameras at two intersections during a demonstration project. During the demonstration project, violators received warning notices in the mail. There was a 23% reduction in the number of violations per day at the two intersections after the public information campaign and mailing of violation notices commenced.³⁶ More recent reports from Howard County indicate that the program is successful. One intersection experienced 15 collisions during the year prior to implementation of a camera and eight collisions in the year following the installation. While the result was recorded too soon after implementation to be statistically significant, it may indicate a positive impact on safety at the intersections. Driver behavior has changed significantly at all intersections in Howard County where the cameras have been installed. The red light violation rate has dropped approximately 53% across all intersections with enforcement systems.³⁷

 Between the first and sixth months of operation of red light enforcement cameras in San Francisco, California, the ratio of violating vehicles to the total number of vehicles using the monitored approach decreased by 42%. San Francisco also implemented a public awareness campaign about the problem of red-light running at the time the automated enforcement program began.³⁸

 Oxnard, California, implemented an automated enforcement program very similar to the one implemented in San Francisco and also began a corresponding public awareness program. The enforcement program in Oxnard also achieved a 42% reduction in violations after only several months.³⁹

 Victoria, Australia, began its red-light enforcement program in 1983 and in 1999 the program included 35 cameras rotated among 132 sites around the Melbourne metropolitan area. A 1988 study found a 30% reduction in right-angle crashes due to the program and a 10.4% reduction in casualties from crashes.⁴⁰ A second study, in 1995, found that the number of red-light violations had been reduced between 35% and 60%, right-angle crashes decreased 32%, right-angle turning crashes decreased by 25%, and rear-end crashes decreased by 30.8%; however, rear-end turning crashes increased by 28.2%.⁴¹

 In the first year of operations, crashes caused by running red lights were reduced 9% at camera-monitored intersections in the city of Charlotte, North Carolina. The system has resulted in a violation reduction of 75%. Charlotte believes that giving the program a name and an extensive marketing program has been a major factor in the success of the system.⁴²

 A 1999 survey of drivers in five U.S. cities that employ red-light running enforcement cameras and five cities that do not use the cameras found that drivers in both groups of cities strongly favor the use of enforcement cameras. In cities currently using the cameras, 80% of drivers approved of their use, while in cities that do not have enforcement cameras, 76% of drivers were in favor of the systems.⁴³

³⁶ ITE 1999.

³⁷ Hansen, Lt. Glenn. "Can We Increase the Capability of Red Light Cameras?" *ITS World*, January/February 2000.

³⁸ ITE 1999.

³⁹ ITE 1999.

⁴⁰ Victoria Traffic Camera Office. Website, [<http://home.vicnet.net.au/~tco/index.htm>]. Melbourne, Australia: TCO, 1999. cited in ITE 1999.

⁴¹ Coleman, Janet A. et al. *FHWA Study tour for Speed Management and Enforcement Technology*. Federal Highway Administration Report (FHWA-PL-96-006). Washington, DC: February 1996. cited in ITE 1999.

⁴² "Branding is the Name of the Game in Enforcement." *ITS International*, May/June 2000, pp. 66-67.

⁴³ Retting, Richard A. "Reducing Red Light Running Crashes: A Research Perspective." 2000 ITE Annual Meeting. Nashville, Tennessee. 6-10 August 2000.

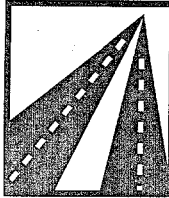

2.2 FREEWAY MANAGEMENT SYSTEMS

There are three major ITS functions that make up freeway management systems. Two of these are the monitoring and control of freeway operations. Monitoring and surveillance can be used to implement control and management strategies such as ramp metering rates and variable speed limits based on observed freeway conditions. The third function consists of displaying or providing information to the motorist. Motorists may receive this information in several ways, including Dynamic Message Signs (DMS), Highway Advisory Radio (HAR), In-vehicle Signing (IVS), or specialized information transmitted

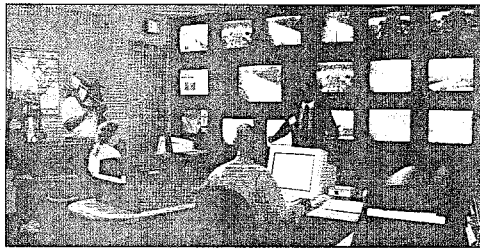
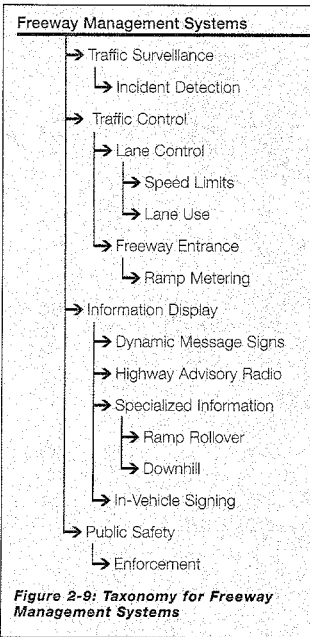

only to a specific set of vehicles. Other methods of providing traveler information are discussed in Section 2.9 of this report.

Automated enforcement is also used to improve safety by increasing compliance with speed limits and reducing aggressive driving. Figure 2-9 shows the classification of benefits data for freeway management systems.

For a summary of freeway management systems deployment in 78 of the largest U.S. cities, refer to www.itsdeployment.its.dot.gov.

2.2.1 Summary of Freeway Management Impacts

Data collected for freeway management systems have shown improvements to safety, reductions in travel time and delay, increased throughput, and flow improvements. Although each of these measures contains data points, only a few contain enough data for comparison and analysis. Much of the collected data have been related to ramp metering. Ramp metering has shown significant reductions in crashes, crash rates, and increased mainline travel speed. Table 2-1 outlines much of the ramp metering results collected and is compiled from data presented in previous benefits reports along with the new data highlighted in Section 2.2.2.

Location	Number of Meters	Freeway Coverage (km)	Crash Reduction	Secondary Crash Reduction	Crash Rate Reduction	Increase Speed	Reduced Travel Time	Delay Reduction	Increase Throughput Capacity	Demand Increase	Increase Traffic Volume
National Survey			15-50%			16-62%	48.0%		8-22%		17-25%
Seattle, WA					62.0%						10-100%
St. Paul, Minnesota						60%		11-93 hours	30.0%	2.9-7.2%	
Portland, OR	58		43%			60%	39.1%				25.0%
Minneapolis/St. Paul, MN	6	8	24%		38.0%	16%					
Minneapolis, MN	39	27	27%		38.0%	30%					32.0%
Minneapolis/St. Paul, MN*	430	338	21%			8%	22.0%		16.3%		9.9%
Seattle, WA	22				39.0%	20%	52.3%				86.0%
Denver, CO	5		50%								18.5%
Detroit, MI	28		50%			8%					12.5%
Austin, TX	3	4.2				60%					7.9%
Long Island, NY						9%					
Long Island, NY	70	207	15%			13%					
Amsterdam			35%	46%	23.0%						
German Autobahn			29%		20.0%						
Glasgow, Scotland									5.0%		

* Figures from the 2000 Minneapolis/St. Paul evaluation converted as needed from impact of ramp metering shutdown to impact of ramp metering operation.

Table 2-1: Summary of Ramp Metering Impacts

There are several interesting points to note from the table. First, there are three different evaluations of the ramp meters in the Minneapolis region. The difference between these studies is that the second one examined more than six times the number of meters and over three times the number of freeway kilometers as the first, yet both studies show similar results in crash and crash rate reductions. The most recent study, completed in February 2001, assesses the impact of the entire ramp metering system and also measured a similar crash reduction percentage. The variety of travel speed improvements between the studies is likely due to differences in the operating conditions of the different study areas under investigation. For example, speed improvements might be very significant in bottleneck areas, but modest at less congested interchanges.

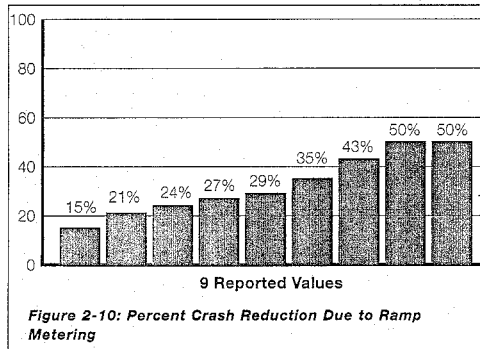

Figure 2-10: Percent Crash Reduction Due to Ramp Metering

Figure 2-10 summarizes the measured values for the percent reduction in crashes due to ramp metering of freeways in metropolitan areas. Ramp metering can reduce crashes by reducing the probability of sideswipes in merge areas. Also reduced are rear-end collisions that occur as vehicles slow to allow others to merge, or because vehicles on the

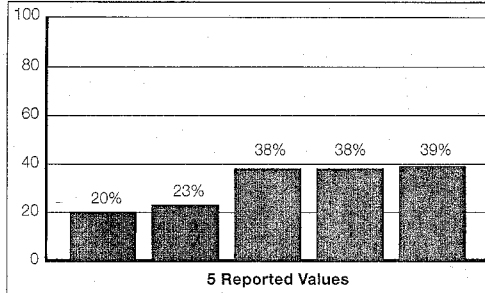

Figure 2-11: Percent Reduction in Crash Rates Due to Ramp Metering

ramp cannot merge. These reductions occur in both the mainline lanes as well as on ramps. Values of crash reductions reported range from 15% to 50%. Figure 2-11 illustrates the data reflecting reduction in crash rates, which range from 20% to 39%.

Ramp metering also has a positive impact on freeway speeds as summarized in Figure 2-12. These increases in speed imply significant travel time or delay savings. The range of speed increase is from 8% to 60%. This large range may be due to the differences in flow rates, geometric design of the freeway, number of meters, ramp spacing, or the length of freeway being measured. The figure also shows that the data appear to be grouped around low (8% to 16%) and high (60%) thresholds.

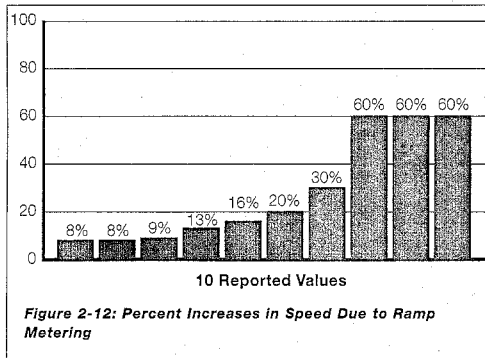

Figure 2-12: Percent Increases in Speed Due to Ramp Metering

2.2.2 Summary of Most Recent Evaluations

A recent study performed for the Minnesota Department of Transportation (Mn/DOT) revealed the impacts of shutting down the extensive ramp metering system on Minneapolis-St. Paul area freeways for a six-week evaluation period. The study analyzed data collected along four test corridors chosen to represent typical freeway configurations and conditions across the region. The study

collected a variety of data using several data collection techniques, including probe vehicles operating during peak periods, traffic volume counts from existing traffic detectors and temporary installations, crash statistics, and traveler surveys. Results from the evaluation indicate the generally positive impact of ramp meters:



- A 9% reduction in freeway volume without ramp meters, and a 14% reduction in peak period throughput (VMT).
- An average 22% decrease in freeway travel times with the meters on. The increase in travel times without the system more than offsets the elimination of ramp delays. Meters result in an annual systemwide savings of 25,121 hours.

- A 7% reduction in freeway speeds without meters.
- A 26% increase in crashes without meters.

Market research data collection results showed a number of changes in attitudes among area travelers that occurred once meters were shut down.

- Most survey respondents believed that traffic conditions worsened.
- Support for modifying the metering system, such as using faster cycle times, having shorter operating hours, and using fewer meters, increased from 55% to 69% of respondents.

 Analysis of the benefits and costs of the ramp metering system showed that when the costs of the entire congestion management system (including changeable message signs, traveler information, and other components) are factored in, the benefit/cost ratio for ramp metering is 5:1. When ramp meter benefits are compared to only those costs directly associated with ramp metering, the benefit/cost ratio is 15:1.⁴⁴

  A computer simulation study estimated the impact of a freeway management system on incident-related congestion in Fargo, North Dakota. Results of the investigation revealed an 8% decrease in network travel times and an 8% increase in speeds with the installation of dynamic message signs to notify travelers of alternative routes around incidents. The study also investigated the integration of the freeway management system with an adaptive signal control system on adjacent arterial roadways to accommodate diverted traffic, which resulted in an 18% reduction in travel times and a 21% increase in vehicle speeds during incident conditions.⁴⁵

 A study to examine the safety impacts and public opinion of the pilot Aggressive Driver Imaging and Enforcement (ADIE) program along the Capital Beltway in Montgomery and Prince George's Counties, Maryland, was conducted in 1998. The study used motorist surveys and speed measurements to determine the effectiveness of the imaging and enforcement system and a related media campaign carried out in November 1997. The system began operation in January 1998. The ADIE system consisted of a specially trained police officer using several ITS technologies mounted in a dedicated police vehicle positioned at appropriate locations along the Beltway. The system allowed the officer to identify aggressive drivers and trigger an automated camera that photographed both the entire vehicle and the license plate. Warnings were mailed to offenders, but no penalties were assessed during the pilot program. Before-and-after surveys were distributed to residents in the vicinity of the Beltway, Commercial Vehicle companies operating on the Beltway, and truck drivers at a rest area near the I-95 and I-495 Interchange in Maryland. Approximately 4,000 copies of the survey were distributed in April 1997 and again after the system began operation, with approximately 1,000 surveys returned each time. Survey results indicated that the media campaign was effective in increasing motorists' awareness of the aggressive driving problem, with the number of respondents indicating that aggressive driving was a problem increasing from 19% to 54%. Prior to implementation, 82% of survey respondents favored using video technology for traffic enforcement, while 86% favored its use afterwards. The study analyzed speed data from automatic recording stations at three locations along the Beltway to assess the impact of the system on vehicle speeds. There was a significant reduction in the number

⁴⁴ Cambridge Systematics, Inc. *Twin Cities Ramp Meter Evaluation*. Prepared for Minnesota Department of Transportation. February 1, 2001.

⁴⁵ Birst, Shawn and Ayman Smadi. "An Evaluation of ITS for Incident Management in Second-Tier Cities: A Fargo, ND Case Study." ITE 2000 Annual Meeting. Nashville, Tennessee. 6-10 August 2000.

www.benefitcost.its.dot.gov

of vehicles exceeding 60 mph (the Beltway speed limit is 55 mph) in March 1998 when compared to March 1997. Two of the three recording stations showed decreases while one revealed an increase in the number of vehicles traveling at more than 60 mph. Due to the incomplete development of the system, related technical problems hindering its application, and the short duration of the study period, overall safety impacts such as any reduction in the number of crashes could not be assessed.⁴⁶



The traffic management system for Highway 401 in Metropolitan Toronto is known as COMPASS. COMPASS was developed to provide safe and efficient travel on 42 km of the highway. It consists of loop detectors to determine traffic speed, volume, and density along with closed circuit television (CCTV) cameras monitoring the highway. Incident conditions and delay are monitored along the highway. Information is then sent to dynamic message signs, the media, fax machines, and radio stations for delivery to travelers. The benefits of the system include a cost savings of over \$10 million per year from reduced crash, travel time, and vehicle operation costs. Incident duration has been reduced from an average 86 minutes to 30 minutes, while average incident-related delay is reduced by 537 vehicle hours per incident systemwide. This results in over 300,000 vehicle-hours of delay saved each year. By displaying messages on the dynamic message signs, 200 crashes per year are also saved. Average speeds have also improved between 7% and 19%.⁴⁷

⁴⁶ Daniel Consultants, Inc. *Aggressive Driver Imaging and Enforcement: Evaluation Report - Impact of Media Campaign and Effects on Safety and Productivity*. Report prepared for Science Applications International Corporation. September 11, 1998.

⁴⁷ Institute of Transportation Engineers. *1996 ITS Tour Report: Eastern North America & 1996 ITS World Congress*. ITE Report. Washington, DC: 1997.

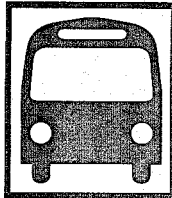

2.3 TRANSIT MANAGEMENT SYSTEMS

Advanced Public Transportation Systems (APTS) include a number of ITS applications that can help transit agencies increase the safety and operational efficiency of the nation's transit systems. Remote monitoring of transit vehicle status and passenger activity helps to provide additional safety and security to passengers. Transit ITS services also assist operators in maintaining vehicle fleets. Vehicle self-diagnostics can alert mechanics of unexpected mechanical problems as well as routine maintenance needs. Automated vehicle location (AVL) and computer aided dispatch (CAD) can improve scheduling activities and schedule adherence. Figure 2-13 shows the taxonomy for benefits of transit management systems described in this section. Transit signal priority and electronic fare payment, discussed in sections 2.1 and 2.7, respectively, also provide significant benefits to transit operations.

Transit management systems have demonstrated that they are capable of reducing travel time both by improving the operation of the vehicles and the overall operation of the transportation network. Transit management systems

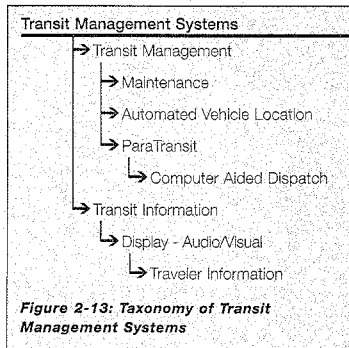

improve schedule adherence and the dissemination of schedule and route information to passengers, resulting in a reduction in passenger wait time and improvement in transfer coordination.

Also, APTS applications reduce the cost of system operations by improving staff productivity and the utilization of facilities and equipment.

For a summary of transit management systems deployment in 78 of the largest U.S. cities, refer to www.itsdeployment.its.dot.gov.

2.3.1 Summary of Transit Management System Impacts

Combined CAD/AVL systems are some of the most widely deployed APTS applications.⁴⁸ Analysis of these systems has begun to reveal their quantifiable impacts on schedule reliability. The unique conditions faced in each application of CAD/AVL and the different performance metrics used in evaluating them, make summary assessments of the systems difficult. Figure 2-14 contains three reported values of the impact of these systems on the on-time performance of the transit systems that implemented them. Results in the figure are from evaluations of implementations in Portland, Oregon;⁴⁹ Kansas City, Missouri;⁵⁰ and Baltimore, Maryland.⁵¹ Regardless of the performance measures used, many system evaluations indicate positive impacts on schedule reliability and operational efficiency. In addition to improvements in on-time performance, CAD/AVL systems allow agencies to gain the most from their vehicle resources, providing valuable information for operational control strategies that can reduce the number of vehicles necessary to provide the required level of service to transit passengers.

Passenger surveys reveal high levels of customer satisfaction with implemented APTS applications. Transit patrons appreciate the benefits of improved communication of transit route and schedule information through a variety of information dissemination technologies. The various surveillance technologies used in APTS also improve the safety and security of transit systems.

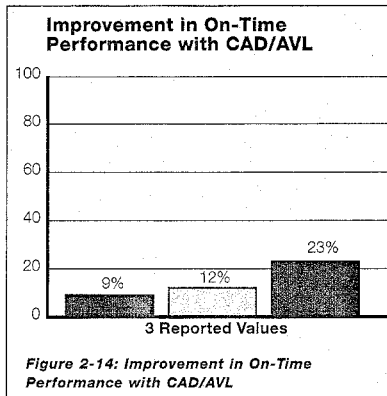



Figure 2-14: Improvement in On-Time Performance with CAD/AVL

2.3.2 Summary of Most Recent Evaluations

 Metro Online, a website providing route and schedule information for the Seattle area bus system, provides a valuable service to its users. Many users indicated, in a survey, that they had been long-term users of this ITS service. Several recommended potential improvements to the site, including improvements to the route planning and transfer sections of the site.⁵²

 Customer satisfaction was also high for Transit Watch, a system that provides actual arrival and departure information for passengers at key transit centers in Seattle. Transit riders indicated that they would like to see the information available at places where travel decisions are made. While the system did not increase the

satisfaction of existing riders with the transit system as a whole, new riders were pleased with the system, which may indicate that it could help the bus network retain new transit patrons.⁵³

⁴⁸ Casey, R., et al. *Advanced Public Transportation Systems: The State of the Art - Update - 96*. Federal Transit Administration Report. Washington, DC: January 1996.

⁴⁹ Strathman, James G., et al. "Service Reliability Impacts of Computer-Aided Dispatching and Automatic Vehicle Location Technology: A Tri-Met Case Study." *Transportation Quarterly*. Vol. 54 No. 3, Summer 2000, pp. 85-100.

⁵⁰ Giugno, M. *Milwaukee County Transit System: Status Report*, July 1995.

⁵¹ "Intelligent Time Savers, Life Savers." *ITS Update*, December 1997.

⁵² Jensen, M., et al. 2000.

⁵³ Jensen, M., et al. 2000.



Since implementing an Automatic Vehicle Location (AVL) system, the Denver Regional Transportation District (RTD) has provided its transit customers with higher quality service. The RTD decreased the number of vehicles that arrived at stops early by 12% between 1992 and 1997. The number of passengers per vehicle that arrived at stops late decreased by 21%. Customer complaints decreased by 26% per 100,000 boardings, in part due to improved schedule adherence by RTD. Provision of a silent alarm feature with the AVL system has helped improve the safety of the transit system. Passenger assaults per 100,000 passengers decreased by 33% between 1992 and 1997.⁵⁴



The Outreach paratransit transportation broker in San Jose, California, realized significant benefits after implementing a digital geographic database, an Automatic Vehicle Location system on a portion of the vehicles under contract to Outreach, and an automatic scheduling and routing system. Outreach benefited from increased ridership, better on-time performance, and a \$500,000 reduction in operating costs during the first year of operation. A study of the system revealed an increase in the number of shared rides from 38% to 55% of all rides provided, a reduction in the size of the paratransit fleet from 200 to 130 vehicles, and a reduction in the cost per passenger mile from \$4.88 to \$3.72.⁵⁵



Portland, Oregon's, Tri-Met System achieved a 9.4% improvement in on-time performance after implementing an AVL and CAD systems. The variability in the headways between buses decreased by 5% after implementation of the improvements. No significant change was measured in the average run times for buses along the routes, with run times remaining about 1% longer than their scheduled values. The average coefficient of variability for bus run times did improve by 18%, however, and no route experienced an increase in run time variability. These benefits indicated by the comparison of before and after data are consistent with the improved control available to transit supervisors after the implementation of the AVL and CAD systems. A modeling effort using the collected data to control for external impacts on bus run times determined that the impact of the AVL/CAD system was to improve running times by 3.4%. Increases in the average number of stops made, the scheduled headways of buses, and the average departure delay of buses beginning their routes counteracted this improvement. This indicates that the AVL/CAD system allowed the Tri-Met to accommodate these changing conditions without increasing bus run times.⁵⁶



A demonstration system in Valencia, Spain, incorporated a dynamic bus scheduling system and a remote maintenance monitoring system. This system led to efficiency gains including a 35% reduction in the time it takes to create a bus schedule and a 10% improvement in the cost-effectiveness of schedules through reductions in waiting time. The maintenance system enabled a 20% to 30% reduction in the time required to detect and correct vehicle faults.⁵⁷



A European study investigating the use of Travel Dispatch Centers for coordinating and managing paratransit services demonstrated significant cost savings over previous implementations. Accounting for implementation costs, the system resulted in a 2% to 3% annual decrease in costs to provide paratransit service, which compares favorably with the previous experiences of a 15% annual increase.⁵⁸

⁵⁴ Weatherford, Matt. *Assessment of the Denver Regional Transportation District Automatic Vehicle Location System*. U.S. Department of Transportation Report (DOT-VNTSC-FTA-00-04). Cambridge, MA: John A. Volpe National Transportation Center, August 2000.

⁵⁵ Taylor, Steven T. "Reaching Out with ITS." *ITS World*. March/April 1997. pp. 24-28.

⁵⁶ Strathman 2000.

⁵⁷ *Telenatics Applications Programme 2000*.

⁵⁸ *Telenatics Applications Programme 2000*.

www.benefitscosts-its.dot.gov

 A 1998 survey of transit riders in Ann Arbor, Michigan, assessed the impact of several transit safety and security enhancements including on-board video surveillance, emergency phones, video cameras at transit centers, enhanced lighting at transfer centers, and increased police presence. The surveillance systems were the safety enhancement most often noticed by respondents. The on-board cameras were noticed by 70% of the respondents and the transit center cameras by 63%. Additional police presence was noticed by 51% of respondents, while the increased lighting was noticed by 42%. Only 28% of those responding to the survey noticed the emergency phones installed at transfer centers. Respondents rated all improvements very highly when asked the degree to which each improved their sense of security.⁵⁹

2.4 INCIDENT MANAGEMENT SYSTEMS

It is projected that by the year 2005, incident-related congestion will cost the U.S. public over \$75 billion in lost productivity and will result in over 8.4 billion gallons of wasted fuel.⁶⁰ Incident management systems can reduce these effects by decreasing the time to detect incidents, reducing the time for responding vehicles to arrive, and by decreasing the time required to return the facility to normal conditions. Freeway service patrols, which began prior to the emergence of ITS technologies, but are being incorporated into traffic management centers, significantly reduce the time to clear incidents, especially minor incidents. It is generally understood that incident management systems are implemented concurrently with freeway management systems, but it is important to keep in mind that arterials can be included in incident management programs as well. Coverage of arterials by incident management programs is increasing, particularly in areas with well-established programs. The classification of benefits data for incident management systems is summarized in Figure 2-15.



For a summary of incident management systems deployment in 78 of the largest U.S. cities, refer to www.itsdeployment.its.dot.gov.

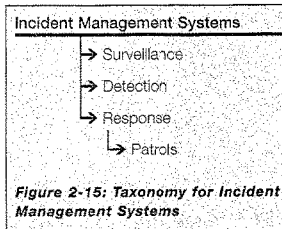

Figure 2-15: Taxonomy for Incident Management Systems.

2.4.1 Summary of Incident Management Impacts

Table 2-2 summarizes much of the data collected for incident management impacts. Incident management programs have shown the potential to reduce the number of crashes and the time required for the detection and clearance of incidents. These programs show significant savings in the cost of congestion and are cost-effective. In addition, the public response to these programs has been very positive.

⁵⁹ Wallace, Richard R., et al. "Who Noticed, Who Cares? Passenger Reactions to Transit Safety Measures." *Transportation Research Record No. 1666*. Washington, DC: Transportation Research Board, 1999. pp. 133-138.
⁶⁰ Booz Allen, and Hamilton. *Incident Management: Detection, Verification and Traffic Management*. Filed Operational Test: Cross-Cutting Study. September 1998.

Location	Reduced Incident Clearance Time	Reduced Response Time	Crash Reduction	Secondary Crash Reduction	Reduced Crash Rates	Cost Savings/yr. (\$ millions)	Delay Savings (hrs/yr)	Percent Delay Savings	Fuel Savings (Gallons)
Brooklyn, NY	66.0%								
Philadelphia, PA			40.0%						
San Antonio, TX		20.0%	35.0%	30.0%	41.0%	1.65	255,500		2,600
Japan				50.0%					
Houston, TX						8.40	572,095		
Denver, CO						0.95	95,000		
Atlanta, GA							2,000,000	5.00%	
Minnesota						1.40			
Atlanta, GA	38.0%								
Georgia Navigator	23 min	30.0%				44.60	547,000		

Table 2-2: Summary of Incident Management Data

Figures 2-16 and 2-17 show the range of values reported for cost savings and delay savings. Both of these measures are a function of the study area and implementation methodology. Thus the results show a wide range of possible values.

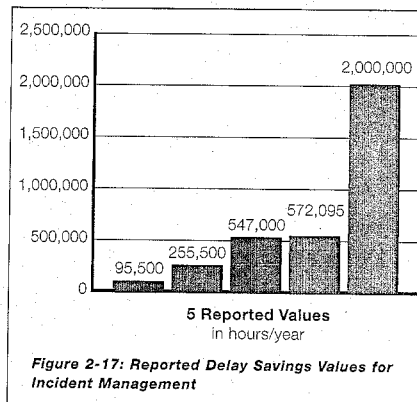
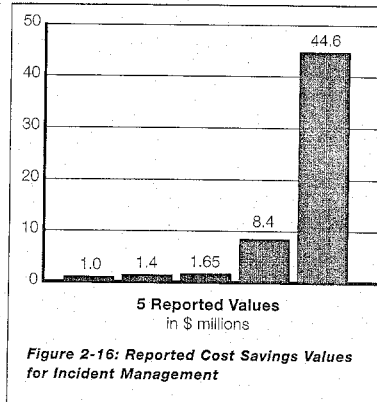

www.benefitcost.its.dof.gov

2.4.2 Summary of Most Recent Evaluations



Results from the evaluation of nine ITS implementation projects in the city of San Antonio, Texas, indicate that the most effective stand-alone implementation is incident



management, which showed improvements in all impact measures assessed. DMS and arterial traffic signal control can provide additional improvement under many of these areas. For a particular corridor modeled during this study, optimum implementation of the integrated DMS and incident management result in a 5.7% decrease in delay, a 2.8% decrease in crashes, and a 1.2% decrease in fuel consumption annually. Integrated use of incident management, DMS and arterial traffic control can achieve an annual benefit of a 5.9% reduction in delay, a 2.0% decrease in crashes, and a 1.4% decrease in fuel consumption for travelers in the corridor. Focus group studies indicate that customers are satisfied with the DMS system, but do have some suggestions for improvement. Participants in the focus groups felt that DMS were a reliable source of traffic information, primarily when they are located close to the congestion or incident.⁶¹



Georgia's Intelligent Transportation System, "NAVIGATOR," includes several ITS elements. Elements include freeway management, incident management, transit management, electronic toll collection, electronic fare payment, and signal control. Operators can update dynamic message signs, ramp meters, the web site, and information kiosks quickly with a click of a mouse. Operators can also dispatch emergency response and change traffic signal timings. An evaluation of NAVIGATOR concentrated on the freeway and incident management system component and determined the following impacts:⁶²

- Reduced response, identification, and dispatch time for incidents to two minutes (a 30% reduction).
- A 23-minute reduction in incident duration during 1997, resulting in cost savings of \$44.6 million due to reduced delay time (did not include environmental benefits and benefits due to ramp metering during incidents).
- A 2.3:1 benefit/cost ratio for 1997 for the freeway and incident management components (based on a capital investment of \$72 million for these components).
- Other benefits include air quality impact reductions, fuel consumption improvements, crash reduction, more efficient use of emergency services and more satisfied travelers.



Freeway service patrols have proven to be one of the most successful aspects of an incident management program for reducing incident detection time and duration. With a high benefit-cost ratio (ranging from 2:1 to 36.2:1), programs such as these are popular with the motoring public, politicians, and the agencies that support and operate them. Table 2-3 summarizes several benefit/cost ratios reported.⁶³

⁶¹ Carter, M. et al. *Metropolitan Model Deployment Initiative: San Antonio Evaluation Report (Final Draft)*. FHWA Report (FHWA-OP-00-017). Washington, DC: May 2000.

⁶² Presley, Michael, et al. *Calculating Benefits for NAVIGATOR: Georgia's Intelligent Transportation System*. Georgia Department of Transportation. September 1998.

⁶³ Fenno, David W., and Michael A. Ogden. "Freeway Services Patrols: A State of the Practice." 77th Annual Meeting of the Transportation Research Board. Washington, DC: January 1998.

Patrol Location	Patrol Name	Year Performed	B/C Ratings
Charlotte, NC	Incident Management Assistance Patrol	1993	3:1 to 7:1
Chicago, IL	Emergency Traffic Patrol	1990	17:1
Dallas, TX	Courtesy Patrol	1995	3.3:1 to 36.2:1
Denver, CO	Mile High Courtesy Patrol	1996	20:1 to 23:1
Detroit, MI	Freeway Courtesy Patrol	1995	14:1
Fresno, CA	Freeway Service Patrol	1995	12.5:1
Houston, TX	Motorist Assistance Program	1994	6.6:1 to 23.3:1
Los Angeles, CA	Metro Freeway Service Patrol	1993	11:1
Minneapolis, MN	Highway Helper	1995	5:1
New York & Westchester Co., NY	Highway Emergency Local Patrol	1995	23.5:1
Norfolk, VA	Safety Service Patrol	1995	2:1 to 2.5:1
Oakland, CA	Freeway Service Patrol	1991	3.5:1
Orange Co., CA	Freeway Service Patrol	1995	3:1
Riverside Co., CA	Freeway Service Patrol	1995	3:1
Sacramento, CA	Freeway Service Patrol	1995	5.5:1

(Adapted from Fenno and Ogden; see previous page)

Table 2-3: Results of Service Patrol Benefit-Cost Studies

www.benefitscost.its.dot.gov

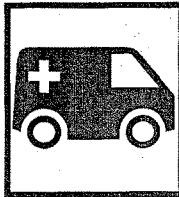

2.5 EMERGENCY MANAGEMENT

Benefits of emergency management include those derived from improved notification, dispatch, and guidance of emergency or other response equipment when an incident occurs, as shown in Figure 2-18. These benefits are sometimes highly dependent on the related implementations of incident management systems, which often detect the need for emergency response to incidents on the transportation network. Applications of ITS in emergency management typically consist of automatic vehicle location, computer aided dispatch, fleet management, and vehicle guidance systems. Each of these systems can help decrease the response time of emergency vehicles to incident scenes and aid public safety agencies in improving their operational efficiency.

The U.S. Department of Transportation recently initiated an ITS Public Safety program. As this program guides the development of ITS applications for public safety agencies such as police, fire, and rescue departments, improved information on the benefits of ITS to emergency management should develop.

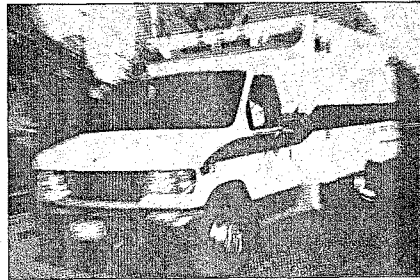
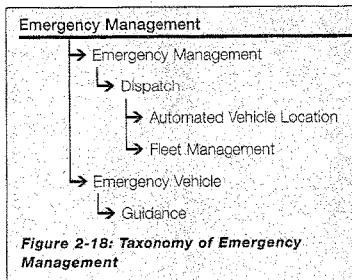

For a summary of emergency management systems deployment in 78 of the largest U.S. cities, refer to www.itsdeployment.its.dot.gov.

2.5.1 Summary of Emergency Management Impacts

Very few new data have been collected in the area of Emergency Management since the 1999 version of this report. Therefore, data highlighted in this section are from the 1999 report.

Albuquerque, New Mexico, uses a map-based computer-aided dispatch system in its ambulance fleet. The system allows the dispatch center to send ambulances to the exact location of an emergency and provide guidance on how to get there. As a result, the company's efficiency has increased by 10 to 15 percent.⁶⁴

⁶⁴ Taylor, Steven T. "Helping Americans." *ITS World*, Jan/Feb 1997.



Palm Beach County, Florida, installed the Priority One signal preemption system. The system is used to connect the Global Positioning System (GPS) to its emergency vehicles. Prior to installation, it was predicted that the system could cut 20% from incident response time, depending on the intersection and time of day (as found by two Illinois towns using the system). As the vehicle approaches a traffic light, it transmits a signal interrupting the normal cycle, which allows the emergency vehicle to go through it without stopping. The GPS system will also allow dispatchers to figure out who is closer to an emergency. The cost is about \$4000 per intersection and \$2000 per vehicle.⁶⁵



The Puget Sound Help Me (PuSHMe) Mayday System allowed a driver to immediately send a response center a notification and location of incidents along with the need for any assistance. The system includes two-way pagers and cellular telephones that transmit vehicle location, nature of the problem, and the priority level of the problem to a response center. The devices may also send automated signals when the driver may be incapable of manually initiating a signal. Ninety-five percent of drivers equipped with voice communications felt they were more secure, while just 70% of those with only data communications said that they were more secure with the system installed.⁶⁶

⁶⁵ Shifrel, Scott. "Satellites Around Globe May Save Lives Right Here." *The Palm Beach Post*, June 1, 1997.

⁶⁶ Haselkorn, M., et al. *Evaluation of PuSHMe Mayday System*: Final Report. June 19, 1997.

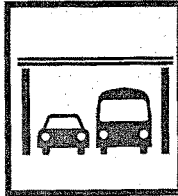

2.6 ELECTRONIC TOLL COLLECTION

Electronic Toll Collection (ETC) is one of the ITS program areas where little new benefits information is required. Benefits due to impacts on the cost of toll administration, management, and collection have been demonstrated. Vehicle delay reduction and throughput at toll plazas have been proven to be very high. Therefore, many of the recent reports for applications of ETC have concentrated on the accuracy and improvements in vehicle identification. Technologies are now capable of identifying vehicles at mainline speeds and at a high rate of accuracy. As a result, throughput is maximized, and delay that would occur at toll plazas is substantially

reduced. There are also several efforts planned or underway to integrate these systems with other possible electronic payment systems, such as parking, transit fare payment, and drive-through window payment.

For a summary of electronic toll collection deployment in 78 of the largest U.S. cities, refer to www.itsdeployment.its.dot.gov.

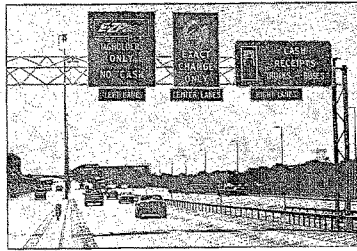

2.6.1 Summary of Most Recent Evaluations

The evaluation of air quality benefits from implementing automatic vehicle identification (AVI) technology for electronic toll collection (ETC) has demonstrated positive results.

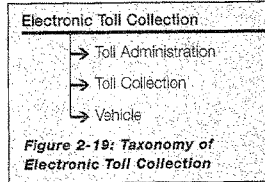

Located in Orlando, Florida, the Orlando-Orange County Expressway Authority (OOCEA) operates 11 mainline toll plazas. The busiest, the Holland East Toll Plaza, includes 14 toll lanes, nine of which are used for peak direction travel. A before-after study on the Express Pass (E-PASS) implementation of AVI-based ETC at the toll plaza was conducted to evaluate the reduction in vehicle emissions. Specifically, the reductions in Carbon Monoxide (CO), Hydrocarbons (HC), and Nitrogen Oxides (NO_x) were evaluated at the toll plaza. Data

for the before AVI study were collected from August 1994 to October 1994. Arrival, departure, and speed data were collected during the peak morning hour (7-8 AM) for 14 days across all nine lanes in the westbound direction at the plaza. The after study data were collected from July 1996 to August 1996 during the peak morning hour (7-8 AM) in the westbound direction for 10 days. During this phase of the study, two dedicated lanes were configured for AVI/ETC operations. A comparison of before and after data revealed that the total average number of vehicles using the Holland East Toll Plaza during the peak hour increased by an average of 30% (1270 vehicles). Also, the average number of E-PASS users in the "after" study during the peak hour compared to the total volume is 40%. This is significant when considering that there were no E-PASS users in the "before" study. Using the MOBILE5a emission model and collected data, it was shown that even with the increased volumes at the Holland East Toll Plaza, vehicle emissions were reduced. The model estimated an overall average reduction in Carbon Monoxide by 7.29% (5.21 kg) and HC by 7.19% (0.40 kg), but NO_x increased by 33.77% (2.21 kg). Two additional scenarios were run to control for the growth in volumes on the results. The results remained consistent with the before-after study but demonstrated larger benefits.⁶⁷

 A cost-benefit analysis was undertaken as part of an Electronic Toll and Traffic Management (ETTM) feasibility study for Florida's Turnpike. Tamiami Plaza, the most heavily utilized of all the Turnpike mainline toll plazas, was selected for the study. For the 10% ETTM participation alternative, the benefit-to-cost (B/C) ratio was 2.03:1. For 30% ETTM, the B/C ratio was 2.29:1, and for 50% ETTM, the B/C ratio was 3.07:1.⁶⁸

 A report published in July 2000 summarizes the evaluation results for many types of ITS projects implemented in Europe between 1994 and 1998, including road pricing facilitated by electronic toll collection. Impact analysis of electronic toll collection in urban areas found up to a 17% reduction in traffic due to a road-pricing scheme. Most of the population was found to be against road pricing schemes, but if the programs were accompanied by reductions in vehicle and fuel taxes, acceptability rises to 61%.⁶⁹ These impacts are due to a road-pricing scheme facilitated by electronic toll collection, which could also be implemented without ETC, likely with a higher operating cost.

 An assessment of the impact of a value-pricing program for two toll bridges in Lee County, Florida, was evaluated. The program allows motorists to pay a 50% discounted bridge toll during designated hours just outside the typical AM and PM peak periods. Only those drivers participating in the electronic prepayment program were eligible for the reduced tolls, as they were collected automatically via in-vehicle transponders mounted on the vehicle's windshield. A traveler survey of Lee County residents and collection of vehicle volume data at the toll plazas are the basis for the results presented in the study. The program began in August 1998. The analysis indicated that there was a significant shift in travelers away from the peak (full toll) periods to the non-peak (discounted toll) periods by those drivers who possessed the necessary transponders. A random telephone survey of 400 motorists in the county took place several months after the program began operation, between November 30 and December 5, 1998. Of the 193 travelers who had transponders in their vehicles, 38 (20%) responded that they had made changes in their travel due to the new program. Analysis indicated that travelers who modified their travel plans were more likely to be retired or working part-time. The survey results indicated that commuters were less likely to modify their schedules as a result of variable pricing than those with other trip purposes.⁷⁰ These impacts are also due to a road-pricing scheme facilitated by electronic toll collection, which could also be implemented without ETC, but probably with higher operating costs.

⁶⁷ Klondzinski, J.G., et al. "Impacts of Electronic Toll Collection on Vehicle Emissions." 77th Annual Meeting of the Transportation Research Board, Washington, DC, January 1998.

⁶⁸ Pietrzyk, Mike, et al. "Cost-Benefit Analysis of Electronic Toll and Traffic Management." Proceedings of the IVHS America 1992 Annual Meeting, Volume I, 1992.

⁶⁹ *Telematics Applications Programme 2000*.

⁷⁰ Burris, Mark and Ashley Yelds. "Using ETC to Provide Variable Tolling: Some Real-World Results." ITS America 2000 Annual Meeting, Boston, Massachusetts, 1-4 May 2000.

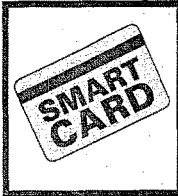

2.7 ELECTRONIC FARE PAYMENT

Electronic fare payment is another one of the ITS program areas where little new benefits information has been required to justify implementation. Electronic fare payment tests, which address customer convenience and security, are ongoing in both bus and rail systems. Results indicate increased convenience to the customer, and significant cost savings in the administrative and money handling processes of the service providers. In some cases, it has also been reported that electronic fare payment can increase transit ridership.





For a summary of electronic fare payment deployment in 78 of the largest U.S. cities, refer to www.itsdeployment.its.dot.gov.

2.7.1 Summary of Most Recent Evaluations

 A report published in July 2000 summarized the evaluation results for several ITS projects implemented in Europe between 1994 and 1998. Three projects discussed demonstrated the coordinated use of a smart card as a payment system for public transit, canteens, libraries, swimming pools, and/or other city services. User acceptance and satisfaction with these systems was very high, ranging from 71% to 87%.⁷¹

Other benefits reported for using electronic fare payment include:⁷²

 Ventura County, California: Smart card system will save an estimated \$9.5 million per year in reduced fare evasion; \$5 million in reduced data collection costs, and \$990,000 by eliminating transfer slips.

 New York City: Metro Card system will save an estimated \$70 million per year in fare evasion, resulting in increased revenues of \$34 million from merchant fees and revenue float, \$140 million from unused value on the cards, and \$49 million from increased ridership.

 New Jersey: estimated savings of \$2.7 million in reduced handling costs of fare media, increased revenues of 12% after automated fare collection implementation.

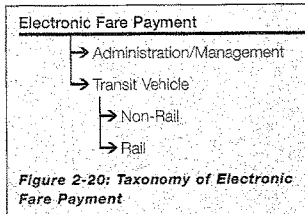

⁷¹ Telematics Applications Programme 2000.

⁷² APTS Benefits. Federal Transit Administration, November 1995.

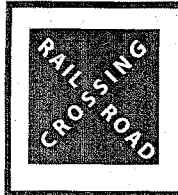

2.8 HIGHWAY-RAIL INTERSECTIONS

The number of crashes that occur at highway-rail intersections (HRIs) on a yearly basis indicates the need for improvements at HRIs. In addition, the occasional spectacular crash including school buses or hazardous materials attracts national attention.

However, the number of crashes occurring at HRIs has continued to decline over the last several years. As of January 2001, preliminary statistics show that from January to October 2000 2,776 HRI incidents were reported. This number is down 4.5% from that of the same period in 1999 (almost 14% from the same time period for 1997). The number of fatalities at HRIs increased from 331 to 351 (6%) between the two time

periods. The general trend has been a decrease in HRI fatalities since 1997. HRI incident rates, calculated as the number of incidents multiplied by 1,000,000 then divided by the total number of train miles, has also shown a downward trend (18.8% since 1997).⁷³ It should be noted that these reductions are not related to ITS implementations. Instead they may be due to aggressive educational programs, such as "Operation Lifesaver" and the extensive use of the media to promote railroad safety issues over the last several years, as well as the physical reduction in the number of HRIs. The goal of the HRI user service is to further improve safety at these crossings and to improve the coordination between rail operations and traffic management functions.

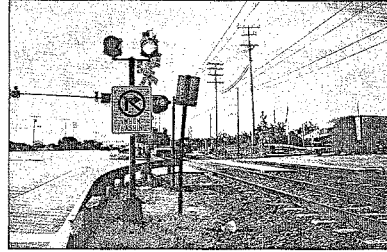

Several operational tests involving coordinating traffic signals and notifying vehicles of approaching trains at intersections are currently being developed and implemented. A few pilot projects have produced results, but are insufficient to develop overall conclusions. Several other projects are being planned or are now in progress and are expected to produce quantitative data on benefits. Figure 2-21 illustrates the classification of benefits data for highway-rail intersections.

For a summary of highway-rail intersection systems deployment in 78 of the largest U.S. cities, refer to www.itsdeployment.its.dot.gov.

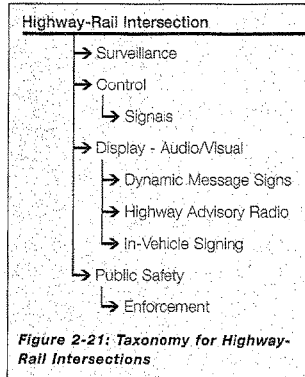



⁷³ Federal Rail Administration, Office of Safety.

www.benefitcost.us.dot.gov

2.8.1 Summary of Most Recent Evaluations

 Minnesota DOT investigated the effectiveness of an in-vehicle train crossing warning system for school buses in Glencoe County. Transmitters mounted at five rail crossings transmitted warning signals to school buses in the vicinity of the crossings. The system notified drivers of both the presence of the crossing and whether or not a train was approaching. The evaluation of the project consisted of a questionnaire distributed to drivers and train operators. Drivers felt that the system enhanced awareness of the crossings and approaching trains; however, there were no significant changes in driver behavior. The drivers' confidence in the system's reliability was evenly divided.⁷⁴

 To reduce train horn noise at heavily used highway-rail grade crossings in Ames, Iowa, an automated horn system to warn motorists and pedestrians was installed in September 1998. Working in conjunction with existing gates and lights, two horns at each intersection are aligned to provide a more directed audible warning to the road and eliminate the need for the train horn under most circumstances. The evaluation examined the changes in noise levels in the area before and after installation of the automated horn system, and the opinions of residents, motorists, and locomotive engineers regarding the system.  Results indicate that the area impacted by a noise level greater than 80 decibels decreased by 97% with the implementation of the automated system, from 171 acres to less than six acres. A mail-in resident survey taken two months before and two months after implementation determined that area residents were very satisfied with the system. 77% of residents indicated that the train horns had a "negative" or "very negative" impact on their quality of life before the automated system began operation. After implementation, 82% of residents responded that the automated horn was "no problem." The project also surveyed the locomotive engineers seven months after the automated horns began operation. Ninety-two percent of engineers indicated that the overall safety at the crossings was "about the same" or "safer" after the system was installed.⁷⁵

⁷⁴ APTS Benefits 1995.

⁷⁵ Gent, Steve J., et al. *Evaluation of an Automated Horn Warning System at Three Highway-Railroad Grade Crossings in Ames, Iowa*. Iowa Department of Transportation Report, undated.



2.9 REGIONAL MULTIMODAL TRAVELER INFORMATION

Providing traveler information regarding several modes of travel can be beneficial to both the traveler and service providers. Several transit agencies have started using traveler information kiosks and web sites to provide schedules, expected arrival times, expected trip times, and route planning services to patrons. Also, several traffic management centers are providing current traffic conditions and expected travel times using similar approaches. These services allow users to make a more informed decision for trip departures, routes, and mode of travel, especially in bad weather. They have been shown to increase transit usage, and may help to reduce congestion when travelers choose to defer or postpone trips, or to select alternate routes. Information on impacts of traveler information systems are separated into those which provide pre-trip and en-route information, as shown in Figure 2-22.

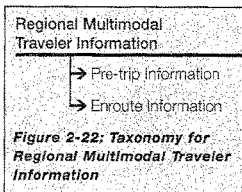



Figure 2-22: Taxonomy for Regional Multimodal Traveler Information

For a summary of regional multimodal traveler information systems deployment in 78 of the largest U.S. cities, refer to www.itsdeployment.its.dot.gov.

2.9.1 Summary of Multimodal Traveler Information System Impacts

Evaluation of implemented traveler information systems reveals that the systems are well received by those who make use of them. Field tests providing traveler information through a variety of in-vehicle and portable devices have received widespread support from project participants. The number of travelers using the information systems generally represents a small portion of the total travelers in a region. Consequently, the evaluated systems have little, if any, impact on travel times across the regional transportation network. Individual users of the systems do perceive significant benefit from them and are generally satisfied with the service.

2.9.2 Summary of Most Recent Evaluations

 The Advanced Regional Traffic Interactive Management and Information System (ARTIMIS) is a regional traffic management system provided by: the Kentucky Transportation Cabinet; Ohio Department of Transportation; FHWA; Ohio-Kentucky-Indiana Regional Council of Governments; and the City of Cincinnati. The system serves the Northern Kentucky and Cincinnati metropolitan areas. It contains an advanced transportation management system and an advanced traveler information system. In June 1995, a telephone information service began providing real-time traffic and travel condition information by specific route or route segment. Sources of up-to-date traffic information include video cameras, radar detectors, inductive loops, aircraft, service patrols, and drivers acting as probes. In a survey conducted in February and March 1999, ARTIMIS users rated the service very high in accuracy and ease of use. More than 99% of those surveyed said they benefited by avoiding traffic problems, saving time, reducing frustration, and arriving at destinations on time.⁷⁶

⁷⁶ Clemons, J., L. Aultman-Hall, & S. Bowling. *ARTIMIS Telephone Travel Information Service: Current Use Patterns and User Satisfaction*. Kentucky Transportation Center, University of Kentucky, Department of Engineering, Lexington, KY: June 1999.

www.benefitcost.its.wdot.gov



The customer satisfaction evaluation undertaken as a part of the Seattle Metropolitan Model Deployment Initiative (MMDI) determined, through focus groups, mail-in questionnaires, and web-based surveys, the response of Seattle area travelers to the various ITS improvements undertaken during the project. Overall, the three traveler information projects evaluated for customer satisfaction received high ratings from those travelers who made use of the systems. While the number of travelers influenced by the different systems varied widely, those who relied on each individual system generally found them to be useful. The Washington State Department of Transportation (WSDOT) traveler information web site received very favorable ratings from participants in an online survey accessible through the site. The web site used data from freeway loop detectors and video feeds to publish freeway segment travel speeds and incident data. Responses indicated that the site was frequently used for trips to and from work or school and that route changes were a significant response to information obtained from the site. Participants also indicated the benefit of reducing the stress of their journey. It is important to note that this was a voluntary survey, and that the responses of those who participated cannot be extended to represent all users of the web site. Data on the number of user sessions on the web site each day reflected a very large spike in usage during a winter weather event in December. This provides evidence of the importance of these types of systems during severe weather.⁷⁷



The Seattle MMDI also implemented a traffic information television channel, known as Traffic TV. A focus group study and mailed questionnaire indicated that frequent users of the Traffic TV service rated it very highly, often using it to change travel routes for a particular journey. The survey also indicated that many of the users discovered the service while changing channels on their TV sets, indicating a low public awareness of the service.⁷⁸



The Fastlane system, designed to provide pre-trip and en-route traveler information in the Seattle area through Personal Digital Assistants (PDAs), experienced very low usage during the MMDI project. The lack of a significant marketing campaign and the limited number of PDAs supported by the software limited the market penetration of the service. Limited evidence of those travelers who did make use of this system indicated that they did change their behavior based on the information received.⁷⁹



Additions and improvements to elements of San Antonio's traveler information system occurred during the MMDI, including new traveler information kiosks, improvements to the internet web site, and the installation of in-vehicle navigation (IVN) devices in vehicles operated by public agencies in the area.



The kiosks provide information on incidents and congestion on the freeway network, transit schedules and fares, as well as navigational assistance. The web site provides freeway traffic information including incident locations, and links to transit schedule and fare information. The IVN devices provide navigational assistance, incorporating information on congestion, incidents, and railroad crossing status when planning trips.



Evaluation of the kiosks by a qualified expert indicated that the devices had several functional problems and were unlikely to be used often by travelers. Based on these results, the study did not perform further evaluation on the system impacts of the kiosks or customer satisfaction with them.

The web site evaluation indicates that usage of the site increased at a rate of 19% per year over the course of the nine-month evaluation period. Significant latent demand for the service was evidenced by dramatic increases in the

⁷⁷ Jensen, M., et al. 2000.

⁷⁸ Jensen, M., et al. 2000.

⁷⁹ Jensen, M., et al. 2000.

number of users accessing the site during two severe weather events over the evaluation period. Despite this growth, the relatively small number of travelers making use of the system led to no overall system impacts due to the web site. Modeling results indicate that individual travelers who use the web site prior to traveling along a particular corridor would receive annual benefits of a 5.4% reduction in delay, a 0.5 % reduction in crash rate, and a 1.8% reduction in fuel consumption.

The small number of publicly owned vehicles using the in-vehicle navigation (IVN) devices led to no system impact from these devices. Focus groups composed of drivers of vehicles equipped with the units indicated that the drivers most satisfied with the system were those who frequently drove different routes each day. Drivers often asked to drive to unfamiliar parts of the metropolitan area, such as paratransit drivers and police investigators, seemed to get the greatest benefit from the system. Public safety representatives did indicate that, with improvements to the method for entering destinations, the devices could be helpful in reducing response times of emergency vehicles. Modeling results indicate significant potential benefits for individuals using the devices. Over a one-year period a traveler using an IVN device could experience an 8.1% reduction in delay, a 4.6% reduction in the crash rate, and a 3% reduction in fuel consumption.⁸⁰

 The Seattle Wide-area Information for Travelers (SWIFT) Field Operational Test was an evaluation project of a large-scale advanced traveler information system. Deployed in the Seattle metropolitan area, SWIFT provided information on several transportation modes using three different devices. The devices included a wristwatch, an in-vehicle navigation system, and a portable PC-based system. Approximately 800 participants were used to evaluate the effectiveness and user acceptance of the three devices. The message watch received traffic information regarding user specified routes. The in-vehicle devices allowed users to request navigation instructions and provided traffic information and guidance along the selected route. Portable computers received information regarding traffic incidents, speed, congestion, and bus-location information. Users of the PC systems appeared to place a higher importance on the receipt of incident and congestion information and less on general information than users of other devices. In general, users of all three devices indicated that they found the information useful for making travel decisions. They also indicated a reduction in stress and travel time. Others changed routes based on provided information. Many users of the devices (especially Seiko Message Watch users) indicated that messages did not provide timely information. Some also questioned the accuracy of information displayed.⁸¹

 A Finnish project found a high user acceptance of traveler information delivered via portable electronic devices sometimes called personal travel assistants (PTA). One-third of users reported changing mode based on information provided, and half changed route based on the information. Another project reported 40% stating they had changed mode based on information from the PTA, while 15% to 25% were willing to start their journey earlier.⁸²





⁸⁰ Carter, et al. 2000.

⁸¹ Perez, William and Bruce Wetherby. *Seattle Wide-area Information For Travelers (SWIFT): Evaluation Summary*. Prepared for Washington State Department of Transportation by Science Application International Corporation, McLean, VA. January 5, 1999.

⁸² *Telematics Applications Programme 2000*.

www.benefitscost.hs.gov

Evaluations of a series of European projects have provided information on the impacts of a variety of traveler information systems.⁸³

-  Six projects provided information via public access terminals or fixed information terminals. User acceptance of the devices was high; cited projects report 79% to 95% of users finding the systems easy to use.
-  Internet information provided during six of the projects also had a high level of user acceptance, with 65% to 75% of respondents indicating that the information was easy to use and understand.
-  Several projects implemented in-vehicle navigation (IVN) devices. The CLEOPATRA project in Turin, Italy, demonstrated timesavings of more than 10% for cars equipped with the IVN devices. Customer satisfaction measures ranged from 50% to 75% of users expressing satisfaction with the devices. It should be noted, however, that 20% of the test drivers in Rotterdam, the Netherlands, expressed concern over being distracted from the driving task.
-  Several European studies focused on the impacts of messages displayed on DMS and the effectiveness of different information strategies. A collaborative study among the various projects found that 30% to 90% of drivers noticed DMS information. In Piraeus, Greece, the route guidance system combined with an integrated traffic control strategy led to a 16% reduction in travel time.



The Phoenix MMDI assessed customer satisfaction with the publicly operated Trailmaster web site and the Traffic Check cable TV traffic information service. Both the web site and television channel provided information on travel conditions on Phoenix area roadways by integrating data from the freeway management system and the Arizona Department of Transportation (ADOT) Roadway Closure and Restriction System.

Analysis of web site usage statistics indicated that the number of visits to the traveler information web site increased steadily during the evaluation period at a rate of 50% per year; evaluators expected this trend to continue. Overall, usage levels for the Phoenix web site were significantly lower than those experienced in Seattle, where traffic congestion is a more significant problem. Two focus group studies revealed Phoenix area travelers felt that congestion levels were not high enough to warrant frequent use of the site. Users did find the site helpful in assessing delays due to construction. Participants felt that the addition of congestion information for arterial roadways would make the site more useful.

A telephone survey was conducted to assess the impact of the traveler information cable TV channel implemented through the MMDI. Thirty-five thousand cable subscribers in Tempe, Arizona, received the Traffic Check television service during the evaluation period. Seven percent of these subscribers responded to a postcard survey inquiring about their use of the traffic information channel. Phone interviews were conducted with 723 subscribers, approximately half of whom had used the Traffic Check channel.

The phone interviews yielded several interesting results regarding the usage and customer satisfaction with Traffic Check. Of the participants who commute regularly, 93% report listening to traffic radio broadcasts for traveler information, 77% used traffic reports on local television, 75% use DMS, and 48% report using Traffic Check.

⁸³ *Telematics Applications Programme 2000.*

Survey results also indicate that pre-trip information in general may be less useful than en-route information; respondents typically indicated that information sources available en-route were most useful. Due to the small sample size, the authors of the evaluation report caution against extrapolating the survey results to a larger population.⁸⁴



Mitretek Systems performed a three-step analysis of the effects of web-based traffic information and weather events on a mixed freeway/arterial network north of downtown Seattle. Analysis of Washington State's Department of Transportation (WSDOT's) traffic website usage data and observed weather data revealed that web site activity increased by 27% during a weather event and 69% during a snow event. This analysis also indicated that market penetration of the advanced traveler information system (ATIS) is not evenly distributed as originally assumed in the Seattle Metropolitan Model Deployment Initiative (MMDI) evaluation. A comparison analysis of non-uniform distribution results to MMDI baseline data found that for the "Freeway and Arterial" scenario, the total number of stops decreased by 6%, the adjusted travel time decreased by 1% percent, and the vehicle kilometers of travel did not appreciably change. The coefficient of variation for the "Freeway Only" scenarios decreased by a small but statistically significant 0.62 %, indicating that the travel time was more reliable. The results of a network analysis demonstrated that a non-uniform ATIS utilization rate related to severe weather has a small positive impact on roadway system efficiency.⁸⁵

⁸⁴ Zimmerman 2000.

⁸⁵ Hardy, Matthew, et al. *Analyzing the Effects of Web-Based Traffic Information and Weather Events in the Seattle Puget Sound Region: Draft Report*. Mitretek Systems. October 2000.

2.10 INFORMATION MANAGEMENT

Data collected by ITS applications have great value as indications of the historical performance of a transportation system with regard to a variety of performance measures. In addition to supporting improvements in the operation of the ITS components, these data can also assist transportation planning, research, and safety management activities. The National ITS Program Plan released by the U.S. DOT in August 2000 describes ITS data archiving as addressing "the collection, storage and distribution of ITS data for transportation planning, administration, policy, operation, safety analyses, and research."⁸⁶ The recent addition of the Archived Data User Service (ADUS) and Archived Data Management System (ADMS) to the National ITS Architecture also indicates the value of retaining and analyzing data collected by ITS.

Operating agencies around the U.S. are in various stages of planning, implementing, and operating archived ITS data management systems. As these systems become a part of routine transportation planning, research, and operations activities, examples of their effectiveness will become available.

2.11 IMPACTS OF OTHER ITS APPLICATIONS IN METROPOLITAN AREAS

As the implementation of ITS in metropolitan areas continues, many implementing organizations are realizing that ITS applications initially designed for rural areas can also apply to situations faced in metropolitan areas. Examples of these applications include travel and tourism services, particularly systems providing information on travel services such as hotels and restaurants, and road weather management systems. Road weather management systems provide support to transportation agencies in collecting and disseminating information on road surface and weather conditions and managing weather-related maintenance activities, such as snow and ice removal during winter storms. These ITS applications can be beneficial in metropolitan as well as rural areas, and evaluations of urban applications of these systems are beginning to demonstrate positive impacts.

2.11.1 Summary of Most Recent Evaluations

 An automated motorist warning system (AMWS) in the city of Ft. Lauderdale, Florida warns motorists of the presence of wet pavement on a freeway ramp at an urban interchange. Comparing vehicle speed data from an evaluation period of six weeks prior to the activation of the AMWS and nine weeks following the activation reveals that, after the system was activated, average vehicle speeds were 10.2 mph (16.4 km/h) lower during heavy rain and 4.6 mph (7.4 km/h) lower during periods of light rain.⁸⁷

⁸⁶ U.S. DOT ITS Joint Program Office. *The National Intelligent Transportation Systems Program Plan: Five Year Horizon*. Federal Highway Administration Report (FHWA-OP-00-008). August 2000.

⁸⁷ Pietrzyk, Michael C. "Are Simplistic Weather-Related Motorist Warning Systems 'All Wet'?" ITE 2000 Annual Meeting, Nashville, Tennessee. 6-10 August 2000.

3.0 BENEFITS OF RURAL ITS

Although rural areas account for a small portion of our nation's population, they contain a major portion of the transportation system. Eighty percent of the total U.S. road mileage is in rural areas, generating 40% of the vehicle miles traveled. Unlike urban areas, the rural environment has a different set of priorities and needs that reflect longer distances, lower traffic volumes, drivers unfamiliar with the surroundings, and longer emergency response times. Many of the ITS services provided in metropolitan areas can also be implemented in the rural environment. However, these services are sometimes required to cover much broader areas, or may become much more specialized in what they provide to the traveler.

The rural ITS initiative is a relatively new program, with increasing activity and funding levels over the last few years. Many rural operational tests and early deployments are currently underway. Some of these tests are starting to report impacts and benefits, while many are still undergoing development, implementation, or evaluation.

Rural ITS infrastructure is classified into seven major program areas. These areas include: crash prevention and security, emergency services, travel and tourism information, traffic management, transit and mobility services, operations and maintenance, and road weather management. Figure 3-0 summarizes these seven major program areas for Rural ITS.

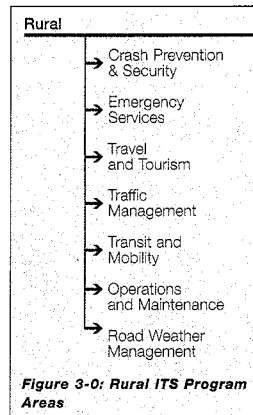
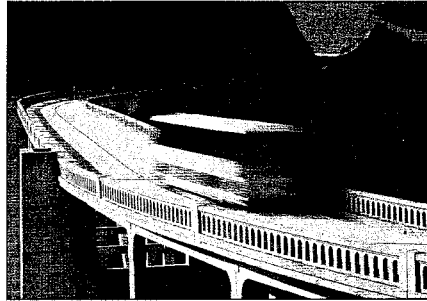

www.benefitscost.its.dot.gov

3.1 CRASH PREVENTION AND SECURITY

One of the major goals of Rural ITS is to improve safety and security. Many of these services are intended to provide advance warning to motorists regarding dangerous roadway conditions. Others improve emergency response when incidents occur in rural areas. ITS applications can assist in evacuation and disaster management plans, where timely information is critical. Also included in this category of ITS are services such as remote surveillance and monitoring, which can enhance security at remote park-and-ride lots, rest areas, and similar facilities. Information from crash prevention and security applications can be used to implement roadway control strategies, such as emergency road closings or variable speed limits. Figure 3-1 depicts the classification of benefits related to crash prevention and security.



3.1.1 Summary of Most Recent Evaluations



California installed an advanced curve warning system at five curves along Interstate 5 in a rural mountainous area. Traffic volumes through the curves are low, ranging from an average daily traffic volume of 7,650 to 9,300 vehicles. The advanced warning systems consisted of dynamic message signs installed before each of the curves displaying warning messages about the upcoming curves. Using data from a radar unit mounted near the signs, the system also displays the actual speed of vehicles approaching the curves. An evaluation of the system included manual speed data collection and surveys of passenger vehicle and truck drivers at nearby rest areas and truck stops. Speed measurements were collected nine months prior to the system's installation and again two months, five months and 10 months after operation began. For three of the five installation sites, the reduction in the speed of trucks traveling through the curves was statistically significant for at least one of the three data collection periods after the warning signs began operation. The two sites that demonstrated a significant

reduction in truck speeds for all three visits after installation had downgrades greater than five percent. The speed reductions were smaller for the later visits to the sites, possibly indicating the drivers were becoming accustomed to the signs and paying less attention to them. Passenger vehicles also demonstrated significant speed reductions at two of the five curves. Over 70% of the drivers surveyed indicated that the system was useful.⁸⁸

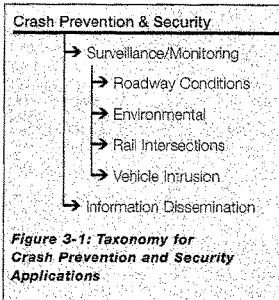

Figure 3-1: Taxonomy for Crash Prevention and Security Applications

A Collision Countermeasure System (CCS) was designed for application at rural, unsignalized, two-way, stop-controlled intersections to improve safety. Operating on input from in-pavement loop detectors, the system automatically activates signs that graphically advise drivers of the presence and direction of approaching traffic. The system was installed on all approaches at the intersection of Aden Road and Fleetwood Drive in Aden, Virginia. A targeted analysis of data gathered on high-speed vehicles and those projected to collide with

⁸⁸ Tribbett, Lani, Patrick McGowen and John Mounce. *An Evaluation of Dynamic Curve Warning Systems in the Sacramento River Canyon: Final Report*. Prepared by the Western Transportation Institute, Montana State University, Bozeman for the California Department of Transportation New Technology and Research Program. April 2000.

another vehicle in the absence of an avoidance response, such as braking, indicated that the system eliminated the occurrence of projected times-to-collision shorter than an acceptable avoidance response time. For high-speed vehicles, average speed was reduced from 55.5 mph (89 kph) in the "before" phase to 54.8 mph (88 kph) in the "after" phase. Greater speed reductions observed immediately after sign installation were not sustained four months after operation began.⁸⁹ While the system does not appreciably reduce the speed of high-speed vehicles, it did eliminate the occurrence of vehicles approaching the intersection at a speed too high to avoid a collision when a vehicle was approaching on the intersecting roadway.

3.2 EMERGENCY SERVICES

Emergency Services address the detection of and response to incidents (such as vehicle crashes and hazardous material spills) and widespread events (such as evacuations and search and rescue missions). For rural areas, the response time for emergency medical services is greater than that typical in metropolitan areas resulting in more severe consequences or impacts. Data related to detection, mobilization and response, and information dissemination due to emergencies in rural areas are classified in the taxonomy as shown in Figure 3-2.

Mobilization often involves a coordinated emergency response involving multiple agencies, various emergency centers, and numerous response plans. Coordination may include tracking of emergency vehicle fleets using automated vehicle location (AVL) technology, two-way communication between emergency vehicles and dispatchers, as well as interfaces with traffic and transit management systems and traveler information systems to disseminate information to affected agencies and the traveling public.

3.2.1 Summary of Most Recent Evaluations

+ In field tests conducted on the Ford-Lincoln Continental Remote Emergency Satellite Cellular Unit (RESCU) security system, drivers were able to make voice contact with a response center operator within one minute. On average, emergency response vehicles arrived within 11 minutes of system activation.⁹⁰

\$ The Georgia Department of Transportation installed a cellular telephone call box system along 39 miles (62.7 kilometers) of Interstate 185. During a six-month study period, system costs were roughly \$120,000. Benefits associated with injury and fatality reductions were projected to be \$289,000, while benefits associated with other incidents (e.g., flat tires, road debris, etc.) were estimated to be approximately \$40,000. The benefit/cost ratio of the call box system was found to be 2.76:1.⁹¹

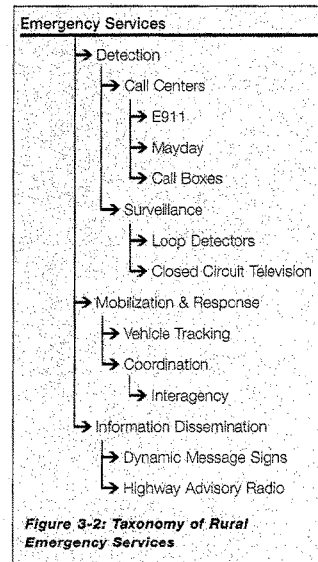

Figure 3-2: Taxonomy of Rural Emergency Services

⁸⁹ Hanscom, Fred R. "Rural Stop-Sign Controlled Intersection Crash Countermeasure System Device Vehicle-Behavioral Evaluation." ITS America 2000 Annual Meeting. Boston, Massachusetts. 1-4 May 2000.

⁹⁰ Meyer, Harvey. "Safer Cars Make Safer Roads." *GEICO Direct*. Fall 1997. p 24 - 27.

⁹¹ Kolb, Stephanie L., et al. "Evaluation of Georgia's Emergency Motorist Aid Call Box Pilot Project." ITS America 2000 Annual Meeting. Boston, Massachusetts. 1-4 May 2000.

www.benefitcosts.org

3.3 TOURISM AND TRAVEL INFORMATION

Tourism and travel information focuses on the need of travelers to receive information in unfamiliar areas they are traveling through. These services address issues of mobility and traveler convenience, and may also improve the economy and productivity of rural and tourist areas.

Many of these services are in the planning and development stages, and few data regarding benefits for these services are available. Several national parks are currently undertaking operational tests or are examining the possible impacts of these services. Information services could include electronic yellow pages, transit, and parking availability. Mobility services such as a pre-trip route selection or en-route navigation are also included. Figure 3-3 summarizes the classification for benefits of tourism and travel information.

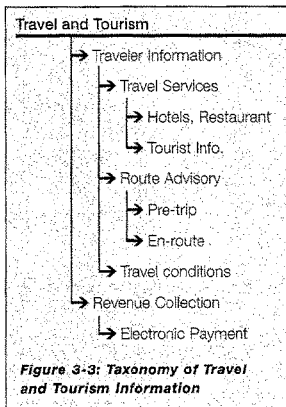

3.4 TRAFFIC MANAGEMENT

Through the application of ITS technologies, traffic management seeks to meet the needs of agencies tasked with operation and maintenance of rural roadways, improve mobility and driver safety, and foster economic development in rural areas. Figure 3-4 summarizes the classification of benefits data related to traffic surveillance, traffic control, and information dissemination.

Rural traffic management addresses unique traffic and safety issues related to occasional congestion. Dynamic control systems are often employed to monitor and manage traffic flow, including the flow of traffic through work areas.

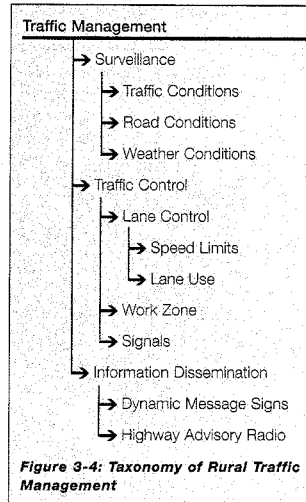

Figure 3-4: Taxonomy of Rural Traffic Management



3.5 TRANSIT AND MOBILITY

The need for public transportation in rural areas is highlighted by the fact that 38% of the nation's rural residents have no access to public transit services and another 28% live in areas in which the level of transit service is negligible. Operating costs can be high, and providing these services in an efficient and effective manner can be difficult. Coordination between various providers can prove useful when trips consist of many different origins and uncommon destinations over wide areas. Advanced transit with AVL-assisted dispatching and routing along with fare payment strategies can also be used. Advanced ride sharing with improved parking information is also considered under this group of rural services. Data associated with public travel and mobility services are classified as shown in Figure 3-5.



3.5.1 Summary of Most Recent Evaluations

\$ The Potomac and Rappahannock Transportation Commission operates demand-responsive transit to serve transit needs and commuter rail stations in the suburban fringe of the Washington, D.C. metropolitan area. The service also meets requirements of the Americans with Disabilities

Act. Compared to a fixed route service and complementary paratransit service; the demand-responsive system is estimated to produce a 40% reduction in total cost.⁹²

\$ Use of coordinated paratransit with a dispatch system including AVL, which can coordinate trips among up to five agencies, has the potential to reduce fraud in Medicaid transportation by \$11 million annually in the State of Florida.⁹³

\$ Public transportation providers in rural areas can achieve cost efficiencies by increasing ridership. The computer-assisted dispatching system in Sweetwater County, Wyoming, which allows same-day ride requests to be accepted, has contributed to an increase in ridership from 5,000 passengers monthly to 9,000 monthly without increasing the dispatch staff and a reduction of operational expense of 50% over a five-year period on a per passenger-mile basis.⁹⁴

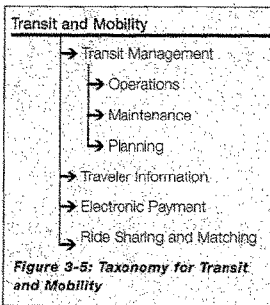

⁹² Farwell, R. "Evaluation of OmniLink Demand Driven Transit Operations: Flex-Route Services." SG Associates, Annandale, Virginia. European Transport Forum. 1996.

⁹³ Ride Solutions. "Operational Strategies for Rural Transportation." Florida Coordinated Transportation System. Undated.

⁹⁴ Casey, R. "The Benefits of ITS Technologies for Rural Transit." Rural ITS Conference. September 1996.

3.6 OPERATIONS AND MAINTENANCE

Operating and maintaining rural transportation systems can be costly. Managing traffic and monitoring roadway conditions in rural areas is often difficult due to distance, isolation, and the number of road miles. Many state DOTs are implementing ITS to better manage roadway maintenance efforts and enhance safety at rural work zones. ITS applications in operations and maintenance focus on integrated management of maintenance fleets, specialized service vehicles, hazardous road conditions remediation, and work zone safety. Systems and processes are required to monitor, analyze, and disseminate roadway/infrastructure data for operational, maintenance, and managerial uses. As implementation of these systems expands, quantified benefits of their use will become apparent. However, there are no benefits data available at this time. Figure 3-6 summarizes how benefits data regarding operation and maintenance are classified.

Winter weather maintenance applications fall under Road Weather Management, discussed in Section 3.7.

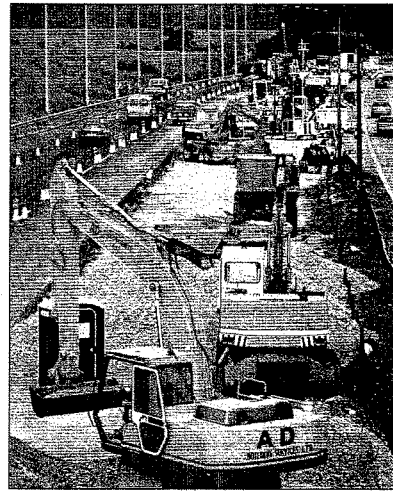
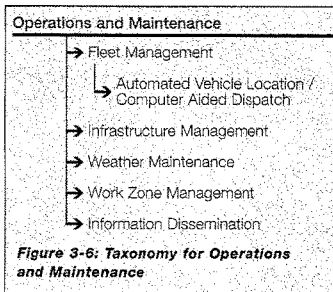

3.7 ROAD WEATHER MANAGEMENT

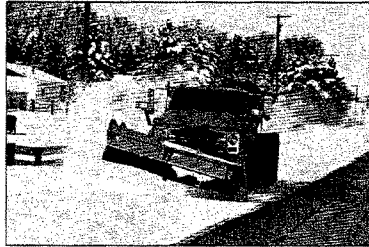

Adverse weather conditions pose a significant threat to the infrastructure and operation of our nation's roads. The Road Weather Management Program – formerly the Weather and Winter Mobility Program – was created to coordinate several weather-related activities in the Federal Highway Administration. The program focuses on development of improved road weather information systems (RWIS), development of improved winter maintenance technologies, and coordination of operations within and between state Departments of Transportation (DOTs). Figure 3-7 depicts the classification of data associated with Road Weather Management.

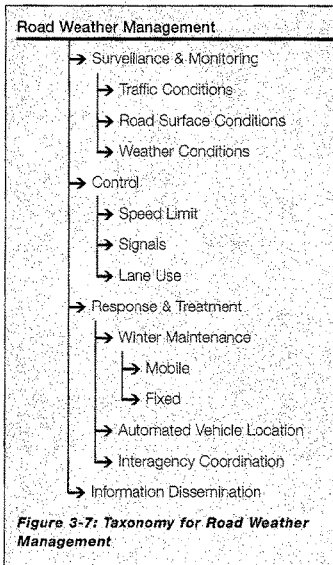





Figure 3-7: Taxonomy for Road Weather Management

3.7.1 Summary of Most Recent Evaluations

 In Utah's Salt Lake Valley, a warning system comprised of visibility sensors and dynamic message signs (DMS), which display recommended speed limits under foggy conditions, increased average vehicle speeds by 15% while decreasing speed variability by 22 percent. Prior to installation of the warning system, the average vehicle speed was 54 mph (86.8 kph) with a standard deviation of 9.5 mph (15.3 kph). After system activation, the average speed increased to 62 mph (99.7 kph) while the standard deviation decreased 22% to 7.4 mph (11.9 kph). This reflects slower drivers increasing their speed to approach the recommended speed, decreasing the variability in vehicle speeds, resulting in an improvement in the safety of the facility.⁹⁵ The results of this study indicate that drivers do respond to advisory speeds posted under foggy conditions and that care should be taken in recommending advisory speeds to ensure that the posted speed is a safe travel speed.

⁹⁵ Perrin, Joseph, et al. "Effects of Variable Speed Limit Signs on Driver Behavior During Inclement Weather." Institute of Transportation Engineers (ITE) 2000 Annual Meeting, August 2000.

 In the Netherlands, an automatic fog-signaling system with 20 sensors installed along 7.5 miles (12 kilometers) of the A16 motorway decreased vehicle speeds by approximately 5.6 mph (9 kph). Visibility distance was used to determine the appropriate speed limit, which was displayed on overhead DMS. For visibility distances between 230 and 460 feet (70 and 140 meters), the posted speed limit was 50 mph (80 kph). Visibility below 230 feet (70 meters) caused a 37 mph (60 kph) speed limit to be displayed. Due to the relationship between average speed and number of crashes, a decrease in crash frequency was also achieved.⁹⁶

 The Finnish National Road Administration (FinnRA) evaluated the profitability and effectiveness of an experimental RWIS installed along 8.7 miles (14 kilometers) of E18. The RWIS was comprised of 36 variable speed limit signs, five DMS, and two environmental sensor stations (ESS). In the winter, recommended speed limits were varied based upon pavement condition, precipitation, visibility, and wind.  When speed limits were reduced, the reason for reduced speeds, such as “slippery road surface,” was displayed on the DMS. It was estimated that the average speed decreased 0.4% to 1.4% due to the RWIS. The average yearly crash rate was projected to decrease by 8% to 25%. Annual costs were expected to decrease by \$234,500. The anticipated benefit-cost ratio of the system was 1.1:1.0 and the remunerative rate of interest, which indicates how effective the use of invested capital has been, was 14%. These values show that the system has been socioeconomically profitable.⁹⁷

 The Idaho Storm Warning System field operational test assessed the performance of visibility sensors and analyzed the effectiveness of DMS in reducing vehicle speeds on Interstate 84 in southeastern Idaho. The evaluation of the operational test established performance capabilities of the system, baseline driver behavior, and driver behavior with the system operating during various road conditions. Researchers concluded that when travel conditions deteriorate due to poor visibility, high winds, wet or snow-covered pavement, or heavy precipitation; drivers reduce speeds without condition information from DMS. They further reduce speeds when DMS operate under high winds, high winds and moderate to heavy precipitation, and high winds and snow-covered pavement. When DMS were used, speeds were nearly 20 mph (32.2 kph) lower than when they were not used under these conditions.⁹⁸

 The Technical Research Centre of Finland conducted a two-phased driving simulator study to compare adverse road condition driver support systems. Three driver support systems were compared under winter conditions: no support system (i.e., typical winter driving feedback), an advanced driver information system including dynamic message signs (DMS) displaying “ICE” if road surface friction was low, and the weather-related intelligent speed adaptation (WISA) system, which prevented vehicles from exceeding a safe speed on icy road sections. The safe speed was computed based upon curve radius and surface friction. Average travel speeds with no driver support system and with the advanced driver information system were 39.4 mph (63.3 kph) and 38.8 mph (62.4 kph), respectively. With the advanced driver information system, speeds increased slightly

⁹⁶ Hogema, Jeroen H. and Richard van der Horst. “Evaluation of A16 Motorway Fog-Signaling System with Respect to Driving Behavior.” *Transportation Research Record No. 1563*. Washington, DC: National Academy Press, 1996.

⁹⁷ Yrjö, Pilla-Sihvila and Lähesmaa Jukka. *Weather Controlled Road and Investment Calculations*. Finnish National Road Administration, Southeastern Region. December 1995.

⁹⁸ Kyte, M., et al. *Idaho Storm Warning System Operational Test: Final Report*. Prepared for the Idaho Transportation Department. December 2000.

on bare road sections, but decreased more than necessary on icy sections due to overcompensation by drivers. It was concluded that driver adaptation to adverse conditions is inadequate, as they cannot accurately assess the degree of road surface friction. The WISA system was safer than the advanced driver information system, due to reduced variability in vehicle speeds and more uniform traffic flow. This reduced variability in vehicle speeds also led to a higher average speed, 40.2 mph (64.6 kph).⁹⁹

 A computer model quantified the benefits of using road weather information system (RWIS) data and the costs of reacting to weather conditions. Model results showed that the benefit-cost ratio for using weather and pavement condition forecast support was greater than 20:0:1:0. Level of service improvements on the order of 20% were computed.¹⁰⁰

 To improve the timeliness of winter maintenance activities, the Finnish National Road Administration has developed an automated information system that transmits actual and forecast weather and road surface information to maintenance personnel. The system includes 11 central stations, 150 environmental sensor stations (ESS) and over 200 workstations. De-icing activities reduced the duration of slippery road conditions by 10 to 30 minutes. It was anticipated that improved maintenance response would decrease crashes by three to 17 percent. The estimated cost savings due to crash reductions, delay reductions, and vehicle costs were \$900,000 per year, \$60,000 per year and \$20,000 per year, respectively.¹⁰¹

 The Indiana Department of Transportation utilizes the Computer Aided System for Planning Efficient Routes (CASPER) software to design winter maintenance routes. The number of routes needed to service the roadway network decreased by 8% to 10%. Winter maintenance cost reductions were anticipated to be between 11 million and 14 million dollars.¹⁰²

 The Wisconsin Department of Transportation (DOT) utilizes the Wisconsin Winter Weather System (WWWS) to dispatch winter maintenance equipment. The system utilizes ice detection systems and a snow forecasting model to plan work schedules, determine appropriate treatment times, identify treatment locations, and reduce costs. Cost reductions were achieved by minimizing personnel overtime costs and decreasing the use of de-icing chemicals. For each storm, the system is expected to reduce personnel costs by \$144,000 and save roughly \$75,000 due to reduced salt usage.¹⁰³

⁹⁹ Peltola, Harri and Risto Kulmala. *Weather Related Intelligent Speed Adaption - Experience from a Simulator*. Technical Research Center of Finland, 2000.

¹⁰⁰ Bosilly, S. Edward, III. "Benefit-Cost Assessment of the Utility of Road Weather Information Systems for Snow and Ice Control." *Transportation Research Record No. 1352*. Washington, DC: National Academy Press, 1992.

¹⁰¹ Yrjö, Pilla-Sihvola, et al. "Road Weather Service System in Finland and Savings in Driving Costs." *Transportation Research Record No. 1387*. Washington, DC: National Academy Press, p. 196-206.

¹⁰² Deeter, D. and Bland, C.E. *Technology in Rural Transportation 'Simple Solutions'*. Federal Highway Administration (FHWA-RD-97-108). October 1997.

¹⁰³ "Wisconsin's Winter Weather System." *TR News No. 147*. National Research Council, Washington, DC. March-April 1990. p. 22-23.

4.0 BENEFITS OF ITS FOR COMMERCIAL VEHICLE OPERATIONS

Commercial vehicle operators and the agencies that regulate them will also experience benefits due to implementation of ITS. Improvements in administrative efficiency, avoidance of infrastructure investment, and improvements in highway data collection will improve safety and reduce operating costs. ITS/CVO applications fall into four program areas, as depicted in Figure 4-0. Three of the program areas include ITS applications that enhance communication between motor carriers and the various agencies that regulate them, particularly during interstate freight movements. Applications in the areas of safety assurance, credentials administration, and electronic screening will aid both carriers and agencies in reducing operating expenses through increased efficiency, and assist in ensuring the safety of motor carriers operating on the nation's roadways. The fourth ITS/CVO program area, carrier operations, includes a variety of ITS applications that aid motor carriers in improving their internal operations and provide support for enhancing coordination with regulating agencies. Carriers will move quickly to equip their own fleets with systems that will improve efficiency, safety, or other measures that provide them with a competitive advantage.



4.1 SAFETY ASSURANCE

Improved safety information exchange programs can assist in improving the safe operation of commercial vehicles. By providing inspectors with better access to safety information, the number of unsafe commercial drivers and vehicles removed from the highway can be increased. Onboard monitoring of cargo can alert drivers and carriers of potential unsafe load conditions. Many of these services are beginning to be implemented in the CVO community. Evaluation to date primarily consists of surveys of the opinions of various stakeholders on the expected impacts of the systems. As these services mature, additional benefits data will become available. Data associated with the benefits of safety assurance are classified as shown in Figure 4-1.

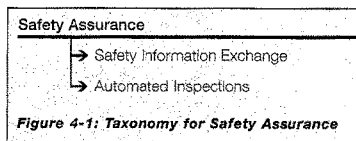
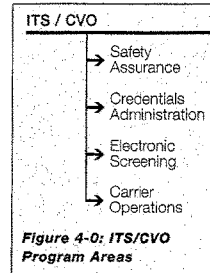



4.1.1 Summary of Most Recent Evaluations



A nationwide survey of truck and motorcoach drivers assessed their opinions regarding the utility of a variety of ITS applications. Findings regarding safety assurance applications include:¹⁰⁴

- Truck drivers held much less favorable opinions of Automated Roadside Safety Inspection than motorcoach drivers,
- Truck drivers who carried hazardous materials were very much in favor of Hazardous Materials Incident Response programs, and
- On-Board Safety Monitoring systems were unpopular with both truck and motorcoach drivers; many felt that the technology was too invasive and relied too much on computers.



The Roads and Traffic Authority of New South Wales, Australia, uses a system of remote automated cameras linked to a central processing center to monitor commercial vehicle operations and enforce safety regulations. Cameras are located along interstate highways in New South Wales, along with processors that allow the remote sites to photograph the vehicle, perform vehicle detection and classification and license plate recognition, and forward the information to the central processing site over a communications network. The central site processes the information received to determine average vehicle speeds over highway segments, identify registration infractions or license plate alerts, and determines if there is a need for driver fatigue notification. The central location also issues any necessary citations for recorded infractions. An evaluation of the system, considering the reduction in lives lost and the time lost during unnecessary vehicle stops and inspections, found a benefit/cost ratio of 2.5 to 1.¹⁰⁵



A cost-benefit analysis of the Commercial Vehicle Information Systems and Network (CVISN) program in Maryland estimated benefit/cost ratios for a variety of ITS/CVO applications.¹⁰⁶ The ratios are based on a 10-year lifecycle for the project, with full deployment of the system in the first year and participation in the program by industry increasing gradually in the early years, more rapidly in the middle years and leveling off in the final years of the lifecycle. Findings include:

- Overall benefit/cost ratios ranging from 3.17 to 4.83,
- Roadside operations of safety enforcement with benefit/cost ratios between 4.01 to 6.08,
- The benefit/cost ratios for state agencies are between 1.41 and 1.66, and
- Commercial motor carriers achieving benefit/cost ratios between 6.49 and 10.71.

¹⁰⁴ *Driver Acceptance of Commercial Vehicle Operations (CVO) Technology in the Motor Carrier Environment*. FHWA Report (FHWA-JPO-97-0010), undated.

¹⁰⁵ ITE 1999.

¹⁰⁶ *A Report to the Maryland General Assembly Senate Budget and Taxation Committee and House Appropriations Committee regarding Commercial Vehicle Information Systems and Network*. Maryland DOT report to the Maryland General Assembly: November 1998.

 A survey of motor carriers operating in the state of Maryland provides additional insight regarding the opinions of the carriers regarding several safety assurance applications. The percentages given for particular responses are determined based on the number of responses to the entire survey rather than each individual question. For most questions, many respondents were unable to respond to the question. Consequently, response rates for particular questions do not sum to 100%.¹⁰⁷

- Approximately 14% of respondents believed that electronic application for Controlled Hazardous Substances (CHS) permits have little or no value, while almost 5% were neutral. Approximately 12% felt that they would be valuable.
- Regarding the value of online access to fleet safety information and traffic and road conditions, approximately 34% of respondents favored online access to fleet safety information. Another 11% assigned little or no value to it, while roughly 10% were neutral.
- When asked to assess the statement that electronic roadside clearance at mainline speeds will decrease the number of unsafe and illegal carriers, roughly 42% of carriers were neutral, about 32% agreed, and over 25% disagreed.

4.2 CREDENTIALS ADMINISTRATION

Services that support in-house administrative functions can provide savings to state and administrative agencies. Electronic credentialing can improve the time required for states to approve operating permits. Data warehouses can facilitate the exchange of credentials data between agencies and jurisdictions. Credentials administration can be further classified as shown in Figure 4-2.

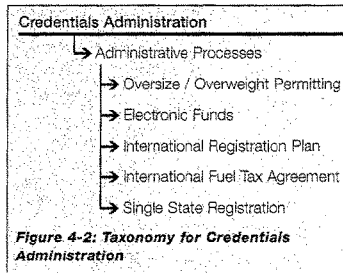



Figure 4-2: Taxonomy for Credentials Administration

4.2.1 Summary of Most Recent Evaluations

 The nationwide survey of truck and motorcoach drivers discussed in Section 4.1.1 requested drivers' opinions regarding credential administration applications. Commercial Vehicle Administrative Processes were not favored by truck drivers, with most feeling the service was an invasion of privacy by the government, and some held concerns that the system relied too heavily on computers. Motorcoach operators were very much in favor of these systems, however, feeling that the automated systems could reduce paperwork, make it easier to comply with regulations, and give them an advantage over other drivers.¹⁰⁸

¹⁰⁷ Bapna, Sanjay and Zaveri, Jigish. *Perceived Benefits and Utilization of Technology: A Comprehensive Survey of the Maryland Motor Carrier Industry*. ITS America 2000 Annual Meeting. Boston, Massachusetts. 1-4 May 2000.

¹⁰⁸ *Driver Acceptance of Commercial Vehicle Operations (CVO) Technology* undated.

www.benefitscosts.org



The Maryland analysis of CVISN discussed in the previous section found benefit/cost ratios for credential processing to be between 1.93 and 3.00.¹⁰⁹



The survey of Maryland motor carriers, also discussed in Section 4.1.1, provides additional insight regarding the opinions of the carriers regarding several ITS applications for administrative processes. The percentages given for particular responses are determined based on the number of responses to the entire survey rather than each individual question. For most questions, many respondents were unable to respond to the question. Consequently, response rates for particular questions do not sum to 100%.¹¹⁰

- Respondents were asked to rate the potential value of Electronic Data Interchange (EDI) and the Internet for conducting business with Maryland State Agencies. On a scale of one to three, the potential values of EDI and the Internet were 1.85 and 2.04, respectively, for small carriers. As fleet sizes grow, the potential values of these technologies increase and are approximately the same for both technologies. For fleet sizes of 25 or more, the potential value of these technologies is 2.2, which is relatively high. Current users of EDI and Internet technologies rated the potential value of these technologies higher than non-users.
- More than one-third of the respondents believed that electronic fuel tax application and filing is valuable, while almost 13% were neutral. Roughly 10% felt that it has little or no value.
- Regarding electronic application for Oversize/Overweight (OS/OW) permits, approximately 20% of respondents thought that the service would be valuable. Nearly 7% were neutral and roughly 13% felt this technology has little or no value.
- Roughly 35% of respondents thought that electronic access to Maryland motor carrier regulations was valuable. About 10% were neutral and another 10% believed that the use of this technology has little or no value.
- Regarding the statement that respondents would find it easier to comply with regulations if all agencies support more efficient processing, the majority (60%) agreed with the statement, nearly 29% were neutral, and approximately 11% disagreed.
- Approximately 40% of carriers were impartial to the statement that there is a lack of timely information exchange between themselves and the agencies. Roughly 39% agreed, while another 21% disagreed.
- Nearly 33% of those responding felt electronic registration is valuable, roughly 13% were neutral, and approximately 11% thought it has little or no value.

¹⁰⁹ *A Report to the Maryland General Assembly* 1998.

¹¹⁰ Bapna 2000.

4.3 ELECTRONIC SCREENING

Electronic screening of commercial vehicles can reduce congestion at inspection stations, improve travel time for commercial vehicles, and help operating companies and regulating agencies reduce costs. Allowing safe and legal carriers to bypass weight and safety inspection stations without stopping can reduce congestion at the facilities. Roadside electronic screening allows authorities to investigate a larger portion of potentially unsafe vehicles. Figure 4-3 displays the taxonomy for classifying benefits data related to electronic screening.

4.3.1 Summary of Electronic Screening Impacts

Studies cited in previous ITS Benefits reports estimated the benefits of various electronic screening programs based on their intended operating strategies and statistics on current motor vehicle operations. The Crescent project, investigating the implementation of all types of electronic screening in the states along the West Coast of the U.S., found a benefit/cost ratio of 4.8 to the state agencies for fully implementing the program.¹¹¹ Another study found government benefit/cost ratios ranging from 5.4 to 7.9 for automated roadside inspections, electronic clearance and one-stop/no-stop shopping.¹¹² A simulation study of an advanced truck weigh station permitting transponder equipped vehicles to bypass the scales found significant delay savings for non-equipped vehicles as the number of trucks equipped with transponders increased.¹¹³ These early studies of the potential of electronic screening indicated that the systems could produce significant benefits.

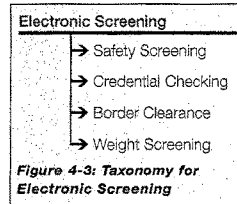
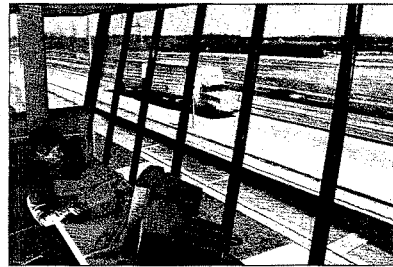

4.3.2 Summary of Most Recent Evaluations



A pilot study referred to as the Intelligent Transportation Border Crossing System (ITBCS) was conducted at the Peace Bridge. The Peace Bridge is a major crossing facility between Buffalo, New York (U.S.A.), and Fort Erie, Ontario (Canada). The ITBCS is a transponder based system that identifies common carriers, autos, etc. that cross the bridge with the intention of speeding the processing of both customs and immigration information. A simulation study indicated that significant benefits would result from a full deployment of the system. On the U.S. side of the bridge, comparing scenarios of 0% and 50% of transponder usage, both trucks and autos received significant timesavings. Trucks saved an average 66% overall in inspection times while the average time for autos in the system decreased 35%. On the Canadian side, time for trucks in the system was reduced 40%.¹¹⁴

¹¹¹ The Crescent Evaluation Team. *The Crescent Project: An Evaluation of an Element of the HELP Program*. Executive Summary and Appendix A. February 1994.

¹¹² Booz, Allen & Hamilton. *Study of Commercial Vehicle Operations and Institutional Barriers*. Appendix F. McLean, VA: Booz, Allen & Hamilton, November 1994.

¹¹³ Glasco, R., et al. *Studies of Potential Intelligent Transportation Systems Benefits Using Traffic Simulation Modeling: Volume 2*. Mitretek Systems Report (MTR 1997-31). McLean, VA: Mitretek Systems, June 1997.

¹¹⁴ Nozick, L., et al. *Evaluation of Advanced Information Technology at the Peace Bridge*. Cornell University & Rensselaer Polytechnic Institute Report. April 1999.

www.detroitits.com

 The field operational test involving the Ambassador Bridge Border Crossing System (ABBCS) demonstrated the ability of ITS services to improve safe and legal border crossings between Detroit, Michigan (USA), and Windsor, Ontario (Canada). The system studied for the Ambassador Bridge identified trucks, crews, cargo, and commuter vehicles, processed them quickly and facilitated electronic payment of the bridge toll. A simulation study of the bridge determined the impact of the system when all four traffic lanes on the bridge were open to equipped and non-equipped vehicles. The simulation showed that the time between an equipped truck entering the lane leading to the customs station and the same truck exiting the station could be reduced by 50%. The simulation also showed that as the percentage of equipped trucks increases, the benefits of the system are more pronounced.¹¹⁵

 The nationwide survey of truck and motorcoach drivers discussed in the preceding two sections¹¹⁶ found that both motorcoach and truck drivers held favorable opinions of commercial vehicle electronic clearance systems. The survey found a 2:1 ratio of truckers strongly favored this service to those strongly opposing it. A similar ratio for motorcoach drivers was 3:1 in favor of the service.

 The survey of motor carriers operating in the state of Maryland, discussed in the preceding section, recorded the following opinions of the carriers regarding electronic screening applications. The percentages given for particular responses are determined based on the number of responses to the entire survey rather than each individual question. For most questions, many respondents were unable to respond to the question. Consequently, response rates for particular questions do not sum to 100%.¹¹⁷

- About 29% of respondents believed that electronic roadside clearance is valuable, nearly 10% did not feel it is valuable, and almost 5% were neutral.
- Twenty-four percent of respondents were willing to participate in a weigh/inspection bypass program despite the possibility of incurring more costs. Another 23% were neutral, while the majority, 53%, would not be willing to participate.

¹¹⁵ Booz-Allen & Hamilton. *Final Evaluation Report: Ambassador Bridge Border Crossing System (ABBCS) Field Operational Test*. Prepared for ABBCS FOT Partners. May 2000.

¹¹⁶ *Driver Acceptance of Commercial Vehicle Operations (CVO) Technology* undated.

¹¹⁷ Bapna 2000.

4.4 CARRIER OPERATIONS

ITS/CVO can improve carrier operations by improving the scheduling of vehicles and reducing the number of empty loads. Administrative compliance costs can be reduced for carriers by participating in automated state credentialing processes. The classification for data related to carrier operations is shown in Figure 4-4.

4.4.1 Summary of Carrier Operations Impacts

Previous reports of the benefits of ITS Carrier Operations services have consisted primarily of anecdotal information from carriers implementing the systems. Carriers report cost savings and productivity gains resulting from enhanced communication with drivers. Those implementing Computer Aided Dispatch (CAD) systems report significant benefits in increased vehicle utilization.¹¹⁸

4.4.2 Summary of Most Recent Evaluations

 The nationwide survey of truck and motorcoach drivers discussed in the preceding ITS/CVO sections found that truck and motorcoach drivers were in greatest agreement about the usefulness of commercial fleet management systems.¹¹⁹

 The survey of Maryland motor carriers found that over 36% of respondents felt that having access to information about traffic and road conditions is valuable. About 13% felt it would have little or no value, while another 9% were neutral. The percentages given for particular responses are determined based on the number of responses to the entire survey rather than each individual question. For most questions, many respondents were unable to respond to the question. Consequently, response rates for particular questions do not sum to 100%.¹²⁰

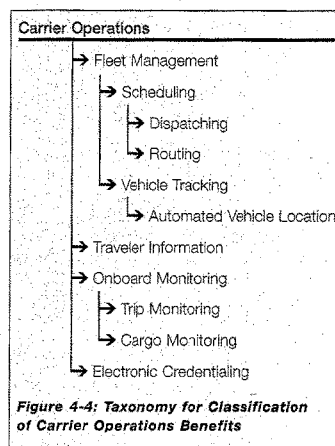

Figure 4-4: Taxonomy for Classification of Carrier Operations Benefits

¹¹⁸ ATA Foundation, Inc. *Survey of the Use of Six Computing and Communications Technologies in Urban Trucking Operations*. Alexandria, VA: American Trucking Association, 1992.

¹¹⁹ Driver Acceptance of Commercial Vehicle Operations (CVO) Technology undated.

¹²⁰ Bapna 2000.

www.benefits.tts.com

5.0 BENEFITS OF INTELLIGENT VEHICLES

ITS services focusing on the vehicle include those functions that assist the driving task or recommend control actions. Although many in-vehicle services are directly affected by non-vehicle infrastructure systems, for purposes of classification this section considers those systems that directly influence the driving task as part of the Intelligent Vehicle Program Area.

Most Intelligent Vehicle services are applicable across all platforms of vehicles. However, a few services have been developed for specific types of vehicles. For example, unlike other types of vehicles, commercial vehicles may have cargo-monitoring systems to alert drivers of possible load shifting or hazardous materials leakage. Because there have been few reported benefit data for individual platforms, this report classifies all data related to Intelligent Vehicles into driver assistance and collision avoidance and warning systems.

5.1 DRIVER ASSISTANCE

ITS services that assist in the driving task are entering the marketplace. In-vehicle vision enhancement may improve safety for driving conditions involving reduced sight distance due to night driving, inadequate lighting, fog, drifting snow, or other inclement weather conditions affecting visibility. Navigational systems are also included here as they provide assistance to the driver in unfamiliar surroundings. Figure 5-1 summarizes how benefits data are classified under driver assistance.

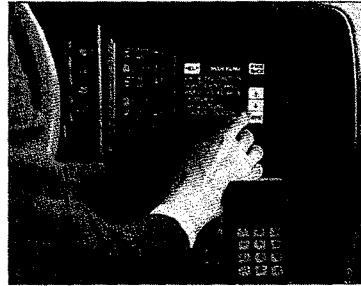

5.1.1 Summary of Most Recent Evaluations

+ The INTEGRATION simulation model was used to estimate the safety impact of the TravTek project, which tested in-vehicle navigation devices in Orlando, Florida. The simulation consisted of a representation of the Orlando roadway network, and performance parameters obtained during the field studies. Analyses were performed to estimate the crash risk of motorists using navigation devices compared to motorists without them. In addition, the safety impacts on the entire traffic network (both equipped and unequipped vehicles) were analyzed. Results indicated an overall reduction in crash risk of up to 4% for motorists using navigation devices, due to improved wrong turn performance and the tendency of the navigation system to route travelers to higher-class facilities such as freeways, which typically have lower crash rates. When diversion around incidents or congestion occurred, increased safety risks of up to 10% were estimated for the equipped vehicles, due to diversion to smaller roads that historically have a higher rate of crashes per VMT.

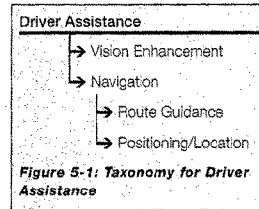

while the overall network experienced a safety impact ranging from neutral to a slight improvement. The network safety improvements were experienced when diversion from congested roadways reduced the level of congestion for the remaining equipped and non-equipped vehicles and helped to smooth traffic flows on those roads.¹²¹



TravTek users perceived that their driving was safer. Based on survey data, users felt less nervous and confused and more confident, attentive, and safe, with local users being significantly more positive than renters. Users also felt that the use of TravTek did not interfere with their driving task. While users were no more likely to be involved in close calls than were nonusers, users who were interacting with TravTek immediately before a near-crash were more likely to feel that they had contributed to close calls.¹²² In-vehicle navigation devices can benefit users in terms of travel time and route finding. A field operational test suggests system benefits when wider deployment appears. The TravTek test in Orlando found that for unfamiliar drivers, wrong turn probability decreased by about 33% and travel time decreased by 20% relative to using paper maps, while travel planning time decreased by 80%.¹²³ The TravTek yoked driver study, measuring the travel times of drivers with and without in-vehicle devices, demonstrated that the system reduced traveler's trip-planning time for unfamiliar destinations; however, there were no statistically reliable reductions in travel time from origin to destination for all but one of the origin/destination pairs studied.¹²⁴ Simulations using data collected during the TravTek test predicted an increase in throughput. Using constant average trip duration as a surrogate for maintaining level of service, a market penetration of 30% for dynamic route guidance results in the ability to handle 10% additional demand.¹²⁵



The ADVANCE project in the northwest suburbs of Chicago tested the time effects of dynamic route guidance through in-vehicle devices using a yoked vehicle study on an arterial network with limited probe data. The aggregate data set demonstrated that motorists could reduce travel time by 4% under normal or recurring conditions; however, this result was based on a small sample size with a relatively high standard deviation.¹²⁶ It did appear that the dynamic route guidance concept, as implemented in ADVANCE, could detect some larger delays and help drivers to avoid them.



Beginning operation in the spring of 1994, the Vehicle Information and Communication System (VICS) is considered to be the forefront of ITS in Japan. In 1998 the system covered four cities: Tokyo, Aichi, Osaka, and Kyoto, and provided drivers with road condition information and alternative route choices to avoid congestion. Drivers using the system reported that they felt less stressed due to the provided advice. They also indicated that they would like the area of service expanded. Road tests of the system have indicated that the dynamic route guidance provided saves about 15% of travel time.¹²⁷

¹²¹ Inman, V., et al. *TravTek Evaluation: Orlando Test Network Study*. Federal Highway Administration Report (FHWA-RD-95-162). Washington, DC: January 1996.

¹²² Inman, V., et al. *TravTek Evaluation: Rental and Local User Study*. Federal Highway Administration Report (FHWA-RD-96-028). Washington, DC: March 1996.

¹²³ Inman, et al. *Orlando Test Network Study* 1996.

¹²⁴ Inman, V., et al. *TravTek Evaluation Yoked Driver Study*. Federal Highway Administration Report (FHWA-RD-94-139). Washington, DC: October 1995.

¹²⁵ Van Aerde, M., and Rakha, H. *TravTek Evaluation: Modeling Study*. Federal Highway Administration Report (FHWA-RD-95-090). Washington, DC: March 1996.

¹²⁶ Schofer, J., et al. *Formal Evaluation of the Targeted Deployment: Vol. II, Appendix J*. Northwestern University Transportation Center. July 1996.

¹²⁷ "VICS reduces travel time by 15%." *ERTICO News*. January 1998. p. 10.

www.bent/focus/its/010100k

5.2 COLLISION AVOIDANCE AND WARNING



Collision avoidance and warning systems are expected to result in both safety benefits and effective capacity benefits by reducing the number of incidents.

Collision avoidance includes several user services such as intelligent cruise control, rear-end crash avoidance, and road departure avoidance. Each of these user services may take on three different levels of control.

The lowest level warns or suggests to the driver what action to take. The middle level responds to safety-compromising positions by taking limited control of the vehicle. For example, intelligent cruise control could slow a vehicle if approaching a lead vehicle too quickly. The highest level of control would be when the system overrides the driver and takes complete

control of the vehicle. Figure 5-2 presents the classification of benefits for collision avoidance and warning.

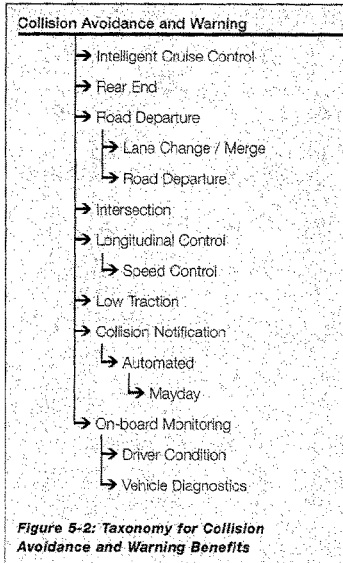



5.2.1 Summary of Most Recent Evaluations

Previous studies of collision avoidance and warning systems estimated the potential impact of these systems on the highway system. A 1997 National Highway Traffic Safety Administration (NHTSA) study estimated the possible effectiveness of several collision avoidance technologies. Estimates for rear-end collision avoidance systems included 42% effectiveness in reducing crashes when the leading vehicle decelerated, 75% effectiveness when the leading vehicle stopped, and 51% effectiveness overall. Lane change or lane merge warning systems were estimated to decrease all lane change collisions by 37%. Road-departure countermeasures were estimated to have an effectiveness of 24%. The study also indicates that the economic benefits of the three systems together would be approximately \$25.6 billion (based on the 1994 value of the dollar).¹²⁸ Field trials of collision avoidance and warning systems are expanding knowledge of the impacts of these systems.

¹²⁸ Kaniandha, Dr. Joseph, and Merrig, A. *Opportunities for Collision Countermeasures Using Intelligent Technologies*. National Highway Traffic Safety Administration. Washington, DC: 1997.

 The results of the federally sponsored field operational test (FOT) of adaptive cruise control (ACC) indicate mixed results for this system regarding safety. The study revealed that the interaction between driver and machine in the important safety task of maintaining vehicle headways raises several issues for which the safety impacts are unclear. However, the study did note an increase in the number of participants conforming to the flow of traffic from 29 of 108 without ACC to 42 of 108 with the system operational, a 12% increase. This indicated that adaptive cruise control has potential for promoting a more uniform traffic flow.¹²⁹

 An analysis of data collected during the adaptive cruise control field operational test assessed the safety impact of ACC based on situations encountered by the volunteers participating in the field study. Analysis of the number of close calls, defined as near collisions with or without driver intervention or cases of driver error requiring corrective action, determined that adaptive cruise control was associated with a lower rate of close calls per million vehicle kilometers of travel (MVKmT) on freeways. For travel on arterial roadways, adaptive cruise control was associated with an increase in the rate of close calls per MVKmT among a subset of participants who also had a high rate of close calls during manual operation. The study, performed by the Volpe National Transportation Systems Center, also assessed the impact of the adaptive cruise control on a variety of other relevant safety measures.¹³⁰

 A study in the south Swedish town of Eslov (population 30,000) equipped the personal vehicles of 25 people with adaptive speed control. The study assessed, through driver interviews, the opinions of participants regarding the system after two months of driving with the system engaged. During the field trial, an active accelerator pedal prevented the vehicles from exceeding the citywide speed limit of 50 km/h, with the system being activated by roadside transponders located on the 10 roadways entering the city. Driver behavior was also assessed through observation while drivers traversed a predetermined test route. Results from driver interviews following the two-month evaluation period indicate that drivers had a positive opinion of the system:

- Seventy-five percent of the drivers consider adaptive speed control more positively than they expected before the trial.
- Three out of four drivers also indicated that they are driving more smoothly and at generally lower speeds while the function is operating.
- More than half of the participants found the driving experience more comfortable with the system engaged.
- A majority of the participants wanted the system to be extended to all speed limits within the urban area, not merely the 50 km/h legal limit.
- A vast majority of the participants prefer adaptive speed control to physical speed countermeasures such as humps, chicanes, and mini-roundabouts.

The observations of driving behavior after the trial period showed an increased tendency of participating drivers to yield when interacting with other drivers and in critical situations at signalized intersections. Given the limited number of vehicles involved, there were no direct benefits to traffic safety during the field trial.¹³¹

¹²⁹ Fancher, P., et al. *Intelligent Cruise Control Field Operational Test (Final Report)*. NHTSA Report (DOT HS 808 849). Washington, DC: May 1998.

¹³⁰ U.S. DOT. *Evaluation of the Intelligent Cruise Control System Volume I*. U.S. DOT Report (DOT-VNTSC-NHTSA-98-3). November 1998.

¹³¹ Almqvist, Sverker. "Speed Adaptation: A Field Trial of Driver Acceptance, Behaviour and Safety." 5th World Congress on Intelligent Transport Systems. Seoul, South Korea. 12-16 October 1998.



✚ A German simulation study investigated the safety impact of a collision avoidance system that used longitudinal vehicle control to attempt to prevent crashes. The system uses information gathered by microwave radar and computer vision sensors to control vehicle speed with actuators that allow the control of acceleration and braking. Braking is automatically controlled only to avoid an impending collision if the driver has not yet applied the brakes. Values of simulation parameters were based on the experimental closed test facility and a field trial of the system providing only collision warnings in and around the city of Nordhausen, Germany. The study measured the frequency of collisions during numerous simulations of vehicles operating under a variety of scenarios. In each situation, the lead vehicle in a platoon decelerates to simulate an unsafe maneuver.

Reductions in the number of crashes when comparing various levels of market penetration of the collision avoidance system to the base case of no equipped vehicles ranged considerably under the circumstances investigated during the study. The smallest reduction was 9% when the lead vehicle brakes at the maximum rate to a complete stop and 10% of the vehicles in the platoon have collision avoidance systems. The greatest reduction was a 60% reduction in the number of collisions when the lead vehicle brakes at 20% of the maximum rate to a complete stop and 50% of the vehicles in the platoon have collision avoidance systems.¹³²

¹³² Sala, Gianguido, and Lorenzo Mussone. "The Evaluation of Impact on Traffic Safety of Anti-Collision Assist Applications." 6th World Congress on Intelligent Transport Systems. Toronto, Canada. November 8-12, 1999.

6.0 SUMMARY

The evaluation of implemented systems and emerging concepts of ITS has been an ongoing process. Significant knowledge is available for many ITS services, but many gaps in knowledge also exist. This report has summarized much of the quantifiable data on ITS impacts collected by the JPO. In general, ITS services have shown some positive benefit. Negative benefits are usually outweighed by other positive impacts. For example, higher speeds and improved traffic flow result in increases in nitrous oxides; however, other emission measures, fuel consumption, travel time, and delay are reduced.

Due to the wide range of different technologies used to implement these services and the difference in variables between implementations, in many cases it is difficult to predict the potential impacts of individual ITS services planned for a particular area. Also, ITS services are beginning to be incorporated into the planning process and are included with the addition of traditional capacity or service. When this occurs, it is very difficult to measure the separate impacts of the additional capacity and the individual ITS services. However, through simulation and comparison with similar services that have been implemented elsewhere, planners and decision-makers may be able to estimate the contribution of the ITS services. Furthermore, where measured or predicted data on ITS performance are not available, subjective data or anecdotal benefits may be available. This type of data can be determined through questionnaires, interviews, or case studies.

Although further evaluation of ITS services is an ongoing effort, the remainder of this section summarizes the availability and depth of known data and points to where gaps in the knowledge exist. The number of references represented in the following tables differs from the total number cited in this report. Many reports cover more than one measure of effectiveness for a given deployment or data from several related or unrelated ITS deployments. These references appear more than once in the summary tables. The cost impacts column contains references reporting benefit/cost ratios. The authors acknowledge that other data may exist which could have been included and has yet to be uncovered in their ongoing literature review. Those with appropriate references are encouraged to submit them to the authors via the online database.

Table 6-1 depicts the quantity of reports in the database discussing the performance of applications in each ITS application area by performance measure. Reviewing the table, it is apparent that the level of benefit information in the database reflects the level of deployment of various ITS components. The applications with the greatest number of evaluations are those taking place in metropolitan areas, which have been the focus of many deployment efforts. As the number of statewide and rural ITS deployments increase, the number of related evaluations is also increasing. The relatively large number of Road Weather Management System evaluations indicates the increase in deployment of related ITS applications. The reader interested in finding available benefits information on a particular measure of effectiveness can use this table as a cross-reference into the report and the ITS Benefits Database.

www.benefitcostifs.gov

		Number of References							
		0 -	1 to 3 -	4 to 6 -	7 to 10 -	>10 -			
		Safety	Time & Delay	Capacity/Throughput	Cost	Customer Satisfaction	Energy & Environment	Other	
Metropolitan	Arterial Management Systems	●	●	●	●	●	●	○	
	Freeway Management	●	●	●	●	●	●	○	
	Transit Management	●	●	●	●	●	●	○	
	Incident Management	●	●	●	●	●	●	○	
	Emergency Management	●	●	○	○	○	○	○	
	Electronic Toll Collection	●	●	●	●	●	●	○	
	Electronic Fare Payment	○	●	○	○	●	○	●	
	Highway-Rail Intersection	●	●	○	○	●	●	○	
	Regional Multimodal Travel Information	●	●	●	●	●	●	●	
	Information Management	○	○	○	○	○	○	○	
Rural	Traveler Safety and Security	●	○	○	○	●	○	○	
	Emergency Services	●	●	○	○	○	○	○	
	Tourism and Travel Information	○	○	○	○	○	○	○	
	Public Transit and Mobility Services	○	○	○	○	○	○	○	
	Infrastructure Operation and Maintenance	●	●	○	○	○	○	○	
ITS/CVO	Road Weather Management	●	●	●	●	○	○	○	
	Safety Assurance	○	○	○	○	●	●	○	
	Credentials Administration	○	○	○	○	●	●	○	
I.V.	Electronic Screening	●	●	○	○	○	○	○	
	Carrier Operations	○	○	○	○	○	○	○	
	Driver Assistance	●	●	●	○	○	○	○	
	Platform Specific	○	○	○	○	○	○	○	

Table 6-1: Summary of Available Data by Benefit Measure (as of 15 February 2001)

Tables 6-2 through 6-5 present the number of references in the database by ITS service or program area, including more detail on the types of applications discussed within each application area. Again, it is evident that most of the data collected to date are concentrated within the metropolitan areas. This is probably due to the fact that the metropolitan program has been in existence longer and is much more developed than rural or CVO. The heaviest concentrations of data in the metropolitan area are in arterial management systems, freeway management, incident management, and regional multimodal traveler information. Most of the available data on traffic signal control systems discuss adaptive traffic signal control. For freeway management, most data reflect benefits related to ramp metering. There are also few data for highway-rail intersections compared to no data available in the 1999 report.

Currently, not enough benefits data have been collected regarding rural ITS to develop any general conclusions. However, this area of ITS has seen a significant growth in reported benefits since the 1999 Benefits Report. Several state and national parks are now examining, testing, and implementing technologies to better transmit tourism and travel information. Also, several rural areas are implementing public transit services. Furthermore, states are now beginning to incorporate ITS into the operation and maintenance of facilities and equipment. Much of the data reported for rural ITS are concentrated in the areas of crash prevention and security. Also, a significant amount of information is available for road weather management activities.

Components	Data Available
Arterial Management Systems	49
Traffic Surveillance	2
Traffic Control	38
Information Dissemination	0
Public Safety / Enforcement	9
General	0
Freeway Management Systems	29
Traffic Surveillance	3
Traffic Control	10
Information Dissemination	13
Public Safety	3
General	2
Transit Management Systems	16
Personal Rapid Transit	1
Transit Management & Operations	11
Security	1
Transit Information	3
General	1
Incident Management Systems	25
Surveillance	3
Detection	5
Response	15
Clearance	1
General	1
Emergency Management	5
Emergency Management	5
Emergency Vehicle	0
General	0
Electronic Toll Collection	10
Toll Administration	2
Toll Collection	5
Toll Vehicle	3
General	0
Electronic Fare Payment	5
Administration/Management	4
Transit Vehicle	1
General	0
Highway-Rail Intersection	6
Surveillance	1
Control	1
Display - Audio/Visual	3
Public Safety	1
General	0
Regional Multimodal Information	21
Pre-trip Information	11
En-route Information	10
General	2
Information Management	0
Data Archiving	0
General	0
Other Metropolitan Systems	4
Travel and Tourism	1
Road Weather Management	2
Operations and Maintenance	1
Parking Management	0

Table 6-2: Number of Metropolitan ITS References in the Database (as of 15 February 2001)

www.benefits.its.gov

Components	Data Available
Crash Prevention and Security	7
Surveillance/Monitoring	2
Information Dissemination	5
General	0
Emergency Services	3
Detection	2
Mobilization & Response	1
Information Dissemination	0
General	0
Travel and Tourism	1
Travel Information	0
Revenue Collection	0
General	1
Traffic Management	0
Surveillance	0
Traffic Control	0
Information Dissemination	0
General	0
Transit and Mobility	3
Transit Management	0
Traveler Information	0
Electronic Payment	0
Paratransit	3
Ride Sharing and Matching	0
General	0
Operations and Maintenance	5
Fleet Management	0
Infrastructure Management	0
Weather Maintenance	4
Work Zone Management	1
Information Dissemination	0
General	0
Road Weather Management	9
Surveillance and Monitoring	5
Information Dissemination	4
General	0

Table 6-3: Number of Rural ITS References in the Database (as of 15 February 2001)

table indicates that two reports within the Benefits Database discuss ITS implementations that include the communication of information on arterial traffic conditions from an arterial management system to a freeway management system.

ITS/CVO continues to provide benefits to both carriers and state agencies. Although it appears that few data have been collected for ITS/CVO, the data that have been reported are from measures that are often directly measurable. Therefore, it might be expected that these data are accurate and few data points would be necessary to convince carriers, states, and local authorities of the possible benefits of implementing these user services. Also, it may be that few data points are needed to convince local jurisdictions that data sharing and other integration measures between other jurisdictions could provide for significant cost savings and improved service. To date, the largest percentage of benefit data related to ITS/CVO is from carrier operations and electronic screening.

ITS program areas and user services associated with driver assistance and specific vehicle classes are still being developed and planned. Although a few of these services are available in the marketplace, much of the data currently associated with these services are predicted or projected based on how systems are expected to perform. As market penetrations increase and improved systems are developed, there will be ample opportunity to measure and report data based on actual measurements.

Metropolitan integration continues to be an important topic among ITS professionals. Table 6-6 presents the number of entries in the database evaluating systems involving integration of more than one ITS application. The table contains pairs of icons representing the integration links introduced in Figure 2-1 in Section 2. The arrows between the icons represent the flow of information between the applications, while the entries in the second column specify the type of information transferred or the action taken based on the communication. For example, the second entry in the

In reporting integration benefits, it is often difficult to separate the benefits of one component with regard to the other. For example, the benefits achieved by emergency management may not be possible without a well-developed incident management program. Reported data may not indicate these relationships very clearly. The reader is also advised that no attempt is made to attribute the relative impact of the integration on the benefits reported in the database entries; the entries in Table 6-6 indicate only that integration was present in the system evaluated in each of the studies.

Based on the data available, integrated ITS deployments linked with regional multimodal traveler information are most often evaluated. There is also a significant amount of data available for the integration of arterial management with transit management and for freeway and incident management systems. The lack of evaluation reports for many of the integrated systems represented in the table and the scarcity of attempts to specifically identify the benefits made possible through integration indicate a need for further research into the impacts of integration among ITS applications.

ITS applications are reaching ever increasing levels of deployment in the U.S. and worldwide. As experience with additional applications increases, additional benefits will become apparent. Implementing agencies will also learn valuable lessons regarding appropriate implementation and operational strategies. The ITS Joint Program Office will continue to make this information available via the ITS Benefits Database, the Electronic Document Library, and other publications.

Components	Data Available
Safety Assurance	5
Safety Information Exchange	2
Automated Inspections	2
General	1
Credentials Administration	2
Administrative Processes	2
Electronic Screening	7
Safety Screening	1
Credential Checking	2
Border Clearance	2
Weight Screening	1
General	1
Carrier Operations	9
Fleet Management	6
Traveler Information	1
On-board Monitoring	0
Electronic Credentialing	2
General	0

Table 6-4: Number of ITS/CVO References in the Database (as of 15 February 2001)

Components	Data Available
Collision Avoidance and Warning	8
Intelligent Cruise Control	1
Rear End	2
Road Departure	2
Intersection	0
Longitudinal Control	1
Low Traction	0
Collision Notification	1
On-board Monitoring	1
General	0
Other Driver Assistance	6
Vision Enhancement	0
Navigation	6
General	0

Table 6-5: Number of Intelligent Vehicle References in the Database (as of 15 February 2001)

Metropolitan Integration Link	Link Purpose	Data Available
	Affect Travel Decisions	2
	Adjust Ramp Signals or Inform Drivers	2
	Adjust Schedules/Routes	1
	Adjust Response	1
	Affect Traffic Control Strategy	2
	Affect Travel Decisions	11
	Adjust Emergency Response	3
	Affect Control Strategy	4
	Adjust Schedules/Routes	0
	Affect Travel Decisions	8
	Adjust Arterial Signals	1
	Adjust Routes/Schedules	0
	Detect Incidents and Adjust Response	5
	Static Route/Schedule Information	6
	Real-Time Route/Schedule Information	1
	Ramp Signal Priority	0
	Travel Speed Information	0

Table 6-6: Number of Metropolitan Integration References in the Database (as of 15 February 2001)





























Metropolitan Integration Link	Link Purpose	Data Available
 → 	Signal Priority	6
 → 	Travel Speed Information	1
 → 	Probe Vehicle Information to Affect Control Strategy	0
 → 	Probe Vehicle Times Affect Timing	0
 ↔ 	Share Common Fare Media	0
 → 	Transit Service Planning	0
 → 	Information on Incident Severity, Location, and Type	0
 → 	Information on Incident Clearance	0
 → 	Signal Priority/Preemption	2
 → 	Signal Coordination	0
 → 	Alert	0
 ↻	Agencies Participating	0
 ↻	Coordinate Timing Across Jurisdictions	3
 ↻	Transit Operators with Common Fare Media	1
 ↻	Toll Operators with Common Tags	0
 → 	Information on Incident Severity, Location, and Type	0
 ↻	Agencies Share Freeway Condition Information	0

Table 6-6: Number of Metropolitan Integration References in the Database (as of 15 February 2001)



APPENDIX 1: REFERENCE LIST

REFERENCES

- A Report to the Maryland General Assembly Senate Budget and Taxation Committee and House Appropriations Committee Regarding Commercial Vehicle Information Systems and Network.* Maryland DOT report to the Maryland General Assembly. November 1998.
- Abdel-Rahim, Ahmed, William C. Taylor and Ashok Bangia. "The Impact of SCATS on Travel Time and Delay." Eighth ITS America Annual Meeting. Detroit, Michigan. 4-7 May 1998.
- Almqvist, Sverker. "Speed Adaptation: A Field Trial of Driver Acceptance, Behaviour and Safety." 5th World Congress on Intelligent Transport Systems. Seoul, South Korea. 12-16 October 1998.
- APTS Benefits.* Federal Transit Administration, November 1995.
- ATA Foundation, Inc. *Survey of the Use of Six Computing and Communications Technologies in Urban Trucking Operations.* Alexandria, VA: American Trucking Association, 1992.
- Bapna, Sanjay and Zaveri, Jigish. "Perceived Benefits and Utilization of Technology: A Comprehensive Survey of the Maryland Motor Carrier Industry." ITS America 2000 Annual Meeting. Boston, Massachusetts. 1-4 May 2000.
- Barbaresso, James C. *Preliminary Findings and Lessons Learned From the Fast-Trac IVHS Program.* Road Commission for Oakland County. Beverly Hills, Michigan, 1994.
- Beteille, J. and Briet, G. "Making Waves in Traffic Control." *Traffic Technology International.* Annual Review, 1997.
- Birst, Shawn and Ayman Smadi. "An Evaluation of ITS for Incident Management in Second-Tier Cities: A Fargo, ND Case Study." ITE 2000 Annual Meeting. Nashville, Tennessee. 6-10 August 2000.
- Booz-Allen and Hamilton. *Study of Commercial Vehicle Operations and Institutional Barriers.* Appendix F. McLean, VA: Booz-Allen and Hamilton, November 1994.
- Booz-Allen and Hamilton. *Final Evaluation Report: Ambassador Bridge Border Crossing System (ABBCS) Field Operational Test.* Prepared for ABBCS FOT Partners. May 2000.
- Booz-Allen and Hamilton. *Incident Management: Detection, Verification and Traffic Management.* Filed Operational Test Cross Cutting Study. September 1998.
- Boselly, S. Edward, III. "Benefit-Cost Assessment of the Utility of Road Weather Information Systems for Snow and Ice Control." *Transportation Research Record No. 1352.* Washington, D.C.: National Academy Press, 1992.
- "Branding Is the Name of the Game in Enforcement." *ITS International.* May/June 2000. pp. 66-67.
- Bullock, Darcy, J. Morales, B. Sanderson. *Evaluation of Emergency Vehicle Signal Preemption on the Route 7 Virginia Corridor.* Federal Highway Administration Report (Publication No. FHWA-RD-99-070). Washington, D.C.: July 1999.

- Burris, Mark and Ashley Yelds. "Using ETC to Provide Variable Tolling: Some Real-World Results." ITS America 2000 Annual Meeting. Boston, Massachusetts. 1-4 May 2000.
- Cambridge Systematics, Inc. *Twin Cities Ramp Meter Evaluation*. Prepared for Minnesota Department of Transportation. February 1, 2001.
- "Cameras Reduce Red Light Running Violations by 20-30%." *The Urban Transportation Monitor*. May 23, 1997.
- Carter, M. et al. *Metropolitan Model Deployment Initiative: San Antonio Evaluation Report (Final Draft)*. FHWA Report (FHWA-OP-00-017). Washington, D.C.: May 2000.
- Casey, R. "The Benefits of ITS Technologies for Rural Transit." Rural ITS Conference. September 1996.
- Casey, R., et al. *Advanced Public Transportation Systems: The State of the Art Update 96*. Federal Transit Administration Report. Washington, D.C.: January 1996.
- Cima, Bart, et al. "Transit Signal Priority: A Comparison of Recent and Future Implementations." ITE 2000 Annual Meeting. Nashville, Tennessee. 6-10 August 2000.
- City of Los Angeles Department of Transportation. *Automated Traffic Surveillance and Control (ATSAC) Evaluation Study*. June 1994.
- Clemons, J., L. Aultman-Hall, & S. Bowling. *ARTIMIS Telephone Travel Information Service: Current Use Patterns and User Satisfaction*. Kentucky Transportation Center, University of Kentucky, Dept. of Engineering. Lexington, Kentucky: June 1999.
- Coleman, Janet A. et al. *FHWA Study tour for Speed Management and Enforcement Technology*. Federal Highway Administration Report (FHWA-PL-96-006). Washington, D.C.: February 1996. Cited in Institute of Transportation Engineers. *Automated Enforcement in Transportation*. ITE Report (Publication No. IR-100). Washington, D.C.: ITE, December 1999.
- Daniel Consultants, Inc., *Aggressive Driver Imaging and Enforcement: Evaluation Report-Impact of Media Campaign and Effects on Safety and Productivity*. Report prepared for Science Applications International Corporation. September 11, 1998.
- Deeter, D. and Bland, C.E. *Technology in Rural Transportation "Simple Solutions."* Federal Highway Administration (FHWA-RD-97-108). October 1997.
- Driver Acceptance of Commercial Vehicle Operations (CVO) Technology in the Motor Carrier Environment*. FHWA Report (FHWA-JPO-97-00 10). Undated.
- Fancher, P., et al. *Intelligent Cruise Control Field Operational Test (Final Report)*. NHTSA Report (DOT HS 808 849). Washington, D.C.: May 1998.
- Farwell, R. "Evaluation of OmniLink Demand Driven Transit Operations: Flex-Route Services." SG Associates, Annandale, Virginia. European Transport Forum. 1996.
- Federal Rail Administration, Office of Safety.

www.benefitsfrees.com

- Fenno, David W., and Michael A. Ogden. "Freeway Services Patrols: A State of the Practice." 77th Annual Meeting of the Transportation Research Board. Washington, D.C.: January 1998.
- Furth, Peter G. and Theo H.J. Muller. "Conditional Bus Priority at Signalized Intersections." 79th Annual Meeting of the Transportation Research Board. Washington, D.C. 9-13 January 2000.
- Gent, Steve J., et al. *Evaluation of an Automated Horn Warning System at Three Highway-Railroad Grade Crossings in Ames, Iowa*. Iowa Department of Transportation Report. Undated.
- Giugno, M. *Milwaukee County Transit System: Status Report*. July 1995.
- Glasco, R., et al. *Studies of Potential Intelligent Transportation System Benefits Using Traffic Simulation Modeling*. Mitretek Systems Report (MP96W0000101). June 1996.
- Glasco, R., et al. *Studies of Potential Intelligent Transportation Systems Benefits Using Traffic Simulation Modeling: Volume 2*. Mitretek Systems Report (MTR 1997-31). McLean, Virginia: Mitretek Systems, June 1997.
- Hanscom, Fred R. "Rural Stop-Sign Controlled Intersection Crash Countermeasure System Device Vehicle-Behavioral Evaluation." ITS America 2000 Annual Meeting. Boston, Massachusetts. 1-4 May 2000.
- Hansen, Lt. Glenn. "Can We Increase the Capability of Red Light Cameras?" *ITS World*. January/February 2000.
- Harcy, Matthew, et al. *Analyzing the Effects of Web-Based Traffic Information and Weather Events in the Seattle Puget Sound Region: Draft Report*. Mitretek Systems. October 2000.
- Haselkorn, M., et al. *Evaluation of PuSHMe Mayday System: Final Report*. June 19, 1997.
- Highway Capacity Manual 2000*. Transportation Research Board, National Research Council. Washington, D.C.: 2000.
- Hogema, Jeroen H. and Richard van der Horst. "Evaluation of A16 Motorway Fog-Signaling System with Respect to Driving Behavior." *Transportation Research Record No. 1563*. Washington, D.C.: National Academy Press, 1996.
- Hughes, Ronald, H. Huang, & C. Zeger. "ITS and Pedestrian Safety at Signalized Intersections." *ITS Quarterly*. Vol. VII, No. 2. Washington D.C.: ITS America, Spring/Summer 1999.
- Inman, V., et al. *TravTek Evaluation Yoked Driver Study*. Federal Highway Administration Report (FHWA-RD-94-139). Washington, D.C.: October 1995.
- Inman, V., et al. *TravTek Evaluation: Rental and Local User Study*. Federal Highway Administration Report (FHWA-RD-96-028). Washington, D.C.: March 1996.
- Inman, V., et al. *TravTek Evaluation: Orlando Test Network Study*. Federal Highway Administration Report (FHWA-RD-95-162). Washington, D.C.: January 1996.
- Institute of Transportation Engineers. *1996 ITS Tour Report: Eastern North America & 1996 ITS World Congress*. ITE Report. Washington, D.C.: 1997.

- Institute of Transportation Engineers. *Automated Enforcement in Transportation*. ITE Report (Publication No. IR-100). Washington, D.C.: ITE, December 1999.
- "Intelligent Time Savers, Life Savers." *ITS Update*. December 1997.
- Jensen, M., et al. *Metropolitan Model Deployment Initiative Seattle Evaluation Report: Final Draft*. Federal Highway Administration Report (FHWA-OP-00-020). Washington, D.C.: May 2000.
- Kanianthra, Dr. Joseph, and Mertig, A. *Opportunities for Collision Countermeasures Using Intelligent Technologies*. National Highway Traffic Safety Administration. Washington, D.C.: 1997.
- Klondzinski, J.G., et al. "Impacts of Electronic Toll Collection on Vehicle Emissions." 77th Annual Meeting of the Transportation Research Board. Washington, D.C. January 1998.
- Kolb, Stephanie L., et al. "Evaluation of Georgia's Emergency Motorist Aid Call Box Pilot Project." ITS America 2000 Annual Meeting. Boston, Massachusetts. 1-4 May 2000.
- Kyte, M., et al. *Idaho Storm Warning System Operational Test: Final Report*. Prepared for the Idaho Transportation Department. December 2000.
- McGurrin, Michael and Karl Wunderlich. "Running at Capacity." *Traffic Technology International*. April/May 1999.
- McNally, M.G., et al. *Evaluation of the Anaheim Advanced Traffic Control System Field Operational Test: Executive Summary*. California PATH Research Report (Report No. UCB-ITS-PRR-99-18). Berkeley, California: July 1999.
- "Measuring ITS Deployment: and Integration." Prepared for the FHWA ITS JPO. January 1999.
- Meyer, Harvey. "Safer Cars Make Safer Roads." *GRICO Direct*. Fall 1997. p 24 - 27.
- Muller, Theo, and Peter Furth. "Integrating Bus Service Planning with Analysis, Operational Control, and Performance Monitoring." ITS America 2000 Annual Meeting. Boston, Massachusetts. 1-4 May 2000.
- Nozick, L., et al. *Evaluation of Advanced Information Technology at the Peace Bridge*. Cornell University & Rensselaer Polytechnic Institute Report. April 1999.
- Peck, C., M. Blanco and J. Lopez. "Learning from the User: Next Steps for ITACA's Adaptive Control." *Traffic Technology International*. Annual Review, 1999. p. 155-158.
- Peltola, Harri and Risto Kulmala. *Weather Related Intelligent Speed Adaption - Experience from a Simulator*. Technical Research Center of Finland. 2000.
- Perez, William and Bruce Wetherby. *Seattle Wide-area Information For Travelers (SWIFT): Evaluation Summary*. Prepared for Washington State Department of Transportation by Science Application International Corporation, McLean, Virginia. January 5, 1999.
- Perrin, Joseph, et al. "Effects of Variable Speed Limit Signs on Driver Behavior During Inclement Weather." Institute of Transportation Engineers (ITE) 2000 Annual Meeting. August 2000.

www.benefits.its.fdot.gov

- Pietrzyk, Michael C. "Are Simplistic Weather-Related Motorist Warning Systems 'All Wet'?" ITE 2000 Annual Meeting, Nashville, Tennessee. 6-10 August 2000.
- Pietrzyk, Mike, *et al.* "Cost-Benefit Analysis of Electronic Toll and Traffic Management." Proceedings of the IVHS America 1992 Annual Meeting, Volume I. 1992.
- Presley, Michael, *et al.* *Calculating Benefits for NAVIGATOR: Georgia's Intelligent Transportation System*. Georgia Department of Transportation. September 1998.
- Proper, Allen T. *Intelligent Transportation Systems Benefits: 1999 Update*. U.S. Department of Transportation, ITS Joint Program Office (FHWA-OP-99-012). May 1999.
- Retting, Richard A. "Reducing Red Light Running Crashes: A Research Perspective." 2000 ITE Annual Meeting, Nashville, Tennessee. 6-10 August 2000.
- Ride Solutions. "Operational Strategies for Rural Transportation." Florida Coordinated Transportation System. Undated.
- Sala, Gianguido, and Lorenzo Mussone. "The Evaluation of Impact on Traffic Safety of Anti-Collision Assist Applications." 6th World Congress on Intelligent Transport Systems. Toronto, Canada. November 8-12, 1999.
- Schofer, J. *et al.* *Formal Evaluation of the Targeted Deployment: Vol. II, Appendix J*. Northwestern University Transportation Center. July 1996.
- Shifrel, Scott. "Satellites Around Globe May Save Lives Right Here." *The Palm Beach Post*. June 1, 1997.
- Siemens Automotive, USA. "SCOOT in Toronto." *Traffic Technology International*. Spring 1995.
- Strategic Plan for Intelligent Vehicle Highway Systems in the United States*. ITS America Report (IVHS-Amer-92-3). Washington, D.C.: May 20, 1992.
- Strathman, James G., *et al.* "Service Reliability Impacts of Computer-Aided Dispatching and Automatic Vehicle Location Technology: A Tri-Met Case Study." *Transportation Quarterly*. Vol. 54 No. 3, Summer 2000. pp. 85-100.
- Taylor, Steven T. "Helping Americans." *ITS World*. January/February 1997.
- Taylor, Steven T. "Reaching Out with ITS." *ITS World*. March/April 1997. pp. 24-28.
- Telematics Applications Programme - Transport Areas' Results (4th Funding Programme)*. European Commission Report. July 2000. [<http://www.trentel.org/transport/frame1.htm>].
- The Changing Face of Transportation*. U.S. Dept. of Transportation, Bureau of Transportation Statistics (BTS00-007). 2000.
- The Crescent Evaluation Team. *The Crescent Project: An Evaluation of an Element of the HELP Program*. Executive Summary and Appendix A. February 1994.

- Tracking the Deployment of Integrated Metropolitan Intelligent Transportation Systems Infrastructure in the USA: FY99 Results.* FHWA Report (FHWA-OP-00-016). March 2000.
- Tribbert, Lani, Patrick McGowen and John Mounce. *An Evaluation of Dynamic Curve Warning Systems in the Sacramento River Canyon: Final Report.* Prepared by the Western Transportation Institute, Montana State University, Bozeman, for the California Department of Transportation New Technology and Research Program. April 2000.
- U.S. DOT. *Evaluation of the Intelligent Cruise Control System Volume I.* U.S. DOT Report (DOT-VNTSC-NHTSA-98-3). November 1998.
- U.S. DOT ITS Joint Program Office. *The National Intelligent Transportation Systems Program Plan: Five Year Horizon.* Federal Highway Administration Report (FHWA-OP-00-008). August 2000.
- Van Aerde, M., and Rakha, H. *TravTek Evaluation: Modeling Study.* Federal Highway Administration Report (FHWA-RD-95-090). Washington, D.C.: March 1996.
- "VICS reduces travel time by 15%." *ERTICO News*. January 1998. p. 10.
- Victoria Traffic Camera Office. Website, [<http://home.vicnet.net.au/~tco/index.htm>]. Melbourne, Australia: TCO, 1999. Cited in Institute of Transportation Engineers. *Automated Enforcement in Transportation*. ITE Report (Publication No. IR-100). Washington, DC: ITE, December 1999.
- Wallace, Richard R., et al. "Who Noticed, Who Cares? Passenger Reactions to Transit Safety Measures." *Transportation Research Record No. 1666*. Washington, D.C.: Transportation Research Board, 1999. pp. 133-138.
- Weatherford, Matt. *Assessment of the Denver Regional Transportation District Automatic Vehicle Location System.* U.S. Department of Transportation Report (DOT-VNTSC-FTA-00-04). Cambridge, Massachusetts: John A. Volpe National Transportation Center, August 2000.
- "Wisconsin's Winter Weather System." *TR News No. 147*. National Research Council, Washington, D.C. March-April 1990. p. 22-23.
- Yrjö, Pilla-Sihvila, et al. "Road Weather Service System in Finland and Savings in Driving Costs." *Transportation Research Record No. 1387*. Washington, D.C.: National Academy Press. p. 196 - 200.
- Yrjö, Pilla-Sihvila and Lähesmaa Jukka. *Weather Controlled Road and Investment Calculations.* Finnish National Road Administration, Southeastern Region. December 1995.
- Zhou, Wei-Wu, et al. "Fuzzy Flows." *ITS: Intelligent Transportation Systems*. May/June 1997.
- Zimmerman, C., et al. *Phoenix Metropolitan Model Deployment Initiative Evaluation Report.* FHWA Report (FHWA OP-00-015). Washington, D.C.: 2000.



APPENDIX 2: LIST OF ACRONYMS

LIST OF ACRONYMS

ABBCS	Ambassador Bridge Border Crossing System
ACC	Adaptive Cruise Control
ADIE	Aggressive Driver Imaging and Enforcement
ADMS	Archived Data Management System
ADOT	Arizona Department of Transportation
ADUS	Archived Data User Service
AMWS	Automated Motorist Warning System
APTS	Advanced Public Transportation Systems
ARTIMIS	Advanced Regional Traffic Interactive Management and Information Systems
ATIS	Advanced Traveler Information System
AVI	Automatic Vehicle Identification
AVL	Automated Vehicle Location
B/C	Benefit/Cost
CAD	Computer Aided Dispatch
CCS	Collision Countermeasure System
CCTV	Closed Circuit Television
CHS	Controlled Hazardous Substances
CO	Carbon Monoxide
CVISN	Commercial Vehicle Information Systems and Network
CVO	Commercial Vehicle Operations
DMS	Dynamic Message Signs
DOT	Department of Transportation
EDI	Electronic Data Interchange
E-PASS	Express Pass
ESS	Environmental Sensor Stations
ETC	Electronic Toll Collection
ETTM	Electronic Toll and Traffic Management
FHWA	Federal Highway Administration
FOT	Field Operational Test
FY	Fiscal Year
HAR	Highway Advisory Radio

HC	Hydrocarbon
HRI	Highway-Rail Intersections
IFTA	International Fuel Tax Agreement
IRP	International Registration Plan
ITBCS	Intelligent Transportation Border Crossing System
ITS	Intelligent Transportation Systems
ITS/CVO	ITS for Commercial Vehicles
IVN	In-Vehicle Navigation
IVS	In-Vehicle Signing
JPO	Joint Program Office
LRT	Light Rail Transit
MMDI	Metropolitan Model Deployment Initiative
Mn/DOT	Minnesota Department of Transportation
MVKmT	Million Vehicle-Kilometers of Travel
NHTSA	National Highway Traffic Safety Administration
NO _x	Nitrous Oxide
OOCEA	Orlando-Orange County Expressway Authority
OS/OW	Oversize/Overweight
PC	Personal Computer
PDA	Personal Digital Assistant
PTA	Personal Travel Assistant
PuSHMe	Puget Sound Help Me (Mayday System)
RESCU	Remote Emergency Satellite Cellular Unit
RWIS	Road Weather Information System
SCOOT	Split Cycle Offset Optimization Techniques
SSR	Single State Registration
SWIFT	Seattle Wide-area Information for Travelers
TEA-21	Transportation Equity Act for the 21st Century
U.S. DOT	United States Department of Transportation
VICS	Vehicle Information and Communication System
VMT	Vehicle-Miles of Travel
WISA	Weather-related Intelligent Speed Adaptation System
WSDOT	Washington State Department of Transportation

STATEMENT OF ELWYN TINKLENBERG, COMMISSIONER, MINNESOTA DEPARTMENT
OF TRANSPORTATION

INTRODUCTION

Mr. Chairman and Members of the Committee, my name is Elwyn Tinklenberg. I am Commissioner of the Minnesota Department of Transportation and Chair of the Advanced Transportation Systems Subcommittee of the American Association of State Highway and Transportation Officials (AASHTO). I am here today to testify on behalf of AASHTO, and want to thank you for your leadership in holding this oversight hearing to review the Nation's progress in deploying intelligent transportation systems (ITS) for the benefit of the Nation's travelers.

The Intermodal Transportation Efficiency Act of 1991 (ISTEA) and the Transportation Equity Act of 1996 (TEA-21) clearly established a national direction for the transportation community to develop and employ new technology to modernize the Nation's transportation system, improve customer service, make it safer to use and to improve the quality of life for the Nation.

I am pleased to report that based on our 10 years of effort the surface transportation community has responded, in ways never anticipated and to levels never expected. However, the transformation is not yet complete. The foundation has been set and the best is yet to come. ITS has made pervasive inroads in many areas from metropolitan to rural America, improving safety, weather and traveler information, vehicle design and safety, driver protection and customer service. We have successfully begun transferring technology from NASA and the Defense Industries to the transportation arena. New partnerships never before envisioned have become a way of doing business for the public and private sector and we are establishing the needed foundation for interoperability through a national architecture and nationally consistent standards. And it is making it possible for government to operate differently through new organizational arrangements, better consistency and effectiveness of service, and stretching the use of the system.

Today we want to focus on what we have done, the benefits that have accrued to the Nation, showcase what we believe to be a true surface transportation success story, and offer some thoughts for the future.

THE NEED FOR INTELLIGENT TRANSPORTATION SYSTEMS TOOLS AND APPROACHES.

The 2000 Census reinforced, with regard to the transportation capacity, that this country cannot rely solely on building new capacity to keep up with population growth. The U.S. population grew by 32 million this last decade: California by 4.1 million, Texas by 3.8 million, Florida by 3 million, five Western and Southern States by one million or more, and 14 additional States by from 500,000 to one million.

Vehicle miles of travel (VMT) have been growing twice as fast as our population. We believe that the leveling off of VMT that we have seen over the past year is not likely to continue very long into the future, and growth in VMT will resume. Freight has been growing even faster than VMT. Freight is expected to more than double in volume over the next 20 years, and it is anticipated that 82 percent of those shipments will travel over the roads.

Over the last 40 years, the U.S. population grew by 100 million and is expected to grow by an additional 100 million the next 40. From the 1960s through the 1990s, the United States built the 47,000-mile Interstate Highway System, and more than 200,000 miles of additional arterials. This network provides the mobility that has made the modern American economy possible. Our productivity and competitiveness depend on it.

The strategy for the last forty years was to build the highways that were needed for the prospering economy. However, most of that construction occurred during the first half of the period. From 1956 to 1979 total highway system lane miles increased by 1.1 million miles. From 1980 to 1999, the increase was less than one-third of that—only 300,000 miles were added to the system. The fact that we have congestion is not surprising.

There is a crisis of capacity—on the highways, on buses, in the air, and on trains. What we need now is a vision of how to sustain and then enhance our mobility for the next 40 years. And that vision must recognize that we need to use new tools and technologies to improve safety, while adding needed new capacity.

Technology holds the promise of improving traffic throughput by 15 percent or more in major urban corridors facing severe congestion. This includes, for example, better traveler information through 511 systems, incident management to clear accidents and assist stranded motorists, advanced traffic management centers, electronic toll systems and electronic clearance system for commercial trucking.

Of course, increasing transit must also be part of the strategy to help add capacity and reduce congestion. In 1999, transit ridership reached 9 billion for the first time since 1960. That is good news for highway and State departments of transportation have a stake in seeing it increase still more. Doubling transit ridership over the next 10 years would be an ambitious goal. In some of the most transit-oriented regions, that would increase transit's share of trips to as much as 20 percent. In most other areas, a doubling would mean increasing the percentage of trips made by transit from 2 percent to 5 percent. Increasing transit ridership is a vital part of the solution, but investment in transit alone cannot solve the capacity problem. Overall, doubling transit ridership would, at best, meet 10 percent of travel demand, leaving a substantial gap in the capacity needs for the remainder of passenger trips and all of freight.

Even if we can achieve the ambitious goal of meeting a total of 25 percent of demand through increasing transit and through technology deployment and improved operations, the remaining 75 percent realistically can only be met by building additional capacity. New capacity—to remove bottlenecks, improve intermodal connections and ease congestion—will be needed throughout the country. It will be needed in areas in the Midwest and East with moderate population growth, but significantly increased traffic. It will be absolutely essential in the areas of the South and West facing rapid growth.

THE PROMISE OF TECHNOLOGY BEING FULFILLED

I am proud of what we have accomplished in my State of Minnesota. Minnesota has a broad range of ITS technologies deployed, planned, or being tested and evaluated. Let me mention a few:

- Statewide Road/Weather Information System (RWIS)—86 stations statewide provide real-time pavement and atmospheric data and forecasts.
- 511—In November of this year wireless callers will be connected to the statewide road/weather information service. Future efforts will include transit and traffic conditions.
- Statewide system of transportation operation and communication centers including computer-assisted dispatching, mobile data terminals and automatic vehicle location for the MN State patrol.
- Adaptive signal systems integrated with regional ramp metering in the Twin Cities. The ramp metering systems have improved freeway travel time 22 percent, reduced crashes by 24 percent, and improved freeway throughput by 14 percent.
- Automated scheduling of transit Federal technical assistance and special deployment funding along with a skilled workforce and leadership in Minnesota helped to shape the success we have achieved.

Since 1994, when the U.S. Department of Transportation (USDOT) ITS Joint Program Office in conjunction with AASHTO and ITS America began tracking and evaluating the deployment of ITS technologies and documenting their benefits, a clear pattern has begun to emerge.

As of the year 2000 for the seventy-five largest urban areas in the country the following has occurred in deployment: twenty-four cities have a high level of integrated ITS tools, 22 percent of freeway miles have real time data collection technologies, 73 percent of toll collection lanes have electronic toll collection capability, 31 percent of fixed route transit facilities have automatic vehicle location technology and 49 percent of signalized intersections are under centralized or closed loop control.

The ITS technologies, tools and practices being deployed across the country have seven major focus areas: Metropolitan, Rural, Transit, Commercial Vehicle Operations, Intelligent Vehicle Initiatives, Standards Development and Partnerships. Metropolitan deployments have concentrated on freeway and arterial management, incident and emergency response, electronic toll collection and payment, transit system management, and regional multimodal traveler information. In the rural environment deployments are focusing on crash prevention and security, emergency services, travel and tourism services, traffic management, road weather information, transit, and operations and maintenance. The transit initiatives include automatic vehicle location and dispatching, security, and record keeping systems. The commercial vehicle focus is on safety assurance, credential administration, electronic screening and operations. Intelligent vehicle initiatives dealing with driver assistance services and employing improved technology in snow and ice control fleets and public safety operations. We also put in place standards for the tools and software that are needed and facilitated new public/private partnerships and public/public partnerships.

Some Highlights of the Benefits of Deployments in Metropolitan Areas

- Some of the most impressive benefits of the ITS Program in the first generation have been realized in the major metropolitan areas across the country. From arterial and freeway management to emergency and incident response to electronic toll collection to better traveler information these technology deployments are improving safety, reducing trip delay/improving trip reliability, and reducing costs to the transportation user.
- Dynamic message signs have been deployed in virtually all major metropolitan areas to improve driver information on major freeways.
- Automated enforcement of traffic signals has reduced violations from 20 percent to 75 percent.
- Adaptive Signal Controls have reduced traffic delay from 14 percent to 44 percent, while reducing fuel consumption anywhere from 2 percent to 13 percent, and reducing stops from 10 percent to 41 percent.
- Ramp metering has shown 15 percent to 50 percent reduction in crashes. Recent studies have shown a 16 percent increase in throughput with an 8 percent to 60 percent increase in speeds on freeways.
- 360 agencies across the country have installed signal preemption systems for emergency vehicles improving emergency response times to life threatening events.
- Incident management systems installed across the country are estimated to be reducing travel delay from 95,000 to 2 million hours per year.
- Electronic Toll Collection systems like E-Zpass have reduced staffing at toll collection booths by up to 43 percent, money handling by almost 10 percent, and toll road maintenance cost by 15 percent. In addition, travelers have been able to adjust their starting times by up to 20 percent. These systems are also contributing to the reduction of Carbon Monoxide (8 percent), and Hydrocarbons (7 percent) in metropolitan areas.

Some Highlights of the Benefits of ITS Deployments in Rural Areas

Rural activity has focused around improving emergency response/services, traveler information, road/weather information, operations and management, and developing partnerships between State and local agencies.

Road/weather information systems have been implemented in almost half of the States. The information is being used to better utilize snow and ice operations and provide traveler information prior to and during winter operations.

New technologies are being used to allow improved tracking of snowplows and technology to allow snowplow operators to see the road even in the worst of conditions.

Highway-rail grade crossings have been made safer through the use of new technologies.

95 percent of drivers equipped with Mayday/Onstar type systems reported feeling more secure.

Some Highlights of the Benefits of ITS Deployments in Transit Systems

In continuing surveys of over 500 transit systems across the country we find deployment of ITS technologies have focused on automatic vehicle location (AVL), operations and scheduling software programs, automated dispatching, use of mobile data terminals in buses, security systems within buses, and pre-trip passenger information. These transit systems are representative of both metropolitan and rural systems.

AVL, a basic building block for ITS applications in for transit systems, is used by dispatchers, vehicle operators, schedulers, planners, maintenance staff, supervisors, and customers. It has been deployed in a variety of areas across the country. Where deployed, AVL has improved in schedule adherence ranging from 12.5 percent to 90 percent.

Customer complaints are reduced by up to 26 percent with the installation of computer-assisted dispatch (CAD) and AVL systems. Silent Alarm systems have supported a 33 percent reduction in passenger assaults where deployed.

Software that assists scheduling, dispatching, record keeping and billing have reduced agency-operating costs by up to 8.5 percent per vehicle mile.

Some Highlights of the Benefits to Commercial Vehicle Operation

Three main technology areas are designed for commercial vehicle operations (CVO) applications are safety information exchange, electronic screening and electronic credentialing.

As of 1999, 84 percent of the States were using Aspen, a software system that facilitates recording and processing of inspection data and provides historical information on the safety performance of motor carriers.

Nearly 7000 motor carrier fleets nationwide are participating in such electronic screening programs as Pre-Pass or NORPASS, which is saving operators significant time in bypassing of inspection and weigh stations.

Some Highlights of the Intelligent Vehicle Initiative (IVI)

Research and development activities underway with industry are heavily focused at the potential safety benefits of IVI.

Given that approximately one-third of fatalities are related to run-off-the-road and one-fourth with intersections, the following activities will truly help reduce fatalities in the future.

- Road Departure Crash Warning—An operational test for a system that can warn a driver when they are about to drift off the road, or are traveling too fast for an upcoming curve.
- Intersection Collision Avoidance System—The Intersection Collision Avoidance System is designed to provide a driver with warnings of an impending crash or potential hazards at intersections.
 - “Rollover Stability Advisor” to address large truck rollovers.
 - An operational test of large trucks equipped with a collision warning system and an advanced braking system.
 - An operational test of an infrastructure-assisted hazard warning system for commercial vehicles.
 - An operational test of a fleet of snowplows equipped with collision warning and lateral guidance.
 - Adaptive Cruise Control—Automatic “headway keeping” to maintain safe space between vehicles and warn drivers if following too closely.

Some Highlights of ITS Standards Deployment

ITS standards are the means by which the agencies and industry ensure that the tools and technologies being deployed are adaptable and interoperable over time.

We are pleased to report that the ITS standards development partnership with the several organizations has been very successful. The Federal, State, local and private sector partnership has:

- Developed over 50 key ITS standards.
- Balloted and approved by AASHTO 24 ITS standards and will be balloting another 23 within the next 3 years.
- Supported training in the application of key ITS standards, encouraged State departments of transportation to deploy ITS technologies using the new ITS standards, conducted case studies of the applications of ITS technologies to share with others, and produced a series of guide documents to assist with the application of the standards.
 - Given special attention to the deployment of actuated signal systems, dynamic message signs, traffic management center-to-center communications, incident management, and road weather information systems.

As widely understood in the computer and communications world, the technology is changing so rapidly that standards developed today are soon obsolete or in great need of revision and enhancement. Thus it is important that the partnerships with FHWA, the Institute of Transportation Engineers (ITE), the National Electrical Manufacturers Associations (NEMA) and others be maintained and that funding to support the development and enhancement of standards for evolving technologies continue.

PARTNERSHIPS CREATED THROUGH ITS RESEARCH AND DEPLOYMENT

One of the exciting benefits of the research, testing and deployment of new ITS technologies has been the unique partnerships that have been formed over the last 10 years. Federal, State and local governments have found that ITS technologies have created an environment in which new sharing opportunities can be realized. Associations like ITS America, ITE, NEMA, American Public Works Association (APWA), American Public Transportation Association (APTA), Association of Metropolitan Planning Organizations (AMPO) and others have come together to ensure consistent public agency and industry communication and development of guidelines, input to national directions, and provision of new services to the public. Examples include:

- Transportation operations and management centers are springing up all over the country. These operations/communications centers feature unique partnerships between State and local agencies, law enforcement and public safety agencies and in some cases transit operations. The foundation of these partnerships is the need for common information which is enabled by the shared technology tools needed by all agencies, such as automatic vehicle location (AVL), CAD and joint operations in

responding to incidents and emergencies and in providing traffic conditions reporting via the Internet through other means.

- National partnerships have been formed between AASHTO, ITS America, APTA, AMPO, Cellular phone associations, FHWA and others to guide the uniform deployment of the new national traveler information phone number 511.
- Jointly sponsored national and international conferences to share and advance the State of the use of ITS technologies.
- Partnerships that have been formed to develop and maintain the standards that provide the unifying operations between public and private sector partners.
- Numerous public/private partnerships have been implemented as ITS systems and technologies have been researched and deployed throughout the country.
- Unique partnerships that have been formed between Federal and State agencies, national associations and the higher education community to cooperatively pursue ongoing research and testing of new technologies and educational programs to mainstream ITS into use throughout the Nation.

A LOOK TO THE FUTURE

While much has been accomplished, the work is not done. The transportation community is now just beginning to realize the full potential of the ITS tools and technologies from the first 10 years of research, testing and deployment. These are truly exciting times in technology deployment. ITS is worldwide in its scope, long-term in its impact and commitment, and opening the opportunity for us to truly manage and operate our transportation systems in concert and make the customer experience seamless. We have turned the corner and ITS has now become pervasive and unseen in our society. The opportunities we face in the next generation of work in ITS include:

- Integrating systems through ensuring that our standards are open, flexible and easy to use. We must make sure that we do not build barriers to deployment of the next generation of advanced systems.
- Creating partnership opportunities among public organizations at Federal, State and local levels to ensure that we realize the full potential of ITS tools. ITS requires that the public and private sectors cooperate at a level not previously required. This will require reform of rules affecting the relationship between government and private sector providers.
- Institutionalizing an operations approach to managing our transportation systems. To optimize efficiency, organizations must now institutionalize these tools and commit to providing services in ways that are customer focused.
- Continuing the Federal research and operational testing of the technologies that are emerging for new and better ways of providing customer service and different ways of doing the transportation business. We will need continued efforts on better system integration tools, improved data collection and vehicle monitoring technologies, advanced transportation system management technologies, intelligent vehicle initiatives—with a strong emphasis on crash avoidance, integrated user information systems, and human factors.
- Continue strong Federal funding for educating and training a differently skilled transportation professional and then integrating them into transportation organizations.
- Continue Federal support for continually monitoring and updating the scores of technical standards as technology changes and as deployment experiences suggest modifications to the standards.
- Focusing on achieving public awareness and political support to more clearly articulate how ITS is contributing to safety and quality of life, while offering them true choices in how their travel time is most productively spent.
- Recognizing that the traveler is truly a customer with varying individual requirements. ITS can make it possible for the customer to expand their options and pattern their transportation options to fit their life styles.
- Committing the necessary resources to deployment of ITS technologies by Federal, State and local governments and the private sector. This includes continuing the special Federal funding for deployment.
- Simplifying ITS project approvals through possible changes to administrative regulatory and statutory requirements.

We are at the end of the beginning. We must now finish the journey. We must now reach to create integrated and market driven systems that cause us to work together in new and different ways to improve the operation of our systems, and to improve safety and our quality of life.

STATEMENT OF LAWRENCE YERMACK, CHAIRMAN, BOARD OF DIRECTORS, INTELLIGENT
TRANSPORTATION SOCIETY OF AMERICA

INTRODUCTION AND BACKGROUND

Chairman Reid, Ranking Member Inhofe and Members of the Committee, thank you for the opportunity to discuss the Intelligent Transportation Systems program with you today—systems that are saving lives, time, and money, and improving the quality of life for all Americans. My name is Lawrence Yermack; I am the Chairman of the Board of the Intelligent Transportation Society of America (ITS America). ITS America is a non-profit 501(c)(3) organization, with over 600 members, including State departments of transportation, associations, non-profits, universities, and private companies. These member organizations represent some 60,000 individuals involved in intelligent transportation programs around the world. ITS America also serves as a utilized Federal Advisory Committee to the U.S. Department of Transportation, rendering programmatic advice to the U.S. DOT on issues of research, development, and deployment of ITS technologies.

Since its founding in 1990, ITS America has been, and continues to be, the only public-private partnership focused exclusively on fostering the use of advanced technologies in today's surface transportation systems. ITS America first received modest Federal funding under the Intermodal Surface Transportation Efficiency Act (ISTEA) of 1991 (P.L. 102-240, Dec. 19, 1991). Since 1991, the national ITS program has pursued research, technology development, and field-testing of ITS technologies, and has promoted the deployment of ITS applications.

In addition to serving as the volunteer Chairman of ITS America, I am the President of PB Farradyne, Parson Brinckerhoff's intelligent transportation systems company, responsible for the financial management, technical oversight and operations of the company. Over my career, I have worked in both the public and private sectors and I have considerable professional experience in the fields of financial and program management of toll systems, ITS and advanced toll technologies.

I am honored to appear before you today to discuss the progress we have made in deploying intelligent transportation systems. My message to you today is this: the significant investment that the Federal Government has made in ITS, along with investments made by States and the private sector, have been well spent and have delivered meaningful and significant benefits to the safety and mobility of the American people.

To illustrate this point, in my remarks I will address how ITS has been deployed across the country, discuss the many benefits generated by deployment of ITS, and finally touch on the future direction of ITS.

A FRAMEWORK FOR UNDERSTANDING ITS DEPLOYMENT

Since the inception of the ITS program in the early 1990s, government agencies—at all levels—have come to realize the important benefits that ITS technologies can provide. Proper investment in ITS can produce a safe, efficient, and environmental friendly transportation system that provides mobility for all of its citizens.

The private sector also has come to realize the vast market opportunity that ITS provides not only in the business-to-government and business-to-business marketplaces, but also increasingly in the consumer marketplace. The ITS program has laid the foundation for an explosion in consumer-oriented technologies.

What Has Been Deployed?

At the end of 2000, 55 of the 75 largest metropolitan areas had met the goal of medium-to-high deployment of ITS. Here are a few of the significant milestones.

- Electronic toll collection has been installed on 73 percent of existing toll road mileage.
- Centralized or closed loop control has been installed at 49 percent of signalized intersections.
- Computer-aided dispatch has been installed in 67 percent of the emergency management vehicles and 36 percent have in-vehicle route guidance.
- Electronic surveillance has been installed at 65 percent of the signalized intersection and 71 percent have emergency preemption.
- Traffic Management Centers have been established in two-thirds of the areas monitoring freeway traffic and providing early notification of incidents.

Over 384 public transit systems nationwide have installed, or are installing, components of ITS to provide the public with safer and more effective public transportation.

- Advanced communication systems have been installed at 213 transit agencies.
- Automatic vehicle location systems have been installed at 154 agencies.

- Electronic payment systems have been installed at 108 transit agencies.
- Automatic passenger counters have been installed at 154 transit agencies.
- Automated Transit information is available 163 transit agencies.
- Computer-aided Dispatch systems are available at 152 agencies.
- Traffic signal priority is available at 55 agencies.

CONSUMER AUTOMOBILE PROGRAMS

Telematics devices (advanced in-vehicle communications technologies) allow for automated crash identification, keyless entry, remote diagnostics, and a variety of mobile commerce applications. According to a study by McKinsey & Company, the telematics marketplace will likely generate up to \$100 billion in sales in the United States, Japan and Western Europe by 2010.

Onstar, one of more recognized telematics brand names, currently has 1.2 million subscribers. Over 8 million navigation units have been deployed in automobiles worldwide. The Federal ITS Program has been essential to the growth of this emerging marketplace as well as to the development of other safety-enhancing vehicular technologies.

The Light Vehicle Program of the Intelligent Vehicle Initiative is a crucial part of this deployment. The program establishes minimum performance requirements and standards, and fosters the development of cooperative systems, both vehicle-to-vehicle and vehicle-to-infrastructure.

Examples of completed accomplishments are the NHTSA/Volpe analysis of Forward Collision and Roadway Departure countermeasures and the Field Trial of Adaptive Cruise Control systems. Ongoing research projects include the Field Trial of a Forward Collision Warning system and the establishment of the IVI Enabling Research Consortium for joint public-private research. Key future efforts will include the Field Trial of an advanced Roadway Departure system and the identification and design of cooperative systems for near-term deployment.

There are two significant means by which the IVI program has accelerated the growth of in-vehicle electronic marketplace. As wireless and location technology has progressed, there has been a concomitant increase in the ability of vehicle manufacturers to offer safety, information and entertainment features. IVI research is revealing the safety effects associated with these systems and will determine the availability of these features while the vehicle is in motion. Safety warning systems based on IVI activities include deployed Adaptive Cruise Control with safety warnings and first-generation Roadway Departure Warning systems (announced for deployment).

COMMERCIAL VEHICLE PROGRAMS

The trucking industry has begun to adopt three ITS technologies in attempt to enhance the safety, efficiency, and productivity of the movement of goods on America's roads: transponders, Commercial Vehicle Information Systems and Networks (CVISN), and Intelligent Vehicle technologies for heavy trucks.

Transponders have the ability to monitor drivers, vehicles and loads to ensure safe, and efficient operations. For instance, transponders which have already been approved for use by the U.S. Customs Service, allow a safety enforcement agency such as the State Police, or State Motor Vehicle Department to input data related to safety, taxes, permitting, driver identification and freight load information in a single device. Use of this type of technology ensures the safe operation of all trucks, including those domiciled outside our Nation's borders, as they travel on U.S. roads, while permitting the tariff agency to perform its functions as well. The goal is to facilitate the deployment of a single multi-purpose transponder to handle functions including toll payment, safety, credentialing, weigh in motion pre-clearance, and other e-commerce applications. This is a rapid growth area and presently there are 30 States, which employ transponders for preclearing trucks through roadside inspection stations. The 13 Northeast states throughout the Interagency Group employ a single transponder known as EZPass for its electronic toll collection system which boasts of over 6 million devices in use today. These types of transponders can ultimately be used at the borders to record and monitor the entry of safe vehicles and drivers into and throughout the country.

The second area of interest is credential administration. States and the motor carrier industry have collaborated to develop and deploy such programs consistent with the Federal Commercial Vehicle Information Systems and Networks (CVISN) architecture.

Eight States have completed the initiation of a CVISN and 34 others are actively in the process of completion. Results of testing have shown many positive results including a 75 percent reduction in the current cost of credential administration for

both the States and industry, with a \$20 per process savings in fees (Kentucky estimates based upon systems deployed in the State). Also a cost/benefit savings for motor carriers ranging between 4:1 and 20:1, depending on carrier size (American Trucking Associations Foundation Study), and reductions in State administrative costs resulting in these programs being self sufficient in most States (study by the National Governors Association).

The last area of potential benefits from technological deployments relates to the Intelligent Vehicle Initiative for Heavy Trucks. This is an ongoing program sponsored by the U.S. DOT with partners from various private sector enterprises. The benefits derived from front-end collision warning devices when coupled with the action of the adaptive cruise control systems are potentially enormous. Field Operations Tests are underway to determine the exact extent of these expected savings, not only in dollars, but also in lives saved. Other tests now underway include work zone warnings, and rollover warning and protection devices.

WHAT HAVE WE ACHIEVED?

Four benefit areas and associated goals have been identified against which change and progress can be measured. These goals provide the guideposts for fully realizing the opportunities that ITS technology systems can provide in enhancing the operation of the Nation's transportation systems, in improving the quality of life for all citizens, and in increasing user satisfaction, whether for business or personal travel.

SAFETY BENEFITS

Some of the benefits that have been realized by using ITS to improve safety include:

- Automated enforcement of traffic signals has reduced violations 20 percent to 75 percent, leading to reductions in crashes and fatalities.
- Ramp metering has shown that these systems reduce crashes by 15 percent to 50 percent.
- Implementation of ITS results in smoother traffic flow and fewer stops, which enhances safety by providing less speed variance and fewer opportunities for conflicts.
- Road Weather Information Systems, combining pavement condition and other environmental sensors with driver advisories through Dynamic Message Signs (DMS), have proven effective in lowering speeds and increasing safety during adverse driving conditions.
- Provision of a silent alarm feature with an AVL system helps improve safety of many transit systems around the country. In Denver, this feature decreased the number of passenger assaults per 100,000 passengers by 33 percent between 1992 and 1997.

EFFICIENCY BENEFITS

Some of the benefits that have been realized by using ITS to improve system efficiency and economy include:

- Adaptive signal control has reduced delay from 14 to 44 percent.¹
- Aggressive incident management programs have saved travelers in metropolitan areas 100,000–2,000,000 hours per year.
- Ramp metering systems have produced 8 to 60 percent increases in speed (i.e., improved throughput) on freeways.
- Electronic toll collection can reduce the costs of plaza-related roadway maintenance by 14 percent. A study of the Carquinez Bridge in California estimates a person-time savings of nearly 80,000 hours (per year), more than \$1 million in lost time.
- Incident management has saved travelers in a metropolitan area \$1-\$45 million per year, depending on the extent of the system.
- An electronic fare payment system in New Jersey has saved \$2.7 million in reduced handling costs of fare media with increased revenues of 12 percent after automated fare collection implementation.
- Implementation of "next vehicle arriving" technology, AVL (automatic vehicle location), and CAD (computer-aided dispatching) has added more certainty for many transit riders in several cities. In the Denver Regional Transportation District, for example, the number of passengers that arrived at stops late decreased by 21 per-

¹Data on the benefits of ITS that are presented in this section and subsequent sections of the White Paper were extracted from the ITS Benefits database, located at <http://www.benefitcost.its.dot.gov/>

cent; in Portland, Oregon, the Tri-Met system achieved a 9.4 percent improvement in on-time performance.

MOBILITY BENEFITS

Some of the benefits that have been realized by using ITS to improve users' mobility in and access to the transportation system include:

- Advanced traveler information systems (ATIS) have improved the ability of individuals to manage their travel, improving the likelihood of choosing a departure time, route, and mode of travel enabling them to arrive at or before desired arrival time. ATIS users reduce late arrivals by 69 percent when compared to those who don't use ATIS.

- The Federal Communications Commission has allocated the "511" number for the provision of traveler information. Data gathered by traffic management systems, including accidents, road conditions, and alternative routes can be directly accessed by drivers to empower drivers to make optimum route selection, to shorten travel time, and to reduce the stress of congestion.

Smart card technology is simplifying the daily commute of more than 100,000 daily transit users in the Washington DC area. The New York City Metro Card system is expected to save an estimated \$70 million per year in fare evasion. Ventura County California will save an estimated \$90,000 by eliminating transfer slips.

Public transportation providers in rural areas can achieve cost efficiencies by increasing ridership. The CAD system in Sweetwater County, Wyoming (which allows same-day ride requests to be accepted) has contributed to a 3,000 passenger monthly increase while reducing operational expenses by 50 percent over a 5-year period on a per passenger basis.

HOW HAS ITS PROMOTED A CLEANER ENVIRONMENT AND REDUCED ENERGY CONSUMPTION?

Some of the benefits that have been realized by using ITS to mitigate the negative community and lifestyle impacts of congestion, crashes, air quality, noise and other factors include:

- Electronic Toll Collection in Florida has resulted in emissions reductions of 7.3 percent for CO, and 7.2 percent for HC with 40 percent ETC usage.

- Improvements to traffic signal control systems have reduced fuel consumption between 2 percent and 13 percent.

- TransGuide in San Antonio, Texas reports estimated fuel consumption savings of up to 2,600 gallons per major incident as a consequence of reduced congestion during incident response and clearing.

- The development and use of better models and more robust data on environmental impacts will provide more information on the extent to which ITS technologies positively affect the environment and how ITS can be used proactively to address problems in nonattainment areas. The future goal is to save a minimum of one billion gallons of gasoline each year and to reduce emissions at least in proportion to these fuel savings through the use of ITS technologies.

WHAT ROLE HAS ITS AMERICA PLAYED IN DEPLOYMENT?

Since its inception in 1991 ITS America has served a pivotal role in the development and deployment of ITS technologies and systems. In 1992 ITS America developed the first Program Plan which has served as the blueprint for ITS deployment in the last decade. ITS America was instrumental in the development of the National ITS Architecture and development of standards working closely with the Standard Development Organizations. Today, ITS America continues to bring the diverse interests of the ITS Community to the table to foster cooperative development and deployment of these technologies. As rate of deployment increases, the need for this cooperation between State, local, and Federal Government and the private sector only increases. ITS America's technical committees (which meet with regularity) continue provide a forum for technical experts for the private sector, government, academia to reach consensus essential to the timely deployment of ITS systems.

A VISION FOR THE FUTURE

In each of these areas, the integrated nature of ITS technologies and services promotes opportunities (and presents challenges) for the institutional reform and re-invention that is so critical to the next stage of the transportation service delivery and infrastructure management.

In the future, the initial investment in ITS infrastructure and in-vehicle technologies may be seen as the first wave of a technology revolution. The second wave of the ITS technology revolution will be the integration of localized intelligent transportation systems into larger and larger integrated networks of information. Communications from vehicle-to-infrastructure and from infrastructure-to-vehicle will become richer. Both the quality and quantity of data transmission will increase. And as a result of network integration, not only will we see greater efficiencies in America's transportation system; we will see a fundamental shift in how America does business.

For example, the mass adoption of personal computers in the 1970s and 1980s did not significantly increase workplace productivity until these computers were networked in the 1990s—and then the increased productivity was dramatic. Similarly, while the initial investment in ITS has produced only modest gains in efficiency, once these transportation information systems are widely deployed and networked, then, we will enjoy dramatically increased efficiencies.

Development of an Integrated Network of Transportation Information

The future vision for surface transportation is based on information management and availability, on connectivity, and on system control and optimization—in short, the creation of an integrated national network of transportation information.

The information to be gathered and managed includes the physical State of the infrastructure, how it is being used (real-time and historically), how it is being maintained, and the environment, including relevant weather conditions. This information network depends on forging new forms of stakeholder cooperation across all sectors.

Seamless Travel for People. For the traveling public, an integrated network of transportation information makes travel reasonable and convenient for all users, regardless of age or physical disability. It means availability of static and real time information on the availability and condition of components of the transportation system that will allow choice of travel mode. It means full coordination between transit, rail, highway, and arterial systems. It means eliminating missed connections and, through work-zone management, eliminating confusion during detours and diversions.

Information will be available on all modes via web-based, radio and calls centers and will include automobile and transit travel. Other information services will include online mapping and driving direction, en-route variable message signs and kiosks, and personal subscription services as well as real-time information for both pre-trip planning and enroute modifications, covering the current and expected conditions.

Seamless Freight Movement. For the movement of freight, an integrated network of transportation information means the availability of information that will facilitate shipments moving more efficiently from origin to destination both within and across modes. It means real time information at points where shipments transfer from one mode of transportation to another and cross-jurisdictional boundaries. Shippers and customers will have better information on the location of cargo and mobile assets throughout the trip. It means information will be exchanged more efficiently to and among regulatory agencies.

Advanced Crash Avoidance Technologies

Advanced crash avoidance technologies will help to significantly reduce the number of vehicle crashes. Unprecedented levels of safety, mobility, and efficiency will be made possible through the development, integration, and deployment of a new generation of in-vehicle electronics and vehicle automation. These technologies also support selective automated enforcement, including the determination of fitness to drive.

In-Vehicle Electronics and Vehicle Automation. Four kinds of in-vehicle electronics products will be available: information products, diagnostic/prognostic products, driver assistance products, and active safety products. All will help drivers and vehicles to perform better and more safely.

Driver Qualification and Automated Enforcement: Technology will be available to assure that a driver/operator is appropriately licensed, unimpaired, and alert. Automated enforcement that is carefully applied and protective of personal privacy will reduce crashes and encourage safe and responsible driving.

Automatic Crash Detection and Response

Getting emergency response teams to the scene of a crash or other injury-producing incident as quickly as possible is critical to saving lives. ITS technology will allow emergency response teams to receive timely notice of the incident and be efficiently routed to the scene and then to the hospital. It means they will be aware

of and able to convey the nature and degree of the injuries and thereby provide timely medical care.

Traffic-sensitive route planning software will identify which EMS unit, among those available and appropriate for the specific incident, can arrive at the accident site in the shortest travel time. Route guidance software will efficiently direct the unit to the scene, with the way cleared and the trip speeded by traffic signal preemption and other traffic control mechanisms. At the scene, direct audio and video communication with the trauma center will provide the EMS team with instructions on immediate treatment.

Advanced Transportation Systems (encompassing multiple transportation modes)

Advanced transportation systems facilitate better management of the flow of vehicles (automobiles, public transit vehicles, and trains) through the physical infrastructure; better vehicle operator decisions based on the cooperative exchange of data between vehicles and the infrastructure, and system automation.

Advanced Transportation Management Systems. Advanced transportation management systems enable area-wide surveillance and detection, rapid acquisition of traffic flow data, real-time evaluation of traffic flows, predictive capabilities regarding near-term, real-time operational responses to traffic flow changes, and evaluation of the operational responses to traffic flow changes.

Vehicle-Infrastructure Cooperation. An important foundation for effective transportation management is an exchange of information between equipped vehicles and the infrastructure. The infrastructure may include instrumented roadways or wireless communications between vehicles and an information provider. Vehicles will report on the rate at which traffic is flowing, the condition of the roads, weather conditions, etc. The infrastructure-based system will analyze these data to create an overall understanding of the roadway environment and report this back to vehicles and their drivers/operators to use in planning travel.

Transportation Automation. Technologies will include automation of all or part of the driving task for private cars, public transportation vehicles, and maintenance vehicles through an intelligent physical infrastructure. The primary objective is to increase capacity and flow. Research in infrastructure-vehicle automation will include automated rapid transit systems, precision docking of vehicles, dedicated lanes for automated trucks, automatic guidance of snow removal and other maintenance vehicles, and eventually, fully automated passenger vehicles.

Mobile Commerce. The same in-vehicle communication systems (or telematics) which enable automated crash identification and vehicle-infrastructure cooperation allows the automobile to become the point-of-purchase for consumer transactions. Hotel reservations, shopping, and even stock transactions can be (and to an extent are currently being) conducted through the use of telematics devices. The GPS and other vehicle-identifying technologies inherent in ITS, will enable businesses to offer consumers location-specific goods and services. The advent of mobile commerce will be part of the fundamental shift in how Americans do business through the use of ITS.

CONCLUSION

ITS research and deployment must continue to flourish within the foreseeable future. ITS technologies are quickly becoming part of the fabric of design and operation of our Nation's transportation system and hold the promise of continuing to provide our citizens the most efficient, the safest and the most environmentally sound transportation system in the world. We look forward in working with you to design a continuing ITS program that will fulfill the dreams of the American traveling public and the private sector industry that will benefit from a vital ITS program.

Thank you.

Tracking the Deployment of the Integrated Metropolitan Intelligent Transportation Systems Infrastructure in the USA: FY2000 Results

July 2001

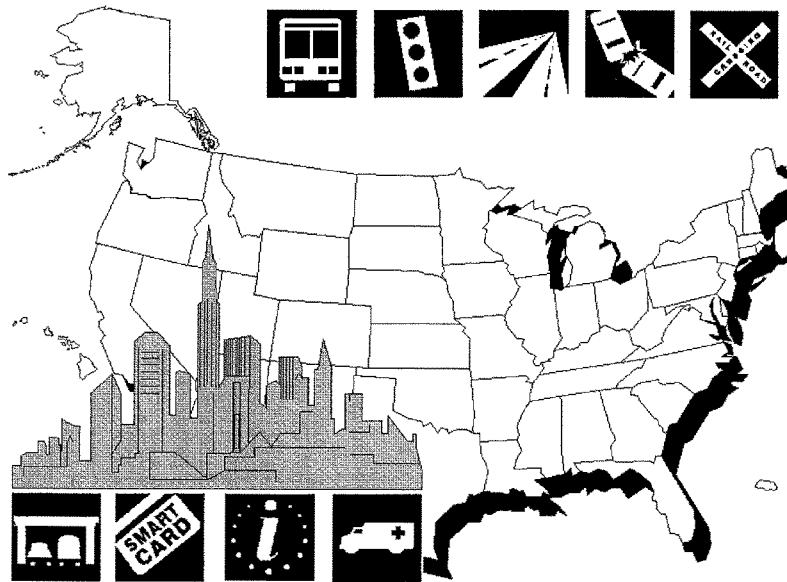

Prepared for:

ITS Joint Program Office
Federal Highway Administration
Washington, DC

1. Report No. FHWA-OP-O1-136	2. Government Accession No.	3. Recipient's Catalog No.	
4. Title and Subtitle Tracking the Deployment of the Integrated Metropolitan Intelligent Transportation Systems Infrastructure in the USA: FY2000 Results		5. Report Date July 2001	
		6. Performing Organization Code	
7. Author(s) Steve Gordon and Jeffrey Trombly		8. Performing Organization Report No.	
9. Performing Organization Name and Address Oak Ridge National Laboratory P.O. Box 2008, Bldg 4500N, MS 6206 Oak Ridge, TN 37831-6206 Science Applications International Corporation 301 Laboratory Road Oak Ridge, TN 37831		10. Work Unit No. (TRAVIS)	
		11. Contract or Grant No. DTFH61-00-Y-30014	
12. Sponsorship Agency Name and Address Department of Transportation FHWA ITS Joint Program Office 400 Seventh Street, S.W. - Room 3422 Washington, DC 20590		13. Type of Report and Period Covered	
		14. Sponsoring Agency Code HOIT-1	
15. Supplementary Notes Contact person at JPO - Joseph Peters			
16. Abstract This report describes the results of a major data gathering effort aimed at tracking deployment of nine infrastructure components of the metropolitan ITS infrastructure in 78 of the largest metropolitan areas in the nation. The nine components are: Freeway Management, Incident Management, Arterial Management, Electronic Toll Collection, Electronic Fare Payment, Transit Management, Highway-Rail Intersections, Emergency Management, and Regional Multimodal Traveler Information. Deployment is tracked through the use of indicators tied to the major functions of each component. In addition, integration of components is tracked through examining the transfer of information between components and the use of that information, once transferred. The report summarizes results at a national level and includes information on the number of metropolitan areas deploying selected technologies related to the indicators.			
17. Key Words Intelligent Transportation Systems, ITS, Integration, Deployment Tracking, ITS Component Indicators, Regional ITS Planning, National ITS Infrastructure		18. Distribution Statement No restrictions. This document is available to the public from: National Technical Information Service Springfield, Virginia 22161	
19. Security Classif. (of this report) Unclassified	20. Security Classif. (of this page) Unclassified	21. No. of Pages 64	22. Price

Preface

This report presents the results of an update of a major nationwide data gathering effort to track the deployment of the metropolitan Intelligent Transportation Systems (ITS) Infrastructure in the largest metropolitan areas in the United States. In 1999, the U.S. Department of Transportation (USDOT) published a report updating the 1997 baseline survey. This current report documents results of a survey conducted in 2000 to update the 1999 results. Tracking deployment of ITS infrastructure is an important element of ITS program assessment since implementation of ITS is an indirect measure of effectiveness of the ITS program. Information regarding deployment activities provides feedback on progress of the program that can help stakeholders establish strategies for continued market growth. Understanding the rate of ITS deployment in various metropolitan areas can lead to insights regarding future program changes, redefinition of goals, or maintenance of current program direction.

The methodology followed to complete this effort is based on the development of deployment indicators designed to capture the most important functions provided by a particular ITS infrastructure component. The nine components tracked include: Freeway Management, Incident Management, Arterial Management, Transit Management, Electronic Fare Payment, Electronic Toll Collection, Highway-Rail Intersections, Emergency Management, and Regional Multimodal Traveler Information. In addition, indicators were developed to capture the level of integration of these components.

Questions or comments concerning the material presented in this report are encouraged and can be directed to:

Joseph I. Peters, Ph.D.
ITS Joint Program Office
Federal Highway Administration (HOIT-1)
400 Seventh Street, SW
Washington, DC 20590
(202) 366-2202
E-mail: joe.peters@fhwa.dot.gov

Table of Contents

Preface.....	ii
Table of Contents	iii
List of Figures	iv
List of Tables	v
Acronym List	vi
Executive Summary	1
Deployment Summary Indicators	2
Integration Indicators	3
Measuring Progress in Integrated Deployment.....	4
Introduction.....	5
Background	5
National Summary Indicators	6
Organization of Report	7
ITS Infrastructure Component Description and FY2000 Survey Results	8
Freeway Management.....	9
Incident Management.....	13
Arterial Management	17
Electronic Toll Collection.....	21
Electronic Fare Payment.....	23
Transit Management	25
Highway-Rail Intersection.....	27
Emergency Management	29
Regional Multimodal Traveler Information.....	31
ITS Infrastructure Integration Indicator Description and FY2000 Survey Results	33
Traffic Management Integration	35
Traveler Information Integration	40
Transit Management Integration.....	42
Emergency Response Integration	45
Deployment Goal Setting.....	47
Background	47
2000 Status of Integrated Deployment	48
Tracking Integrated Deployment Progress	52
Appendix A.....	53
Appendix B.....	55

List of Figures

FIGURE 1 NATIONAL SUMMARY INDICATORS	2
FIGURE 2 NATIONAL INTEGRATION LINKS	3
FIGURE 3 PROGRESS IN INTEGRATED METROPOLITAN ITS DEPLOYMENT	4
FIGURE 4 NATIONAL SUMMARY INDICATORS	6
FIGURE 5 NATIONAL INTEGRATION LINKS.....	7
FIGURE 6 FREEWAY MANAGEMENT COMPONENTS.....	9
FIGURE 7 SURVEILLANCE TECHNOLOGIES	10
FIGURE 8 TRAFFIC CONTROL DEVICES	11
FIGURE 9 INFORMATION DISSEMINATION	12
FIGURE 10 FREEWAY AND ARTERIAL INCIDENT MANAGEMENT	13
FIGURE 11 INCIDENT DETECTION	14
FIGURE 12 INCIDENT VERIFICATION	15
FIGURE 13 INCIDENT RESPONSE ON FREEWAYS.....	16
FIGURE 14 INCIDENT RESPONSE ON ARTERIALS	16
FIGURE 15 ARTERIAL MANAGEMENT	17
FIGURE 16 TRAFFIC SURVEILLANCE	18
FIGURE 17 TRAFFIC CONTROL	19
FIGURE 18 INFORMATION DISSEMINATION	20
FIGURE 19 ELECTRONIC TOLL COLLECTION.....	21
FIGURE 20 LANES WITH ETC CAPABILITY	22
FIGURE 21 ELECTRONIC FARE PAYMENT.....	23
FIGURE 22 VEHICLES WITH EFP	24
FIGURE 23 RAIL STATIONS WITH EFP.....	24
FIGURE 24 TRANSIT MANAGEMENT.....	25
FIGURE 25 TRANSIT MANAGEMENT TECHNOLOGIES	26
FIGURE 26 HIGHWAY-RAIL INTERSECTION.....	27
FIGURE 27 HRI SURVEILLANCE.....	28
FIGURE 28 EMERGENCY MANAGEMENT	29
FIGURE 29 EMS VEHICLES TECHNOLOGIES	30
FIGURE 30 REGIONAL MULTIMODAL TRAVELER INFORMATION.....	31
FIGURE 31 INTEGRATION LINKS	33
FIGURE 32 TRAFFIC MANAGEMENT INTEGRATION LINKS	35
FIGURE 33 TRAVELER INFORMATION INTEGRATION LINKS	40
FIGURE 34 TRANSIT MANAGEMENT INTEGRATION LINKS	42
FIGURE 35 EMERGENCY RESPONSE INTEGRATION LINKS	45
FIGURE 36 RATE OF CHANGE IN INTEGRATED DEPLOYMENT.....	48
FIGURE 37 PROGRESS IN INTEGRATED METROPOLITAN ITS DEPLOYMENT	49
FIGURE 38 LEVEL OF INTEGRATED DEPLOYMENT (ACTUAL AND GOAL).....	52

List of Tables

TABLE 1 TRAFFIC MANAGEMENT INTEGRATION LINKS	36
TABLE 2 TRAVELER INFORMATION INTEGRATION LINKS.....	41
TABLE 3 TRANSIT MANAGEMENT INTEGRATION LINKS.....	43
TABLE 4 EMERGENCY RESPONSE INTEGRATION LINKS	46
TABLE 5 METROPOLITAN LEVEL OF INTEGRATED DEPLOYMENT.....	49

Acronym List

ADOT	Arizona Department of Transportation
ATMS	Advanced Traffic Management System
AVI	Automatic Vehicle Identification
AVL	Automatic Vehicle Location
CAD	Computer-Aided Dispatch
CBD	Central Business District
CCTV	Closed Circuit Television
EFP	Electronic Fare Payment
EM	Emergency Management
ETC	Electronic Toll Collection
FHWA	Federal Highway Administration
FM	Freeway Management
FTA	Federal Transit Administration
HAR	Highway Advisory Radio
HAZMAT	Hazardous Material
HPMS	Highway Performance Monitoring System
HRI	Highway-Rail Intersections
IM	Incident Management
ISP	Information Service Provider
ITS	Intelligent Transportation Systems
IVS	In-Vehicle Signing
JPO	Joint Program Office
MMDI	Metropolitan Model Deployment Initiative
MPO	Metropolitan Planning Organization
MSA	Metropolitan Statistical Area
ORNL	Oak Ridge National Laboratory
PIAS	Personal Information Access System
RMTI	Regional Multimodal Traveler Information
RTS	Remote Transfer Support
TM	Transit Management
TSC	Traffic Signal Control
USDOT	United States Department of Transportation
VMS	Variable Message Sign

Executive Summary

In January 1996, former Secretary Peña set a goal of deploying the integrated metropolitan Intelligent Transportation System (ITS) infrastructure in 75¹ of the nation's largest metropolitan areas by 2006:

"I'm setting a national goal: to build an intelligent transportation infrastructure across the United States to save time and lives, and improve the quality of life for Americans. I believe that what we do, we must measure . . . Let us set a very tangible target that will focus our attention . . . I want 75 of our largest metropolitan areas outfitted with a complete intelligent transportation infrastructure in 10 years."²

-- Former Secretary Peña, 1996

In order to track progress toward fulfillment of the former Secretary's goal for deployment, the United States Department of Transportation (USDOT) Intelligent Transportation Systems (ITS) Joint Program Office (JPO) developed the metropolitan ITS deployment tracking methodology in 1997. This methodology tracks deployment of the nine components that make up the ITS infrastructure: Freeway Management; Incident Management; Arterial Management; Emergency Management; Transit Management; Electronic Toll Collection; Electronic Fare Payment; Highway-Rail Intersections; and Regional Multimodal Traveler Information. Information is gathered through a set of surveys distributed to the state and local agencies involved with these infrastructure components. The surveys gather information on the extent of deployment of the infrastructure and on the extent of integration between the agencies that operate the infrastructure. Deployment is measured using a set of indicators tied to the major functions of each component. Integration is measured by assessing the extent to which agencies share information and cooperate in operations based on a set of defined links between the infrastructure components. The details of the methodology are explained elsewhere.³

In FY97, the ITS JPO undertook a baseline survey of deployment in the nation's largest metropolitan areas following the metropolitan ITS deployment tracking methodology and published the results in a series of site reports and a nationwide summary report. During the summer and fall of 1999, the ITS JPO undertook a new data collection effort for the purpose of updating the 1997 survey results. This was repeated in 2000. Individual site reports have been developed for each metropolitan area surveyed. This report is a national summary of the FY2000 survey results.

¹ Since former Secretary Peña's speech, the number of metropolitan areas that DOT will measure has been increased from 75 to 78. However, to maintain reporting consistency across the 10-year goal period, this report considers only the original 75 metropolitan areas.

² Excerpt of a speech delivered by former Secretary of Transportation Peña at the Transportation Research Board in Washington, DC on January 10, 1996.

³ Additional Resources: "Measuring ITS Deployment and Integration" http://www.itsdocs.fhwa.dot.gov/jpodocs/repts_te/3dg011.pdf (also see: Electronic Document Number: 4372). U.S. Department of Transportation, Joint Program Office for Intelligent Transportation Systems, 400 Seventh St., SW (HVH-1), Washington, DC 20590, Phone: 202-366-9536, Fax: 202-366-3302, Web: <http://www.its.dot.gov>.

Deployment Summary Indicators

As will be seen in Section 2 of this report, the level of deployment of each of the ITS infrastructure components is described by a number of indicators. These indicators have been chosen to serve as estimators of the extent of technology deployment supporting critical functions. For each component, one of these indicators has been designated to serve as a summary for the whole component, allowing national results to be portrayed in a single graph. Figure 1 presents the national summary indicators. The FY2000 results are compared to results from 1999 and 1997. In addition, responders were asked to estimate deployment levels in the year 2005 as part of the 2000 survey and these projections are included in the figure. The indicators developed for deployment tracking are surrogates that do not necessarily reflect the full breadth of deployment. Because deployment goals have not been established, these indicators should not be read as a comparison of what is deployed versus eventual deployment goals. Instead, they only reflect what is deployed compared to full market saturation (i.e., the full deployment opportunity).

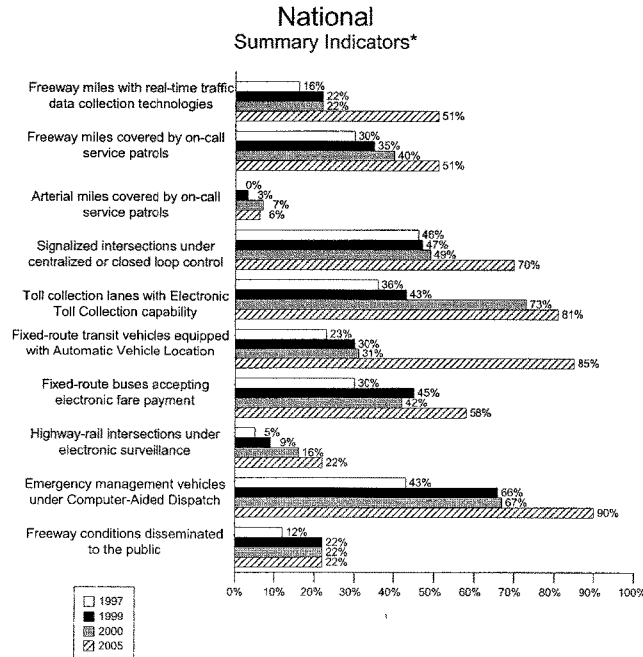

* Indicators are single surrogates that do not necessarily reflect the full breadth of ITS deployment activity.
 ** Deployment opportunity reflects potential totals that do not necessarily reflect actual need.

Figure 1 National Summary Indicators

Integration Indicators

ITS integration is measured using 34 links that have been defined within the ITS infrastructure. These links are both inter-component (e.g., the sharing of arterial and freeway traffic condition information between freeway and arterial management agencies) and intra-component (e.g., the sharing of traffic signal timing information between arterial management agencies). The measure of integration is the simple calculation of the number of agencies that participate in integration compared to the total number of agencies that possibly could. As with deployment, this measure does not make a distinction between those agencies that should be linked and those that should not. Figure 2 presents the national summary of integration results for the FY2000 survey.

2000 National Integration Links

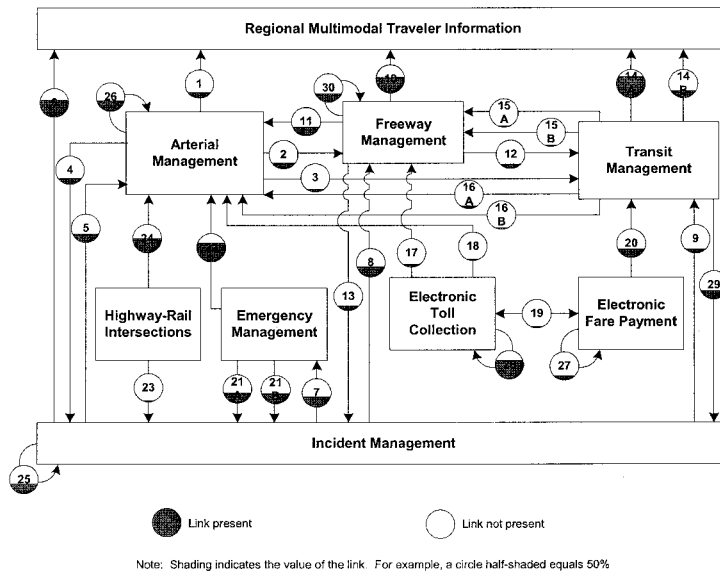

Figure 2 National Integration Links

Measuring Progress in Integrated Deployment

Deployment tracking data were used to develop a methodology for developing and tracking goals for integrated deployment to support monitoring of progress toward the former Secretary's 10-year goal. Deployment is measured using a set of threshold values for the major infrastructure components. A metropolitan area is assigned a rating of low, medium, or high based on the number of thresholds attained. Integration is measured by evaluating the existence of integration links between a subset of the infrastructure--freeway management, arterial management, and transit management. An integration rating of low, medium, and high is assigned and combined with the deployment rating to produce a single overall rating for integrated deployment. Crossing a threshold value for either deployment or integration means that a metropolitan area has made a significant commitment to deploy and integrate the metropolitan ITS infrastructure. *However, it does not mean that deployment or integration is complete.* The 10-year goal will be met if all of the 75 metropolitan areas are rated medium or above for integrated deployment. This methodology is explained in detail in section 4. Figure 3 summarizes the level of deployment in 75 of the nation's largest metropolitan areas for 1997, 1999, and 2000.

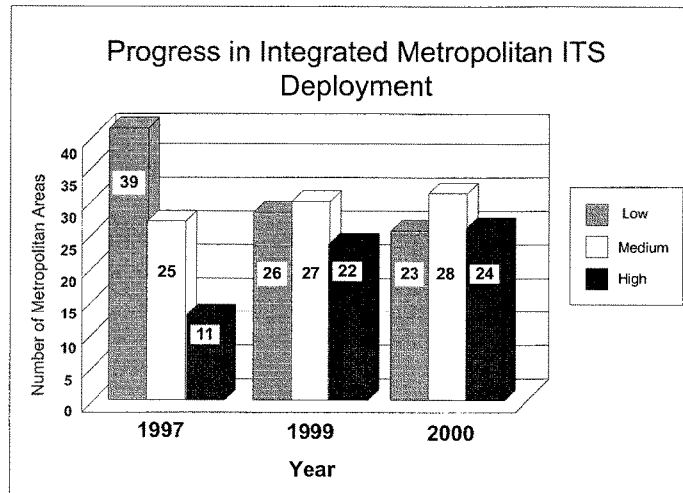

Figure 3 Progress in Integrated Metropolitan ITS Deployment

Introduction

Background

In January 1996, former Secretary Peña set a goal of deploying the integrated metropolitan Intelligent Transportation System (ITS) infrastructure in 75⁴ of the nation's largest metropolitan areas by 2006:

"I'm setting a national goal: to build an intelligent transportation infrastructure across the United States to save time and lives, and improve the quality of life for Americans. I believe that what we do, we must measure . . . Let us set a very tangible target that will focus our attention . . . I want 75 of our largest metropolitan areas outfitted with a complete intelligent transportation infrastructure in 10 years."⁵

-- Former Secretary Peña, 1996

In order to track progress toward fulfillment of the former Secretary's goal for deployment, the United States Department of Transportation (USDOT) Intelligent Transportation Systems (ITS) Joint Program Office (JPO) developed the metropolitan ITS deployment tracking methodology in 1997. This methodology tracks deployment of the nine components that make up the ITS infrastructure: Freeway Management; Incident Management; Arterial Management; Emergency Management; Transit Management; Electronic Toll Collection; Electronic Fare Payment; Highway-Rail Intersections; and Regional Multimodal Traveler Information. Through a set of indicators tied to the major functions of each component, the level of deployment is tracked for the nation's largest metropolitan areas. In addition, the integration links between agencies operating the infrastructure are also tracked. The details of the methodology are explained elsewhere.⁶

In 1997, the ITS JPO published the results of the first nationwide survey of deployment in the nation's 78 largest metropolitan areas using the metropolitan ITS deployment tracking methodology. The results of this effort are documented elsewhere. In 1999, the ITS JPO implemented a national survey effort designed to update the information collected in the 1997 survey. This report summarizes the results of the 2000 data collection effort. Information provided in this report includes a comparison of 1997, 1999, and 2000 deployment for the metropolitan ITS infrastructure components mentioned earlier. In addition, this report compares levels of integration of these components in 1999 against those measured in 2000. In the 2000 survey, agencies were asked to estimate anticipated levels of deployment by 2005. Therefore, this report also includes a comparison of 1997, 1999, 2000, and 2005 levels of deployment from a national perspective.

⁴ Since former Secretary Peña's speech, the number of metropolitan areas that DOT will measure has been increased from 75 to 78. However, to maintain reporting consistency across the 10-year goal period, this report considers only the original 75 metropolitan areas.

⁵ Excerpt of a speech delivered by former Secretary of Transportation Peña at the Transportation Research Board in Washington, DC on January 10, 1996.

⁶ Additional Resources: "Measuring ITS Deployment and Integration" http://www.itsdocs.fhwa.dot.gov/jpodocs/repis_te/3dg011.pdf (also see: Electronic Document Number: 4372). U.S. Department of Transportation, Joint Program Office for Intelligent Transportation Systems, 400 Seventh St., SW (HWH-1), Washington, DC 20590, Phone: 202-366-9536, Fax: 202-366-3302, Web: <http://www.its.dot.gov>.

Approximately two thousand survey forms were distributed in these areas with an overall response rate of 81% in 1997, 84% in 1999, and 90% in 2000.

National Summary Indicators

Several deployment indicators have been developed for each component. However, a single indicator has been selected for the purpose of summarizing the level of deployment for a particular component. The summary indicators are expressed as a percentage; however, because deployment goals have yet to be established, these indicators should not be read as a comparison of what is deployed versus eventual deployment goals. Instead, they only reflect what is deployed compared to full market saturation (i.e., opportunity for deployment). The indicators are surrogates that do not necessarily reflect the full breadth of metropolitan ITS deployment. Figure 4 portrays the summary indicators developed from the 1997, 1999, and the 2000 survey. (The 2000 survey asked for estimated 2005 levels of deployment.)

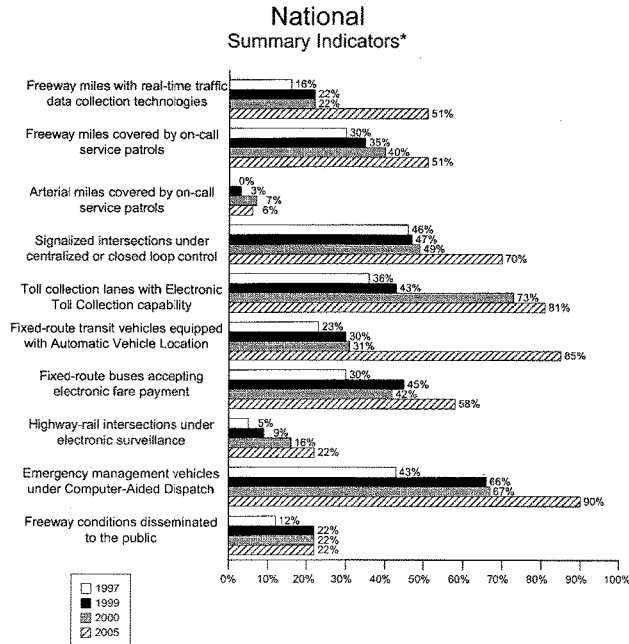

* Indicators are single surrogates that do not necessarily reflect the full breadth of ITS deployment activity.
 ** Deployment opportunity reflects potential totals that do not necessarily reflect actual need.

Figure 4 National Summary Indicators

Figure 5 portrays the national summary indicators for integration. As with the component indicators, definitions for inter- and intra-component integration were developed for each component. Indicators derived from these definitions were also produced for each component. A total of 34 individual integration indicators were specified and are portrayed in the third figure, which follows. Each integration indicator has been assigned a number and an origin/destination path from one ITS infrastructure component to another. For example, the number “10” identifies the integration of information from the Freeway Management component to the Regional Multimodal Traveler Information component.

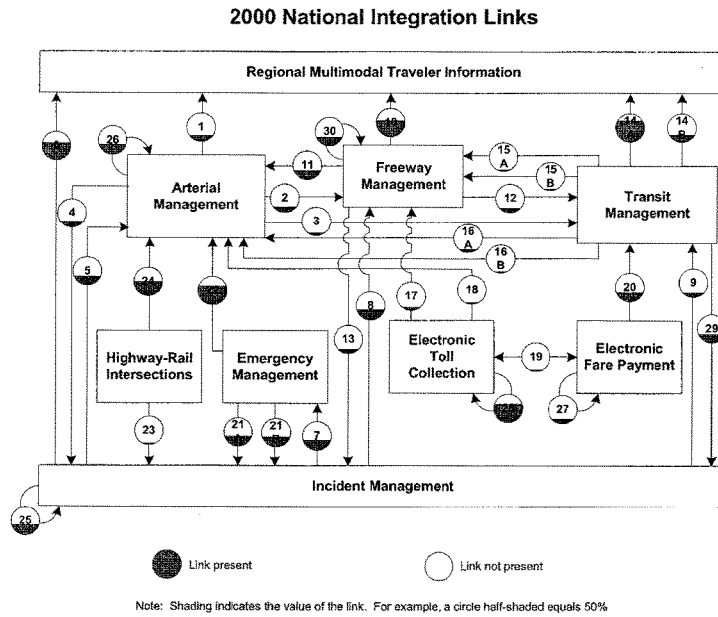

Figure 5 National Integration Links

Organization of Report

This report is divided into five parts: Executive Summary; Introduction; ITS Infrastructure Component Description and FY2000 Survey Results; ITS Infrastructure Integration Indicator Description and FY2000 Survey Results; and Deployment Goal Setting.

ITS Infrastructure Component Description and FY2000 Survey Results

This section presents deployment-tracking indicators for each of the nine metropolitan ITS components. The following information is provided for each component:

1. A description of the basic functions performed by each component.
2. Data gathering results for each indicator displayed in a set of graphs. The horizontal bar graph that portrays results is expressed as a percent of deployment opportunity achieved for each indicator. The deployment opportunity reflects the total potential deployment and does not necessarily reflect actual need. For example, freeway management indicators are compared to a deployment opportunity consisting of the entire freeway system and are not corrected for any assessment of how local conditions might limit the scope of deployment to a portion of the freeway system. These indicators are single surrogates that do not necessarily reflect the full breadth of ITS deployment activity. Where possible, FY2000 results are compared to FY1997, FY1999, and estimates for FY2005. In some cases, a decrease in deployment or integration over time occurs. This may be due to difference in reporting from year to year, agencies responding one year and not the other, or an actual decrease in the level of deployment.
3. Additional survey results are used to evaluate the extent that individual metropolitan areas have adopted technologies. This information is displayed in graphs that show the number of metropolitan areas reporting the presence of a particular technology that supports a component. In many cases, metropolitan areas have more than one of these technologies. As with the indicators, FY2000 results are compared to FY1997 results, FY1999 results, and 2005 estimates.

Freeway Management

Freeway Management Functions

Freeway Management provides the following traffic management functions:

1. Capability to monitor traffic conditions on the freeway system in real-time (i.e., traffic surveillance).
2. Capability to implement appropriate traffic control and management strategies (such as ramp metering and lane control) in response to recurring or non-recurring flow impediments (i.e., traffic control).
3. Capability to provide critical information to travelers through infrastructure-based dissemination methods such as Variable Message Signs (VMS), Highway Advisory Radio (HAR), or In-Vehicle Signing (IVS) (i.e., information display).

The Freeway Management component indicators are shown in Figure 6.

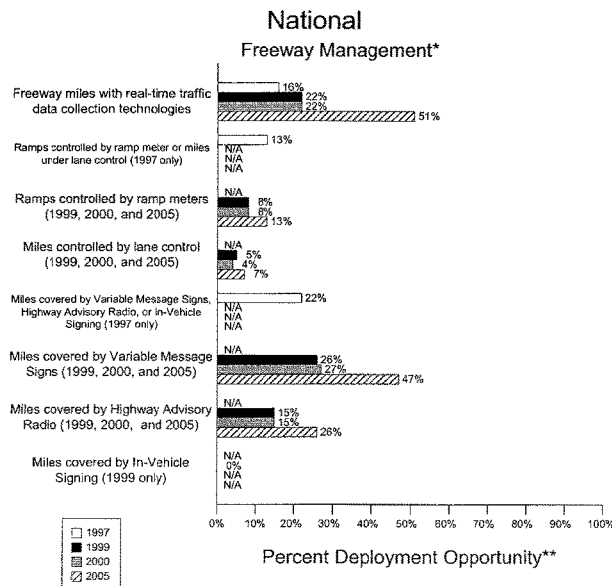

* Indicators are single surrogates that do not necessarily reflect the full breadth of ITS deployment activity.
 ** Deployment opportunity reflects potential totals that do not necessarily reflect actual need.

Figure 6 Freeway Management Components

Traffic Surveillance

Figure 7 contains the number of metropolitan areas that use various surveillance technologies. Some metropolitan areas use more than one technology. The most frequently used electronic surveillance technology is loop detectors, although radar detectors and video image detectors show the greatest projected growth.

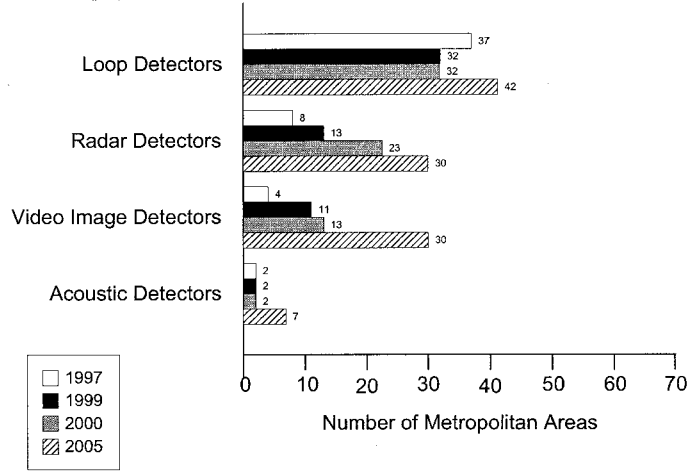

Figure 7 Surveillance Technologies

Traffic Control

Traffic condition data are analyzed to identify the cause of a flow impediment and to formulate an appropriate response in real-time. Traffic control devices, such as ramp meters or lane control devices, may be applied to provide a better balance between freeway travel demand and capacity during congested conditions.

Figure 8 contains the number of metropolitan areas that use lane control or ramp metering, the type of ramp meter control used, and the number of metropolitan areas that have ramp meter preemption for emergency vehicles and priority for transit vehicles.

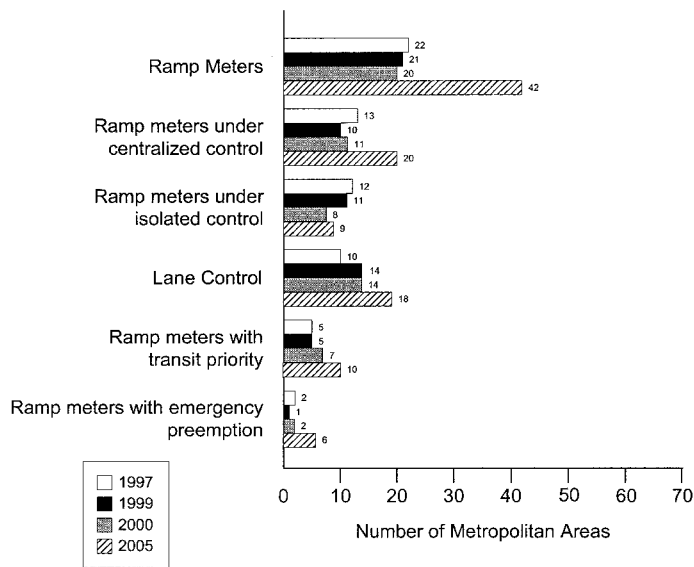

Figure 8 Traffic Control Devices

Information Display

Information may be provided to travelers through roadside traveler information devices such as VMS, HAR, and IVS.

Figure 9 contains a summary of the number of metropolitan areas reporting the use of information display technologies. The most frequently used technology is VMS, followed by HAR. No metropolitan area reports using IVS.

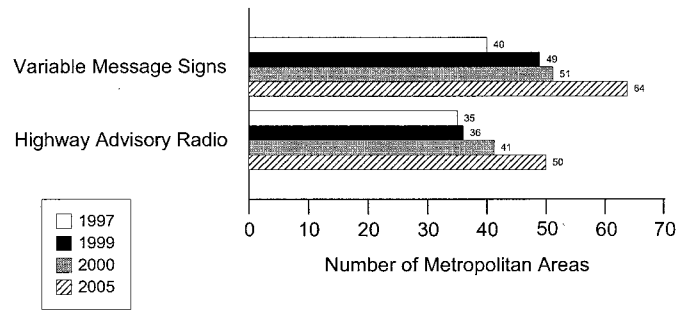

Figure 9 Information Dissemination

Incident Management

Incident Management Functions

Incident Management provides the following traffic management functions in real-time:

1. Capability to detect incidents on the freeway and arterial roadway system (i.e., incident detection).
2. Capability to verify incidents on the freeway and arterial roadway system (i.e., incident verification).
3. Capability to respond to incidents on the freeway and arterial roadway system (i.e., incident response).

The Freeway and Arterial Incident Management component indicators are shown in Figure 10.

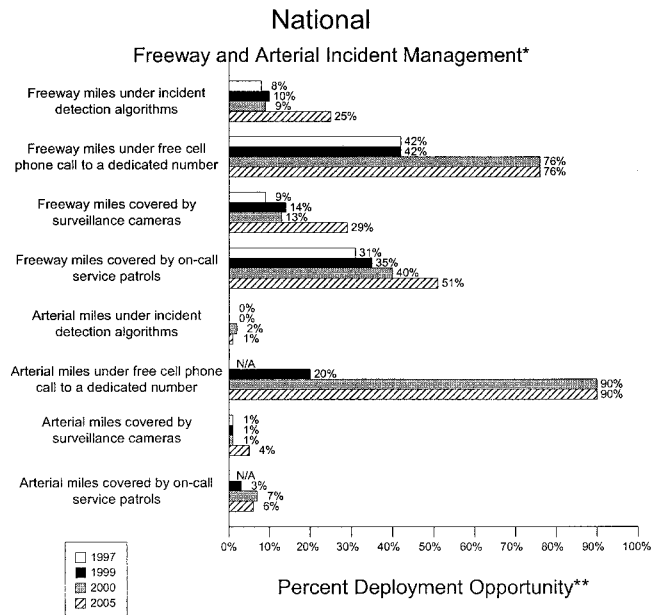

* Indicators are single surrogates that do not necessarily reflect the full breadth of ITS deployment activity.
 ** Deployment opportunity reflects potential totals that do not necessarily reflect actual need.

Figure 10 Freeway and Arterial Incident Management

Incident Detection

Monitoring of freeway conditions for the purpose of incident management is usually integrated with Freeway Management, with notification of the presence of an incident provided to the Incident Management component.

Figure 11 contains the number of metropolitan areas that use various incident detection methods. Use of free cellular phone calls to a dedicated number is the most commonly used method. Incident detection algorithms are also used in freeways and arterials.

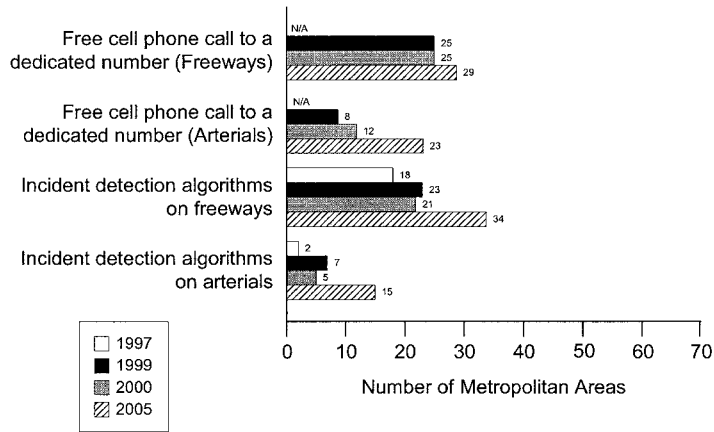

Figure 11 Incident Detection

Incident Verification

Incident verification is typically accomplished through observation by cameras.

Figure 12 contains the number of metropolitan areas that use surveillance cameras for incident verification on arterials and freeways.

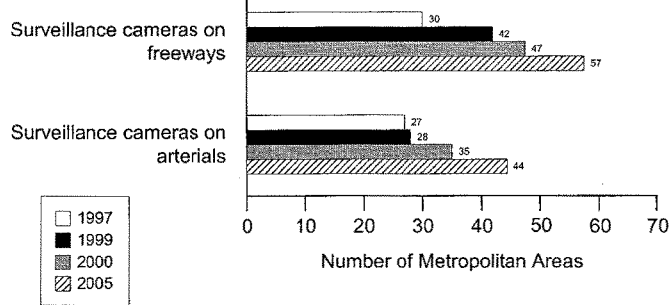

Figure 12 Incident Verification

Incident Response

Roadways are cleared and flow restored as rapidly as possible, minimizing frustration and delay to travelers while at the same time meeting the requirements and responsibilities of the agencies involved.

Figure 13 contains the number of metropolitan areas that use various incident response methods in freeways. More than half of the metropolitan areas reporting use publicly operated service patrols.

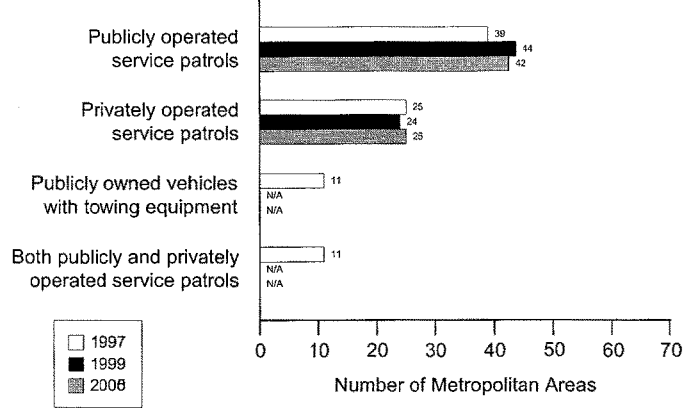

Figure 13 Incident Response on Freeways

Figure 14 contains the number of metropolitan areas that use various incident response methods in arterials. Although not widely deployed, the most commonly used method is the use of publicly operated service patrols.

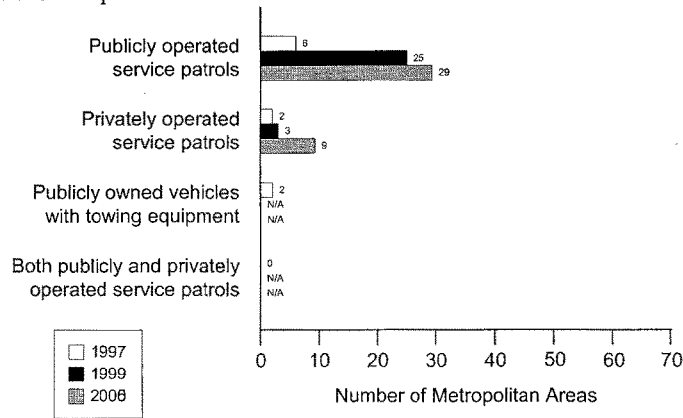

Figure 14 Incident Response on Arterials

Arterial Management

Arterial Management Functions

Arterial Management provides for the following traffic management functions:

1. Capability to monitor traffic flow conditions on arterials in real-time (i.e., traffic surveillance).
2. Capability to implement traffic signal timing patterns that are responsive to traffic flow conditions (i.e., traffic control).
3. Capability to provide critical information to travelers through infrastructure-based dissemination methods such as VMS, HAR, or IVS (i.e., information display).

The Arterial Management component indicators are shown in Figure 15.

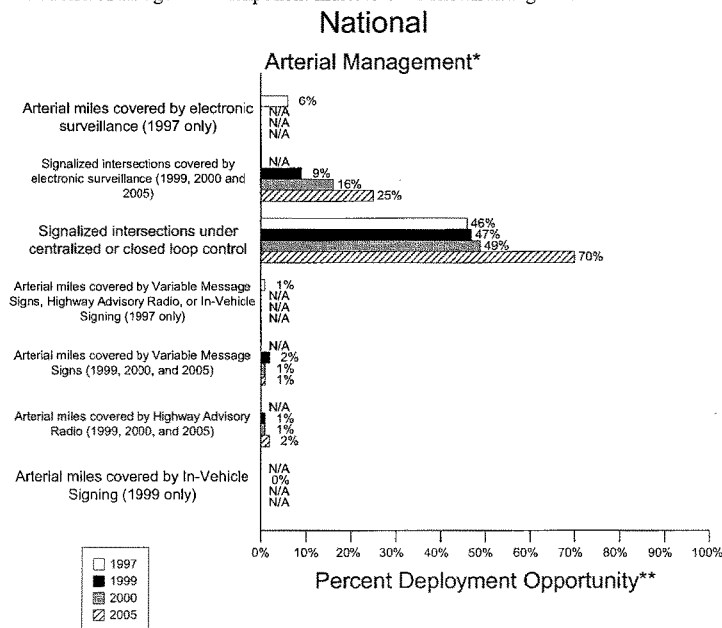

* Indicators are single surrogates that do not necessarily reflect the full breadth of ITS deployment activity.
 ** Deployment opportunity reflects potential totals that do not necessarily reflect actual need.

Figure 15 Arterial Management

Traffic Surveillance

Traffic signal control may incorporate peripheral elements that are not essential to the task of traffic control per se, but which may enhance overall traffic management capabilities in an area. These elements could include CCTV surveillance, motorist information and/or traveler information components, a database management system to support analysis and development of management strategies, and data exchange with other traffic management systems including freeway management and incident management.

Figure 16 contains the number of metropolitan areas that use electronic surveillance on arterials. More than half of the metropolitan areas reporting have signalized arterial miles with electronic surveillance for monitoring traffic flow.

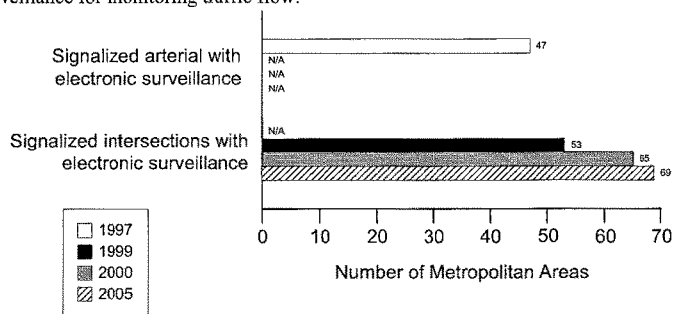

Figure 16 Traffic Surveillance

Traffic Control

Arterial Management is responsible for the coordinated control of traffic signals along urban arterials, networks, and the CBD. Arterial Management provides the capability to adjust the amount of green time for each street and coordinate operation between each signal in response to changes in demand patterns. Traffic signal timing patterns may be executed in response to pre-established "time of day" or "special event" plans, based on historical traffic conditions, or may be executed in response to real-time traffic conditions using "traffic-adaptive" algorithms. Coordination can be implemented through a number of techniques including time-based and hard-wired interconnection methods. Coordination of traffic signals across agencies requires development of data sharing and traffic signal control agreements. Therefore, a critical institutional component of Arterial Management is the establishment of formal or informal arrangements to share traffic control information as well as actual control of traffic signal operation across jurisdictions.

Figure 17 contains a summary of metropolitan areas that use various control technologies. All of the metropolitan areas that have responded report signalized arterial miles under centralized or closed loop control. The majority of the metropolitan areas reporting use closed loop control. More metropolitan areas have reported signals with preemption for emergency vehicles than priority for transit vehicles.

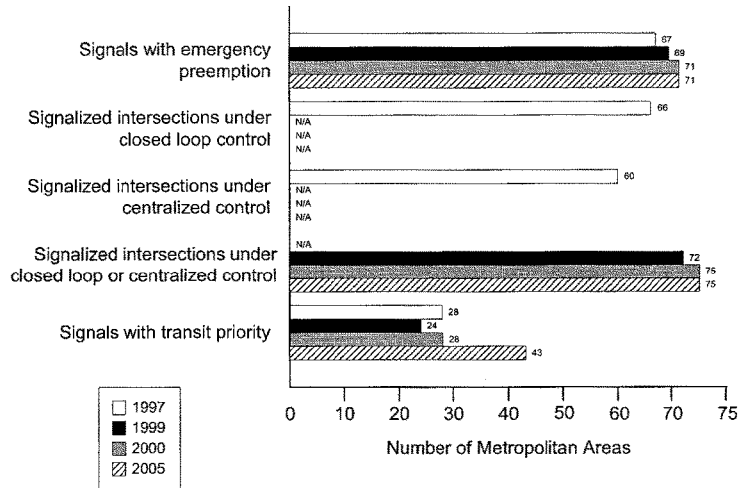

Figure 17 Traffic Control

Information Display

Information may be provided to travelers through roadside traveler information devices such as VMS and HAR.

Figure 18 contains a summary of metropolitan areas that use various display technologies. VMS is the method used most often.

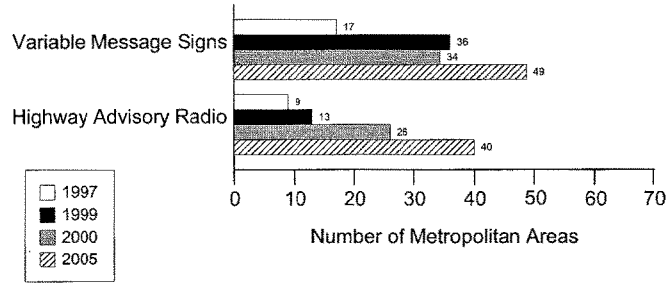

Figure 18 Information Dissemination

Electronic Toll Collection

Electronic Toll Collection Functions

Electronic Toll Collection (ETC) provides for the following traffic management function:

Automatically collect toll revenue through the application of in-vehicle, roadside, and communication technologies to process toll payment transactions (i.e., electronically collect tolls).

The Electronic Toll Collection component indicators are shown in Figure 19.

**National
Electronic Toll Collection***

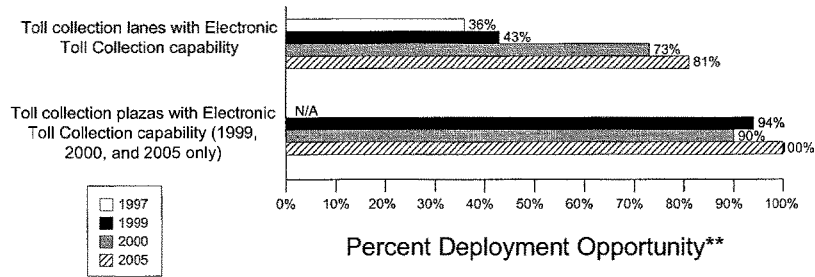

* Indicators are single surrogates that do not necessarily reflect the full breadth of ITS deployment activity.
 ** Deployment opportunity reflects potential totals that do not necessarily reflect actual need.

Figure 19 Electronic Toll Collection

Figure 20 contains the number of metropolitan areas that have toll collection lanes with ETC capability.

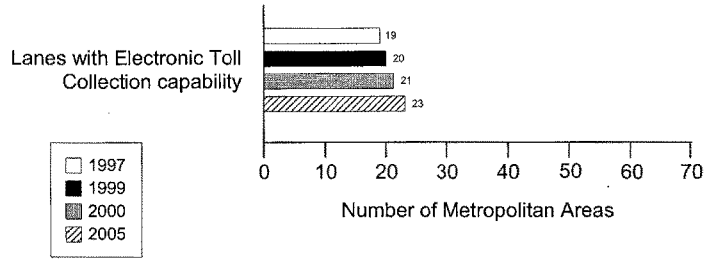

Figure 20 Lanes with ETC Capability

Electronic Fare Payment

Electronic Fare Payment Functions

Electronic Fare Payment (EFP) provides for the following fare payment functions:

1. Capability to pay public transit fares on fixed-route bus and light-rail transit vehicles using EFP media.
2. Capability to pay public transit fares at heavy-rail transit stations using EFP media.

Electronic Fare Payment Component Indicators

The Electronic Fare Payment component indicators are shown in Figure 21.

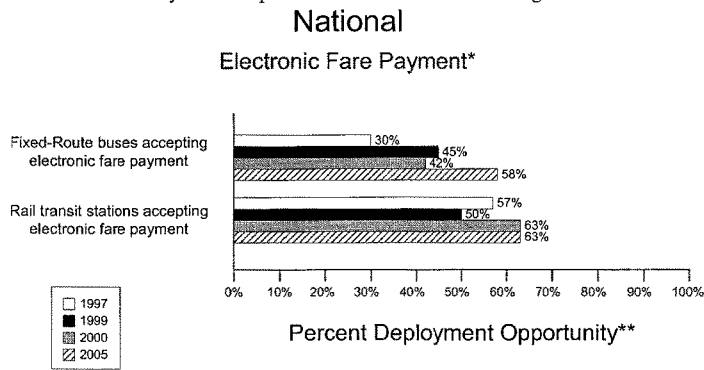

* Indicators are single surrogates that do not necessarily reflect the full breadth of ITS deployment activity.
 ** Deployment opportunity reflects potential totals that do not necessarily reflect actual need.

Figure 21 Electronic Fare Payment

Figure 22 contains the number of metropolitan areas that use EFP media for fixed-route bus services. Only five metropolitan areas use smart cards.

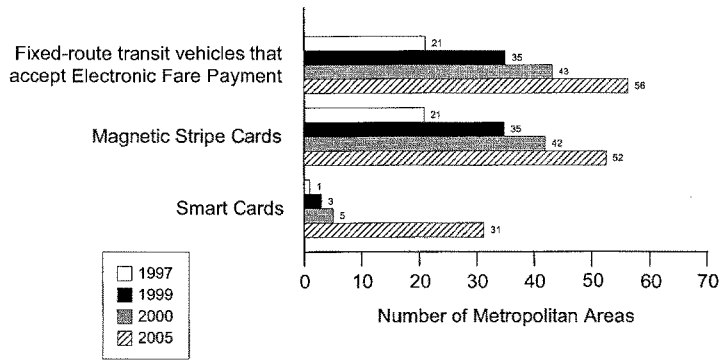

Figure 22 Vehicles with EFP

Figure 23 contains the number of metropolitan areas that use EFP for heavy-rail.

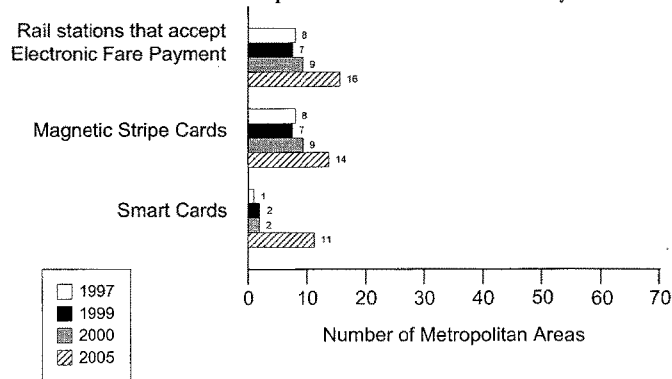

Figure 23 Rail Stations with EFP

Transit Management

Transit Management Functions

Transit Management provides for the following functions:

1. Capability to monitor the location of transit vehicles to support schedule management and emergency response (i.e., Automatic Vehicle Location [AVL]).
2. Capability to monitor maintenance status of the transit vehicle fleet (i.e., vehicle maintenance monitoring).
3. Capability to provide demand responsive flexible routing and scheduling of transit vehicles (i.e., paratransit management).
4. Capability to provide real-time, accurate transit information to travelers (i.e., information display).

The Transit Management component indicators are shown in Figure 24.

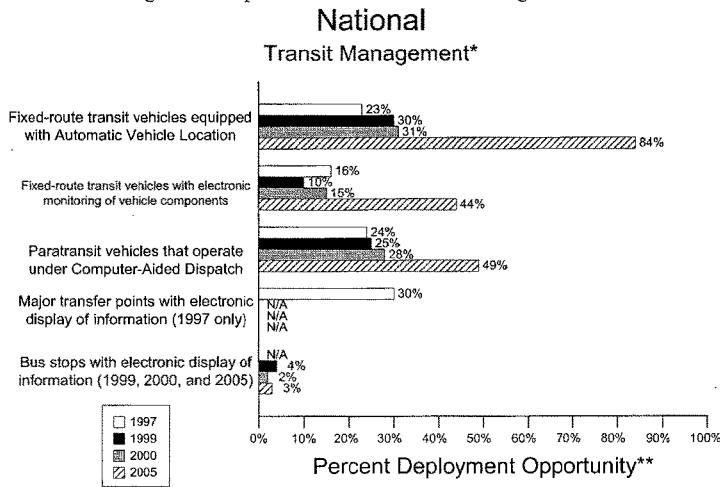

* Indicators are single surrogates that do not necessarily reflect the full breadth of ITS deployment activity.
 ** Deployment opportunity reflects potential totals that do not necessarily reflect actual need.

Figure 24 Transit Management

Automatic Vehicle Location

Transit Management supports management of the transit fleet by electronically monitoring vehicle locations in real-time. Transit vehicles equipped with AVL technology provide the basis for vehicle tracking. Information on the current location of a transit vehicle is transmitted to a centralized dispatcher who then compares the actual location with the scheduled location. Depending on the variance between the actual and scheduled locations, actions may be taken to improve schedule adherence and to transfer information to travelers. This also supports emergency response by providing real-time information on vehicle locations in emergency situations.

Vehicle Maintenance Monitoring

Transit Management includes electronic monitoring of vehicle performance parameters using in-vehicle sensors. This involves monitoring of usage statistics such as mileage and status of routine scheduled maintenance. In addition, this permits automatic monitoring of vehicle conditions including key parameters such as oil and fuels levels and tire pressure.

Paratransit Vehicle Dispatching

The use of AVL also supports advanced demand-responsive computer-aided routing and scheduling. Transit dispatchers can combine real-time information on vehicle location and status with advanced CAD systems to provide optimal vehicle assignment and routing to meet non-recurring public transportation demand.

Figure 25 contains the number of metropolitan areas reporting the use of AVL on fixed-route services, the use of electronic vehicle maintenance monitoring systems, and the use of a CAD system for demand-responsive vehicle dispatching.

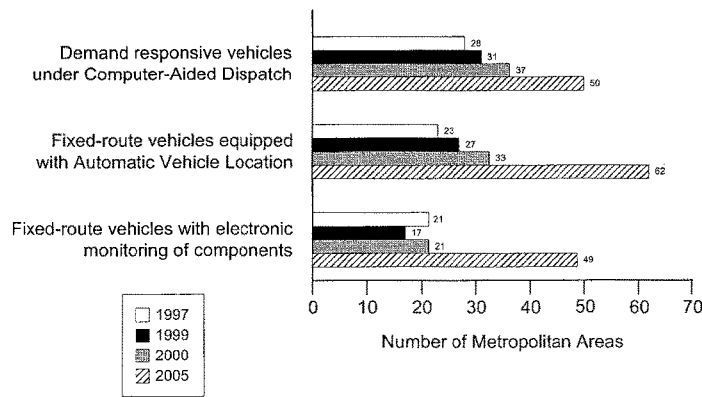

Figure 25 Transit Management Technologies

Highway-Rail Intersection

Highway-Rail Intersection (HRI) Functions

Highway-Rail Intersection provides for the following function:

Electronically monitor Highway-Rail Intersections to: (a) coordinate rail movements with the traffic control signal systems, (b) provide travelers with advanced warning of crossing closures, and (c) improve and automate warnings at highway-rail intersections.

The Highway-Rail Intersection component indicator is shown in Figure 26.

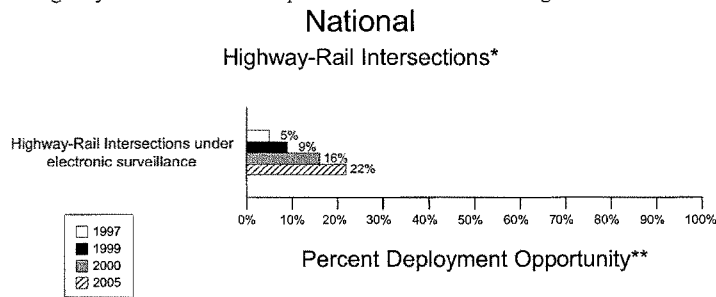

* Indicators are single surrogates that do not necessarily reflect the full breadth of ITS deployment activity.
 ** Deployment opportunity reflects potential totals that do not necessarily reflect actual need.

Figure 26 Highway-Rail Intersection

Electronic Surveillance

The at-grade highway-rail intersection is a special form of roadway intersection where a roadway and one or more railroad tracks intersect. At a Highway-Rail Intersection, the right-of-way is shared between railroad vehicles and roadway vehicles, with railroad vehicles typically being given reference. Railroad trains, which travel at high speeds and can take up to a mile or more to stop, pose special challenges. As a result, automated systems are now becoming available that allow the deployment of safety systems to adequately warn drivers of crossing hazards.

The Highway-Rail Intersection component involves electronic surveillance of grade crossings to detect vehicles within the crossing area, either through video or other means such as loop detectors. This may eventually support real-time information on train position and estimated time of arrival at a crossing and interactive coordination between roadway traffic control centers and train control centers.

Figure 27 contains the number of metropolitan areas reporting the use of video and other than video surveillance as well as electronic traffic violator devices. The purpose of the latter is to enforce crossing restrictions by identifying violators.

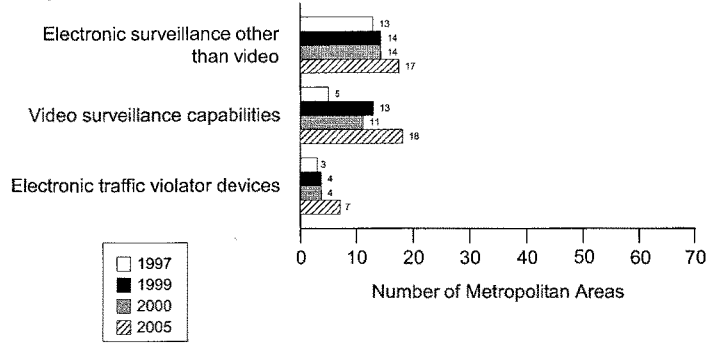

Figure 27 HRI Surveillance

Emergency Management

Emergency Management Functions

Emergency Management provides the following capabilities:

1. Capability to operate public sector emergency vehicles under CAD.
2. Capability to provide public sector emergency vehicles with in-vehicle route guidance capability.

The Emergency Management component indicators are shown in Figure 28.

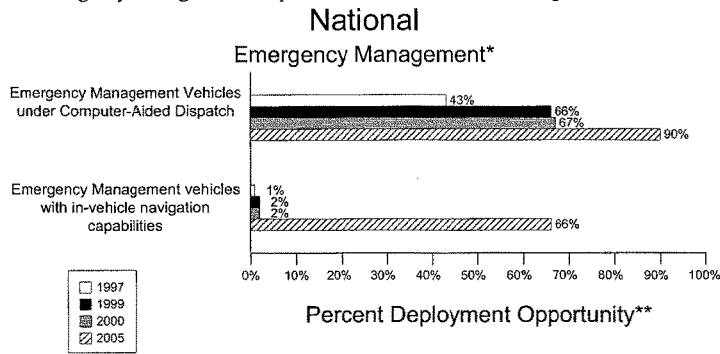

* Indicators are single surrogates that do not necessarily reflect the full breadth of ITS deployment activity.
 ** Deployment opportunity reflects potential totals that do not necessarily reflect actual need.

Figure 28 Emergency Management

Computer-Aided Dispatch

Emergency vehicle fleet management utilizes AVL equipment to provide CAD of vehicles. Through the use of real-time information on vehicle location and status, emergency service dispatchers can make optimal assignment of vehicles to incidents.

Route Guidance

The installation of route guidance equipment in emergency service vehicles provides improved directional information for drivers and improves responsiveness of emergency services.

Figure 29 contains the number of metropolitan areas with emergency management vehicles dispatch and guidance technologies.

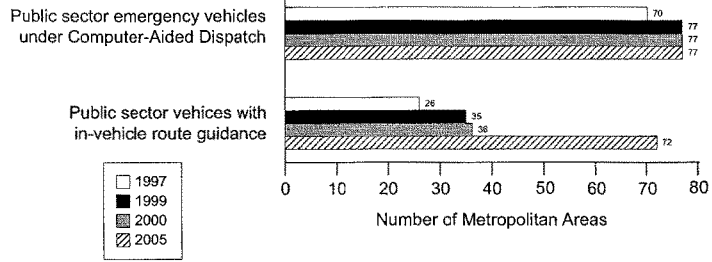

Figure 29 EMS Vehicles Technologies

Regional Multimodal Traveler Information

Regional Multimodal Traveler Information (RMTI) Functions

Regional Multimodal Traveler Information provides for the following capabilities:

1. Collect current, comprehensive, and accurate roadway and transit performance data for the metropolitan area.
2. Provide traveler information to the public via a range of communication techniques (broadcast radio, FM subcarrier, the Internet, cable TV) for presentation on a range of devices (home/office computers, television, pagers, personal digital assistants, kiosks, radio) (i.e., media).
3. Provide multimodal information to the traveler to support mode decision-making.

The Regional Multimodal Traveler Information component indicators are shown in Figure 30.

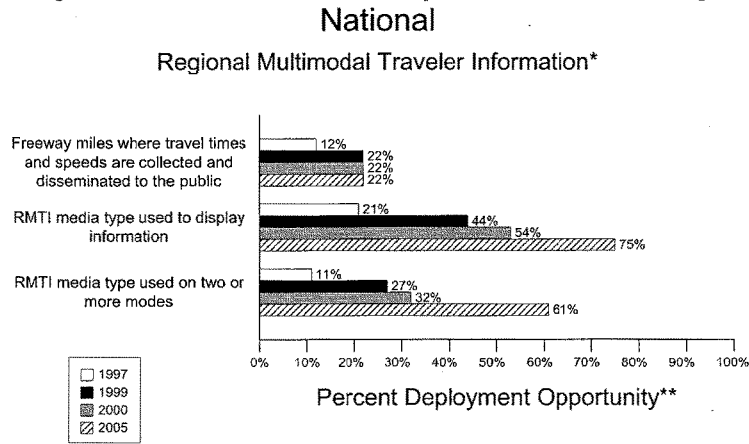

* Indicators are single surrogates that do not necessarily reflect the full breadth of ITS deployment activity.

** Deployment opportunity reflects potential totals that do not necessarily reflect actual need.

Figure 30 Regional Multimodal Traveler Information

Geographic Coverage of Traveler Information

The Regional Multimodal Traveler Information component of the metropolitan ITS infrastructure receives roadway and transit system surveillance and detection data from a variety of sources provided by both public and private sector entities. It has the capability to combine data from different sources, package the data into various formats, and provide the information to a variety of distribution channels.

Media Employed

Agencies or organizations use many methods to disseminate traveler information to the public. Indicator calculations are based on a deployment opportunity of eight media: dedicated cable TV, telephone systems, web sites, pagers, interactive TV, kiosks, e-mail, and in-vehicle navigation.

Media Displaying Information on More Than One Transportation Mode

Traveler information on more than one transportation mode may be displayed on a single medium. For example: Transit schedules and fares as well as freeway travel times, speeds, or conditions may be displayed on a Web site.

ITS Infrastructure Integration Indicator Description and FY2000 Survey Results

A critical aspect of ITS that provides much of its capability is the integration of individual components to form a unified regional traffic control system. Individual ITS components routinely collect information that is used for purposes internal to that component. For example, the Arterial Management component monitors arterial conditions to revise signal timing and to convey these conditions to travelers through such technologies as VMS and HAR. Agencies operating other ITS components can make use of this information in formulating control strategies. For example, Transit Management agencies may alter routes and schedules based on real-time information on arterial traffic conditions, and Freeway Management agencies may alter ramp metering or diversion recommendations based on the same information.

As with the component indicators, definitions for inter- and intra-component integration were developed for each component, and indicators, derived from these definitions, were produced for each. A total of 34 individual integration links were specified and are portrayed in Figure 31. Each integration link has been assigned a number and an origin/destination path from one ITS infrastructure component to another. Both inter- and intra-agency links are considered. For example, the number "10" identifies the integration of information from the Freeway Management component to the Regional Multimodal Traveler Information component. The transfer of information between traffic signal agencies is identified by link "26" that has Arterial Management as both the origin and the destination. This labeling convention is used throughout the main body of this report (Note: Four of the 32 numbered indicators have "a" and "b" indicators, making the total 34.)

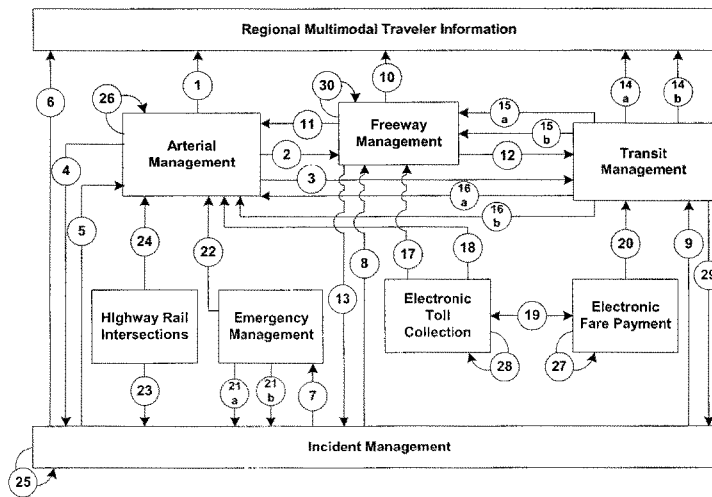

Figure 31 Integration Links

The measurement of integration associated with each of the links is agency-based. The calculation is simple and is an expression of the number of agencies that share data divided by the total number of agencies that possibly could. Therefore, for each of the integration links, a percentage integration score, ranging from zero to one hundred, is assigned. As with the deployment indicators, this rating system is based on the maximum possible integration without consideration of whether it is needed in every case.

In order to make the discussion of individual links clearer, links have been grouped into four broad categories: (1) Traffic Management Integration, (2) Traveler Information Integration, (3) Transit Management Integration, and (4) Emergency Management Integration. The integration rating is indicated by the shading in the circles associated with each link in Figures 32 to 35.

Traffic Management Integration

Traffic Management Integration enables the implementation of coordinated traffic management strategies among operating agencies responsible for Freeway Management, Incident Management, and Arterial Management within a metropolitan area. Key characteristics of Traffic Management Integration include the following:

1. Collection of real-time traffic and incident data on the freeway and arterial street network.
2. Coordination of management actions in response to changes in traffic flow.
3. Collaboration among operating agencies to optimize the strategies available to improve traffic flow.

Figure 32 presents an overview of the integration links that define Traffic Management Integration.

2000 Traffic Management National Integration Links

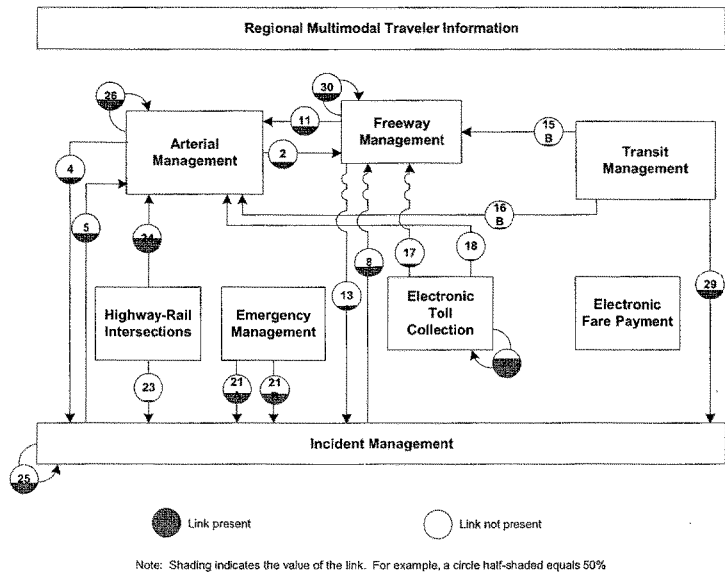

Figure 32 Traffic Management Integration Links

Table 1 presents a description of each of these links along with a summary of the survey results for each link.

Table 1 Traffic Management Integration Links

Link	From/To	Description	Survey Response
2	Arterial Management to Freeway Management	Freeway Management Center monitors arterial travel times, speeds, and conditions using data provided from Arterial Management to adjust ramp meter timing, lane control or HAR in response to changes in real-time conditions on a parallel arterial.	Traffic condition information is sent from 57 of the 396 (14%) Arterial Management agencies to a Freeway Management agency.
4	Arterial Management to Incident Management	Incident Management monitors real-time arterial travel times, speeds, and conditions using data provided from Arterial Management to detect arterial incidents and manage incident response activities.	Traffic condition information is sent from 61 of the 396 (15%) Arterial Management agencies to an Incident Management agency.
5	Incident Management to Arterial Management	Arterial Management monitors incident severity, location, and type information collected by Incident Management to adjust traffic signal timing or provide information to travelers in response to incident management activities.	Incident severity, location, and type data are sent from 34 of the 105 (32%) Incident Management agencies to an Arterial Management agency.

Link	From/To	Description	Survey Response
8	Incident Management to Freeway Management	Incident severity, location, and type data collected by Incident Management are monitored by Freeway Management for the purpose of adjusting ramp meter timing, lane control or HAR messages in response to freeway or arterial incidents.	Incident severity, location, and type data are sent from 39 of the 105 (37%) Incident Management agencies to a Freeway Management agency.
11	Freeway Management to Arterial Management	Freeway travel time, speeds, and conditions data collected by Freeway Management are used by Arterial Management to adjust arterial traffic signal timing or arterial VMS messages in response to changing freeway conditions.	Freeway travel time, speeds, and condition data are sent from 33 of the 105 (31%) Freeway Management agencies to a Arterial Management agency.
13	Freeway Management to Incident Management	Incident Management monitors freeway travel time, speed, and condition data collected by Freeway Management to detect incidents or manage incident response.	Freeway travel time, speeds, and condition data are sent from 21 of the 105 (20%) Freeway Management agencies to an Incident Management agency.
15b	Transit Management to Freeway Management (transit vehicles equipped as probes)	Transit vehicles equipped as probes are monitored by Freeway Management to determine freeway travel speeds or travel times.	Transit vehicle probe data is sent from 4 of the 220 (2%) Transit Management agencies to a Freeway Management agency.
16b	Transit Management to Arterial Management (transit vehicles equipped as probes)	Transit vehicles equipped as probes are monitored by Arterial Management to determine arterial speeds or travel times.	Transit vehicle probe data is sent from 5 of the 220 (2%) Transit Management agencies to an Arterial Management agency.

Link	From/To	Description	Survey Response
17	Electronic Toll Collection to Freeway Management (ETC-equipped vehicles as probes)	Vehicles equipped with ETC tags are monitored by Freeway Management to determine freeway travel speeds or travel times.	ETC-equipped vehicles are used as probes by 6 of the 105 (6%) Freeway Management agencies.
18	Electronic Toll Collection to Arterial Management (ETC equipped vehicles as probes)	Vehicles equipped with ETC tags are monitored by Arterial Management to determine arterial travel speeds or travel times.	ETC equipped vehicles are used as probes by 3 of the 396 (1%) Arterial Management agencies.
21a	Emergency Management to Incident Management (Incident location, severity, and type)	Incident Management is notified of incident location, severity, and type by Emergency Management to identify incidents on freeways or arterials.	Emergency Management agencies provide notification of incident location, severity, and type to 29 of the 105 (28%) Incident Management agencies.
21b	Emergency Management to Incident Management (Incident clearance activities)	Incident Management is notified of incident clearance activities by Emergency Management to manage incident response on freeways or arterials.	Emergency Management agencies provide notification of incident clearance to 37 of the 105 (35%) Incident Management agencies.
23	Highway-Rail Intersections to Incident Management	Incident Management is notified of crossing blockages by Highway-Rail Intersection to manage incident response.	Highway-Rail crossing blockage data are provided to 15 of the 396 (4%) Arterial Incident Management agencies (Arterial Management agencies).
24	Highway-Rail Intersections to Arterial Management	Highway-Rail Intersection and Arterial Management are interconnected for the purpose of adjusting traffic signal timing in response to train crossing.	203 of the 396 (51%) Arterial Management Agencies have signals that adjust timing in response to train crossing.

Link	From/To	Description	Survey Response
25	Incident Management intra-component	Agencies participating in formal working agreements or Incident Management plans coordinate incident detection, verification, and response.	336 of the 898 (37%) Emergency Management agencies participate in a formal Incident Management program.
26	Arterial Management intra-component	Agencies operating traffic signals along common corridors sharing information and possibly control of traffic signals to maintain progression on arterial routes.	123 of the 396 (31%) Arterial Management agencies share data with another Arterial Management agency.
28	Electronic Toll Collection intra-component	ETC agencies share a common toll tag for the purpose of facilitating "seamless" toll transactions.	42 of the 64 (66%) Toll Collection agencies use a common toll tag.
29	Transit Management to Incident Management	Transit agencies notify Incident Management agencies of incident locations, severity, and type.	Incident information is provided by 54 of the 220 (25%) Transit Management agencies to an Incident Management agency.
30	Freeway Management intra-component	Agencies operating freeways within the same region share freeway travel time, speeds, and condition data.	35 of the 105 (33%) Freeway Management agencies send data to another Freeway Management agency.

Traveler Information Integration

The collection, processing, and distribution of timely information related to the performance of the transportation system is a by-product of integrating selected metropolitan ITS components. Information gathered by Freeway Management, Incident Management, Arterial Management, and Transit Management components is fused to create a region-wide traveler information database. Information in the database is then transferred to various media for display to travelers. Travelers receiving this information can make better-informed decisions regarding if, when, where, and how to travel, which may lead to an increase in travel efficiency and a reduction in travel congestion and delay. Figure 33 presents an overview of the integration links that define Traveler Information Integration.

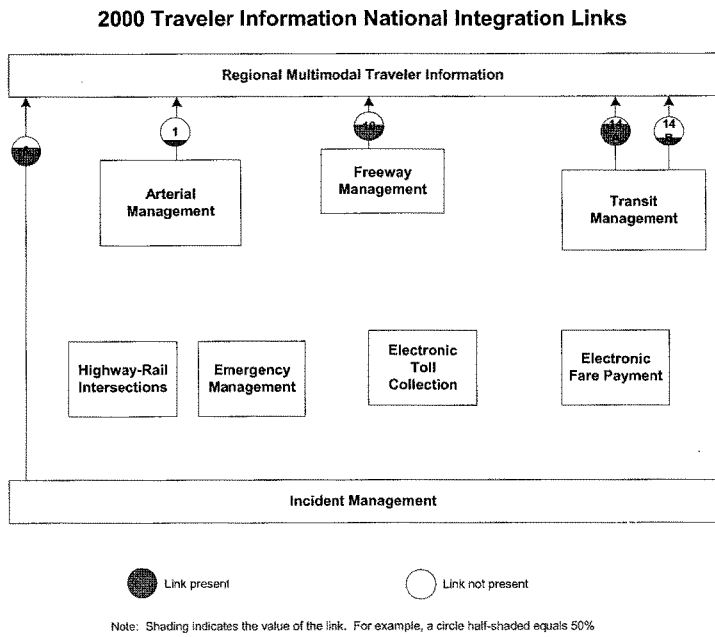

Figure 33 Traveler Information Integration Links

Table 2 presents a description of each of these links along with a summary of the survey results for each link.

Table 2 Traveler Information Integration Links

Link	From/To	Description	Survey Response
1	Arterial Management to Regional Multimodal Traveler Information	Arterial travel time, speed, and condition information are displayed by Regional Multimodal Traveler Information media.	Arterial travel time, speed, and condition information are displayed by Regional Multimodal Traveler Information media for 82 of the 396 (21%) of the Arterial Management agencies.
6	Incident Management to Regional Multimodal Traveler Information	Incident location, severity, and type information are displayed by Regional Multimodal Traveler Information media.	Incident location, severity, and type information are displayed by Regional Multimodal Traveler Information media for 61 of the 105 (58%) Incident Management agencies.
10	Freeway Management to Regional Multimodal Traveler Information	Freeway travel time, speed, and condition information are displayed by Regional Multimodal Traveler Information media.	Freeway travel time, speed, and condition information are displayed by Regional Multimodal Traveler Information media for 59 of the 105 (56%) Freeway Management agencies.
14a	Transit Management to Regional Multimodal Traveler Information (transit routes, schedules, and fares)	Transit routes, schedules, and fare information are displayed on Regional Multimodal Traveler Information media.	Transit routes, schedules, and fare information are displayed on Regional Multimodal Traveler Information media for 167 of the 220 (76%) Transit Management agencies.
14b	Transit Management to Regional Multimodal Traveler Information (schedule adherence)	Transit schedule adherence information is displayed on Regional Multimodal Traveler Information media.	Transit schedule adherence information is displayed on Regional Multimodal Traveler Information media for 50 of the 220 (22%) Transit Management agencies.

Transit Management Integration

Transit Management Integration provides public transit operators with information and control capabilities to better manage transit system on-time performance. Transit Management Integration also exploits the use of EFP media to improve the efficiency of route planning and financial management. Figure 34 presents an overview of the integration links that define Transit Management Integration.

2000 Transit Management National Integration Links

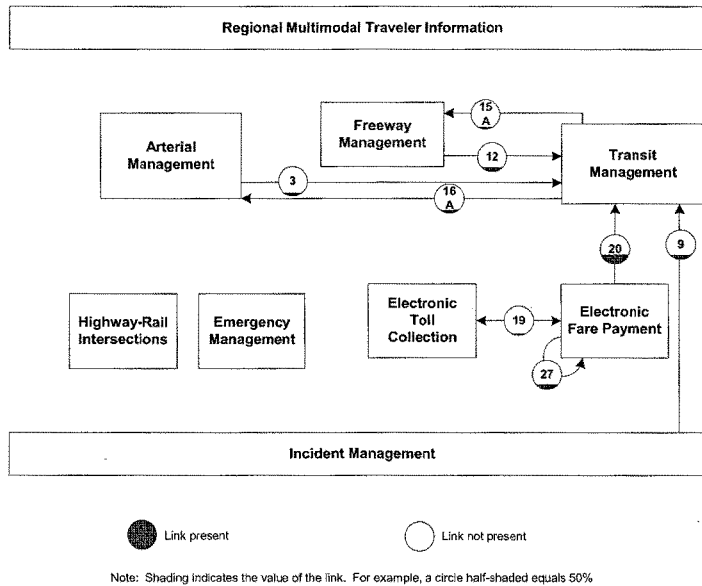

Figure 34 Transit Management Integration Links

Table 3 presents a description of each of these links along with a summary of the survey results for each link.

Table 3 Transit Management Integration Links

Link	From/To	Description	Survey Response
3	Arterial Management to Transit Management	Transit Management adjusts transit routes and schedules in response to arterial travel times, speeds, and conditions information collected as part of Arterial Management.	Traffic condition information is sent from 39 of the 396 (10%) Arterial Management agencies to a Transit Management agency.
9	Incident Management to Transit Management	Transit Management adjusts transit routes and schedules in response to incident severity, location, and type data collected as part of Incident Management.	Incident severity, location, and type data are sent from 15 of the 105 (14%) Incident Management agencies to a Transit Management agency.
12	Freeway Management to Transit Management	Transit Management adjusts transit routes and schedules in response to freeway travel times, speeds, and conditions information collected as part of Freeway Management.	Freeway travel time, speeds, and condition data are sent from 15 of the 105 (14%) Freeway Management agencies to a Transit Management agency.
15a	Transit Management to Freeway Management (ramp meter priority)	Freeway ramp meters are adjusted in response to receipt of transit vehicle priority signal.	Transit vehicle receives ramp meter priority for 5 of the 220 (2%) Transit Management agencies.
16a	Transit Management to Arterial Management (traffic signal priority)	Traffic signals are adjusted in response to receipt of transit vehicle priority signal.	Transit vehicle receives traffic signal priority for 18 of the 220 (8%) Transit Management agencies.
19	Electronic Toll Collection to Electronic Fare Payment	Transit operators accept ETC-issued tags to pay for transit fares.	2 of the 220 (1%) Transit Management agencies accept ETC tags for payment of transit fares.
20	Electronic Fare Payment to Transit Management	Rider ship details collected as part of EFP are used in transit service planning by Transit Management.	EFP data are used by 71 of the 220 (32%) Transit Management agencies.

Link	From/To	Description	Survey Response
27	Electronic Fare Payment intra-component	Operators of different public transit services share common EFP media.	35 of the 220 (16%) Transit Management agencies have a common fare media that can be used on more than one transit service (within that transit operator or with another transit operator).

Emergency Response Integration

Emergency Response Integration increases emergency response capabilities through improved incident notification from Incident Management and traffic signal preemption provided by Arterial Management. Figure 35 presents an overview of the integration links that define Emergency Response Integration.

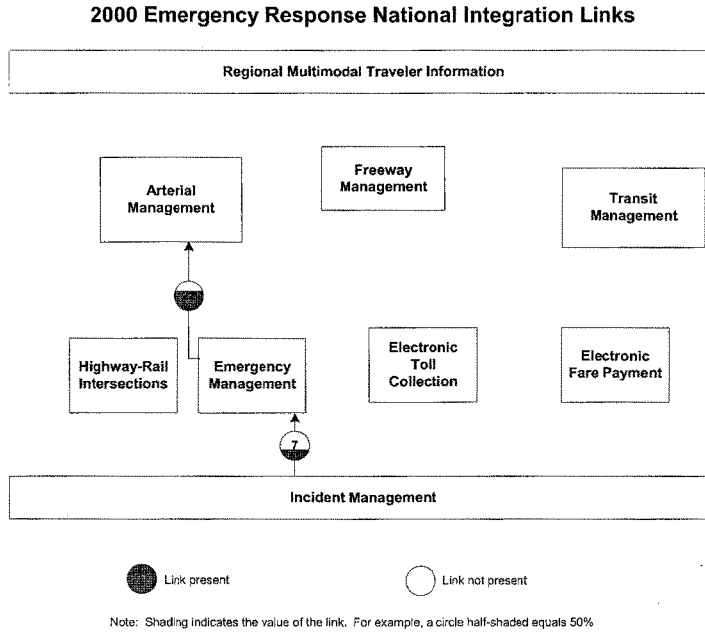

Figure 35 Emergency Response Integration Links

Table 4 presents a description of each of these links along with a summary of the survey results for each link.

Table 4 Emergency Response Integration Links

Link	From/To	Description	Survey Response
7	Incident Management to Emergency Management	Incident severity, location, and type data collected as part of Incident Management are used to notify Emergency Management for incident response.	Incident severity, location, and type data are sent from 35 of the 105 (33%) Incident Management agencies to an Emergency Management agency.
22	Emergency Management to Arterial Management	Emergency Management vehicles are equipped with traffic signal priority capability.	Emergency response vehicles receive traffic signal priority for 215 of the 898 (24%) Emergency Management agencies.

Deployment Goal Setting

Background

A set of deployment threshold values was identified and applied across all metropolitan areas in order to categorize each metropolitan area into one of three levels of deployment: High, Medium, or Low. These threshold values were established in a way that allowed demarcation of meaningful progress toward an achievable 10-year goal, while still maintaining some requirement for "stretching" to reach the goal.

The assignment of a single integrated deployment rating for each metropolitan area was accomplished using a three-step process. First, the current level of deployment of the ITS infrastructure components at each metropolitan area was determined. These data were compared to an established threshold level for each component to determine a deployment rating. Next, an integration rating was assigned to each area based on the degree to which infrastructure components are integrated. Finally, the resulting ratings for deployment and integration were combined into a single overall integrated deployment rating.

Crossing a threshold value for either deployment or integration means that a metropolitan area has made a significant commitment to deploy and integrate the metropolitan ITS infrastructure. However, it does not mean that deployment or integration is complete. Figure 36 shows that, even in the high level of deployment, a metropolitan area may still have "miles to go" in completing full deployment. A significant level of investment of time and money is needed to organize and perform initial planning for metropolitan areas categorized as low, in order to build deployment momentum. Metropolitan areas in the medium stage are moving rapidly toward full deployment through leveraging the important initial investments in ITS infrastructure. Metropolitan areas in the high category are beginning to experience still higher rates of return on investment in ITS; however, they still need continued investment to bring them up to complete deployment. New systems are being added to an already robust infrastructure, and integration is multiplying the impact of deployments, producing more "bang for the buck." All this adds up to a solid and expanding base for deploying the integrated infrastructure, but only with a sustained commitment of time and resources.

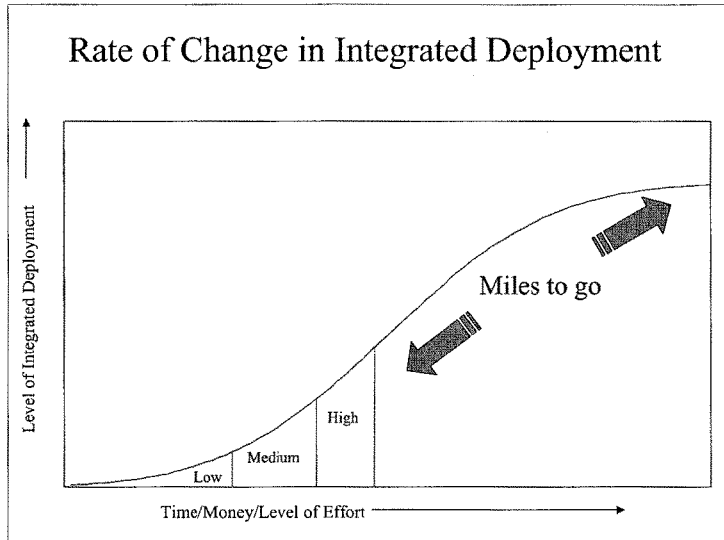

Figure 36 Rate of Change in Integrated Deployment

2000 Status of Integrated Deployment

As shown in Figure 37, a total of 23 metropolitan areas are categorized as low, 28 as medium, and 24 as high in 2000. This can be contrasted with 1999 where 26 areas were characterized as low, 27 as medium, and 22 as high. The information suggests that considerable progress has been made in the deployment of integrated ITS over the last year.

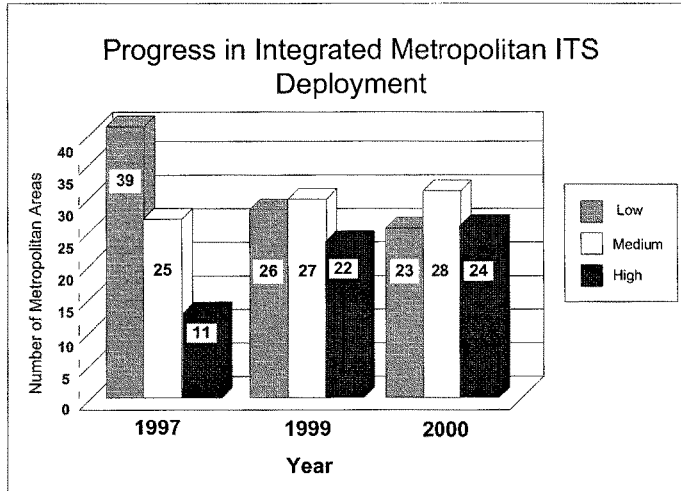

Figure 37 Progress in Integrated Metropolitan ITS Deployment

Table 5 lists the 75 metropolitan areas and their respective level of integrated deployment for 1997, 1999, and 2000. Areas with a high level of integrated deployment in 2000 are listed at the top of the table, followed by areas with a medium level of integrated deployment, and finally areas with a low level of integrated deployment. A total of 3 areas moved from a low to medium level of integrated deployment from 1999 to 2000. The methodology used to prepare these ratings combines information concerning deployment and integration into a single integrated deployment measure.

Table 5 Metropolitan Level of Integrated Deployment

Metropolitan Area	1997 Integrated- Deployment Level	1999 Integrated- Deployment Level	2000 Integrated- Deployment Level
Atlanta	High	High	High
Baltimore	Med	High	High
Charlotte, Gastonia, Rock Hill	Med	High	High
Chicago, Gary, Lake County	Med	High	High
Cincinnati, Hamilton	High	High	High
Dallas, Fort Worth	Med	High	High
Detroit, Ann Arbor	Med	High	High

Metropolitan Area	1997 Integrated- Deployment Level	1999 Integrated- Deployment Level	2000 Integrated- Deployment Level
Greensboro, Winston-Salem, High Point	Low	High	High
Houston, Galveston, Brazoria	High	High	High
Jacksonville	Med	Med	High
Los Angeles, Anaheim, Riverside	High	High	High
Miami, Fort Lauderdale	Med	Med	High
Milwaukee, Racine	Med	High	High
Minneapolis, St. Paul	High	High	High
New York, Northern New Jersey, Southwestern Connecticut	High	High	High
Orlando	Med	High	High
Philadelphia, Wilmington, Trenton	Med	High	High
Phoenix	High	High	High
Portland, Vancouver	High	High	High
San Antonio	Med	High	High
San Diego	High	High	High
San Francisco, Oakland, San Jose	Med	High	High
Seattle, Tacoma	High	High	High
Washington	High	High	High
Albany, Schenectady, Troy	Low	Med	Med
Allentown, Bethlehem, Easton	Med	Med	Med
Austin	Med	Med	Med
Baton Rouge	Low	Low	Med
Boston, Lawrence, Salem	Med	Med	Med
Birmingham	Low	Low	Med
Buffalo, Niagara Falls	Med	Med	Med
Cleveland, Akron, Lorain	Med	Med	Med
Denver, Boulder	Med	Med	Med
Hampton Roads	Med	Med	Med
Harrisburg, Lebanon, Carlisle	Low	Med	Med
Hartford, New Britain, Middletown	Low	Med	Med
Kansas City	Low	Low	Med
Memphis	Med	Med	Med
New Haven, Meriden	Med	Med	Med
New Orleans	Low	Med	Med
Pittsburgh, Beaver Valley	Med	Med	Med
Raleigh-Durham	Med	Med	Med
Richmond, Petersburg	Low	Med	Med
Rochester	Med	Med	Med
Sacramento	Med	Med	Med
Salt Lake City, Ogden	Low	Med	Med
Scranton, Wilkes-Barre	Low	Med	Med

Metropolitan Area	1997 Integrated- Deployment Level	1999 Integrated- Deployment Level	2000 Integrated- Deployment Level
St. Louis	Low	Med	Med
Tampa, St. Petersburg, Clearwater	Low	Med	Med
Tucson	Low	Med	Med
West Palm Beach, Boca Raton, Delray	Low	Med	Med
Providence, Pawtucket, Fall River	Low	Med	Med
Bakersfield	Low	Low	Low
Charleston	Low	Low	Low
Columbus	Low	Low	Low
Dayton, Springfield	Low	Low	Low
El Paso	Low	Low	Low
Fresno	Low	Low	Low
Grand Rapids	Low	Low	Low
Greenville, Spartanburg	Low	Low	Low
Honolulu	Low	Low	Low
Indianapolis	Low	Low	Low
Knoxville	Low	Low	Low
Las Vegas	Low	Low	Low
Little Rock, North Little Rock	Low	Low	Low
Louisville	Low	Low	Low
Nashville	Low	Low	Low
Oklahoma City	Low	Low	Low
Omaha	Low	Low	Low
Springfield	Low	Low	Low
Syracuse	Low	Low	Low
Toledo	Low	Low	Low
Tulsa	Low	Low	Low
Wichita	Low	Low	Low
Youngstown, Warren	Low	Low	Low

Tracking Integrated Deployment Progress

The measurement of progress for 2000 can be set in a context of yearly goals leading to successful achievement of the former Secretary's 2006 integrated deployment goal. Figure 38 portrays the level of integrated deployment measured in 1997, 1999, and 2000 along with goals for deployment for each year through 2005. No data were collected in 1998; therefore, only the goal levels of integrated deployment are shown for 1998. This figure shows that as of 2000, nationwide integrated deployment is advancing at a rate compatible with the achievement of the former Secretary's year 2005 goal. The data contained in this figure indicate that all 75 metropolitan areas should be moved out of the low category into either a high or medium level of deployment by 2006.

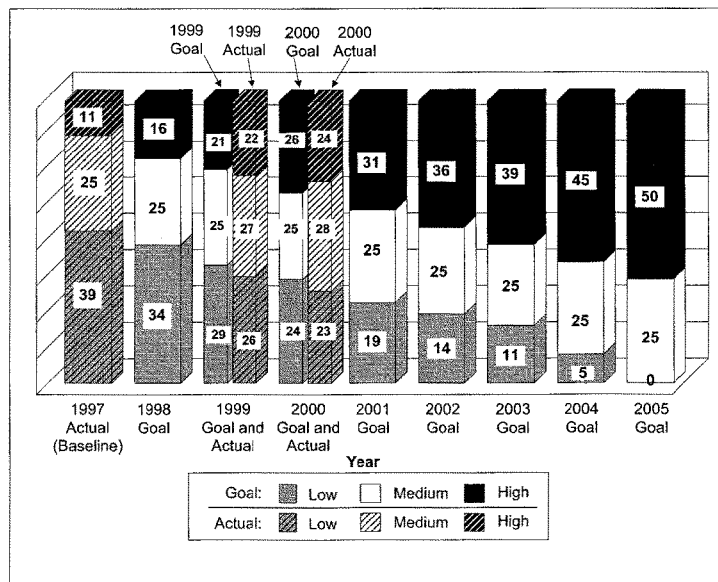

Figure 38 Level of Integrated Deployment (Actual and Goal)

Appendix A

Metropolitan Area	State	1997 Survey Return Rate	1999 Survey Return Rate	2000 Survey Return Rate
Albany-Schenectady-Troy	NY	94%	95%	95%
Albuquerque	NM	25%	70%	90%
Allentown-Bethlehem-Easton	PA	60%	100%	91%
Atlanta	GA	82%	96%	94%
Austin-San Marcos	TX	100%	92%	91%
Bakersfield	CA	36%	100%	75%
Baltimore	MD	68%	89%	100%
Baton Rouge	LA	100%	93%	100%
Birmingham	AL	58%	70%	100%
Boston-Worcester-Lawrence	MA	71%	76%	80%
Buffalo-Niagara Falls	NY	92%	100%	93%
Charleston- North Charleston	SC	68%	80%	80%
Charlotte-Gastonia-Rock Hill	NC	100%	100%	100%
Chicago-Gary-Kenosha	IL	95%	90%	95%
Cincinnati-Hamilton	OH	61%	91%	91%
Cleveland-Akron	OH	85%	84%	97%
Columbus	OH	100%	100%	100%
Dallas-Ft Worth	TX	91%	93%	94%
Dayton-Springfield	OH	66%	88%	93%
Denver-Boulder-Greeley	CO	63%	92%	88%
Detroit-Ann Arbor-Flint	MI	89%	86%	98%
El Paso	TX	86%	75%	87%
Fresno	CA	45%	89%	77%
Grand Rapids-Muskegon-Holland	MI	90%	81%	100%
Greensboro-Winston Salem-High Point	NC	92%	97%	100%
Greenville-Spartanburg-Anderson	SC	80%	100%	95%
Hampton Roads	VA	94%	91%	96%
Harrisburg-Lebanon-Carlisle	PA	60%	88%	100%
Hartford	CT	92%	86%	90%
Honolulu	HI	56%	83%	83%
Houston-Galveston-Brazoria	TX	87%	63%	56%
Indianapolis	IN	79%	100%	100%
Jacksonville	FL	95%	100%	100%
Kansas City	MO	82%	79%	100%
Knoxville	TN	78%	92%	91%
Las Vegas	NV	100%	100%	100%
Little Rock-North Little Rock	AR	100%	100%	100%
Los Angeles-Riverside-Orange County	CA	79%	84%	92%
Louisville	KY	91%	94%	100%

Metropolitan Area	State	1997 Survey Return Rate	1999 Survey Return Rate	2000 Survey Return Rate
Memphis	TN	100%	91%	80%
Miami-Ft Lauderdale	FL	100%	77%	92%
Milwaukee-Racine	WI	96%	89%	93%
Minneapolis-St. Paul	MN	73%	84%	93%
Nashville	TN	100%	75%	100%
New Haven	CT	90%	80%	86%
New Orleans	LA	83%	72%	84%
New York-Northern New Jersey-Southwestern Connecticut	NY	61%	77%	91%
Oklahoma City	OK	83%	88%	82%
Omaha	NE	95%	86%	92%
Orlando	FL	100%	94%	100%
Philadelphia-Wilmington-Atlantic City	NJ	62%	77%	87%
Phoenix-Mesa	AZ	96%	94%	88%
Pittsburgh	PA	73%	100%	93%
Portland-Salem	OR	78%	79%	95%
Providence-Fall River-Warwick	RI	66%	76%	83%
Raleigh-Durham-Chapel Hill	NC	80%	82%	100%
Richmond-Petersburg	VA	65%	75%	84%
Rochester	NY	100%	80%	84%
Sacramento	CA	71%	89%	100%
Salt Lake City-Ogden	UT	90%	86%	90%
San Antonio	TX	100%	63%	42%
San Diego	CA	65%	88%	86%
San Francisco-Oakland-San Jose	CA	83%	90%	89%
San Juan	PR	56%	33%	33%
Sarasota-Bradenton	FL	100%	100%	91%
Scranton-Wilkes Barre-Hazleton	PA	81%	73%	54%
Seattle-Tacoma-Bremerton	WA	90%	89%	85%
Springfield	MA	67%	54%	90%
St. Louis	MO	79%	83%	72%
Syracuse	NY	87%	90%	70%
Tampa-St. Petersburg-Clearwater	FL	94%	95%	100%
Toledo	OH	88%	84%	89%
Tucson	AZ	100%	100%	100%
Tulsa	OK	95%	81%	78%
Washington	DC	82%	89%	94%
West Palm Beach-Boca Raton	FL	94%	92%	100%
Wichita	KS	100%	100%	100%
Youngstown-Warren	OH	74%	81%	81%

Appendix B

References

"Building the ITI: Putting the National Architecture into Action," Federal Highway Administration, FHWA-JPO-96-011, April 1996 (ITS Electronic Document Library document number 415).

Highway Performance Monitor Guide Field Manual," United States Department of Transportation, Federal Highway Administration, August 1993.

"Intelligent Transportation Systems: The National Architecture, A Framework for Integrated Transportation into the 21st Century" (Publication Number: FHWA-JPO-96-012) (ITS Electronic Document Library document number 4847).

"Measuring ITS Deployment and Integration," Oak Ridge National Laboratory, August 1998 (ITS Electronic Document Library document number 4372).

"National Transit Database," U.S. DOT/Federal Transit Administration (FTA). Federal Transit Administration, Washington, 1995.

"1990 Census of Population and Housing," U.S. Department of Commerce, U.S. Bureau of The Census, 1993.

RESPONSES FROM LAWRENCE YERMACK TO ADDITIONAL QUESTIONS FROM
SENATOR REID

Question 1. You mention in your testimony that 55 of our largest metropolitan areas have begun significant deployment of ITS. You also have set a goal that all 75 of these metropolitan areas have a medium to high level of deployment by 2006. Can you explain what you mean by a “medium to high level of deployment?”

Response. In order to monitor progress toward this goal (and more generally monitor progress in Intelligent Transportation Systems (ITS) deployment), the Department of Transportation has been tracking deployment of five specific ITS components as well as their integration in the 78 largest metropolitan areas. The specific components the Department has been tracking are (1) freeway management or incident management systems; (2) transit management or electronic fare payment systems; (3) arterial management systems; (4) regional multi-modal traveler information systems, and (5) emergency management systems. These components were identified as best representing the critical components of a comprehensive urban ITS deployment.

For each component, the Department is tracking its level of deployment in each of these metropolitan areas using one or more indicators and have established a threshold value for each indicator. When certain indicators reach the threshold level, that metropolitan area is considered to have achieved a medium level of deployment. An area is considered “high” when it achieves the threshold value for at least one indicator for each component (i.e., each of the five components we are tracking are deployed to some minimal level in that area.)

It should be noted that achieving these medium and high thresholds only indicates that the metropolitan area has made a significant commitment to ITS across a number of critical components. It should not be interpreted to mean that the metropolitan area has fully deployed ITS with a particular component or across all components. For example, the indicator used for arterial management systems is the percentage of signalized intersections in a metropolitan area under computerized control. A jurisdiction that has more than one-third of their signals under computerized control would be considered above the threshold in that area. While this clearly demonstrates a commitment to deploying ITS on their arterial roadways, it does not mean that all signals within that jurisdiction that should be under computerized control are all computerized.

Question 2. What will it take for you to meet this goal? What are the biggest barriers to widespread ITS deployment?

Response. While the Department believes it is on track to meet this goal, we must recognize that this is only the first step toward the full deployment of ITS nationwide. At the current pace, most, if not all of the largest metropolitan areas will have achieved a medium to high level of deployment by 2006. While this measure indicates that these jurisdictions will have made a significant commitment to ITS, it also means that without more aggressive actions it will be many more years before widespread deployment is attained.

The biggest barriers to widespread ITS deployment are:

(1) *The lack of full knowledge of the real-time conditions on the surface transportation system.* For ITS to fulfill its promise of operating the surface transportation system at the highest level of efficiency requires the availability of realtime traffic, transit, and roadway weather information. Today, less than 25 percent of the National Highway System is sufficiently instrumented to provide this information. If ITS is to be used to improve the management of incidents, reduce delays through work zones, adapt to changing weather conditions, and respond in emergency situations, we need to deploy the necessary sensors, cameras, and communication systems to provide this critical data.

(2) *The lack of an institution to both champion and be accountable for the operation of the surface transportation system.* Existing transportation institutions were largely created to build the transportation system. Deployment of ITS enables and enhances the operation of the system. There is no existing institution in a metropolitan area that has responsibility and accountability for the operation of the system. There needs to be a mechanism to bring the key players to the table, including non-traditional transportation partners such as police, fire, emergency management service, towing service operators, parking operators, etc., to develop and implement a regional operations plan.

(3) *The lack of investment in ITS deployment and operations.* Given the significant infrastructure needs that exist, it is difficult for ITS and operations projects to compete for funding. Acceleration of ITS deployment will require stronger support for efforts that increase road efficiency through intelligent transportation systems.

Question 3. How would you define full deployment? Are there any metropolitan areas that you would consider to be close to fully deployed?

Response. The Department has begun to develop a set of minimum requirements for a fully functional surface transportation “infrastructure.” That work, which is not complete, will give us a good part of the definition requested. In the meantime, insight into the extent of deployment in leading metropolitan areas can be drawn from our recent efforts to implement a mobility monitoring program. The goal of this program is to identify cities with the highest levels of instrumented freeways that could be used to develop measures of mobility—travel time and its reliability. The ten cities that participated in this effort were Atlanta; Cincinnati; Detroit; Hampton Roads, Virginia; Houston; Los Angeles; Minneapolis-St. Paul; Phoenix; San Antonio; and Seattle. Even in these leading cities the level of instrumentation is highly variable ranging from 13 percent in the lowest city to 63 percent in the highest city. This clearly demonstrates the need for a more aggressive approach to the deployment of surveillance and detection capability. Based on this analysis and our knowledge of other ITS deployments, we believe the cities closest to full deployment are Houston, Los Angeles, Minneapolis-St. Paul, Phoenix, and Seattle.

Question 4. I would appreciate it if you would provide further information in writing regarding the level of deployment in each of these 75 metropolitan areas.

Response. We have attached the fiscal year 2000 Report on our survey results of the 78 largest metropolitan areas. Included in that report, on pages 49-51, is a table tracking the deployment levels of each city in 1998, 1999 and 2000.

Question 5. Last year the Federal Communications Commission approved “511” as a nationwide telephone number for traveler information. What is the Department’s timeframe for implementing this number? How many areas of the country have sufficient ITS infrastructure in place to provide the traffic and transit information?

Response. The Federal Communications Commission’s (FCC) order on July 21, 2000, approving the use of 511 for traveler information delivery, makes seven specific points in the assignment of 511. They are:

1. 511 is assigned to government entities for both wireline and wireless telephone services.
2. Technical details of implementation and cost recovery are left with Federal, State, and local transportation agencies to determine.
3. Federal, State, and local transportation agencies are to determine the type of information to be provided.
4. Federal, State, and local transportation agencies are encouraged to ensure that 511 transcends municipal boundaries and is appropriate to the national designation of the number.
5. Transportation agencies are encouraged to determine uniform standards for providing information to the public.
6. U.S. DOT is encouraged to facilitate widespread deployment of 511.
7. The FCC will assess the deployment of 511 in 2005 to determine if the number is in widespread use.

The FCC order very deliberately allows broad discretion on the part of State and local transportation agencies in the implementation of 511. Paying for the 511 services is left to the State and local agencies to determine. This is not a mandated public service.

The assignment of 511 is nationwide and the FCC expects that the service will be available to the entire traveling public. However, the Commission realizes that this nationwide deployment will take time. The FCC uses the term “national scope” in discussing 511, and many segments of the transportation community have interpreted “national” to mean “Federal.” This is not the intent of the FCC. The U.S. DOT has been encouraged to facilitate deployment, not mandate it nor regulate it.

The Department has been engaged in activities to facilitate local agencies’ deployment of 511.

The Department helped to establish a 511 coalition led by the American Association of State Highway and Transportation Officials (AASHTO), the American Public Transportation Association (APTA), and ITS America. This coalition is developing implementation guidelines that will foster consistent 511 deployment from State to State. The Department has also made available a 511 deployment assistance grant program that will provide up to \$100,000 per State to encourage transportation agencies to work together with communications providers to develop a Statewide plan for 511 deployment. The Department has also developed a number of case study reports to describe the deployment experiences of six jurisdictions that are considered the “early adopters” of 511, and white papers to guide transportation professionals and officials in the deployment of 511.

The FCC will look at the deployment of 511 in 2005 to determine if there is widespread deployment of 511. The three-digit dialing codes, 211 through 911, are scarce resources. Thus, if the number is not being used, the FCC could reassign the number to another use. However, there are no reporting requirements on 511 deployment implied by this statement. The U.S. DOT will keep the FCC informed about the status of deployment to satisfy this requirement of the FCC.

The number of areas that have sufficient ITS infrastructure in place to provide traffic and transit information grows over time. Currently the Department is aware of over 300 telephone numbers that disseminate traveler information as well as numerous others that provide transit information. Few, if any of them, have complete coverage of their entire metropolitan area. Instead they have surveillance or sensing information that covers a portion of the system, usually that most heavily traveled. Implementation of 511 is considered a local matter, so consideration of whether or not enough infrastructure is available rests with the local agencies. The Department believes there is a need for increased surveillance capability nationwide in order to support 511 and other traveler information initiatives, as well as for improved operation of our highway system, and we are pursuing various initiatives to improve this information gap.

RESPONSES OF LAWRENCE YERMAK TO ADDITIONAL QUESTIONS FROM
SENATOR SMITH

Question 1. The basic infrastructure to allow traffic monitoring usually consists of closed circuit cameras and loop detectors. I am interested in how to ensure the limited use of these cameras for traffic monitoring purposes only. Is it common for jurisdictions to have a policy that does not allow video recording, using images for vehicle or personal identification, or using the cameras for purposes not related to traffic monitoring, such as law enforcement? Will this limitation be incorporated into Federal ITS standards? What research is DOT conducting to explore less costly or more technologically advanced methods of traffic monitoring that do not involve the use of cameras?

Response. Surveillance cameras are valuable traffic surveillance tools that serve many purposes. Their primary purpose is to confirm that an accident or other traffic-impeding incident has occurred, to accurately determine the location of the incident, and to determine the extent of the incident and therefore the proper response (i.e., are serious injuries likely, is there a potential for hazmat release, etc.). Surveillance cameras are also used to confirm that various traffic control devices are operating properly, such as the gates that control reversible High Occupancy Vehicle (HOV) lanes and variable message signs. Another type of video camera with video recognition capability is now being used to replace more common vehicle detection systems such as inductive loops. These systems, while more expensive initially, are much more reliable over time than the traditional loop detector and therefore are gaining in popularity for such uses as controlling traffic signals. Neither of these cameras should be confused with cameras used solely for enforcement purposes such as red light running systems, which are very different in design and intended purpose.

State and local agencies that use traffic surveillance cameras are very sensitive about the improper use of these cameras and have policies and procedures in place to ensure proper use. It is very common for jurisdictions to have a policy on the use of surveillance traffic cameras that does not allow video recording, using images for vehicle or personal identification, or using the cameras for purposes not related to traffic monitoring, such as law enforcement. In fact, we are not aware of any public agencies using cameras for traffic surveillance that do not have clear policies in place for the use of video images. For example, most, if not all, agencies who share this video information with local television stations for traveler information purposes also have clear policies about not making images available of accidents where vehicles or victims could be identified. Strong policies have also been established for other ITS systems, such as electronic toll tags, to ensure privacy.

ITS America has established a set of privacy principles that most members of ITS America have adopted for their own use. This is largely a State and local responsibility and, since strong policies have been developed and adopted by these entities, there does not appear to be a need to establish Federal policies, regulations, or standards, at this time. The ten ITS America principles deal with such topics as the recognition and respect of individual privacy; compliance with applicable State and Federal laws on privacy and information use; anonymity; and commercial or secondary use.

In previous years, we have funded a number of efforts to advance the State of the art in traffic surveillance and detection and are currently evaluating technologies that would allow travel time information to be gathered anonymously. We are not currently funding any development work in this area, in part, because the State of the art in traffic surveillance is so advanced and, in part, because the market and therefore the privately funded development efforts are so robust. Despite the wide range of surveillance technologies available in the market these days, we would conclude, however, that the video camera meets a number of special needs in traffic surveillance that other detection systems cannot and are not likely to meet in the near future. Therefore the use of these cameras is likely to continue to expand both in terms of jurisdictions and coverage area. The events of September 11 have caused a number of metropolitan areas, including Washington, DC, to question the adequacy of their video surveillance network to manage traffic during evacuations and other major events or incidents.

Question 2. How can we structure the ITS reauthorization to encourage the wider deployment of proven ITS applications that have immediate benefits?

Response. There are three key leverage points which must be put in place for widespread deployment and use of ITS funding:

(1) *Full knowledge of the real-time conditions on the surface transportation system.* For ITS to fulfill its promise of operating the surface transportation system at the highest level of efficiency requires the availability of real-time traffic, transit, and roadway weather information. Today, less than 25 percent of the National Highway System is sufficiently instrumented to provide this information. If ITS is to be used to improve the management of incidents, reduce delays through work zones, adapt to changing weather conditions, and respond in emergency situations, we must create the incentives and requirements that will result in the quick deployment of sensors, cameras, and communication systems, and the creation of a nationwide intelligent “infrastructure.”

(2) *Institutional change.* Key to the deployment of ITS, and improved operations of the system will be creating points of accountability and coordination for systems operations. Existing transportation institutions were largely created for and operate from a project-based culture. Operating the system is a 24/7 job that requires a performance-based approach. It also requires that there be a mechanism (similar to the metropolitan planning organizations for infrastructure planning) that brings the key players—including non-traditional partners such as police, fire, emergency response, towing operators, parking managers, etc.—to the table to develop and implement regional operations.

(3) *Funding.* Outside of the ITS program, the use of Federal funds for ITS deployment has been limited. States have been slow to take advantage of the changes made in TEA-21 that make it clear that ITS is eligible under the mainstream Federal-aid highway programs (National Highway System (NHS), Surface Transportation Program (STP), Congestion Mitigation and Air Quality Improvement Program (CMAQ)). Given the significant infrastructure needs that exist, it is difficult for ITS and operations projects to compete for funding. Acceleration of ITS deployment will require stronger support for efforts that increase road efficiency through intelligent transportation systems.

Question 3. ITS deployment has not been significantly funded from State formula funds when the funding must compete with construction projects. Is the national architecture and standards now mature enough that all States can take advantage of ITS formula funds?

Response. The investments that the Department has made in architecture and standards development, as well as training, technical assistance and technical guidance, have laid the foundation for the nationwide deployment of ITS. In addition, local plans for ITS deployment are being established through the implementation of the TEA-21 requirement on architecture consistency. This requirement will result in the development of regional architectures at the State and local level. Collectively, these efforts will provide the mechanism for guiding future ITS deployments. While continued investment in ITS Research and Development is needed, the program is now mature enough to support the widespread deployment of ITS through formula funds.

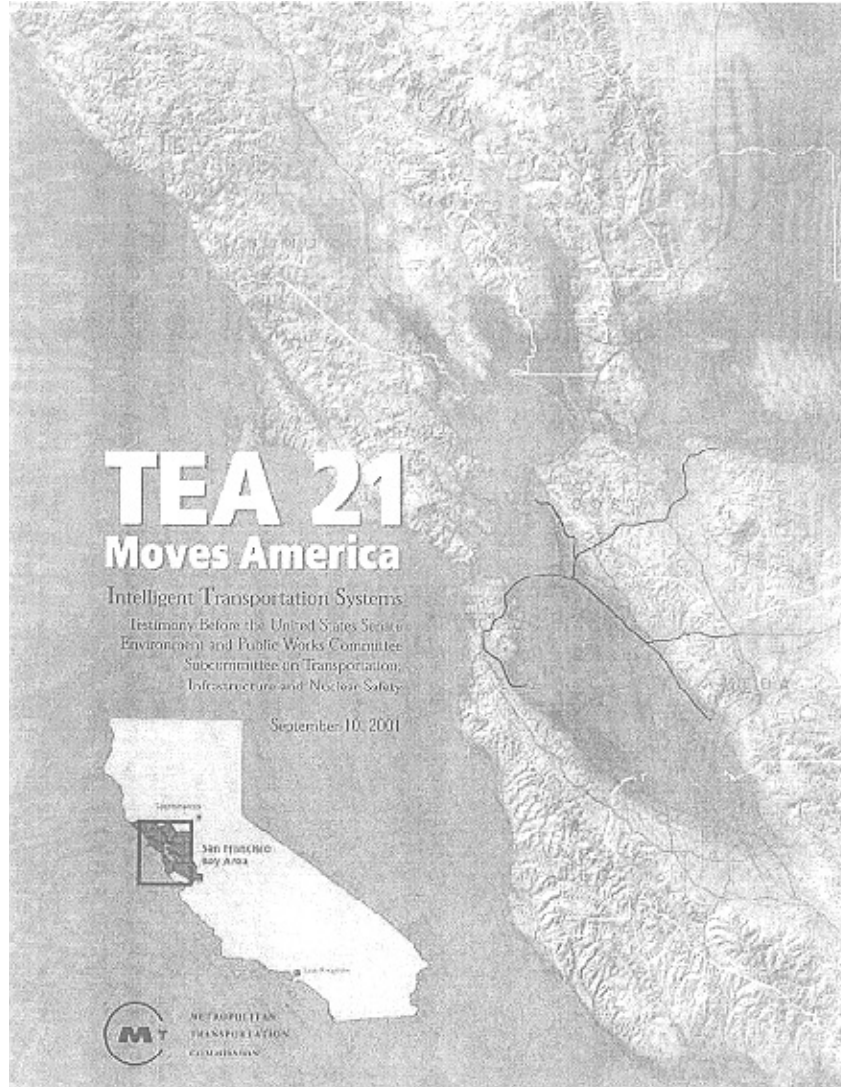

Testimony of the Metropolitan Transportation Commission
before the Senate Environment and Public Works Committee
Subcommittee on Transportation, Infrastructure and Nuclear Safety
September 10, 2001

Good afternoon. My name is Jim Beall. I have been a commissioner on the San Francisco Bay Area's Metropolitan Transportation Commission for nearly a decade and a half, and I am the current chair of the board of supervisors for Santa Clara County, California — the center of Silicon Valley.

Thank you for the opportunity to submit this testimony to support the Committee's efforts to maintain an adequate federal role in transportation investments across this nation, and specifically to let the Committee know of the successes of TEA 21 and to help the Committee gain a more detailed view on what ITS means for the nation's transportation network.

The Metropolitan Transportation Commission is the metropolitan planning organization, or MPO, for the nine-county San Francisco Bay Area — a region comprising nearly 6.8 million people, who reside in nine counties and more than 100 cities, in an area of over 7,000 square miles that includes the densely populated cities of San Francisco, San Jose and Oakland, as well as the agricultural expanses of Napa and Sonoma counties. Making transportation work in a region as diverse as ours requires partnering with federal, state and local jurisdictions. It also requires that MTC, as the Bay Area's MPO, balance competing demands for scarce federal transportation funding.

As MPOs around the country grow and the metropolitan areas they serve become more and more important to the nation's economy, they increasingly are turning to ITS services to keep people and goods moving.

Coming from the home of the high-tech revolution, I am particularly aware of the many ways intelligent transportation systems or ITS can be used to combat congestion and get commuters where they're going, as efficiently as possible. In Santa Clara County, for example, a multi-agency team, led by the city of San Jose and the county, is working to link

freeways, expressways, local streets and public transit services into a 15-mile "Smart Corridor." Fiber-optic cables carrying data and video images, and connecting traffic signals, cameras and computers into a single network, enable traffic managers to spot accidents and congestion, change timing patterns for traffic signals, alert drivers to problems, and dispatch traffic control officers or tow trucks to the scene.

While MTC has been using TEA 21's flexible funding features to implement these kinds of transportation management programs out on the street, such ITS programs were made possible in part by 10 years of federally sponsored ITS research, development, testing and initial deployments. In that decade, ITS has moved from research and development of leading-edge technology to becoming a practical tool for commuters to make the right travel decisions.

ITS allows us to provide drivers with instant information about accidents or backups through changeable message signs and highway advisory radio, and to send extra highway patrol officers on the routes with the most traffic congestion, so they can be ready to respond to accidents.

To prevent traffic congestion before it happens, we've also upgraded and linked traffic signals to reduce stop-and-go traffic on major thoroughfares, and installed metering lights to allow cars to move onto freeways and bridges at a regulated pace.

We have implemented FasTrak™, an electronic toll collection system, on all Bay Area toll bridges, to let drivers prepay tolls without stopping — and they can use the same device on Southern California toll roads 500 miles away. In the Bay Area, we also have installed roadway detectors and closed-circuit television to collect up-to-the-minute data on what's happening on the roads. The Bay Area's Transportation Management Center uses these high-tech tools to monitor traffic conditions and dispatch help as needed. The center also permits us to plan ahead for major events that could disrupt traffic by coordinating transit and other services and letting the public know their options.

ITS enables Bay Area transportation managers to expand the choices available to the region's travelers. For example:

-
- Bay Area transit riders are just now starting to carry one card, the TransLink[®] smart card, to pay their bus, train or ferry fare, under a pilot program launched by MTC to test the technology. The "universal transit ticket" stores value and automatically deducts the cost of each trip when the card is passed near a reader onboard vehicles or at fare gates.
 - Bay Area travelers can call a single regionwide phone number for up-to-the-minute traffic information on all of the region's freeways, as well as direct connections to public transit operators, ridesharing and other services. MTC also is leading the effort to make the Bay Area the first region in California to offer this service through a new, nationally designated transportation information number: 511.

ITS programs such as these make travel more convenient for the region's commuters but they also provide considerable savings in time and resources. For example,

- The California Department of Transportation estimated a time savings of over 25,000 hours per year and fuel savings of more than 55,000 gallons during the initial phase of the electronic toll collection system that is now in place on all nine Bay Area toll bridges.
- Each month, 50,000 Bay Area residents call TravInfo[®] — the regional transportation information phone number — for traffic, public transit and other types of travel information. A survey evaluating the service indicated that 45 percent of callers changed their travel behavior after receiving this real-time information.
- More than 10,000 Bay Area drivers per month use one of the 3,500 wireless telephone call boxes installed by MTC along the region's highways. The call boxes are a direct line to dispatchers, who can send police, fire, paramedic, towing or other roadside assistance.
- MTC's fleet of roving tow trucks — the Freeway Service Patrol — covers over 400 miles of Bay Area freeways, responding to 9,000 incidents a month. In addition to increasing traveler safety and reducing air pollution, the tow trucks cut congestion-related delay by more than 3.5 million hours and fuel consumption by 1.4 million gallons annually.

Mr. Chairman and members of the subcommittee, as you can see, TEA 21 is working well in the San Francisco Bay Area. It is important to note that Bay Area ITS programs have been funded by the flexible features of TEA 21 and other local and state sources, and not just by federal ITS funds. We encourage continued mainstreaming for such projects as a further commitment by federal transportation policy to better manage the transportation system that we have.

Our experience with ITS confirms that a federal program that is focused on broad national goals that no state, regional or local government could easily accomplish for itself, is essential for the further deployment, operation, maintenance and implementation of ITS across the nation, and that, given the fast-changing nature of ITS technologies, operations and maintenance as well as capital needs for ITS should be eligible for federal funding.

At a more general level, the federal transportation program must recognize that ITS projects are becoming essential to the safe, efficient operation of the nation's transportation systems. There is now (thanks to federal funding of evaluation studies) extensive documentation on the range of benefits that ITS can achieve for improving mobility and safety for our citizens.

We believe that the federal initiative in sponsoring a national ITS program was a far-sighted move that will continue to pay positive dividends far into the future, and we urge you to renew that national commitment.

Attached to this testimony in the packets before you are more details on the high-tech transportation applications I've been describing to you this afternoon. We also have brought along prototypes of our FasTrak™ transponder and the TransLink® smart card-card reader for display. At this time, I'd like to introduce MTC's manager of Transit Coordination and Access, Melanie Crotty, who can answer any specific questions you may have about how ITS is being used to improve the mobility of those who live and work in the Bay Area.

Intelligent Transportation System Projects Bring Benefits to Bay Area

While the Bay Area continues to make significant strategic investments to expand the transportation system, we are increasingly emphasizing service and technological improvements that focus on boosting the efficiency of the region's existing transportation network and giving users better information and travel options to make the most of the region's roadway and transit network. We call this strategy "system management."

MTC and its transportation partners provide a number of programs targeted at reducing congestion, improving traveler information and increasing access for all Bay Area travelers. MTC also works with local jurisdictions to better maintain local streets and roads as well as assist with projects that smooth the flow of traffic on local arterials. In recent years, MTC has assumed a greater regional role in designing and directly operating programs to better manage the transportation system.

Key Projects

TransLink®

TransLink® is a smart-card-based universal ticket that will be good on all of the region's mass transit systems.

TransLink® is designed to (1) improve passenger convenience in making inter- and intra-agency trips; (2) improve the efficiency and security of the region's fare collection systems; (3) improve transit system data collection for service planning purposes and development of fare policies; and (4) take

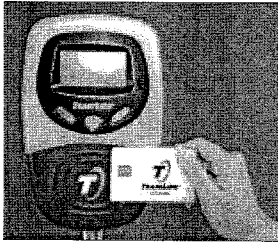

advantage of revenue-enhancing or cost-saving business partnerships with the private sector. The Phase 1 TransLink® demonstration will be implemented in fall 2001 on selected portions of six transit operators — AC Transit, BART, Caltrain, Golden Gate Transit, San Francisco Muni and Santa Clara Valley Transportation Authority (VTA). Approximately 4,000 transit riders will use TransLink® for a six-month period and evaluate the system's capabilities. Full implementation on all of the region's transit systems will depend on the outcome of this demonstration phase.

FasTrak™ Electronic Toll Collection

Now in operation on all seven of the region's state-owned toll bridges, the FasTrak™ electronic toll collection system is saving drivers time and money while reducing congestion at key Bay Area hot spots. FasTrak™ users establish a prepaid account with Caltrans (which administers the system) and receive a small electronic transpon-



der that is placed inside their vehicle. At the toll plaza, an overhead antenna reads the transponder and deducts the appropriate toll amount as the driver passes through at the 25 mile-per-hour speed limit — eliminating the need to stop and pay tolls and improving traffic flow through these bottlenecks.

The FasTrak™ system has proven very popular with the region's motorists since its introduction in 2000. As of July of this year, Caltrans had issued nearly 150,000 transponders, and new FasTrak™ applications were averaging 1,500 per week.

The FasTrak™ system is also in effect at the independently operated Golden Gate Bridge in the Bay Area, and in Southern California on the Route 91 express lanes as well as the Foothills and San Joaquin Corridor toll facilities.

TravInfo®

The TravInfo® telephone service — accessed via 817-1717 from any area code in the Bay Area — provides comprehensive traveler information 24 hours a day, 365 days a year. Since the project was launched in September 1996, TravInfo® has served approximately 3 million callers. Over the course of the next two years, MTC will transition 817-1717 to 511, the new Federal Communications Commission-approved nationwide number for traveler information. In addition, the next two years will see improved data collection on traffic conditions and enhanced information dissemination to the public. The core of TravInfo® is the operation of its Traveler Information Center, which receives and disseminates road condition and transit information to travelers through the 817-1717 number and to TravInfo®'s private sector partners via an electronic connection.

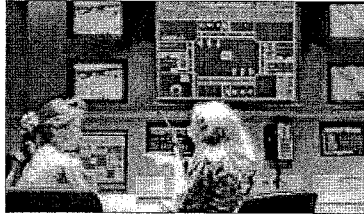

Improving Traveler Information

MTC provides a wide range of information to Bay Area travelers on transportation system conditions and travel options that help promote effective use of the region's road and transit networks.

Transitinfo.org

MTC's transit information Web site — transitinfo.org — provides transit service information (schedules, fares, maps, announcements, etc.) and links for over 40 public and private transit services throughout the MTC region and in neighboring areas. The site also includes information about and links to regional programs, such as bicycle programs and airport and ridesharing services, as well as transit lines that serve major Bay Area destinations. Currently, the site is averaging nearly 380,000 users per month.

TranStar

MTC also is implementing the TranStar system, which combines into a single database the routes, schedules and fare information for all transit services offered by Bay Area transit operators. TranStar makes this information available to all transit telephone information centers to enable them to provide trip-planning assistance to any caller, regardless of the transit system (or systems) used.

TakeTransitSM Trip Planner

The TakeTransitSM Trip Planner — available since July 2001 on transitinfo.org — provides TranStar capabilities on the Internet, and enables travelers to obtain transit itineraries for any trips using BART, AC Transit, San Francisco Muni and County Connection (Central Contra Costa Transit Authority). The remaining transit agencies will be integrated into the trip planning system over the next two years.

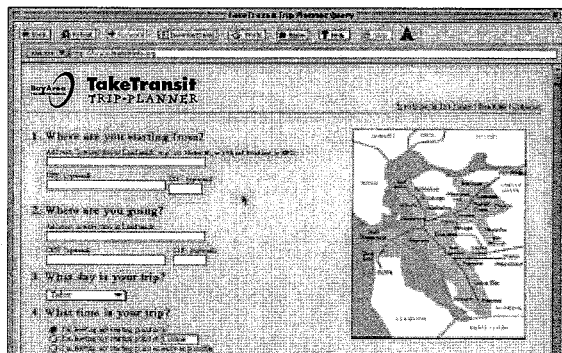

Targeting Congestion and Traveler Safety

Freeway Operations

A number of interrelated programs to improve the safety and efficiency of the freeway system are under way in the Bay Area. Overseen by MTC, Caltrans and the California Highway Patrol (CHP), these include a traffic operations system, which employs high-tech devices to monitor and report on traffic, and "Smart Corridors," in which multiple traffic and transit control centers are managed as a single network via computer connections.

Freeway Service Patrol

The Bay Area Freeway Service Patrol (FSP) is a special team of 74 tow trucks, six pickup trucks and two flatbeds (plus six back-up trucks) that continuously patrol more than 400 miles of the Bay Area's most congested freeways. More than 107,000 assists were provided in 2000. The FSP's primary purpose is to cut down on traffic jams by quickly clearing accidents and other incidents that account for more than 50 percent of traffic congestion. A swift response also reduces the chance of further accidents and bottlenecks. The tow trucks are financed with federal, state and local monies. Local funds come from the MTC Service Authority for Freeways and Expressways (SAFE), which is financed by a \$1 annual vehicle registration fee in participating counties. The service costs approximately \$5 million a year to operate.

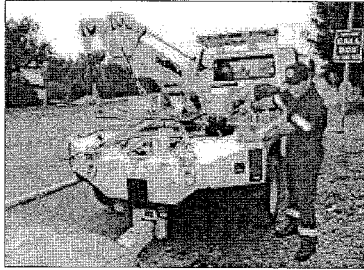

Call Box Network

The call box program provides assistance to motorists in trouble, allowing them to report a road hazard, a flat tire or a mechanical breakdown. In partnership with the CHP and Caltrans, MTC operates over 3,500 call boxes on more than 1,100 miles of urban, suburban and rural highways and expressways in the nine counties. Upon receiving a call from a call box, call answering personnel can dispatch appropriate assistance, whether a tow service or law enforcement, fire or medical service.



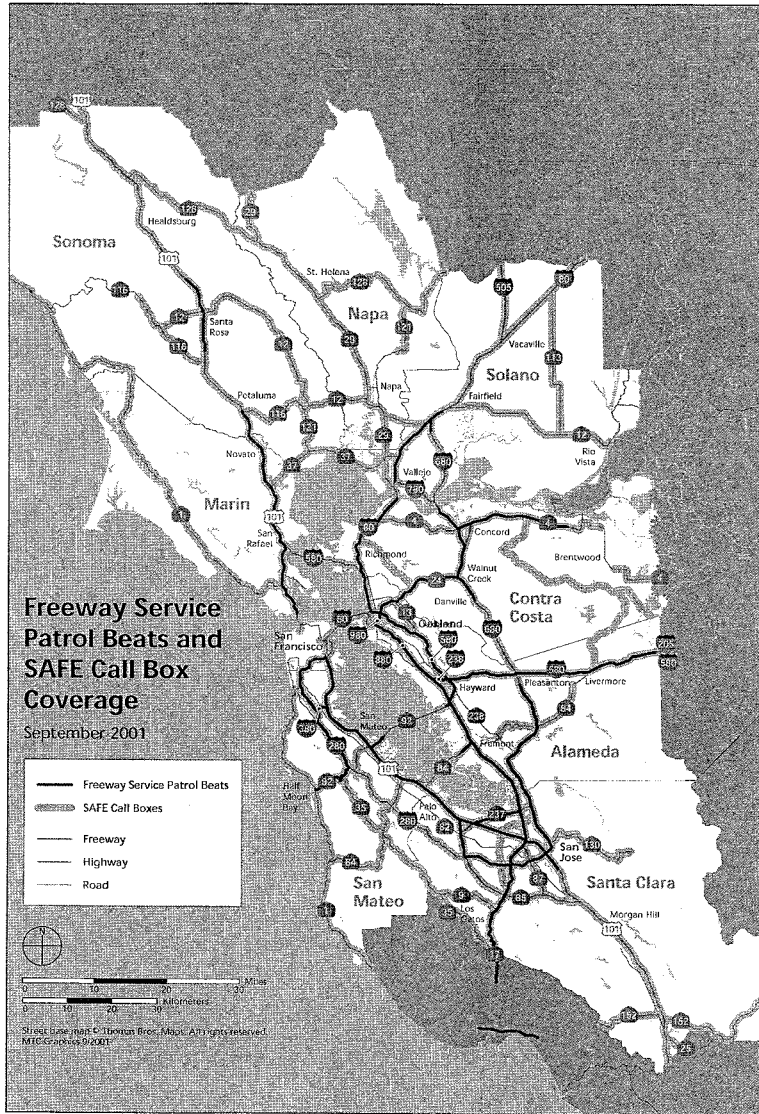

Managing Traffic Signal Networks

MTC's Traffic Engineering Technical Assistance Program (TETAP) provides consultant expertise for local governments that do not have the in-house staff to maintain and operate their traffic signal network. The program focuses on improving the timing of signals within and between jurisdictions to improve the flow of traffic on major roadways. MTC has provided over 100 TETAP grants to more than 60 jurisdictions, the majority with populations under 65,000.

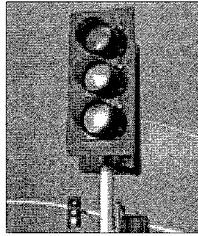

Pavement Management System

MTC's Pavement Management System (PMS) provides computer software and technical assistance to help cities and counties extend the life of pavement and thus stretch local budgets further. Today, MTC's PMS program is used by 91 cities and eight counties in the Bay Area. The program also is used outside the region in Southern California and in eight states beyond California's borders.

This program has been essential in identifying the extent of local street maintenance needs and the shortfalls in funding to address them. While MTC's most recent

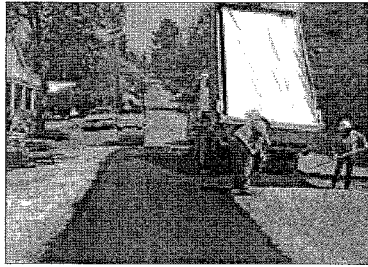

Regional Transportation Plan (RTP) dedicates 29 percent of available revenues over the next 20 years to operation and maintenance of the region's road system, significant shortfalls remain. MTC's legislative program advocates additional funding for repair of the region's roadway network.

STATEMENT OF MARTY MANNING, PRESIDENT-ELECT, AMERICAN PUBLIC
WORKS ASSOCIATION

Thank you Mr. Chairman and Members of the Subcommittee for the opportunity to appear before you today. My name is Marty Manning and I am the president-elect of the American Public Works Association. I am also the Public Works Director for Clark County, Nevada. My comments will be brief and will cover the views of the American Public Works Association on this topic as well as the efforts of the local area partnership in Clark County, Nevada that is presently working to implement intelligent transportation system facilities.

The American Public Works Association serves more than 26,000 members concerned with the operation, maintenance, renewal and improvement of the Nation's infrastructure by promoting professional excellence and public awareness through education, advocacy and the exchange of knowledge.

APWA has a vital interest in the reauthorization of the Transportation Equity Act for the 21st Century (TEA-21). In fact, APWA has a reauthorization task force currently in place that is working diligently to develop and promote APWA's priorities for reauthorization. Additionally, APWA has teamed up with other local organizations to comprise the Local Officials Transportation Working Group, which is made up of organizations representing elected county and city officials as well as development organizations, technology and city/county managers. APWA also serves as a member of the steering committee for the Federal Highway Administration's National Dialogue on Operations.

We hope that you will look to APWA as a valuable resource for you and your staff members as reauthorization proceeds. With so many unmet transportation-funding needs, APWA believes that it is imperative to maintain the basic goals of TEA-21 by protecting the funding firewalls and allowing for as much local funding flexibility as possible. Further, as our members deal most directly on a daily basis with the system users, we have a strong understanding of how to best address transportation issues within our communities.

Recent studies show that traffic congestion costs the country \$78 billion in wasted time and wasted fuel annually. In addition, urban area trips take about one-third longer during rush hours and 27 percent of the Nation's urban freeways are now congested. This takes a toll on the Nation's economy.

The deployment of ITS tools in conjunction with the construction of needed improvements would assure that existing transportation infrastructure may operate at a higher capacity and that new improvements would also operate more efficiently and be more economical to build.

As you know, Clark County is one of the most rapidly growing areas in the Nation. We have come to expect new residents at a rate of 3,000 to 5,000 a month. We also expect to welcome the arrival of 35 million visitors this year to the Las Vegas destination resort area. This continuing growth puts a lot of pressure on the area network of highways, roads and streets.

In Clark County, Nevada, we are becoming advocates of the management tool products that ITS offers and the capacity and safety benefits that they represent. Existing intelligent transportation systems are being improved and integrated with new system tools that are now being installed. The installation of ITS products in the urbanized Las Vegas Valley has only been possible by the creation of partnerships among Federal, State and local governments as well as our private sector partners.

As an example, the Las Vegas Area Computer Traffic System provides computerized control for the traffic signals in all of the jurisdictions in the Las Vegas Valley. The system, operating under an agreement among the Nevada Department of Transportation, the Southern Nevada Regional Transportation Commission, three incorporated cities and the county, provides substantial travel time improvements throughout a growing urbanized area with a population of 1.4 million people. It has also provided real benefits in air quality. While the system was originally installed with a Federal grant and NDOT assistance, the incorporated cities and the county pay its annual operations and maintenance costs.

The Las Vegas Area Computer Traffic System was an initial step into ITS technology. Recently, further steps have been taken. Additional improvements to the system have added new computer hardware and software, high-speed telecommunications facilities from the traffic signals to the computer, television observation at critical intersections, and high tech local traffic signal controllers. In addition, the Nevada Department of Transportation is proceeding on additional ITS projects to create a highway management system that will provide the functions of traffic control, incident management, en-route and pre-trip traveler information and a user service for archived data. The highway management system called FAST will be in-

tegrated with the arterial management system under the Las Vegas Area Computer Traffic System at a common location shared with the Nevada Highway Patrol Dispatching Center. Each system will operate with a common staff and an operating agreement among the Nevada Department of Transportation, the Southern Nevada Regional Transportation Commission, the three incorporated cities and the county.

Construction of the initial phase of the FAST highway management system will begin before year-end and will be completed in two years. This construction will encompass the installation of ramp meters at select locations; high-occupancy vehicle bypass ramps at metered locations; arrangements with the Nevada Highway Patrol for ramp and bypass traffic enforcement; dynamic message signage at selected locations to provide road condition and incident information to motorists and the construction of an arterial and highway management operations center. Upon completion of this project, the Las Vegas urban area will be well on the way to the creation of an integrated arterial and highway management system.

As a county public works director, I can appreciate the value of the ITS management tools and technologies we have already installed and the potential values that the additions in new system improvements will provide in our urbanized area.

New technologies and tools that can be deployed to improve transportation system management already do and can continue to have positive results at the local government level, but primarily in communities prepared to enter into cooperative arrangements and partnerships with State and other local jurisdictions for the express purpose of improving transportation system management. ITS should have a continuing role in perfecting transportation system management technologies.

In conclusion, we would recommend the continued support of the ITS Program and recognition of its value in identifying and developing transportation system management technologies needed to improve the capacity and efficiency of the Nation's highways, roads and streets. In addition we would recommend that the overall goals of promoting safety, efficiency and economy; enhancing mobility; providing accessibility to transportation; improving the productivity of travel; safeguarding the environment and reducing energy consumption be considered a solid basis for the development of the ITS Program of the future.

STATEMENT OF STEPHEN ALBERT, DIRECTOR, WESTERN TRANSPORTATION INSTITUTE, MOUNTAIN STATE UNIVERSITY, AND PRESIDENT, ROCKY MOUNTAIN CHAPTER, INTELLIGENT TRANSPORTATION SOCIETY OF AMERICA

Good afternoon Chairman Reid, Ranking Member Inhofe, and Members of the Committee. I would like to begin by thanking you for this opportunity to share our views and perspective on Intelligent Transportation Systems and specifically Advanced Rural Transportation Systems or rural ITS. WTI/MSU, and actually the entire rural community of transportation, tourism, public safety, fleet managers, National Parks, Native Americans and private sectors/interests thank you for recognizing the need to address rural transportation issues and advanced technology applications at this hearing.

My name is Stephen Albert, I am the Director of the Western Transportation Institute (WTI) at Montana State University (MSU). This is the second time I have had the opportunity to present our view of rural transportation needs to the Committee.

The first was in 1996, as part of the Subcommittee's ISTEA Reauthorization Field Hearings in Coeur d'Alene, Idaho, to Senators Baucus, Warner and Kempthorne.

WTI's mission is to "make rural travel and transportation safer, more convenient and more accessible." Founded in 1994 by the California Department of Transportation, Montana Department of Transportation and MSU, WTI is the Nation's leading research Center focusing on rural transportation issues. With ongoing research, demonstration and evaluation projects in 30 States and 10 National Parks, WTI was recognized in 1998 by ITS America for our "outstanding achievement in rural ITS."

In addition to serving as WTI's director, I also serve as the Rocky Mountain ITS America Chapter president, which includes Montana, Idaho, Wyoming, Utah, and Colorado, and as vice-chair of the ITS America State Chapters Council that represents all 50 States. I also serve on the ITS America Advanced Rural Transportation System Committee, U.S. DOT Rural Action Team and the National Academy of Sciences, Transportation Research Board Task Force on Transportation Needs for National Parks and Public Lands. Finally, I recently authored a chapter on Advanced Rural Transportation Systems for the Intelligent Transportation Primer sponsored by Institute of Transportation Engineers, U.S. DOT and ITS America.

Turning to the subject matter of your hearing today, I am here representing not only Western States, but the entire rural community and we thank each of you for

raising awareness of rural America transportation needs and ITS applications. My testimony was developed from speaking with stakeholder groups on the East Coast, Southern United States, Midwest and Alaska.

My testimony will address the following three areas:

Magnitude and severity of rural transportation challenges facing this Nation; specific examples and benefits of successful ITS deployment; future focus areas where additional emphasis and resources should be placed.

1. WHAT ARE THE RURAL CHALLENGES?

For the last 10 years the rural constituents have heard our transportation leaders highlight congestion as our Nation's leading challenge. Programs such as Operation Time Saver, Model Deployment Initiative and others have been the showcase of U.S. DOT. These showcase programs have little, if any, direct application to approximately eighty percent (80 percent) of our Nation's surface roads, or roughly four million miles of roadway. The emphasis of ITS applications in urban areas has focused on reducing congestion and increasing vehicle throughput and highway capacity, all of which are benefits with which rural stakeholders have little in common. Unlike urban areas that have congestion as the primary single issue, rural needs are more diverse, complex and only tangentially transportation-related. So what are the rural challenges?

1.1 Safety and Non-Interstate Roadways

In rural areas safety is of paramount importance. According to Federal Highway Administration (FHWA) statistics, sixty percent (60 percent) of the crash fatalities occur on rural highways, while only 39 percent of the vehicle miles traveled occur on these roads—a disproportionate relationship. These combined facts make rural crash rates (the number of crashes per million vehicle miles traveled) 2.5 times greater than urban areas. In examining the rural crash rate by classification of roadway (i.e. interstate, major collector, local road, etc.), we find that local roads have a crash rate of 3.68 verses interstate crash rates of 1.23—or local roads have a three times greater risk factor. Furthermore, single vehicle crashes on 2-lane rural roads accounted for 54 percent of all rural crashes in 1998, and about 30 percent of these occurred on curves. When these crashes occur they are compounded by limited emergency services among communities such as volunteer fire and rescue, and remote hospital facilities. Emergency response time for crashes in rural areas to receiving aid at a hospital is twice as long as in urban areas, according to the National Highway Traffic Safety Administration (NHTSA).

1.2 Digital Divide—No Wireless Communication Coverage

The safety situation on our rural roads is exacerbated by the fact that vast rural areas of the United States are without wireless communications, which impacts safety and increases infrastructure deployment costs. The current and planned conveniences that wireless coverage provides for Mayday services, entertainment, and telephone service is largely non-existent in rural America. Cellular providers' business models are focused on call volume and profit; these do not align with rural characteristics. Preliminary research conducted by WTI in five Western States indicates that the notification time to learn of a crash is two to three times longer where no wireless communication exists and near jurisdictional borders. In fact, the medical response needs of the "golden hour" in remote sections of rural America is not measured in minutes, but rather hours. When agencies must consider deployment of technology if no wireless coverage exists, then wireline services must be constructed. Recently, the Washington DOT had to install 30 miles of cable for one closed circuit television camera that was needed to monitor and verify safety issues on a rural segment of highway. These types of communication challenges do not exist in an urban environment.

1.3 Weather Impacts Every Day Life

Weather can be deadly in many regions of the United States. Stories of travelers stranded in rural communities due to road closures, vehicles trapped in snow banks, and flooding and hurricanes destroying or isolating communities are now becoming more frequent events. In November 2000 a snowstorm in Rollins, Wyoming closed I-80 and resulted in 31 miles of semi-tractor trailers backed-up with no fuel, no services and no way to communicate the closure or re-opening of the roadway to drivers. According to FHWA there are approximately 7,000 fatalities and 450,000 persons injured each year due to weather related events. ITS technologies are available to mitigate the effects of circumstances such as this; however, additional funding for rural ITS deployment is critical.

1.4 Tourism and Economic Viability

Tourism is a critical concern to the economic viability of numerous rural communities. According to the Travel Industry Association of America in 1998, travel and tourism in the United States is the Nation's largest export industry and second largest employer, accounting for over \$515 billion in expenditures, resulting in 7.6 million jobs and accounting for 1.3 billion domestic trips. In most States, tourism is the second leading economic indicator and considered the key to the economic future of many States. Based on rural ITS outreach workshops conducted in 15 States by WTI, in partnership with FHWA, the travel and tourism community have identified concerns in the following areas: directional signing; timely and accurate information; coordination of traffic management alternatives; seasonal and special event traffic management; parking information; regional sharing of information and services; and funding. In summary, an efficient transportation system is essential to rural communities who depend on tourism revenues for their survival. Providing real-time information to tourists, via ITS, is the key to encouraging greater tourist activity in rural areas and enhancing their economies.

1.5 Federal Lands, National Parks and Native Americans

Two distinct groups of target areas that highlight rural environment are issues associated with Federal lands and Native American lands as well as users of those areas. As an example of our Federal lands consider National Parks and transportation. The impact of our National Park Service on regional economies and their transportation systems should not be underestimated. In order to provide a framework on the impact of the NPS consider the following NPS statistics:

- Scale—374 parks in 49 States, 18 million acres;
- Employees—19,200;
- Economic activity—\$14 billion, supporting 309,000 jobs;
- Visitation—266 million visitors, demand increasing 500 percent over the next 40 years.

With a broad impact and visitation on the increase, the NPS is under extreme pressure to provide increased services with fewer resources, while simultaneously trying to provide stewardship for an environment they are entrusted to protect for future generations. As our National Parks become increasingly "loved to death," it is apparent that respective transportation systems and associated services are a critical issue.

The second area is our sovereign Native American lands where safety, economic viability and transportation are the key issues. Research has shown that Native Americans die in motor vehicle crashes at rates six times that of the rest of the Nation and $\frac{3}{4}$ of Native American traffic fatalities involve alcohol. Unemployment rates on reservations often exceed 70 percent, over 10 times the national rate. Last, only 29 percent of tribes have any form of transit system. The issue of economic viability was the most important issue identified by 300 Native American tribes in a recently completed survey by WTI to assess tribal and transportation needs. Safety needs were second priority, followed by tourism and traveler information. Here again, ITS deployment will have a positive impact by providing enhanced safety and traveler information.

1.6 Animal Conflicts

Each year there are approximately 726,000 animal-vehicle crashes. These crashes rarely result in fatalities, but at approximately \$2000 per incident in property damage, the annual cost nationally amounts to over \$1 billion. The growth of suburbs into wildlife corridors contributes to the problem, however, these accidents occur at higher speeds and with greater frequency in rural areas. Today's deer population alone is greater than 25 million. Accidents with deer and other animals are only going to increase as populations expand and urban development encroaches into rural areas.

1.7 Public Mobility

Unlike urban areas, where public transportation service is implemented to provide transportation for employment purposes or as a means of reducing congestion, in rural areas public transportation service has a direct impact on the quality of life of many rural residents. According to the Federal Transit Administration (FTA), approximately 38 percent of the rural population has no access to public transportation and another 28 percent has little access. Even when public transportation exists, little or no information is available about the services. Furthermore, service is sometimes restricted to weekends, evenings, or designated days of the week. Low population density in rural service areas makes it difficult at best to deliver public transit services. Where neighbors often live miles apart, trip distances are long, and

travel to common origin and destinations are infrequent, public transportation providers find economically viable solutions to their problems difficult to identify and extremely costly to implement.

Rural transit agencies typically operate small fleets that provide service to these sparsely settled areas. In fact, most Section 18 recipients (60 percent) serve areas with fewer than 100 persons per square mile using 8 to 15 passenger vans. In addition to service limitations associated with the size of the fleets, rural transportation must also meet the diverse needs of a broad range of users including elderly, handicapped, and financially disadvantaged individuals. The demands placed on the fleet staff by the service requirements, the various vehicle equipment requirements, and the payment systems or subsidies used to finance those services are also factors to be considered. Finally, local coordination must determine what types of transportation services can be provided to rural residents and how providers must work together on meeting the needs of their rural residents.

1.8 Commercial Vehicles, Goods Movement and Long-distance Trips

The movement of goods is critical to the economy of the United States and the rural interstate system is an essential component in the process. Rural interstates are, in essence, the arteries over which flow the goods to be distributed to citizens throughout the country. On many rural highways, 30 percent of traffic is commercial vehicles, and their numbers continue to grow. This increase is a result of many closures of rail lines that served rural communities and freight centers, such as grain elevators. In many instances rural America is inheriting the traffic from urban areas that moves within and between its' communities.

Commercial vehicle operators have identified several transportation needs associated with rural travel, such as the frequency with which they must stop at weigh stations for verification of permits, load limitation checks, and safety inspections. Every time a commercial vehicle stops at a weigh station or a border crossing, it costs the carrier money. Therefore, measures to increase the operational efficiency of the system or reduce travel delays for the commercial vehicle operators are considered of primary importance. ITS technology exists today to dramatically reduce these costs. For instance, vehicles traveling across the country often must pass through multiple tolling systems, efficiency in terms of time savings could be realized through the use of electronic payment systems on toll roads.

1.9 Diversity and Understanding

Rural areas are challenged in that there are few issues and application similarities among different locations and regions (i.e. Cape Cod, MA; Brandon, VT and Eureka, CA). This diversity challenge is further complicated by the fact that "transportation is not the hook" to bring stakeholders together, and the stakeholders typically do not have frequent opportunities to meet to develop a common vision. They also lack facilitation and oversight as provided by a metropolitan planning organization (MPO). These issues of diversity, lack of understanding of ITS benefits and the absence of a Federal process that treats rural ITS projects on a level playing field with urban ITS all contribute to the many institutional issues and delays in deployment. I believe very strongly that now is the time for U.S. DOT to step up to the plate and provide a level playing field and provide adequate resources to respond to rural transportation needs that urban areas have enjoyed over the last several years.

2. ADVANCED RURAL TRANSPORTATION SYSTEMS SUCCESS STORIES

Now, having made that last statement, I do want to recognize a number of success stories that have taken place in rural areas. In recognition of the rural issues in need of attention, the United States Department of Transportation's (U.S. DOT) Joint Program Office established the Advanced Rural Transportation Systems (ARTS) program in 1997. The ARTS Program has been defined by development tracks that categorize the various technology tools that can be utilized to address user needs in the various rural communities. The development tracks include emergency services, tourism and travel information, traffic management, rural transit and mobility, crash prevention and security, operations and maintenance, and surface transportation and weather. I would like to highlight some of the successful projects that have been implemented at the local level.

2.1 Crash Prevention and Security

The technology applications relating to this area focus on the prevention of crashes before they occur and on reducing severity when they do. Many State departments of transportation are targeting three areas of focus to address these needs: speed management, intersection collision avoidance and animal collision avoidance. To manage travel speed in mountain passes, Colorado DOT has implemented a dy-

dynamic downhill speed warning system on I-70 west of Denver, outside the Eisenhower Tunnel. The system measures truck speeds, weight, and number of axles and advises the driver of the appropriate speed. The truck speed warning system was installed on a narrow curve that has a design speed of 45 mph. The average truck speed around this curve has dropped from 66 mph to 48 mph since the installation of the warning system. The system has eliminated approximately 20 truck run-aways and 15 truck related crashes per year. California DOT has implemented a similar speed warning system for passenger cars and trucks near Redding California along I-5 in Sacramento Canyon. The system has reduced travel speed and reduced the number of accidents, and has provided California DOT an opportunity to showcase technology that can save lives.

In Maine and Virginia, the DOTs are implementing an intersection collision avoidance system that uses detectors at all approaches of an intersection to track vehicles nearing the intersection. The detectors use parameters such as the presence and speed of a vehicle to display warnings to drivers approaching both from the major and minor roads. These messages read "Cross Street Traffic Is Approaching" and "Watch Out For Cross Traffic." These systems have reduced accident experience and provided advance warning in rural areas.

A third project that can be highlighted to address crash prevention is the Animal-Vehicle Crash Mitigation Project, which involves 15 States and will demonstrate technologies to detect animals in the rights-of-way through microwave technology sensing systems and inform the drivers upstream of the encroachment. If successful, this project may help to reduce the approximately \$1 billion lost on animal-vehicle collisions each year.

2.2 Emergency Services

This area concentrates on the services provided by law enforcement, fire departments, emergency medical services, and related organizations. The organizations usually are multi-jurisdictional in nature, involve complex operations and require a great deal of coordination. Recognizing these challenges the Virginia DOT sponsored the Northern Shenandoah Valley Public Safety Initiative. The project's goals are to enhance the collection and communication of critical accident victim patient data between the on-scene emergency medical personnel and the receiving hospital through the use of hand-held portable digital assistance devices. Use of the off-the-shelf PDA's has improved patient outcome, improved on-scene, en-route and emergency room patient services, improved data collection, all in addition to incident management coordination. A similar system is being deployed in Montana too.

In Texas, the San Antonio Fire Department has utilized ITS with LifeLink. LifeLink is designed to link the ambulances located on or near San Antonio's freeway system with a hospital in the City. Each ambulance is equipped with videoconferencing hardware and software to provide 2-way video and voice between the ambulance and an ER or trauma physician at the hospital. The equipment can also send vital signs and cardiac data to the hospital. These technologies are designed to assist with the issues associated with the golden hour to save lives. The city of Tucson and the State of Nebraska are implementing a similar system, too.

2.3 Tourism and Traveler Information

As stated previously, tourism supports the economic viability of rural communities with approximately \$500 billion annually. This technology application area focuses on the core infrastructure to provide information and data exchange between organizations and the traveler. Examples of successful projects include the deployment of traveler information systems (kiosks, highway advisory radio, variable message signs, internet sites) in tourist locations such as in Flagstaff, Arizona along I-40 near Grand Canyon National Park and Branson, Missouri where the number of annual visitors is more than one thousand times greater than the resident population.

Two unique applications of technology that have been showcased recently are the Yellowstone National Park Smart Pass project and the Oregon DOT Travel Time Estimation project. As you know, our National Parks are experiencing increasing visitation and traffic congestion. The Yellowstone National Park Smart Pass will provide frequent users and local residents with an electronic pass and a designated lane at entrance gates to bypass congestion. The Oregon DOT Travel Time Estimation project will provide ODOT with the ability to collect travel-time data on U.S. 39/101, a high volume recreation corridor, through license plate "capture" technology. The license plate can be captured along the route and be used as a "probe" to determine if incidents have taken place. The license plate image is scrambled and discarded after use and to avoid privacy issues.

2.4 Traffic Management

This area of application focuses on technologies to control operations as well as provide guidance and warning of traffic to improve travel on roadways. As in the area of emergency services, coordination is the key to success. Three examples of success are the Duluth Transportation Operations and Communication Center, for jointly managing transportation with other organizations, the Arizona DOT Highway Closure Restriction System, and the Oregon DOT TripCheck for developing virtual applications to collecting and disseminating information to multiple organizations to manage traffic. At the Duluth Transportation Operations and Communication Center, MinnDOT jointly manages the transportation system with State police and transit organizations to provide seamless transportation services. In order to provide for decentralized information collection and dissemination, the Arizona DOT and Oregon DOT utilize the internet whereby organizations can enter road closure, lane restrictions, unsafe road conditions, and parking information into the system and all agencies can view the status of those conditions. The ODOT TripCheck system includes images from closed circuit cameras at mountain passes and other locations and is directed predominantly at DOT staff, but the information can be viewed by the general public, too. During the peak usage the number of users have exceeded 350,000 per month.

2.5 Rural Transit and Mobility

This area focuses on increasing access to transportation for those who are mobility impaired through transit/para-transit services. As stated previously, providing mobility service to vast geographic areas is difficult from the perspective of cost effectiveness and communications infrastructure. One project that has accomplished this is the global positioning system project in Ottumwa, Iowa for the Ottumwa Transit Authority. The OTA provides public transit service in southern Iowa that includes Ottumwa, and the surrounding 10 counties. The service area is a very large, low-density rural area of 5000 square miles, and 149,000 people. To overcome communication coverage the OTA had to create a communications backbone to support the gathering and distributing of data over such a broad geographic distance. This was accomplished by establishing a 4-tower radio network. Using space on existing towers strategically located throughout the area at the furthest points enabled OTA to eliminate "black holes" in communication between buses and the office. Data is gathered at these 4 tower sites, and transmitted to a central location in Ottumwa. Via microwave link, the data is transmitted between the central tower and the central office (dispatch). This network has successfully enabled OTA to track each vehicle and provide electronic messages between the office and buses.

2.6 Operations and Maintenance

This development track focuses on improving the efficiency and capabilities of service to maintain and operate our transportation system. Because resources are more scarce and distances greater than urban areas, the ability to operate and maintain transportation infrastructure and the roadway system is paramount. Example projects include the operation of automated anti-/de-icing of bridges, and advanced technology for snowplows and agency vehicle monitoring. The Automated Anti-/De-Icing on Bridges enables the remote application of anti-icing and de-icing chemicals to the roadway. The system uses atmospheric and pavement sensors to provide early warning of changing conditions. When weather conditions reach certain criteria, the application of chemicals is automatically performed. The system reports to maintenance personnel when the chemicals have been applied. The maintenance personnel also can call the system using a cellular phone to override the sensors and activate the chemical application. A second example is the application of technologies to winter maintenance activities to monitor snowplow fleets, spreading applications, and vehicle collision warning and route guidance. The Iowa, Michigan and Minnesota DOTs are utilizing technology to monitor agency vehicles (e.g. chemical applications, vehicle location, plow up/down, etc.) at to a central point. In California and Arizona, the State DOTs have instrumented snowplows and the mountain pass roadways with technologies to allow for vehicle tracking in the roadway for lane guidance and collision avoidance systems to warn motorists of close proximity. In California and Arizona, the snowplow operators were surveyed and the systems were found to increase their safety, productivity and efficiency.

2.7 Surface Transportation and Weather

This development area focuses on improved weather information systems and maintenance technologies for all types of weather conditions. Accurate road and weather information can mean the difference between life and death.

Example projects include the Greater Yellowstone Weather and Traveler Information System and the U.S. DOT Field Operation Test called FORETELL. The Greater Yellowstone Weather and Traveler Information System will develop and integrate the SAFE-PASSAGE mountain pass pavement temperature prediction model, and a road and weather condition information system that delivers trip-specific weather forecast and road reports via cellular telephone by dialing #SAFE in North Dakota, South Dakota, Minnesota and soon Montana and Nebraska. The #SAFE system will provide road and weather information 40 to 60 miles (or 1-1½ hours travel time) ahead of the direction of travel. The #SAFE system has been used by over 300,000 motorists, with a monthly average of 16,000 per month and the median use of the system is 25 times per year, mostly in the winter. A recent survey found that 94 percent of the users of the system found it beneficial.

The second project, FORETELL, is also a multi-state public-private partnership which brings together all available weather data sources, including satellites, radars, and surface sites including National Weather Service Department of Defense, aviation and conventional DOT road-weather information stations to create nowcasts and forecasts. The FORETELL project is initially targeted as an internet maintenance management tool but later will be expanded to provide traveler information. The States involved in the FHWA project include Iowa, Missouri, Maine, New Hampshire and Vermont.

3. WHAT ARE THE FUTURE NEEDS?

While there have been success stories as highlighted by my previous testimony there are some very real gaps and opportunities that must be addressed. To date, U.S. DOT has predominantly concentrated on urban ITS and discounted the need to address rural challenges in any realistic programmatic level. To quote one DOT Chief Engineer, "the highest use is not necessarily the highest need." Prevailing attitudes must change if rural challenges are to be addressed. The time to address rural needs has arrived and we need Federal leadership and commitment. The following recommendations are proposed from rural ITS constituents around the country including myself.

3.1 Conduct Outreach and Professional Capability Building Seminars

Rural stakeholders have little understanding or conceptualization of how advanced technologies can impact their daily lives; the phrase "ITS" is unknown to most organizations beyond DOTs. In fact, because ITS has been so frequently described as a congestion management tool, the word "ITS" is best not used in a rural environment because of the images that may come to mind. While outreach has occurred it has only taken place as a result of various national leaders in the field, and not any planned Federal initiative. In the last year a variety of outreach materials (e.g. ITS America's State-of-the-ARTS document, Rural ITS Toolbox, ARTS CD Outreach Presentation materials, incorporating rural needs into the National Architecture, Guidance document) have been developed that can be used to perform outreach and training to rural stakeholders. Given that Federal dollars to develop Early Deployment Plans were only available to urban areas with populations over 50,000 and guidelines exist that regionally significant projects need to develop regional architecture, there should be a commitment to provide outreach and training in rural areas more than at just a statewide level. Also, it is important that these outreach and professional capability building activities occur in rural communities where stakeholders live rather than large urban centers.

3.2 Integrate Funding and Increase Awareness

In attempting to develop a rural ITS project one learns quickly that Federal and State agencies are only concerned about their individual mission rather than the crosscutting solutions. In essence, each agency is "stove-piped" in their perspective and funding. Also, Federal and State agencies are not aware of respective funding opportunities to advise rural constituents. The process to initiate a project from the Federal level is the same no matter the dollar amount. While these issues may appear inconsequential they are the very real institutional barriers that inhibit ITS deployment.

Rural areas have challenges that are aligned to more than just the departments of transportation missions, including agencies such as agriculture, health and human services, public safety, tele-communications, tourism, and more. To integrate funding and increase awareness of opportunities, it is recommended that a blue-ribbon committee be formed to create a one-stop shopping process or even a clearinghouse, develop an awareness program for rural funding opportunities, review the project initiation approval process, and determine if a block-grant approach may be more feasible for ITS deployment that would horizontally cut-across Federal agen-

cies. In fact a model for this effort already exists at Federal Lands Highway Program with the award-winning *www.recreation.gov* website. This website received honors including the National Performance Review Hammer Award, Government Executive magazine “best Feds on the web” award, and Trailblazer award by E-Gov 2001 as outstanding example of government best practice.

3.3 Improve Communications Coverage to Provide a Basic Level of Detection, Increased Safety and Reduced Deployment Cost

Communication coverage is critical to achieve a level of detection on rural highways to improve safety and lower installation deployment costs. Currently, the times to detect, respond, and provide service at an incident is typically twice that of an urban area. If we are to manage our rural roadways in a safe and prudent manner then some level of basic infrastructure to detect problems and a communication system to transmit that data must be created and funded. Critical to the basic level of detection needed is a communication backbone.

Second, the vision of Public Law 106–81 is to encourage and facilitate the prompt deployment throughout the United States of a seamless, ubiquitous, and reliable end-to-end infrastructure for communications, including wireless communications, to meet the Nation’s public safety and other communication needs. Nowhere in America does the congressional intent of the Wireless Communications and Public Safety Act of 1999 hold more promise than in rural States. Rural States record less than 25 percent of the 17 million annual car accidents but these collisions result in 60 percent of all fatalities. Twenty-five thousand Americans die each year on our rural highways because the promise of the technology has yet to be fully realized. Emergency medical personnel refer to the time immediately following a crash as the “Golden Minutes and Golden Hour.” It is estimated that 40 percent of all 911 call are cellular based. Given that rural America has large pockets of “dead zones” (no cellular wireless service), a new or improved model will need to be developed to increase communications coverage. This new model may be similar to the Rural Utility Service but at a minimum it may require a Federal subsidization for private carriers that cannot achieve the return on investment that the high volume urban subscriber models deliver. If ITS deployment is going to be achieved and a “seamless” transportation system envisioned then communication coverage must be addressed in rural America.

Third, by providing the communication coverage (wireless/wireline) the installation cost of ITS deployment will be reduced thereby allowing an increased number of solutions. As previously highlighted in the Washington DOT example of 30 miles communication cable for one closed circuit television camera, it is unrealistic to have this as the norm.

3.4 Develop Regional Projects and Partnerships

Travelers do not see the jurisdictional State boundaries as they plan or complete trips, nor do they care, and yet most ITS projects are developed with only a single State in mind. While there are a handful of truly regional scale initiatives such as the Greater Yellowstone project (Montana, Wyoming, Idaho), California—Oregon Advanced Transportation System, CANAMEX Corridor (Canada, Montana, Idaho, Nevada, Arizona, Mexico), I–95 Corridor Coalition, Gary-Milwaukee-Chicago Corridor, they are limited. Regional scale projects focused on the travel sheds that motorists use need to address a national system and to encourage public-private partnerships to develop the economies of scale needed to minimize risk.

3.5 Implement Regional Servers for Data and Information Exchange Between Stakeholder Groups

Central to any architecture developed for rural projects across the country is the need and ability to exchange data and information. Many States are implementing internet based solutions and developing virtual “traffic management centers” because they realize a decentralized information collection and dissemination process that includes all stakeholder groups (transit, tourism, public safety, fleet managers, National Parks, Native Americans) is more critical to manage the transportation system in rural America. To accelerate the ability to exchange data and information to provide for communication, cooperation and coordination, funds should be allocated to implement regional “internet” based servers throughout the 50 States.

3.6 Increase Research Funding and Provide for More Adaptive Standards

Because the majority of deployment has been done as a result of State lead efforts rather than Federal, and because State DOT’s tend to be more concerned about implementation than evaluation (or they intuitively know the benefits), there has been only a marginal amount of research as to the quantified benefits of rural ITS. If ITS is to be accepted by rural communities and eventually mainstreamed as a viable

solution, the benefits of ITS applications need to be known before considering more traditional measures (e.g. widening the road versus dynamic speed warning system). Funding for research, specifically targeted for rural ITS, should be set aside to allow for a more robust evaluation of current and planned deployment.

Standards are developed to allow for ITS deployment interoperability. While this is a general goal that everyone can agree with, many in the rural community feel that it should be accelerated and that there should be flexibility to allow for a rural needs to be addressed and not a “one size fits all” mentality that is aligned with the requirement of larger urban center requirements.

3.7 Create a Rural Model Deployment Initiative

To date, the majority of rural ITS planning and deployment has been the initiative of individual States. If the U.S. DOT truly wants to take a leadership role, then an opportunity I recommend would be to create a Rural Model Deployment Initiative similar to the Metropolitan Model Deployment Initiative, but concentrated on a more regional/rural scale as discussed previously. It should be noted that Rural Model Deployment Initiative can be similar to the Metropolitan Model Deployment Initiative, but it will fail if one attempts to take the applications from urban and just apply them to rural. This new Initiative may need to be more cross-cutting in determining how technology can assist several organizations in performing their day-to-day activities rather than just one organization. An example may include the use of Automatic Vehicle Location systems for the combined needs of transit, maintenance fleets, public safety fleets, and ambulances.

3.8 Build on Successful Tourism Partnerships to Create Jobs

Tourism is the economic engine of rural America! To allow ITS to be more effective the focus and attention toward tourism partners that may ultimately be the implementers of ITS must be increased to spur economic activity and create jobs. It should be noted that at this time while traveler information systems have been found effective in providing information, it is unknown to what extent they contribute to increase economic activity, but it appears plausible.

In closing, while there are isolated success stories that can be highlighted, there are still many challenges yet to be addressed. In keeping to the rural spirit, the Subcommittee and U.S. DOT have an opportunity to be “pioneers” in making a renewed rural ITS commitment. As we like to say in the West—Our forefathers were pioneers, not settlers!

