

OPTIONS FOR HUBBLE SCIENCE

HEARING BEFORE THE COMMITTEE ON SCIENCE HOUSE OF REPRESENTATIVES ONE HUNDRED NINTH CONGRESS

FIRST SESSION

FEBRUARY 2, 2005

Serial No. 109-2

Printed for the use of the Committee on Science



Available via the World Wide Web: <http://www.house.gov/science>

U.S. GOVERNMENT PRINTING OFFICE

98-396PS

WASHINGTON : 2005

For sale by the Superintendent of Documents, U.S. Government Printing Office
Internet: bookstore.gpo.gov Phone: toll free (866) 512-1800; DC area (202) 512-1800
Fax: (202) 512-2250 Mail: Stop SSOP, Washington, DC 20402-0001

COMMITTEE ON SCIENCE

HON. SHERWOOD L. BOEHLERT, New York, *Chairman*

RALPH M. HALL, Texas	BART GORDON, Tennessee
LAMAR S. SMITH, Texas	JERRY F. COSTELLO, Illinois
CURT WELDON, Pennsylvania	EDDIE BERNICE JOHNSON, Texas
DANA ROHRBACHER, California	LYNN C. WOOLSEY, California
KEN CALVERT, California	DARLENE HOOLEY, Oregon
ROSCOE G. BARTLETT, Maryland	MARK UDALL, Colorado
VERNON J. EHLERS, Michigan	DAVID WU, Oregon
GIL GUTKNECHT, Minnesota	MICHAEL M. HONDA, California
FRANK D. LUCAS, Oklahoma	BRAD MILLER, North Carolina
JUDY BIGGERT, Illinois	LINCOLN DAVIS, Tennessee
WAYNE T. GILCHREST, Maryland	RUSS CARNAHAN, Missouri
W. TODD AKIN, Missouri	DANIEL LIPINSKI, Illinois
TIMOTHY V. JOHNSON, Illinois	SHEILA JACKSON LEE, Texas
J. RANDY FORBES, Virginia	ZOE LOFGREN, California
JO BONNER, Alabama	BRAD SHERMAN, California
TOM FEENEY, Florida	BRIAN BAIRD, Washington
BOB INGLIS, South Carolina	JIM MATHESON, Utah
DAVE G. REICHERT, Washington	JIM COSTA, California
MICHAEL E. SODREL, Indiana	AL GREEN, Texas
JOHN J.H. "JOE" SCHWARZ, Michigan	CHARLIE MELANCON, Louisiana
MICHAEL T. MCCAUL, Texas	VACANCY
VACANCY	
VACANCY	

CONTENTS

February 2, 2005

Witness List	Page 2
Hearing Charter	3

Opening Statements

Statement by Representative Sherwood L. Boehlert, Chairman, Committee on Science, U.S. House of Representatives	17
Written Statement	18
Statement by Representative Bart Gordon, Ranking Minority Member, Committee on Science, U.S. House of Representatives	19
Written Statement	20
Statement by Representative Ken Calvert, Chairman, Subcommittee on Space and Aeronautics, Committee on Science, U.S. House of Representatives	21
Written Statement	22
Prepared Statement by Representative Jerry F. Costello, Member, Committee on Science, U.S. House of Representatives	23
Prepared Statement by Representative Eddie Bernice Johnson, Member, Committee on Science, U.S. House of Representatives	23
Prepared Statement by Representative Mark Udall, Member, Committee on Science, U.S. House of Representatives	24
Prepared Statement by Representative Russ Carnahan, Member, Committee on Science, U.S. House of Representatives	24
Prepared Statement by Representative Sheila Jackson Lee, Member, Committee on Science, U.S. House of Representatives	24

Witnesses:

Gary P. Pulliam, Vice President, Civil and Commercial Operations, The Aerospace Corporation	
Oral Statement	26
Written Statement	28
Biography	41
Dr. Louis J. Lanzerotti, Chair, Committee on Assessment of Options to Extend the Life of the Hubble Space Telescope, National Research Council, The National Academies; accompanied by General Charles F. Bolden, Jr. (Ret.), Senior Vice President at TechTrans International, INC., and Joseph H. Rothenberg, President and Member, Board of Directors, Universal Space Network	
Oral Statement	41
Written Statement	44
Biography	49
Financial Disclosure	50
Dr. Joseph H. Taylor, Jr., Co-Chair, Astronomy and Astrophysics Survey Committee, National Research Council, The National Academies	
Oral Statement	53
Written Statement	54
Biography	57
Dr. Steven V.W. Beckwith, Director, Space Telescope Science Institute	
Oral Statement	57
Written Statement	58

IV

	Page
Dr. Steven V.W. Beckwith, Director, Space Telescope Science Institute—Continued	
Biography	63
Dr. Paul Cooper, General Manager, MDA Space Missions	
Oral Statement	63
Written Statement	66
Biography	88
Dr. Colin A. Norman, Professor of Physics and Astronomy, Johns Hopkins University	
Oral Statement	88
Written Statement	90
Biography	101
Discussion	
Webb versus Hubble	101
Cost and Schedule of a Robotic Servicing Mission	102
A Hubble Servicing Mission’s Effect on Other Science Missions	105
The Cost of a Shuttle Servicing Mission	109
The Rehosting Option	112
The Manifesting of a Shuttle Servicing Mission	114
Rehosting Continued	115
Risk and a Shuttle Servicing Mission	116
Shuttle Servicing Options	119
The Hubble Space Telescope’s Projected Life Expectancy	120
Cost of Rehosting	120
The Hubble Space Telescope and Dark Energy	121
Aerospace Corporation Analysis Assumptions versus Reality Regarding a Robotic Servicing Mission	122
Value of a Robotic Servicing Mission to Exploration	123
Safe Haven and a Shuttle Servicing Mission	124
The “Science Gap” and Rehosting	126
Safety	128
Hubble Servicing and Its Relation to Exploration	129

Appendix 1: Answers to Post-Hearing Questions

Dr. Louis J. Lanzerotti, Chair, Committee on Assessment of Options to Extend the Life of the Hubble Space Telescope, National Research Council, The National Academies	134
Dr. Joseph H. Taylor, Jr., Co-Chair, Astronomy and Astrophysics Survey Committee, National Research Council, The National Academies	139
Dr. Steven V.W. Beckwith, Director, Space Telescope Science Institute	141
Dr. Paul Cooper, General Manager, MDA Space Missions	144
Dr. Colin A. Norman, Professor of Physics and Astronomy, Johns Hopkins University	148

Appendix 2: Additional Material for the Record

Statement by the Institute of Electrical and Electronics Engineers—United States of America (IEEE–USA)	150
--	-----

OPTIONS FOR HUBBLE SCIENCE

WEDNESDAY, FEBRUARY 2, 2005

HOUSE OF REPRESENTATIVES,
COMMITTEE ON SCIENCE,
Washington, DC.

The Committee met, pursuant to call, at 10:03 a.m., in Room 2318 of the Rayburn House Office Building, Hon. Sherwood L. Boehlert [Chairman of the Committee] presiding.

**COMMITTEE ON SCIENCE
U.S. HOUSE OF REPRESENTATIVES
WASHINGTON, DC 20515**

Hearing on

Options for Hubble Science

February 2, 2005
10:00 a.m. – 12:00 a.m.
2318 Rayburn House Office Building

WITNESS LIST

Mr. Gary Pulliam
Vice President for Civil and Commercial Operations
Aerospace Corporation

Dr. Lou Lanzerotti
Chair
Committee on the Assessment of Options for Extending the Life of the Hubble Space Telescope

Dr. Steve Beckwith
Director
Space Telescope Science Institute
and
Professor of Physics and Astronomy
Johns Hopkins University

Dr. Paul Cooper
Vice President and Deputy General Manager
MD Robotics

Dr. Colin Norman
Professor of Physics and Astronomy
Johns Hopkins University

Dr. Joseph Taylor
Professor of Physics
Princeton University

Section 210 of the Congressional Accountability Act of 1995 applies the rights and protections covered under the Americans with Disabilities Act of 1990 to the United States Congress. Accordingly, the Committee on Science strives to accommodate/meet the needs of those requiring special assistance. If you need special accommodation, please contact the Committee on Science in advance of the scheduled event (3 days requested) at (202) 225-6371 or FAX (202) 225-0891.
Should you need Committee materials in alternative formats, please contact the Committee as noted above.

HEARING CHARTER

**COMMITTEE ON SCIENCE
U.S. HOUSE OF REPRESENTATIVES****Options for Hubble Science**WEDNESDAY, FEBRUARY 2, 2005
10:00 A.M.—12:00 P.M.
2318 RAYBURN HOUSE OFFICE BUILDING**1. Purpose and General Background**

On Wednesday, February 2, the Committee on Science will hold a hearing to examine the options for the future of the Hubble Space Telescope.

Launched in 1990, the Hubble is, according to the National Academy of Sciences, “arguably the most powerful single optical astronomical facility ever built” and “a uniquely powerful observing platform” that has made “profound contributions” to the human understanding of the universe.

The Hubble was designed at a time (before the 1986 *Challenger* accident) when it was assumed that the Space Shuttle would be used regularly to launch and service satellites. As a result, the Hubble was launched by the Shuttle (rather than by an expendable rocket) and was designed to require periodic servicing by astronauts to remain aloft and functioning. Four missions have serviced the Shuttle (including one that was not originally planned to correct a flaw in the Hubble’s mirror). A fifth and final mission was scheduled for 2004 both to replace the batteries and gyroscopes the Hubble needs to continue to function and to add new scientific equipment. (That scientific equipment has already been built and is at the Goddard Space Flight Center in Maryland.) Without servicing, the Hubble will cease functioning as early as 2007 when the batteries run low; the exact timing is uncertain.

The demise of the Space Shuttle *Columbia* in February 2003 necessitated a change in the plans for the Hubble. At the very least, the loss of the *Columbia* meant a significant delay in Hubble servicing. (The Shuttle will not return to flight earlier than May 2005 and has a backlog of missions to construct and service the International Space Station (ISS).) But last January, NASA Administrator Sean O’Keefe ruled out any servicing mission, announcing that the Shuttle would no longer fly to destinations other than the ISS, citing safety concerns. That decision appeared to doom the Hubble.

But the Hubble was given a new lease on life, when, responding to a public outcry and pressure from Congress, NASA proposed last year to develop a robot to perform the necessary servicing. NASA also contracted with the National Academy of Sciences to review its decision.

In December, the Academy issued a report that took issue with every aspect of the NASA approach and recommended a Shuttle servicing mission. The Academy concluded that the likelihood of NASA’s robotic plan succeeding was “remote.” The Academy also found that a Shuttle sent to the Hubble faced risks similar to those faced by a Shuttle sent to the International Space Station. (NASA plans to send the Shuttle to the Space Station as many as 30 more times.)

Two additional studies funded by NASA, one performed internally and the other performed by The Aerospace Corporation, similarly concluded that a robotic mission to service the Hubble would not be ready in time to save the Hubble before its batteries died. (The Aerospace Corporation is a Federally Funded Research and Development Center that works primarily for the Air Force.)

The Aerospace Corporation additionally found that a new telescope built from the instruments NASA originally planned to install on the Hubble would provide the greatest value to NASA in terms of risk and cost. NASA has received a proposal, known as the Hubble Origins Probe, to build such a telescope from the instruments that already exist at Goddard and some additional new equipment.

Recent press reports have suggested that in its Fiscal Year (FY) 2006 budget request, the Administration plans to cancel the robotic mission to service the Hubble, presumably because of the costs and uncertainty about success, once again dooming the telescope.

This hearing will help the Committee prepare for the debate over Hubble that will come to a head once the budget request is released Feb. 7. There are basically four

options available with regard to the Hubble, each of which is discussed in greater detail later in this charter and in Attachment A:

- Do not service the telescope. The telescope will then cease to function as early as 2007. NASA does have other space telescopes in orbit and others are planned to be launched in 2011, but none has the same capabilities as Hubble.
- Send the Shuttle to service the telescope. Like any Shuttle mission, this would put astronauts at risk. It would also delay completion of the ISS.
- Send a robotic mission to service the telescope. The studies mentioned above have raised grave doubts as to whether this mission could be ready in time. The contractor designing the robot takes issue with those studies.
- Launch a new “platform” with the equipment that was designed to be added to the Hubble (this is sometimes called “rehosting”) and perhaps include new equipment as well (the proposed “Hubble Origins Probe” or HOP). This would leave a gap in Hubble science, as the new platform would probably not be ready until after the Hubble stopped operating.

All of these options raise questions about cost as well as risk. But arguably (see below), they all cost in the range of \$2 billion to complete. Any option, therefore, raises questions about whether Hubble servicing is a high enough priority to proceed even if it would take funds away from NASA’s other science plans and its exploration mission.

Finally, regardless of which option is chosen, NASA will have to send a robot up to the Hubble around 2013 to de-orbit it. Otherwise, the telescope will re-enter the Earth’s atmosphere uncontrolled, potentially causing death and destruction upon landing. Designing a robot for de-orbiting the Hubble is much less complicated than designing one to service the telescope, and much more time is available for the project as the Hubble is not expected to fall out of orbit for many years.

2. Overarching Questions

The Committee plans to explore the following overarching questions at the hearing:

1. How important are the contributions that would be expected from extending the life of the Hubble Space Telescope to the continued advancement of our understanding of the cosmos?
2. What are the comparative costs, strengths, and weaknesses of a Shuttle servicing mission, a robotic servicing mission, and a mission to fly elements of a Hubble servicing mission rehosted on a new telescope?
3. Should either a Hubble servicing mission (whether by robot or by Shuttle) or a new Hubble-based telescope be a higher priority for funding than other astronomical programs at NASA?

3. Witnesses

Mr. Gary Pulliam is Vice President for Civil and Commercial Operations, Aerospace Corporation.

Dr. Lou Lanzerotti was Chair of the National Academy of Sciences study on the Hubble, known officially as the Committee on the Assessment of Options for Extending the Life of the Hubble Space Telescope. Dr. Lanzerotti is a Professor of solar-terrestrial research at the New Jersey Institute of Technology and a consultant to Bell Labs and Lucent Technologies.

Dr. Steve Beckwith is Director of the Space Telescope Science Institute and a Professor of physics and astronomy at the Johns Hopkins University. The Institute manages the Hubble Space Telescope on behalf of NASA.

Dr. Paul Cooper is Vice President and Deputy General Manager of MD Robotics, the company building the arm for the robotic servicing mission to repair the Hubble.

Dr. Colin Norman is a Professor in the Department of Physics and Astronomy at the Johns Hopkins University, and the lead scientist on the proposal to build the Hubble Origins Probe.

Dr. Joseph Taylor is a Nobel Laureate and Distinguished Professor of Physics at Princeton University. In 2001 Dr. Taylor served as a Co-chair of the National Academy of Science’s “decadal survey,” the document that recommended priorities for astronomy and astrophysics missions in this decade. The survey is prepared by the

Academy's Astronomy and Astrophysics Survey Committee. Dr. Taylor also served on the Academy's Hubble Committee that was chaired by Dr. Lanzerotti.

4. Issues

These are some of the questions that need to be evaluated in deciding what to do about the Hubble:

- **How important is it to have the Hubble Telescope's life extended and its capabilities enhanced?** Every ten years astronomers come together under the aegis of the National Academy of Sciences to survey their field and develop a list of priority research questions to be pursued and funded by NASA (the "decadal survey"). The most recent decadal survey, released in 2001, assumed that Hubble would be serviced in 2004 and be available to scientists until around 2010. Some of the priority projects were expected to work in conjunction with Hubble. It is unclear how the priorities in the decadal survey would shift if Hubble servicing were canceled, or if servicing (by Shuttle or robot) were to take funds from other planned science missions. It is also unclear where a project like HOP would rank among the options for astronomy.
- **How much time does NASA have to send a mission to the Hubble before it can no longer be rescued?** When the Hubble's batteries will run too low to protect the telescope from the frigid temperatures of space cannot be predicted precisely. The National Academy of Sciences' Hubble report projected that the batteries would most likely run low by May 2009. The Aerospace Corporation reached similar conclusions. The ability of the Hubble to perform science is likely to erode sooner, mostly likely in April 2008, according to the Academy. NASA could extend the life of the batteries somewhat by putting the telescope into a "dormant" mode in anticipation of a servicing mission. Any servicing mission that arrived after the batteries ran down would be pointless.
- **How much time would a robotic mission to service Hubble take to develop?** Predicting how long a complex space mission will take to develop is fraught with uncertainty. The Aerospace Corporation estimated that a mission to service the Hubble robotically would not be ready to launch for at least 65 months, or 5.4 years, too late to rescue the Hubble telescope. NASA claims, however, that its robotic mission will be ready in only 39 months, or 3.25 years.

The crux of the dispute is the question of how novel a Hubble robotic mission would be. NASA and MD Robotics point out that the "arm" the robot would use has already been developed and used by the Shuttle. Skeptics argue that the "arm" has not been used for an analogous mission and rendezvousing with the Hubble gently enough to avoid damaging it will be tricky.

- **How much time would a Shuttle mission to service Hubble take to prepare for?** NASA has estimated that it would take 31 months to prepare a Shuttle mission to Hubble, which includes crew training and having a backup Shuttle available for any rescue mission (a new approach in the wake of the *Columbia* accident). The Academy concluded that the latest a Shuttle mission to Hubble could launch and still save the telescope was May 2009.
- **Where would the funding come from to pay for a servicing mission to Hubble?** Past Hubble servicing missions have been paid out of the Shuttle program's budget. Since the last Shuttle was sent to the Hubble in 2002, NASA has adopted a new bookkeeping method in which each program must pay for activities that benefit it, even if those activities are carried out by another program. Under this "full cost accounting" methodology, NASA's Science Directorate might be expected to pay for all or part of a Shuttle mission to service the Hubble. In the meantime, the funding for the robotic servicing mission—contracts have already been let to design the robot—is being split between NASA's Science Directorate, in which the Hubble program resides, and the Exploration Directorate, which hopes to benefit from the robotic technology that the Hubble mission would develop. (The Exploration Directorate is charged with developing new technology for the President's proposal to return humans to the Moon.) If money for Hubble servicing started eating into other planned science projects, support for a Hubble servicing mission in the science community might erode.

- **How much would a servicing mission to Hubble cost? Which mission provides the highest value?** According to The Aerospace Corporation, the total cost of a robotic servicing mission would be roughly \$2 billion. NASA estimated the cost at \$1.3 billion. The initial contracts for the robotic mission have come in at less than Aerospace had estimated, but some of those contracts allow for cost escalation as the project continues.

According to NASA, the cost of a Shuttle servicing mission to Hubble would cost a similar amount, \$2.2 billion. This is basically NASA's estimate of the cost of any Shuttle flight, not an estimate of costs unique to a Hubble mission. Aerospace did not conduct an independent estimate of the cost of a Shuttle servicing mission. The Government Accountability Office has said it cannot verify NASA's estimates of Shuttle costs.

The Aerospace Corporation found that a simple "rehosting" option—sending up just the instruments already built to be added to Hubble—would also cost about the same amount, roughly \$2 billion. Proponents of HOP, which would include additional equipment, claim that their proposal would cost about \$1.5 billion.

The Omnibus Appropriations Bill for FY05 that the President signed in December specifically included \$291 million to begin work on the robotic servicing mission, which would be expected to launch in FY07. According to its latest Operating Plan, NASA plans to allocate \$175 million to the project in FY05.

- **Would a Shuttle flight to Hubble be riskier than one to the International Space Station?** The NASA Administrator has said that his decision not to send Shuttle to the Hubble was based in large part on his belief that astronauts would face a greater risk on such a mission compared to a mission to the International Space Station. NASA has never provided any data to back up that assertion but it appears to be based on the assumption that the ISS can act as a "safe haven" in the event that a problem with the Shuttle is discovered during a mission. (Shuttles sent to the Hubble cannot reach the ISS.) Some critics have charged that the Shuttle mission to Hubble was scrapped solely to accelerate the construction of the ISS. The National Academy of Sciences found that the difference in risk between a single mission to Hubble and a mission to the Space Station is "very small." Furthermore, the Academy pointed out that NASA plans to send the Shuttle to the Space Station 25 to 30 more times. The probability of another accident occurring in 30 flights can be calculated to be greater than 40 percent if the past accident rate of the Shuttle (two in 113 flights) is used to predict future reliability. In addition, some experts have argued that proposed missions to the Moon and Mars are likely to pose much greater risks to astronauts than a Shuttle mission to the Hubble.

5. Background

The Hubble Space Telescope:

The Hubble Space Telescope (HST) was launched from the Space Shuttle *Discovery* in 1990 and has operated continuously in orbit for the past 14 years. The Hubble was originally designed for a 15-year mission, but until recently NASA intended to extend its operations through 2010. The telescope was designed to be serviced by astronauts, and a series of four Shuttle servicing missions, the last flown in 2002, have replaced nearly all of the key components except the original telescope mirrors and support structures. Three of the four servicing missions added major new instruments, boosting the telescope's observing capabilities.

HST is one of the most powerful optical astronomical telescopes ever built. It was designed to make observations in the visible, ultraviolet, and near-infrared wavelength portions of the spectrum, and its orbit above the Earth's blurring atmosphere provides an unobscured and undistorted view of the Universe.

In its report, the Academy cited as the Hubble's primary scientific achievements:

- Direct observation of the universe as it existed 12 billion years ago;
- Measurements that helped to establish the size and age of the universe;
- Discovery of massive black holes at the center of many galaxies;
- Key evidence that the expansion of the universe is accelerating, which can be explained only by the existence of a fundamentally new type of energy and therefore new physics; and
- Observation of proto-solar systems in the process of formation.

Prior to the *Columbia* Shuttle accident, NASA had scheduled a servicing mission (SM-4) slated for 2004 to replace the batteries, gyroscopes and fine guidance sensors, all of which are showing signs of failure. SM-4 was also to install new thermal blankets and two new science instruments, the Wide Field Camera 3 (WFC3) and the Cosmic Origins Spectrograph (COS). The Shuttle would also have raised Hubble's orbit. After performing these repairs and new instruments, NASA expected the Hubble would continue to operate for another three to five years.

Hubble is not the only space-based astronomical observatory, though it is only one that operates in optical wavelengths. The Spitzer Space Telescope, which NASA launched in August 2003, has a 2.5-year mission and is designed to observe in the infrared portion of the spectrum. NASA launched the Chandra X-ray Observatory in July 1999. While Chandra had only a five-year mission, it has been operating past its planned lifetime and continues to perform well today. The next telescope mission, scheduled for launch in 2011, is the James Webb Space Telescope (JWST). It will observe in the infrared portion of the spectrum using the largest mirror (six meter diameter) ever flown in space. (As all of these telescopes were designed after 1986, none relies on the Shuttle for launch or requires servicing.) Scientists greatly value the ability to do complementary observations using any or all of these active telescopes, peering at the same target at the same time. When the Hubble operations cease, there will be no other space-based optical telescope available.

The Columbia Accident Investigation Board:

Following the *Columbia* accident in February 2003, NASA appointed the *Columbia* Accident Investigation Board (CAIB) to investigate the accident. The CAIB's report included 15 Return-To-Flight (RTF) recommendations that it said should be completed prior to NASA resuming Shuttle flights, and an additional 14 recommendations to assure continued safe operation.

At times, NASA has argued that its decision to cancel the Shuttle mission to Hubble was the only option available in light of the CAIB report. And the CAIB did make some distinctions between missions to the ISS and other missions.

The clearest example is in its recommendation 6.4-1, which states in part, "For non-Station missions, develop a comprehensive autonomous (independent of Station) inspection and repair capability to cover the widest possible range of damage scenarios." NASA has not developed that capability. But at the request of Senator Barbara Mikulski of Maryland, Admiral Harold Gehman, the Chairman of the CAIB, clarified the recommendation.

In a March 2004 letter, Gehman said that risk to the Shuttle needed to be reviewed in light of all of CAIB's recommendations, not just a single recommendation, and he said the wording of the specific recommendation for non-Station missions meant "do the best you can." He said non-ISS missions "may be slightly more risky" than missions to the ISS. Admiral Gehman said that the CAIB had taken no position on the feasibility of a Hubble mission and that all Shuttle missions posed risks. He concluded, "I suggest only a deep and rich study of the entire gain/risk equation can answer the question of whether an extension of the life of the wonderful Hubble telescope is worth the risks involved, and that is beyond the scope of this letter." Gehman's response was one impetus for the Academy study.

The Academy Report:

NASA commissioned the National Academy of Sciences study in the spring of 2004, in response to Congressional requests and shortly after initiating efforts to study the feasibility of a robotic servicing mission. NASA asked the National Academy of Sciences to assess "the viability of a Space Shuttle servicing mission" that would satisfy all of the CAIB's and NASA's own additional safety recommendations. The Academy was also asked to consider the viability of a robotic servicing mission.

The Academy's panel, *The Committee on the Assessment of Options for Extending the Life of the Hubble Space Telescope* (the full charter and a list of committee members are attached), made three recommendations:

1. That NASA should commit to a servicing mission to the Hubble Space Telescope that accomplishes the objectives of the originally planned SM-4 mission.
2. That NASA should send the Shuttle to service the Hubble as soon as possible.
3. That a robotic mission approach should be pursued solely to de-orbit Hubble after its mission is completed.

The Academy expressed strong doubts about the likely success of NASA's plans for a robotic servicing mission, stating: "Based on extensive analysis, the committee concluded that the very aggressive schedule for development of a viable robotic serv-

icing mission, the commitment to development of individual elements with incomplete systems engineering, the complexity of the mission design, the current low level of technology maturity, the magnitude of the risk-reduction efforts required, and the inability of a robotic servicing mission to respond to unforeseen failures that may well occur on Hubble between now and the mission, together make it unlikely that NASA will be able to extend the service life of HST through robotic servicing.”

Robotics experts at NASA and its contractors dispute the Academy’s characterization of the overall level of technical maturity of the robotic mission’s components. For instance, they argue that the Shuttle’s robotic arm (on which the robotic arm for the servicing mission will be based) has suffered no mission failures in 25 years of use. They also contend that the Academy’s assessment of robotics risk is out of date since it is based on information and site visits that occurred during late spring/early summer 2004. Developments since then, they say, have eliminated many of the risks.

In recommending that NASA conduct a servicing mission with the Shuttle, the Academy suggested that to minimize risk, NASA should prepare to use two Shuttles—one to fly to Hubble, and the second to sit at the ready on an adjacent launch facility to be used as a rescue vehicle should the first suffer damage that precludes a safe return. This was based on a rescue scenario outlined in the CAIB report.

NASA argues that this proposal is not feasible because it would increase the cost of the mission, further disrupt the schedule for completing the International Space Station, and put additional crew at risk as the rescue mission would be unprecedented. Any rescue mission would have to be launched quickly (within 17–30 days, depending on how much emergency power was available on the Shuttle). Astronauts would have to be transferred in space from one Shuttle to another, a task NASA views as without precedent. However, the Academy report found that spacewalks “for transferring the crew from a damaged vehicle on a Shuttle HST flight, although complex, are well within the experience base of the Shuttle program.”

The Aerospace Corporation Report:

The Academy panel relied heavily on a study produced by The Aerospace Corporation that analyzed a variety of alternative methods for extending the life of Hubble. The report was requested, and paid for, by NASA as an analysis of alternatives (AoA).

Aerospace used a “blank sheet of paper” approach that considered generic options rather than any specific pending proposal. As a result, it did not review the specific robotics work underway for the Hubble mission, which was only in an early stage when the Aerospace study was done in any event. (The Aerospace Report was completed in August, 2004.) Aerospace also did not review NASA’s cost or schedule estimates for the Shuttle, but simply accepted them as a baseline.

Aerospace was not charged with recommending a specific alternative, but only with ranking their relative costs and benefits. Key findings of the Aerospace study include:

- Robotic servicing alternatives, based on estimated development schedules, are susceptible to arriving too late when Hubble is no longer in a serviceable state. Furthermore, they undertake unprecedented servicing operations and are subject to an aging observatory that may fail for some other reason following servicing.
- Rehost alternatives are lower risk with similar cost to the robotic servicing missions, but may result in a two- to seven-year science gap.
- SM-4 has costs in the same range as the rehost and robotic servicing alternatives, has higher probability of mission success than the robotic servicing missions, and does not suffer from the gap in science associated with rehost alternatives.
- Other means to perform astronaut servicing with reduced risk such as launching a safe haven or relocating Hubble to the vicinity of the International Space Station are more costly and take longer to develop than SM-4.

Aerospace Analysis of Alternatives – Summary of HST Servicing Study Results

	Life Cycle Cost (FY04 \$B)	Nominal Development Time (years)	Development Risk	Mission Risk
Shuttle Servicing Mission SM-4	\$2.2	2.6	Medium	Medium
Robotic Servicing Mission	\$2.0	5.4	High	High
De-orbit Mission (no life extension)	\$0.4	4.2	Low	Low
Rehosting SM- 4 on a Free Flyer	\$2.0	8.4	Low	Low

(Aerospace Corporation defines “Development Risk” for a servicing mission as the risk that the mission can be developed in time to reach the Hubble before irreparable damage occurs. Aerospace defines “Mission Risk” for a servicing mission as the risk that every element of the mission will succeed as planned and the telescope will continue to operate for another three years after being serviced.)

6. Recent Developments

NASA continues to work on a robotic servicing mission, for which the FY05 Omnibus Appropriations bill provided \$291 million. Of this amount, NASA plans to spend \$175 million through Preliminary Design Review, scheduled for late March—the stage at which a decision is normally made as to whether to carry on with a project. Another critical stage in the program’s development, the Critical Design Review, is tentatively scheduled for this September.

NASA recently let contracts valued at \$330 million to Lockheed Martin to begin development work on a spacecraft that could be used for either a robotic servicing mission or a comparatively simple robotic de-orbiting mission. A contract valued at \$153 million was let to MD Robotics, a subsidiary of the Canadian firm MacDonald Dettwiler, to develop the robotic arm that would perform any servicing. The company built the existing Shuttle robotic arm.

7. Questions Asked of the Witnesses

Witnesses invited to appear before the Committee were asked to address the following questions in their testimony:

Mr. Gary Pulliam

1. Please summarize the findings of your report to NASA analyzing the agency’s alternatives in servicing the Hubble Space Telescope. In particular please explain the comparative strengths and weaknesses of a Shuttle servicing mission, a robotic servicing mission, and a mission to fly elements of a Hubble serving mission rehosted on a new telescope.
2. How confident are you of your cost estimates for each of the options?

Dr. Lou Lanzerotti, Chairman

Please explain the findings and recommendations of your panel’s assessment of options for extending the life of the Hubble Space Telescope with a particular emphasis on the following questions:

1. What is the telescope’s contribution to science and what would be lost if the telescope were not to be serviced and no replacement telescope launched?

2. What are the comparative costs, strengths, and weaknesses of a Shuttle servicing mission, a robotic servicing mission, and a mission to fly elements of a Hubble servicing mission rehosted on a new telescope?
3. How disruptive to science would it be if Hubble's new instruments were to be unavailable for a number of years? Would any of your panel's findings and recommendations change if NASA were unable to launch a Shuttle servicing mission in time to prevent a "gap" in Hubble science?
4. How would you personally, or on behalf of the Committee, evaluate a free flyer (rehosting) instead of a servicing mission?

Dr. Steve Beckwith

1. How important are the contributions that would be expected from extending the life of the Hubble Space Telescope when compared to advancements expected from other astronomical programs at NASA to be launched in the next decade, such as the James Webb Space Telescope?
2. What are the comparative strengths and weaknesses of a Shuttle servicing mission, a robotic servicing mission, and a mission to fly elements of a Hubble servicing mission rehosted on a new telescope?
3. Should either a Hubble servicing mission (whether by robot or by Shuttle) or a new telescope as the Hubble Origins Probe be a higher priority for funding than other astronomical programs at NASA?

Dr. Paul Cooper, General Manager

Please describe the robotic mission to service the Hubble Space Telescope that you are helping to develop for NASA with particular emphasis on the following questions:

1. To what extent do you agree or disagree with the assessment by The Aerospace Corporation of a robotic servicing mission?
2. What are the costs, strengths, and weaknesses of the robotic servicing mission, compared to a Shuttle servicing mission and a mission to fly elements of a Hubble servicing mission rehosted on a new telescope?

Dr. Colin Norman

Please briefly describe your proposal for NASA to build and fly a new telescope called the Hubble Origins Probe with particular emphasis on the following questions:

1. How, if at all, does your proposal differ from those analyzed by The Aerospace Corporation?
2. What contributions could your proposed telescope make to science compared to those that could be made by the Hubble if it were serviced by either the Shuttle or a robotic servicing mission?
3. What are the comparative costs, strengths, and weaknesses of your proposal, a Shuttle servicing mission and a robotic servicing mission?

Dr. Joseph H. Taylor, Jr.

1. To what extent, and in what ways, was the Decadal Survey premised on the Hubble Space Telescope having additional instruments that were to be added by a servicing mission? Would the loss of the Hubble cause you to entirely rethink your priorities? Would that change if the Hubble Origins Probe or a similar rehost mission is launched?
2. How important are the contributions that would be expected from extending the life of the Hubble Space Telescope when compared to advancements expected from other astronomical programs at NASA to be launched in the next decade, such as the James Webb Space Telescope?
3. Should either a Hubble servicing mission (whether by robot or by Shuttle) or a new telescope as the Hubble Origins Probe be a higher priority for funding than other astronomical programs at NASA?

Attachment A**Comparison of Servicing Mission Options**
(Prepared by Science Committee Staff)

	Advantages	Disadvantages
Shuttle Servicing Mission	<ul style="list-style-type: none"> • Astronauts able to deal with unforeseen problems • Shortest development schedule • Demonstrated experience of four previous servicing missions 	<ul style="list-style-type: none"> • Safety Risk to Astronauts • Delay completion of ISS • Unknown cost and complexity to ready a second "rescue" shuttle • Shuttle-to-shuttle transfer of astronauts if rescue mission is launched • Unbudgeted cost to NASA
Robotic Servicing Mission	<ul style="list-style-type: none"> • No safety risk to astronauts • Develop and test robotic technologies for future robotic exploration missions 	<ul style="list-style-type: none"> • Development and schedule risk • Limited ability to improvise repairs should unforeseen problems occur • Unbudgeted cost to NASA
Hubble Origins Probe (rehost)	<ul style="list-style-type: none"> • No safety risk to astronauts • Has superior field of view than HST • Heritage design, several instruments already built 	<ul style="list-style-type: none"> • Science gap – two years or more • Unbudgeted cost to NASA
De-Orbit Mission (no servicing)	<ul style="list-style-type: none"> • No schedule pressure. De-orbit not required before 2013. • Limited cost 	<ul style="list-style-type: none"> • No extended HST operations • Limited demonstration of robotic technologies

Attachment B**Committee on the Assessment of Options for Extending the Life of the Hubble Space Telescope**

LOUIS J. LANZEROTTI, *Chair*, Consultant, Bell Laboratories, Lucent Technologies, and New Jersey Institute of Technology
 STEVEN J. BATTEL, Battel Engineering, Scottsdale, Arizona
 CHARLES F. BOLDEN, JR., TechTrans International, Inc., Houston, Texas
 RODNEY A. BROOKS, Massachusetts Institute of Technology Computer Science and Artificial Intelligence Laboratory, Cambridge, Massachusetts
 JON H. BRYSON, The Aerospace Corporation (retired), Chantilly, Virginia
 BENJAMIN BUCHBINDER, Consultant, Bonaire, Antilles
 BERT BULKIN, Lockheed Missiles and Space (retired), Woodbridge, California
 ROBERT F. DUNN, U.S. Navy (retired); National Consortium for Aviation Mobility, Alexandria, Virginia
 SANDRA M. FABER, University of California Observatories/Lick Observatory, University of California, Santa Cruz
 B. JOHN GARRICK, Independent Consultant
 RICCARDO GIACCONI, Johns Hopkins University and Associated Universities, Inc., Washington, D.C.
 GREGORY HARBAUGH, Sun N Fun Air Museum, Lakeland, Florida
 TOMMY W. HOLLOWAY, NASA (retired), Houston, Texas
 JOHN M. KLINEBERG, Space Systems/Loral (retired), Redwood City, California
 VIJAY KUMAR, University of Pennsylvania, Philadelphia, Pennsylvania
 FORREST S. McCARTNEY, U.S. Air Force (retired), Indian Harbour Beach, Florida
 STEPHEN M. ROCK, Stanford University, Stanford, California
 JOSEPH ROTHENBERG, Universal Space Network
 JOSEPH H. TAYLOR, JR., Princeton University, Princeton, New Jersey
 ROGER E. TETRAULT, McDermott International, Inc. (retired), Punta Gorda, Florida
 RICHARD H. TRULY, U.S. Navy (retired); National Renewable Energy Laboratory, Golden, Colorado

Committee on the Assessment of Options for Extending the Life of the Hubble Space Telescope**Statement of Task**

The committee will conduct an independent assessment of options for extending the life of the Hubble Space Telescope. The study will address the following tasks:

1. Assess the viability of a Space Shuttle servicing mission that will satisfy all recommendations from the CAIB (*Columbia* Accident Investigation Board), as well as ones identified by NASA's own Return-to-Flight activities. In making this assessment, compare the risks of a space Shuttle servicing mission to HST with the risks of a Shuttle mission to the ISS and, where there are differences, describe the extent to which those differences are significant. Estimate to the extent possible the time and resources needed to overcome any unique technical or safety issues associated with HST servicing that are required to meet the CAIB recommendations, as well as those from the Stafford-Covey team.
2. Survey other available engineering options, including both on-orbit robotic intervention and optimization of ground operations, that could extend the HST lifetime.
3. Assess the response of the spacecraft to likely component failures and the resulting impact on servicing feasibility, lost science, and the ability to safely dispose of HST at the end of its service life.
4. Based upon the results of the tasks above, provide a benefit/risk assessment of whether extension of HST service life, via (a) a Shuttle servicing mission if one is deemed viable under task #1 and/or (b) a robotic servicing mission if one is deemed viable under task #2, is worth the risks involved. The assessment should include consideration of the scientific gains from different options considered and of the scientific value of HST in the larger context of ground and space-based astronomy and science more broadly. Special at-

tention should be paid to the practical implications of the limited time available for meaningful intervention robotically or via the Shuttle.

The committee is not expected to make either organization or budgetary recommendations, but it may need to consider cost as a factor in weighing the relative benefits of alternative approaches.

The committee will investigate the possibility of providing an interim report to NASA that addresses a portion of the items in the task statement in advance of delivering a full final report if such an approach is deemed feasible and able to provide early, credible answers to the questions being considered.

Committee on the Assessment of Options for Extending the Life of the Hubble Space Telescope

Recommendations

1. The committee reiterates the recommendation from its interim report that NASA should commit to a servicing mission to the Hubble Space Telescope that accomplishes the objectives of the originally planned SM-4 mission.
2. The committee recommends that NASA pursue a Shuttle servicing mission to HST that would accomplish the above stated goal. Strong consideration should be given to flying this mission as early as possible after return-to-flight.
3. A robotic mission approach should be pursued solely to de-orbit Hubble after the period of extended science operations enabled by a Shuttle astronaut servicing mission, thus allowing time for the appropriate development of the necessary robotic technology.

Findings

Chapter 3—The Impact of Hubble: Past and Future

- The Hubble telescope is a uniquely powerful observing platform because of its high angular optical resolution, broad wavelength coverage from the ultraviolet to the near infrared, low sky background, stable images, exquisite precision in flux determination, and significant field of view.
- Astronomical discoveries with Hubble from the solar system to the edge of the universe are one of the most significant intellectual achievements of the space science program.
- The scientific power of Hubble has grown enormously as a result of previous servicing missions.
- The growth in the scientific power of Hubble would continue with the installation of the two new instruments, Wide Field Camera-3 (WFC3) and the Cosmic Origins Spectrograph (COS), planned for SM-4.
- A minimum scientifically acceptable servicing mission would install batteries, gyros, WFC3, and a FGS. The installation of COS is highly desirable.
- Ground-based adaptive optics systems will not achieve Hubble's high degree of image stability or angular resolution at visible wavelengths for the foreseeable future.
- Servicing Hubble expeditiously is highly desirable.

Chapter 4—HST Observatory Assessment and Lifetime Projection

- The HST avionics system is currently in a fully operable state and retains redundancy on all subsystems. Its performance is monitored regularly and is well understood by the operations team where it is possible to credibly forecast system performance, failure trends, and replacement requirements.
- Previous human servicing missions have successfully carried out unforeseen repairs as well as executing both planned and proactive equipment and scientific upgrades. The current excellent operational status of the observatory is a product of these past efforts.
- The robotic mission plan presented by NASA accomplishes the minimum mission servicing goals of installing batteries, gyros, and scientific instruments and potentially a fine-guidance sensor, but does not install other important life-extension upgrades that were also planned for SM-4. It is also unclear whether the fine guidance sensor replacement or unforeseen repairs can be effected on a robotic mission without exceptional mission complexity and associated telescope risk.

- The HST avionics system reliability model used by NASA projects a 50 percent reliability interval of 4.5 years. Using October 2004 as a starting date, this interval establishes May 2009 as the latest approximate date for vehicle servicing with at least a 50 percent chance for success.
- The flexibility for repairing unforeseen anomalies has been demonstrated on past Shuttle servicing mission. With this flexibility, the avionics system is projected to operate with a reliability value of 0.69 at three years and 0.45 at five years in support of science operations following a Shuttle servicing mission.
- The baseline robotic mission is judged to have minimal capacity for responding to and repairing unforeseen anomalies. Assuming robotic servicing in February 2009 (based on a 5.4 year “most likely” readiness date), the system reliability is projected to be 0.41 at the time of servicing, 0.18 after three years of post-servicing science operations, and less than 0.10 at five years.
- Battery lifetime trends are consistent with supporting science operations through April 2008 and maintaining the telescope optical system in a highly protected Level-1 safe-hold state until July 2009. Loss of capability to do science due to optical failure is most likely to occur in the May 2011 timeframe but could occur as early as December 2009 based on a worst-case projection.
- If HST operations continue as they are, progressive gyroscope failures are likely to terminate observatory science operations around September 2007. Timely transition to a 2-gyro mode after software validation in the first half of 2005 could extend science operations into the mid-2008 timeframe.
- HST gyro replacement by the Shuttle is a straightforward operation that has been accomplished successfully on past servicing mission. Replacement by a robotic mission is more complex, entailing the attachment of multiple RSU and ECU elements plus interface electronics on to the WFC3 instrument. The interface to the spacecraft system is made via an external cable routed to a test interface on the telescope computer.
- FGS-2R is projected to fail in the October 2007 to October 2009 timeframe. Its replacement is important if FGS redundancy is to be retained to support post-servicing science operations. Replacement of FGS-2R is straightforward on a Shuttle mission but considered to be high risk for a robotic mission. Therefore, it is possible to retain FGS redundancy by Shuttle servicing and potentially is possible via robotic servicing.
- FGS-3 is projected to fail in the January 2010 to January 2012 timeframe although its life can potentially be extended through the near-term use of FGS-2R. Failure in this timeframe will not strongly affect post-servicing science operations if FGS-2R is replaced.
- Solar Panel performance is running according to expected trends such that sufficient power will be available to support HST science operations until at least 2014 in the case of either Shuttle or robotic servicing.
- Retention of Reaction Wheel Assembly redundancy is important to maximize the likelihood of three to five years of post-servicing HST science operations. Replacement of RWA units has been performed successfully in response to an unexpected anomaly on two previous Shuttle mission and is also possible, if required, on SM-4. Replacement of an RWA is not part of the planned robotic mission and may not be possible due to the RWA mounting locations on the telescope.
- Analysis in combination with long-term avionics monitoring predicts that radiation damage should not interfere with science operations through the 2010 timeframe. Adverse radiation effects after 2010 are more likely, with an increasing risk of avionics component failures if science operations are extended until 2014.
- The projected termination in mid to late 2007 of science operations due to gyroscope failure and the projected readiness in early 2010 to execute the planned NASA robotic mission result in a projected 29-month interruption of science operations. No interruption of science operations is projected for a realistically scheduled SM-4 Shuttle mission.
- The planned NASA robotic mission is less capable than the previously planned SM-4 mission with respect to its response to unexpected failures and its ability to perform proactive upgrades. Combined with the projected schedule for the two options, the mission risk associated with achieving at least three years of successful post-servicing science operations is significantly higher for the robotic option with the respective risk numbers at three years being approximately 30 percent for the SM-4 mission and 80 percent for the robotic mission.

Chapter 5—HST Robotic Servicing Assessment

- The technology required for the proposed HST robotic servicing mission involves a level of complexity, sophistication, and maturity that requires significant development, integration, and demonstration to reach flight readiness and has inherent risks that are inconsistent with the need to service Hubble as soon as possible.
- Technologies needed for proximity operations and autonomous rendezvous and capture have not been demonstrated in a space environment.
- The addition of targets and fiducials and a better latching system by the astronauts on the SM-4 mission will enhance the ability of the subsequently launched de-orbit module to dock with the HST and provide a more precise alignment for de-orbit.
- The control algorithms and software for lidar and camera based control of the grapple arm are mission-critical technologies that have not been flight-tested.
- Technologies needed for autonomous manipulation, disassembly and assembly, and for control of manipulators based on vision and force feedback have not been demonstrated in space.
- The Goddard Space Flight Center HST project has a long history of HST Shuttle servicing experience, but little experience with autonomous rendezvous and docking or robotic technology development, or with the operations required for the baseline HST robotic servicing mission.
- The proposed HST robotic servicing mission involves a level of complexity that is inconsistent with the current 39-month development schedule and would require an unprecedented improvement in development performance compared with that of space missions of similar complexity. The likelihood of successful development of the HST robotic servicing mission within the baseline 39-month schedule is remote.
- “*Conclusion*”: The very aggressive schedule for development of a viable robotic servicing mission, the commitment to development of individual elements with incomplete systems engineering, the complexity of the mission design, the current low level of technology maturity, the magnitude of the risk-reduction efforts required, and the inability of a robotic servicing mission to respond to unforeseen failures that may well occur on Hubble between now and the mission, together make it unlikely that NASA will be able to extend the science life of HST through robotic servicing. (page 74).
- Many of the concerns raised by the committee regarding the risk of attempting to robotically service the Hubble telescope could be mitigated for future programs through planning for robotic servicing in the initial spacecraft design.

Chapter 6—Space Shuttle Servicing of Hubble

- A complete inspection of the orbiter thermal protection system can be accomplished on a Shuttle servicing mission to HST using the SRMS (Shuttle remote manipulator system) and the SRMS/OBSS (orbiter boom sensor system).
- The orbiter thermal protection system repairs can be accomplished on a Shuttle servicing mission to HST following the development of worksite and repair techniques for ISS (International Space Station) to meet the CAIB (*Columbia* Accident Investigation Board) and NASA requirements.
- The ISS safe haven offers operational flexibility and time to adapt to real-time problems in the case of a critical ascent impact event that is both detected and repairable, or that affords the option of a Shuttle rescue mission. However, the availability of the ISS safe haven is zero-fault-tolerant, requires significant pre-positioning of supplies, and therefore, has significant risks due to its limited redundancy and margins.
- An HST Shuttle rescue mission can be ready on the second launch pad. There would be some costs and ISS schedule delays, principally because of the impact of parallel orbiter processing. Limited time would be available to execute a rescue.
- Meeting the CAIB and NASA requirements (relative to inspection and repair, safe haven, Shuttle rescue, orbital debris, and risk to the public) for a Shuttle servicing mission to HST is viable.
- The extravehicular activities (spacewalks) for transferring the crew from a damaged vehicle on a Shuttle HST flight, although complex, are well within the experience base of the Shuttle program.

- To avoid putting the Hubble at risk and to maintain continuous science operation the HST servicing mission could be flown as early as the seventh flight after return-to-flight without a critical operational impact on the ISS.
- Major HST mission preparation work for a Shuttle servicing mission to HST can be deferred until after return-to-flight. This would avoid a significant expenditure of human resources until the Shuttle is flying again.
- Compared to the total cost of flying a Shuttle flight, the resources required to overcome unique technical or safety issues involved in flying a Shuttle mission to HST are small and are well within the experience base of work done in the past to enable unique Shuttle missions.
- *“Comment”*: The committee believes that careful planning for, and implementation of, the additional HST-unique activities to meet the CAIB and NASA requirements will result in substantially lower actual costs to service the HST using the Shuttle than those projected above. [NASA estimates of \$1.7B–\$2.4B.] (Page 87).
- The Shuttle crew safety risks of a single mission to ISS and a single HST mission are similar and the relative risks are extremely small.
- In the case of every documented anomaly encountered during the conduct of extravehicular activities (EVAs) on all four HST missions, the onboard crew, in conjunction with its ground-based mission control team, worked around each anomaly and successfully completed every task planned for these missions.
- Space Shuttle crews, in conjunction with their ground-based mission control teams, have consistently developed innovative procedures and techniques to bring about desired mission success when encountering unplanned for or unexpected contingencies on-orbit.
- The risk in the mission phase of a Shuttle HST servicing mission is low.

Chapter 7—Benefit/Risk Assessment of Hubble Space Telescope Servicing Options

- Although a quantitative mission risk assessment does not exist for either a human or a robotic servicing mission to the Hubble Space Telescope, the committee’s qualitative evaluations lead it to conclude that the human servicing mission poses a low risk to mission success. Conversely, the robotic mission risk is high, considering the short time frame available for system development and testing, and the uncertainty concerning robotic performance.

Chairman BOEHLERT. The hearing will come to order. I want to welcome everyone here this morning for our hearing on the vexing question of what to do about the Hubble Space Telescope. Here is our quandary. On the one hand, everyone acknowledges that the Hubble has been a sparkling jewel in the crown of American science, but on the other, there is disagreement about how and whether to save it, and that disagreement will come to a head in the coming weeks, once the proposed budget for Fiscal 2006 is released. Regardless of whether it actually zeros out a Hubble mission, as has been widely rumored. So our goal this morning is to do our homework for the upcoming debate. We have before us leading authorities on the Hubble, representing a variety of viewpoints, and their answers to our questions will help Congress choose among the options for the Hubble: letting it die, saving it with a Shuttle mission, saving it with a robotic mission, or sending up a new version of the telescope.

I think that Congress faces three fundamental questions regarding the Hubble in today's fiscal environment. The broadest is, is Hubble—is it worth saving the Hubble even if that means taking money away from other NASA programs such as exploration? Second, and more narrowly, we need to ask is it worth saving the Hubble even if that means taking money away from other NASA science programs? And finally, if the answer to either of those questions is yes, then we need to ask what is the best way to save the Hubble, or at least its science, in terms of costs and risk? I come to today's hearing as an agnostic on all three questions. The first question on my list, about the priority of Hubble in relation to other NASA programs, is in some ways beyond the scope of today's hearing, but what we will hear today will help us evaluate it. As I said, I don't have a view on that right now, but let me reiterate that I think all aspects of space science and Earth science need to be viewed as continuing priorities for NASA, even as the Exploration Initiative moves forward. If the ultimate payoff of exploration is a changed view of the world and of the universe, then science like that performed by Hubble certainly is a model of exploration.

We will get some answers today to the second question on my list, about Hubble's relation to other science priorities. Astronomy is a model for other fields in its creation of a consensus list of priorities for every decade. Dr. Taylor, in his written testimony, gives a remarkably clear and straightforward answer to our question about science priorities, and let me thank you, Dr. Taylor. I will be very interested to hear our other witnesses comment on his thoughts.

Finally, on the narrow question of how, rather than whether to save the Hubble, I am also eager to hear our witnesses interact today. I am especially eager to hear Dr. Lanzerotti's response to Mr. Cooper's testimony about the feasibility of robotics, and Dr. Norman's responses to Dr. Lanzerotti's testimony about the viability of "rehosting" the Hubble instruments. So, I hope we can clarify today what is at stake in upcoming Hubble debate.

I would dearly love to save the telescope. It has outperformed everyone's fondest hopes, and has become a kind of mascot for science, maybe even for our planet. One can't help but root for it.

I will always remember when Sean O’Keefe and I were having lunch in the Member’s dining room one day last year, and one of the waiters came up to him, and said: “Save the Hubble.” And I didn’t put him up to it. But this can’t be an emotional decision or one based on what we would do in an alternative universe that lacked fiscal constraints or uncertainty.

We have to make hard choices about whether a Hubble mission is worth it now, when moving ahead is likely to have an adverse impact on other programs, including quite possibly other programs in astronomy. The whole matter is, as I said at the outset, vexing. I hope that by the end of this hearing, I will be better prepared to help make those hard choices.

[The prepared statement of Chairman Boehlert follows:]

PREPARED STATEMENT OF CHAIRMAN SHERWOOD L. BOEHLERT

I want to welcome everyone here this morning for our hearing on the vexing question of what to do about the Hubble Space Telescope. Here’s our quandary: On the one hand everyone acknowledges that the Hubble has been a sparkling jewel in the crown of American science, but on the other there is disagreement about how and whether to save it. And that disagreement will come to a head in the coming weeks once the proposed budget for fiscal 2006 is released—regardless of whether it actually zeros out a Hubble mission, as has been widely rumored.

So our goal this morning is to do our homework for the upcoming debate. We have before us leading authorities on the Hubble, representing a variety of viewpoints. And their answers to our questions will help Congress choose among the options for the Hubble—letting it die, saving it with a Shuttle mission, saving it with a robotic mission, or sending up a new version of the telescope.

I think that Congress faces three fundamental questions regarding the Hubble in today’s fiscal environment. The broadest is: Is it worth saving the Hubble even if that means taking money away from other NASA programs such as exploration? Second, and more narrowly, we need to ask: Is it worth saving the Hubble even if that means taking money away from other NASA science programs? And finally, if the answer to either of those questions is yes, then we need to ask: What’s the best way to save the Hubble (or at least its science) in terms of cost and risk.

I come to today’s hearing as an agnostic on all three questions.

The first question on my list—about the priority of Hubble in relation to other NASA programs—is in some ways beyond the scope of today’s hearing, but what we hear today will help us evaluate it. As I said, I don’t have a view on that now. But let me reiterate that I think all aspects of space science and Earth science need to be viewed as continuing priorities for NASA even as the exploration initiative moves forward.

If the ultimate payoff of exploration is a changed view of the world and of the universe, then science like that performed by Hubble certainly is a model of exploration.

We will get some answers today to the second question on my list—about Hubble’s relation to other science priorities. Astronomy is a model for other fields in its creation of a consensus list of priorities for every decade. Dr. Taylor in his written testimony gives a remarkably clear and straightforward answer to our question about science priorities. I will be very interested to hear our other witnesses comment on his thoughts.

Finally, on the narrow question of how (rather than whether) to save the Hubble, I am also eager to hear our witnesses interact today. I am especially eager to hear Dr. Lanzerotti’s responses to Mr. Cooper’s testimony about the feasibility of robotics, and Dr. Norman’s responses to Dr. Lanzerotti’s testimony about the viability of “rehosting” the Hubble instruments.

So, I hope we can clarify today what’s at stake in upcoming Hubble debate. I would dearly love to save the telescope. It has outperformed everyone’s fondest hopes and has become a kind of mascot for science, maybe even for our planet. One can’t help but root for it.

I’ll always remember when Sean O’Keefe and I were having lunch in the Member’s Dining Room one day last year, and one of the waiters came up to him and said, “Save that Hubble!” And I had not put him up to it.

But this can’t be an emotional decision or one based on what we would do in an alternative universe that lacked fiscal constraints or uncertainty. We have to make

hard choices about whether a Hubble mission is worth it now, when moving ahead is likely to have an adverse impact on other programs, including quite possibly other programs in astronomy. The whole matter is, as I said at the outset, vexing. I hope that by the end of this hearing, I'll be better prepared to make those hard choices.

Mr. Gordon.

Mr. GORDON. Good morning, and I would like to join the Chairman in welcoming the witnesses to today's hearing.

We have important—an important issue to address this morning, namely, the future of the Hubble Space Telescope. The Hubble Space Telescope has been one of the world's premier scientific instruments for more than a decade. Observations made by Hubble have greatly expanded our knowledge of the universe, and continue to rewrite the textbook in astronomy.

Thus, it was a surprise to me when NASA Administrator last year cancelled the long-planned mission to service and upgrade the Hubble telescope. That cancellation led to a large outcry from both scientists and the public at large, and I guess even a few waiters in the House dining room. And through the efforts of Senators and Representatives of both parties, including our own Representative, Mark Udall, NASA became aware of the intense Congressional interest in the future of Hubble.

As a result, the NASA Administrator asked the National Academies to undertake a review of the options for extending the life of the Hubble Space Telescope, as well as whether it makes sense for—from a scientific standpoint to do so. The National Academies accepted the challenge, and assembled a very distinguished committee to conduct the review. They delivered their report last year, and Dr. Lanzerotti, the Chairman of the Committee, will present their findings and recommendations today.

I must say that I was very impressed with both the quality and the clarity of the Committee's report. The Committee worked its way through a very complex set of issues, and wound up issuing a very clear set of findings and recommendations. Dr. Lanzerotti and his Committee, as well as the National Academies' staff, deserve our thanks for a job well done.

And at this point, I think the burden of proof has to be placed on anyone who would differ markedly from their conclusions. In that regard, I am disappointed that NASA was not invited to today's hearing. I think we need to hear how NASA views the National Academies report, and how it plans to respond to its recommendations. For example, the National Academies Committee concluded that, and I quote: "The Shuttle crew safety risk of a single mission to ISS and a single HST mission are similar, and the relative risks are extremely small." Does NASA agree or disagree with that conclusion, or for that matter, how would NASA compare the risk of having astronauts service Hubble with the risk of sending astronauts back to the surface of the Moon, and how would it compare the benefits?

In addition, there are concerns within the scientific community that funding a Hubble service mission would force deep cuts in other planned space science initiatives. However, when I asked NASA Administrator O'Keefe to answer for the record whether the Shuttle-related costs of the SM4 Hubble Servicing Mission would have to come out of the scientific budget, his response was as follows, and I quote: "This long-planned servicing mission is consid-

ered grandfathered—grandfathered in. Under this policy and the projected budget for the mission was included—in the five year budget run-out under the Office of Space Flight.” Where did the money go? And is NASA management now planning to walk away from an earlier budgetary commitment to the NASA science program on the allocation of the Hubble servicing cost?

These questions take on increased importance in the current budgetary environment. We have all heard reports that the funding for the servicing Hubble would not be in NASA’s FY 2006 budget request in order to free up money for other initiatives, such as the President’s Exploration Initiative. We will know within a week whether or not these reports are accurate. If they are, and I think this Congress will need to take a hard look at the priorities behind such a cut. While I support human exploration beyond low-Earth orbit, I want the Administration to make sure that it is adequately paid for, and not funded by simply canceling or cutting other important activities in NASA non-exploration science and technology accounts.

Mr. Chairman, this morning’s hearing will be this House Committee’s first hearing on space issues in the 109th Congress. I am confident it will not be the last. There are a whole host of issues related to NASA and the Nation’s space and aeronautics program that need Congress’ attention. I look forward to working with you and the rest of the Committee to address those issues.

And in closing, I would like to once again welcome our witnesses, and I look forward to their testimony.

[The prepared statement of Mr. Gordon follows:]

PREPARED STATEMENT OF REPRESENTATIVE BART GORDON

Good morning. I’d like to join the Chairman in welcoming the witnesses to today’s hearing. We have an important issue to address at this morning’s hearing—namely, the future of the Hubble Space Telescope.

The Hubble Space Telescope has been one of the world’s premier scientific instruments for more than a decade. Observations made with Hubble have greatly expanded our knowledge of the universe—and continue to rewrite the textbooks in astronomy!

Thus, it was a surprise to many when the NASA Administrator last year canceled the long-planned mission to service and upgrade the Hubble telescope. That cancellation led to a large outcry from both scientists and the public at large. And through the efforts of Senators and Representatives of both parties, including our own Rep. Mark Udall, NASA became aware of the intense congressional interest in the future of Hubble.

As a result, the NASA Administrator asked the National Academies to undertake a review of the options for extending the life of the Hubble Space Telescope—as well as whether it made sense from a scientific standpoint to do so. The National Academies accepted the challenge, and it assembled a very distinguished committee to conduct the review. They delivered their report late last year, and Dr. Lanzerotti, the Chair of that committee, will present their findings and recommendations today.

I must say that I was very impressed with both the quality and the clarity of the committee’s report. The committee worked its way through a very complex set of issues and wound up issuing a very clear set of findings and recommendations. Dr. Lanzerotti and his committee, as well as the National Academies staff, deserve our thanks for a job well done.

At this point, I think that the burden of proof has to be placed on anyone who would differ markedly with their conclusions. In that regard, I am disappointed that NASA was not invited to today’s hearing.

I think we need to hear how NASA views the National Academies report, and how it plans to respond to its recommendations. For example, the National Academies committee concluded that:

“The Shuttle crew safety risks of a single mission to ISS and a single HST mission are similar and the relative risks are extremely small.”

Does NASA agree or disagree with that conclusion? Or for that matter, how would NASA compare the risks of having astronauts service Hubble with the risks of sending astronauts back to the surface of the Moon? And how would it compare the benefits?

In addition, there are concerns within the scientific community that funding a Hubble servicing mission would force deep cuts in other planned space science initiatives. However, when I asked NASA Administrator O’Keefe several years ago to answer for the record whether the Shuttle-related costs of the SM-4 Hubble servicing mission would have to come out of the science budget, his response was as follows:

“This long-planned servicing mission is considered ‘grandfathered in’ under this policy, and the projected budget for the mission was included in the five-year budget runout under the Office of Space Flight.”

[Source: Record of 2/27/02 Hearing with NASA Administrator O’Keefe, p. 166]

Where did that money go? And is NASA management now planning to walk away from its earlier budgetary commitment to the NASA science program on the allocation of Hubble servicing costs? These questions take on increased importance in the current budgetary environment.

We have all heard reports that funding for servicing Hubble will not be in NASA’s FY 2006 budget request in order to free up money for other activities, such as the President’s exploration initiative. We will know within a week whether or not those reports are accurate. If they are, I think that this Congress will need to take a hard look at the priorities behind such a cut.

While I support human exploration beyond low-Earth orbit, I want the Administration to make sure that it is adequately paid for and not funded by simply canceling or cutting other important activities in NASA’s non-exploration science and technology accounts.

Mr. Chairman, this morning’s hearing will be the Science Committee’s first hearing on a space issue in the 109th Congress. I am confident that it will not be the last—there are a whole host of issues related to NASA and the Nation’s space and aeronautics programs that need Congress’s attention. I look forward to working with you and the rest of the Committee to address those issues.

In closing, I’d again like to welcome our witnesses, and I look forward to your testimony. Thank you.

Chairman BOEHLERT. Thank you very much, Mr. Gordon, and just let me tell you. We intentionally did not invite NASA for two basic reasons. One, they are unlikely to say anything much of substance in advance of the release of the budget, and secondly, we wanted to hear about hearing all the options, not about Administration policy, and so that is what this hearing is designed to do, expose us to the various options.

With that, let me proudly introduce the new Chairman of the Subcommittee on Space and Aeronautics, Mr. Calvert of California.

Mr. CALVERT. Thank you, Mr. Chairman, for holding today’s hearing on the future of the Hubble Space Telescope. There is no doubt that the Hubble is a national treasure, extraordinary scientific instrument. It opened up our eyes and has dazzled us with images of galaxies, stars, and planets. The Hubble has also fundamentally changed our understanding of the universe, and forced scientists to rethink many of their own theories. Thanks to Hubble, we have caught glimpses of black holes. We have watched comets slam into Jupiter. We have seen stars born and stars die. These are just a few examples of Hubble’s accomplishments.

Not since Galileo first peered into the looking glass nearly 400 years ago has a single telescope made such a difference in the way we see the heavens. Now, I am all—sure that we all agree that Hubble is great, but I suspect there may be differing opinions on

what should be done going forward. The Hubble's life is limited. The window of opportunity to service it is narrow, and the costs and risks for servicing a mission are significant. It is valuable to understand and weigh the options which may extend the Hubble Space Telescope's useful lifespan. It is essential that we fully understand the comparative costs, strengths and weaknesses, of a Shuttle servicing mission, a robotic servicing mission, and a mission to fly elements of a Hubble servicing mission rehosted on a new telescope. In addition, an open and healthy debate about how a Hubble servicing mission, whether by robot or by Shuttle, should be prioritized against funding for other astronomy programs at NASA is welcome.

While the Hubble amazing journey will some day, eventually, come to an end, it will not end the story, just as Galileo's looking glass wasn't the last telescope, the next chapter will feature bigger, better, and more capable observatories, which will provide even more amazing discoveries.

Again, thank you, Mr. Chairman, for assembling this outstanding panel. I look forward to their testimony. I look forward to working with my colleagues on the Committee and addressing the Hubble Space Telescope and other important issues in the 109th Congress. I thank you for the opportunity you gave me. I want to apologize in advance. I must leave around 11:15 to attend a Steering Committee, which will be deciding how the appropriations side of this process is going to work, and so, that is also important, so—but I look forward to being fully briefed on this after the hearing.

Thank you, Mr. Chairman.

[The prepared statement of Mr. Calvert follows:]

PREPARED STATEMENT OF REPRESENTATIVE KEN CALVERT

Mr. Chairman, thank you for holding today's hearing on the future of the Hubble Space Telescope. There is no doubt that the Hubble is a national treasure and an extraordinary scientific instrument. It has literally opened our eyes to the Universe and dazzled us with images of galaxies, stars, and planets. The Hubble has also fundamentally changed our understanding of the Universe, and forced scientists to re-think many of their theories. Thanks to Hubble, we've caught glimpses of black holes, we've watched comets slam into Jupiter, we've seen stars being born and stars die, and these are but a few examples of Hubble's accomplishments. Not since Galileo first peered into his looking glass nearly 400 years ago has a single telescope made such a difference in the way we see the heavens.

Now, I'm sure we all agree that the Hubble is great, but I suspect there may be differing opinions on what should be done going forward. The Hubble's life is limited, the window of opportunity to service it is narrow, and the costs and risks for a servicing mission are significant. It is valuable to understand and weigh the options which may extend the Hubble space telescope's useful lifespan. It is essential that we fully understand the comparative costs, strengths, and weaknesses of a Shuttle servicing mission, a robotic servicing mission, and a mission to fly elements of a Hubble servicing mission placed on a new telescope. In addition, an open and healthy debate about how a Hubble servicing mission, whether by robot or by Shuttle, should be prioritized against funding for other astronomy programs at NASA is welcome.

While the Hubble's amazing journey will some day eventually come to an end, it will not be the end of the story, just as Galileo's looking glass wasn't the last telescope. The next chapter will feature bigger, better, and more capable observatories which will provide even more amazing discoveries.

Thank you, Mr. Chairman for assembling this outstanding panel. I look forward to their testimony, and I look forward to working with my colleagues on the Committee in addressing the Hubble Space Telescope and other important issues in the 109th Congress.

Now I want to apologize at the outset for not being able to stay for the entirety of today's hearing as I have important and requisite work to attend to as a Member of the House Steering Committee. I do look forward to getting briefed on the full debate from today's proceedings at a later time.

Chairman BOEHLERT. Thank you very much, Chairman Calvert.
[The prepared statement of Mr. Costello follows:]

PREPARED STATEMENT OF REPRESENTATIVE JERRY F. COSTELLO

Good morning. I want to thank the witnesses for appearing before our committee to examine the options for the future of the Hubble Space Telescope.

This committee is privileged to have jurisdiction over our space programs because we have the opportunity to consider funding requests to develop new capabilities for exploration on behalf of all Americans. We strive to involve all Americans in our efforts by sharing publicly in our challenges and our successes. Working in collaboration with NASA, The Aerospace Corporation, the National Academy of Sciences, scientists, and other space industries, it is important that this committee understands the contributions and expectations for continued funding for the Hubble Space Telescope. In order to ensure tax-payer dollars are being spent wisely, it is imperative that we continually evaluate and assess the effectiveness of our space programs and servicing missions. Thus, we need to listen to the recommendations and positions from our experts in the field.

I am aware that Members of the science community are concerned that a servicing mission to Hubble might come at the expense of other planned projects within NASA's science program if the science office had to absorb all the costs of a servicing mission.

I am pleased the Committee is having this hearing today because it will help us prepare for future hearings once the Administration's budget request is released next week. I am aware of the possibility that a robotic mission to service the Hubble Space Telescope may be dropped from the Fiscal Year 2006 budget. With four options available to determine the course in which the Hubble Telescope will be funded, it is critical we examine each proposal very carefully.

I look forward to hearing the testimony from our panel of witnesses.

[The prepared statement of Ms. Johnson follows:]

PREPARED STATEMENT OF REPRESENTATIVE EDDIE BERNICE JOHNSON

Thank you, Chairman Boehlert. I thank the Chairman for calling this very important meeting. In addition, I would like to thank our distinguished group of witnesses for agreeing to testify here today on Options for the Hubble Telescope.

The space exploration research program has been one of the most successful research programs in the history of this country. Because of it, our nation benefited many lifesaving medical tests, accessibility advances for the physically challenged, and products that make our lives more safe and enjoyable.

The Hubble Space Telescope is a national asset. Scientists all over the world use the orbiting observatory to get a view of the universe that they can't get any other way. This telescope has already made major contributions to the science of astronomy.

However, on Saturday, Jan. 17 2004, NASA announced they will not send a scheduled servicing team to the Hubble Space Telescope, and instead will crash this great scientific instrument into the ocean in 2008.

NASA, now strapped for funding, will not make the scheduled 2006 Shuttle to repair failing gyroscopes and batteries.

The resulting void created by not scheduling badly needed repairs to the Hubble leaves many questions about how we will continue our space exploration and observation programs.

I pledge to do what I can to help our space program so these important endeavors can be achieved and the space program can flourish in the future. As a Senior member of the Science Committee, I will work closely with my House colleagues to assist NASA in meeting their goals.

I am a firm believer that the United States will continue our space program that has accomplished so much in the areas of research and science.

[The prepared statement of Mr. Udall follows:]

PREPARED STATEMENT OF REPRESENTATIVE MARK UDALL

I'm glad to have this opportunity to express my strong support for keeping Hubble alive and for making it more productive than it has ever been.

We all remember when Administrator O'Keefe first announced the cancellation of the Hubble servicing mission. There was a tremendous outcry from the academic community and scientists worldwide, as well as from the general public.

Congress also expressed great concern and fought the Administrator's decision. A resolution I introduced last year urging NASA to appoint an independent panel of experts to review options for carrying out the servicing mission drew 77 co-sponsors. So I was pleased when Administrator O'Keefe saw the value in Hubble's future scientific productivity and decided to look into a number of servicing options. Congress backed him on the decision to keep Hubble alive, providing nearly \$300 million in FY05 for a repair mission.

In my view, the best news of last year for Hubble was when the National Research Council report called it 'the most powerful astronomical facility ever built,' and recommended that NASA commit to a Shuttle servicing mission to Hubble, one that would accomplish the objectives planned for the original mission, including the installation of the two new instruments.

So it was with great concern that I learned about NASA's plans to zero out funding for a repair mission in FY06. After all that we have learned from the Hubble assessment report and all that we know about Hubble's potential to produce even more spectacular science for years to come, it is incomprehensible to me that this Administration would so hastily ignore the panel's scientific recommendations and shut down the planned repair mission.

It is unfortunate that we don't have a NASA witness on the panel, but I look forward to hearing from all the witnesses today about how they view Hubble's future. In particular, I'd like to express my appreciation to Dr. Lanzerotti and the other members of the Hubble assessment panel for the hard work and careful analysis that went into their report. I'd also like to thank Steve Beckwith for his dedication to Hubble and for all that he does to help produce its amazing science and imagery.

[The prepared statement of Mr. Carnahan follows:]

PREPARED STATEMENT OF REPRESENTATIVE RUSS CARNAHAN

Mr. Chairman, thank you for bringing us together today with this superb panel of witnesses to examine the quandary of what to do with the Hubble Space Telescope (HST). I am honored to sit with you for the first time during my tenure as a Member of the House of Representatives and I look forward to serving the third Congressional district of Missouri on the Committee on Science.

The Hubble Space Telescope has opened the eyes of astronomers and the public alike to faraway galaxies, new discoveries in the field of astrophysics and never seen before imagery.

Today, we will hear about the options available for coping with the upcoming Hubble battery failure, which is anticipated to be as early as 2007. Various advocates propose the following four options: not service the station (which requires that we still de-orbit Hubble); send an astronaut-manned Shuttle to service the station; send a robotic mission to service the station; or launch a new spacecraft and integrate portions of the existing telescope into the new one. I come to this hearing with no particular preconceived notions about which option is preferable.

In the future, we will have important decisions to make about the Hubble Space Telescope's relative worth to the scientific field, the financial cost of various options, human safety involved in a potential Shuttle mission, and the reliability of a robotic mission. I look forward to hearing the testimony of the panelists and hearing their counsel on how to best balance these multiple concerns while working to advance the scientific knowledge that Hubble has brought the world. Thank you.

[The prepared statement of Ms. Jackson Lee follows:]

PREPARED STATEMENT OF REPRESENTATIVE SHEILA JACKSON LEE

Chairman Boehlert, Ranking Member Gordon,

I want to thank you for organizing this important hearing on the Hubble Space Telescope. We will all have some difficult decisions to make regarding the future of the Hubble and this hearing will help to identify issues that need to be included in the debate.

First commissioned into service in 1990, the Hubble Space Telescope is by all measures an extraordinary success in terms of the contributions it has made to further our understanding of astronomy, space science, and physics. Hubble's placement above the atmosphere allows it to focus in on distant bodies free of the atmospheric interference that affects all ground based telescopes. This gives Hubble the ability to collect data in the ultraviolet and near infrared that are filtered by the atmosphere. Even at optical wavelengths, the Hubble produces images that are currently unmatched in clarity by any other telescope.

A study by the National Academies chaired by Dr. Lanzerotti reviewed the popular press and peer-reviewed publications and found that Hubble-generated data contributed to a number of astronomical 'firsts' or the experimental confirmation of previously proposed theories. Hubble currently has 1500 registered users, and request for access exceeds that available by a factor of seven.

The adage that "a picture is worth a thousand words" applies to the Hubble beyond the 19 terabytes of data already collected. The spectacular images we have all seen have no doubt inspired countless numbers of students to consider future careers in science and engineering—not just in astronomy, but in other disciplines that have contributed to the design and operation of the Hubble, such as computer science and engineering, physics, mechanical engineering, and robotics.

The operation of the Hubble originally anticipated a series of servicing missions involving astronauts and equipment transported by the Space Shuttle. Three servicing missions have been successfully and safely completed involving the replacement, repair, or upgrade of many of the key components of the original telescope. So many improvements have been made through these three previous missions that the National Academies' report describes today's Hubble as different from the telescope that was launched in 1990.

A fourth and final Shuttle servicing mission was originally scheduled for 2004–2005. After the tragic loss of the Shuttle *Columbia*, Administrator O'Keefe canceled plans for this scheduled servicing mission. The scientific community criticized this decision to abandon support for the Hubble and NASA proposed a robotic servicing mission that would perform the essential servicing tasks for the telescope's continued survival. Critical components, (e.g., batteries) are nearing their end of life, and the spacecraft will likely fail around the end of the decade without their replacement.

Without servicing, it is estimated that the Hubble's batteries and other systems will cause the irreversible deterioration of the spacecraft sometime between 2008 and 2009. Even if no repairs are made, a robotic mission will be needed around 2013 to initiate the controlled safe de-orbit of the spacecraft.

Aside from the option to forego repairs, the National Academies and The Aerospace Corporation have identified three repair scenarios, each of which is estimated to cost approximately \$2 billion. Those involve:

- Send the Shuttle to service the telescope. Like any Shuttle mission, this would put astronauts at risk. It would also delay completion of the ISS.
- Send a robotic mission to service the telescope. The studies mentioned above have raised grave doubts as to whether this mission could be ready in time. The contractor designing the robot takes issue with those studies.
- Launch a new "platform" with the equipment that was designed to be added to the Hubble (this is sometimes called "re-hosting") and perhaps include new equipment as well (the proposed "Hubble Origins Probe" or HOP). This would leave a gap in Hubble science, as the new platform would probably not be ready until after the Hubble stopped operating.

Cost estimates were reviewed by the General Accountability Office, which found NASA's justification for the lacking detail or unjustifiable.

Aside from the cost issues raised by the GAO, I am extremely concerned about the safety of all NASA missions. Administrator O'Keefe canceled future Shuttle servicing missions because such missions lack 'safe haven' access to the International Space Station. A robotic servicing mission has been proposed, but the National Academies and The Aerospace Corporation have both criticized that approach because it involves the development unproven technologies that may not be available before irreversible deterioration occurs to the Hubble.

A third option to re-host ground based Hubble components in a new telescope also has uncertainties and involves a two year period between the demise of an unserviced Hubble and the commissioning of its replacement.

Our oversight responsibilities compel us to ask the hard questions that will foster healthy debate on the issues associated with these options. It is the job for all of

us to help facilitate the continued progress in the sciences and technology in a way that does not cause unreasonable risks to our astronauts.

Chairman BOEHLERT. Today's list of very distinguished witnesses impresses even those of us who have been around here a long time, and I want to thank all of them for being resources for this committee. And I want to thank you all for your testimony submitted in advance, and as I indicated in my opening statement, Dr. Taylor, it is so refreshing to have someone do what you did in your testimony, give us some guidance on priorities. I have found through all my years on the Committee that so often, there is a reluctance to assign any priorities to anything by the scientific community, because everything is so darn important, and they are reluctant to assign a lower category to some other discipline, because there but for the grace of God go I, say the people assigning that. So, thank you very much.

Our witnesses today are Mr. Gary Pulliam, Vice President for Civil and Commercial Operation for The Aerospace Corporation; Dr. Lou Lanzerotti, Chair, Committee on the Assessment of Options for Extending the Life of the Hubble Space Telescope; Dr. Joseph Taylor, Professor of Physics, Princeton University; Dr. Steve Beckwith, Director, Space Telescope Science Institute and Professor of Physics and Astronomy at Johns Hopkins University; Dr. Paul Cooper, Vice President and Deputy General Manager, MD Robotics; and Dr. Colin Norman, Professor of Physics and Astronomy, Johns Hopkins University. Thank you all very much.

I would ask that you try to summarize your statement. The entire statement will be in the record at this juncture, in relatively five minutes or so. 300 seconds is not nearly adequate enough time to say what you want to say, but if you can summarize the statements, that will give us more of an opportunity to pick your brains, and that is what we are here—and that is what the mission is all about.

So with that, Mr. Pulliam, you are up first.

STATEMENT OF GARY P. PULLIAM, VICE PRESIDENT, CIVIL AND COMMERCIAL OPERATIONS, THE AEROSPACE CORPORATION

Mr. PULLIAM. Good morning, Mr. Chairman, to Mr. Gordon, Committee Members and staff. I am pleased to represent The Aerospace Corporation today, and to appear to you—to appear before you as you deliberate the future of the Hubble Space Telescope.

As a private, nonprofit corporation, The Aerospace Corporation has provided engineering and scientific services to government space organizations for over 40 years. We provide a stable, objective expert source of analysis. We are focused on the government's best interests, with no profit motive or predilection for any particular design or technical solution.

As our primary activity, Aerospace operates a federally-funded research and development center sponsored by the Under Secretary of the Air Force and managed by the Space and Missile Systems Center in El Segundo, California. Aerospace also undertakes projects for NASA and other civil agencies that are in the national interest and are consistent with our corporate rule.

In June 2004, Admiral Craig Steidle, the Associate Administrator for Exploration Systems, asked Aerospace to perform an analysis of alternatives for servicing options for Hubble. Today, I will briefly describe the characteristics of an analysis of alternatives, how we conducted this analysis, and our findings.

An analysis of alternatives is a formal analytical tool, which Aerospace has used on large Department of Defense space programs. An analysis of alternatives is properly used to compare alternatives, and to make broad conclusions based on analytical data. However, the analysis does not evaluate specific programs, or their execution to plans, nor does it recommend specific solutions to the problem.

For this analysis of alternatives for Hubble, we adopted our processes to NASA's needs. We involved key stakeholders in our analysis, including the Hubble program office, and the Office of Space Science Evaluation team. Our measures of effectiveness were cost, schedule, development risk, mission risk, and capability. For cost, we used life cycle cost. For the schedule measure, we used development time. Development risk is the combination of the probability that Hubble will still be in the required state for servicing, and the development time of the particular option. In other words, an important element of the evaluation of servicing options is can we get there before Hubble suffers a failure. The mission risk is the probability of mission success for any particular alternative. And finally, a capability measure is the estimation of the instrument capability compared to the baseline of Hubble, should the next Shuttle servicing mission have flown.

We combined several measures into an analysis of expected value, to examine the cost benefit of each alternative, compared with its probability of success. For this analysis, there are two important dates to consider, the need date for servicing Hubble, which we estimate to be early 2009, and the need date to de-orbit Hubble, which we estimate to be 2013.

Mr. Chairman, here are our findings. As I present them, I am mindful of the Committee's request for me to compare the strengths and weaknesses of the various approaches. First, a disposal mission is required to provide a controlled re-entry. Without this mission, Hubble would pose an unacceptable casualty risk to the population. A disposal mission does not prolong Hubble's life, nor enhance its science capabilities. Our analysis is that a de-orbit mission would cost between \$300 million and \$1.1 billion, depending on the approach taken.

Second, a combined robotic servicing and de-orbit mission would cost between \$1.3 billion and \$2.2 billion, and carries high risk, because of the time required to develop the capability, and Hubble's likely degradation or failure in 2008 or 2009. Strengths of this alternative are that it can extend Hubble's life expectancy and enhance its science capabilities. Weaknesses in this approach are the requirement to arrive at Hubble before failure, performing unprecedented robotic operations, and the fact that Hubble may fail for some other reason even after a successful servicing mission.

Third, rehosting options, meaning launching a new satellite to perform the science mission, would cost \$1.9 and \$2.3 billion. This mission is technically and programmatically feasible. The strength

is that this option does not depend on Hubble's condition. The weakness is that there would be a period of several years where we would have no science, and the new observatory might not have as robust a capability as Hubble.

Fourth, a baseline servicing Shuttle servicing mission, while not analyzed by Aerospace, may have a higher probability of success than the robotic mission. We did not analyze the strengths and weaknesses of the Shuttle servicing mission, but we did present the SM4 costs and schedule estimate as a baseline comparison. And finally, safe haven options, which might allow for astronaut servicing missions, still do not remove all of the associated risks with human space flight.

When viewed from the expected value perspective, missions such as a rehost mission score well, because the launch date is not tied to Hubble's demise. In other words, these missions have a higher probability of success, because there is no requirement to get to Hubble by 2009. Robotic missions, while providing an enhanced capability, score lower because of the aggressive development schedule required to get to Hubble before it fails, and because of the higher mission risk. And as mentioned earlier, a de-orbit mission provides no enhanced capability.

Finally, the Committee asked me to address our confidence in our study. This analysis of alternatives used proven tools and proven approaches, Aerospace's best technical experts in the field, and went through the rigorous internal review process at Aerospace. I see this as exemplary of Aerospace's finest analytic capability. However, it is important for the Committee to realize that this was an analysis of alternatives, not an examination of the programmatic of any particular program presently in development.

Our analysis was completed in August 2004. A new analysis performed today, that included an independent assessment of the progress of the development of the robotic and grapple arm would certainly refine the results, but in our opinion, would not change the basic fact that a robotic servicing mission is a challenging undertaking.

Now, Mr. Chairman, I thank the Committee for the opportunity to summarize our report, and I look forward to your questions.

[The prepared statement of Mr. Pulliam follows:]

PREPARED STATEMENT OF GARY P. PULLIAM

Mr. Chairman, distinguished Committee Members and staff:

I am pleased to have the opportunity to share with you the findings of a recent Aerospace Corporation assessment of robotic servicing alternatives for the Hubble Space Telescope. Before I begin, I would like to present an overview of Aerospace and how we came to provide this study for NASA.

The Aerospace Corporation

The Aerospace Corporation is a private, nonprofit corporation, headquartered in El Segundo, California. It was created in 1960 at the recommendation of Congress and the Secretary of the Air Force to provide research, development and advisory services to the U.S. government in the planning and acquisition of space, launch and ground systems and their related technologies. The key features of Aerospace are that we provide a stable, objective, expert source of engineering analysis and advice to the government, free from organizational conflict of interest. We are fo-

cused on the government's best interests, with no profit motive or predilection for any particular design or technical solution.

As its primary activity, Aerospace operates a Federally Funded Research and Development Center sponsored by the Under Secretary of the Air Force, and managed by the Space and Missile Systems Center in El Segundo, California. Our principal tasks are systems planning, systems engineering, integration, flight readiness verification, operations support and anomaly resolution for the DOD, Air Force, and National Security Space systems. Through our comprehensive knowledge of space systems and our sponsor's needs, our breadth of staff expertise, and our long-term, stable relationship with the DOD, we are able to integrate technical lessons learned across all military space programs and develop systems-of-systems architectures that integrate the functions of many separate space and ground systems.

The Aerospace Corporation also undertakes projects for civil agencies that are in the national interest. Such projects contribute to the common good of the Nation while broadening the knowledge base of the corporation. Aerospace has supported many NASA assessments of human and robotic space programs, addressing technical, cost and schedule risks.

Aerospace does not compete with industry for government contracts, and we do not manufacture products. The government relies on Aerospace for objective development of pre-competitive system specifications, and impartial evaluation of competing concepts and engineering hardware developments, to ensure that government procurements can meet the military user's needs in a cost-and-performance-effective manner.

Aerospace employs about 3,450 people, of whom 2,400 are scientists and engineers with expertise in all aspects of space systems engineering and technology. The professional staff includes a large majority, 74 percent, with advanced degrees, with 29 percent holding Ph.Ds. The average experience of Members of the Technical Staff (MTS) is more than 25 years. We recruit more than two-thirds of our technical staff from experienced industry sources and the rest from new graduates, university staff, other nonprofit organizations, government agencies, and internal degree programs.

In January of 2004, NASA Administrator Sean O'Keefe announced the cancellation of one last planned Space Shuttle mission to service the Hubble Space Telescope. Under pressure from Congress and the public, NASA agreed to look for alternative ways to extend Hubble's life.

Analysis of Alternatives

NASA requested that The Aerospace Corporation perform a nonadvocate assessment of Hubble Space Telescope (HST) robotic servicing alternatives. These alternatives encompassed a broad range of options in the following families: ground life extension, disposal, rehosting instrumentation on other platforms, robotic servicing, and the baseline Shuttle Servicing Mission 4 (SM-4) previously planned for 2005. In developing this Analysis of alternatives (AoA), Aerospace assessed each alternative against a set of measures of effectiveness (MOEs), which included cost, schedule, risk, and the resulting capability of the alternative to perform science relative to the planned post-SM-4 baseline.

The key findings of this AoA are:

- Ground-based life extension does not replace instruments and does not address the risk associated with uncontrolled HST re-entry.
- Disposal-only alternatives have relatively low cost, but provide no HST life extension or added science capability comparable to the current configuration.
- Rehost alternatives provide higher value at equivalent cost to the robotic servicing missions, but may result in a two- to seven-year science gap. This higher value results from the lower development and mission risks.
- Robotic servicing alternatives, based on estimated development schedules, are susceptible to arriving too late. HST may no longer be in a serviceable state. Furthermore, they are subject to an aging observatory that may fail for some other reason during the three years following servicing.
- SM-4 has costs in the same range as the rehost and robotic servicing alternatives, has higher probability of mission success than the robotic servicing missions, and does not suffer from the gap in science associated with rehost alternatives.¹ Other means to perform SM-4 with reduced risk by launching a safe habitat or relocating HST to the vicinity of the International Space

¹SM-4 was not analyzed by the study team but was included for completeness as a baseline for comparison. SM-4 and the safe habitat approaches have unique human space flight risks that were beyond the scope of this study and therefore not assessed. Furthermore they would compete against the ISS Shuttle manifest.

Station (ISS) were examined, but would require more development time and be more costly.

Introduction

The Hubble Space Telescope (HST), launched in 1990, is the first and most widely known of NASA's great observatory missions. Orbiting the Earth at an altitude of 320 nautical miles, HST is the only orbiting observatory outside the Earth's atmosphere with the capability to observe simultaneously in the near-IR, visible, and ultraviolet wavelengths. HST observing sensitivity is beyond what is achievable, in most cases, with Earth-based telescopes, and its achievable angular resolution equals or surpasses state-of-the-art ground-based facilities. During its lifetime, HST has produced detailed images of stars, galaxies, and nebulae that have led to major scientific discoveries in astronomy and astrophysics, and have captured the public's imagination with spectacular views of the universe.

HST, whose subsystems and instruments were designed to be serviced on-orbit by astronauts using the Space Shuttle, has been visited four times for this purpose (Servicing Missions 1, 2, 3A, and 3B). The previous Shuttle servicing missions have accomplished a broad array of repairs and upgrades, including the change-out and installation of newer, more capable instruments, replacing solar arrays, batteries, and flight computers, and adding new radiators and thermal shielding.

The next Space Shuttle servicing mission, Servicing Mission 4 (SM-4), was scheduled for 2005 and manifested to replace the Corrective Optics Space Telescope Axial Replacement (COSTAR) and Wide Field Planetary Camera 2 (WFPC2), with the Cosmic Origins Spectrograph (COS) and Wide Field Camera 3 (WFC3), respectively. SM-4 would also further extend the observatory's mission life by replacing failed components and those components approaching their end of life.² Due to safety concerns surrounding the loss of the Space Shuttle *Columbia* and crew, NASA canceled future Shuttle flights to HST and embarked on a process to assess other options in order to understand the implications of HST's possible eventual demise, including that of an uncontrolled re-entry. NASA's Goddard Space Flight Center (GSFC) took the lead in developing a non-Shuttle-based servicing approach, using robotic technologies. This concept, known as the Hubble Space Telescope Robotic Servicing and De-orbit Mission (HRSDM), employs robotic vehicles to accomplish the major servicing elements of the canceled SM-4.

In this context, NASA requested that The Aerospace Corporation prepare a non-advocate assessment of HST servicing alternatives. These alternatives encompass a broad range of options including doing nothing at all, minimal replacement of components close to failure, partial and full replacement of old instruments, rehosting the existing SM-4 replacement instruments or equivalent on other spacecraft, and providing a safe habitat in the vicinity of HST so that an astronaut-performed mission might be reconsidered. Each alternative was assessed against a set of measures of effectiveness (MOEs), which included cost and schedule, risk, and the resulting capability of HST to perform science relative to the planned post-SM-4 baseline capability. The capability impact assessment did not address science quality or value, nor did it address how that science might be impacted by constraints imposed by various alternatives. It was assumed that the science value of each instrument has already been assessed as part of the instrument selection process. The capability impact assessment findings were made available to the Office of Space Science Effectiveness Team (OSSET) for comments on the impact on science value from each alternative.

The study team began with research into HST design and servicing history. Next, the team considered a broad array of alternative servicing approaches that spanned the spectrum of options covered by the study. Finally, the team grouped and consolidated similar alternatives into a final set of 21 alternatives that were representative of the trade space to be examined. The 21 alternatives provided natural incremental changes in the complexity of servicing operations and in capability enhancement. A number of robotic alternatives that bounded the trade space were included in the set, including a minimum mass alternative to de-orbit HST, and an alternative that provided power and gyro augmentation with and without a robotic arm used for a grapple-assisted docking. More complex alternatives, such as one that accomplished the goals of the GSFC HRSDM, and an ambitious mission to accomplish all of the tasks from SM-4, were also included. Each alternative included a component to de-orbit HST at the end of its useful life. The alternatives were described with sufficient detail to allow evaluation and comparison with other alternatives.

²In addition to COS and WFC3, SM-4 was to replace the gyros, batteries, fine guidance sensors (FGS), and install the aft shroud cooling system (ASCS) and thermal protection material.

In parallel with the development of alternatives, MOEs were defined, in terms of cost and schedule, risk, and capability impact. Cost and schedule MOEs examined absolute cost and development time, as well as cost risk and schedule risk. The risk MOEs included development risk and also the probability of mission success, assuming the alternatives could be successfully developed. The capability impact MOE was defined as the estimated HST instrument capability associated with each of the alternatives.

A measure for safety was also defined early in the study as the mission risk weighted re-entry casualty expectation. This measure, however, turned out not to be a strong discriminator among alternatives, and is therefore not included in this report. For cases where the disposal mission is successful, the re-entry casualty expectation is zero. Without the disposal mission, the casualty expectation is approximately one in 250.

Description of Alternatives

The HST study trade space examined is illustrated in Figure 1. Alternatives were defined in four broad categories: rehost, disposal, service, and safe habitat. Rehost alternatives flew the COS and/or WFC3 instruments on new platforms. Disposal and service alternatives were accomplished by robotic means. Safe habitat referred to a Shuttle-based astronaut-servicing mission in concert with an astronaut safe habitat in the vicinity of HST. Because of recently imposed constraints on crewed servicing since the *Columbia* accident, emphasis was placed on robotic servicing and de-orbit concepts.

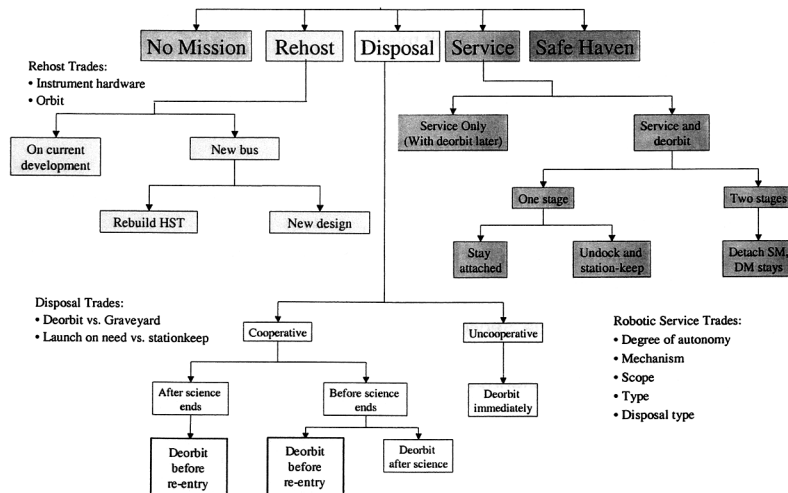

Figure 1. HST Study Decision Tree.

In defining specific alternatives, the study team sought a reasonable coverage of the trade space such as lowest-cost alternatives, alternatives that left the minimum residual mass attached to HST, minimal complexity alternatives, and high complexity alternatives in terms of number and type of operations required. The in-depth feasibility assessment of the alternatives was not performed as part of this study. However, a screening of the alternatives was performed to rule-out unrealistic alternatives. Key trades that manifest themselves in the MOEs are whether a robotic arm is used to assist in docking a de-orbit or servicing module and the number and type of servicing operations performed.

The decision tree analysis in Figure 1 led to the following arrangement of alternatives (note that all but the “do nothing” alternative include a de-orbit mission):

Alternative family A: Extension of HST through non-servicing means.

A1: Maintain HST through ground-based life-extension workarounds, until end of life.

A2: Rehost replacement instruments on a new platform in low-Earth orbit (LEO), and de-orbit HST.

A3: Rehost replacement instruments or develop equivalent capability on a new platform beyond LEO, and de-orbit HST.

Alternative family B: Robotic missions.

B1: Robotic docking and disposal of HST without servicing.

B2: Robotic docking and minimal servicing of life extension only, by addition of an external power and gyro system, followed at end of life by a separate de-orbit mission.

B3: Life extension and instrument replacement servicing alternatives, of varying complexity, combined with a de-orbit mission.

B4: Life extension and instrument replacement servicing alternatives, of varying complexity, followed at end of life by a separate de-orbit mission.

Alternative family C: Astronaut safe habitat missions.

C1: Relocate HST to the vicinity of the ISS to provide a safe habitat for a Shuttle-based astronaut-servicing mission.

C2: Launch a habitat module to the HST orbit, to provide a safe habitat for a Shuttle-based astronaut-servicing mission.

Alternative family D: Original Shuttle Servicing Mission 4.

D1: Proceed with originally planned SM-4.

Table 1 provides a summary of each of the 21 alternatives. SM-4 was not analyzed as part of this study; however, it was included in the findings for comparison. Data for the cost and schedule estimates for SM-4 were provided directly by NASA, and are unofficial, predecisional estimates.

ALTERNATIVE	TASK/COMPONENT	TASK/COMPONENT											FAMILY				
		Propulsion	Docking	Arm	Battery	Gyro	WFC3	COS	FGS	A, N & D	Disposal	Orbit					
Ground Life Extension	A1-A																L
Rehost COS LEO	A2-A	B	U							X	X	X		X		X	L
Rehost COS & WFC3 LEO	A2-B	B	U							X	X	X		X		X	L
Rehost COS outside LEO	A3-A	B	U							X	X	X		X		X	O
Rehost COS & WFC3 outside LEO	A3-B	B	U							X	X	X		X		X	O
De-orbit	B1-A	B	U													X	L
De-orbit with Arm	B1-B	B	A	G												X	L
Electric Graveyard	B1-C	E	U													X	L
Tumbler	B1-D	M	U													X	L
Servicer Light	B2-A	M/B	U/T			X	X									X	L
Baseline no COS	B3-A	M	A	D	X	X	X									X	L
Baseline	B3-B	M	A	D	X	X	X	X								X	L
Baseline with FGS	B3-C	M	A	D	X	X	X	X	X							X	L
Baseline no COS with FGS	B3-D	M	A	D	X	X	X	X	X							X	L
Cadillac	B3-E	M	A	D	X	X	X	X	X	X						X	L
Boomerang	B4-A	M	A	D	X	X	X	X	X	X	X					X	L
Baseline separate deorbit	B4-B	M	A/T	D	X	X	X	X								X	L
Cling-on	B4-C	M	A	D	X	X	X	X								X	L
Tug to ISS	C1	E	U													X	L
Safe habitat	C2															X	L
Servicing Mission 4	D1															X	L

M= Monoprop, B = Biprop, E = ElectricProp
 U = Untargeted docking, T = Targeted docking, A = Grapple arm assisted
 D = Dexterous arm, G = Grapple arm
 L = LEO, O = Outside LEO
 X = Includes task/component
 A, N & D = Additional SM4 ASCS, NOBL & DMCSU servicing components

Table 1. Summary of Alternatives

Measures of Effectiveness (MOEs)

Each alternative was assessed against a common set of measures of effectiveness (MOEs), which included cost and schedule, risk, and the observatory capability relative to the post-SM-4 state.

The cost MOE (MOE #1) was defined to be the life cycle cost (LCC). The LCC includes (as applicable to the given alternative) servicing and de-orbit module development, payload instrument development or modification, spacecraft bus, launch, program management, systems engineering, mission assurance, robotics, ground system development, servicing operations, three years of post-servicing HST mission operations, data analysis, and reserves. Cost estimates were calculated as probability density functions, based on triangular distributions for the main cost elements listed above. The cost MOE was defined as the 75th percentile life cycle cost.

The schedule MOE (MOE #2) was defined to be the development time from program authority to proceed (ATP) to launch. The schedule MOE was based on schedule estimating relationships developed for the rehost, de-orbit and robotic servicing, and safe haven option families. Like cost, schedule estimates were also developed as probability distributions for use in the calculation of MOE #3.

Development risk (MOE #3) was the convolution of two probability distribution functions: the probability distribution of HST being in the required state, and the probability distribution of the development time. This convolution resulted in the probability of HST being in the required state when the servicing or disposal mission is launched. For servicing missions, the "required state" was defined as a state where a servicing mission can dock with HST, either cooperatively or uncooperatively, and where HST can be restored to full operations using only the replacement parts associated with the current design of the servicing alternative. For this study, this is essentially a state where gyros may have failed, but all other subsystems necessary for the functioning of HST are operating. For the disposal-only missions, the "required state" was based on HST having not re-entered the Earth's atmosphere.

The probability of mission success (MOE #4) is a measure of mission risk, and is based on the probability of successfully completing a sequence of events, beginning at launch and including proximity operations and docking, the sequence of servicing steps, three years of HST mission operations, and de-orbit. This measure is independent of development risk. In the analysis process, there is no linkage between systematic or workmanship errors that may occur prelaunch during development, but that manifest themselves later during the mission.

The capability MOE (MOE #5) measures the predicted capability of the HST to perform science relative to its expected post-SM-4 condition. There is no metric for future space exploration value and no weight is given to the value of one particular scientific investigation relative to another.

Summary of Results

Figure 2 shows MOE #1 (life cycle cost) for the alternatives examined. The numbers following the bars provide the range of costs within each alternative family. In all cases, it is assumed that each system is a new development. However, for consistency, each alternative is credited with heritage for about 40 percent of the component mass of the system. Not unexpectedly, the astronaut-servicing missions that depend on a safe habitat (alternative family C) are the costliest; while the disposal alternatives (alternative family B1) are the least expensive. Note also that there is little difference between the cost of the rehost alternatives and the robotic servicing missions. The discriminator becomes risk, which will be discussed in the sections that follow.

The rehost alternatives range in cost from \$1.9B to \$2.3B, with roughly \$350M of that total reserved for the HST de-orbit mission (represented by B1-A). The disposal missions have the greatest variability in cost, ranging from \$300M for the simplest de-orbit alternative, B1-D, to \$1.1B for the B1-B alternative that uses grapple-arm-assisted docking. Drivers on the range of B1 family costs are whether a robotic arm is utilized, estimated at approximately \$300M, with the associated mass needed to support the robotic components on the de-orbit module. Additionally, integration of the arm significantly increases program management, systems engineering, and mission assurance (PM/SE/MA) costs over the no-arm option.

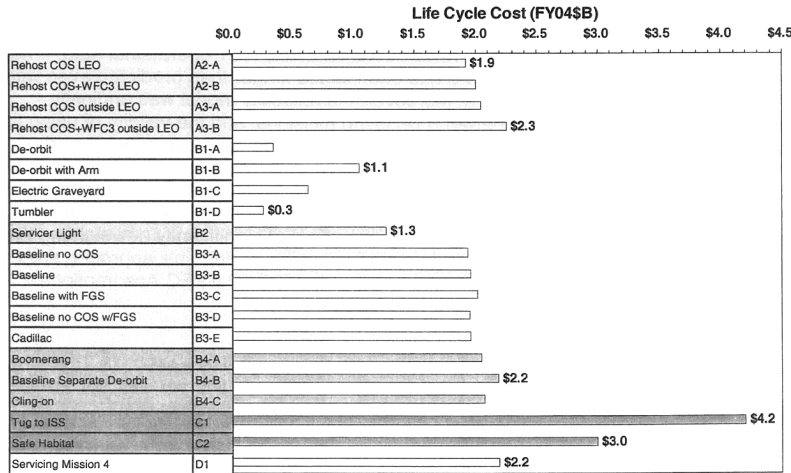

LCC Estimates Show Little Cost Difference Between Rehost & Servicing Missions

Figure 2. Life Cycle Cost (MOE #1).

For the servicing alternatives, costs range from \$1.3B for the external gyro and battery augmentation option, which doesn't require a robotic arm (B2), to \$2.2B for alternative B4-B, which uses a second separate mission for de-orbit. The cost variations across the B3 family are relatively small since the mass of these options is generally insensitive to the equipment manifested and the servicing steps that need to be accomplished.

The discriminator in the costs for the de-orbit and robotic servicing options is the grapple arm. Once the grapple arm is included, adding the capability for a dexterous arm enables a large array of complex servicing tasks at an incremental cost of about \$700M over the armless external servicing option, B2. The cost of the robotics was based on the development cost of the Canadarm-Shuttle Remote Manipulator System (SRMS), the European Robotic Arm (ERA) for the Columbus Orbital Facility of the ISS, and the Special Purpose Dexterous Manipulator (SPDM) developed for use on the ISS.

For systems that do not use the grapple arm to dock, there are impacts to the design and implementation of the docking system, the requirement for precision maneuvers, reduced closing velocities, and small docking forces. In the case of a servicing mission, the closing rates and latching forces would be limited so as not to damage HST. However, in the case of unassisted docking for the purposes of de-orbit, damage to HST may not be a central issue, and a different approach that allows higher forces to guarantee a hard dock and positive latching might be more appropriate.

Figure 3 displays MOE #2, development schedule, and MOE #3, development risk. The HST predicted lifetime bar at the bottom of Figure 3 is based on two assumptions on the application of the HST reliability model. The "HST Reliability Model" end of serviceable state (EOSS) prediction (50th percentile probability of failure date) is calculated using the current failure rate assumptions in the reliability model. This model has been improved over the years by periodically updating the component failure rates based on actual HST operational data. It has been observed, however, that HST hardware has often lasted longer than predicted even with the periodic updates to the failure rate data. Moreover, the reliability model was originally designed and used to size the interval between servicing missions, and the validity of using the model to predict an end-of-life state has never been fully assessed. Consequently, experts familiar with HST often view the HST reliability model as overly conservative. To address this criticism, a different approach, recommended by NASA GSFC, to updating the failure rates was applied. In this approach, the failure rates for the top five reliability drivers were recomputed based solely on HST operational experience, having the effect of significantly deweighting them in the reli-

ability calculation relative to the standard HST reliability model. This approach adds about 12 months of life to HST (50th percentile) and is labeled “EOSS GSFC Assumptions.”

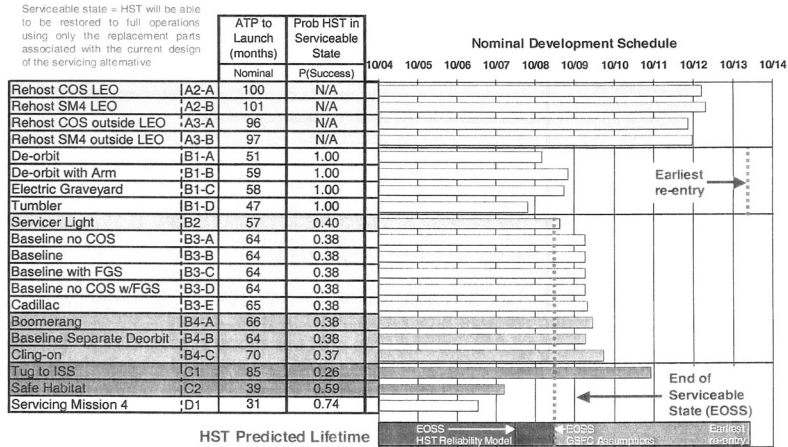

Figure 3. Development Schedule (MOE #2) and Development Risk (MOE #3).

As can be seen in Figure 3, the nominal development time exceeds the date associated with the end of serviceable state by a number of months in most cases. The B2 servicing option nominal development time almost meets this date. The probability of HST being in a serviceable state is less than or equal to 40 percent for the robotic servicing options, because they are tied to a HST demise in April 2009. The de-orbit alternatives are tied to the earliest re-entry date of 2014, and can be developed within this time with a very high likelihood.

The rehost options are also insensitive to the HST date of demise. However, there is a high likelihood that the rehost options cannot be developed before the HST end of life, resulting in a multi-year science gap with no HST-like observing capability in orbit.

The development risk for the SM-4 alternative is listed at 74 percent. This calculation is based on the earliest launch date provided by NASA, which is unofficial and predecisional. In assigning the SM-4 launch date, NASA assumed that the SM-4 mission, if it were to fly, would be launched 31 months from the ATP date of October 2004. Conceivably, the mission could be moved forward in the return-to-flight schedule, which would decrease the development risk, with the constraint that sufficient astronaut training time be provided.

Figure 4 presents the probability of mission success (MOE #4), and provides an example calculation of this value for the baseline alternative, B3-B. The definition of mission success is different for each alternative and is dependent on the number of events that must be accomplished to achieve the final success state. For all robotic servicing alternatives, the success state includes three years of science operations and a successful de-orbit. Clearly, there are more events that could lead to mission failure for servicing missions than for disposal missions. Hence, they tend to have a lower probability of mission success by their very nature. As can be seen in the B3-B example shown in Figure 4, the probability of mission success for the robotic servicing missions is dominated by the probability of successfully completing the servicing operations and by the probability of HST operating for three years, once the servicing is complete. Due to the age of the HST, after several years of post-service operations, other components and failure mechanisms begin to dominate the reliability estimates.

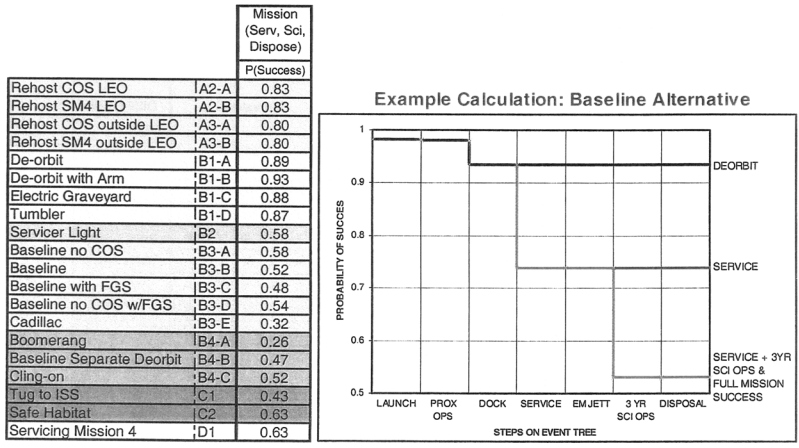

Figure 4. Probability of Mission Success (MOE #4).

Note the 63 percent probability of mission success for the SM-4 alternative. Astronaut servicing has been successfully demonstrated on four prior servicing missions. Probability of success for the servicing events is 100 percent. The Shuttle has failed once on launch and once on re-entry, leading to a 99 percent probability of success. Here again, the probability driving the success is achieving three years of post-servicing operations.

Figure 5 provides the capability impact for each alternative relative to the post-SM-4 baseline (MOE #5), based on historical instrument utilization patterns. Clearly the disposal options have a resultant relative capability of zero. The B2 alternative, which provides power and rate-sensing augmentation, is also very low since new instruments are not added. Furthermore, in the existing HST architecture, the Near Infrared Camera and Multi-Object Spectrometer (NICMOS) Cooling System (NCS) is powered through a separate circuit that is not accessible by alternative B2. The result is that the NCS would need to remain operating directly off the HST battery bus, serviced by the HST solar arrays. This may not be possible once the HST batteries reach a state where they can no longer hold sufficient charge to support the NCS load. The rehost alternatives register at 40- or 78-percent of the full post-SM-4 capability. This calculation is based on historical utilization data that indicates that new instruments generally crowd out the old instruments for observing time. This measure is imperfect since it does not account for the benefits of observing the same target simultaneously with two or more instruments, increased observing efficiency associated with the rehost alternatives outside of LEO, or the fact that each instrument in a smaller instrument suite may receive higher overall utilization.

			Instruments						Family
		Capability Relative to Post-SM4 HST	WFPC2	STIS	ACS	NICMOS	WFC3	COS	
Rehost COS LEO	A2-A	40%						X	REHOST
Rehost SM4 LEO	A2-B	78%					X	X	
Rehost COS outside LEO	A3-A	40%						X	
Rehost SM4 outside LEO	A3-B	78%					X	X	
De-orbit	B1-A	0%	No value						DISPOSAL
De-orbit with Arm	B1-B	0%							
Electric Graveyard	B1-C	0%							
Tumbler	B1-D	0%							
Servicer Light	B2	21%	X	X	X				SERVICING
Baseline no COS	B3-A	62%		X	X	X	X		
Baseline	B3-B	100%		X	X	X	X	X	
Baseline with FGS	B3-C	100%		X	X	X	X	X	
Baseline no COS w/FGS	B3-D	62%		X	X	X	X		
Cadillac	B3-E	100%		X	X	X	X	X	
Boomerang	B4-A	100%		X	X	X	X	X	
Baseline Separate Deorb	B4-B	100%		X	X	X	X	X	
Cling-on	B4-C	100%		X	X	X	X	X	
Tug to ISS	C1	100%		X	X	X	X	X	OTHER
Safe Habitat	C2	100%		X	X	X	X	X	
SM4	D1	100%		X	X	X	X	X	

Figure 5. Capability Relative to Post-SM4 HST (MOE #5).

Since the capability metric is based solely on instrument utilization, all alternatives that result in the same final instrument complement as the post-SM-4 configuration were scored 100 percent. There are additional servicing items accomplished by SM-4, such as the installation of the ASCS radiator on the external shroud to provide additional instrument detector thermal margin/control and improve HST's operational efficiency. This may provide a capability benefit through additional observing time; however, enhancements of this nature are not captured in this metric.

Figure 6 summarizes the five major MOEs assessed in this study: cost, development time, development risk, mission risk, and capability impact. Mission risk and development risk are rated with qualitative descriptors. The uncertainty of the risk assessments for the robotic servicing alternatives is higher than for the de-orbit missions and the rehost options. While there are several missions yet to be launched that have features similar to the robotic servicing alternatives (autonomous docking using grapple arms, proximity operations, etc.), none have flown, and they are outside the historical experience base. For this reason, it is difficult to discriminate between the risks associated with any of the robotic servicing alternatives when the development and mission risks (one minus the probability of success) cluster in the 40 to 60 percent range.

Alternatives	Cost & Schedule			Risk & Safety		Capability						Family	
	Life Cycle Cost (FY04\$B)	Nominal Development Time (Years)		Development Risk	Mission Risk	W FP C2	ST IS	AC S	NI C M OS	W FC 3	C OS		
Ground Life Extension	A1					X	X	X	X				
Rehost COS LEO	A2-A	\$1.9	8.4	Science Gap	Low							X	
Rehost SM4 LEO	A2-B	\$2.0	8.4										X
Rehost COS outside LEO	A3-A	\$2.0	8.0										X
Rehost SM4 outside LEO	A3-B	\$2.3	8.1									X	X
De-orbit	B1-A	\$0.4	4.2	Low	Low	No value						DISPOSAL	
De-orbit with Arm	B1-B	\$1.1	4.9										
Electric Graveyard	B1-C	\$0.6	4.8										
Tumbler	B1-D	\$0.3	3.9										
Servicer Light	B2	\$1.3	4.7	High	High	X	X	X					
Baseline no COS	B3-A	\$1.9	5.4	High	High		X	X	X	X			
Baseline	B3-B	\$2.0	5.4				X	X	X	X	X		
Baseline with FGS	B3-C	\$2.0	5.4				X	X	X	X	X		
Baseline no COS w/FGS	B3-D	\$2.0	5.4				X	X	X	X	X		
Cadillac	B3-E	\$2.0	5.4				X	X	X	X	X		
Boomerang	B4-A	\$2.1	5.5	High	High		X	X	X	X			
Baseline Separate Deorb	B4-B	\$2.2	5.4				X	X	X	X	X		
Cling-on	B4-C	\$2.1	5.8				X	X	X	X	X		
Tug to ISS	C1	\$4.2	7.1	High	High		X	X	X	X			
Safe Habitat	C2	\$3.0	3.3		Medium			X	X	X	X		
SM4	D1	\$2.2	2.6	Medium	Medium		X	X	X	X			

Figure 6. HST Servicing Study Results Summary.

A qualitative, but uncalibrated scale was selected to bin the mission risk values into the “low,” “medium,” and “high” risk categories. In general, mission success probabilities higher than 80 percent were labeled low risk. Success probabilities between 80 percent and 40 percent were labeled medium risk, and success probabilities below 40 percent were labeled high risk. For medium-risk alternatives, the mission risk was dominated by the probability of HST operating successfully for three years after the servicing mission is completed. Hence, all astronaut-servicing options, including SM-4, have at least medium mission risk. The medium ranking on the SM-4 development risk is constrained by the Shuttle launch date assumption provided by NASA. In the high-risk category, mission risk was dominated both by the probability of success of the servicing mission, and the probability of success of the three years of operations.

Figure 7 illustrates the results of combining three MOEs—capability (MOE #5), development risk (MOE #3), and probability of mission success (MOE #4)—to produce an expected value calculation:

$$\text{Expected Value} = \text{MOE \#3} * \text{MOE \#4} * \text{MOE \#5}$$

This combined expected value is plotted against life-cycle cost. Figure 7 indicates that the disposal alternatives provide no value relative to observatory capability. The expected value calculation also indicates that rehosting both the SM-4 instruments on new platforms provides higher value at equivalent cost to the robotic-servicing missions. This results from the lower development and mission risks, which includes launch and on-orbit operations, associated with the rehost alternatives. There is, however, a gap in science with the rehost alternatives that is not captured in this expected value assessment.

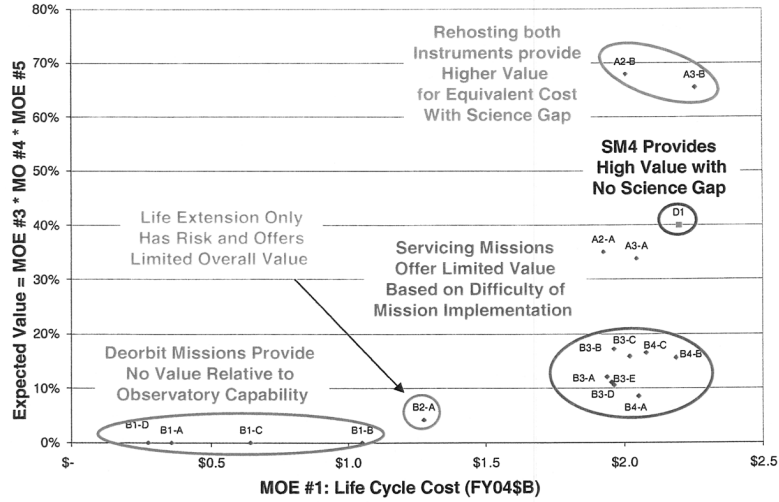

Figure 7. Expected value vs. life cycle cost.

The robotic servicing alternatives cluster in the lower right corner of the plot, suggesting that the value of these alternatives is limited based on difficulty of the mission implementation, the complexity of the servicing mission, and the reliability of HST after servicing.

SM-4 has costs in the same range as the rehost and robotic-servicing alternatives. It has the added benefit of higher probability of mission success than the robotic servicing missions, and does not suffer from the gap in science associated with the rehost alternatives.

Acronyms

AoA	Analysis of alternatives
ASCS	Aft shroud cooling system
ATP	Authority to Proceed
CONOPS	Concept of Operations
CORDS	Center for Orbital and Re-entry Debris
COS	Cosmic Origins Spectrograph
COSTAR	Corrective Optics Space Telescope Axial Replacement
DMCSU	Data Management Cross Strap Unit
EOSS	End of serviceable state
ERA	European Robotic Arm
FGS	Fine Guidance Sensor
FY	Fiscal Year
GEO	Geosynchronous Earth orbit
GSFC	Goddard Space Flight Center
HRSDM	Hubble Space Telescope Robotic Servicing and De-orbit Mission
HST	Hubble Space Telescope
ISS	International Space Station
LCC	Life cycle cost
LEO	Low Earth orbit
MOE	Measure of Effectiveness
NCS	NICMOS Cooling System
NICMOS	Near Infra-Red Camera and Multi-Object Spectrometer
NOBL	New Outer Blanket Layer
OSSET	Office of Space Science Effectiveness Team
PM/SE/MA	Program management, systems engineering, and mission assurance
SM4	Servicing Mission 4
SPDM	Special Purpose Dexterous Manipulator
SRMS	Shuttle Remote Manipulator System
WFC3	Wide Field Camera 3
WFPC2	Wide Field Planetary Camera 2

BIOGRAPHY FOR GARY P. PULLIAM

Gary P. Pulliam is Vice President of Civil and Commercial Operations. He was appointed to this position in December 2004. Pulliam directs all civil and commercial business at Aerospace and is responsible for contracts valued at \$90 million annually. Key customers include the National Aeronautics and Space Administration, the National Oceanic and Atmospheric Administration, and a wide number of other civil and commercial organizations in the United States and overseas.

In addition to his responsibilities in Civil and Commercial Operations, Pulliam is Corporate Director of Government Relations.

Pulliam joined The Aerospace Corporation in 1994 as Director of Government Operations after serving for five years as Chief of Staff for U.S. Representative Earl Hutto of Florida's first congressional district. He concurrently was a professional staff member for the House Armed Services Committee, supporting Chairman Hutto, and was the Congressman's campaign manager.

Pulliam was appointed General Manager in charge of non-Defense Department business at Aerospace in 1997. He has continued to handle government relations responsibilities while managing increasingly important civil and commercial programs.

During a 20-year career in the Air Force, Pulliam served as a pilot and instructor and held assignments at the Aeronautical Systems Center in Dayton, Ohio. He also held several positions at the Pentagon, including an assignment as Legislative Liaison in the Office of the Secretary of the Air Force.

He holds a Bachelor's degree in English from Clemson University and earned a Master's in Operations Management at the University of Arkansas. He also is a graduate of Harvard University's Kennedy School of Senior Managers in Government Program.

The Aerospace Corporation, based in El Segundo, California, is an independent, nonprofit company that provides objective technical analyses and assessments for national security space programs and selected civil and commercial space programs in the national interest.

Chairman BOEHLERT. And let me thank you for the skillful way in which you summarized it, and yet hit all the high points.

Dr. Lanzerotti.

STATEMENT OF DR. LOUIS J. LANZEROTTI, CHAIR, COMMITTEE ON ASSESSMENT OF OPTIONS TO EXTEND THE LIFE OF THE HUBBLE SPACE TELESCOPE, NATIONAL RESEARCH COUNCIL, THE NATIONAL ACADEMIES; ACCOMPANIED BY GENERAL CHARLES F. BOLDEN, JR. (RET.), SENIOR VICE PRESIDENT AT TECHTRANS INTERNATIONAL, INC., AND JOSEPH H. ROTHENBERG, PRESIDENT AND MEMBER, BOARD OF DIRECTORS, UNIVERSAL SPACE NETWORK

Dr. LANZEROTTI. Mr. Chairman, Mr. Gordon, Members of the Committee, thank you for the opportunity to testify today. My name is Louis Lanzerotti, as the Chairman indicated. I appear in my capacity as Chair of the National Academies Committee on Assessment of Options to Extend the Life of the Hubble Space Telescope.

In early 2004, the National Academies were asked by Congress and NASA to examine the issues surrounding the cancellation in January of that year of the final servicing for the Hubble telescope, and to consider both the value of preserving Hubble and the potential methods for doing so.

The Academies formed a committee of members of outstanding international reputations and credentials. The committee concluded, after detailed examination of the evidence, that NASA should commit to a Hubble servicing mission that accomplished the objectives of the originally planned servicing mission.

The committee's three principal conclusions related to the mission and the crew risk of servicing Hubble were the following. First, the need for timely servicing of Hubble due to lifetime limits on various engineering subsystems imposes difficult requirements on the development of a robotic servicing mission. The very aggressive schedule, the complexity of the mission system design, the low current level—current low level of technology maturity, with the notable exception of the Space Station Dexterous Manipulator System, make it highly unlikely that the science life of Hubble will be extended through robotic servicing.

Secondly, a Shuttle servicing mission is the best option for extending the life of Hubble, preparing it—and preparing it for eventual robotic de-orbit. The committee believes that this servicing mission could reasonably occur as early as the seventh Shuttle mission following return-to-flight.

Thirdly, the committee also concluded that the difference in the crew risk faced by a single Shuttle mission to the Space Station, already accepted, I noted, by NASA and the Nation, about 25 to 30 flights, and the crew risk of a single Shuttle mission to Hubble is very small. These conclusions were reached after in depth analytical examination of technical data, presentations by expert witnesses, extensive consultations with NASA and with industry, multiple site visits by committee members to the Goddard Space Flight Center, the Johnson Space Flight Center.

The committee did not rely on any one source, such as the Aerospace report, in its deliberations, although Aerospace and we arrived at similar conclusions on some of the issues. The committee received inputs from many different sources, accepted no conclusions that it could not independently verify. Two of my esteemed committee members, General Charles Bolden, a veteran former astronaut whose Shuttle missions include the deployment of the Hubble telescope, and Mr. Joseph Rothenberg, former Associate Administrator of Space Flight at NASA Headquarters, and former Director of Goddard Space Flight Center, are present with me today, and will be available, and I will call on them for answers of some questions.

When this study was initiated, I found a broad diversity of opinion among Committee members on both the question of whether Hubble should be preserved, agnostic, just as you said yourself are, Mr. Chairman, and if so, if it should be preserved, which method of doing so is preferable. After a vigorous and questioning exploration of the information presented to us, many committee meetings, subcommittee meetings, the Committee reached its conclusions in our report unanimously and without reservation.

And with regard to Hubble, I will only very briefly note, many of you, all three of you on the—who have spoken on the dais, have indicated this. Results from Hubble have captured the imagination of scientists and of the general public around the world. Hubble has been one of the most important outreach instruments in terms of contributions to public awareness of science and of the universe in which we live. It might be argued, of course, that the universe will be here into the future, for other space missions to explore. However, I would like to note that a number of NASA space astronomy missions presently in flight, as well as planned, including the

X-ray satellite Chandra, and the infrared satellite Spitzer, will not be as productive as they can be if synergistic data were not available from Hubble for the analyses and for carrying on. My colleague Professor Taylor here is here today, and will address this aspect of—and can address this aspect of Hubble much better than can I.

Now, in comparing the various options. My Committee's engineering analyses concluded that Hubble most likely will need to terminate science operations by mid-2007. Therefore, any servicing mission must be accomplished by the end of 2007 at the latest to prevent an interruption in science, and to not have an impaired Hubble to deal with. Even NASA's most optimistic projections places the robotic mission in December 2007. This estimate was made when the NASA project hoped to receive full development funding in both 2005 and 2006, something that has not occurred. And Mr. Rothenberg can address that further, if there are some questions related to that.

My committee compared a robotic servicing mission with a Shuttle servicing one. Important strengths of a Shuttle servicing mission include it has been done before, four times in fact, successfully. There is no new development required. All of the instruments and replacement equipment have been built, so there is low schedule risk. Numerous life extension upgrades that are not feasible on a robotics mission could be carried out with a Shuttle mission, and there have been—this has been proven to be the case time and again on the previous four missions, servicing missions.

A human mission has the unique ability to respond to last minute requirements, usually driven by unforeseen failure, and again, we have shown that in previous servicing missions. The risks and costs of the eventual de-orbit mission for Hubble could be decreased substantially by pre-positioning a docking mechanism and associated fiducials. The main risks of a Shuttle servicing mission are that the schedule depends on a successful Shuttle return-to-flight, and a small crew risk, as I noted, by flying one more Shuttle mission. An additional Shuttle mission would also delay Space Station assembly by three to five months.

The strengths of a robotic mission are that it avoids risks to astronauts of one additional Shuttle flight. It is exciting technology. Some of the technology may have applications to other space activities, although we have to recognize that Hubble was not designed for robotic servicing. The weaknesses of a robotic mission are primarily those associated with successfully achieving an extremely ambitious mission on a very aggressive schedule, and a very real risk to Hubble of using it as an uncooperative target vehicle for the demonstration of unproven robotic technology.

My committee—if I might have one more minute to address dehosting—my committee had a number of important concerns on practical aspects of rehosting of Hubble instruments. For comparable science returns, NASA would need—certainly need to commit to, to fly and build, a new Hubble telescope. For mission success, this program would require a commitment of very significant resources, as well as very strong scientific and political support over an extended interval. Such a program has never been evaluated by the priority setting process of a Decadal Survey, which Dr.

Taylor will outline. It was not clear to my committee that rehosting would involve significant cost savings over a Shuttle repair mission, particularly given the uncertainties of developing an entire new satellite that performs like the original Hubble. For these reasons, I personally have strong reservations regarding a rehosting option for Hubble, as compared to a Shuttle repair mission. If a Shuttle repair mission were proven not to be possible. For example, if return-to-flight of the Shuttle was not successful, then I would recommend that the tradeoffs involving a rehosting mission should be reviewed by the astronomy community in the context of its overall planning for space astronomy in the next decade, such—in the context of the Decadal Survey.

In concluding, I reiterate that my committee found Hubble to be a scientific asset of extraordinary value to the Nation, that Shuttle servicing is best—servicing is the best option for extending the life of Hubble. Thank you, and as I indicated, my colleagues, General Bolden and Mr. Rothenberg, and I are prepared to answer your questions.

[The prepared statement of Dr. Lanzerotti follows:]

PREPARED STATEMENT OF LOUIS J. LANZEROTTI

Mr. Chairman, Ranking Minority Member, and Members of the Committee:

Thank you for inviting me here to testify today. My name is Louis Lanzerotti and I am a Professor of Physics at the New Jersey Institute of Technology and a consultant for Bell Laboratories, Lucent Technologies. I appear today in my capacity as Chair of the National Research Council (NRC)'s Committee on Assessment of Options to Extend the Life of the Hubble Space Telescope.

As you know the NRC is the unit of the National Academies that is responsible for organizing independent advisory studies for the Federal Government on science and technology. In early 2004 the NRC was asked by Congress and NASA to examine the issues surrounding the cancellation of the final servicing mission (SM-4) for the Hubble Space Telescope and to consider both the value of preserving Hubble and the potential methods for doing so. Specifically called out in the tasking was a requirement to survey the potentials of both on-orbit and robotic intervention. The National Research Council formed a committee under the auspices of the Space Studies Board and the Aeronautics and Space Engineering Board to respond to this request.

After detailed examination of the astronomical evidence that was presented to it, the committee concluded that NASA should commit to a Hubble servicing mission that accomplishes the objectives of the originally planned SM-4 mission. This includes the emplacement of two new instruments, the Cosmic Origins Spectrograph (COS) and the Wide Field Camera-3 (WFC3), as well as refurbishments of those spacecraft subsystems that are required to preserve the health and safety of the telescope, both for science as well as for eventual safe de-orbiting.

The committee's principle conclusions related to the mission risk of servicing Hubble were:

- The need for timely servicing of Hubble, due to lifetime limits on various engineering subsystems, imposes difficult requirements on the development of a robotic servicing mission. The very aggressive schedule, the complexity of the over-all mission system design (which is in a rudimentary state), the current low level of technology maturity (other than the yet-to-be flown International Space Station (ISS) Special Purpose Dexterous Manipulator System (SPDM) and Grapple Arm (GA; essentially the Shuttle Remote Manipulator System (RMS)), and the inability of a robotics mission to respond to unforeseen failures that may well occur on Hubble between now and a robotic servicing mission make it highly unlikely that the science life of HST will be extended through robotic servicing.
- A Shuttle servicing mission is the best option for extending the life of Hubble and preparing the observatory for eventual robotic de-orbit; such a mission is highly likely to succeed. The committee believes that this servicing mission could occur as early as the seventh Shuttle mission following return-to-flight,

at which point critical Shuttle missions required for maintaining the ISS will have been accomplished.

It is obvious that a robotic servicing mission to Hubble would involve no risk to astronauts. However, the committee was informed that the Nation is committed to 25 to 30 human Shuttle flights to the International Space Station (ISS). In reviewing all of the data presented to it, and in making use of the expertise of the committee's members who have deep experience in human space flight as well as in managing the Nation's human space flight program,

- The committee concluded that the difference between the risk faced by the crew of a single Shuttle mission to the ISS—already accepted by NASA and the Nation—and the risk faced by the crew of a Shuttle mission to HST is very small. Given the intrinsic value of a serviced Hubble, and the high likelihood of success for a Shuttle servicing mission, the committee judges that such a mission is worth the risk.

As I noted, these conclusions were reached after a considerable, in-depth examination of technical data and documents, presentations by expert witnesses, extensive exchanges and consultations with NASA, industry and academic colleagues, and multiple site visits to the Goddard Space Flight Center and the Johnson Space Flight Center. The committee members have outstanding, world-recognized credentials in not only the diverse fields relevant to this study (ranging from risk assessment to astronomy) but also in their decades of direct, practical, experience with the NASA spacecraft systems and programs that were being evaluated. Two of my committee members, General Charles Bolden, a veteran former astronaut whose Shuttle missions include the deployment of the Hubble Space Telescope, and Mr. Joseph Rothenberg, former Associate Administrator of Spaceflight at NASA and former Director of the Goddard Space Flight Center, are present with me today and are available to answer questions.

Before I continue I would like to note, and indeed stress, that when this study was initiated, I found a broad diversity of opinion among the committee members on both the question of whether Hubble should be preserved, and if so, which method of doing so was preferable. After all, from my personal experience and the experience of some members of the committee, almost no space researcher is ever in favor of turning off an operating spacecraft that is continuing to return excellent data. Hence, some members of the committee questioned at the outset of our study the very premise of keeping Hubble alive. It was only after a vigorous and painstaking exploration of the information presented to us, and considerable questioning analysis, that the committee reached the conclusions that are found in our report. Those conclusions were reached unanimously, and without reservation, by our entire membership.

Of the many issues considered by the committee, I have been asked to focus today on 1) Hubble's contribution to science and what its loss or performance interruption would mean, and the 2) the comparative strengths and weaknesses of a Shuttle servicing mission, a robotic servicing mission, and a rehosting mission. I will therefore devote the remainder of my testimony to these issues.

The Past and Future Contributions of Hubble

Over its lifetime, the HST has been an enormous scientific success, having earned extraordinary scientific and public recognition for its contributions to all areas of astronomy. Hubble is the most powerful space astronomical facility ever built, and it provides wavelength coverage and capabilities that are unmatched by any other optical telescope currently operating or planned. Much of Hubble's extraordinary impact was foreseen when the telescope was being planned. It was predicted, for example, that the space telescope would reveal massive black holes at the centers of nearby galaxies, measure the size and age of the observable universe, probe far enough back in time to capture galaxies soon after their formation, and provide crucial keys to the evolution of chemical elements within stars.

All of these predicted advances have been realized, but the list of unforeseen Hubble accomplishments may prove even greater. Hubble did discover "adolescent" galaxies, but it also saw much farther back in time to capture galaxies on the very threshold of formation. Einstein's theory of general relativity was bolstered by the detection and measurement of myriad gravitational lenses, each one probing the mysterious dark matter that pervades galaxies and clusters of galaxies. Gamma-ray bursts had puzzled astronomers for more than 20 years; in concert with ground and X-ray telescopes, Hubble placed them near the edge of the visible universe and established them as the universe's brightest beacons, outshining whole galaxies for brief moments. Perhaps most spectacularly, Hubble confirmed and strengthened preliminary evidence from other telescopes for the existence of "dark energy," a new

constituent of the universe that generates a repulsive gravity whose effect is to drive galaxies apart faster over time. The resulting acceleration of universal expansion is a new development in physics, possibly as important as the landmark discoveries of quantum mechanics and general relativity near the beginning of the 20th century.

Closer to home, Hubble has zeroed in on our own cosmic past by uncovering virtual carbon copies of how the Sun and solar system formed. Dozens of protoplanetary disks have been found encircling young stars in nearby star-forming regions of the Milky Way. The sizes and densities of these disks show how surplus dust and gas collect near infant stars to form the raw material of planets. Dozens of large, Jupiter-like planets have been discovered, initially by other telescopes but recently by Hubble using a new and more precise method. Measuring the tiny drop in light as a planet transits the disk of its parent star, the new technique could lead to a method for discovering Earth-like planets—a discovery with tremendous long-term implications for the human race.

I would like to stress that results from Hubble—its pictures and the new concepts that have flowed from these images—have captured the imagination of the general public, not only in our country but around the world. Hubble has been one of the most important outreach instruments in terms of its contributions to public awareness of science and of the universe in which we live.

Fascinating as they are, the scientific returns (and the public interest and excitement) from Hubble are far from their natural end. With its present instruments the telescope could continue probing star formation and evolution, gathering more data on other planetary systems, revealing phenomena of the planets and comets in our own solar system, and exploring the nature of the universe at much earlier times.

Two new instruments, already built for NASA's previously planned servicing mission (SM-4), would amplify the telescope's capabilities by allowing qualitatively new observations in two under-exploited spectral regions. Such rejuvenation via new instruments has occurred after every Hubble servicing mission, and the next one promises to be no different. Wide Field Camera-3 (WFC3) would increase Hubble's discovery efficiency for ultraviolet and near-infrared imaging by factors of 10 to 30. The UV channel coupled with the camera's wide field of view will image the final assembly of galaxies still taking place in the universe. The near-infrared channel of WFC3 favors discovery of the very youngest galaxies, whose light is maximally red-shifted. The available UV, visible, and near-IR channels will combine to give a sweeping, panchromatic view of objects as diverse as star clusters, interstellar gas clouds, galaxies, and planets in our own solar system.

The second new instrument, the Cosmic Origins Spectrograph (COS), will increase Hubble's observing speed for typical medium-resolution ultraviolet spectroscopy by at least a factor of 10 to 30, and in some cases by nearly two orders of magnitude. Ultraviolet spectra carry vital clues to the nature of both the oldest and the youngest stars, yet UV rays are totally invisible to ground-based telescopes. COS will fill important gaps in our understanding of the birth and death of stars in nearby galaxies. Even more impressive, COS will use the light of distant quasars to spotlight previously undetectable clouds of dispersed gas between nearby galaxies, thereby mapping in unprecedented detail the properties of the so-called "cosmic web."

The future accomplishments I have described, and the many unforeseen discoveries that are impossible to predict but certain to occur, are what would be lost if Hubble was not serviced or replaced. It might be argued, of course, that the universe will be here into the future for other space missions to explore further. However, a number of NASA space astronomy missions presently in flight as well as planned, including the X-ray satellite Chandra and the infra-red satellite Spitzer, would not be as productive as they can be if synergistic data from Hubble were not to be available for analyses. The most recent Decadal Survey of Astronomy has predicated its recommendations for the future of the research field, and for the future facilities that would be needed for future advances, on the existence of Hubble data and its use in conjunction with other NASA space astronomy missions. My colleague Professor Joseph Taylor, a Co-Chair of this Decadal Survey, is here today and can address this aspect of Hubble much better than can I.

It is important to recognize that a central issue in the discussions that entered into our committee's conclusions is that the Hubble has a limited life; it was designed from the outset to be serviced periodically. A lengthy delay in servicing (the technical details are described in detail in our report) could result in a permanent loss of the telescope and even in a telescope orientation that would prevent ultimate safe de-orbit.

As shown in our report, it is most likely that an interruption of science operations will occur due to gyroscope failure some time in mid-2007 unless servicing occurs. The ultimate, irreversible, failure of the telescope in the next several years is de-

pendent on battery lifetime. Our committee spent a great deal of time investigating the conditions of the batteries (with a sub group of the committee speaking to NASA and other engineers, including the battery manufacturer, and studying data from battery life tests in a laboratory) and concluded that the window for battery failure that would end science operations opens in about May 2007. The window for potential vehicle failure opens in 2009. While there are many considerations in coming to these dates, there are few options beyond servicing for improving the outcome. The batteries themselves are not greatly affected by lighter loading that might be possible by early termination of science operations since operations will already be terminated at an early date due to loss of gyros.

Comparison of Robotic Servicing, Shuttle Servicing and Rehosting

Let us leave aside for the moment the issue of placing the Hubble instruments on some other spacecraft and begin with the realization that, given the predicted failure of the on-board gyros, HST most likely will need to terminate science operations by mid-2007. Based on this engineering determination which we believe to be correct, any servicing mission, Shuttle or robotic, must be accomplished by the end of 2007 at the latest to prevent an interruption in science. A delay past 2007 not only results in increasing odds that the repair mission will meet an impaired Hubble when it launches. In the case of a robotic mission, it also means a growing reduction in the remaining lifespan of the serviced Hubble because, unlike a human servicing mission, it will be incapable of correcting most types of avionics system failures. A 2009 robotic mission would occur at a time when the telescope is already at the fifty percent risk point.

Even NASA's most optimistic projections places the robotic mission in December 2007, and this estimate was made when the NASA project hoped to receive full funding for development in both 2005 and 2006, something that has not occurred. Because the impact of reduced funding is always schedule delay, and often increased risk, there is a low probability of being able to undertake a successful robotic mission in time to save HST, even if much of the hardware has already been assembled and all of the systems testing had been successfully accomplished.

Now, let us compare a robotic servicing mission with a Shuttle servicing one. Some of the important strengths of a Shuttle servicing mission are (1) it has been done successfully before—four times in fact—so there is no new development required; (2) all of the instruments and replacement equipment have been built or can be made ready, so there is low schedule risk; (3) numerous life extension upgrades that are not feasible on a robotics mission could be carried out; (4) the Shuttle has a proven capability for repairing Hubble with one hundred percent success history from four missions; and (5) a human mission has the unique ability to respond to last-minute requirements, usually driven by unforeseen failure (such as the need for new magnetometer covers that occurred on SM-1). In addition, and very importantly, the SM-4 mission could reduce the risk and cost of the eventual de-orbit mission for Hubble by pre-positioning a docking mechanism and associated fiducials on the aft end of the telescope so that the rendezvous and docking of the de-orbit module would be greatly facilitated over the uncooperative target that the telescope presently offers to any robot approaching it. The main weaknesses in a Shuttle servicing mission are that the schedule depends on successful Shuttle Return-To-Flight (RTF), and there is a small crew safety risk by flying one Shuttle mission in addition to the 25 to 30 that are estimated by NASA as required for completion of the ISS. The additional Shuttle mission would also delay ISS assembly by three to five months, thereby increasing slightly Shuttle program costs (in comparison to total Shuttle program costs) at the end of the Shuttle life, currently projected for 2010.

The strengths of a robotic mission are (1) it avoids the risks to astronauts of one additional Shuttle flight; (2) it is exciting technology; and (3) some of the technology may have applications to other space activities. The weaknesses are primarily those associated with successfully achieving an extremely ambitious mission on an aggressive schedule, and the risk to HST (not only to HST science but also to eventual successful de-orbit) of using it as a target vehicle for the demonstration of unproven technology. It also has very large costs, both near- and far-term costs; an estimate of \$2.2 billion (or more including launch costs) was provided to NASA by the Aerospace Corporation. Those members of the committee who are familiar with such costs believe that this number is plausible.

From the risk mitigation viewpoint, the committee stated in our report that the planned use for the robotic servicing mission of the mature ISS robotic arm and robotic operational ground system helps reduce both the schedule risk and the development risk for this mission. However, the committee found many other serious challenges to the development of a successful robotic mission. Some of these challenges are due to the simple fact that Hubble was not designed to be serviced

robotically, and thus has hardware features that are designed for human, not robot, interactions. Challenging issues for a successful robotic mission include:

- Technologies required for close proximity operations and autonomous rendezvous and capture of the telescope have not been demonstrated in a space environment.
- The control algorithms and software for several proposed systems such as the laser ranging instrument (lidar) and the camera-based control of the grapple arm are mission-critical technologies that have not been flight-tested.
- Technologies needed for autonomous manipulation, disassembly and assembly, and for control of manipulators based on vision and force feedback have not been demonstrated in space.
- The Goddard HST project has a long history of Hubble Shuttle servicing experience, but little experience with autonomous rendezvous and docking or robotic technology development, or with the operations required for the proposed HST robotic servicing mission.
- The Committee found that the Goddard HST project had made advances since January 2004. However, the Committee also found that there remain significant technology challenges and—very significantly—major systems engineering and development challenges to successfully extend the lifetime of HST through robotic servicing.
- The proposed Hubble robotic servicing mission involves a level of complexity that is inconsistent with the current 39-month development schedule and would require an unprecedented improvement in development performance compared with that of space missions of similar complexity. The committee concluded that the likelihood of successful development of the HST robotic servicing mission within the baseline 39-month schedule is remote.

Rehosting

Rehosting of the two new instruments COS and WFC3 was the final option I was asked to discuss in my testimony today. In theory, the flight of these existing instruments on a new astronomy mission would be a possible means of obtaining some of the science that would otherwise be lost if Hubble were not repaired through a Shuttle servicing mission. The information that was provided by NASA to the committee on possible rehosting options was very sketchy, certainly not as defined and as detailed as was much of the technical information available for servicing Hubble. One clear advantage of any rehost mission is that it would use a spacecraft that employed current era technologies. Possible rehosting missions could be to either a low-Earth orbit (LEO), such as the one that Hubble is currently flying in, or to some other orbit, such as geosynchronous or a Lagrangian point. It was unclear to the committee which, if any, of these orbits was under any serious consideration by NASA. Thus, I have to speculate somewhat as to what might be being proposed today, some four months after the committee's last meeting.

A rehost mission to geosynchronous orbit or to a Lagrangian point would require the employment of launch vehicles that would permit the mission to arrive at, and to survive there. A spacecraft to a Lagrangian point location would likely involve a thermal design that was simpler than is used on Hubble since no eclipses would occur in that orbit. At geosynchronous orbit, eclipses occur twice a year, such as geosynchronous communications spacecraft experience. The relative absence of eclipses at geosynchronous or at a Lagrangian point would also allow a higher duty cycle for the acquisition of science data. Any new telescope located at either location would not be practical to service, a feature that has allowed the HST to be continually upgraded since launch.

Independent of the lack of solid technical (to say nothing of lack of schedule) information on rehost options, the committee had a number of important concerns with respect to the practical aspects of rehosting. In order to obtain science returns from the COS and the WFC3 comparable to the return from the instruments if they were flown on Hubble, the new satellite would have to carry a 2.4 meter diameter mirror, with diffraction-limited performance down to the ultraviolet (such a mirror diameter is especially necessary for the science of the WFC3 instrument), together with a very accurate pointing and guiding system that would be consistent with HST's capabilities. The two instruments would also have to be modified from their present states in order to be able to effectively use the new un-aberrated mirror that would likely be designed and built for the new spacecraft. (It seems inconceivable to me that an aberrated mirror would be purposefully designed for a brand new spacecraft just to match the Hubble's aberrated mirror.) In essence then, NASA would need to commit to, and to build and fly, a new Hubble telescope with an unaberrated mir-

ror. The original Hubble development and testing program involved a lengthy and costly process. For mission success, this new rehost development program would require a commitment of very significant resources as well as political support over an interval of several years. The committee questioned whether such a commitment is likely to be given, let alone sustained in the face of numerous competing, high-priority, peer-reviewed astronomy programs that are already planned.

Even if the new Hubble program were adequately supported, such a program would come with the added risks that technical problems could halt or seriously delay development. In addition, as already noted in the Aerospace Corporation report, it was not clear to the committee that there would be significant cost savings over the options for a Shuttle SM-4 repair mission, particularly given the uncertainties of developing an entirely new satellite that performs like the original Hubble. Finally, unlike a Hubble repair, a satellite with rehosted instruments would represent a significant new astronomy program that never was carefully evaluated for cost and schedule in the deliberative, detailed planning process that was carried out for astronomy research in the most recent Decadal Survey—a process that involved a great many resource and schedule trade-offs.

The SM-4 Hubble service mission has been in NASA plans and budgeting profiles for years. In contrast, it would appear that any consideration of any rehosting option would need to obtain and to critically evaluate accurate data on the costs for a satellite development mission of a complexity almost identical to that for the original Hubble. In addition, the review of a rehosting mission by the astronomy community would have to establish its relative priority for funding and scheduling in terms of planned and on-going programs.

For these reasons, I personally would have strong reservations regarding a plan to rehost the COS and the WFC3 Hubble instruments on another satellite, particularly when compared to a Shuttle repair mission. If a Shuttle repair mission were not possible—if for instance NASA was not successful in returning Shuttle to flight—then I would argue that the trade-offs of performing a rehosting mission should be reviewed by the astronomy community in the context of its overall planning for space astronomy in the next decade.

In conclusion, I would like to reiterate the committee's conclusions that Hubble is a scientific asset of extraordinary value to the Nation, and that Shuttle servicing is the best option for extending the life of Hubble.

Thank you for the opportunity to appear before you today. I am prepared to answer any questions that you may have.

BIOGRAPHY FOR LOUIS J. LANZEROTTI

Louis J. Lanzerotti (Chair) currently consults for Bell Laboratories, Lucent Technologies and is a distinguished professor for solar-terrestrial research at the New Jersey Institute of Technology. Dr. Lanzerotti's principal research interests have included space plasmas, geophysics, and engineering problems related to the impact of space processes on space and terrestrial technologies. He was Chair (1984–1988) of NASA's Space and Earth Science Advisory Committee and a member of the 1990 Advisory Committee on the Future of the U.S. Space Program. He has also served as Chair (1988–1994) of the Space Studies Board and as a member (1991–1993) of the Vice President's Space Policy Advisory Board. He has served on numerous NASA, National Science Foundation, and university advisory bodies concerned with space and geophysics research. He is a member of the International Academy of Astronautics and is a fellow of the Institute of Electrical and Electronics Engineers, the American Geophysical Union, the American Institute of Aeronautics and Astronautics, the American Physical Society, and the American Association for the Advancement of Science. He is an elected member of the National Academy of Engineering and has an extensive history of NRC service.

THE NATIONAL ACADEMIES
Advisers to the Nation on Science, Engineering, and Medicine

Space Studies Board
Aeronautics and Space Engineering Board

500 Fifth Street, NW
Washington, DC 20001
Phone: 202 334 3477
Fax: 202 334 3701
E-mail: ssb@nas.edu
www.nationalacademies.org/ssb

January 28, 2005

The Honorable Sherwood L. Boehlert
U.S. House of Representatives
Chairman, Committee on Science
2320 Rayburn House Office Building
Washington, DC 20515

Dear Chairman Boehlert:

On February 2, 2005, I will testify on behalf of the Committee on Assessment of Options to Extend the Life of the Hubble Space Telescope of the National Academies at the House Science Committee's hearing on "Options for Hubble Science". As required by the Rules of the House of Representatives, witnesses must reveal the sources of federal funding that directly support the subject matter on which they will testify. I have never had any federal funding related to the Hubble Space Telescope program, nor have I ever been involved scientifically with the Hubble program. I have no funding from any other government or non-government sources related to the Hubble program. I presently have some NASA research funding from the ACE and Ulysses spacecraft programs.

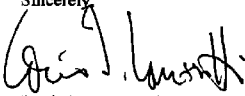
Sincerely,

Louis J. Lanzerotti
Chair
Committee on Assessment of Options to Extend the Life
of the Hubble Space Telescope
Space Studies Board

BIOGRAPHY FOR CHARLES F. BOLDEN, JR.

CHARLES F. BOLDEN, Jr., a retired USMC major general, is a Senior Vice President at TechTrans International, Inc. Selected as an astronaut candidate by NASA in 1980, Mr. Bolden qualified as a Space Shuttle pilot astronaut in 1981 and subsequently flew four missions in space. As pilot of the Space Shuttle Discovery in 1990, Mr. Bolden and crew successfully deployed the Hubble Space Telescope. On his third mission in 1992, he commanded the Space Shuttle Atlantis on the first Space Laboratory (SPACELAB) mission dedicated to NASA's "Mission to Planet Earth." Immediately following this mission, Mr. Bolden was appointed Assistant Deputy Administrator for the NASA. He held this post until assigned as commander of STS-60, the 1994, the first joint U.S./Russian Space Shuttle mission. Upon completion of this fourth mission, Major General Bolden left the space program and returned to active duty in the U.S. Marine Corps as the Deputy Commandant of Midshipmen at the Naval Academy after leaving NASA. Mr Bolden served on the NRC Committee on the Navy's Needs in Space for Providing Future Capabilities (2003-2004).

THE NATIONAL ACADEMIES*Advisors to the Nation on Science, Engineering, and Medicine***Space Studies Board
Aeronautics and Space Engineering Board**

500 Fifth Street, NW
Washington, DC 20001
Phone: 202 334 3477
Fax: 202 334 3701
E-mail: sab@nas.edu
www.nationalacademies.org/sab

January 28, 2005

The Honorable Sherwood L. Boehlert
U.S. House of Representatives
Chairman, Committee on Science
2320 Rayburn House Office Building
Washington, DC 20515

Dear Chairman Boehlert:

On February 2, 2005, I will testify on behalf of the Committee on Assessment of Options to Extend the Life of the Hubble Space Telescope of the National Academies at the House Science Committee's hearing on "Options for Hubble Science". As required by the Rules of the House of Representatives, witnesses must reveal the sources of federal funding that directly support the subject matter on which they will testify. I neither now nor ever have received federal funding for any work related to the Hubble Space Telescope. My only connections with HST have been as an astronaut crew member of STS-31 in 1990 when we made the initial deployment of the observatory and this committee of the National Academies. I have no funding from any other government or non-government sources related to the Hubble Space Telescope.

Sincerely,



Charles F. Bolden Jr.
Committee member
Committee on Assessment of Options to Extend the Life
of the Hubble Space Telescope
Space Studies Board

BIOGRAPHY FOR JOSEPH H. ROTHENBERG

JOSEPH H. ROTHENBERG is currently President and a member of the Board of Directors of Universal Space Network. Mr. Rothenberg, who joined NASA in 1983, was named Associate Administrator for Space Flight January 1998 and was in charge of NASA's human exploration and development of space. Before coming to NASA Headquarters, he served as Director of the NASA Goddard Space Flight Center. As AA, Mr. Rothenberg was responsible for establishing policies and direction for the Space Shuttle and International Space Station programs, as well as for space communications and expendable launch services. Rothenberg joined Goddard in 1983 and was responsible for space systems development and operations, and for execution of the scientific research program for the NASA Earth-orbiting science missions. He is widely recognized for leading the development and successful completion of the first servicing mission for the Hubble Space Telescope, which corrected the telescope's flawed optics. From 1981 to 1983, he served as Executive Vice President of Computer Technology Associates, Inc., Space Systems Division where he managed all ground test and operations systems-engineering projects. Those projects included the Hubble Space Telescope, Solar Maximum repair mission, and space tracking and data system architecture projects.

THE NATIONAL ACADEMIES*Advisors to the Nation on Science, Engineering, and Medicine*

**Space Studies Board
Aeronautics and Space Engineering Board**

500 Fifth Street, NW
Washington, DC 20001
Phone: 202 334 3477
Fax: 202 334 3701
E-mail: asb@nas.edu
www.nationalacademies.org/teeb

January 28, 2005

The Honorable Sherwood L. Boehlert
U.S. House of Representatives
Chairman, Committee on Science
2320 Rayburn House Office Building
Washington, DC 20515

Dear Chairman Boehlert:

On February 2, 2005, I will testify on behalf of the Committee on Assessment of Options to Extend the Life of the Hubble Space Telescope of the National Academies at the House Science Committee's hearing on "*Options for Hubble Science*". As required by the Rules of the House of Representatives, witnesses must reveal the sources of federal funding that directly support the subject matter on which they will testify. At this time, I have no sources of federal funding for the Hubble Space Telescope Program or Servicing activities, nor do I receive funding from any other sources relevant to the issues on which I will testify.

Sincerely,

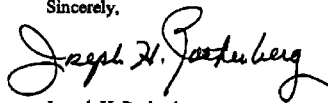

Joseph H. Rothenberg
President
Universal Space Network
1501 Quail Street
Newport Beach, CA 92660
Committee Member
Committee on Assessment of Options to Extend the Life
of the Hubble Space Telescope
Space Studies Board

Chairman BOEHLERT. Thank you very much, Dr. Lanzerotti. I really appreciate it. Dr. Taylor.

STATEMENT OF DR. JOSEPH H. TAYLOR, JR., CO-CHAIR, ASTRONOMY AND ASTROPHYSICS SURVEY COMMITTEE, NATIONAL RESEARCH COUNCIL, THE NATIONAL ACADEMIES

Dr. TAYLOR. Chairman, Mr. Gordon, and Members of the Committee, thank you very much for inviting me to testify. My name is Joseph Taylor, and I am Professor of Physics and former Dean of the Faculty at Princeton University. I appear here this morning in my capacity as Co-Chair of the Astronomy and Astrophysics Survey Committee.

The astronomy community has a long history of undertaking broad surveys of astronomical science at 10 year intervals. The surveys identify key scientific questions that need to be answered. They lay out principal research goals for the next decade, and they propose new facilities that will make these goals achievable. A distinguishing feature of the surveys is a prioritized list of missions and facilities recommended for construction, a list that is put together with great care. The National Science Foundation and NASA both use the survey reports as a basis for their planning, and the vast majority of the projects recommended in previous surveys have been completed. Those projects have much to do with the leadership position our nation enjoys in the astrophysical sciences.

The most recent Survey Committee understood that a mid-decade servicing mission to the Hubble Space Telescope would install two important new instruments, a wide field camera, and a spectrograph. The mission would also service the satellite in other ways, so that Hubble could remain productive throughout the decade, at the end of which, NASA's follow-on facility, now called the James Webb Space Telescope, would become operational. The Committee was informed that the mission would cost \$350 million, and that cost estimate helped to shape our final priority list.

The Hubble telescope was a truly remarkable instrument. It has made enormous contributions to astronomy and it has helped to inspire a whole generation of young Americans to go into science, engineering, and the other technical fields that contribute so much to our national prosperity. My Committee was charged with looking ahead, however, and we concluded that answers to many of the important astrophysical questions most ripe for scientific progress in this decade are likely to be found at spectral wavelengths outside the Hubble telescope's capabilities.

Two of our three top priorities are therefore the James Webb Space Telescope, which will operate in the infrared, and the Constellation X-ray Observatory. We can never be sure of where the next scientific breakthroughs will arise, but the future of those missions seems particularly bright. The Webb telescope will be able to observe and examine the very first galaxies that formed in our universe, and the very first—the ignition of the very first stars. Constellation-X will examine how matter and energy behave in the extreme environments near black holes, conditions in which some of the most fundamental physical theories have never yet been tested. The Survey Committee made the tough decision to push space astrophysics into new frontiers in the infrared and X-ray regions of

the spectrum. In this context, it is very difficult for me to say that knowledge of the premature loss of the Hubble would have significantly altered our priority list. Perhaps the Committee would have given higher ranking to a project called the Space Ultraviolet Observatory, which was omitted from our final list, but I do not believe that the other priorities would have been much altered.

Mr. Chairman, my Committee was making judgments about scientific payoffs some years in the future, but I know yours is grappling with decisions that need to be made very soon. Accounting methods and other changes at NASA since completion of our survey now make it seem very unlikely that a Shuttle servicing mission would cost the Science Directorate as little as \$350 million. Present estimates seem to run to at least a billion dollars, whether the servicing is done by manned Shuttle or by robot. That cost is roughly the equivalent of a second James Webb telescope, and if borne by NASA's science program alone, would likely delay important new missions under development, including those ranked very highly across all fields of space science.

You will hear about possible rehosting of the Hubble replacement instruments on a new satellite called the Hubble Origins Probe. Cost estimates for this project are also around a billion dollars, and the telescope might be ready by the year 2010. Such a satellite does offer significant promise. However, to start work on it now would be to insert an entirely new priority into the mission queue without benefit of comprehensive peer review, like those undertaken for all existing survey priorities. Though from the point of view of the Survey Committee, I believe that neither a billion dollar servicing mission nor a billion dollar rehosting satellite should be a higher funding priority than the new astronomical projects recommended by the Committee.

Our nation's science enterprise has been extremely well served by having open, broadly based mechanisms for setting priorities in astronomy, and by closely following those roadmaps. I think you will do well to see that the agencies continue to follow the good advice on priorities they have received.

As you know, I am also a member of the Committee on Assessment of Options to Extend the Life of the Hubble Space Telescope. I most heartily endorse that Committee's recommendation that NASA should pursue a servicing mission to accomplish the original objectives of the SM4 servicing mission. However, I do not favor such a plan, much less the launch of a wholly new satellite to host the Hubble replacement instruments, if it would require major delays or reordering of the Survey Committee's science priorities. If NASA follows such a course, I believe it will squander the excellent reputation for scientific leadership and judgment that it has so rightly earned over the years.

Thank you for your attention, and I will be pleased to answer questions.

[The prepared statement of Dr. Taylor follows:]

PREPARED STATEMENT OF JOSEPH H. TAYLOR, JR.

Mr. Chairman, Ranking Minority Member, and Members of the Committee: thank you for inviting me here to testify today. My name is Joseph Taylor and I am the James S. McDonnell Distinguished University Professor of Physics and former Dean

of the Faculty at Princeton University. I appear today in my capacity as Co-chair of the Astronomy and Astrophysics Survey Committee.

As you know, the Astronomy community has a long history of creating, through the National Research Council (NRC), broad surveys of the field at ten-year intervals. These surveys lay out the community's research goals for the next decade, identify key questions that need to be answered, and propose new facilities with which to conduct this fundamental research. The most recent decadal survey, entitled *Astronomy and Astrophysics in the New Millennium*, was released in the year 2000.¹ I have been asked to answer the following questions from my perspective as the Co-chair of the committee that produced that report:

1. To what extent, and in what ways, was the Decadal Survey premised on the Hubble Space Telescope having additional instruments that were to be added by a servicing mission? Would the loss of the Hubble cause you to entirely rethink your priorities? Would that change if the *Hubble Origins Probe* or a similar rehost mission is launched?
2. How important are the contributions that would be expected from extending the life of the Hubble Space Telescope when compared to advancements expected from other astronomical programs at NASA to be launched in the next decade, such as the James Webb Space Telescope?
3. Should either a Hubble servicing mission (whether by robot or by Shuttle) or a new telescope such as the Hubble Origins Probe be a higher priority for funding than other astronomical programs at NASA?

In the balance of my testimony I shall address all three questions.

Until recently, the NRC decadal survey was an activity unique to the discipline of astronomy and astrophysics. The most recent survey involved the direct participation of 124 astronomers; moreover, the direct participants received input from many hundreds more of their colleagues. Altogether, a substantial fraction of the Nation's astronomers were in some way involved in the creation of the report. By gathering such broad community input, the survey process creates a document that reflects the consensus opinion of the researchers in the field. The value of this activity to NASA and the NSF has been demonstrated in many ways, and most recently by NASA's request for the NRC to conduct similar surveys for planetary science,² solar and space physics,³ and Earth science.⁴

The feature of the decadal Astronomy Survey that distinguishes it from summaries of other fields of science is the prioritized list of missions and facilities that are recommended for construction. This list is put together very carefully; many worthy projects do not make the list, while others are deferred to the next decade. I can assure you that the decision-making process is very thorough and sometimes leaves some "blood on the floor," metaphorically speaking. One of the factors that make the process possible is the remarkable success of the surveys. The National Science Foundation and NASA have used the survey reports as the basis of their planning processes, and the vast majority of recommended projects from previous surveys have been completed—even if they have sometimes stretched over the boundaries from decade to decade. The completed projects have much to do with the leadership position of our national enterprise in the astrophysical sciences.

The process of priority setting is based on a set of assumptions. For the purposes of this hearing, the most important of these is that priorities from previous decades should be completed. For example, the year 2000 Survey reaffirmed the importance of completing the Atacama Large Millimeter Array that had been recommended in the 1991 Survey.⁵ Along the same lines, the most recent Survey was based on the expectation that a Shuttle Servicing Mission would install in the Hubble Space Telescope new instruments called the Cosmic Origins Spectrograph and Wide Field Camera-3, and would refurbish the satellite in other ways so that Hubble would continue to operate until 2010—about the time that the infrared James Webb Space Telescope (JWST) is planned to become available.⁶ We were told that this mission, now referred to as SM-4, would cost \$350 million, and it was one of the considerations that led to the final shape of the priority list.

There are a number of strong arguments for keeping the Hubble telescope operational until JWST is ready. The new instruments will expand Hubble's reach far-

¹*Astronomy and Astrophysics in the New Millennium*, NRC, 2001.

²*New Frontiers in the Solar System*, NRC, 2003.

³*The Sun to the Earth—and Beyond*, NRC, 2003.

⁴Study underway—<http://qp.nas.edu/decadalsurvey>

⁵*A Decade of Discovery*, NRC, 1991.

⁶The James Webb Space Telescope (then referred to as the Next Generation Space Telescope) was the highest priority recommendation of *Astronomy and Astrophysics in the New Millennium*.

ther into the near-infrared region of the spectrum. This capability will enable the selection of potentially interesting targets that will form much of the basis of the initial JWST research program. The Hubble Space Telescope is still in the prime of its scientific life. Even with some temporarily reduced capacity, astronomers are using it to observe objects that were thought to be beyond any telescope's capability. Hubble is also important to the Nation for reasons beyond its immediate scientific contributions. According to a recent NRC study, nearly one third of all federal support for astronomy research is tied to the Hubble telescope and its affiliated research programs.⁷ NASA, in consultation with the community, plans to transfer these programs to the James Webb Space Telescope when it becomes operational; but the premature loss of Hubble would threaten the continuity and vitality of this research enterprise, and this source of highly trained technical personnel for the Nation.

We all love Hubble. It is truly a remarkable instrument. That said, the object of my committee's decadal survey was to look ahead and identify the tools that would be needed to continue answering deep questions about the Universe and the most fundamental laws of Nature. In the Survey committee's judgment, in the present decade answers to these questions are more likely to be found in regions of the spectrum outside the Hubble telescope's capabilities. Top Survey priorities such as JWST and the Constellation X-Ray (Con-X) observatory will open large spectral windows on the universe that are simply not available to instruments on the ground. While we can never be sure where the next scientific breakthrough will arise, the future with these missions seems very bright. JWST will be able to observe and examine the very first galaxies that formed in our Universe, and to study the era when the first stars ignited. Con-X will be able to observe how matter and energy behave near black holes—an extreme environment in which the laws of physics have not yet been well tested.

The Survey does not neglect the optical region of the spectrum. Two of the Survey's top three recommendations for ground-based facilities are for new optical telescopes that will observe the universe in new and different ways.⁸ While Hubble can do some things that are unmatched by telescopes on the ground, the choice to move space astrophysics into the infrared and X-ray regions of the spectrum was one of the difficult decisions that the committee made. In this context, it is difficult to say that the premature loss of the Hubble telescope would significantly alter the Survey's priority list. It is possible that the committee would have given a stronger priority to the Space Ultraviolet Observatory (SUVO), which was omitted from the final priority list; but I do not believe that the rest of our list would have been very different.

Mr. Chairman, the scientific promise of JWST and other Survey priorities lies in the future, while your committee is grappling with decisions that need to be made very soon. Accounting methods and other changes that have taken place at NASA since the completion of the Survey now make it seem very unlikely that a Shuttle servicing mission would cost the science mission directorate as little as \$350 million. However the Hubble telescope is serviced, present cost estimates seem to run to at least \$1 billion—roughly equivalent to that of a second JWST. Such a cost, if borne by the science program, will likely delay a number of other missions that are under development, including those ranked highly in NRC decadal surveys across all of space science.

One option that I have not yet mentioned is to host the Hubble replacement instruments COS and WFC3 on a new satellite like the proposed Hubble Origins Probe (HOP). According to the team proposing HOP, the cost for such a mission would also be roughly \$1 billion, and the telescope would be ready by 2010. The proposal also calls for an additional wide-field imaging camera. Such a satellite offers significant promise; however, to start work on it would in essence insert a new priority into the mission queue, without benefit of the kind of comparative review undertaken in the survey. From the point of view of the survey committee, I believe that neither a \$1 billion servicing mission nor a \$1 billion rehosting satellite should be a higher funding priority than the astronomical science priorities recommended by the survey committee.

Our nation's science enterprise has been well served by having open, broadly based mechanisms for setting priorities in astronomy, and by closely following the wise decisions made in that way. A project similar to the Hubble Origins Probe could easily be included in the next Astronomy Survey, and would likely be a strong contender then. As you know, I am also a member of the Committee on Assessment of Options to Extend the Life of the Hubble Space Telescope. I heartily endorse that

⁷ *Federal Funding of Astronomical Research*, NRC, 2000, pg. 54.

⁸ The Giant Segmented Mirror Telescope and the Large Survey Telescope

committee's recommendation that NASA should pursue a Shuttle servicing mission to Hubble so as to accomplish the objectives of the planned SM-4 mission. However, I do *not* favor such a plan, much less the launch of a new satellite to host Hubble's replacement instruments, if it would require major delays or re-ordering of the Survey Committee's science priorities. With such a course of action, I believe that NASA would squander the excellent reputation for scientific judgment and leadership that it has so rightly earned over the years.

I should stress that these opinions are my own, informed by my work on the survey and other advisory committees and by conversations with many colleagues.

Thank you for your attention, and I would be pleased to answer questions.

BIOGRAPHY FOR JOSEPH H. TAYLOR, JR.

Joseph H. Taylor, Jr. is the James S. McDonnell Distinguished University Professor of Physics and former Dean of the faculty at Princeton University. He is a radio astronomer and physicist who, with Russell A. Hulse, was the co-recipient of the 1993 Nobel Prize for Physics for their joint discovery of the first binary pulsar. He has won several other awards, including the Wolf prize in Physics, The National Academy of Sciences Henry Draper medal, the American Astronomical Society's Dannie Heineman prize, the Magellanic Premium of the American Philosophical Society, and he was the Albert Einstein Society's Einstein Prize Laureate. Taylor is an elected member of the National Academy of Sciences, and he has served as Co-chair of the NRC Task Group on Gravity Probe B (1994–1995) and member of the Committee on Space Astronomy and Astrophysics (1981–1982), the Committee on Radio Frequencies (1980–1986). He also served as Co-chair of the Astronomy and Astrophysics Survey Committee (1998–2000), and currently serves on the Board on Physics and Astronomy.

Chairman BOEHLERT. Thank you. Dr. Beckwith.

STATEMENT OF DR. STEVEN V.W. BECKWITH, DIRECTOR, SPACE TELESCOPE SCIENCE INSTITUTE

Dr. BECKWITH. Chairman Boehlert, Mr. Gordon, Members of the Committee, I deeply appreciate the opportunity to testify today on behalf of the Space Telescope Science Institute.

The Institute, commonly called STSCI, is managed by OAR under contract with NASA. The Institute was set up 24 years ago to carry out the science operations for Hubble. More recently, we were assigned the full responsibility of operating the spacecraft itself. We have a vital interest on behalf of astronomers worldwide to operate this in the most scientifically productive manner possible.

At the outset, I want to commend the Committee for holding this hearing on the very important matter. The Hubble Space Telescope was designed to measure the age of the universe, explore the nature of distant galaxies, measure the mass of black holes, detect the dark matter between galaxies, study the nature of stars in the Milky Way and neighboring galaxies, and even planets in our own solar system, sort of the whole shebang, as we say in astronomy.

It made tremendous progress on all of these goals within a few years of launch, but more importantly, Hubble opened up entirely new fields of research not included in its initial goals. Hubble has invented or captured entire subfields of astronomy, such as the study of the creation of galaxies, the nature of dark energy in the early universe, the study of atmospheric chemistry in extra-solar planets, that rank among the premiere scientific problems of our time. The United States has achieved preeminence in these areas with Hubble, a preeminence we do not want to lose.

Just as important as Hubble's scientific contributions is its impact on education and public awareness of science. Hubble has be-

come an international icon of humankind's scientific prowess. The vivid colors and rich information content of its images with unparalleled resolution captivate millions of Americans each year. Hubble's pictures make even esoteric concepts about the universe accessible to schoolchildren. And if I can just give a personal remark, one of my vivid memories of coming to Baltimore six years ago was going to Dumbarton Middle School, where both of my children were enrolled, on parent visiting night. I saw Hubble pictures in every classroom on my kids' schedule, including English, health, and social studies, in addition to their science classrooms. Hubble has been one of our most important tools to excite children about science at a time when the need for a technically astute workforce is more important than ever to our economic future.

An essential element of Hubble's enormous success is NASA's ability to upgrade the scientific instruments with modern technology through servicing by Shuttle astronauts. Some of the most important problems Hubble tackles, such as the dark energy and extra-solar planet studies, were not even active topics of observational research when Hubble was designed in the 1980s, and therefore, were not part of Hubble's mission goals. Hubble's enormous impact in helping us uncover the secrets of the cosmos has come out because it has continually improved through periodic servicing, and it is a general purpose observatory that can respond to new discoveries in a way that particular targeted missions cannot.

At present, there is no other mission planned or under construction to duplicate Hubble's capabilities and major strengths. It is essential that we complete the Hubble mission, and let it fulfill its scientific potential in preparation for the era that will be dominated by the James Webb Space Telescope, the Terrestrial Planet Finder, and other astronomical missions in NASA's strategic plan.

Fortunately, there are at least two ways to service Hubble, using the Space Shuttle and using robots, that would realize the great future promise of NASA's original plan. Timeliness is an important element of scientific success, as well as mission success, and it should be a factor in weighing any options to retain Hubble science. Among the proposed options you will hear today, it appears now that servicing with astronauts would provide the most expeditious path. Servicing by robots would be the next most timely option, and building a replacement would take the longest. As a scientist, I would like to see our important scientific capabilities established as soon as possible, so I favor the servicing of Hubble.

You will hear different views today from others more expert in the risks and costs associated with each option. One area which I believe all speakers today will agree, however, is that it is vital for us to preserve this scientific and education capability for the Nation. It is definitely feasible to do so, and it should become a very high priority for support this year.

I will welcome your questions on any aspect of this issue. Thank you, Mr. Chairman.

[The prepared statement of Dr. Beckwith follows:]

PREPARED STATEMENT OF STEVEN V.W. BECKWITH

- 1. What are the Hubble Space Telescope's most important contributions to the advancement of science? How important are those contributions**

compared to advancements expected from other astronomical programs at NASA, such as the James Webb Space Telescope to be launched in the next decade?

The Hubble Space Telescope (HST) was built to measure the age of the universe, explore the nature of distant galaxies, measure the mass of black holes, detect the dark matter between galaxies, study the nature of stars in the Milky Way and neighboring galaxies and even planets in our own solar system. It made tremendous progress on all of these goals within a few years of launch. More importantly, Hubble opened up entirely new fields of research not included in its initial goals. Hubble looked back close to the time of creation by observing the assembly of the first galaxies when the universe was only seven percent of its present age, it confirmed that the universe is accelerating, one of the most profound discoveries in 100 years, it obtained images of young solar systems around other stars before planets had formed, it detected extra-solar planetary systems and even measured the atmospheric chemistry of one extra-solar planet. Most recently, Hubble helped discover the most distant object in the Solar System.

The Hubble Space Telescope has far outpaced everyone's early expectations of success. An essential element of that broad success is NASA's ability to upgrade the scientific instruments with modern technology through servicing by Shuttle astronauts. Hubble is currently poised to address several of the most important problems in astrophysics, indeed, in all of science over the next five to ten years, if new instruments are installed on another servicing mission. Two of these problems, the nature of dark energy that powers the acceleration of the universe and the properties of extrasolar planetary systems, were not even active topics of observational research when Hubble was designed in the 1980's and therefore were not part of Hubble's mission goals. Hubble's enormous impact in helping us uncover the secrets of the cosmos has come about because it is a multi-purpose observatory with observational powers greatly exceeding those required for a single problem or set of problems that the mission designers could divine before it was launched.

Hubble's discoveries drove it to the top of the Nation's most productive scientific facilities. By the metrics we use to measure scientific success, Hubble is number one. It annually produces more scientific papers that collectively receive more citations in the scientific literature than any other astronomical observatory or instrument. The widely used Davidson Science News metric, NASA's own measure of the relative successes of its different missions, ranked Hubble number one in science impact for the last ten years. In 2004, the most recent year for which this metric is available, Hubble had almost twice as many important discoveries as the next highest producer among NASA missions, and it was the only one of the top 25 most productive missions to gain discovery points. It shows no signs of slowing down.

Just as important as Hubble's scientific contributions is its impact on education and public awareness of science. Its pictures reveal the complex structure of galaxies and nebulae. The vivid colors and rich information content of its images with unparalleled resolution captivate millions of Americans and people around the world each year. Hubble's pictures make even esoteric concepts about the universe accessible to school children. One of my first memories of coming to Baltimore six years ago was going to Dumbarton Middle School on parent visiting night where both my children enrolled. I saw Hubble pictures in every classroom on my kids' schedule, including English, social studies, and health in addition to their science classrooms. Hubble has been one of our most important tools to excite children about science at a time when the need for a technically astute workforce is more important than ever to our economic future.

At present, there is no other mission planned or under construction to duplicate Hubble's capabilities and major strengths. The James Webb Space Telescope (JWST) is designed to have the same angular resolution—or sharpness of image—as Hubble covering a different wavelength band and with greater light gathering power. The tremendous advances enabled by Hubble have driven the scientific community to pose questions that were not even imagined a decade ago, but now form the basis for the JWST mission.

The James Webb Space Telescope complements the Hubble Space Telescope as part of a continuous, balanced program to study the universe with flagship observatories. Hubble's sensitivity to ultraviolet and visual light and its high performance now make it an enormous value to astronomy. JWST's coverage of infrared wavelengths and large collecting area will make it an essential asset when it is launched. JWST's anticipated success in the future guarantees its high priority for the next decade.

Because of the strong scientific relationship between HST and JWST, the original plan envisioned by the scientific community would have allowed an overlap of sev-

eral years to accomplish an orderly transition of observing programs. We now realize that HST's future potential is even more important than previously thought owing to new discoveries about the universe and its constituents from HST and other facilities. It is essential to complete the HST mission and let it fulfill its scientific potential in preparation for the era that will be dominated by JWST, the Terrestrial Planet Finder, and other astronomical missions in the NASA Strategic Plan.

2. Should a Hubble servicing mission be a higher priority for funding than other astronomical programs at NASA?

Setting priorities for astronomical programs at NASA is normally done in three ways. The first is the National Academy of Sciences' Decadal Surveys done every ten years to provide a long-term look especially at large missions. The most recent Decadal Survey (*Astronomy and Astrophysics in the New Millennium* 2001) considered NASA's plan to service Hubble with SM-4 and operate it until the end of the decade, 2010. The survey committee believed that was a good plan and one that they supported even with the demands of competing new instruments such as the James Webb Space Telescope.

The second is to have special "blue ribbon" committees examine particular issues or proposals in between the Decadal surveys. These committees draw their members from the elite of the scientific establishment who are not direct beneficiaries of the missions under review. Two such committees recently reviewed Hubble: the Bahcall committee (chartered by NASA's Office of Space Science) in August 2003 and the Lanzerotti committee (chartered by the National Academy of Sciences) in December 2004 (*Assessment of Options for Extending the Life of the Hubble Space Telescope* (2005)). Both committees had winners of the most prestigious research prizes in science, including the Nobel prize, and the latter committee also had a large number of distinguished engineers, astronauts, and former senior managers from the aerospace industry, military, and NASA, including an ex-NASA Administrator. Both committees gave a strong endorsement to the fifth Hubble servicing mission, SM-4. The Lanzerotti committee stated that the future scientific returns from Hubble are likely to be as important as its past discoveries. No other NASA mission has been so extensively reviewed by independent committees of such high capability and prestige.

The third is NASA's own advisory system. In that system, representatives of different subfields of astronomy advise NASA on the relative merits of their projects. The most recent resolution about SM-4 came from the Space Science Advisory Committee (SScAC) meeting of November 2003, in which the committee reaffirmed that continuing Hubble's success in this decade with SM-4 is essential to a balanced program of high-profile astronomical research.

3. What are the comparative strengths and weaknesses of a Shuttle servicing mission, a robotic servicing mission, and a mission to fly elements of a Hubble servicing mission rehosted on a new telescope?

The Lanzerotti report concludes that a Shuttle servicing mission, SM-4, would give us the most scientific capability in the shortest amount of time at the lowest risk among the three options. Time is an important advantage that is often neglected as a factor in scientific importance. SM-4 gives us two new instruments in addition to Hubble's current suite in about three years, continuing to provide overlap with NASA's other Great Observatories, Spitzer and Chandra, for example. It would extend Hubble's lifetime another four to six years (likely overlapping early operations of JWST), and it would provide us with the possibility of fixing the currently inoperative Space Telescope Imaging Spectrograph to further enhance Hubble's scientific power. Since the instruments and other components needed to service Hubble are nearly ready for flight, the costs to the science budget, exclusive of Shuttle infrastructure costs, are likely to be relatively low and predictable compared to the four previous servicing missions. The chances of mission success are very high, as the Lanzerotti report emphasized, consistent with four successful servicing missions in which 18 consecutive space walks achieved all of their objectives.

A successful robotic servicing mission could give us much of the same new scientific capability as SM-4 depending on how it is planned, but somewhat later in time. It is unclear how the cost of a robotic servicing mission would be shared between the science budget and the budget for the new exploration initiative. It is important to distinguish between a robotic mission that has the capability to install the new instruments and upgrade Hubble's batteries and gyroscopes from one that simply de-orbits the telescope. NASA has committed to a de-orbit mission that by itself would produce no new science. In these remarks, I refer to a mission that would upgrade Hubble's scientific instruments and increase its lifetime as well as install a de-orbit module.

The robotic mission would be able to install new instruments, batteries and gyroscopes, although it would not be able to repair some of the infrastructure items normally done by astronauts. Thus, Hubble's lifetime following a robotic mission is likely to be shorter than that following SM-4, although an exact number is a matter of debate. The chances of mission success with robots are likely to be smaller than for SM-4, simply because robotic servicing is untested and without the flexibility that humans bring to any task with unforeseen problems.

On the other hand, a robotic servicing mission would demonstrate new technology that could be important to NASA's new exploration initiative and to future scientific facilities that are not accessible to humans. Thus, the potentially higher cost and risk would be offset by the future potential of using this technology for other missions. Indeed a whole generation of future scientific missions might be enabled by a robotic capability initiated in this decade. The robotic option also has the advantage of providing Hubble with the de-orbit module capability it needs to be safely de-orbited at the end of its life.

The third option, rehosting, could recover some of the science capabilities of a fully serviced Hubble. I assume here that rehost means building an equivalent sized telescope to Hubble containing the two new instruments already built, the Cosmic Origins Spectrograph (COS) and the Wide Field Camera 3 (WFC3) as assumed in the Aerospace Corporation study of alternatives to Hubble servicing. Such a telescope will deliver less scientific capability at a much later time with higher risk than servicing Hubble. The new telescope would have to have a 2.4m mirror with a pointing stability of a few milliseconds of arc, the most challenging part of Hubble's construction. That mission would be launched in approximately eight years, according to the Aerospace study. Thus, we would have a Hubble Lite with two working instruments in 2013 rather than a full Hubble with four to five working instruments (depending on STIS) in 2007 or 2008.

Time is an important element in this case, because Hubble Lite would become available after the currently planned launch date of JWST in 2011. JWST's infrared capabilities will supercede those of WFC3. The lack of two of Hubble's current instruments, the Advanced Camera for Surveys (ACS) and Near Infrared Camera and Multi-Object Spectrometer (NICMOS) means that two of the four most compelling future science projects with Hubble that I discussed with the Lanzerotti committee would be impossible. My understanding from the Aerospace study is that even Hubble Lite would cost the science budget between \$1.5 and \$2 billion, not unreasonable considering the cost to build Hubble in the first place, but certainly higher than typical costs of a Shuttle servicing mission, less than \$500 million. The chances of mission success would be lower than those for SM-4, simply because of the infant mortality risk for all new space missions.

It is, of course, always possible to propose a rehost mission with new capabilities that Hubble does not have, such as the HOP telescope consortium proposes. Such a mission would be scientifically attractive by providing even more capability than a Hubble Lite. Depending on the precise proposal and configuration, it could be designed to address specific science problems, such as the dark energy problem. There are other mission proposals to provide new telescopes with new capabilities that would have to be weighed against one another, since none have yet undergone the extensive reviews that the Hubble program has. It would also not have the public recognition that has made Hubble so beneficial to education and public outreach. I assume that any telescope with more capability than Hubble Lite would also be more expensive and carry more development risk than either a rehost mission or SM-4.

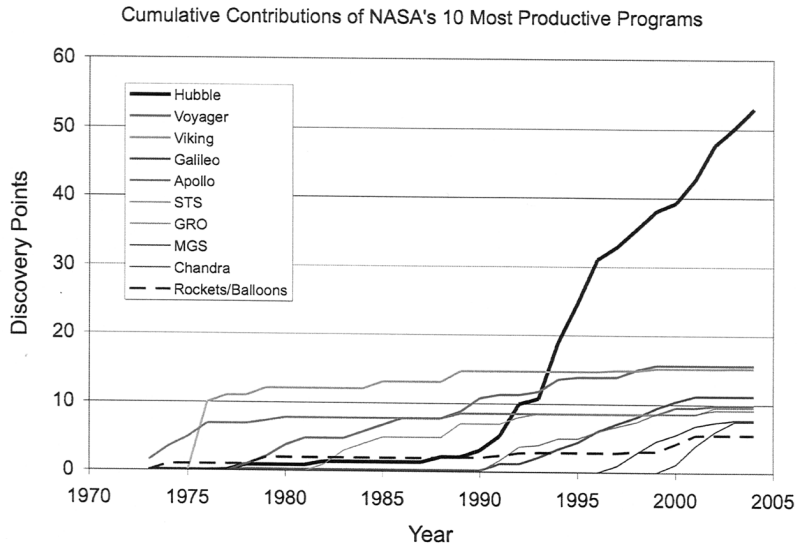

Figure 1: This chart plots the Davidson Science News Metric showing the cumulative discoveries from NASA's 10 most productive missions over time. Of these missions, only Hubble, Chandra, and Rockets/Balloons are still active.

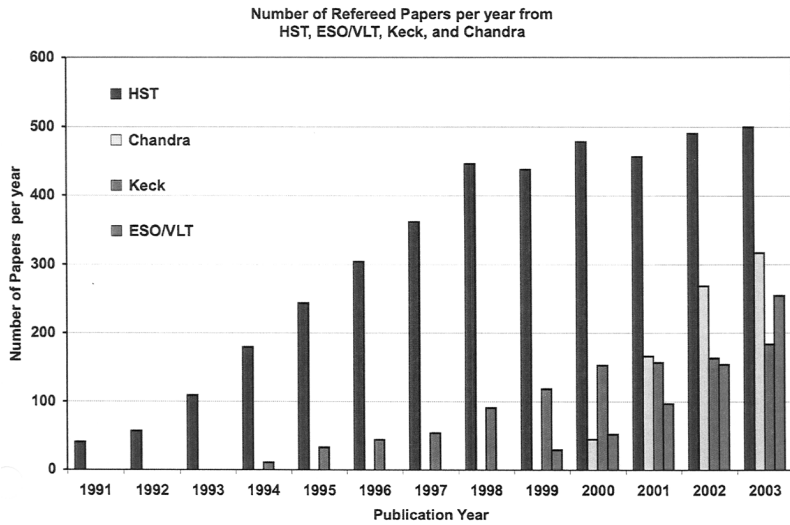

Figure 2: This chart compares the number of refereed papers per year published from four of the world's most productive observatories: NASA's Hubble and Chandra observatories and the ground-based Keck and VLT observatories.

BIOGRAPHY FOR STEVEN V.W. BECKWITH

Steven Beckwith is the Director of the Space Telescope Science Institute on the campus of Johns Hopkins University in Baltimore, Maryland, and a Professor of Physics and Astronomy at JHU. The Institute runs the science operations for the Hubble Space Telescope. As Director, he is responsible for selecting the scientific programs, supporting grants, and all data from the telescope. The Institute has a staff of approximately 500 people, including 100 scientists and 150 engineers to support the space observatory.

He attended the engineering school at Cornell University as an undergraduate from 1970 to 1973, receiving a B.S. with distinction in Engineering Physics in 1973. From 1973 to 1978, he did graduate work in physics at the California Institute of Technology, receiving a Ph.D. in Physics in 1978. Following his Ph.D., he joined the faculty of Cornell University in the astronomy department, where he taught for 13 years as a Professor of Astronomy. During that time, he held a number of visiting positions at Arcetri Observatory (Florence, Italy), the University of California at Berkeley, the California Institute of Technology, and the Max-Planck-Institut für Astronomie (Heidelberg, Germany). He also founded a small company with his wife, Ithaca Infrared Systems, and served as President of the company from 1983 until 1989. The company tested all the short wavelength detectors for the Cosmic Background Explorer.

In 1991, he moved to Heidelberg, Germany as one of two directors of the Max-Planck-Institut fuer Astronomie. He became Managing Director of the that institute in 1994, where he had responsibility for a staff of approximately 200 people and ran the German national observatory, the Calar Alto Observatory, in southern Spain. He was Managing Director until 1998, when he moved back to the United States to become the Director of the Space Telescope Science Institute.

His principal research interests are the formation and early evolution of planets including those outside the Solar System, and the birth of galaxies in the early universe. He has published over 100 research articles, and lectures extensively to the general public and professional audiences. He has won several awards in the United States and Europe for his research and is a fellow of the American Academy of Arts and Sciences. He also contributes his time to advisory committees on research policy. He was the chairman of the Science and Technical Committee of the European Southern Observatory for three years, he chaired the European panel to set priorities for space research for all wavelengths from the ultraviolet to the radio spectrum (Horizon 2000+), and he was recently the Chairman of the panel to set priorities in ultraviolet through radio space research for the first decade of the new millennium as part of the Astronomy and Astrophysics Survey Committee of the National Research Council of the United States, among other advisory contributions.

Chairman BOEHLERT. Thank you very much, Dr. Beckwith. Dr. Cooper.

STATEMENT OF DR. PAUL COOPER, GENERAL MANAGER, MDA SPACE MISSIONS

Dr. COOPER. Mr. Chairman, Committee Members, it is a great pleasure and honor to be here, and I have to say it is particularly an honor to be representing the team of extraordinarily motivated people that are working as we speak towards the critical design review of the Hubble Robotic Servicing Mission. My name is Paul Cooper. I am actually the—lead the space robotic activities at MDA Space Robotics.

I want to start off by putting a little reality around this concept of the robotic space mission. Oh. I see we don't have me on here. Here we go.

Okay. I want to start out with putting a little reality around this idea, and I am actually going to run a little bit of a video here. It is about one minute. It starts off with the real Hubble and the Space Shuttle arm. It is—we are going to—about to do a real grapple. This is the view from the arm. The basic goal here is to grab this peg. The part that I want you to realize is this very piece of hardware that is—it is—you are seeing is what is planned for the

mission. The only difference between this piece of video and what is really going to be planned, the astronauts are going to be on the ground instead of the—in the Shuttle.

Once we grab it, we do the dexterous servicing. This beastie is called Dexter. This is it, in titanium glory. It has been flight qualified. It is ready to roll. This is the actual piece of hardware that we are planning to use to service the Hubble. It is ready now. So, a question arises, which is can this robot do the job, and here, you see Dexter actually doing one of the tasks. This is the—basically the battery jumper cable installation task, and Dexter uses a sense of touch, which you can more or less see in action right here. Without that, it wouldn't be possible, but as you can see, it is possible.

There was some doubt about whether Dexter could be controlled from a distance. Here are some astronauts in Houston. The robot and the telescope mockup are in D.C. here. This is the wide field camera insertion. This is fairly realistic test. Time delay, it is the whole nine yards, no problem. So, we see we have a lot of reality already in this mission, and I want to turn now to talk briefly about the reports that have been issued about it.

This page is about as black and white as it can get, from our point of view. I will start quickly with the costs. The Aerospace Corporation suggested the cost of a grapple arm would be \$700 million. I have to tell you when I saw this, I was pretty amazed that—I thought maybe we left a lot of money on the table, because frankly, our contract is \$154 million, firm, fixed price, can't go up, of which a small component, \$25 million, is for this grapple arm. So, we—we are just puzzled by this. The same basic confusion between this original estimate and how our contract actually come down. Our contract specifies delivery in 31 months, less than half the estimated time, with penalties if we are late. Similar story on mission risk. This robotic mission was rated a high mission risk, and I invite you to look at the track record of Space Robotics, 25 years, 69 missions, not a single mission failure.

Lest it be seen like only the robotic is the reliable component, and only the robotics can be prepared in time, the Lockheed story is the same. This spacecraft is to be delivered in 30 months, not 66 months. If I back up for a moment and look at the total budget picture, there is this estimate floating around, \$2 billion, \$2.2 billion. We have these two contracts. They add up to a little bit less than half a billion. We have our colleagues at Goddard. We are one long way from \$2 billion at the moment.

I want to turn briefly to the NAS appraisal. This was an extraordinarily bleak appraisal of the prospects for this mission, which directly fly in the face of everything we know about the track record for space robotics. That raises the question, how could this be? And I have a little chart here that more or less explains the logic that you have already heard. What it comes down to is estimates of schedule. The Hubble is degrading. If we assume that we have a project that starts from a clean sheet, that is, we have to figure out how to do this, it is plausible that it might take 66 months. By the time you get there, the telescope is dead. This is not a good plan.

This is not the reality. The reality of this is the program was conceived as starting from a huge running start. It is maximally exploiting existing technology. You saw it hanging there. The same

with the spacecraft. The same with the LIDAR sensor, et cetera, et cetera. If you start from a big running start, it is much more plausible to assume this project can be done in a shorter time-frame. It is not an aggressive schedule if you don't assume you are starting from a blank sheet of paper, and in fact, we are also improving the rate of the Hubble degradation and the total picture changes completely when you realize that this assumption was wrong.

If we assume the schedule can be met, the question then turns to the real technical risks of can we do this job? And all I can tell you about this is you don't stand back and say this is a big, complicated problem. What you do is you dive in, you break the problem down into pieces, and you see if you can solve the pieces one by one. And I believe on the chart over here, you can see some of the progress that is being made. One of the things we did is we relentlessly took a real robot operating on real mockup hardware at Goddard, and we have now executed every single task that is necessary to do the servicing and upgrade operations. This has actually been done. This is the most that we could possibly do to prove it is possible prior to actually going and doing it with the telescope.

There are other areas of risk that have been raised. For example, the autonomous rendezvous. This is an interesting one. The Russians have been doing this for 20 years. The Air Force knows that this is an important capability for the United States. There is a mission launching next month. The spacecraft is actually being fueled as we sit here. This mission will launch. It will prove this technology works by the time of the critical design review of the Hubble mission, we will know whether this technology works.

The Committee also asked me to comment briefly on the pros and cons of the robotics mission versus Shuttle. This is a big topic. I have one comment to make. The NAS report focuses on the safety advantage of a—or disadvantage of a single mission. The bottom line here is if we make a robot that can do this kind of servicing, we have changed the safety tradeoff equation for NASA and astronauts for the rest of time, not just this mission. It is a fairly significant fact.

One last point about the robots. The robots build a capability that is important for the future, and for a variety of uses. These include the big observatories of the future of science. These include national security assets in orbit. And for sure, the exploration vision which has been explicitly articulated in terms of just this kind of robotic capability.

In short, we can do this, and we think it is the right thing to do. Thank you. I look forward to your questions.

[The prepared statement of Dr. Cooper follows:]

PREPARED STATEMENT OF PAUL COOPER

Saving Hubble Robotically: A Wise Choice NAS Report Overstated Risks

Executive Summary

The mission to save the Hubble robotically began October 1, 2004, with a huge “running start.” Key elements of the system, such as Dextre (the dexterous robot that will actually perform the servicing activities), are already built. Other major subsystems are “build to print” of existing technology or require little or no development.

Estimates of schedule—can the mission be launched before the Hubble degrades too far?—are key to evaluating whether the mission will be successful. The advisory reports (one from the Aerospace Corp. and one from the National Academy of Science) derived pessimistic schedule estimates from the faulty assumption that the program would begin from scratch, with a “blank sheet of paper.” The real situation clearly contradicts this. One new piece of data is the delivery date for the robotic system: 31 months (Firm Fixed Price with penalties for late delivery). This is less than half the 65 months assumed by the NAS. The actual facts about cost also challenge early estimates (e.g., robotic grapple arm is \$25M versus Aerospace Corp. estimates of \$700M).

Since the mission can be launched in time to arrive before the telescope is dead, the question that remains is technical risk. A key mission task entailing some risk is initially grappling or grabbing the telescope following rendezvous. This grapple task will be executed using a robotic grapple arm and “end effector” (or hand). The end effector will re-use an actual flight unit from the Space Shuttle manipulator, and the grapple arm for the mission is very similar to the existing Shuttle arms. Over 25 years, the Shuttle manipulator has executed 69 missions, including 142 grapple operations, without a single mission failure. This track record includes grappling the Hubble itself on five occasions.

In short, the NAS report significantly over-stated the risks associated with the robotic mission to save the Hubble.

The NAS report recommended a Shuttle-based rescue mission for servicing Hubble. If the decision were a simplistic man versus machine choice, the best choice would be astronauts. But if one asks the broader question: “How does NASA best deploy its Shuttles, astronauts, and robotic technology?”, risking astronaut lives to change batteries seems shortsighted.

Finally, it was not within the scope of the NAS report to consider the value of the various mission options, beyond saving the Hubble. But the robotics mission has a clear advantage in this regard. For example, there is little of value to be learned by having astronauts do something they have done four times before. The capability for robotic servicing in space, on the other hand, is important to the future of science, national security and exploration.

To be more specific, since the future of astronomy is with large instruments outside the Shuttle’s reach, robots that can service and upgrade them are likely crucial to the future of astronomy. For national security, the ability to robotically inspect and service large DOD assets in orbit is important. And the Nation’s exploration vision has already been explicitly articulated in terms of humans and robots working together. Robots will be necessary, for example, to assemble and maintain spacecraft, staging depots, and infrastructure.

To summarize, the robotic servicing mission will be successful saving the Hubble, while also contributing to the future of science, security and exploration.

1 Introduction

Good morning Mr. Chairman, Committee Members. It’s a tremendous honor to be invited to be here, and it’s a particular honor to be representing the team of extraordinarily motivated people working as we speak towards the Robotic Servicing Mission Critical Design Review in the fall.

I am Paul Cooper; I lead the space robotics business at MDA Space Missions, which for 25 years has been NASA’s space robotics partner.

Let me first reinforce that saving the Hubble is an important and worthy goal; in fact, it is among our engineers’ proudest achievements to have played a key role in the four earlier servicing missions, as well as the initial deployment of the telescope.

Among the options for servicing the telescope, we believe that the robotic servicing mission, already underway, is the right choice. In particular, we feel that the recently released reports from the National Academy of Sciences and the Aerospace Corporation have significantly over estimated the risks associated with saving Hubble robotically.

2 The Robotic Servicing Mission

I assume that the Committee may already be aware of the mission profile for Hubble robotic servicing, but nevertheless here's a quick summary:

- Launch of Hubble Space Telescope (HST) Robotic Vehicle (HRV) on an Atlas V or Delta IV expendable launch vehicle.
- The HRV will consist of two separate spacecraft: the De-orbit Module (DM) and the Ejection Module (EM).
- HRV rendezvous with HST.
- Capture of HST using a 42-foot long Grapple Arm (similar to the Shuttle Robotic Arm but slightly shorter); the Grapple Arm will then be used to attach the HRV to the HST.
- Grapple Arm releases HST and picks up Dextre (or Special Purpose Dexterous Manipulator).
- Dextre is used to perform servicing mission tasks:
 - Robotically connect new battery packs to HST
 - Robotically connect new gyros to HST
 - Change-out Wide Field Camera
 - Change-out Cosmic Origins Spectrograph
 - Other servicing tasks
- At the conclusion of the HST Robotic Servicing Mission, the EM (along with all the robotic servicing equipment) will be separated from the HRV, leaving the DM attached to the HST.
- At the conclusion of (extended) HST scientific life, HRV-DM will safely de-orbit Hubble into the Pacific Ocean.

Figure 1 shows the Hubble with the HRV attached and the robots deployed.

The Hubble robotics servicing mission is also illustrated in a NASA movie that can be found at the NASA Goddard website (<http://hubble.nasa.gov/missions/intro.php>).

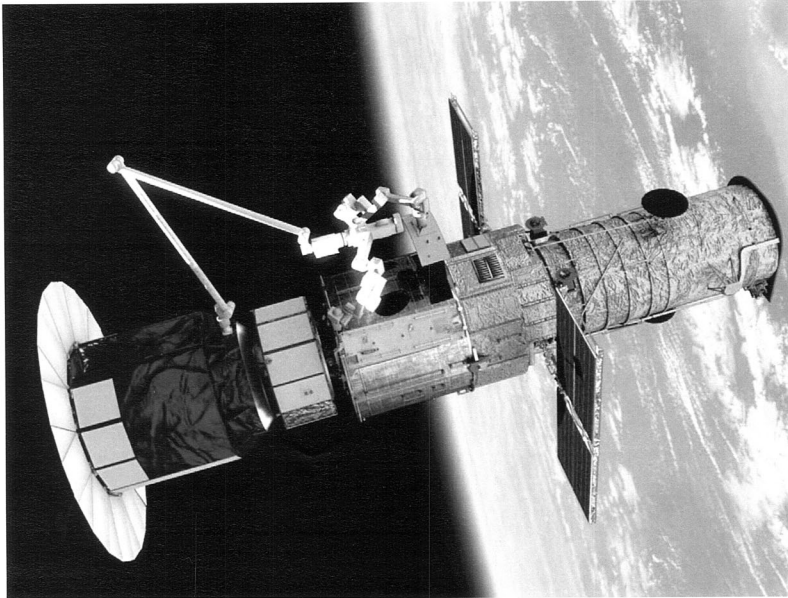

Figure 1: Hubble with the HRV Attached and the Robots Deployed

2.1 Mission Status

As of February 1, 2005 the mission has progressed significantly, and is on schedule for a late 2007 launch, beginning with an October 1, 2004 start date. The major subcontracts are in place (for the supply of the De-orbit Module and the Robotic System), and a large team is ramped up and working at speed both within and outside of NASA.

The Mission Preliminary Design Review is scheduled for March 2005, with Critical Design Review to follow in early September 2005.

These “design” reviews suggest that the mission is still on the drawing boards. But due to the heavy re-use of existing technology, progress is far further ahead than one might envision.

For example, for the two major elements of the robot system, in one case (the use of the Space Station Dextre for Hubble instead of Station) the major components are already essentially complete, and where new hardware is being built (e.g., for the Grapple Arm), we have already begun cutting titanium forgings to make the new gears.

In another example, a few weeks ago NASA Goddard received a deliverable from Draper: software to control the spacecraft during autonomous rendezvous.

In other words, the robotic servicing mission is not a half-baked notional plan, but is a rapidly maturing reality being assembled from prior work.

3 Overall Orbital Robotics Track Record

Figure 2 is emblematic of the trust that NASA has developed in space robotics: not only does it show humans and robots working together, but it shows one of the space program’s most valuable assets—an astronaut—literally hanging from a robot during Extra Vehicular Activity (EVA).

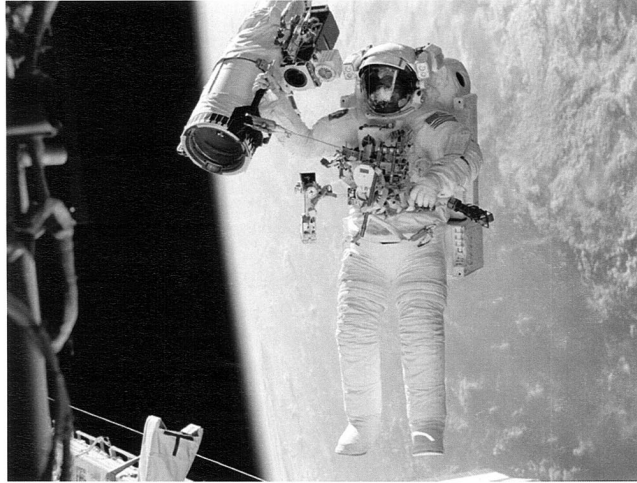

Figure 2: Shuttle Mission Photo Showing an Astronaut Attached to Shuttle's Robotic Arm

The most well-known space robot, the Shuttle Remote Manipulator System, has been flying since 1981. It has performed 69 missions without a single mission failure. The same system has also been successfully used four times to grapple the Hubble Space Telescope and to support subsequent EVA servicing missions for the Hubble.

This track record is particularly relevant because the robotic servicing mission plan calls for the use of a robotic arm nearly identical to the Shuttle arm, including the re-use of a actual Shuttle flight “end effector” (the “hand” on the end of the arm).

More recently, new robotic systems have been developed for the construction and maintenance of the International Space Station, including Dextre, to be described momentarily. Unmanned robotic missions for DOD applications in Low-Earth Orbit (LEO) have also been developed.

Beyond LEO, the heritage and operational reliability of the many robots that have been the workhorse of planetary science are relevant, include the current MER rovers on Mars.

4 Aerospace Corporation Report

In our opinion, the Analysis of Alternatives report from the Aerospace Corporation was overly pessimistic in its view of robotic servicing. Table 1 summarizes our view of the difference between what are now known facts concerning the robotics elements, and what the report asserted.

Table 1: Elements of the Mission Compared

Element	Aerospace Corp. Study Assertion	Space Robotics Fact
Cost	\$700M for grapple arm. >\$2B for mission.	\$154M Firm Fixed Price! For grapple arm <i>and</i> copy of Dextre.
Schedule	66 months	31 months with penalties
Development risk	High	Very low, since mission uses hardware that is already built
Mission risk	High	25 years, 69 missions, no mission failures

4.1 Cost

The Aerospace Corporation report has suggested that a Hubble Robotic Servicing Program will cost more than US\$2B, with a grapple arm incremental cost of approximately US\$700M. The fact of the matter is that MDA has entered into a Firm Fixed Price Contract with NASA at US\$154M to provide a grapple arm plus a dex-

terous robot and other accessories. (The share of the contract devoted to the grapple arm amounts to \$25M.)

4.2 Schedule

The Aerospace Corporation report suggested that a Hubble Robotic Servicing Program will take at least 66 months to execute. Again, the fact is that on the robotics portion of the mission, MDA has contractually committed to NASA to deliver the robotics systems within 31 months, with the potential for negative financial consequences if delivery is late.

As for the spacecraft portion of the mission, the Aerospace Corporation has drawn their schedule conclusion based on a diverse and not necessarily compatible data set, including a mix of manned and unmanned missions, U.S. and foreign Programs, and so on. As shown in Figure 3, a very different perspective will emerge using data points that reflect new spacecraft development that is not “done from scratch” but nonetheless yields a new integrated product. We believe that this perspective is representative of the current Hubble Robotic Servicing Program run by NASA Goddard, which maximizes the use of existing technologies and subsystems to support a “running start” and not a “white sheet of paper” approach. This approach suggests that a roughly 40 month schedule for the Program is entirely plausible, and not the 66 month schedule that has been suggested.

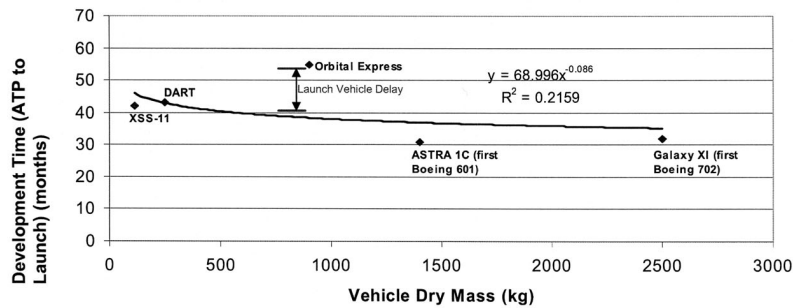

Figure 3: Schedule Estimate Results Analogous to Aerospace Corp. Report

4.3 Development Risk

4.3.1 Robot System

The Aerospace Corporation report suggested that a Hubble Robotic Servicing Program has high development and mission risks. Development risk is defined as the risks associated with preparing the mission in time. Mission risk is defined as the risk associated with executing the mission successfully. (Although for the NAS mission risk was defined as the risk of failing to achieve mission objectives.)

The overall evaluation was dominated by the estimate of the schedule necessary to mount the mission. In short, if the telescope has a high likelihood of being dead by the time the rescue mission reaches it, the mission is a failure.

Because the Robot System for Hubble servicing either uses hardware that is already built or leans heavily on existing hardware, there is practically no development risk. The primary example is Dextre. A picture of the completed and flight-qualified Dextre, hanging in our Cleanroom, is shown in Figure 4. This is the *actual robot that will be used to service the Hubble*; the only planned change is to add an additional camera. (A copy of Dextre will be built for later use on the Space Station.)

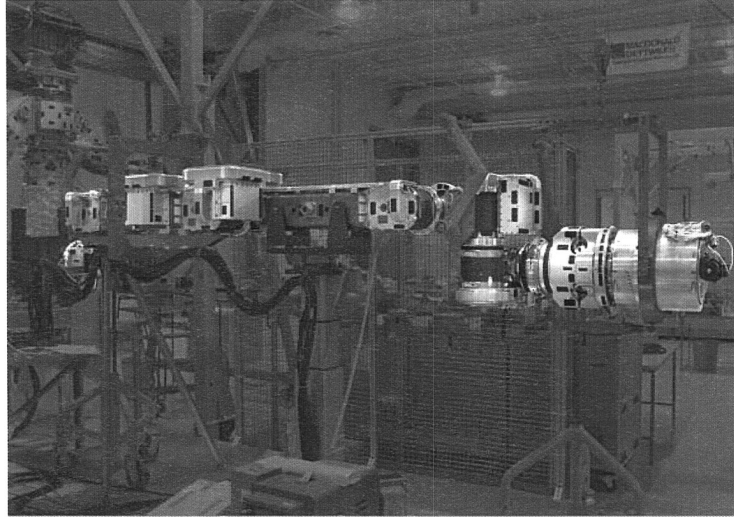

Figure 4: Dextre Flight Hardware

For another extremely important element of the Robot System—the End Effector that will actually grapple the Hubble and pick up Dextre—the plan is to re-use a Shuttle flight unit that has already successfully performed this critical operation on orbit dozens of times.

In short, for the Robotic System, development risk is minimal. Hence the willingness of the contractor to enter into a Firm Fixed Price contract with a 31 month schedule.

4.3.2 Other Mission Elements

Is there then some other critical mission element that is being developed from scratch, for which the assumed schedule of 66 months makes more sense? The answer, in short, is no. The de-orbit vehicle is also on an approximately 30 month schedule, and maximizes re-use of existing technology. A key sensor for the rendezvous (the “lidar”) is a re-build of a sensor just delivered a few months ago for a separate mission. The situation is similar for basically all the key components of the mission, including the software for controlling the spacecraft during rendezvous.

4.4 Mission Risk

The Aerospace report analyzed “mission risk” as the concatenated probability of failure of specific subsystems and mission tasks.

As a starting point, consider the Aerospace analysis of the probability of mission success for the De-orbit Option using a grapple arm: 93 percent. A key thing to understand about the De-orbit mission profile is that *it contains almost all the significant risks of the servicing mission*, specifically the need to autonomously rendezvous with and grapple a potentially tumbling telescope.

Once the telescope is grappled and the rescue vehicle is berthed, the mission risk reduces down to the risk of successfully executing the specific repair and upgrade operations.

But while the Aerospace report was guessing at the likelihood of specific component and task failures, NASA Goddard (working in concert with engineers from MDA Space Missions) *was systematically performing each operation using real hardware*—that is, using the Earth-bound version of Dextre operating on the Hubble high fidelity mockup.

NASA summarized this intensive risk retirement activity in this way: “A space-flight qualified robot has successfully demonstrated that all life-extension tasks and science instrument change-outs can be robotically performed.” (A comprehensive list of the tasks performed and the dates upon which they were executed is included in Appendix C.)

It would be difficult to do further work to retire mission risks; the next logical step is to actually execute the mission. Based on these new facts, one can now estimate the likelihood of successfully executing the whole servicing operation as similar to the likelihood of succeeding at the de-orbit mission, e.g., in the 90 percentile range.

4.5 Summary on Aerospace Report

I would like to summarize our reaction to the Aerospace Corporation Report as follows:

- Aerospace Corp. Reported Baseline Assessment for Robotic Servicing Program: US\$2B, 5.4 years, high development risk, high mission risk
- Alternative Assessment: ~ US\$1.3B, 3.5 years plausible, little development risk, 90 percent or higher probability of mission success

5 National Academy of Sciences (NAS) Report: Risk Overstated

5.1 Overall Mission Risk Appraisal

The NAS report concluded with a remarkably pessimistic appraisal about the prospects for the robotic mission: an 80 percent chance of mission failure is asserted.

This seems to fly in the face of everything known about the track record of space robotics, so how could this conclusion have been arrived at? The assertion is derived mainly from two guesses: a guess as to how long it will take to mount the mission, and a guess as to how slowly the Hubble will degrade, i.e., in what state will the telescope be when the robotic rescue mission reaches it?

The NAS report inherited its schedule assumptions in large part from the Aerospace report, and the same consequences follow as described earlier. Since in reality the Hubble robotic rescue is starting from a “running start” (e.g., maximal utilization of existing technology) we can reasonably expect the mission to be launched before the telescope degrades to the point where it cannot be repaired.

Also, continuing progress is being made in slowing the Hubble’s rate of degradation, further mitigating the risk to mission success from schedule. If the risks due to schedule are removed, what remains as a real threat to the mission’s success are technical risks.

5.2 NAS Technical Risks

The NAS report identified a number of areas of technical concern. We discuss these risks, and highlight in particular the risk mitigation progress that has been made since the report was published.

5.2.1 Grapple Events

The NAS report expressed concern that each grapple event was a source of risk, e.g., initially grappling the telescope, releasing the telescope, and subsequently grappling Dextre.¹ Each event requires making a mechanical connection and in the case of grappling Dextre, establishing an electrical connection as well.

In a nutshell, this concern is misplaced. The mission plan calls for the re-use of a reliable End Effector from the Shuttle robotic arm, proven through dozens of uses in space. Literally hundreds of grapple operations have been performed with identical hardware over the past decades. (Appendix A summarizes the performance of the Shuttle Remote Manipulator System.)

5.2.2 Time-delayed Control

The NAS report expressed concern about the risks related to operating on-orbit robots from the ground via time-delayed control². There is no doubt that time-delay will be present when controlling the robots, since for example, the signal will travel via the TDRSS data relay satellite.

Since the report was issued, two significant developments have transpired that suggest the risks inherent in time-delayed control are less than the NAS report suggests.

First, following a one-year review process, ground control of Space Station robotics recently passed the NASA Space Station Safety Review panel in September 2004. This process was driven by need: astronaut time on-orbit is scarce and valuable, and if robots can perform mundane tasks while controlled from the ground, on-orbit productivity will increase. (This same trade-off applies more broadly for the Hubble

¹National Research Council of the National Academies (2004) *Assessment of Options for Extending the Life of the Hubble Space Telescope: Final Report*. Page 63–66.

²National Research Council of the National Academies (2004) *Assessment of Options for Extending the Life of the Hubble Space Telescope: Final Report*. Page 63.

mission.) As one can imagine, the safety review involved an extreme in-depth scrutiny of the risks involved with time-delayed control of on-orbit robots. Ground control is set to be commissioned on-orbit in February 2005. There is no doubt that during 2005 (prior to the Hubble robotic mission CDR in the fall), much will be learned from operational experience. These lessons can be incorporated into planning for the Hubble mission, which uses substantially the same ground control system.

Second, risk mitigation testing specifically aimed at addressing this question has been ongoing at Goddard. Since the NAS report, numerous tests of the Earth-bound version of the Dextre robot have been performed. Shuttle astronauts at the Johnson Space Center remotely operated the robot at NASA Goddard to extract the Wide Field of View Camera 2 (WFOC-2) and insert the WFOC-3 overcoming technical challenges such as control time delays of two seconds. In a separate set of tests, variable control time delays of up to eight seconds were generated during the extraction of the COSTAR instrument and replacement of the COS instrument. These tests independently varied the video and force feedback time delays. Other tests have demonstrated that astronaut control is achievable even in operations in which astronauts are provided with inadequate camera views of the worksites. Our testing shows that the mission is wholly feasible under the constraints of time delay.

5.2.3 Autonomous Rendezvous

The NAS report highlights the risk of autonomous rendezvous as one of the most serious to be faced by the mission. In fact, the report asserts that this “has never been done.”³

Russian spacecraft have been routinely executing automatic rendezvous and docking missions using technology developed in the early 80’s. Table 2 summarizes autonomous rendezvous and docking with Russian spacecraft.

Table 2: Russian Spacecraft Autonomous Docking Since 1987

Spacecraft	Number of fully automatic dock/undock operations	Timespan
Spacecraft to MIR Space Station	101	1987-2000
Spacecraft to International Space Station	28	2000-2005
Total	129	

The importance of autonomous rendezvous and proximity operations has been recognized by the U.S. space community for some time. As a result, there has been a significant development activity in place for many years, and a sequence of missions is planned to validate and demonstrate these capabilities. All these missions will fly prior to the Hubble mission, with time enough to incorporate “lessons learned.” Missions devoted to examining autonomous rendezvous and/or capture/docking include the XSS-11 mission for the Air Force Research Labs (scheduled for launch March 2005), the DARPA Orbital Express mission (scheduled for launch in 2006), and the DART mission.

The initial concepts for rendezvous and capture were developed during the Gemini and Apollo programs. The Shuttle has demonstrated that these can be performed for a more general set of LEO missions and has developed a wide variety of approach trajectories and control strategies. These missions demonstrated many of the automated guidance, navigation and control functions required today for autonomous rendezvous and capture. For both Apollo and Shuttle, the rendezvous planning was performed on the ground, but the on-board system was able to target and automatically control the rendezvous burns. The final capture/docking phase was controlled manually by the crew. The Shuttle on-board GN&C is able to automatically perform many of the necessary rendezvous functions, including relative navigation, targeting and control. Attitude control is done automatically, and translational control is done manually based upon Rendezvous and Prox Ops Planner (RPOP) software that runs on a laptop computer in the cockpit.

The crew enters data into the laptop from the hand-held radar and the Trajectory Control Sensor (LIDAR), and the RPOP program computes the burn plan. The crew manually performs the final docking maneuvers using the cameras and data from the vision sensors. The Hubble Robotic Servicing mission will require full automation of these functions, but the fundamental techniques for rendezvous, proximity operations, and capture of a stable target have been adequately demonstrated.

³National Research Council of the National Academies (2004) *Assessment of Options for Extending the Life of the Hubble Space Telescope: Final Report*. Page 63.

The significant remaining technical issues that need to be addressed for the AR&C phase of the Hubble Robotic Servicing mission are the autonomous operations, and the relative sensing and subsequent capture of a tumbling target.

XSS-11

As of Feb. 1, 2005, the XSS-11 spacecraft is being fueled for launch in a few weeks. The automation aspects of autonomous rendezvous are fully addressed with the XSS-11 mission plan, which will perform completely several fully autonomous rendezvous and operations in proximity to several uncooperative targets. The software to affect an autonomous rendezvous and capture has been developed and tested in a 6 degree-of-freedom (6DOF) gantry facility at Lockheed Martin.

A version of this software suitable for the Hubble mission rendezvous and proximity operations from long range into a 10 foot offset point has been developed by Draper Lab, and has already been delivered to Lockheed for the purpose of conducting simulation demonstrations of the autonomous Hubble rendezvous and capture.

The XSS-11 mission relies on a laser-based Lidar vision system for rendezvous and docking. By detecting the reflection of a laser beam, the Lidar will detect features on objects that are less than half an inch in size from a distance of almost two miles. The same Lidar will be used on the Hubble Robotic servicing mission.

The on-orbit performance of the entire XSS-11 rendezvous system, including sensor, will be known by the September 2005, when the Critical Design Review is scheduled for the Hubble robotic mission.

In addition, extensive ground validation of the autonomous capture operations is ongoing for the Hubble Robotic Servicing mission. The 6DOF proximity operations necessary to match the rotation of a tumbling HST have been demonstrated in a high fidelity simulation by Draper Lab. It should be noted that the estimated worst case rotation rate is very slow at 0.22 deg/second (or only 2.2 revolutions per hour).

5.2.4 System Integration

The NAS report also highlighted the risks associated with the overall task of integrating and testing the entire system. Since the NAS fact finding sessions, the program has actually begun, and NASA Goddard has substantially matured its plan for System Integration. This plan is included as Appendix B.

5.2.5 Robotic Repair Operations Actually Performed on Hubble Mockup

One thing that was remarkable in its absence from the NAS report was any discussion of the extensive efforts that have gone on at Goddard in the past year to prove, by having the ground test-bed version of Dextre actually execute the operations on the high fidelity mockup of Hubble, that all the operations could be executed. In other words, predominately since the NAS report fact finding, a space-flight qualified robot has successfully demonstrated that all life-extension tasks and science instrument change-outs can be robotically performed.

Appendix C describes these operational tests in more detail.

5.3 Robotics' Risk Summary

5.3.1 The Robotic Mission Will Have Time and Be Flexible

Perceptions of how the robots will operate can affect inferences about associated risk. Sometimes, it seems like people imagine that the robotic rescue mission is going to be like a car assembly operation—that it can only be done one way and if that way fails we're stuck. Alternatively, people imagine that while an astronaut is driving the robot from on the Earth, something is going to happen really fast that we won't be able to deal with.

But both these perceptions are wrong.

Previous Shuttle-based Hubble Servicing Missions, although very successful, have relied on quick execution of EVA tasks on a very tight timeline that is counted in hours and days.

The robots, however, won't need oxygen, and we'll have lots of time—weeks or months if necessary—to go slow, evaluate what's happening, make adjustments, make multiple attempts at operations, and re-plan if necessary. For example, we have two arms to use, even though the nominal operations plan calls for using only one most of the time.

We have seen with the current Mars rovers a very compelling example of how robots can recover from problems, and do amazing things in much more difficult circumstances (e.g., much longer time delays for control) than what we are looking at for Hubble.

In short, the robot mission will be much more flexible than people imagine.

5.3.2 The Next Step: Fly the Mission

It is our opinion that the robotic risks for the Hubble robotic servicing mission have been largely overstated by the NAS report. Key identified risks in autonomous rendezvous and grapple have either already been largely demonstrated or are to be fully demonstrated on missions such as XSS-11, DART and Orbital Express. Ground control of Space Station robot has already passed NASA safety review and is scheduled for a first demonstration in February 2005. Critical Hubble servicing robotic operations have been tried-out on the ground using flight-representative robotic and Hubble mockups remotely operated over long distances. The key robotics risks for the mission, in our opinion, have hence been largely retired, and the next logical step is actually to fly it.

6 Alternative Mission Options

6.1 Shuttle Servicing Option

The NAS report recommends using a Shuttle mission to service the Hubble. If one allows for the possibility that a robotic mission is likely to be successful, a robotic option becomes the preferred option.

On this question there is no debate: “Which is more intelligent and flexible, astronaut or robot, and thus more likely to succeed in performing Hubble servicing activities?” Everyone would agree that an astronaut is more likely to be successful. This is not, however, the fundamental question needing to be addressed.

The broader question is something more like: “Given the available assets for use in space, including Shuttles, astronauts, robots, ELVs, etc., what is the best way of allocating these assets to the tasks to be accomplished?”

Servicing the Hubble robotically has compelling value when considered in this light:

- 1) It liberates scarce resources—Shuttles and astronauts—for other tasks that *cannot* be achieved using a robotic mission
- 2) It allows the Shuttle to be retired sooner
- 3) Astronaut lives are not risked on this mission
- 4) A capability is developed that can be used on other missions (this is described momentarily)

Astronauts changing batteries? It appears short-sighted, and certainly we will need other more economically appropriate alternatives in the long run.

6.2 De-orbit Only Option

It is our understanding that at a minimum, a robotic de-orbit mission of the Hubble has to be mounted, in order to avoid an eventual uncontrolled re-entry of the telescope, and thus ensure public safety. The Aerospace Corporation report asserted that a de-orbit mission using a robotic grapple arm for Hubble capture has a 93 percent probability of mission success.

From a robotics point of view, the key fact about a de-orbit mission is this: *adding servicing to a de-orbit mission adds only relatively small incremental risk and cost.* Put another way: Since the key mission risks of “autonomous rendezvous and grapple” are the same for the servicing and de-orbit missions, why not do the servicing too?

This logic is particularly compelling if the telescope is dying anyway, and there is little to lose by trying to fix it. The servicing mission will only add incremental costs and small incremental risks, while producing very significant paybacks.

6.3 Rehosting

Another alternative that has been proposed is rehosting the science instruments intended for the Hubble upgrade on another new platform similar to the Hubble.

It is certainly beyond the scope of this witness to comment on the technical and economic challenges of building space telescopes, and the potential science value that may result.

It may perhaps be useful to note, however:

A new telescope contributes nothing to the Hubble problems—at a minimum, a still-expensive de-orbit-only mission must be mounted for Hubble. But the incremental cost of adding servicing to a de-orbit mission is certainly much less than the cost of developing a rehosting solution.

Unlike the robotic mission, constructing a new telescope is unlikely to make a substantial contribution to any other space mission goals.

7 The Future

Unlike the other options for servicing the Hubble, developing a robotic servicing capability would be extremely valuable for other national needs in space.

7.1 Science

The future in astronomy is to place larger instruments well beyond low Earth orbit, for example at Lagrangian Points such as L2 (which is beyond the Moon). These distances are so far that they are beyond the reach of the Shuttle. Robotic servicing offers scientists the ability to upgrade these instruments as our knowledge of the universe unfolds. The Hubble Robotics Servicing Mission will provide scientists with a proven method for building ever better instruments.

7.2 National Security

Akin to extending the life of the Hubble Space Telescope, the Department of Defense (DOD) is seeking to extend the life of critical military space assets by performing on-orbit servicing. The XSS-11 and Orbital Express missions are developing and testing the necessary technologies for servicing military satellites on-orbit. The DOD has decided to use robots for autonomous rendezvous and docking, refueling, repair and other tasks. The DOD will benefit from the experiences gained on the Hubble Robotics Servicing Mission.

7.3 Exploration

Future Space Exploration Programs will undoubtedly need to maximize sustainable affordability, maximize safety, improve mission success effectiveness and advance the state-of-the-art with each mission. Future missions will also need to achieve the right balance between humans and robots working collaboratively, given some of the far mission locations and the high costs and complexity of conducting human-only missions. Robotics advancement will open new alternatives that can contribute increased safety and mission success, while lowering overall mission costs. NASA is already embarking on its vision to use humans and robots in tandem to explore the universe. Humans are to perform the analysis and discovery and manage dynamic environments while robots will complement humans by performing routine tasks such as the maintenance of spacecraft staging depots and infrastructure.

More specifically, the proposed Hubble Robotics Mission will serve as a key stepping stone for NASA's new vision for Space Exploration, by acting as a precursor and testbed for effective closely coupled human and robotic partnerships in Exploration. Astronauts have already well proven themselves on previous Hubble Servicing and other manned missions in Low-Earth Orbit and on the Moon. Now is the right time to extend the reach of astronauts by introducing more sophisticated remotely operated robotic capabilities.

Appendix A: End Effector Operational Track Record

Description of Operation	Total Number of Operations
Total SRMS End Effector Flights	69
Total SRMS on-orbit End Effector Actuations	436 (includes end effector checkouts)
Total SRMS payload grapples	142 (includes both fixed and free-flyer grapples)
Total SRMS Free-Flyer grapples	33 (including HST 4 times)

SRMS end effector failures = none. All the above were 100% successful.

Appendix B:

System Integration Plan for the Hubble Robotic Servicing and De-orbit Mission (HRSDM)

HRSDM is truly a large system to design, develop, integrate, test and verify, within a 39-month start to launch period of performance. This was accommodated during selection of architecture through an approach that focuses on a modular, relatively independent, implementation. This includes:

- Stand alone De-orbit Module based on a proven spacecraft.
- Existing Robot System with International Space Station heritage.
- New GSFC developed Ejection Module with high commonality with De-orbit Module spacecraft bus architecture.
- An evolving Ground Station made up of existing HST ground equipment augmented with equipment used during HRSDM elements integration and test program.
- Existing HST science replacement hardware ready for incorporation into the Hubble Space Telescope.

The implementation approach described above has three major features that will facilitate System I&T. First, each of the major program elements will be independently integrated, tested and verified against their respective requirements. During that integration and test process, simulators from the interfacing elements will be used for interface validation.

Second, a full up System Integration and Test Program of all of the elements at GSFC starting January 2007 one year prior to launch, will validate all system interfaces and complete Element Level environmental test.

Third, all of the Element Level ground station hardware and software that will be used to test the various elements at their developer's facilities, will be delivered to GSFC for final HRSDM Level Integration and Test and will remain at the Mission Operations Control Center through the Servicing Mission, as applicable, through the eventual De-orbit Mission.

The GSFC existing facilities, the just-in-time deliveries of the HRSDM elements, and the preliminary System Level integration during Element I&T are major contributing factors of a rigorous, albeit short, implementation program. However, the principal contribution is the use of existing personnel experienced on four prior servicing missions who have demonstrated their ability to meet launch dates without compromising mission integrity. Building of EM in-house allows the personnel to get involved early throughout the EM I&T program. As Robotic System hardware, EM spacecraft, and HST payloads become available, they will be interfaced and tested along with their appropriate ground stations. This enables a team to start into System Level I&T during EM testing from September 2006 through January 2007. During the February 2007 through May 2007 as the other elements are delivered, this experienced team will integrate the elements into the Mission System.

This still leaves six full months for System Level testing, mission simulations and requirements verifications, before delivery of the mission to KSC for launch.

Throughout the mission the same trained and experienced work force will man the Ground Stations, operate the HRSDM Elements, service the HST and de-orbit the Ejection Module spacecraft.

Appendix C:**Hubble Mockup Testing**

Since March 2004, engineers have been testing an Earth bound version of Dextre to determine if all of the Hubble servicing tasks can be accomplished robotically under the actual operation scenario which includes various degrees of camera views, transmission time delays and variable lighting conditions. These tests are summarized below.

AT MDA**15/3/04—07/04/04****SSM BAY 1—(486 COMPUTER)**

J LATCH LOCKING FEATURE UNDONE
 J LATCHES ROTATED
 DOOR OPENED
 P9 TERMINATOR PLUG REMOVAL FROM J9
 INSTALLATION OF 1553 DATA BUS CONNECTOR ONTO J9
 DOOR CLOSED

DIODE BOX

REMOVAL OF P6A PLUG FROM DIODE BOX
 INSTALLATION OF P6A PLUG ONTO TEMP STOW BRACKET
 REMOVAL OF P8A PLUG FROM DIODE BOX
 INSTALLATION OF P8A PLUG ONTO TEMP STOW BRACKET

AT GODDARD SPACE FLIGHT CENTRE**30/04/04—10/05/04****WIDE-FIELD CAMERA**

INSTALLATION OF GROUND STRAP TEMP STOW BRACKET
 GROUND STRAP REMOVAL FROM WIDE-FIELD CAMERA 2
 GROUND STRAP INSTALLATION ON TEMP STOW BRACKET
 WIDEFIELD CAMERA 2 REMOVAL
 WIDEFIELD CAMERA 3 INSERTION
 GROUND STRAP REMOVAL FROM TEMP STOW
 GROUND STRAP INSTALLATION ON WIDE-FIELD CAMERA 3

12/05/04—18/05/04**REMOTE DEMONSTRATION OF WIDE-FIELD TASKS FROM JSC**

CREW TRAINING @ GODDARD FOR WIDE-FIELD TASKS
 CREW TRAINING @ JSC FOR WIDE-FIELD TASKS
 CREW REMOTE DEMONSTRATION FROM JSC
 (GROUND STRAP AND WIDE-FIELD REMOVAL INSERTION TASKS, WITH
 LATENCY—TWO SECONDS ON VIDEO, TELEMETRY INSTANTANEOUS)

19/05/04—28/05/04**COSTAR/COS TASKS**

INSTALLATION OF “COME-ALONG” TOOL TO RESTRAIN DOOR
 UN-TORQUE AND ROTATE LATCHES
 OPEN DOORS
 REMOVE CONNECTORS FROM COSTAR (J1, J2, J3, J4)
 INSTALL CONNECTORS ON CONNECTOR TEMP STOW PANEL (J1, J2, J3,
 J4)
 REMOVE GROUND STRAP FROM COSTAR
 INSTALL GROUND STRAP ON C.T.P.
 CLOSE DOORS USING “COME-ALONG” TOOL
 ROTATE AND TORQUE DOOR LATCHES
 REMOVE “COME-ALONG” TOOL

18/06/04—23/07/04

COSTAR/COS TASKS—CONTINUED

INSTALLATION OF “COME-ALONG” TOOL TO RESTRAIN DOOR
 UN-TORQUE AND ROTATE LATCHES
 OPEN DOORS
 INSTALL DOOR RESTRAINT
 INSTALL CONNECTOR TEMP STOW PANEL
 REMOVE CONNECTORS FROM COSTAR (J1, J2, J3, J4)
 INSTALL CONNECTORS ON CONNECTOR TEMP STOW PANEL (J1, J2, J3, J4)
 REMOVE GROUND STRAP FROM COSTAR
 INSTALL GROUND STRAP ON C.T.P.
 MOVE C.T.P. TO HANDRAIL
 INSTALL B LATCH TOOL
 REMOVE COSTAR
 INSTALL COS
 REMOVE B LATCH TOOL
 INSTALL C.T.P. TO COS
 REMOVE DOOR RESTRAINT
 CLOSE DOORS USING “COME-ALONG” TOOL
 ROTATE AND TORQUE DOOR LATCHES
 REMOVE “COME-ALONG” TOOL

08/09/04—08/10/04

+V2 CONDUIT

ATTACH CONDUIT TO NC RADIATOR
 RETRIEVE R&P CONNECTION TO DM
 RETRIEVE SA UMBILICAL BRACKET
 RETRIEVE AND MATE CONNECTION TO NCS RADIATOR

WIDE-FIELD CAMERA

INSTALL ADAPTOR PLATE TO WIDE-FIELD CAMERA
 ACCESS A LATCH
 ACQUIRE BLIND MATE CONNECTOR MECHANISM

LATENCY TESTS

CONTROLLED TESTS OF LATENCY EFFECTS
 VIDEO AND TELEMETRY LATENCY ADJUSTED INDEPENDENTLY
 VIDEO AND TELEMETRY LATENCY TESTED FROM TWO SECONDS TO EIGHT SECONDS
 TASKS PERFORMED WITH LATENCY INCLUDE: COSTAR REMOVAL/COS INSERTION, -V2 DOOR LATCH BOLT ACTIVATION

VISION SYSTEM

CONTROLLED TESTS OF VISION SYSTEM
 VISION USED TO ASSESS POSITION BY MODEL MATCHING
 -V2 DOOR LATCH SUCCESSFULLY ACQUIRED, UN-TORQUED, AND ROTATED, WITHOUT ASSISTANCE OF VIDEO

29/11/04—17/12/04

V2 AFT SHROUD DOORS

INSTALLATION OF “COME-ALONG” TOOL TO RESTRAIN DOOR
 UN-TORQUE AND ROTATE LATCHES
 OPEN DOORS
 CLOSE DOORS USING “COME-ALONG” TOOL
 ENGAGE SHEAR PLATES
 ROTATE AND TORQUE DOOR LATCHES
 REMOVE “COME-ALONG” TOOL

SSM BAY

UN-TORQUE AND ROTATE J LATCHES

FINE GUIDANCE SYSTEM

REMOVE CONNECTORS

INSTALL CONNECTORS ON C.T.P.

DIODE BOX

REMOVE CONNECTORS

INSTALL CONNECTORS ON C.T.P.

COSTAR/COS

REMOVE AND INSTALL CONNECTORS

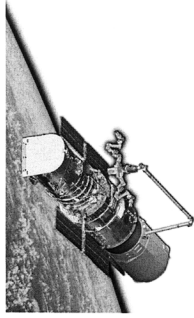

Aerospace Report

Aerospace Corp Study Assertion	Space Robotics Fact
\$700M grapple arm	\$154M Firm Fixed Price contract
66 months	31 months with penalties
High development risk	Flight-qualified hardware waiting to fly
High mission risk	25 years, 69 missions, no mission failures

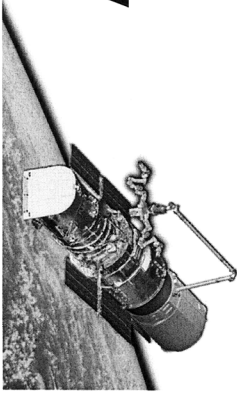

Aerospace Report

- Lockheed Martin De-orbit Module
– \$330M, 30 months

Aerospace Corp Study Assertion	Total Industry Major Contracts
\$2.2B	\$484M

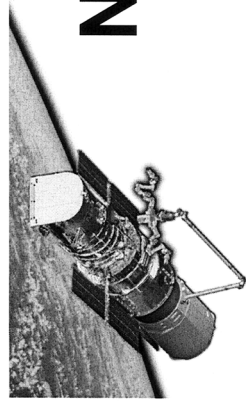

NAS Risk Appraisal

On One Hand	On the Other
80% likelihood of robotics mission failure	25 years no failures. Mars rovers, 1 yr +?

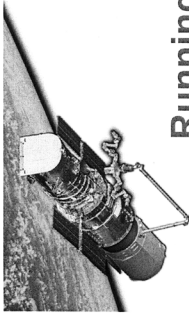

Running Start

~~Clean Sheet Assumption~~



~~66 Month Schedule~~

40

Slower Degradation

~~Hubble Degrading~~

High
~~Remote Chance of Success~~

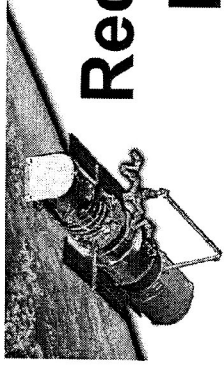

Recent Progress Retiring NAS Technical Risk

- Servicing task execution
 - Fall 2004: real hardware has done the tasks
- Autonomous rendezvous
 - March 2004: XSS-11 flight
- Can incorporate “lessons learned”

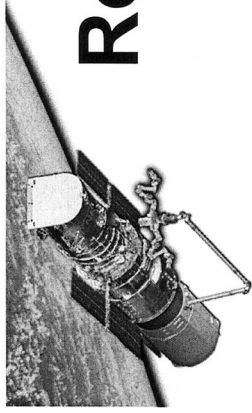

Robotics vs. Shuttle

86

- Robotics is game-changer for safety
 - Alters trade-off equation now and in the future

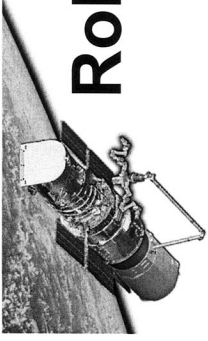

Robotic Hubble Servicing Enables the Future

- **For Science:** large observatories.
Assembly, servicing, and upgrades.
 - Instruments *outside the reach of Shuttle*
- **For Security:** DOD orbital assets.
Inspection, servicing, upgrades, assembly.
- **For Exploration:** large spacecraft, staging
bases, refueling depots.
Build and maintain necessary infrastructure.

BIOGRAPHY FOR PAUL COOPER

Dr. Paul Cooper is Vice President and Deputy General Manager at MDA Space Missions, where he has overall responsibility for the company's space robotics business, including over 700 employees in five locations. Prior to joining MDA, Dr. Cooper was CEO and co-founder of Perceptual Robotics, Inc., the Chicago company that created the webcam. Earlier, he was a Professor of Computer Science at Northwestern University. Dr. Cooper's business experience includes strategic leadership, business development, product management, and R&D. His technical background includes autonomous robotics and AI, computer vision, and Internet software; Dr. Cooper is an author of or contributor to numerous patents and research papers. He holds Bachelor's degrees in both Electrical Engineering and Computer Science from the University of British Columbia, and M.S. and Ph.D. degrees from the University of Rochester.

Chairman BOEHLERT. Thank you very much, Dr. Cooper. Dr. Norman.

STATEMENT OF DR. COLIN A. NORMAN, PROFESSOR OF PHYSICS AND ASTRONOMY, JOHNS HOPKINS UNIVERSITY

Dr. NORMAN. Mr. Chairman and Members of the Committee, thank you for your invitation to appear before you today.

There have been many striking moments during the Hubble project, times of tragedy associated with the *Challenger* and *Columbia*, character building times during the discovery of the spherical aberration of the mirror, and then the correction, in the flawless first servicing mission.

There have been times of great discovery that have inspired us all: the precise establishment of the expansion rate of the universe, the determination of the age of the universe, a deep understanding of the origin and evolution of galaxies, basic discoveries concerning the evolution of stars, and the existence of massive black holes at the center of most galaxies. Indeed, Hubble discoveries have rewritten the textbooks from which our children learn.

Each of the previous servicing missions has renewed HST and added significant new capabilities to the Hubble mission. The planned SM-4 servicing mission would be no exception. The scientific output of discoveries coming from Hubble has been remarkable over the last 15 years. There is no doubt that this great scientific data stream will continue as long as the Hubble mission itself continues.

There are three options for continuing the Hubble servicing mission. Option one, a manned servicing mission, which NASA is very experienced at executing, and which would be carried out with brilliance and precision by the astronauts as they have done for other servicing missions. Option two, a robotic servicing mission that would advance important technology that would be extremely useful for future exploration missions of the solar system. Brilliant engineers are working on this. Option three, a free-flyer mission, to be launched on a rocket, that would rehost the COS and WFC3 instruments on a new telescope, and would add a very new wide field imager that would be provided by an international collaboration with Japan. This new Hubble observatory would be a low risk, with a highly optimized scientific return. The very wide field imager, with its one quarter of a billion pixels, would have a revolutionary impact on Hubble's science.

I will now discuss this new telescope option in more detail. Almost a year ago, we approached NASA with the idea of a free-flyer

option for hosting the COS and WFC3 instruments on a new telescope. This is essentially what we call the new car option, with state of the art technology. We have an experienced team, including four current NASA principal investigators. We have developed this study using the basic keep-it-simple principle. The Hubble Origins Probe concept is to replicate the design of the Hubble Space Telescope with a much lighter, unaberrated mirror and associated lightweight optical telescope, and a modern spacecraft, enabling a rapid path to launch, significant cost savings, and risk mitigation. Launch would be on an Atlas 521 rocket. The very wide field imager, VWFI, will be built in collaboration with our Japanese international partners. The cost will be borne by Japan. The scientific enhancement of the mission comes from the fact that the field of view of the very wide field imager is 17 times that of the Advanced Camera currently flying on Hubble, so we can map the heavens 17 times faster.

The conservative estimate of the cost of the HOP project is approximately \$1 billion, which is consistent with The Aerospace Corporation estimate for the project development up to launch. The groundbreaking science, the cutting edge technology generated in the development of new instrumentation, the ability of Hubble science to engage the interest of the public, and its impact on the imagination of students, makes it worthwhile to invest this sum of public funds to complete the last chapter of Hubble's remarkable legacy.

We have developed a detailed schedule for HOP and reasonably estimate that from the time of the authority to proceed, it will take 65 months to a successful launch. There are three points that I would like to summarize in closing. Point one, the great flow of science from the Hubble Space Telescope will continue unabated, as long as it can be serviced, either by manned or robotic missions, or continued by a new free-flyer mission. Point two, the low risk rehost free-flyer Hubble Origins Probe mission that I have outlined will also continue the great Hubble science program with its state of the art technology. With the inclusion of the very wide field imager, the scientific capabilities would be very greatly enhanced, and qualitatively new science can be done in some of the most important areas of physics and astronomy. Point three, HOP can address three of the most central intellectual issues of our age, the nature of dark energy, the nature and distribution of dark matter, and the prevalence of planets, including Earths, around other stars.

At the beginning, I mentioned remarkable Hubble moments. This is another such moment. It is time to decide whether to proceed with the Hubble science mission with any of the three options before us. The decision is obvious. We must continue with the Hubble adventure to explore these great questions further, to understand more fully our remarkable universe and our place in it. We must do this with intense determination and energy and thus continue to inspire new generations with the wonder and thrill of exploration and discovery.

Thank you, Mr. Chairman.

[The prepared statement of Dr. Norman follows:]

PREPARED STATEMENT OF COLIN A. NORMAN

Mr. Chairman and Members of the Committee, thank you for the invitation to appear before you today.

There have been many striking moments during the Hubble mission. There have been dark times that overshadowed us all; namely, the tragedy of *Challenger* during the pre-launch era of HST, and then more recently the *Columbia* tragedy.

There have been character-building times during the discovery of the spherical aberration of the mirror and then the correction of this problem carried out in the flawless First Servicing Mission.

Then, during the last 15 years, there have been the times of great discovery that have inspired us all. The precise establishment of the expansion rate of the Universe (the so-called Hubble constant), the determination of the age of the universe, a deep understanding of the origin and evolution of galaxies, basic discoveries concerning the origin and evolution of stars, and the existence of massive black holes at the centers of most galaxies. Indeed, Hubble discoveries have rewritten the text books from which our children learn.

Now, in the 21st Century, astrophysics has assumed a vital role at the heart of physics itself and Hubble has a major role to play. The universe will be the laboratory in which our fundamental understanding of the laws of physics in the most extreme conditions is tested, and Hubble is already making a major contribution to this understanding.

We now know that ordinary matter and light constitute only a small fraction (a few percent) of the mass and energy content of the Universe. The rest is called dark matter and dark energy. Dark energy may be associated with the cosmological constant introduced by Einstein. We know very little about these major components of our Universe. Hubble is essential to making progress in exploring the nature of the dark matter and dark energy.

Each of the previous servicing missions has renewed HST and added significant new capabilities to the Hubble Mission. The planned Fourth Servicing Mission would be no exception.

The two new science instruments scheduled for the Fourth Servicing Mission are the Cosmic Origins Spectrograph and the Wide-Field Camera 3. The Cosmic Origins Spectrograph (COS) will enable highly significant studies of the diffuse component of the Universe from which all stars and galaxies were made. At least half of the ordinary matter in the Universe may be identified for the first time using this instrument with its powerful spectroscopic capability. Wide-Field Camera 3 (WFC3) has greatly enhanced power for discovery in the blue and the red region of the spectrum and will significantly enhance studies of galaxies and stars. Its infrared capability is essential to studies of dark energy.

The scientific output of discoveries coming from Hubble has been remarkable over the last 15 years. There is no doubt that this great scientific data stream will continue as long as the Hubble mission itself continues. In addition, there has been very significant technical spin-off into industry in the areas of precision engineering, CCD development, systems engineering, large-scale software development and image processing, and state-of-the-art optical technology.

There are three options for continuing the Hubble science mission:

- (1) A manned servicing mission which NASA is very experienced at executing and which would be carried out with brilliance and precision by the astronauts as they have done for the other servicing missions. The issues of safety have been reviewed extensively since the *Columbia* accident and my team cannot add more to that debate.
- (2) A robotic servicing mission that would advance important technology that would be extremely useful for future exploration missions of the solar system. The technical feasibility of a robotics mission has been addressed by the recent Academy study. However, it is important to mention that outstanding scientific and engineering efforts are being made at Goddard Space Flight Center and elsewhere to achieve this goal.
- (3) A free-flyer mission to be launched on a rocket that would rehost the COS and WFC3 instruments on a new telescope and would add a new Very Wide-Field Imager that would be provided by an international collaboration with Japan. This new Hubble Observatory would be a low-risk mission with a highly optimized scientific return. The Very Wide-Field Imager with its one quarter of a billion pixels would have a revolutionary impact on Hubble science.

I will now discuss this new telescope option in more detail.

Almost a year ago we approached NASA with the idea of a free-flyer option for hosting the COS and WFC3 instruments on a new telescope. This is essentially what we call the “new car” option with state-of-the-art technology. We successfully proposed for NASA’s Origins Probes studies program and have been pursuing this NASA-funded study since that time.

We have an experienced team including four current NASA Principal Investigators. We have developed the study for what we call the Hubble Origins Probe (HOP) using the basic KISS (keep-it-simple) principle. The HOP concept is to replicate the design of the Hubble Space Telescope with a much lighter, unaberrated mirror and associated lightweight optical telescope and a modern spacecraft enabling a rapid path to launch, significant cost savings and risk mitigation. Launch into low-Earth orbit would be on an Atlas 521 rocket. A general summary of the Hubble Origins Probe Mission is given in *Appendix 1*. Because of the fast-track schedule for HOP, it would have to start the line of these Origins (or Universe) Probes.

HOP will fly the instruments originally planned for the fourth servicing mission, namely COS and WFC3, as well as a new, very-wide-field imager that will very significantly enhance the original science mission of Hubble.

The very wide-field imager (VWFI) will be built in collaboration with our Japanese international partners. The cost will be borne by Japan. The scientific enhancement of the mission comes from the fact that the field of view of the VWFI is 17 times that of the Advanced Camera currently flying on Hubble and the VWFI is 3–4 times more sensitive at critical wavelengths. This means that we can map the heavens more than 20 times faster.

It is important to note that the Japanese camera will be provided for the use of the entire astronomical community and that, as for COS and WFC3, time on this will be granted by a peer review system that is based on the merit of the proposal as is normal with Hubble time allocation.

Note that the empty fourth quadrant in the field of view could host an additional instrument. One exciting possibility, which we have been discussing with our European and Australian collaborators, is an integral field spectrograph that could make excellent progress in studying super massive black holes at the center of galaxies.

The conservative estimate of the cost of the Hubble Origins Probe project is approximately \$1 Billion, which is consistent with the Aerospace Corporation estimate for the project development up to launch. This is discussed further in *Appendix 2*. The ground-breaking science, the cutting-edge technology generated in the development of new instrumentation, the ability of Hubble science to engage the interest of the public, and its impact on the imagination of students, make it worthwhile to invest this sum of public funds to complete the last chapter of Hubble’s remarkable legacy. Now, \$1 billion is a great deal of money in this time of large budget deficits, but that is what this type of space science mission costs. We argue that the Hubble Mission is a national treasure that both requires and is worthy of the investment of this level of government resources. We believe that the intellectual legacy of HOP would be invaluable. The investment of \$1 billion in leading edge technology, the launch of a state-of-the-art observatory and the excitement that comes with renewed exploration of our universe will ripple out over industry, NASA centers, universities, and grade schools as the components are designed, built and flown and new secrets of the universe are revealed. HOP will inspire and motivate young scientists and engineers, helping seed America with the human capital so vital for the long-term strength of our high-tech economy. For these reasons it is important to maintain and strengthen the partnership between academia and government that has been so vital to our exploration of space.

We have developed a detailed schedule for HOP and reasonably estimate that from the time of the authority to proceed it will take 65 months to a successful launch. This is faster than the Aerospace Corporation estimate of 100 months, but our team has in-depth experience and after an extensive analysis of the schedule we have concluded that the 65 months estimate is reasonable. This is discussed further in *Appendices 3* and *4*. We believe launching HOP near the end of this decade is feasible and of the utmost importance. We are motivated by our sense that great discoveries on the nature of the dark matter, dark energy and planetary systems around other stars are imminent and our belief that the HOP mission sits in a vital position in the NASA roadmap, serving as an essential pathfinder to the even more ambitious missions to map the universe planned for 2015 and beyond. The many young talented scientists and engineers currently associated with Hubble are in place, ready to meet the challenges and reap the challenges of HOP today. They are a pool of expertise and energy which could dissipate should Hubble science fade or the gap between HOP and HST grow too long.

In the context of the astronomical roadmap, our goal with HOP is to first repair the bridge broken by the *Columbia* tragedy, and then drive over that bridge and

explore current territory planned on the roadmap for Hubble science. Subsequently, using our newly enhanced capabilities, we can drive significantly further onwards to explore and map quite new and interesting territories.

There are three points I would like to summarize in closing:

- (1) The great flow of science from the Hubble Space Telescope will continue unabated as long as it can be serviced either by manned or robotic missions or continued by a new free-flyer mission.
- (2) The low-risk, rehost, free-flyer Hubble Origins Probe mission that I have outlined will also continue the great Hubble science program with its state-of-the-art technology. With the inclusion of the Very Wide-Field Imager, the scientific capabilities would be very greatly enhanced and qualitatively new science can be done in some of the most important areas of physics and astronomy.
- (3) These Hubble-related science questions that I have been discussing, including the dark matter and dark energy that constitute most of the Universe, the nature of black holes, and the nature and discovery of planetary systems around other stars, are the subject of intense study by astronomers and physicists. Clearly though, these topics are now not merely in a specialized domain for astronomers only. With HOP we can address three of these most central intellectual issues of our age: the nature of dark energy, the nature and distribution of dark matter and the prevalence of planets, including earths, around other stars.

At the beginning of my talk I mentioned striking moments during the Hubble mission. This is another such moment. The moment now has come to decide whether to proceed with the Hubble science mission with any of the three options before us.

The decision is obvious. We must continue with the Hubble adventure to explore these great questions further, to understand more fully our remarkable Universe and our place in it. We must do this with intense determination and energy and thus continue to inspire new generations with the wonder and thrill of exploration and discovery.

Further information on HOP can be found at the public HOP web site: www.pha.jhu.edu/hop

Appendix 1:**HUBBLE ORIGINS PROBE (HOP)****1. Overview**

A no-new-technology HST-class observatory with the Cosmic Origins Spectrograph (COS), the Wide-Field Camera 3 (WFC3) and the very wide-field-imager (VWFI) as its core instruments can be launched to low-Earth orbit (LEO) on an Atlas 521 during 2010 with a cost of \$1 billion. Using technology developed and perfected since HST was built 25 years ago, we can construct the Hubble Origins Probe (HOP) with a much lighter unaberrated mirror and OTA than those in HST, significantly reducing cost. The HOP mission will be uniquely well suited to the study of the modern universe over the epoch where the majority of star and planet formation, heavy element production, black hole growth, and final galaxy assembly took place. COS/HOP will reach two magnitudes deeper than HST/STIS enabling a broad, deep science program: from the physics of massive star formation in local group galaxies to the atmospheres of giant planets. With a ~100-fold increase in the number of background quasars available for absorption studies, COS/HOP will revolutionize our study of the intergalactic medium. WFC3/HOP provides a ~10-fold increase in discovery power in the Near Infrared (NIR), and a ~100-fold increase in the ultraviolet (UV), enabling new areas of survey science, and addressing fundamental questions about the origin and evolution of galaxies, black holes, and planets. With its capabilities focused on high resolution imaging in the ultraviolet and optical parts of the spectrum, HOP will be a critical complement to NASA's Spitzer and JWST missions in the quest to understand our origins and our universe.

As a new state-of-the-art mission, HOP provides unique opportunities to extend the discovery space provided by COS and WFC3 on Hubble. We will turn the requirement to replace the aberration-correction optics in COS and WFC3 into an opportunity to extend the wavelength range of the COS down to 110 nm, enabling critical new science. Our Japanese partners are leading the development of a high throughput, Very Wide-Field Imager (VWFI) that achieves a field of view approximately 17 times larger than the current Advanced Camera for surveys (ACS) by tilting one half of the unaberrated focal plane with CCDs. We have a novel optical solution for correcting the astigmatism and field curvature in the HST-like wide-field of view Ritchey-Chretien design and are prototyping high throughput Hammamatsu CCDs. High-resolution high-throughput multi-color very wide-field imaging from space with HOP/VWFI would enable unprecedented studies of: the origins of galaxy morphology; the nature of dark energy through an efficient search for distant type Ia SNe; the distribution of dark matter and measurement of cosmological parameters with weak gravitational lensing; the census of thousands of planetary transits per year and, via microlensing, detection of Earth-like planets.

2. Engineering and Technical

We have studied the feasibility of developing and launching the HOP in 2010 to assure the continuity of Hubble science. The approach uses the simplest and lowest risk concept—a dedicated free-flyer mission carrying COS, WFC3 and VWFI. Cost and risk are minimized by use of existing inventory of satellite components and ground systems to the maximum extent possible. The mission is not constrained to reach Hubble before its demise and no Shuttle launch is required.

To preclude complete redesign of the WFC3, the first order optical parameters of the optical telescope (OTA) must match those of the HST. The Science Instruments (SI) interface will be identical to that of HST. We include three Fine Guidance Systems (FGS) for fine guidance control in the core complement. The HOP will use a modern spacecraft with Spitzer heritage and will be launched into a 28.5 degree ~700 km circular orbit by an Atlas 521. The spacecraft provides the functions of HST power, data handling, pointing, and communications based on SIRTf heritage. A de-orbit module based on TDRSS heritage is added. HST-quality pointing and jitter control is achieved using the HST approach with one HST FGS and two new simpler FGS's that use modern technology. A key design issue is mass reduction to control cost and complexity. The mass of the OTA plus SIs is reduced by nearly 50 percent from HST. The necessary de-orbit module is a simple low-cost two-tank design. See Figures 1–3.

3. Cosmic Origins Spectrograph (COS) and Wide-field Camera 3 (WFC3)

The COS gratings will be replaced because the telescope image will be unaberrated. This opportunity will be used to shift the short wavelength cutoff from

1150 Å to 1100 Å. By shifting to a shorter wavelength, significant advances in intergalactic medium studies will be possible.

No major modifications of WFC3 are anticipated in the baseline mission. The primary changes will be the replacement of a few components in the optical train to correct for the unaberrated image of the HOP telescope. No filter changes have been base-lined.

4. Very Wide-Field Imager (VWFI)

The nature of dark energy, the nature and large-scale distribution of dark matter and the demographics of extra-solar planets are outstanding problems for twenty first century science. Solving these problems requires ultra-stable, wide-field, diffraction limited imaging in the optical and near infrared. The HOP Very Wide-Field Imager (VWFI) is specifically designed to attack these and other important origins questions. The VWFI is a camera that will be contributed by Japan. The Japanese astronomy and industrial team is being led by Dr. Saku Tsuneta (National Astronomical Observatory), and is drawing on Japan's deep reservoir of experience in building instruments for space astronomy and ultra wide-field imagers and spectrographs for the Subaru 8m telescope.

The Japanese design to "pave" one half of HOP's unaberrated focal plane with Hamamatsu 2K × 2K CCDs is advancing very quickly. See Figure 4.

The VWFI will have a survey capability 17 times greater than the current Advanced Camera for Surveys (ACS) at all wavelengths.

We will use this powerful new capability to detect thousands of transits by planets in the bulge stars, opening an exciting era of planetary demographics, survey for hundreds of high-z Type Ia supernovae to investigate the nature of dark energy, and to make large area weak lensing surveys to measure the large scale distribution of dark matter. See Figures 5–7.

Appendix 2:

HOP COST ESTIMATE

For further details please see the HOP website www.pha.jhu.edu/hop. The HOP costs are based on a 65-month schedule and it is assumed that funding is available as needed. Three Fine Guidance Sensors are budgeted. A 15 percent fee is included. The VWFI is provided by Japan. Limited availability is assumed for HST-heritage: ground-handling equipment and facilities, test equipment and facilities, transportation, and storage equipment.

Item		FY04 \$M
1	Spacecraft	190
2	DeOrbit Module	12
3	Optical Telescope Assembly	242
4	Science Instrument Modifications	35
5	Science Instrument Integration	12
6	Fine Guidance Sensors	63
7	Space Vehicle Integration & Test	115
	Subtotal	667
	30% Contingency	174
8	Atlas 521 Launch Vehicle	150
	Total	991

Appendix 3:

HOP SCHEDULE

See www.pha.jhu.edu/hop for the integrated master schedule in MS Project.

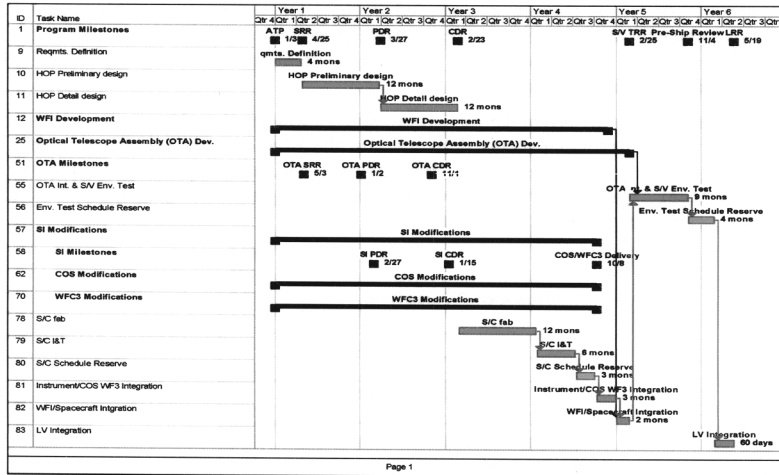

Appendix 4:

COMPARISON WITH AEROSPACE REPORT

The Hubble Space Telescope (HST) Servicing Analyses of Alternatives (AoA) Aerospace Report identified \$2B life cycle cost (including costs for government oversight, mission operations and the cost of the Hubble Space Telescope de-orbit module) for the low-Earth orbit (LEO) free-flyer mission to rehost the HST instruments COS and WFC3. This mission is equivalent to the HOP.

The HOP project cost is approximately \$1B (\$991M) which includes only space vehicle development costs (Phases B, C & D) over a 65-month development span. Thus, the difference between the Aerospace (\$2B) and HOP (\$1B) costs represent inclusion of different portions of very similar project cost estimates.

There are three significant differences between the Aerospace and HOP values. These differences are delineated in Table 1.

- 1) A major difference is that Aerospace developed total life cycle cost, whereas the presented HOP cost represents only project cost. Mission operations (\$300M) and government oversight (\$200M) costs are not included in the HOP project cost, but are appropriately included in total life cycle costs. This accounts for approximately \$500M (50 percent of the difference). Mission operations costs should be the same for HOP as for a refurbished Hubble Space Telescope.
- 2) The second difference is that the Aerospace rehost mission cost includes costs for a Hubble Space Telescope (HST) de-orbit only mission (\$400M) to provide safe HST disposal at the end of its science mission. This work would not be managed by the HOP project office, and thus is not included in the HOP project cost. This accounts for approximately 40 percent of the difference. The HOP design (and project cost) does include a HOP integrated de-orbit propulsion and control system that will safely dispose of HOP at the end of its science mission.
- 3) The third difference is that the Aerospace estimate was developed assuming a 100-month space vehicle development schedule, whereas the HOP estimate was based upon a 65-month development span. This accounts for approxi-

mately \$100M (10 percent of the difference). This number was derived assuming a program loading of 135 EP at \$250K cost per person per year for 35 months.

	FY04 \$M
Aerospace Rehost Cost	2000
Mission Ops	-300
De-Orbit Cost	-400
Govt. (est.)	-200
65- vs. 100-month program cost	-100
Comparable Rehost Cost	1000
HOP Cost	991

Table 1. Itemized differences between Aerospace LEO COS and WF3 rehost and HOP costs.

When compared on a project cost basis, both the Aerospace report and the HOP costs result in equivalent project costs of approximately \$1B (including a 30 percent contingency).

Note that although neither the Aerospace report nor the HOP costs include development costs for the proposed very wide-field imager (VWFI), HOP costs and schedules do include space vehicle systems engineering and integration associated with the VWFI.

With regard to the 100-month Aerospace and 65-month HOP development schedule estimates, the HOP project office plans to execute an efficient 65-month space vehicle development span as possible, while still including appropriate schedule contingency for all major activities. This schedule minimizes any gap between HST and HOP and also avoids marching army costs associated with an extended development span. In the specific case of HOP a 65-month (5½ years) development span for HOP is reasonable because space vehicle design, integration and CONOPS are being reused from the highly successful HST.

Besides having achievable 12-month spans between ATP and system PDR as well as between system PDR and system CDR, HOP's 65-month development span includes serial, completely independent and fully funded schedule reserves at the following levels: six months of schedule reserve in the VWFI development (program critical path); four months of OTA development schedule reserve; three months each of COS and WFC3 development reserve; three months of spacecraft assembly schedule reserve and four months of system-level schedule reserve between the end of environmental test and shipment to the launch base.

In summary, the difference between the Aerospace and HOP cost presentations are primarily a matter of scope. The Aerospace Report's \$2B life cycle cost includes costs for government oversight, mission operations (Phase E) and the \$400M cost of the Hubble Space Telescope de-orbit module which are appropriately not included in the \$1B HOP project cost.

The Aerospace Report's 100-month schedule is significantly conservative and appropriate were HOP an entirely new mission being constructed *ab initio*. However, the proposed HOP is deliberately designed to allowed streamlined development. The HOP baseline 65-month (5½ year) integrated master schedule has reasonable, 12-month spans between system design reviews, adequate instrument modification and VWFI development spans, as well as serial and fully funded schedule reserve for each significant activity in addition to four months of system-level schedule reserve.

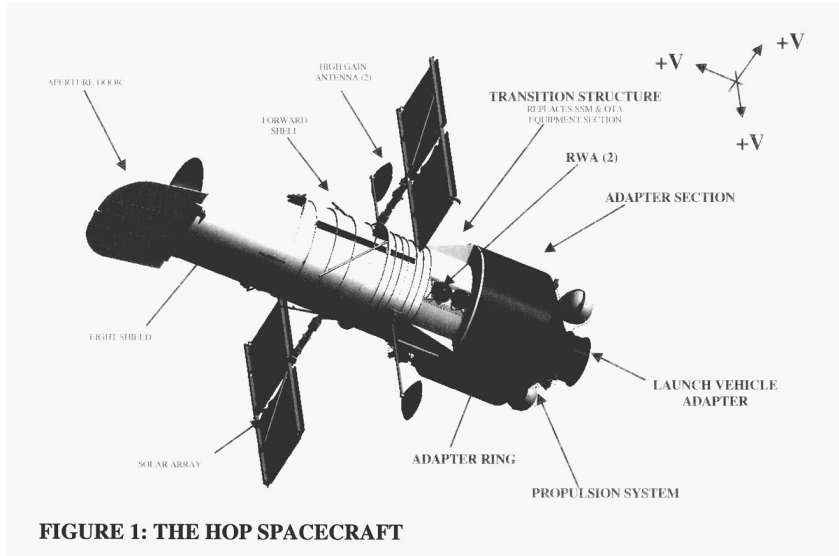

FIGURE 1: THE HOP SPACECRAFT

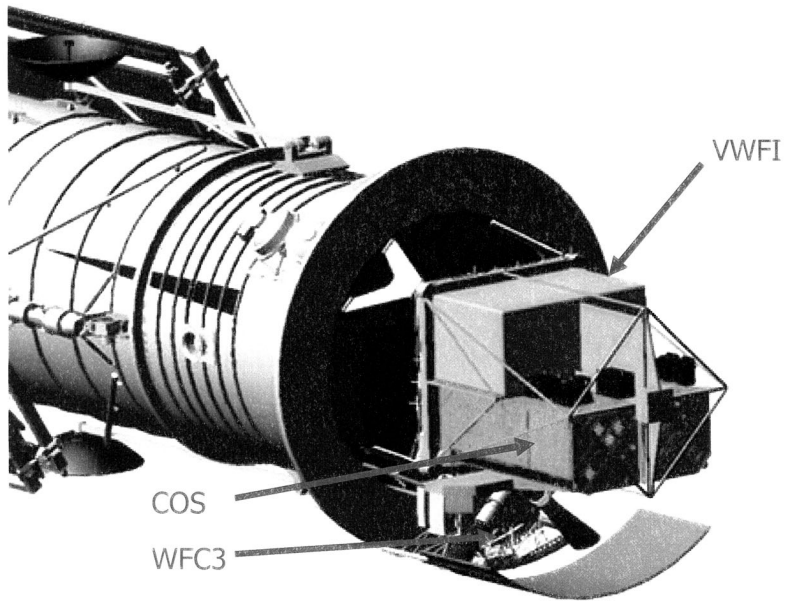

FIGURE 2: THE HOP INSTRUMENTS

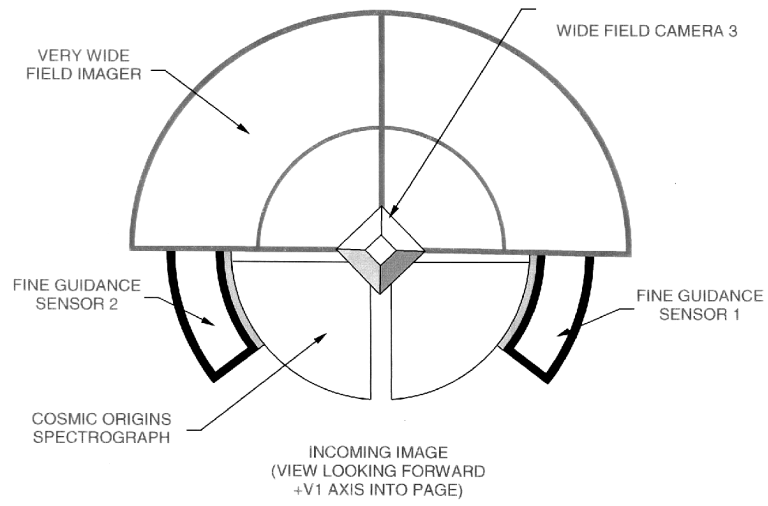

FIGURE 3: THE HOP FOCAL PLANE

FIGURE 4: THE VERY WIDE FIELD IMAGER

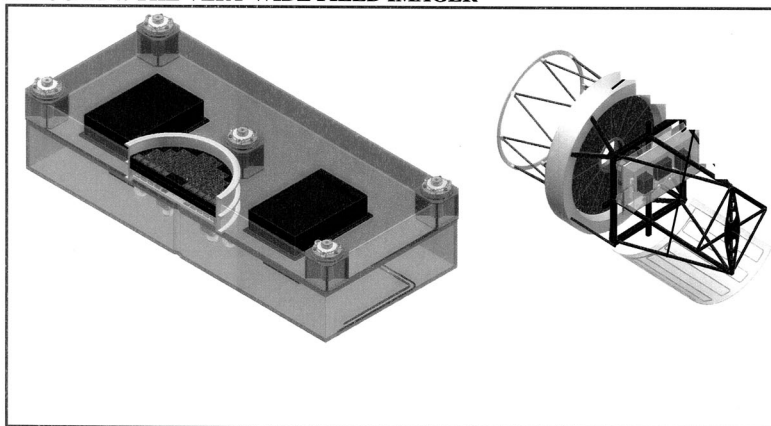

FIGURE 5: DARK ENERGY

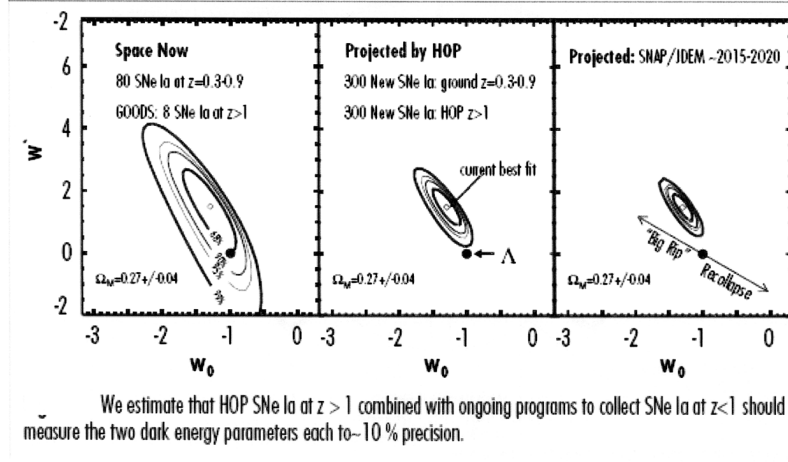

FIGURE 6: DARK MATTER



HOP will map dark matter on large scales using gravitational lensing. The dark matter in this cluster of galaxies, seen at half the age of the Universe, was derived from weak lensing and is shown in violet. This image provides the most detailed picture of dark matter to date.

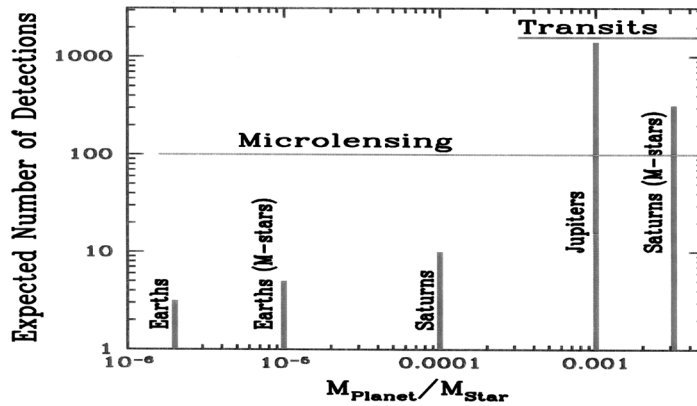
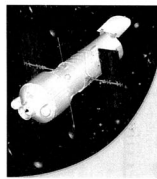

FIGURE 7: PLANETARY SEARCHES AROUND OTHER STARS
HOP will find thousands of planets around other stars and even planets of earth-like mass



HOP HUBBLE ORIGINS PROBE: A THIRD OPTION

The HOP Team

The HOP Study was funded by NASA under the Origins Probe Line

Academia US

JHU: Bianchi, Ford*, Heckman, Kruk, Moos*, Norman (PI)
Caltech: Steidel
Colorado: Green*, Shull
Rochester Inst of Tech: Baum

Centers

STScI: Giavalisco, Nota, Ouchi, Riess, Sahu, Somerville

Industry

Lockheed: Crocker, Woodruff, Reeve, Tenerelli
Ball: Ebbets
ITT/Kodak: Matthews, Wynn

International

Japan: Tsuneta*, Kaifu, Miyazaki, Hakaya, Yamada, Iye
EU: Bacon, de Zeeuw, Fosbury, Larsen, Silk
Australia: Freeman, MacGregor
Canada: Hutchings

* Current NASA Principal Investigator

Biographical Details

Colin Norman is Professor of Physics and Astronomy at The Johns Hopkins University and Astronomer at the Space Telescope Science Institute. For more information see www.pha.jhu.edu/~norman

BIOGRAPHY FOR COLIN A. NORMAN

Colin Norman is Professor of Physics and Astronomy at The Johns Hopkins University and Astronomer at the Space Telescope Science Institute. He works on both theoretical and observational astrophysics in areas including: the formation, structure, and evolution of galaxies; the physics of active galaxies, quasars, and starburst galaxies; the structure of the intergalactic medium and the interstellar medium; and, star formation.

He was an undergraduate at the University of Melbourne, Australia, a graduate student in Theoretical Physics at Oxford as a Rhodes Scholar, and then elected as a Fellow of Magdalen College, Oxford. After his postdoctoral work at UC–Berkeley as a Miller Fellow, Dr. Norman joined the faculty at Leiden University as an Assistant Professor in 1978. In the next six years he held, in addition, appointments at the Institute of Astronomy, Cambridge, the University of Paris and the European Southern Observatory. In 1984, he moved to his current post in Baltimore. From 1988 through 1994 he was Head of the Academic Affairs Division at the Space Telescope Science Institute. He frequently visits the European Southern Observatory where the optical work for this project was done using the eight-meter telescope at the VLT. He is currently proposing to create a new Astrophysics Institute at the Johns Hopkins University.

DISCUSSION

Chairman BOEHLERT. Spoken like a true advocate. Thank you very much, Dr. Norman.

The Chair now is pleased to recognize the Chairman of the Subcommittee on Space and Aeronautics, Mr. Calvert.

WEBB VERSUS HUBBLE

Mr. CALVERT. Thank you, Mr. Chairman, for giving me the courtesy to start early. Dr. Taylor, NASA is developing, as you have mentioned in your testimony, a new, larger telescope, the James Webb Space Telescope, which is, as you know, scheduled to launch in 2011.

How do the capabilities of this Webb telescope compare to what we would get from the Hubble if it was serviced, or for that matter, the rehosting option that Dr. Norman advocates?

Dr. TAYLOR. All right. The Hubble telescope is, of course, a 2.4 meter telescope. The James Webb telescope is six meters in diameter, a very much larger collecting area. The James Webb telescope is optimized for use in the infrared part of the spectrum, the near infrared, and the wavelength region is—overlaps, but only a small amount, so the differences are substantial, and as I attempted to point out, the judgment of the Survey Committee, when this was done, was that pushing into this new wavelength region from space would be extraordinarily beneficial scientifically.

I don't want, at all, to downplay the highly desirable, very important science that will still be accomplishable by a refurbished Hubble telescope.

Mr. CALVERT. In that vein, how disruptive would it be to science and to the astronomers, and the—your opinion, and the opinion of your committee, if the Hubble was to cease operation before the James Webb telescope is launched?

Dr. TAYLOR. The best, by far, would be to have both, but it was always understood that the Hubble's time would end at about the time that the James Webb telescope became available, so simultaneous observations were never thought to be a likelihood. Keeping the Hubble going until that time would still be very desirable.

COST AND SCHEDULE OF A ROBOTIC SERVICING MISSION

Mr. CALVERT. Mr. Pulliam, Dr. Lanzerotti, in the testimony, Dr. Cooper stated that he believes that The Aerospace Corporation, National Academy reports were overly pessimistic, and overstate the costs of—risks of a robotic servicing mission. And he seems to make a strong argument—I was—I am also on the Armed Services Committee. I am compelled by the DOD portion of that, of servicing somewhere down the road, but in your opinion, both Mr. Pulliam and Dr. Lanzerotti, do you believe it is possible that NASA could meet the costs and schedule that Dr. Cooper laid out?

Mr. PULLIAM. Mr. Calvert, let me begin. I think it is important when we talk about cost, to make sure we understand what terms we are using. As I said in my prefatory remarks, the Aerospace analysis of alternatives was just that. It was not an assessment of any individual program. It specifically was excluded from our task list from NASA. It was an analytical survey. But that is not just throwing a dart against a dartboard. Our analytical results came from a database which has results of hundreds of systems and thousands of subsystems on how they really came out, not what was advertised at the beginning.

So, in the process of coming up with these cost estimates for these various missions, we did rely on all the data that is available with regard to cost and schedule. With regard to how our costs were put together, through the issue of the \$2 billion for rehosting, say, versus a \$1 billion cost, again, it is important to realize that the Aerospace models are all our life cycle costs. So, that means included in those costs are not only the costs of building the instruments, and the costs of building the spacecraft vehicle, but also included in our numbers are \$300 million or so of operations over the course of the years that that module would be attached to Hubble, or that a new instrument would be in space. Launch vehicle costs are included in our costs. I haven't heard anybody talk about that. And in all our missions, we also include a de-orbit possibility for Hubble, which the minimum cost for that is about \$300 million, so that must be added. Additionally, we baseline the Goddard system, as they are presently developing it, in terms of the kind of capability. So, when you look at life cycle costs, and begin to take out of that the elements that might not be in someone else's estimate, you get closer on the numbers, and again, realizing that our numbers are analytical.

Any program that looks at the results of how a program might be cost, or might come in on schedule, certainly, the elements that comprise that are in a bell curve. If certainly someone is going to come in under cost and under schedule, but I must say, we see that far less frequently than we see folks who do find technical challenges, and do find costs and schedule delays as they go through programs. So, we believe our analysis rightfully looks at how things have come out versus how they have started.

And finally, to the issue of the grapple arm, of a contract of—a firm, fixed price contract that might be in the \$150 million range versus Aerospace's advertisement of \$700 million. Well, again, our costs are life cycle costs, and are a total of system cost for that arm, I am not privy to the contract for the MDA arm. That contract

had not been awarded when we completed our survey, so we did not look at that program at all, because ours was an analytical survey. But the arm to arm cost, in our estimate is about \$285 million, versus about \$150 million. The remainder of our cost, and the \$700 million, are for things like interface with the spacecraft, increased mass, increased power, software, all the things that we know happen when you hook up something like an arm to a spacecraft in a way that has not been done before.

I congratulate the gentleman on the use of the arm, but operating it on the Shuttle is, in our opinion, different than mating it up to a new spacecraft also in development. With regard to the arm being delivered at the 31 month period, versus our estimate of 64 months, we frankly didn't find the delivery of the arm to be on the critical path of the 66 months. It is the development of the interfaces and the entire system, and getting the spacecraft ready to go with an arm that drove our estimate. So, that is how we came to our conclusions.

Mr. CALVERT. Thank you. My time has expired, but Doctor, would you have any further comment on that?

Dr. LANZEROTTI. If I have a moment, I would like to refer—we had a subcommittee, chaired by Mr. Rothenberg, who looked at the—who did many, many visits to look at the robotic development, and I would like to ask him, if I might, to make some comments related to your question.

Mr. CALVERT. The Chairman.

Mr. ROTHENBERG. Thank you for the opportunity. Number one, I can't commend MDA more for the performance of their robotics to date. The Space Shuttle and Space Station. And the robot was never the issue. We did know from the beginning that that is what the project was baselining. However, I would point out that even in the Space Shuttle, after nine years of flying it, we were still fine-tuning algorithms when we released the Hubble. As General Bolden would remember, there were differences with a mass—vehicle of that mass that needed some fine-tuning of the algorithms on orbit. In fact, with the Space Station, we had a few problems up front in the initial deployment of the robotic arm that is up there today.

The second point I want to make is, the XSS-10, 11 experiment. I am well familiar with it. They briefed us. We had discussions with them, and indeed, the sensor on board, the LIDAR sensor, which is an important part of the Hubble mission, performs one part of the algorithm processing, one part of the sensor detection that feeds the algorithms for the capture of Hubble. However, that is a different vehicle. It is—the technology there is not demonstrating six degrees of freedom, and capture on the translation and rotation that are really needed for the Hubble capture, so there is work once that demonstration is done, on orbit, assuming that it is successful. We are familiar with the optic sensor, and the fact that it is the same sensor that MDA is proposing to use for Hubble, but there is development work.

Finally, the experiments done by the Russians, they were generally all the robotic rendezvous and docking with Progress vehicles. That is all done with what is called a cooperative vehicle, a vehicle that actually has detection on board of an approaching vehicle, and closes the loop. Hubble is not a cooperative vehicle. It

doesn't have fiduciaries on it. A number of complications associated with it. Finally, and finally, the other important point is given the time and given the funding in '05, that the project has, and the time limits, they have not received the full funding that they really need to make the schedule alone, so they are starting out behind the eight ball to begin with.

Given all of those points, our report did consider, I think, almost all of the aspects, and the robot itself was not the issue. It was the system integration, the algorithm development, the validation of the algorithms, and the testing. If I deliver the robot at 31 months, I only have eight months left in which to integrate and work out all the system bugs with the whole rest of the system. And to us, that would seem like a very unreasonable, based on our experience.

Mr. CALVERT. Thank you, and thank you, Mr. Chairman. I just—as a comment, I certainly am intrigued by this technology, but it seems to be very complex. Obviously, we have a budgeting process, and we have a time problem. And I certainly look forward to—I would like to look at it from a DOD perspective, possibly a demonstration project of some type on servicing some of our DOD satellites. This may be some kind of way to find some additional resources to do something like this. But—

Chairman BOEHLERT. Thank you very much, Mr. Calvert. Dr. Lanzerotti, once again, for the benefit of the recorder and the audience, would you introduce your associates for the record?

Dr. LANZEROTTI. Yes. This was Mr. Joseph Rothenberg. I called on him because he was the chair of our subcommittee on the robotics, and led that group. He is the former head of the NASA Goddard Space Flight Center. Thank you for allowing me to use my associates. They bring a certain credibility to this in specialized areas that I could express, but I don't have the same level of credibility that I believe my colleagues do.

Chairman BOEHLERT. Thank you so much for introducing him, and it is good to see you back here. This was billed as an exchange of views, and I am sure that Dr. Cooper has a somewhat different view of the remarks just made, so I will impose on the Committee, and give him a couple of minutes to respond before we continue with Mr. Gordon.

Dr. Cooper.

Dr. COOPER. Thank you, Mr. Chairman, and—

Chairman BOEHLERT. Everybody knows that the people we have here have unquestioned credibility.

Dr. COOPER. Absolutely.

Chairman BOEHLERT. And they have points of view. Where, in your estimation, did they go wrong?

Dr. COOPER. Okay. You might characterize me at the moment as dying to respond to these points that have just been raised. I will start with the gentleman from The Aerospace Corporation. First, actually, when I first looked at the Aerospace Report, I was extremely pleased, because it is very important, when you try to analyze a mission like this, to compare it to things that are like it, and that is the essence of what The Aerospace Corporation report did. The thing is, if you look at the total database of all space programs, you are looking at almost entirely clean sheet programs that started from scratch, and there is almost no programs in their database

that they compared against that were, in fact, started from the beginning as running start programs, and in fact, if you do the same kind of analysis and throw some comparables in there, such as the development of the Boeing 702 commercial communications satellite, you find a much different story about the schedule, and in fact, the schedule looks like 40 months if you start with a running start, and you have a goal to get there, it is not a problem at all. So, that is my first point. The second point that was raised just moments ago, by the—Mr. Pulliam, was with respect to what is included and what is not included. And I am pleased to tell you that in the budget that I showed you, it is approximately a billion dollars, the NASA project budget. It actually includes the launch. And with respect to what is included with the robotics system, and how hard is it to interface to the spacecraft, et cetera, I am happy to tell you that the \$25 million I quoted includes the avionics box that controls the robot and interfaces with the spacecraft. So, in my view, it is a question of what, you know, what you compare to when you look at The Aerospace Corporation report and especially the running start story.

Now, if I might, just a moment, turn to Mr. Rothenberg's comments. Boy. The first thing I want to address is the XSS-11 mission. Mr. Rothenberg said correctly that it doesn't exactly test exactly what we are doing on the Hubble. However, it does establish a major credibility point for the space program of the U.S. This is an Air Force mission. In the core competence of can we find a spacecraft, can we find it, can we use sensors that are very advanced? This LIDAR thing, it can see, basically, something the size of half an inch from a distance of two miles. So once we have done this mission, we have gone a long way, and the few additional pieces, such as this six degree of freedom, essentially have to detect how the spacecraft is positioned relative to you. That part of it is not going to be done in XSS-11. However, there is already on the plan what is called a DTO mission, to fly that exact software very soon. So, again, this risk will have been retired far before we actually try to launch this mission and execute it.

And one—a couple more comments. The funding story, it is true if the program runs out of money, the schedule is going to lengthen. At the moment, all of the components of this program have been running full blast, that is, there has been enough money, so far, that we haven't had any slowdowns, and I encourage the Committee, of course, to keep it that way. So, that has not been a factor to date

And one last comment, which is I very much regret the fact that the Committee didn't come out to see the reality of Dextre in real life. I wish they had. Thank you for your time.

Chairman BOEHLERT. That is an open invitation, I take it.

Dr. COOPER. Oh, absolutely.

A HUBBLE SERVICING MISSION'S EFFECT ON OTHER SCIENCE MISSIONS

Chairman BOEHLERT. Thank you very much, Dr. Cooper. And let me point out that following this hearing, we will submit some questions in writing to all of you. We would appreciate a timely response, and we will also welcome from you sort of a supplemental

statement of—based upon this hearing, some additional thoughts that you think should be brought to our attention. The ideal situation would be to have this back and forth like we have right now. That is where we learn the most, and that is where we get out, exposed into the light of day, the varying points of view. But we don't have unlimited time, so we will make that opportunity available to all of our witnesses, to supplement, following this hearing, your written testimony, and we will make certain that all our members see that, and have the advantage of that input.

Now, it is my turn. Dr. Taylor, you know, as I mentioned at the outset, if the Hubble servicing was going to deprive the science programs of more than a billion dollars, Dr. Taylor said he would reluctantly opt for letting Hubble die. You know, and that, you know, we try so very hard to say we don't have unlimited resources up here. Give us your best guidance, and Dr. Taylor, thank you so much for trying to help us get it in perspective. I would like to see what Dr. Lanzerotti and Dr. Beckwith and Dr. Norman have to say. Would you agree with that assessment?

Dr. Lanzerotti.

Dr. LANZEROTTI. I am not sure I understand exactly your question.

Chairman BOEHLERT. Well, you know—

Dr. LANZEROTTI. Mr. Chairman.

Chairman BOEHLERT. Dr. Taylor tried to help us, tried to quantify. He said if it is going to cost more than a billion dollars, then maybe, because of the risk to other programs, it is not worth the price. If it is going to cost less than a billion dollars, let us go forward. I mean, we are all cheerleaders for Hubble.

Dr. LANZEROTTI. Okay.

Chairman BOEHLERT. We all stand up and applaud when we think about its accomplishment, but there comes a point of diminishing returns, based upon costs and impact on other programs.

Dr. LANZEROTTI. Well, you have to recognize Dr. Taylor was a member of my Committee.

Chairman BOEHLERT. Sure.

Dr. LANZEROTTI. And we had a unanimous opinion. And unanimous conclusions. And our conclusions did not get into the questions of the place of dying Hubble with—or a dead Hubble, with the Decadal Survey. We took it as given that the Decadal Survey of Astrophysics that was issued in 2000 or 2001, Joe, was—assumed Hubble Servicing Mission 4. So that the optical astronomy would be present to continue—optical astronomy would be present with the two new instruments installed in Servicing Mission 4, so that that optical astronomy, with the enormous increase of capabilities—in—that the two new instruments would allow, would be present during this time prior to James Webb telescope, so that there would be the new science, plus the science that would be achieved in the overlap with the ongoing NASA great observatories, the Chandra, the infrared telescope, and other missions that are up there. And so, that was the premise that our committee went on. We did not—our committee did not redo the Decadal Survey. We did not get into this question of—

Chairman BOEHLERT. Well, forget about the Committee for a moment. If you will just as a scientist, I mean—the basic theme that

he advanced, I mean, if it is going to cost more than a billion dollars, the impact on other science programs are not worth the additional costs. He guides us in that direction. And he would say, end it and go forward with the other programs. As a scientist—

Dr. LANZEROTTI. Okay. As a scientist. I am not an astronomer. I think one of the reasons why I was selected to chair this Committee was the fact that I had never used Hubble, didn't know anything about Hubble practically going into this. I have done a lot of space research on unmanned robotic spacecraft throughout the solar system, and mainly, and often around the Earth's environment, for practical purposes, when I was at AT&T and Lucent. As a scientist, I would say that if the billion dollars were going to come out of some other aspect of NASA's science program, such as Earth science, such as solar terrestrial science, then I would have a serious question about that.

With regard to astronomy, I think that I would defer to the astronomers. As I said at the end of my testimony, if the Shuttle repair mission were not possible, for instance, return-to-flight were not possible, then I would recommend that tradeoffs involving a rehosting mission should be reviewed by the astronomy community in the context of its Decadal Survey.

Chairman BOEHLERT. Well, let us hear from a couple of astronomers. Dr. Beckwith.

Dr. BECKWITH. It is—I think, in looking at the costs, you have to figure out exactly how this would be paid by NASA, rather than looking at just a lump sum. We know from four servicing missions what the cost to the science budget of a servicing mission has been. It has been between \$300 and \$400 million. It is very easy to calculate, because we know what the burn rate is at Goddard, and we know what the burn rate is at the Institute, and we know the time it takes to do the mission. That number is very well known. In the past, NASA has charged science of order \$100 million to fly a Shuttle mission to Hubble. I believe the premise was that the Shuttle budget was funded at some level of order \$4 billion a year to provide for all the infrastructure it takes to fly the Shuttle. If you flew the Shuttle to the station, or if you flew the Shuttle to Hubble, they were still going to pay for those Shuttle flights. That—therefore, they did not charge those costs to science. If, now, the idea is that we will still spend \$4 billion a year on the Shuttle budget, and charge an additional billion dollars for a Space Shuttle flight to Hubble from the science budget, then I am not quite sure how I would come down. But that has never been the case in the past. It seems to me if the science budget is charged \$300 or \$400 million for the cost of a Shuttle servicing mission, it is well worth the cost. If the science budget is charged \$1 to \$2 billion for the cost of any of the options ahead of us, then I think you would have to go back to the community and ask for a reprioritization.

Chairman BOEHLERT. Yeah, well, that is what we are trying to, because, as Dr. Taylor has speculated, that appears to be the direction they are going, on the charges.

Dr. TAYLOR. But let me say, if I may, that I think Steve Beckwith and I are in full agreement on that point, and that the method of cost accounting has shifted here over five years or so, by a large amount, which does change the ballgame somewhat, and I

think we have—are fully in agreement that at the \$300 or \$400 million level, we would surely go right ahead and do the servicing. At \$1 or \$1.5 or a \$2 billion level, it is not at all so clear.

Dr. LANZEROTTI. But why charge a Shuttle servicing mission a billion dollars when you don't charge a billion dollars for every mission to the Space Station? There is going to be 25 or 30 Shuttle flights to the space station. If you charge a billion dollars for each one of those, it's \$30 billion. That is almost more than half of the NASA projected budget over the next five years. That—there is some accounting here that doesn't compute properly, if you look at it that way. So, I think that there is a real serious accounting issue, and it is not that the Space—you are not going to be charging the Space Station \$30 billion just for a Shuttle launch, because, as I said, it is more than half of the NASA budget over the next five years. So, why charge a servicing mission a billion, if you are not going to do the same cost accounting for the Space Station?

Chairman BOEHLERT. Dr. Norman, you—

Dr. NORMAN. Yes.

Chairman BOEHLERT.—have some words of wisdom to share with us?

Dr. NORMAN. Perhaps not wisdom, but I will share the words.

I would like to talk about this in the context of the programmatic of NASA, and as you know, there have been several roadmapping activities at the moment, and in the context of the astronomical roadmap, that we are all considering at the moment, our goal with the free-flyer with HOP, is essentially to first repair the bridge in the road that was broken by the *Columbia* tragedy, and then we wish to drive over that bridge with our new free-flyer, and explore the current territory that is planned on the current roadmap for Hubble science. This was laid out and expected in the Academy report, and is expected by everybody associated with the roadmapping activities.

However, subsequently, we have the advantage, because of the astonishing very wide field imager, that we have on HOP, of using our newly enhanced turbocharged car, and driving significantly further onwards in the landscape, to explore and map quite new and interesting territories. Another way to look at this is that we are trying to complete the Hubble science program with this mission, but do much more. I think many of you know that under considerations at NASA right now, there is an Origins Probe line and a Beyond Einstein Probe line. These two have been merged in the new Administration, and we can call them the Universe Probe line. Where the Hubble Origins Probe, the free-flyer, would sit quite naturally, both in terms of financial, fiscal funding and programmatic, is that you would see it completing the Hubble science, but also, being first of this Universe Probe line. It would start a great series of discovery type missions, and it would complete the Hubble science. It would concentrate on these great issues that we all, I think, are interested in: dark matter, dark energy, the origin of planets, and the associated question of the origin of life. This is the programmatic view.

Dr. COOPER. Well, Mr. Chairman, I was going to ask for a moment's indulgence on this budget question also, if I might.

Chairman BOEHLERT. Dr. Cooper, the Chair has a habit of indulging expert witnesses.

Dr. COOPER. Okay. So, I would certainly say that this is not wisdom, either, along with my colleague, Dr. Norman. However, there is a straightforward view of the budget question at the moment, which is NASA's plan, originally, which was—strikes me as right-headed, was to split the cost of the robotic servicing mission 50-50 between science and exploration. So already, you, what, reduce the tradeoffs for science, if you actually have that scheme go forward. Second fact, and it doesn't get talked about that much, more or less, we have to do the de-orbit mission, and the de-orbit mission is, say, half a billion dollars. And you know, you can look at a scheme in which science, the science half pays for the de-orbit mission, and the incremental difference, which is maybe half a billion, is paid for by exploration. By this funny math, you end up that science gets the servicing mission for free. So, it is a thought to debate.

Chairman BOEHLERT. Creative accounting. When you referred earlier to your disappointment that the Committee didn't visit with you, I assumed you were talking about the Academy Committee and not this Committee.

Dr. COOPER. Correct. Well, I would love to have either, and in fact, we were relatively aggressively inviting the Academy Committee, which we regret that they didn't come up, but you know, it is a magnificent thing to understand the reality of what can be done, and how it looks in real life. I don't know if the video captured it, so please do come.

Chairman BOEHLERT. Let me thank all of the witnesses for their—

Dr. LANZEROTTI. I should make a comment. We were very concerned at that time. We visited Goddard several times, as I indicated, our subcommittee. And we were very concerned about the fact that at the time that the invitations came to us by email, largely, at least to my attention, there was a procurement going on, and we were very sensitive to that issue. And so we did not go to Canada for that purpose. It was in the summertime, and it would have been nice to go to Canada in the summer, but we thought ethically, it would be better not. But we did visit Goddard a number of times.

Chairman BOEHLERT. Thank you very much. Mr. Cooper. Mr. Gordon.

THE COST OF A SHUTTLE SERVICING MISSION

Mr. GORDON. Thank you, Mr. Chairman. Listening to the very interesting dialogue between Dr. Beckwith and Dr. Lanzerotti reminds of that famous phrase we heard a few years ago, fuzzy math. So, I think we need to keep that in mind. And let me bring people back to something I said earlier today. I want to just remind you. When I asked NASA Administrator O'Keefe to answer for the record whether the Shuttle-related costs of the Hubble servicing mission would come out of the science budget, his response was as follows, and I quote: "This long-planned servicing mission is considered grandfathered in. Under this policy, and the projected budget for the mission was included in the five year budget run-out under

of the Office of Space Flight.” Just to put this back in perspective. Now—

Mr. PULLIAM. Thank you very much, Mr. Gordon.

Mr. GORDON. I know this is a little bit complicated, but I—and so I hate to say, you know, I don’t want to cut you back, but Mr. Pulliam, if you could just be crisp in some questions here. In your testimony, you stated that the cost of the Shuttle servicing mission is, and I—in quotations, in the same range as the rehost and the robotic servicing alternative. However, would it be accurate to say that the Aerospace did not derive a cost for the Shuttle servicing mission, but instead, simply accepted a cost estimate provided by NASA?

Mr. PULLIAM. Mr. Gordon, that is exactly correct. NASA gave us a \$1.9 billion number, and the time for the Shuttle mission, to which we added \$300 million for a de-orbit mission for a comparison across all options, and we did not analyze that option, nor the conditions that led to that number.

Mr. GORDON. Thank you. And is it also accurate to say that Aerospace did not independently validate the cost estimate provided by NASA?

Mr. PULLIAM. That is correct, sir.

Mr. GORDON. Okay. I am not criticizing you.

Mr. PULLIAM. Yes, sir.

Mr. GORDON. This was not your—

Mr. PULLIAM. Yes, sir.

Mr. GORDON.—your charge. I just—

Mr. PULLIAM. That is right. It is their contract—

Mr. GORDON.—want to—

Mr. PULLIAM.—and their task, and they asked us not to do that.

Mr. GORDON. And are you aware that the Government Accountability Office later examined the NASA cost estimate for a Shuttle servicing mission, and it found that, and I quote: “NASA could not provide documented support for key portions of the estimate?”

Mr. PULLIAM. No, sir. I am not aware of that.

Mr. GORDON. Well, just if you wanted to be more aware of it, the source is GAO Report 05-04, page 2. And Mr. Lanzerotti, your committee expressed the belief that, and here, again, I quote: “Careful planning for and implementation of additional HST unique activities to meet CAIB and NASA requirements will result in substantially lower actual costs to service HST, using the Shuttle, than those projected above. Lower than—i.e., lower than the cost estimates provided by NASA. Would you like to elaborate on that?”

Dr. LANZEROTTI. I would like to call on General Bolden to make some comments related to that, but as an introduction, let me say that our experience with NASA costs on the Shuttle were very similar to what has just been related here—I didn’t know this before now—but by Mr. Pulliam, in terms of the NASA estimates and all. But we had experts on our committee, in terms of the—of experience with space flight. Mr. Rothenberg is one of those, having managed at NASA headquarters, but General Bolden, and some other colleagues on the Committee were experts at Shuttle and Shuttle costs. And General Bolden, would you—this is General Charles Bolden, who is a member of our committee.

General BOLDEN. Thank you very much, Mr. Gordon. First of all, the points that we looked at were the fact that there are a number of things that were required to comply with the *Columbia* Accident Investigation Board, as well as the additional requirements that NASA put on themselves. Our finding was essentially that there is basically little, if any, difference between the requirements for a Hubble mission and an International Space Station mission, so the differential cost, if you will, is minimal. And I think my colleagues have said maybe \$50 million for a Shuttle flight, of a differential cost, because inspection and repair, micrometeoroid analysis and protection from that, those things have to be done whether you are flying to the International Space Station, or whether you are doing an independent Hubble Space Telescope mission. So there is little difference.

Mr. GORDON. Thank you. I guess my concern is this. The NASA Administrator had publicly stated that he was opposed to flying a Shuttle servicing mission, yet we have nothing that has been— independent validation of the cost, and I think we really have two questions here. One is, what really is the cost, and secondly, how should it be allocated? And we just don't have that good answer yet. Dr. Lanzerotti, let me ask you once again. Your—this committee was called upon by Administrator O'Keefe to do this study. Is that correct?

Dr. LANZEROTTI. Yes, that is correct, at the urging of Congress.

Mr. GORDON. Have you reported back to NASA?

Dr. LANZEROTTI. Yes, we have. We—

Mr. GORDON. Have they responded to you?

Dr. LANZEROTTI. They have not responded formally to us as of this date.

Mr. GORDON. Okay. But you have given them a full response.

Dr. LANZEROTTI. We gave them—we briefed several Congressional committees, including some of the staff that I see up there. We—and then we spent an hour and a half with NASA briefing our report to the Administrator and his top staff. In December, December 8, I believe it was. Approximately December 8. We have not received any formal responses back from them, as of this date.

Mr. GORDON. Well, that will be an interesting response. Again, I want to thank all of you who have helped inform us. You have done a good job with your background. Okay, I will—but I think we—there are some questions that you can't answer that need to be answered before we can move forward. Dr. Taylor?

Dr. TAYLOR. Mr. Gordon, I just wanted to ask for a clarification to be sure I am understanding correctly. But are you saying that Mr. O'Keefe's statement to you means that a Hubble servicing mission would not, definitely not be charged to the Science Directorate? Because if so, much of the things that I was talking about in my statement, and fearing might be the case, are moot.

Mr. GORDON. That is correct, except for the science-related costs. Again, let me—but all I can do is quote to you what he said—

Dr. TAYLOR. Right.

Mr. GORDON.—which I will do once again.

Dr. TAYLOR. Well, you did it twice very effectively, and I am sure I heard what you said, and it was—

Mr. GORDON. Wish everybody else did.

Dr. TAYLOR. It was——

Mr. GORDON. Thank you so much.

Dr. LANZEROTTI. Do you have readily at hand, or perhaps Dr. Obermann has at hand, a date when that was?

Mr. GORDON. Yes, sir. It was February the 27th, 2002, at a hearing here with NASA, and it was on page 166.

Dr. LANZEROTTI. Thank you very much.

Mr. GORDON. Thank you. And again, thank all of you. This is a—it is an important question, and clearly, money is a part of the question, science is a part of the question, and we are hopefully going to get closer to bringing all that together.

Chairman BOEHLERT. Thank you very much, Mr. Gordon. And it is a very important question, and it is one that has to be asked and answered to our satisfaction, and the reference you made to the quote was back in '02, when they were beginning to—changing the process of their accountings, and how they were going to go forward, and so we are going to have NASA up here on the 17th, and we are going to ask specifically that question, and we are going to demand a very specific answer. So, Dr. Taylor, you and I and everyone else will be enlightened. Mr. Reichert.

THE REHOSTING OPTION

Mr. REICHERT. Thank you, Mr. Chair. I appreciate the opportunity to be involved in this process as a new Member of Congress. It has certainly been an interesting discussion.

Dr. Lanzerotti, you state that you have strong reservations regarding a plan to rehost the Hubble cameras on a new telescope, but Dr. Norman seems to make a solid argument for rehosting. Dr. Lanzerotti, can you expand on the specific concerns that you have with Dr. Norman's rehosting concept, and Dr. Norman, do you have any comments?

Dr. LANZEROTTI. Let me say first that the concept that Dr. Norman, Professor Norman presented here this morning were not ones that we completely evaluated. When he briefed the Committee, I don't recall that he had the new Japanese telescope at that time. Am I mistaken on that, or not?

Dr. NORMAN. Unfortunately, you are.

Dr. LANZEROTTI. I am mistaken?

Dr. NORMAN. You are.

Dr. LANZEROTTI. Okay. So I am mistaken. He must have had the Japanese telescope on there, but the—there is no question in the Committee's mind that there would be a very large, a significant science gap between the demise of the Hubble and the rehosted instrument. We were asked to look at the overall Hubble question, to not address Hubble prior to its demise, and the possible going into an unstable, let alone not useful state, would not be wise for the Nation at all. If the decision is made not to do anything with Hubble, we are going to have to address Hubble for de-orbit. We just can't leave it up there floating around without addressing the de-orbit.

A robotic vehicle has to attach itself to Hubble at some point to de-orbit it. Hubble has to be in a stable state. It has to be in a state such that the gyros and the batteries make it, and particularly, the battery lifetimes, make it such that Hubble has to be accessed. And

so, we—for one of the—for that reason, for one of—that is the one of the reasons why we felt that just concentrating on rehosting, and the science was not addressing the total Hubble issue, the de-orbit issue. We said, as I stated in my oral testimony here, and I have in my written testimony, that the Shuttle servicing of Hubble could emplace fiducials, could emplace grapples on the telescope, such that an ultimate de-orbit module would be much easier to attach to Hubble to do a controlled reentry into the atmosphere.

A—there is no question that a rehosted Hubble or a new Hubble going to a different location other than low-Earth orbit would allow one to have more science return, because you wouldn't have the eclipses every orbit—every 90 minutes that you see around Earth, for example. That is one of the positives. But the Committee was concerned, as I indicated in my testimony, was concerned that—excuse me—excuse me—I don't want to contradict myself here—that rehosting would involve, really, a significant cost savings over a Shuttle repair mission, and the—we just had this little dialogue here on fuzzy accounting, so to speak, and we were—and we certainly saw the big gap in the science. There would be no overlap with the Chandra and the infrared telescope Spitzer, with a rehosted spacecraft. And so this program that has been proposed by Professor Norman has never really been evaluated by this priority-setting decadal process, and that is why I said personally, I would recommend the tradeoffs involving a rehosting mission should be reviewed by the astronomy community in the context of its Decadal Survey activities.

Mr. REICHERT. Dr. Norman.

Dr. NORMAN. Yes, thank you very much, Mr. Reichert.

Firstly, I would endorse an Academy review of the HOP project. I believe we would stand tall and strong against any such review. And we would like to be as soon as possible, so we can get going.

The main issue, I think, here is the famous so-called gap between the demise of Hubble and the beginning of the HOP mission. Currently, we envisage a 65 month schedule from authority to proceed to launch. That puts us—that puts HOP into orbit and functioning at the end of 2010. So, the gap would be two or three years, as was mentioned by Mr. Pulliam in the Aerospace report. Okay. The analogy I would like to draw for you is that—imagine that you are in a car, driving at 55 miles an hour, heading from Washington to California. Okay. This is Hubble. Okay. So, you are driving along. If you go 17 times faster—this is the wide field imager capability above ACS—then you are going at something like 1,000 miles an hour. It is the difference between flying and driving. So that even if there is a short gap of two or three years, because of the factor of 17, we will complete the science that would have been done by Hubble in that intervening two or three years, by two or three years divided by 17. This is two months. So, in the first two months, we would overcome that.

The second point about the gap is it may in fact be useful. Many of us who have used Hubble for the last 15 years have much data that needs thinking about, reducing, thinking about, and even writing those papers that are littering our desk. A gap of, say—let us say this could take one year or so—when the enormous data stream from the very wide field imager comes down, from the quar-

ter of a billion pixels, which will be orbiting in space, we need to be ready. It would be reasonable to have some time to prepare for this. So, we have thought about this greatly on our team, and the response to this particular question, from Mr. Reichert, about the gap. And we think it would be very reasonable to have a two or three year gap. I think if there is a gap of five years, for example, if we don't get the funding that we need in the time that we need it, if there is a gap of five years, the risk is that we may lose the interest of some of the brightest young astronomers, the astonishing talent of young astronomers, that is working on Hubble today. And that is the argument, I think, for having the political will, the energy, and the determination to get this—if we decide to do the free-flyer, there are other options, of course. But we need the political will, the energy, and the determination to hold our feet to the fire, and NASA's feet to the fire, get this done in 65 months, and get on with it.

Thank you.

Chairman BOEHLERT. Thank you very much, Dr. Norman. Thank you, Mr. Reichert. Mr. Lipinski.

THE MANIFESTING OF A SHUTTLE SERVICING MISSION

Mr. LIPINSKI. I would like to thank the Chairman for holding this hearing. It is a very interesting hearing to begin my Congressional career, and I look forward to working with you and Mr. Gordon and all of the Committee members as we go forward during the—during this Congress. Now, it has been especially interesting hearing today, 17 years ago, I was a young, aspiring mechanical engineer, and unfortunately, my hopes were dashed by The Aerospace Corporation when they rejected my job application. But—

Mr. PULLIAM. Oh, no.

Mr. LIPINSKI. But I think I have done okay since that point. So, I won't grill Mr. Pulliam about that. What I wanted to ask about—

Mr. PULLIAM. We are hiring, sir.

Mr. LIPINSKI. It is a little too late. I wanted to ask Dr. Lanzerotti about the availability of the Space Shuttle. NASA told Aerospace that it would be 31 months after authority to proceed that the Shuttle could be used to service Hubble. Your committee's report states that after discussions with NASA, you determined that a Hubble servicing mission should be flown "as early as the seventh flight after return-to-flight without an impact on the International Space Station." So, how did you arrive at that conclusion?

Dr. LANZEROTTI. Yes. Thank you very much, Mr. Lipinski. I am pleased to answer that. I will make an introductory comment, then I would like to call upon General Bolden. I would like to make the introductory comment by saying that our committee used NASA information, by multiple visits to the Johnson Space Flight Center, but also made its own assessment by the credibility and the experience of the members of our committee, who have been involved in NASA space flight activities, both managing at Johnson, managing at a headquarters, and flying in the Shuttle, both deploying Hubble and repairing Hubble. And the knowledge base that they have on the experience of the Space Station, manufacturing and deployment and development.

And with that, I would like to call upon General Bolden, who can expand more on how the Committee arrived at some of that.

General BOLDEN. Let me try to cover two things, sir, very quickly. First of all, the—our estimate was approximately 18 months to fly from the moment that the Administrator or somebody says okay, let us go ahead and go SM4, fly a Shuttle mission. That is primarily because the mission is, we say, in the can. It is already—the design of the mission is already complete. Some training was in progress. It would be a matter of naming a crew, and from the time the crew is named until the time they are ready to fly is historically about a year, about 12 months. So, that is where we came up with the 18 months.

Why the seventh flight? If you think about balance, the International Space Station needs to get to a point where it is aerodynamically and logistically balanced, and when we talk to the NASA people, the International Space Station program offices, at the point of mission number—the sixth flight to it, then it essentially is a balanced system that can take care of itself. It can be interrupted. It will survive everything else. So, that is why we said as early as the seventh mission. Ideally, you would like to fly the first flight out of the chute to Hubble, and you alleviate a lot of the concerns that we have about delays with batteries and gyros and the other kinds of things. But that was not the decision. So, the seventh flight gives us—gives the International Space Station program an opportunity to get the International Space Station in a balanced situation, or a stable situation, such that it is a nice time to take a break.

Mr. LIPINSKI. Does it matter if the first Space Shuttle flight falls—gets pushed back further?

General BOLDEN. It makes a difference if the first Space Shuttle flight gets pushed back, because now, you have to ask yourself, when does the—if we are going to say the seventh flight is the right place, when does that seventh flight fall? If the seventh flight falls in 2009, 2010, the question that we were challenged to answer is already moot, because our—if you remember, our charge was to find—to evaluate options to save the Hubble Space Telescope. So, that is where time is of the essence. If the Shuttle return-to-flight is delayed by a number of years, I think it is a brand new ballgame. We are not even talking about using Shuttle anywhere down the line, other than maybe the first flight, the return-to-flight flight. So, time is of the essence. You talk about the 2007 to 2009 timeframe, when you go beyond that, you know, you may as well start talking about a de-orbit mission, and essentially forget about a lot of the other things we want to do.

Dr. LANZEROTTI. Thank you, Charlie.

Mr. LIPINSKI. Thank you, Mr. Chairman.

REHOSTING CONTINUED

Chairman BOEHLERT. Thank you. Dr. Taylor, I think you wanted to respond to Mr. Reichert's question.

Dr. TAYLOR. If it is all right, I would like to put in one more word to—in response to Mr. Reichert's question. I appreciated hearing again what Professor Norman had to say. You probably know that one of the ways that we scientists make progress is we push and

shove at each other, we argue, we find the weaknesses in one another's arguments whenever we can, and then, in the end, nature makes up her mind about what is really the case, and we try to agree on it.

I think what needs to be clear to you, Mr. Reichert, is that Hubble light, the HOP project, does not—it does some things extraordinarily well, it does them faster. But it does not do everything that the present Hubble telescope does. It doesn't point as well. It—there are many other things which Hubble does that—which HOP cannot do. And I think the—my evaluation of the loss of science created by the gap of three years or whatever it would be, between something like 2007 and the end of 2010, is rather more significant than Dr. Norman suggested.

Chairman BOEHLERT. And Dr. Beckwith, I think you wanted to comment.

Dr. BECKWITH. Well, since we are into analogies here involving automobiles on the highway, I think HOP does not replace Hubble's capabilities. It has some things, as Dr. Taylor said, which are a little better, but the analogy I would like is you are driving down the highway at 50 miles an hour in a car, and you have the option of going 1,000 miles an hour in a motorcycle. Now, if you alone need to get somewhere fast, that is a very useful option. But if you want to transport your family from Baltimore to Washington, say, in a snowstorm, it may be that that speed is less important than the carrying capacity and the ability to stay out of the snow. So, Hubble has been enormously successful, because it is a general purpose observatory which is able to react to discoveries that we don't have the imagination to predict even a few years ahead of time. And time and again, Hubble has shown that it is built with the right set of characteristics to probe the cosmos in ways that, you know, theorists just aren't predicting. So, it is useful to note that in the suite of programs that NASA has, it has a mix of programs. It has some very small, specialized programs. It has medium-sized programs which are targeted at particular questions. The WMAP program for cosmology, the COBE program, some of these other programs. And it has general purpose observatories. The general purpose observatories have been the most productive of all of NASA's programs by a long, long shot, and so you have to think very carefully when you are making substitutions between that capability and a capability which is a little lighter, a little more specialized, and in this case, would be delivered many years later.

Chairman BOEHLERT. Dr. Beckwith, as an aside, can I ask, in the examples you cited, and the one that Dr. Norman cited, what assumptions are you using with respect to Congress' reaction to my call for increased CAFE standards?

Dr. BECKWITH. I am sorry, but that is not something I am an expert on.

Chairman BOEHLERT. Thank you. Mr. Udall.

RISK AND A SHUTTLE SERVICING MISSION

Mr. UDALL. Thank you, Mr. Chairman. I, too, want to acknowledge the great work that each one of you on the panel has done to think creatively about where we could proceed with this magnifi-

cent instrument that we call Hubble. I want to also thank the Chairman and the Ranking Member for the acknowledgment they directed to me earlier in the hearing in regards to the resolution that we introduced last year in the Congress that resulted, Dr. Lanzerotti, in your panel going to work and coming up with your important recommendations.

It strikes me that the tone of this hearing is that it is not if we are going to save Hubble, but it is how and when, and I hope that, in the long run, is what occurs. Mr. Chairman, it also seems worth noting that I don't know if we have ever held a hearing where we talk about saving a satellite, saving an instrument. Most, if not all, of the satellites are allowed to, or directed to fall into orbit in some way or another, and I think that, in its own way, speaks volumes about the importance of this instrument, and the great brainpower that has been applied to not only putting it into orbit in the first place, but maintaining its life cycle as long as possible.

We have focused on budget concerns and cost accounting and trying to get to the heart of that, I think, it is true there are still some important questions that have to be answered. We have looked at the robotics piece in this hearing, and Dr. Cooper, your efforts have not gone unnoticed, and I would like to associate myself with Mr. Calvert. I am on the Armed Services Committee as well, and regardless of what happens with your mission here, I think there is some very important applications in the long run for what you are doing.

I would like to turn to the safety arena, and direct a couple of questions at Dr. Lanzerotti. In the concerns cited by Administrator O'Keefe for canceling the servicing mission was crew risk, and I think your committee, Dr. Lanzerotti, took that issue head on, and you stated that the Shuttle crew safety risks of a single mission to the Space Station and a single Hubble servicing mission are similar, and the relative risks are extremely small. This is an important finding. Can you elaborate on why your committee believes that to be true?

Dr. LANZEROTTI. Thank you, Mr. Udall. Yes, I will. I would like to call upon General Bolden to give the more definitive technical answers. I would like to say that the Committee took this part of its responsibility very seriously. Human life is at risk. But flight—human flight in space is a very risky endeavor, and so, we took this very seriously. And we understand if the Nation goes into the direction of exploration beyond low Earth orbit, it is also going to be a very risky enterprise. We also recognized that the American public has to understand the risk issues related to humans flying in space. And so, we called upon the expertise of our members of our committee who have flown in space, who have managed the space human flights program, and we have also visited the Johnson Space Flight Center several times by a subcommittee to gather the information that we did.

And I would like to have—if I might ask General Bolden to elaborate on the findings of our committee in that regard.

General BOLDEN. Mr. Udall, thank you very much.

As I mentioned before, our charge was to look at options to assess, to save the Hubble Space Telescope, and we were asked to look at the relative risks between, primarily between robotic,

human missions. There are two risks that we concerned ourselves with. One is the risk to humans. So, the robotic mission wins out, unquestionably, hands down, because there are no humans involved. The other risk is one to the Hubble Space Telescope. And our finding there was that because of experience and past performance, by a small margin, a human mission, a Shuttle mission to Hubble, we recommended as winning out. The ancillary point that we were asked to look at was the comparative risk between the International Space Station mission and Shuttle to the Hubble Space Telescope. The risks are encountered during ascent, on orbit, primarily from micrometeorite, micrometeoroid damage, and then during entry.

For all intents and purposes, the risk to a crew, whether you are going to the Hubble Space Telescope orbit, or whether you are going to the International Space Station, are the same during ascent. The primary difference becomes one of risk to the crew on orbit. In the International Space Station orbit, which is lower than Hubble, the—it is denser, in terms of the amount of debris, so there is some increased risk to a crew in a Shuttle in the orientation that we dock with the International Space Station. There is less risk from micrometeoroid damage, because we can choose our orientation to put the orbiter in a safer orientation, in terms of micrometeoroid debris.

So, that leaves one other thing to be considered, and that is what we call a safe haven. NASA advertises that the International Space Station can provide approximately a 90 day safe haven for a crew in the event that we find that there is some damage. Let me add one thing. First, you have to find out that there is damage to the vehicle. If it is determined that that damage occurs before getting to the International Space Station, or as happened on STS-51-F, in 1985, you don't make it to your desired orbit, the advantage goes away with the International Space Station, because the crew can't get there. They may have been trying to get there, but they don't get there physically. That is a fact of life, and that has happened to us on a previous Shuttle mission. So there, you lose the advantage of the safe haven from the International Space Station. The question of 90 days is one that we can argue the point. Right now, I don't think, and our determination was that the International Space Station, as presently configured, and as presently—its reliability at present, because of its environmental control system, we don't think it can accommodate a crew of seven or more for 90 days. The Shuttle itself, if you determine early enough in the flight that it has problems, you can do a power down, something that we have practiced all the time, and you can get up to—maybe—you can probably squeeze out 30, maybe 45 days on orbit, while you mount a rescue mission or whatever it is. So, the relative risk between a mission to the International Space Station and a single mission to service the Hubble Space Telescope is minimal, at best. That was our assessment. If that is the case, then it says, you know, there is no human safety concern more from a Hubble Space Telescope mission than there is from an individual International Space Station mission. And if you look at 25 or 30 International Space Station missions, then it goes out the window, astronomically more risky to complete the International Space Station.

Mr. UDALL. General, thank you, and you anticipated my follow-on question about safe havens, and the relative risks between a Hubble mission and, actually, the station itself, and I also want to thank you, because the Chairman is a lot more willing to let expert witnesses go on, particularly those who have served our country with distinction, then mere members of the Committee. So, thank you for providing with me with additional minutes on a very important question. So, thank you. Mr. Chairman.

Chairman BOEHLERT. Before turning to Mr. McCaul. General, I would like you to clarify for the record, you said by a very small margin, that was the exact phrase you used, you opted for having astronauts do the repair rather than robotics. Can you amplify that?

General BOLDEN. I—my reference to a very small margin was in terms of risk to the crew and vehicle. And that risk is small, because the single advantage that I think, and most of my colleagues think, a mission to the International Space Station provides is the presence, the ready presence of a safe heaven. If you are damaged on ascent, and you go to the International Space Station, the crew still has to get outside, inspect, determine exactly where the damage is. They have to have a way to either repair it—if they can't repair it, which is a very good probability, even going into the return-to-flight, then you have got to get another Shuttle up to rescue the crew. If you go to the Hubble altitude of almost 400 miles, and you determine that you have a problem, you utilize the same tactics, techniques, and procedures for inspection that we do when we get to the International Space Station. And in determining where we need to go and make the repairs. If you can't repair it at the International Space Station, you can't repair it in the Hubble orbit. So, you know, the risk is minimal, if there is a difference.

And the fact is that after the first few flights—after about the sixth flight or—sixth or seventh flight, when the second—Node 2 is placed on the International Space Station, your ability to inspect and repair at the International Space Station becomes essentially identical to that in the Hubble orbit, because now, you are totally dependent on the orbit—it is the extension of the remote manipulator system arm, the OBSS, you become totally dependent on the OBSS to do the acreage survey, the look throughout the vehicle to determine where the damage is, and that is no different whether you are in a Hubble orbit, or whether you are at the International Space Station.

Chairman BOEHLERT. Thank you. Mr. McCaul.

SHUTTLE SERVICING OPTIONS

Mr. MCCAUL. Thank you, Mr. Chairman. I would like to welcome General Bolden, who is actually a fellow Texan, here today, and he brings a lot of experience, a lot of Shuttle missions, including to the Hubble Space Telescope. I would say real world experience, maybe it is out of this world experience, but I appreciate you being here. I have got a—it is actually sort of a follow-up question to Dr. Lanzerotti and General Bolden. In the effort to save money, we have 25 to 30 Space Shuttle missions budgeted. Is it possible, and I know there is a risk involved, is it possible to have a mission that

could—that is going to the International Space Station, go there and also sort of go in a detour route to the Hubble telescope to fix it? That is my first question.

Dr. LANZEROTTI. I think the problem there is simply one of Shuttle lift capability. Charlie can correct me if I am wrong on these, because he has flown that truck, and I haven't. But the Shuttle will be fully utilized, carrying up two new instruments, as well as all the other equipment that are needed for the refurbishing of the telescope. And so, there would be no extra cargo bay available to go to the station. Also, they are in very different orbits. Very different orbits. The—

Mr. MCCAUL. Thank you.

Dr. LANZEROTTI. And that is also—makes it impossible, essentially impossible, from the point of view of celestial mechanics.

THE HUBBLE SPACE TELESCOPE'S PROJECTED LIFE EXPECTANCY

Mr. MCCAUL. Okay. I think that answers that. My second question is to Dr. Norman, and it is my understanding that either way, if we fix the telescope, that it will still go out in the year 2013. Is that a correct assumption, or is that not?

Dr. NORMAN. Mr. McCaul, if you could clarify that a little bit.

Mr. MCCAUL. Well, if we send either robotic or the Shuttle to repair the Hubble telescope—maybe I should ask it another way. How long would that keep the Hubble telescope alive and well?

Dr. NORMAN. It is a good question. I am not actually technically qualified to answer that, but the time between servicing missions is the order of three to five years, so that we may well have to go there again if we wish to keep it alive. So, that would be if we get there in 2008 this time, and I think you are right, the outer limit would be 2013. Yes.

COST OF REHOSTING

Mr. MCCAUL. Right. And so, we are looking at, I have heard estimates from \$500 million to a billion dollars to fix it, and I—my next question is how much would it cost to just send a Hubble telescope with modern technology that we have today, up into space, with the possibility of not having to repair it every three to five years?

Dr. NORMAN. Right. The—it costs a billion dollars to do the famous HOP project. We are not intending to make that robotically serviceable at the moment, although we may do this later, if we go into detail design phase. But—so, the nominal lifetime of this new, state of the art technology telescope will be five years, and therefore, it will go from 2010 to 2015. In the meantime, of course, JWST will come online, and other major facilities. But it will do great work in that five years. If the nominal lifetime is five years, one might expect that it would last significantly longer, based on other NASA missions. And of course, if one went into the robotics issue, and said that robotics would, in fact, be ready by 2015, then that could be the first robotic servicing mission.

Mr. MCCAUL. Okay. Thank you. Thank you, Mr. Chairman.

Chairman BOEHLERT. Mr. Melancon. You are up. Mr. Matheson.

THE HUBBLE SPACE TELESCOPE AND DARK ENERGY

Mr. MATHESON. Thank you, Mr. Chairman. First, I have a question for Dr. Beckwith. I am interested in your thoughts about this—developing greater understanding of dark energy, and the role that you foresee Hubble being able to undertake in the future, based on decisions that are made on what we do with Hubble. If it is refurbished, how do you see how it could play a role in developing greater understanding for us about dark energy?

Dr. BECKWITH. Well, right now, there are two basic possibilities for dark energy. One is that is what Einstein envisioned in his general relativity equations. It is what is called a cosmological constant. It is a property of the fabric of space-time. And the other possibility is it is something else that we don't know about. Now, if it is Einstein's—if it is according to Einstein's theory, it is a constant. It is ever—it is not changing. And the easiest way to verify that or not is to look back very far in time and compare what the universe was doing a long time ago with what it is doing now. And Hubble is unique for doing that. That is, at very early times, only Hubble can actually detect and measure the supernovae needed to make those measurements.

So, as we speak, Hubble is making progress on this problem. It will make a great deal of progress in three years, and with an upgraded instrument, with the Wide Field Camera 3, its rate will also accelerate by a big factor over what it does today, and so, it is entirely possible that with Hubble, you could rule out one of those possibilities in the next five years or so. Now, of course, we don't know, but that is really, I would say, the hope with Hubble, that we will know if it was Einstein or something weird. Now, if it is something weird, of course, we don't really know. I mean, Hubble will contribute, but obviously, you would have to sit back—sit down and design a very specialized mission for it.

I think it would be useful, of course, if the Committee could establish a dark energy policy, so that we really understood, you know, what the Nation wanted to do on this problem. But in fact, I think that is going to be part of the science community's next Decadal Survey.

Mr. MATHESON. Would this be an example, you mentioned earlier that we are dealing with circumstances where things are unimaginable. Is this an example of those things? When Hubble was launched, did we have a sense that this was going to be a field that would be evaluated?

Dr. BECKWITH. No. There was no significant active research into this particular problem. The breakthrough came in 1997, 1998, two different groups verified this within a year, actually, within six months of the time it was announced, Hubble began doing this. Hubble has now taken over an entire subfield of this research, and it is completely unique for looking back into the distant time to see—early universe to see how much this has changed. This is one of—I can come up with three very prominent examples that everybody could understand that didn't even become topics of research until Hubble was up there working. And in one case, it was Hubble that generated the entire topic. So, that is the power of Hubble.

AEROSPACE CORPORATION ANALYSIS ASSUMPTIONS VERSUS
REALITY REGARDING A ROBOTIC SERVICING MISSION

Mr. MATHESON. I have one other line of questioning I wanted to ask, and in my limited time, this may be—limited on what you can answer as well, as a group, but general question based on The Aerospace Corporation report. As I understand it, both the Shuttle and robotic service mission have comparable life cycle costs, with the data that you were given. The Shuttle's development time is about two and a half years. Has—will it proceed as a medium development risk and mission risk. The development time for the robotic is 5.4 years, and is—has what would be characterized as a higher development and mission risk. Now, I realize the report did not take into account the specific robotics work already under way in the summer of 2004, but—and there are recent reports not known at the time of the report—recent developments not known at the time the report was composed, that suggest the robotic mission risk and time was actually lower than was asserted before. And you may have covered this. I apologize. I was late getting into this hearing, so this may have been covered before I got here. If that is true that they are actually lower than have been asserted, how much risk reduction have we seen, and how much time has been gained on the robotic option? That would be the question I would throw out. I don't know who wants to answer that.

Mr. PULLIAM. Mr. Matheson, I would just start out—

Mr. MATHESON. Sure.

Mr. PULLIAM.—with a reiteration of what we did. The—as I have said before, ours—as you said, ours was an analytical capability assessment, and not a programmatic assessment. But you know, the statement was made earlier that the Aerospace database was fraught with clean sheet of paper exercises, and that this particular development is not a clean sheet of paper.

Mr. MATHESON. Right.

Mr. PULLIAM. I would say that, as I said to the Committee at my opening remarks, our analyses come from the analysis of how things come out, not how they began. So, whatever heritage is in whatever program gets built in to the numbers we use. So, I would say that the only way that the Congress would know that, or even others might know that, is to look specifically at that program. But we would be the first to congratulate anyone who comes in below cost and ahead of schedule.

Mr. MATHESON. Sure.

Mr. PULLIAM. But I think program assessments are the way one would find that out.

Mr. MATHESON. Dr. Cooper.

Dr. COOPER. Thank you for the opportunity to respond, Congressman. First, a comment. You made the comment that The Aerospace Corporation asserted comparable costs for the missions. Even assuming that is true, I want to point out that the value outside the Hubble mission is not comparable. That is, there is basically nothing to be learned by sending astronauts to repair the Hubble. However, if we do the robotic mission, we are doing a lot for the space program outside saving the Hubble. So, the costs may be comparable, but the value is hugely different, which changes the value

equation totally. And the second part of your question was basically how much risk has been reduced since the initial appraisal of the—that one, the best way I can characterize that is how the process occurs, and the process occurs by—one of the great values of the NAS report is it, as you would expect, highlighted a number of areas of risk. And as we understand what the risk areas are, we work relentlessly to eliminate them one by one. And a number of them, we have basically disposed of at this point. For example, originally, there was a great deal of concern about the time delayed control of robotic systems in orbit, when the astronauts driving them on the ground. I think it is fair to say on the basis of—for example, NASA recently actually issued a safety approval, after a long scrutiny, of doing this for—controlling the space station robot, that we pretty much know that one cold. Another one that I referred to earlier, there is a, you know, there is a big—there is a lot of specific motor tasks that have to be achieved to service the telescope, upgrade it. That one, we have also gone a long way towards retiring the risk on that one.

There is another class of risks which are harder to address, which are we haven't flown autonomous rendezvous. We haven't flown autonomous capture, and the thing I would tell you about that is the rest of the space community understands that those risks are very important for a lot of reasons, DOD reasons among them, and there is a whole sequence of space flights planned that are going to essentially relentlessly eliminate those risks one by one. And the net of this is, at the moment, our view is, by the time we come to launch this thing, there is nothing left for us to do but actually go up there and do the mission, because everything we could possibly think of will have been covered by that point.

Dr. LANZEROTTI. Mr. Matheson, our committee was concerned that some of these missions that may do these kinds of things for autonomous rendezvous would be long after the necessity for servicing Hubble.

Mr. MATHESON. Okay.

Dr. LANZEROTTI. And so we were concerned that you might not be able—one might not be able to service Hubble reliably with an uncooperative target that Hubble presents. You—basically, you have got a huge investment up there that is doing fantastic astronomy, and it could be—it is being used as a target for potential DOD missions or whatever else, as Mr. Cooper said. And our committee was concerned with using Hubble as a—just a target vehicle for doing other things that may be applicable with—downstream.

Mr. MATHESON. I appreciate that. Thank you, Mr. Chairman.

Chairman BOEHLERT. Thank you very much. Mr. Rohrabacher.

VALUE OF A ROBOTIC SERVICING MISSION TO EXPLORATION

Mr. ROHRABACHER. Thank you very much, Mr. Chairman, and I would like to thank Mr. Udall, who may have left the room by now, for inspiring this hearing, and you know, goosing us in the right direction a few months ago. I remember people were not paying the attention to this as we should, and then, Mr. Chairman, your personal leadership, and making sure we have a hearing as high a quality as we have had today, has to be commended. Mr. Cooper, I think the last point you made, and—was something people should

focus on, and that is your analysis of the value of a successful robotics mission, as compared to the value of another mission that would be successful. And I happen to believe that part of what we are doing here is pushing the envelope on humankind's capabilities in space. That is part of what we are doing. We are not just fixing the telescope. We are making sure that humans can do things that they can't do now in outer space, and there is a great deal of value to that, and a great deal of actually getting experience in doing things with robotics, so I buy that. I buy that argument. And I think that when we are analyzing what goes on here, that must be part of our decision making factor, as to how much it is going to be worth to humankind to have developed further skills in the use of robots in space.

Let me note that the situation with the Shuttle and—has not exactly been defined here, and I would like to go into that for a moment. And the Academy report states that if the Shuttle can go up, and that a second Shuttle could be launched if there is a rescue mission that is needed. So, we have got that exit strategy. First of all, is an exit strategy essential for us to be able to use the Shuttle? That is—

Dr. LANZEROTTI. Thank you, Mr. Rohrabacher. With regard to your first comment about the value of—if I might—

Mr. ROHRABACHER. Yes.

Dr. LANZEROTTI.—about the values of humans and robots and interactions in space for exploration. You are absolutely right. It is a value—but it also is a value judgment in terms of whether you want to use Hubble, this facility that is operating, as a target to do that kind of practicing, in case of failure. I mean, one could imagine that one could launch something else up there to do target practice—

Mr. ROHRABACHER. Of course, there are some people, you have to remember, who are arguing just to bring Hubble down right now, and it is not worth doing all the rest of it.

Dr. LANZEROTTI. That is absolutely right. In my—

Mr. ROHRABACHER. So, they—

Dr. LANZEROTTI. In my—

Mr. ROHRABACHER. That is part of the equation.

SAFE HAVEN AND A SHUTTLE SERVICING MISSION

Dr. LANZEROTTI. In my opening testimony, I indicated that indeed—remember, the Committee was agnostic on that to begin with. There are many members that thought that Hubble was not worth saving until they dealt and did the analytical analysis. With regard to your—but I said it is a value judgment, and indeed, that is a judgment that the Congress, in its wisdom, and the American people can decide, if Hubble should be a target for practice like that. With—your second point, however, had to do with the standby Shuttle. I would like to have General Bolden make a couple of comments related to that, but let me point out that NASA's return-to-flight implies a Shuttle on the launch pad for the first two launches in return-to-flight at this point, to the best of my understanding.

Mr. ROHRABACHER. Okay.

Dr. LANZEROTTI. It is not a requirement for us to have a second Shuttle on the launch pad for a Hubble service. We point out that,

since that is the case for the first two flights, and if NASA is concerned about a rescue, then that would not be unreasonable to have for our—for a Hubble mission as well. And General Bolden can relate to you that NASA has had two Space Shuttles on the pad in the past with this kind of timing.

Mr. ROHRABACHER. The question is, is if they are—cannot—is that a prerequisite? If they are—

Dr. LANZEROTTI. No, it is not a prerequisite at all.

Mr. ROHRABACHER. Okay.

Dr. LANZEROTTI. Charlie—may Charlie?

General BOLDEN. Mr. Rohrabacher, it is not a prerequisite, as Dr. Lanzerotti says. However, I think NASA has deemed it prudent, and we don't argue with that point, by what we got from our visits to the Johnson Space Center, the second vehicle on the pad causes up to a 30 day slip in the time that you would start preparation for a—or have another Shuttle ready to back into the International Space Station flow. If I may, I want to respectfully disagree with one of the things you just said, because I think it is important for people not to mix apples and oranges. You mentioned the fact that pushing the envelope—and Dr. Cooper has said that pushing the envelope is an important mission, or an important aspect of this mission. That was not in the mission objectives until today. So—

Mr. ROHRABACHER. Well, I—let me tell you, General, it has been in the—in our agenda since the forming of this Committee, and it may not be—NASA may not recognize it as part of its goals officially, but whatever project we are involved in should assume that, so I don't buy that at all.

General BOLDEN. I understand. The other point to be made, in terms of our report is people generally tend to say that we oppose the robotic mission. We encouraged NASA to continue its development of the robotic capability. In fact, we said that you—that they will need the robotic capability, not only for the Exploration Initiative, but in order to de-orbit the Hubble Space Telescope. So, we think it is critical that they continue down the road of the development of the robotic mission. We all need to understand that that mission, however, has to be successful. And in order to optimize its chances for success, we feel that utilizing a proven Shuttle mission to do the servicing of Hubble, and also, installing fiducials, installing attachment configuration pieces that will enable Dr. Cooper's robot to be—to have a better chance of correctly and effectively de-orbiting Hubble, does respond to one of NASA's charges, which is to safely de-orbit Hubble, and lower the risk to the public at large.

Mr. ROHRABACHER. Let me note, if the Chairman will indulge me, this isn't a must do mission. Obviously, we have people advocating that we simply bring it down. So, it is not a must do mission. Where else can give a better incentive for people to push the envelope on technological know-how than in a mission, that if it fails, it is not that great a failure, because when people have already argued to bring it down in the first place.

General BOLDEN. Sir, I think you misunderstood my statement. I—my statement is what is essential, if we are to comply with NASA's charge, and that is to safely de-orbit Hubble, it is essential that a robotic mission work, and we feel that flying the human

servicing mission does two things. It optimizes, or it better enhances the probability of a successful robotic mission to enable us to de-orbit Hubble. That is—

Mr. ROHRABACHER. Right. Well—

General BOLDEN. That is all—

Mr. ROHRABACHER. Well, at the same time—

General BOLDEN. That is all I was saying.

Mr. ROHRABACHER. Well, at the same time, putting human life at risk, where we have got an option where human life is not at risk at all, so that becomes not a factor to be even developed. One more line of questioning, if I could get into, just so I will note that to the degree that we cannot—we don't have to use Shuttle, we shouldn't be using Shuttle to the degree, because right now, we have had these two catastrophic accidents. We know that there is a great deal of risk involved in the Shuttle. So, that is something that we have to keep in our mind as well. And NASA has been dragging its feet, Mr. Chairman, on several areas, where we are trying to refrain from using Shuttle unless we have to. This is one example. Another example is where we—for example, where the Space Station can be serviced with a non-Shuttle type of operation, maybe even a private sector operation, that we do it this way. NASA has been dragging its feet on that. Some people just want to dive back into the use of the Shuttle, as if these accidents, these catastrophic accidents, didn't happen. Well, let us—we can't move forward on that basis. And Mr. Cooper, finally, let me give you a chance to—you have sat there, and if you are going to refute or—

Dr. COOPER. Thank you, Congressman.

Mr. ROHRABACHER.—whatever.

Dr. COOPER. Actually, my initial reaction was you were doing a much more eloquent job of stating the position I believe than I could. However, I do want to object strongly, strongly to the characterization of the Hubble servicing mission with robots as practicing, and in fact, let me tell you about something. It is a DOD-funded mission called Orbital Express. The explicit purpose of this mission is in fact to do this practicing, and this practicing will have occurred prior to when we go up to the Hubble. There will be no practicing involved in this situation.

Mr. ROHRABACHER. Well, thank you very much, and Mr. Chairman, again, let me congratulate you for putting together some team here, that could look at all of the sides of this argument, and give us such a—the benefit of having the value of all of their opinions. We appreciate it.

Chairman BOEHLERT. Well, thank you for contributing to interesting exchanges. Thank you. Ms. Jackson Lee.

THE "SCIENCE GAP" AND REHOSTING

Ms. JACKSON LEE. Thank you very much, Mr. Chairman. I add, too, my appreciation for this hearing. I think the Chairman well knows, and we have had some interesting exchanges between myself and the Chairman and other Members of the Committee. Over the years, my concern has been the question of safety. And I am—been, if you will, very keen on some of the testimony that we have heard this morning, and now, this afternoon, on questions of choice, of what you would use, but also, the variables between using a

human Space Shuttle, versus robotic. Let me also acknowledge General Bolden. It is good to see you again. I have been a neighbor for a long time, and as you well know, concerns about the human space flight, for those of us from Texas, is personal. And particularly in the backdrop of the *Columbia 7* tragedy, that was commemorated yesterday, I believe these issues are extremely important, as well as the science that the Hubble Space Telescope allows us to participate in. And so my line of questioning goes along the lines of choices, along with the question of the budget. And I do thank the Committee for the work that it has done, and I would hope that we would move expeditiously, because you have given us sort of a framework and a timeframe of how fast we need to move. I am looking at a calendar—we are now looking at the reauthorization of the Voter Rights Act of 1965. You wonder how that relates, but we have got to get moving, because it expires within a two year period. You are telling me that we are looking at expiration of the Hubble in its ability to function very shortly. So, let me ask this. On the rehosting, if we were to do the rehosting, there is a gap of time that it takes to have that implemented, what is the time—what is the gap of time? How long would that be, that we would be waiting, if we did—if we opted for the rehosting and the building, if I understand, of certain equipment, how long would that be? Let me add to, I think, an explanation that General Bolden was trying to give, and that is the distinction, or any sort of safety gap between a human Space Shuttle to the Space Station versus human Space Shuttle to Hubble. I would like to keenly understand whether—how finite that difference is, and I would share with my colleagues, I take issue with whether or not we should abandon human Space Shuttle. I absolutely believe we should not. If the President has announced a space exploration, whether or not we use a different type of equipment, human Space Shuttle is going to be very vital, or the human space opportunity is going to be very vital. Why not let us get additional expertise by doing the good works of securing the Space Station or Hubble? So if I might ask the gap on the rehosting, and then, can I get clearly, the distinctions of safety going in both directions? I would like—I will start with Mr. Pulliam, and then, Dr. Lanzerotti, and if you would yield, to also General Bolden as well.

Dr. LANZEROTTI. Yes, I intended. After I have had my little one minute—

Ms. JACKSON LEE. That is all right.

Dr. LANZEROTTI.—of fame.

Ms. JACKSON LEE. Mr. Pulliam.

Mr. PULLIAM. Ms. Jackson Lee, our analyses showed that Hubble would—probably near the end of its science life, in 2007, 2008. We know that extraordinary measures are being taken to preserve power and other kinds of things to keep that science life going as long as it can. We analyzed that Hubble would be at the end of its serviceable state in 2009, with science ending before that.

Our estimates for our completely rebuilt, new rehosting mission were in the 2011–2012 timeframe, so you know, we banded it very broadly by saying a two to seven year science gap. I can't imagine, under the analyses we did, getting much less than that. So, on the

order of five years, I would say, would be about a mean on how long we think the science gap would be.

Ms. JACKSON LEE. And how great do you perceive that science gap to be, when I say we have five years, but how much will we be set back because of that?

Mr. PULLIAM. Well, I will have to defer on that one. We determined early on that probably in doing our analysis, we shouldn't make evaluations about the science. So, we went to what we call the science surrogate, and that is what is the instrument suite that one would have, realizing that these folks to my left will use that to the best interest of the Nation. So, you know, if Hubble does end its science life, and there is a number of years in the four, five, six year range, with no science at all, then I expect my colleagues to my left would have grave concerns about that.

Ms. JACKSON LEE. Dr. Taylor.

Dr. TAYLOR. I could just point out that one of the very serious losses, if there were a gap as large as five years, would be the loss of people in the community who would need to find other things to do during those times, and probably would not be replaced. We would not, during that time, be attracting into doing advanced studies, new Ph.D. students in the field and things like that. It is very hard to turn the progress of that kind of a background of people off, and then turn it on again five years later.

Dr. LANZEROTTI. Thank you. I have—our committee would basically agree with the assessment of Aerospace and Dr. Taylor that it is of the order of five years or more of this science missed. Before I turn to General Bolden on the risk, I would like to make one comment. Dr. Cooper commented about the Orbital Express mission, which is late 2006. I would like to point out, in response to a question from Mr. Rohrabacher, who has to step out, I see, the Orbital Express is, again, a cooperative mission. It has cooperative targets, like the Russian missions. It does not demonstrate Hubble capability in its purest sense. So, I would like to get that on the record, as well.

Now, with regard to risk, and some of your more detailed questions, I will defer to my colleague, General Bolden.

SAFETY

General BOLDEN. Thank you very much, Ms. Jackson Lee. I went back to my notes from our conversation with the NASA Orbiter Project Office, because I wanted to make sure that what I said is what we agree with NASA on. And when they talk about—when we all talk about mission risks, or risks to life, it comes from several sources. One is debris elimination. That is mainly debris from the tank or debris from anywhere else on the launch pad, during the launch process. Everyone agrees that that risk is essentially the same. There is no difference whether you are going to Hubble or whether you are going to the International Space Station. With reference to debris risk on orbit, that is where there is a slight difference. The Hubble altitude, because we can maneuver the way that we want to, and we can put the wing into the wind, if you will, and I am using very loose terms here, okay. But if you figure the debris is coming with the wind, in the Hubble altitude, we can put the wing into the wind to minimize the risk to the vehicle. The way

that we orient the Shuttle presently to the International Space Station, the belly of the orbiter is into the wind. So, it is most—it is at its greatest exposure to debris risk on orbit from an International Space Station configuration. So, that makes ISS more risky from that standpoint.

The next thing comes to crew rescue, if it is—well, we then go to inspection and repair. The inspection process that has been developed, and continues to be developed, will need to be, by NASA's own desire, will need to eventually become autonomous, such that it can be accomplished no matter where the Shuttle is, whether it is in a Hubble orbit, or whether it is in an International Space Station orbit. And because of the way that the International Space Station configuration is gradually being modified, there will come a day, after Node 2 is installed on the International Space Station, that the Shuttle will need an autonomous inspection capability anyway, because Node 2 will prevent us from being able to see and reach things that we can reach right now, while Hubble is—while the Shuttle is docked to the International Space Station. So, inspection and repair, by NASA's own desire, will be equal, whether you are at the International Space Station or whether you are at the Hubble Space Telescope.

The next thing is crew safety, and this is where the margin goes to the International Space Station. NASA says there is a 90 day safe haven capability at the International Space Station. That is questionable, extremely questionable, at present, because of the present state of the environmental control system, the environmental life support system, on the International Space Station. So, it can go somewhere from 30 to 90 days, where a crew can wait for a rescue mission to be mounted. When you power down the Shuttle, once you have discovered that there is a problem, you can have anywhere up to a 30 or 45 day period of time, where just an orbiting Shuttle in a Hubble Space Telescope altitude, or—could also stay with its own safe haven, as the Shuttle itself. This does not give any consideration to commercial recommendations of safe havens that, I think, some of your committee, or staffers have already seen. So, you know, the matter of providing safe havens to a crew is kind of open ended, but right now, the margin there goes to the—to being docked to an International Space Station, hopefully that helps.

Ms. JACKSON LEE. I thank the Chairman for his indulgence. Does anyone believe that this mission should be scrapped, or that we should not try to save the Hubble telescope? Anyone on this panel? So, we have a job to do. Is that correct?

Chairman BOEHLERT. Thank you very much.

Ms. JACKSON LEE. Thank you, Mr. Chairman.

Chairman BOEHLERT. Mr. Sodrel.

HUBBLE SERVICING AND ITS RELATION TO EXPLORATION

Mr. SODREL. Thank you, Mr. Chairman. As a new Member of the Committee, I appreciate the opportunity to ask questions, and as a freshman here, I bring a business background. And if I might defend those folks that are on the low side and the high side of what a Shuttle costs, cost accounting is more art than science, unfortunately. I mean, which of the costs are fixed, which are variable? Of

the fixed costs, how do you amortize them, over how many flights? What is the useful life of the asset? I mean, those are the kind of discussions that we have in business. You know, how long is this asset going to last, how much will we use it, and how much do we need to charge to each use of it? So those are not easy questions. I find that costs are rarely as expensive as a pessimist would have us believe, and they are rarely as inexpensive as the optimist would have us believe. So, somewhere in the middle is probably the cost. And my question goes somewhat to that. Did we consider costs—and this, to Dr. Lanzerotti. Did the Committee consider how the robotic mission to the Hubble would directly apply to future exploration missions, to the Space Station, or the Moon? In other words, can we amortize that cost? Is this something we are going to have to develop anyway, or something that would be useful later on? And did you consider that?

Dr. LANZEROTTI. Our committee did not consider that in depth. I will ask Mr. Rothenberg if he has any further comments, if I might. But the Committee did not consider that in depth. The Committee did have the feeling, and I also have the personal belief, that when one does the Human Exploration Initiative, and continues moving humans to the Moon and possibly to Mars, that one will have a very different model for robotic exploration. One will not have the model of a non-cooperative target that was not designed for robotic servicing, which is the case with Hubble. And so it would—anything that we launch into space that we want to service robotically, and I am sure that we as a nation and internationally will want to do so, we will design that from the start with that in mind. Hubble is not designed for robotic servicing. There have been many experiences that we have had with servicing Hubble by astronauts, where unforeseen things have been found on Hubble. When they have pulled out instrument racks to replace them, they found a blanket in place that wasn't expected from the CAD/CAM drawings, and the astronauts could handle that. When one—if one—presumably, one would design a robotic mission from scratch, so that you wouldn't have such things like that arise. And so, that is—those are some of the kind of issues and experiences from the Shuttle servicing program that one has with this uncooperative target that wasn't designed in this way, that formed an important part of our committee's deliberations.

Joe, would you like to make any further comments in this regard?

Mr. ROTHENBERG. Just one little, further to illustrate it. The uncooperative target is one piece. The second is the actual design of the vehicle in general. For example, there is multiple sockets needed to be carried up for the robot to pick up and address multiple bolts in order to do the servicing. If one were designed for robotic servicing in the future, and even with humans, this became difficult, but one designed for robotic servicing, you would have all of the same bolt sizes, or have a minimum number of different bolt sizes, such that there is a minimum number of motions needed to get another socket, bring it up, and put it on the robot, put it on the nut you are particularly trying to loosen. So, you would design the vehicle differently, and I think that is a lesson we learned from even the human servicing of Hubble, where we had to carry up a

tool suite far beyond what would normally be expected if you designed it for completely servicing.

Mr. SODREL. So, just to follow, then this is apt to be expense rather than an investment. It is a one time expense, not something that we would very likely use in the future.

Dr. LANZEROTTI. I am not—you mean, the servicing of Hubble?

Mr. SODREL. Yes. I mean the robotics involved—

Dr. LANZEROTTI. Oh, the robotics.

Mr. SODREL.—in Hubble.

Dr. LANZEROTTI. Joe?

Mr. ROTHENBERG. No. Clearly, we will learn something. I mean, as we go through it, we are going to learn something of value. That is not the point. I think it would be—the question is, is the investment, if we were only doing it to learn what it took to do exploration, the right investment, or would you do it in a different way, such as using the Dexter on the Space Station and designing some targets and opportunities to test actually as you would design in the future, and buy down the risk of future designs.

Mr. SODREL. Thank you. Mr. Chairman.

Chairman BOEHLERT. Thank you very much, and thank all of you very much for indulging us, and going a little bit beyond the witching hour. We will follow up with some things in writing, and I would urge you, if you feel that there is something more, in view of what took place this morning, that we should consider, please supplement your responses to our written questions with any additional comments you might care to make.

But thank you once again. Hearing adjourned.

[Whereupon, at 12:36 p.m., the Committee was adjourned.]

Appendix 1:

ANSWERS TO POST-HEARING QUESTIONS

ANSWERS TO POST-HEARING QUESTIONS

Responses by Louis J. Lanzerotti, Chair, Committee on Assessment of Options to Extend the Life of the Hubble Space Telescope, National Research Council, The National Academies

Questions submitted by Chairman Sherwood L. Boehlert

Q1. You said at the hearing that having a second Shuttle on an adjacent launch pad ready to rescue any stranded astronauts in an emergency is not a prerequisite for sending a Hubble servicing mission. Yet NASA has told the Committee repeatedly that, to provide a sufficient safety margin, a rescue Shuttle must be on an adjacent launch pad. You also stated that General Bolden could relate past times when NASA has had two Shuttles on the launch pad simultaneously (which he was unfortunately unable to do before the end of the hearing). Yet NASA has told the Committee that processing two missions simultaneously would be risky, highly complex, and would put an “unprecedented strain” on the overall Shuttle system.

Q1a. What is your response to NASA’s assertions?

Q1b. When has NASA had two Shuttles on the launch pad simultaneously?

A1a & b. The CAIB did not require NASA to have a second Shuttle on an adjacent launch pad and ready for launch to rescue stranded astronauts in an emergency, nor did the CAIB require a “safe haven” capability. Both of these requirements were established by NASA as its internal criteria for return to flight. The NRC committee believes, as discussed in Chapter 6, p. 84, of its final report, that following the experience of flying several ISS flights, there are a broad range of options for implementing a single HST servicing mission.

Two of these options would not require a Shuttle rescue mission or a safe haven. Considerations for choosing an option include demonstrated success in eliminating debris during Shuttle ascent and the actual risk reduction provided by a rescue mission. The NRC Committee recognizes that the ultimate decision on implementing a HST servicing mission is the responsibility of NASA. However, as discussed in Chapter 6, p. 80, if NASA decided that an on-orbit crew rescue mission were needed, then a Shuttle HST servicing mission would require the on-pad provision. Implementation of a pad provision on a single HST mission was deemed manageable by the NRC Committee.

With respect to NASA’s concerns that processing two vehicles simultaneously “. . . would be risky, highly complex, and would put an unprecedented strain on the overall Shuttle system,” we note that NASA is currently processing two vehicles simultaneously for flights STS–114 and STS–121 and historically the KSC vehicle processing teams have always had two or three vehicles in the processing flow simultaneously with no evidence of undo strain or risk. Actually the concern is for conduct of simultaneous launch countdowns—that period from T minus 72 hours to launch (up to five calendar days). This concern is driven by the required JSC mission control center reconfiguration for a second launch while simultaneously controlling a flight in progress. NASA also expressed concern about launch crew fatigue and stress at the KSC from knowing that a launch delay of the rescue vehicle would likely result in the loss of a stranded crew. While we accept these concerns as legitimate, they will also be present for any rescue mission needed to the ISS (though the ISS provides some additional time cushion for preparation). Also, we believe these concerns can be mitigated by focused management.

On five occasions since May 1995, there have been two space Shuttles simultaneously in the launch flow on adjacent launch pads at the KSC as follows:

July 2001	STS–104 & STS–105
Dec 1999	STS–103 & STS–99
Oct 1995	STS–73 & STS–74
July 1995	STS–70 & STS–69
July 1995	STS–71 & STS–70

In the first July 1995 case, STS–70 was actually launched 16 days after the launch of STS–71. The intervals between launches of STS–73 and STS–74 and STS–104 and STS–105 were 23 and 29 days, respectively.

Questions submitted by Representative Bart Gordon

Q1. Your committee's report notes that NASA has only committed to providing a "safe haven" capability on the International Space Station for the first two flights of the Space Shuttle after its return to flight. Your report also notes that ISS safe haven "has significant risks due to its limited redundancy and margins."

Q1a. Please elaborate on the nature of the risks, and identify the specific changes to the current ISS baseline that would be required to provide a credible "safe haven" capability on ISS for a combined ISS/Shuttle complement of 9–13 crew members for whatever time would be required to deliver another Shuttle to the ISS, as well as to sustain that capability through the completion of the ISS and retirement of the Shuttle, now scheduled for around 2010.

A1a. The concerns of the NRC Committee with respect to the risks inherent in the ISS "safe haven" are related primarily to the ISS's life support system. The life support system is currently certified for only three crew members, but after the delivery of the additional logistics planned for the LF1 manifest (STS-114), ISS will have the capability to accommodate nine crew members (two ISS and seven Shuttle). However due to the lack of redundancy this capability would not be considered robust. Since our report was issued, the Space Station Program (SSP) has accomplished several engineering reassessments and has taken action to modify the LF1 manifest to provide the necessary logistics to accommodate an ISS crew of nine. A spare ISS Carbon Dioxide Removal Assembly (CDRA) with spare parts, spare power cables for response capabilities for electrical failures, extra stowage bags to maximize collection and storage of orbiter-produced water while still docked to ISS, extra Apollo bags for contingency human waste collection after the orbiter is undocked, along with other logistics provisions have all been added. The most recent SSP engineering assessment has created three ISS scenarios based on conceivable failures before or during a contingency crew stay. The first scenario (loss of CO₂ removal capability) is 16 days of stay time—very similar to that of a Shuttle orbiter at the HST. The second scenario (loss of O₂ generation capability) is 45 days stay time. And the third scenario (exhaustion of onboard water) is 70 days stay time.

Another NRC Committee concern about reliance on ISS as a "safe haven" is that such reliance assumes that the damage to the orbiter (or any other failure) would not prevent it from achieving ISS orbit and docking. In fact, as demonstrated on STS-51F in July 1985, loss of an engine during ascent can result in a lower-than-desired orbit from which the ISS cannot be reached. In such an eventuality, the orbiter would become the "safe haven" and, for the planned case, the crew would have 18 days of stay time.

In summary, NASA has improved the "safe haven" posture of the ISS but Shuttle failure modes do exist that would preempt a docking with the ISS, and there are also potential failures on-board the ISS that would severely limit it as a "safe haven."

Q1b. If NASA decides not to continue to provide a safe haven capability on the ISS after the first few Shuttle flights—as currently appears to be the plan—would there be any practical difference in rescue options available for a Shuttle headed towards ISS and a Shuttle headed towards Hubble?

A1b. Should NASA decide not to provide a "safe haven" capability on the ISS after the first few Shuttle flights, there is still a slight advantage in terms of rescue capability for a flight to the ISS as opposed to one to the Hubble Space Telescope. As stated in our committee report, Chapter 6, p. 79, and during our testimony to the Science Committee, we agree with NASA that the ISS provides the preferred place to be in the event that the crew survives but the orbiter damage is severe enough to result in an unrecoverable vehicle. The ISS would afford additional time for a stranded crew over a stand-alone orbiter and, therefore, increases the likelihood that a rescue can be effected by contingency means. We also agree with the current SSP assessment that, by the time a Hubble servicing mission is flown, NASA will have successfully demonstrated that it fully understands and has solved the problem of debris from non-MMOD1 causes and that therefore the requirement for a "safe haven" capability will have been reduced considerably.

Q2. It has been asserted that the National Academies' suggestion that the Shuttle could be maintained on orbit for 30 days while awaiting rescue does not address the issue of whether it would be possible to sustain the crew's lives for that period of time. How do you respond?

A2. The committee naturally uses the term “safe haven” only to refer to a situation in which the crew’s lives can be sustained. As stated in Chapter 6, p. 80, of the NRC report, the Shuttle provides a “safe haven” for the astronauts of between 17 and 30 days, depending on when an extreme power-down is done. If the full planned timeline for inspection, data processing and decision making is used, SSP analysis shows that 18 days are available. The NRC committee believes that the decision can be made earlier for some scenarios, thereby increasing the time on orbit.

Q3. *It has been asserted that a Hubble servicing mission would not have a trans-Atlantic abort site available to it. Is that correct, and if so, how would you address that concern?*

A3. There has been misunderstanding of the trans-Atlantic landing abort site (TAL) capability as it relates to a Hubble servicing mission. A Shuttle mission to Hubble actually has excess ascent performance, due to the relatively light weight and due East launch profile of the orbiter. This actually results in an overlap of the return to launch site (RTLS) and abort to orbit (AOA) regions, therefore negating the need for a TAL capability. Nevertheless, should the SSP choose to insert a TAL capability in the software for a Hubble servicing mission, the runway at Moron, Spain, is still available for use in a TAL capability.

Questions submitted by Representative Mark Udall

Q1. *Some have argued that there is a large backlog of existing Hubble data waiting to be analyzed, and thus there would be little impact on science if Hubble ceased operations today. Do you agree or disagree?*

A1. This question refers to the large body of data known as the Hubble Archive. The Hubble Archive is an invaluable science resource and exists because of the nature of Hubble data acquisition and the timely analysis and publication of the data. However, the word “backlog,” is sometimes misunderstood in the context of the archive. It implies that analysis of Hubble data has somehow not “kept up” with observations, so that observations have “gotten out in front” of analysis and therefore observations might be stopped with no penalty in order to let analysis “catch up.” This is not the case. In each proposal for new observations, the proposers must list all the previous proposals they have submitted and the status of the data analysis. Unproductive proposers (those who have received data but have not analyzed them) are screened out of the system. Proposers are aware that their past performance will be scrutinized. Since competition to gain time on Hubble is more intense than for any other telescope in the world, and because Hubble science is in itself highly competitive with multiple teams studying the same problem from different perspectives, Hubble users as a group move with exceptional rapidity to get their results out and published in a timely manner. This is one reason that Hubble productivity in terms of number of papers published and number of citations to those papers is by far the highest of any telescope in the world.

However, once data have been analyzed for their original purpose, that is not the end of the data’s usefulness—frequently the data can be reanalyzed for another scientific purpose. It is in this second stage that the Hubble Archive plays a scientific role, to serve as a repository to store the data but also as a powerful search tool to identify and create entirely new *collections* of data (such archives are associated with other major telescope facilities as well and have proven essential in the achievement of new understandings as time passes and ideas and theories change). The reasons for reanalysis take two forms. First, it is a rare proposal that manages to observe all possible astronomical targets that are relevant to the subject. That would take too much time. Rather, the proposer singles out the minimum number of objects that will suffice to answer the precise question posed. Meanwhile, other proposers will have looked at other targets in the same family, for similar reasons or perhaps for completely different reasons. Thus, as time goes by, the collections of data that are available for studying any given problem are continually growing. This growth in numbers makes it possible to detect very subtle trends that are visible only with a very large number of objects. The process is analogous to sampling the population of the United States in a census.

If the sample is tiny, say ten people, one might learn only that roughly half the population is male and half is female. With a million people (carefully selected to be representative) one could learn much more, such as the age distribution, countries of origin, employment figures, etc. In the same manner, the growing richness of the Hubble archive is enabling more and more precise questions to be asked as the number of objects of a given type (stars, galaxies, star clusters, etc.) increases from a few, to several dozen, and now in some cases to several hundreds of objects.

The second reason for the scientific importance of the Archive is that a typical observation usually contains much more information than was needed by the original proposers. For example, every image that is taken contains superimposed objects in the background or foreground along the same line of sight. Likewise, nearly every spectrum contains dozens or hundreds of spectral features in addition to the ones that were originally targeted. This richness encourages scientists to go “back to the well” many times in order to draw every last bit of interesting science from the data. This process is vast and will continue for many years after Hubble has stopped operating.

The response above leads to the second half of the question, which is whether the process of data acquisition has continued long enough and the collected samples are now sufficiently large. The answer is in fact no, for several reasons:

- The universe is constantly changing, and there are many classes of objects that are time-variable. Hubble is still collecting time-series data on many such classes of objects.
- As a telescope with incredibly broad applications, Hubble is needed to work synergistically with other NASA observatories. Hubble sees nearly all objects in the Universe within reach of these other observatories, and Hubble is the telescope that gives the highest-resolution picture showing fine details. As a result, a very large fraction of the proposals received for time on Hubble are being driven by interesting new results from other spacecraft that now need Hubble follow-up for proper interpretation. Hubble is working cooperatively with the Chandra X-ray Observatory, the Spitzer Infrared Observatory, the GALEX Ultraviolet Explorer, and the Swift Gamma-Ray Observatory. These observatories are all much younger than Hubble, and many results are coming in for the first time, inspiring new Hubble projects. For example, Swift just launched last November 20, 2004.
- The larger field of view of the ACS camera, installed in 2002, enabled real surveys to be taken for the first time by Hubble, covering nearby galaxies and star clusters that were formerly too big for Hubble and enabling maps to be made of much larger portions of the distant Universe. Demand for these larger surveys has not yet abated.
- Most important of all, the SM-4 servicing mission would install two new instruments on Hubble. Each time new instruments have been installed, there is a burgeoning of new ideas to explore with them. This time will be no different. One of the new instruments is a combined ultraviolet/infrared camera that will take images 10–50 times faster at UV and IR wavelengths than the older cameras. The second new instrument is an ultraviolet spectrograph that is faster by a comparable factor. These enhanced capabilities will enable huge gains in understanding. Together, these two instruments will essentially remake the Hubble observatory, for the fourth time in its history.

Q2. How should we view Hubble—and more broadly, space science as a whole—in the context of the President’s space exploration vision?

A2. The gains in knowledge made possible by Hubble strongly support-in fact enable—the President’s space exploration vision. Hubble is about exploring: exploring the vast universe in which humanity resides. NASA has been, since its beginning, an agency that inspired—on a broad variety of fronts and in a broad variety of ways—by:

- Instilling admiration for American technology by conducting a dazzling and daring program of firsts in space exploration.
- Fostering the image of America as a capable, can-do society that is willing to take on and conquer the most difficult challenges.
- Educating and inspiring America and the world about the colossal cosmic processes that gave rise to Earth, created life, and ultimately created human beings.
- Unveiling our species’ cosmic history and, in so doing, laying key foundational knowledge for shaping our cosmic future.

Historically, the strategy used by NASA to execute this larger mission has been a highly successful two-pronged strategy of “exploration”:

- Exploration of the Solar System by humans, and
- Exploration of the Solar System (and the Universe beyond) by remotely operated observatories and landers.

Remotely operated craft complete the exploration program by carrying sensors that far outstrip human vision and by going places that humans cannot go, and the next generation of “space robots” will simply be the next step in NASA’s long-term program of substituting machines for people, when appropriate.

The United States space program is an integrated whole: people plus machines exploring space from the edge of the Earth to the edge of the Universe. It is inconceivable to envision a programmatically-whole NASA that does not pursue exploration vigorously, via *both* human space flight *and* remotely operated spacecraft. . .and explores not just within the Solar System but also beyond.

Viewed in this context, the Hubble Telescope repair (together with the broad suite of other exciting scientific missions in flight and in planning makes perfect programmatic sense. While vigorously pursuing the Exploration Vision the agency must maintain its current bold and creative leadership in robotic exploration, from the Earth to the Sun, the planets, and the distant universe. Hubble—the world’s most powerful observatory with gold-plated scientific credentials coupled with high name recognition and widespread public support—fits admirably into this vision.

In repairing Hubble, the human and remote-spacecraft arms of the NASA program come together synergistically to achieve a goal that neither could achieve alone.

ANSWERS TO POST-HEARING QUESTIONS

Responses by Joseph H. Taylor, Jr., Co-Chair, Astronomy and Astrophysics Survey Committee, National Research Council, The National Academies

Questions submitted by Chairman Sherwood L. Boehlert

Q1. Should Hubble operations cease in the next two to four years, what will be its impact to the community of scientists since, as you point out, one-third of all funding for astronomy is tied to Hubble?

Q1a. What will be its impact on the training of the next generation of scientists?

Q1b. How could the impact on Hubble scientists be minimized if no servicing mission were to occur?

A1a & b. If the Hubble Space Telescope (HST) becomes inoperative well before a replacement is available, graduate students, post-doctoral trainees, and their mentors will lose one of the most important sources of astronomical information. Synergistic multi-wavelength results obtained nearly simultaneously with the HST and with Chandra, Spitzer, and ground-based facilities including the Very Large Telescope and the Keck Telescopes will become impossible for some years; students will gravitate to other fields, and US momentum and leadership will suffer.

I believe it would be unwise, and surely a false economy, not to proceed with the planned SM-4 Shuttle servicing mission soon after the Shuttle returns to flight. But if for some reason the servicing cannot be accomplished, NASA should look for other ways to maintain its enviable and well deserved reputation for scientific leadership.

Questions submitted by Representative Bart Gordon

Q1. You chaired the most recent Decadal Survey of Astronomy and Astrophysics.

Q1a. What did that Survey assume regarding an SM-4 Hubble servicing mission?

Q1b. Was it among the "pre-requisites" assumed by the Survey?

A1a & b. The Survey took it as given that NASA would proceed with its plans to keep HST in good operating condition, most likely until (or nearly until) the Next Generation Space Telescope is in orbit and operational.

Q2. Did NASA ask any of the relevant National Academies committees or other appropriate representatives of the scientific community for input prior to its decision last year not to service Hubble?

A2. As far as I know, they did not.

Q3. If the commitment made by NASA Administrator O'Keefe to Congress to "grandfather in" the SM-4 Shuttle servicing mission to Hubble in the wake of NASA's shift in its Shuttle accounting approach is preserved, and thus the Shuttle-related costs of the servicing mission are not imposed on NASA's science program,

Q3a. Would you consider having NASA's science program pay the science-related costs of the servicing mission (estimated to be \$300-\$370 million) to be consistent with the assumptions of the Decadal Survey?

Q3b. Would you favor an SM-4 Shuttle servicing mission to Hubble if NASA's above-mentioned commitment to Congress is maintained?

A3a & b. I do not recall that funding details of the planned servicing mission were explicitly discussed by the Survey Committee. We were told that the necessary servicing missions were "in the budget."

I am definitely in favor of an SM-4 Shuttle servicing mission, as soon as possible after the Shuttle returns to flight. If the stated commitment to Congress is maintained, there should be no adverse effect on other NASA science goals recommended by the Decadal Survey.

Question submitted by Representative Mark Udall

Q1. Dr. Taylor, your testimony mentioned the importance of concurrent science operations by Hubble, the Spitzer Great Observatory, and the Chandra Great Observatory.

Q1a. Would you please explain why that synergy is important for researchers?

A1a. Many of the astronomical phenomena in question are variable on time scales from days to years. Much of the potential of the Chandra Great Observatory, especially, will be lost if simultaneous (or nearly simultaneous) observations are not available from HST over its working lifetime.

In addition, it frequently occurs that important astronomical targets are first identified in one wavelength region, and then studied even more effectively in another part of the spectrum. For that reason, the rate of discovery increases even more than proportionally when concurrent science operations are possible over a wide wavelength range.

ANSWERS TO POST-HEARING QUESTIONS

Responses by Steven V.W. Beckwith, Director, Space Telescope Science Institute

Questions submitted by Chairman Sherwood L. Boehlert

Q1. At the current rate that Hubble data are studied, for how many months or years would astronomers still be analyzing new data if the Hubble telescope ceased operations today? Is the backlog of data sufficient to fill any gap between Hubble operations and those of the James Webb Space Telescope?

A1. The archival program is about 13 percent of the total research program on Hubble. If new observations were not possible, and we funded archival research at the same rate as new observations, all of the useful data analysis would be done in about one year. Of course, Hubble data will be used for archival purposes for many years to come but mostly as ancillary data to support new information coming from operating observatories.

Currently, the Webb telescope is scheduled for launch in 2011, meaning the actual gap would be six years, if Hubble operations ceased today. I do not believe archival research will adequately bridge the gap to the launch of the Webb telescope, if Hubble operations cease early.

Most of the archival programs rely on data that is only a few years old. If there were no more new data, we would expect even the reduced demand for archival research to wane over a four-year period, say.

It is also important to realize that newly targeted Hubble observations conduct quite different type scientific investigations than archival research; the two are not interchangeable avenues to discovery. Hubble observes only a tiny area of the sky; it is a pointed telescope as opposed to a survey telescope. It typically gathers unique data on an object already known to be interesting, and the initial investigations get most of the scientific value in the first publications. These very small regions of the sky in the Hubble archive represent a minuscule section of the Universe. While well-suited to continuing investigations of the original peculiar object that motivated the data, they are generally not useful for random, unexpected discoveries.

Hubble is just now beginning to make major surveys that will serve as a legacy for the future, but these will not be completed if the Hubble mission ends early, thus depriving astronomers of the most valuable archival data they anticipate.

Q2. Should Hubble operations cease in the next two to four years, what will be its impact to the community of scientists since, as Dr. Taylor points out, one-third of all funding for astronomy is tied to Hubble? What will be its impact on the training of the next generation of scientists? How could the impact on Hubble scientists be minimized if no servicing mission were to occur?

A2. The Hubble grants program provides approximately \$24 million dollars per year for astronomy, of which \$3 million is the amount for archival research. The Hubble program does support almost one-third of all funding for astronomy. When Hubble operations cease, funding for archival research on Hubble will continue to support research but at a dramatically reduced rate compared to the total now. It would represent a substantial loss to astronomy.

A second factor is Hubble's impact in motivating ground-based research. Hubble programs stimulate substantial uses of our nation's ground-based facilities such as the National Optical Astronomy Observatories (Kitt Peak and Cerro Tololo) and the international Gemini project. If Hubble ceased operations, many of those Hubble-generated programs and the training they provide to graduate students would disappear.

Questions submitted by Representative Bart Gordon on behalf of Representative Mark Udall

Q1. Some have argued that there is a massive backlog of existing Hubble data waiting to be analyzed, and thus there would be little impact on science if Hubble ceased operations today. Do you agree or disagree?

A1. I disagree with the assertion that there would be little impact on science if Hubble ceased operations today. My analysis of our archival program presented above indicates that the backlog of data would take the equivalent of one year to analyze at the present rate of funding for Hubble research; we could envision funding archival research for a much longer period, of course, but at a reduced rate of expenditure. Even if we relaxed our standards for selecting archival research pro-

grams, we could not credibly support a scientifically compelling program for more than two years at the same rate as we now support new observational programs.

As I have noted previously, archival research and new Hubble observations are not interchangeable, nor equally suited to important discoveries. The former generally extends our knowledge of complex problems in an important way, but it is the latter that most often leads to unexpected and ground-breaking discoveries.

Q2. You chaired one of the Decadal Survey panels that looked at Hubble and the James Webb Space Telescope (JWST). Please describe how your panel prioritized Hubble relative to JWST.

A2. Our panel was given the task of ranking the top priorities for space research at wavelengths from the ultraviolet to the infrared in the decade from 2001 to 2010. NASA's plan for that period contained two important assumptions that aided our work:

- a) The Hubble Space Telescope would be serviced at least two more times (SM-3 and SM-4) and kept operational until 2010.
- b) The James Webb Space Telescope (called the Next Generation Space Telescope at that time) would be launched in 2007.

Those were two crucial assumptions that allowed us to assign priorities. We expected Hubble to remain operational with planned instrument upgrades throughout the decade we were assigned to study. Therefore, we decided not to rank it in our priority list. Our reasoning was that any extension of its life beyond 2010 could be debated in the second half of the decade, when we got to see how new programs developed and how Hubble compared. A servicing mission could be carried out with only a few years lead time, making it unnecessary to consider Hubble right away.

The James Webb Space Telescope was scheduled for launch in 2007. There would, therefore, be a three- to four-year overlap between Hubble and Webb. If Webb achieved all its objectives, the pressure to continue Hubble might be greatly reduced. If the capabilities of Webb were greatly curtailed, or if a failure limited its life, there would still be time to consider life extension for Hubble.

Unfortunately, the launch date of the Webb telescope has now slipped beyond 2010, and NASA is considering an end to the Hubble mission in 2007 or 2008. I believe our panel would have looked at the priorities differently under this changed set of circumstances, and we would likely have made a strong statement about Hubble science given the impending gap that we see now.

The importance of Hubble science in this decade was recently reaffirmed by two, high-level committees who examined the question: The HST-JWST Transition Plan Review Panel (NASA), chaired by John Bahcall, and The Committee on the Assessment of Options for Extending the Life of the Hubble Space Telescope (NRC) chaired by Louis Lanzerotti. Both committees strongly endorsed the scientific importance of servicing Hubble a fifth time through SM-4.

Q3. If Congress or a new NASA Administrator decides to reinstate a Shuttle servicing mission to Hubble, what civil service and contractor workforce will be required to complete the mission within the required timetable, and how soon before the mission will they need to be in place? Is that workforce currently in place?

A3. It takes about two years to prepare for a servicing mission to Hubble, if the experienced teams are available. The good news is that the workforce is largely in place to support a Shuttle servicing mission, including people at Goddard Space Flight Center, Johnson Space Center, the contractor teams, and the Space Telescope Science Institute. Many of the critical government and contractor personnel are working towards a robotic servicing mission. Some additional people would be needed to support documentation for a Shuttle mission at Goddard Space Flight Center, but I believe they could be added relatively easily.

It is vitally important that this workforce remain in place while the debate on Hubble's future continues. If we lose the key engineering and technical talent with decades of experience on Shuttle-based Hubble servicing, it will be very difficult to replace. Fortunately, key people at Goddard Space Flight Center, on the contractor teams, and at the Space Telescope Science Institute are still part of the Hubble team and will remain part of the team as long as they are supported and there is a realistic hope for Hubble servicing in the near future.

Q4. What fraction of the science-related costs (i.e., non-Shuttle-related costs) have already been incurred in preparing for the SM-4 servicing mission? What remains to be done if the SM-4 servicing mission is reinstated?

A4. In round numbers, we have invested approximately \$250 million in new instruments and replacement parts for SM-4. The costs to NASA space science of a servicing mission are typically \$300 to \$400 million spread over the next three years. By this calculation, most of the money for SM-4 has already been spent.

However, the delays to SM-4 following the *Columbia* tragedy mean that the technical workforce will have to be supported for another three years to service Hubble. That three year delay will mean an additional \$360 million for workforce support.

Q5. *How many requests for observing time on Hubble do you receive annually? What percent of those requests can be accommodated? Has the demand for observing time on Hubble changed over the years?*

A5. The demand for telescope time in a single year is approximately six times that amount of time available. That demand has been steady for approximately the last eight years. We experienced a drop of about 25 percent this year following the failure of the Space Telescope Imaging Spectrograph (STIS) in July, 2004. Even without STIS, the demand for time in the most recent year exceeded the available time by a factor of 4.7. To place this value in perspective, it is a greater over-subscription ratio than that of any other NASA observatory, past or present. The scientific quality of the proposals continues to be outstanding, and we will be turning down many proposals that are scientifically compelling.

ANSWERS TO POST-HEARING QUESTIONS

Responses by Paul Cooper, General Manager, MDA Space Missions

Questions submitted by Chairman Sherwood L. Boehlert

Q1. You seem to argue that many aspects of a robotics servicing mission are not new and therefore can be done more easily and quickly than the Aerospace Corporation and the National Academy of Sciences believe. But on the other hand, you argue that a robotic servicing mission is a critical opportunity to drive the development of robotic capabilities in space. How do you reconcile these seemingly contradictory arguments?

A1.

Stepping Stone to the Future

Although the Hubble Robotic Servicing mission will not involve designing and building any radically new technology, the mission will involve *deploying and operating* technology building blocks in new ways, in new combinations, or for the first time.

The key thing to understand in this regard is that the Hubble Robotic Servicing mission *is the next natural step* in the gradual development and proving out of a set of capabilities that are crucial for the future—for the future of affordable space science missions, for the future of DOD space missions, and for the future of human and robotic exploration missions.

As such, the Hubble Robotic Servicing Mission really will serve as “a critical opportunity to drive the development of robotic capabilities in space,” while incurring the least possible additional operational or mission risk.

Let me explain.

An existing “mind-barrier” that NASA Architects currently face is to assume or not assume that they can count on remote robotic capabilities to conduct complex assembly and servicing tasks for future missions, which could impact the direction of NASA investment and development to support such missions. The fact of the matter is that even though all the key building blocks for the Hubble Robotic Servicing Mission already exists or have been flown, no one has yet been given an opportunity to put them together and demonstrate such a mission capability in an integrated fashion. The Hubble Robotic Servicing Mission would enable NASA Architects to plan differently (when they can start counting on similar robotics capabilities) and potentially save billions of dollars by not having to solely rely on astronauts all the time to undertake any remote assembly and servicing tasks, or have to develop very large launchers (only) to accommodate future large integrated space infrastructure. Furthermore, the additional benefits to DOD Space Applications (as has been suggested by several Congressional members at the Hearing) are also expected to be very significant.

Future Space Programs will undoubtedly need to maximize sustainable affordability, maximize safety and improve mission success effectiveness. Hence it is worth underlining the value of what will be achieved with an operational proof of servicing the Hubble:

For astronaut safety: Hubble robotic servicing will show that an alternative to risking astronaut lives exists, particularly for addressing future servicing and other mission requirements that are intrinsically mundane (e.g., changing batteries) or don’t require astronaut talents.

For space science: A future of affordably upgradeable and serviceable large instruments.

For DOD: Affordable assembly and servicing of large national assets in orbit.

For Exploration: The robotic assembly of human-support infrastructure in advance of the human occupation, e.g., at Lagrange points, on the lunar surface. An affordable alternative to very heavy lift capability, e.g., the robotic assembly in orbit of multi-piece spacecraft, where each piece is launched with smaller and much cheaper launchers.

Aerospace Corporation and NAS Reports

Both the Aerospace Corporation and the National Academy of Sciences reports appeared to have based much of their technical/risks assessments for the Hubble Robotic Servicing Program on “starting from scratch” assumptions. Their conclusions were significantly higher than the baseline Program because the Program started from technology and hardware already available. For example, many of the

simulators already exist. The existing SPDM robot is being transferred from ISS (later to be replaced). The RMS End Effector is a flown spare from the Shuttle Program. The Propulsion Module hardware is from the X-38 canceled program. The main rendezvous Lidar sensor is a duplicate of the one to be launched on the AFRL XSS-11 Program by Spring 2005. The unmanned robotic control capability has been qualified for DARPA's Orbital Express Program and will be launched in 2006. Also, flight software for HST exists and would be easily modified. The Ground Station for HST already exists and is in use and, most important of all, there are over 500 personnel who are already knowledgeable and experienced in servicing, checking out, and operating HST. There is very little technology development for this Program. The maximum effort will be expended in Systems Engineering Integration, Testing and Training.

None of these factors were incorporated into the Aerospace Study because it was not their Charter to do so. The Vice President of Aerospace Corporation has subsequently gone to GSFC (February 2005) to see these items of hardware and was amazed with all the progress made and the elements of hardware at hand. Similarly, the NAS had only a four hour presentation on the Robotic Mission, and since NASA was in a procurement process for the robot, the Committee was not able to assess the maturity of the hardware. As a result, they had to depend on the Aerospace Study to form their assessment. Both Aerospace and the NAS members have been invited to the NASA Preliminary Design Review (PDR), March 21-25, 2005.

Q2. Several comments were raised during the hearing regarding risks associated with the grappling arm and the dexterous robotic arm, but there was little discussion about other risks such as interfaces and autonomous docking with an uncooperative target. How serious are these risks, and what measures are being taken to minimize them?

A2.

Other Risks

Some of the other risks associated with the Hubble Robotic Servicing mission are summarized as follows:

Autonomous rendezvous. The Hubble mission will arrive on the heels of the gradual development and testing out of rendezvous technology and capabilities that started originally with Apollo. Most immediately prior to the Hubble mission will have been the XSS-11 mission (to be launched in April 2005), the DART mission (2005 launch), the Orbital Express mission (2006 launch), a Shuttle/ISS Rendezvous DTO Mission (2006 launch). These missions have as a key objective the continuing improvement and testing of sensors and software for autonomous rendezvous and proximity operations. The Hubble mission will use similar or identical rendezvous and proximity operations technology components from the same suppliers. The demands of the Hubble mission may be marginally more difficult or complicated than the circumstances that will be tested out on the prior missions (e.g., possibly, in the worst case scenario in which Hubble is "tumbling," although even in this case the rate of tumble would be actually very slow).

In other words, the technical and operational risk associated with autonomous rendezvous technology and procedures is the smallest possible incremental step forward, but since the Hubble mission will be an operational mission and not a demonstration mission like its predecessors, the Hubble mission will nonetheless serve as a critical opportunity for advancement.

Unmanned capture. The Hubble mission will use its grapple arm to perform the final capture and berthing of servicing spacecraft to the space telescope. Proven predecessor procedures will include:

- the use of an essentially identical grapple arm (the Shuttle arm) to grab the grapple fixture on the Hubble
 - the incremental step forward is astronaut control from the ground instead of the adjacent Shuttle
- ground control of orbital robotics on Space Station (demonstrated February 2005)
 - very similar to the Hubble requirements
- autonomous grapple-arm capture of a target vehicle in Orbital Express
 - although the target vehicle is designed to be "cooperative," in some way (e.g., the grapple fixture with targets) so is the Hubble

In summary, although the unmanned capture of the Hubble will be a significant operational demonstration, in practice it represents the smallest possible step forwards over prior operations and tests.

Dexterous Servicing with Tools. It appears that the schedule requirements of the Hubble mission will require Dextre's first use on-orbit to be for the Hubble rather than the originally planned servicing operations on the Space Station. However, even here there is or will have been important prior art, including:

- dexterous robotic servicing operations on the Orbital Express mission, including Orbital Replacement Unit swaps (e.g., like Wide Field Camera)
 - incremental step forward is the use of the more capable Dextre, although the principles and procedures will be similar
- Hubble servicing operations using tools, as performed by astronauts
 - Incremental step is having Dextre's "hand" hold and operate the tools (controlled by astronauts), instead of having the astronaut hold the tools directly
- Hubble robotic servicing operations, using high fidelity mockup and terrestrial version of Dextre
 - Each and every necessary operational procedure has now been tested on the ground. The only thing left to do is fly the mission.

Again, in summary, although the overall achievement of robotically servicing Hubble will be an impressive operational step forward, we see that nearly all the prior risk mitigating steps that can be imagined will have in fact been done, and that as a result the incremental risk has been minimized.

Risk Mitigation Approach

The overall Risk Mitigation Approach for the Mission has been developed from all of the experienced gained from satellite servicing missions—beginning with Solar Max Repair Mission in 1984 and continuing through WESTAR/PALAPA, Syncom IV, Intelsat, and then the four Hubble Repair Missions. Although there are many specific steps and test activities associated with the robotic servicing plan, it can be boiled down into one single formula for mission success. This formula was employed and maintained on the HST from the first mission through this specific mission and it is: "Test, Test, and Retest. Train, Train, and Retrain."

Specifically dealing with the question of what will give us confidence that the mechanical systems (such as latches, berthing, pins and mechanisms) will fit together when robotically mated in space, the Project will test all mating interfaces with Hubble including Berthing and Latching robotic interfaces using the family of Hi Fidelity Mechanical Simulators in the GSFC Test Facility. These simulators have been validated to be accurate by virtue of the four previous Servicing Missions whereby each of the Critical Interfaces were employed. Master tooling and gages have been revalidated with the returned hardware from space on each of the four Servicing Missions. The Project will use this tooling and Hi Fidelity Simulators to check this system before shipment to KSC for launch.

In addition, to reduce the risk of Approach, Rendezvous, and Capture in the orbit dynamics and day/night aspects, the Project is teamed with MSFC to conduct a series of capture Dynamics Test, Lighting Tests, and Grapple Tests. MSFC facilities will use the actual flight hardware and software elements. This will be done prior to launch as a key part of our Risk Mitigation effort. With increasing degrees of sophistication, these types of tests will first be conducted at MDA, then GSFSC, and finally MSFC. In a similar manner, Approach and Rendezvous Sensors will be tested on several earlier flights such as DART, XSS-11, and a Space Station DTO being conducted in partnership with JSC. Again, these tests are in addition to tests both at vendor's plants and GSFC. The consistent philosophy for all major elements of the Mission is "Test, Test, and Retest."

Question submitted by Representative Bart Gordon

Q1. The Goddard robotic servicing project assumes that the entire mission (not just the robotics system) will be developed within 39 months in order to get to Hubble before it fails. That would imply that the project is allowing only eight months after the robotic system is scheduled to show up to integrate it into the rest of the spacecraft, test the integrated system and software, and prepare the entire spacecraft for launch. Why do you believe that is sufficient time for such a complex set of tasks?

A1. There are two aspects to this question of schedule. The first aspect deals with the question of hardware development and having ample Integration and Test time in a 39-month program. The second question deals with the expected life of the

Hubble Space Telescope and the related question that if the development cycle is delayed, will there be enough time to repair HST before its demise.

Dealing with the aspect of ample development Integration and Test time, the following points need to be made. The major Critical Hardware elements selected for this Program already have been developed. In many cases, the hardware already exists and is being physically transferred to the Program. Such Critical elements as the SPDM Robot, the Grapple Arm, the Grapple End Effector, the Scientific Instruments, the X-38 Propulsion Module, many software elements for the spacecraft (coming from the Mars Reconnaissance Orbiter Program), and components from the Rapid Spacecraft Development Program have been selected to hasten hardware build. From an Integration and Test perspective, the Program has taken the lessons learned from the four earlier Hubble Servicing Missions, and especially the first Hubble Servicing Mission—started and flown in less than 37 months.

The key to all these past missions, including aspects of the Mars Exploration Rover Mission (36-month development and flight cycle) and the Mars Reconnaissance Orbiter Program, was the extensive use of ground test simulators. These simulators are used for all elements of Integration and Testing including software development, structural dynamics, guidance and navigation, zero G testing of robotic activities, etc.

The Program is now six months old, and many of these simulators have been completed and are undergoing checkout at GSFC and University of Maryland Water Tank. Within three more months, these simulators will be used to check out flight software, guidance and navigation algorithms, flight robotic tools, spacecraft lighting, operations procedures, spacecraft harness layouts, etc. Six of these simulators have already been delivered to the GSFC I&T Facility. Through the use of these simulations, Integration activities will start in the next eight months, giving more than an 18-month Integration and Test window before flight.

Dealing with this issue of Hubble life on orbit, one has to remember that there are two elements of HST's life—Scientific Operation Life Expectancy and then the Ultimate Safe Hold Life Expectancy. The Scientific Life Expectancy is driven by the useful life of the gyroscopes on board and present projections are about mid-2008 for loss of gyroscopic precision pointing. After that the spacecraft can be put in a standby (safe hold mode) for another 12 months, waiting for replacement hardware. This extra 12 months is estimated by current battery life projections. Up to that point, the spacecraft can be serviced and returned to full science operations as was done on HST Servicing Mission 3A. At that time, the gyroscopes failed four months before the actual mission.

The point here is that there is a contingency in Hubble's life expectancy to accommodate launch delays—for what ever reason. However, by picking a deliberately tight development schedule, we are not "burning up runway before take-off." By holding to a quick start and tight schedule pressures, the capability to use the contingency later, if and when it is really needed, has been preserved. Furthermore, it saves cost since it take advantage of the people knowledge and skills already on the Program and it holds the program run-out time to a minimum.

ANSWERS TO POST-HEARING QUESTIONS

Responses by Colin A. Norman, Professor of Physics and Astronomy, Johns Hopkins University

Question submitted by Chairman Sherwood L. Boehlert

Q1. If funding for a Hubble Origins Probe were to come at the expense of the timely launch of the James Webb Space Telescope or other priorities identified in the most recent Decadal Survey, would you still believe it should be funded?

A1. If the crucial decision whether to extend Hubble Science or not eventually came to depend on the availability of funding for the Hubble Origins Probe (and presumably this would only occur if manned and robotic servicing proved unfeasible) then the case should be peer-reviewed thoroughly and promptly by the Academy with very careful consideration given to the existing Decadal Survey and its existing priorities.

Questions submitted by Representative Bart Gordon

Q1. Dr. Norman, it appears that the enhanced scientific capability of your Hubble Origins Probe is critically dependent on the inclusion of the Very Wide Field Imager (VWFI).

Q1a. Does this instrument currently exist as space-qualified hardware or would it have to be developed?

A1a. This instrument does not exist as space-qualified hardware, and it has to be developed but it is worth emphasizing that the VWFI design consists of space-qualified devices and highly reliable components.

Q1b. Your proposal indicates that the Japanese would provide the VWFI. Has the Japanese government agreed to fund the development of the instrument?

A1b. The Japanese government has not yet agreed to fund the development of the instrument. But, our Japanese colleagues have submitted the mission proposal to the Japanese space agency JAXA. Our understanding is the JAXA will make their best effort to support the U.S.-led HOP mission.

Q1c. Have the Japanese ever developed and flown a comparable imager in space or would this be a new development?

A1c. There have been excellent collaborations between NASA and the Japanese space agency especially in X-ray astronomy and in solar physics. A comparable imager is the 50cm diffraction-limited visible light telescope developed by the National Astronomical Observatory of Japan aboard the JAXA–NASA Solar-B mission. NASA provided the focal plane package for the telescope.

Q1d. New instrument developments are typically complex undertakings. What amount of slack do you have in your mission schedule to accommodate any possible delays with the instrument?

A1d. Six months of reserve are allocated in the four-year long development schedule for VWFI. This is the primary slack allocated to accommodate possible delays in the instrument. However, there is another two weeks of reserve in the spacecraft-to-instrument two-month long integration schedule. This allows for the possibility of VWFI acceptance at a slightly later than nominal date. There is additionally four months of schedule reserve allocated in the 13-month system-level integration and test span. This enables late insertion of the VWFI during ambient functional testing or prior to space vehicle Thermal Vacuum/Thermal Balance testing.

Q1e. Would you fly Hubble Origins Probe without the VWFI if the instrument were delayed in its development?

A1e. We would make every effort to fly HOP with the VWFI unless there were very significant delays, because of the very strong science enhancement the VWFI provides. We do not anticipate any significant delays.

Appendix 2:

ADDITIONAL MATERIAL FOR THE RECORD

STATEMENT OF THE INSTITUTE OF ELECTRICAL AND ELECTRONICS ENGINEERS—
UNITED STATES OF AMERICA (IEEE–USA)

Concerning the Hubble Space Telescope

IEEE–USA appreciates this opportunity to share our views on the need for continued support of the Hubble Space Telescope for this hearing of the House Science Committee. As an organization of engineers and technical professionals, we support exploring all possible avenues to prolong the useful life of the Hubble telescope for the benefit of science and humanity.

IEEE–USA believes that NASA's benefit and risk analyses should consider the future scientific value of maintaining the Hubble and that the public should be informed about the considerations and tradeoffs considered in making a final decision on a service mission to the HST. To this end, IEEE–USA recommends that:

- NASA should continue planning and preparing for the SM–4 servicing mission.
- In consultation with other government agencies, external experts, and the National Research Council, NASA should strive to develop procedures, technology and equipment that would allow the safe servicing of the HST.

The Hubble Space Telescope (HST) is a 2.4-meter reflecting telescope, which was deployed in low-Earth orbit (600 kilometers) by the crew of the Space Shuttle Discovery on 25 April 1990. HST is a cooperative program of the European Space Agency and the National Aeronautics and Space Administration (NASA) to operate a long-lived space-based observatory for the benefit of the international astronomical community. HST's location above the Earth's atmosphere allows its scientific instruments (cameras, spectrographs and other sensors) to acquire high-resolution images of astronomical objects.

The Hubble Space Telescope (HST) is a 2.4-meter reflecting telescope, which was deployed in low-Earth orbit (600 kilometers) by the crew of the Space Shuttle Discovery on 25 April 1990. HST is a cooperative program of the European Space Agency and the National Aeronautics and Space Administration (NASA) to operate a long-lived space-based observatory for the benefit of the international astronomical community. HST's location above the Earth's atmosphere allows its scientific instruments (cameras, spectrographs and other sensors) to acquire high-resolution images of astronomical objects.

Since its launch, the Hubble telescope has provided astronomers and humanity with measurements that provided, among other results, fundamental new results in planetary science; discovery of the most distant object in the solar system; more accurate estimates of the age of the universe; better measurements of the universe's rate of expansion; the deepest portrait of the visible universe ever achieved by humankind; the discovery of new stars and dynamic phenomena in space; and new views of comets and black holes.

The planned James Webb Space Telescope will eventually provide a new capability for scientific research, but will not launch until 2011, at the earliest. Prospects for continued operation of Hubble until that date without a servicing mission are small. The absence of the Hubble's extraordinary abilities would adversely impact astronomical research. Maintaining the Hubble will accommodate any delays in the Webb Space Telescope. And having both telescopes on the station until the Hubble concludes its mission will increase space research capacity.

IEEE–USA is an organizational unit of the IEEE. It was created in 1973 to advance the public good and promote the careers and public-policy interests of the more than 225,000 technology professionals who are U.S. members of the IEEE. The IEEE is the world's largest technical professional society. For more information, go to <http://www.ieeeusa.org>.