

Paragraph 6002 Class E Airspace Areas Designated as a Surface Area.

* * * * *

ANM CO E2 Aurora, CO [Amended]

Buckley Space Force Base, CO
(Lat. 39°42'06" N, long. 104°45'07" W)
Denver International Airport, CO
(Lat. 39°51'42" N, long. 104°40'23" W)
Centennial Airport, CO
(Lat. 39°34'12" N, long. 104°50'57" W)

That airspace extending upward from the surface to but not including 7,500 feet MSL within a 4.4-mile radius of the airport, within 2 miles northeast and 4 miles southwest of the airport's 151° bearing extending to 7.1 miles southeast, and within 4 miles south and 4.4 miles north of the airport's 270° bearing extending to 4.7 miles west, excluding that airspace within the Denver International Airport, CO, Class B and Centennial Airport, CO, Class D airspace areas. This Class E airspace area is effective during the specific dates and times established in advance by a Notice to Air Missions. The effective date and time will thereafter be continuously published in the Chart Supplement.

* * * * *

Paragraph 6004 Class E Airspace Areas Designated as an Extension to a Class D or Class E Surface Area.

* * * * *

ANM CO E4 Aurora, CO [Removed]

Aurora, Buckley ANG Base, CO
(Lat. 39°42'06" N, long. 104°45'07" W)

* * * * *

Issued in Des Moines, Washington, August 30, 2024.

B.G. Chew,

Group Manager, Operations Support Group, Western Service Center.

[FR Doc. 2024-20197 Filed 9-6-24; 8:45 am]

BILLING CODE 4910-13-P

CONSUMER PRODUCT SAFETY COMMISSION

16 CFR Parts 1112 and 1250

[CPSC Docket No. CPSC-2024-0027]

Safety Standard for Toys: Requirements for Water Beads

AGENCY: Consumer Product Safety Commission.

ACTION: Notice of proposed rulemaking.

SUMMARY: The Consumer Product Safety Improvement Act of 2008 (CPSIA) mandates that ASTM F963 shall be a mandatory toy safety standard. This safety standard sets forth requirements

for water bead toys and toys that contain water beads. The U.S. Consumer Product Safety Commission (CPSC) proposes to establish additional performance and labeling requirements for these products. The Commission also proposes to amend CPSC's list of notice of requirements (NORs) to include water bead toys and toys that contain water beads.

DATES: Submit comments by November 8, 2024.

ADDRESSES: Submit all comments, identified by Docket No. CPSC-2024-0027, by any of the following methods:

Electronic Submissions: Submit electronic comments to the Federal eRulemaking Portal at: <https://www.regulations.gov>. Follow the instructions for submitting comments. Do not submit through this website: confidential business information, trade secret information, or other sensitive or protected information that you do not want to be available to the public. CPSC typically does not accept comments submitted by email, except as described below.

Mail/Hand Delivery/Courier/Confidential Written Submissions: CPSC encourages you to submit electronic comments by using the Federal eRulemaking Portal. You may, however, submit comments by mail, hand delivery, or courier to: Office of the Secretary, Consumer Product Safety Commission, 4330 East-West Highway, Bethesda, MD 20814; telephone: (301) 504-7479. If you wish to submit confidential business information, trade secret information, or other sensitive or protected information that you do not want to be available to the public, you may submit such comments by mail, hand delivery, or courier, or you may email them to: cpsc-os@cpsc.gov.

Instructions: All submissions must include the agency name and docket number. CPSC may post all comments without change, including any personal identifiers, contact information, or other personal information provided, to <https://www.regulations.gov>. Do not submit through this website: Confidential business information, trade secret information, or other sensitive or protected information that you do not want to be available to the public. If you wish to submit such information, please submit it according to the instructions for mail/hand delivery/courier/confidential written submissions.

Docket: For access to the docket to read background documents or comments received, go to: <https://www.regulations.gov>, and insert the docket number, CPSC-2024-0027, into

the "Search" box, and follow the prompts.

FOR FURTHER INFORMATION CONTACT: Matthew Kresse, Project Manager, Division of Mechanical Engineering, Directorate for Laboratory Sciences, Consumer Product Safety Commission, 5 Research Place, Rockville, MD 20850; Telephone 301-987-2222; email: mkresse@cpsc.gov.

SUPPLEMENTARY INFORMATION:

I. Background and Statutory Authority

Section 106(a) of the Consumer Product Safety Improvement Act of 2008 (CPSIA) made ASTM International's (ASTM) voluntary standard for toys, ASTM F963-07, *Standard Consumer Safety Specification for Toy Safety* (except section 4.2 and Annex 4), a mandatory safety standard for toys beginning 180 days after the enactment date of the CPSIA. 15 U.S.C. 2056b(a). The CPSIA states that ASTM F963 shall be considered a consumer product safety standard issued by the Commission under section 9 of the Consumer Product Safety Act (15 U.S.C. 2058). Since 2009, CPSC has enforced ASTM F963 as a mandatory standard for toys.^{1 2} In 2017, the Commission established 16 CFR part 1250, *Safety Standard Mandating ASTM F963 for Toys*, and it incorporated by reference the newly revised ASTM standard at that time, ASTM F963-16. 82 FR 8989 (Feb. 2, 2017). Most recently, on January 18, 2024, the Commission updated part 1250 to incorporate by reference a 2023 revision, ASTM F963-23. 89 FR 3344.

Section 4.40 of ASTM F963-23 includes requirements for toys, including but not limited to water beads, that are made of "Expanding Materials."³ However, the requirements currently in ASTM F963-23 for this category of toys appear insufficient to address all known water bead hazards. Potential hazards for "Expanding Materials" in general include gastrointestinal tract blockage if a child ingests a product comprised of expanding materials. Hazard mitigation provisions in ASTM F963-23 include performance requirements, but do not include warnings or instructional literature specifically tailored to the

¹ Since 2009, ASTM revised F963 five times: ASTM F963-08, ASTM F963-11, ASTM F963-16, ASTM F963-17, and ASTM F963-23 (approved August 1, 2023).

² Section 3.1.91 of ASTM F963-23 (Toy): "Any object designed, manufactured, or marketed as a plaything for children under 14 years of age."

³ Under ASTM F963, "Expanding Materials" are defined as "any material used in a toy which expands greater than 50% in any dimension from its as-received state."

“Expanding Materials” requirements. While sections 5, 6, and 7 of ASTM F963–23 provide “Labeling Requirements,” “Instructional Literature” requirements, and “Producer’s Markings” requirements generally for toys under the standard, none of these requirements is directed to water beads specifically. Thus, the generalized warnings and instructional literature requirements do not address all known hazards.

Incident data, described in section III of this preamble, demonstrate that children ingest water beads, aspirate and choke on them, or insert them into the nose or ear, and subsequently suffer injury or death. Staff’s testing of water beads, described in section IV of this preamble, further demonstrates that tested water beads that pass the performance requirements in ASTM F963–23 can still pose safety hazards. Accordingly, this notice of proposed rulemaking (NPR) under section 106 of the CPSIA proposes additional requirements in part 1250 to establish mandatory requirements specifically for water beads.⁴ Further, this NPR proposes revising the title of part 1250 from “Safety Standard Mandating ASTM F963 for Toys” to “Safety Standard for Toys,” to reflect the inclusion of proposed requirements that do not incorporate by reference existing requirements in ASTM F963.^{5 6}

The Commission is authorized to issue this NPR pursuant to both section 106(c) and (d) of the CPSIA, 15 U.S.C. 2056b(c) and (d). Section 106(c) requires

the Commission to periodically review and revise its mandatory toy safety standards to ensure that such standards provide the highest level of safety for toys that is feasible. Section 106(d) further requires the Commission to examine and assess the effectiveness of its mandatory toy safety standards in protecting children from safety hazards, and then it must promulgate consumer product safety rules that are more stringent than the existing standards if the Commission determines that more stringent standards would further reduce the risk of injury associated with such toys. Consistent with the consultation requirement in section 106(d)(1) of the CPSIA, staff has worked with the ASTM F15.22 subcommittee task group since 2009 to update the toy standard and discuss hazards associated with water beads. This consultation, including sharing staff’s assessment of hazards and suggested additional performance and labeling requirements, continued through revision and publication of ASTM F963–23.

Building on staff’s continued collaboration with ASTM and in consideration of the incident data, the Commission is issuing this NPR to address four identified hazard patterns associated with water beads that are not adequately addressed by the current mandatory standard provisions addressing Expanding Materials: (1) ingestion of water beads, (2) insertion of water beads into the nose or ear, (3) aspiration due to water beads, and (4) choking due to water beads. The Commission proposes adding additional performance requirements to part 1250 to better address these risks. The NPR also proposes establishing acrylamide level limits for water beads, which may contain this toxic chemical, and implementing new testing for water beads under part 1250 to limit acrylamide in water beads in response to toxicity hazards when they enter the body. Finally, the Commission proposes labeling requirements for water beads under part 1250, including mandating warnings on products and instructional literature within scope of the rule.

This NPR provides an overview of staff’s assessment and analysis, and it includes the Commission’s basis for issuing the proposed rule. For the

reasons explained here, the Commission preliminarily determines that the proposed water bead requirements comply with section 106 of the CPSIA because they are more stringent than the current requirements in ASTM F963–23, would further reduce the risk of injury and death associated with products within the scope of the NPR, and would provide the highest level of safety that is feasible for such products. The Commission seeks comment on these issues.

II. The Product

A. Description of the Product

Water beads are various shaped, multi-colored or clear beads composed of water absorbing polymers, such as polyacrylamides and polyacrylates, which expand when soaked in liquid such as water. When first purchased, water beads are small and dehydrated, typically no larger than 7.0 mm diameter. The beads are often sold in large quantity packages that may contain up to thousands of beads (depending on original size) in one package. While in the dehydrated state, with all water content removed, water beads are typically either hard, solid beads, or soft-gelled beads. Water beads are designed to be soaked in water, which allows the beads to absorb the water and expand. After being soaked in water for periods as short as a few hours for smaller water beads or two to three days for larger water beads, water beads multiply in size, as demonstrated in Figure 1. Some water beads can expand, for example, from 2.0 mm diameter in their dehydrated state to 16.0 mm diameter when fully expanded (shown on the left in Figure 1), or from 7.0 mm diameter in the dehydrated state to 50.0 mm diameter when fully expanded (shown on the right in Figure 1). Thus, water beads have the potential to expand up to 800 percent of their original size. Once expanded, water beads remain moist even if removed from water but do not appear to have any adhesive properties that would cause them to stick together. When broken apart by hand or squeezing, expanded water beads tend to break into small, fragmented pieces (shown in Figure 2).

⁴ <https://www.cpsc.gov/content/FY-2024-Operating-Plan>.

⁵ On August 21, 2024, the Commission voted unanimously (5–0) to publish this NPR.

⁶ The information in this proposed rule is based in part on information and analysis in the July 31, 2024 Memorandum, Staff’s Draft Proposed Rule for Safety Standard for Toys: Requirements for Water Beads, available at: https://www.bing.com/ck/a?!&rp=fcf3dff1c5f81972JmltdHM9MTcyNDI4NDgwMCZpZ3VpZD0wMDIhOTVlYi01OTI3LTlywZDYtMzEzYy04MTY1NTg2ODYxNGMmaW5zaWQ9NTIwNA&ptn=3&ver=2&hsh=3&fclid=009a95eb592760d6313c81655868614c&psq=Staff%e2%80%99s+Draft+Proposed+Rule+for+Safety+Standard+for+Toys%3a+Requirements+for+Water+Beads&u=a1aHR0cHM6Ly93d3cuY3BzYy5nb3YvczNmcy1wdWJsaWMvTm90aWNILW9mLVByb3Bvc2VklVJ1bGVtYWtpbmctUmVxdWlyZW1lbnRzLWZvc11XYXRlci1CZWFKcy5wZGY_VmVyc2lvbkklPTNreHZNemVNcElSSEphS1Eza25BNEczNnFwwjZFeVNP&ntb=1.

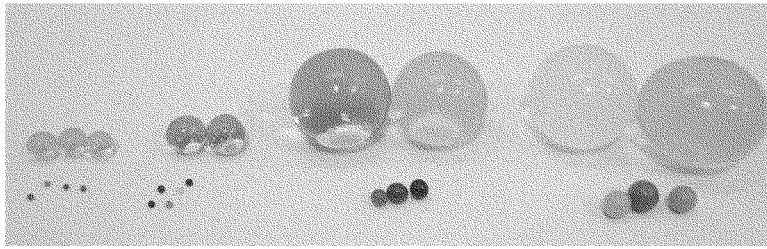

Figure 1: Water Beads, Before and After Expansion.

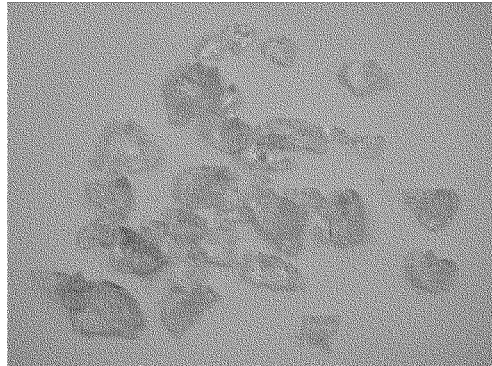

Figure 2: Water Beads, After Being Squeezed and Breaking.

Water beads are often sold in bulk or as part of other children's toys, such as experiment kits and sensory kits, or can be contained within toy squeeze balls or stress balls. Some water beads are not marketed as children's toys and are outside of the scope of this proposed rule.

As noted, CPSC currently regulates water beads under section 4.40 of ASTM F963–23, *Expanding Materials*, and 16 CFR 1250.2(a). ASTM F963–23 does not define the term “water beads,” but it defines an “Expanding Material” in section 3.1.28 as “any material used in a toy which expands greater than 50% in any dimension from its as-received state when tested in accordance with 8.30.” Section 8.30 directs that the toy must be submerged in deionized water maintained at $37\text{ }^{\circ}\text{C} \pm 2\text{ }^{\circ}\text{C}$ for a duration

of 72 hours, with the toy dimensions measured at 6-, 24-, 48- and 72-hour intervals in order to determine if the toy is an expanding material. CPSC proposes establishing a definition for “water bead(s)” under part 1250 as “various shaped, water absorbent polymers, such as, but not limited to polyacrylamides and polyacrylates, which expand when soaked in water.” CPSC proposes to incorporate ASTM's process for conditioning water bead in the proposed rule test procedures.

B. Scope of Products Within the NPR

This NPR would apply both to water bead toys and toys that contain water beads. A toy is “any object designed, manufactured, or marketed as a plaything for children under 14 years of age.” 16 CFR 1250.2(a); section 3.1.92 of

ASTM F963–23. Water bead toys therefore are water beads marketed as a plaything for children under 14 years of age (consistent with the definition of a “toy” in 16 CFR 1250.2(a)), while toys that contain water beads are toys that encompass water beads within the toy and the water beads are not intended to be accessed, such as a squeeze ball (Figure 5). Commonly, water beads are included in a variety of toy products, such as toy experiment kits (Figure 3), toy sensory kits (Figure 4), toy squeeze/sensory balls filled with water beads (Figure 5), and toy water pellet guns designed to shoot water bead projectiles (Figure 6). Each product would be subject to the proposed rule and would need to meet the requirements of a final rule.

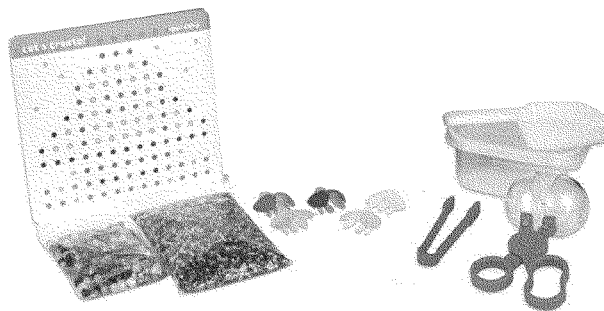

Figure 3: Toy Experiment Kit.

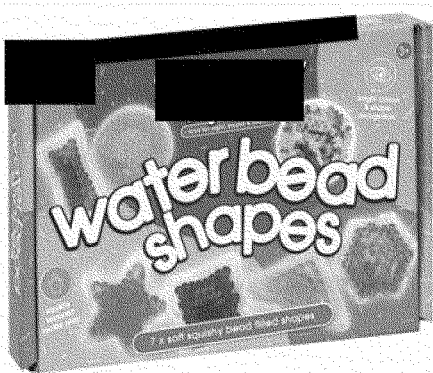

Figure 4: Toy Sensory Kit.

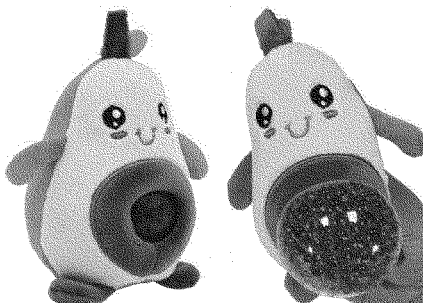

Figure 5: Toy Squeeze/Sensory Ball.



Figure 6: Toy Water Bead Pellet Gun.

Examples of products outside of the scope of this proposed rule are water beads that are not toys or are not contained in toys and are for various

non-toy uses, such as water beads used for decorative purposes (e.g., placement in candle holders), in vases or gardens for plant hydration, as air freshener

products or deodorizers for cat litter, and in first-aid cold packs.

III. Incident Data and Hazard Patterns

CPSC staff searched two CPSC-maintained databases to identify incidents and hazard patterns associated with water beads: the Consumer Product Safety Risk Management System (CPSRMS)⁷ and the National Electronic Injury Surveillance System (NEISS).^{8,9} Due to data availability, the CPSRMS incidents occurred between January 1, 2017, and December 31, 2023, while the NEISS incidents occurred between January 1, 2017, and December 31, 2022.

A. CPSRMS Data

From 2017 through 2023, CPSC identified 64 incidents in CPSRMS associated with the use of water beads. One incident resulted in a fatality, while 27 incidents led to hospitalization; 15 incidents led to emergency department (ED) treatment; and seven incidents led to care by a medical professional. The remaining 14 incident reports noted possible but uncertain medical treatment, or the level of care was unreported. Of the reported incidents that indicate a child's age, children's ages range from 9 months old to 11 years old, with one incident involving a 22-year-old woman with special needs.

⁷ CPSRMS includes data primarily from three groups of sources: incident reports, death certificates, and in-depth follow-up investigation reports. A large portion of CPSRMS consists of incident reports from consumer complaints, media reports, medical examiner or coroner reports, retailer or manufacturer reports (incident reports received from a retailer or manufacturer involving a product they sell or make), safety advocacy groups, law firms, and federal, state, or local authorities, among others. It also contains death certificates that CPSC purchases from all 50 states, based on selected external cause of death codes (ICD-10). The third major component of CPSRMS is the collection of in-depth follow-up investigation reports. Based on the incident reports, death certificates, or NEISS injury reports, CPSC field staff conduct in-depth investigations (on-site, telephone, or online) of incidents, deaths, and injuries, which are then stored in CPSRMS.

⁸ NEISS is the source of the injury estimates; it is a statistically valid injury surveillance system. NEISS injury data are gathered from emergency departments of a sample of hospitals, with 24-hour emergency departments and at least six beds, selected as a probability sample of all U.S. hospitals. The surveillance data gathered from the sample hospitals enable CPSC to make timely national estimates of the number of injuries associated with specific consumer products.

⁹ CPSC staff performed multiple searches consisting of a combination of product codes and narrative or manufacturer/model keyword searches to find water bead incidents. Staff extracted data coded under 1381 (Toys, not elsewhere classified), 1395 (Toys, not specified), 1413 (Greenhouse supplies or gardening supplies [excluding plant stands, tools, hoses, sprayers and chemicals]), 1616 (Jewelry [excluding watches]), 1682 (Hair curlers, curling irons, clips & hairpins), 5016 (Balls, other or not specified), 5020 (Pretend electronics, tools, housewares, and appliances), 9101 (No clerical coding—retailer report), and 9102 (No clerical coding—retailer report).

Staff identified the following incident data hazard patterns.

1. Ingestion

In 52 reported incidents, a child ingested or likely ingested at least one water bead.¹⁰ Of those reports, 47 incidents involved a child ingesting at least one water bead, while five incidents involved a likely ingestion. Where reported, children between the ages of 9 months old and 5 years old ingested or likely ingested the water beads. Incidents included one death, 23 hospitalizations, 12 ED treatments, four visits to a medical professional, and 12 instances where the level of care was uncertain. The fatality involved a child swallowing at least one water bead. Specifically, in CPSC In-Depth Investigation (IDI)¹¹ 230727CBB1846, a 10-month-old female was discovered unresponsive after consuming at least one water bead. The medical examiner determined that the child died from complications after a water bead expanded and caused a small intestine obstruction.¹²

In 22 reported incidents, an ingested water bead caused a bowel obstruction because the water bead expanded to a size that did not naturally pass through the gastrointestinal tract. After ingestion, water beads do not remain in the stomach for an extended period, which limits the potential for the water bead to expand in the stomach. Water beads can expand fully once they pass from the stomach and into the small intestine because water beads remain in the small intestine for a longer period and are able to absorb liquid like the water in which they are designed to absorb and expand. After expansion, water beads can become too large to pass from the small intestine to the large intestine and instead form a bowel obstruction.

Swallowing a water bead presents different hazards than swallowing a smooth, solid object such as a marble because an object like a marble will not grow after being swallowed. Marbles and other smooth, solid objects can frequently also be located and identified

by x-ray due to their density, unlike water beads, as discussed further below. Once located, marbles can be removed endoscopically if reported early enough, especially if they appear to be too large to pass through the stomach or the remainder of the digestive track, whereas water beads can remain small within the stomach and then grow larger, then causing a small bowel obstruction.

Vomiting and coughing are commonly reported initial symptoms that occur after a water bead is first ingested.¹³ Lethargy, distress, dehydration, loss of appetite, fever, fatigue, and abdominal pain are also reported when an expanded water bead blocks the small intestine.

Medical providers may misdiagnose water bead ingestion symptoms because the symptoms are ambiguous and may be attributable to medical conditions or sources other than water bead ingestion, such as gastrointestinal illness. Further, caregivers may be unaware a child ingested a water bead and, therefore, are unable to report the ingestion. Children commonly visit medical care providers multiple times before diagnosis of a water bead ingestion. For example, in IDI 220511HCC3859, a 14-month-old female was initially diagnosed with gastrointestinal illness after episodes of vomiting. The child was taken first to a pediatrician and then to a local ED where she was treated with intravenous fluids and released. Only after the child was taken to a second ED once her condition worsened was it discovered that she had ingested a water bead.¹⁴

In some cases, small water beads pass naturally, as can be the case when other small foreign objects are ingested, such as coins and small toy parts.¹⁵ For example, in IDI 230707CBB1698, a 3-year-old female ingested approximately 1,200 small water beads (approximately 1 tablespoon before expansion). The child successfully passed all water beads through her digestive system with the aid of a mineral oil enema.¹⁶

Medical providers may also not know that ingested water beads can cause

¹³ Forrester MB. Pediatric Orbeez Ingestions Reported to Texas Poison Centers. *Pediatr Emerg Care*. 2019 Jun;35(6):426–427. doi: 10.1097/PEC.0000000000001227. PMID: 28697162.

¹⁴ Size of expanded water bead not provided. Samples of the product showed full expansion being between 45 mm and 50 mm in diameter.

¹⁵ Mehmetoğlu F. A Retrospective 10-Year Analysis of Water Absorbent Bead Ingestion in Children. *Emerg Med Int*. 2018 May 6;2018:5910527. doi: 10.1155/2018/5910527. PMID: 29854461; PMCID: PMC5960561.

¹⁶ Size of expanded water beads not provided. However, samples of the product that staff collected for testing shows full expansion being between 9.32 mm and 15.20 mm in diameter.

¹⁰ In several cases where a child likely ingested water beads, a caregiver saw a child put a water bead in his or her mouth, yet the presumably ingested water bead was not found. The water bead could have passed naturally, or the child never swallowed the water bead. Still, medical intervention had been sought in some incidents.

¹¹ IDIs are CPSC-generated investigation summaries of events surrounding product-related injuries or incidents. Based on victim/witness interviews, the reports provide details about incident sequence, human behavior, and product involvement.

¹² Water bead obstruction was measured to be "approximately 2.8 x 2.8 x 2.8 cm [or 28 x 28 x 28 mm]."

bowel obstructions. Therefore, although a medical provider is aware that a child ingested a water bead, they may send a patient home to digest or naturally pass the water bead, not knowing that may be impossible and the ingestion may result in injury or death. Water beads that do not pass naturally through the digestive tract can sometimes be removed by endoscopy or colonoscopy. However, such medical procedures routinely require sedation or general anesthesia, which carry risks of side effects and complications. For example, in IDI 230613CBB1591, a 2-year-old male swallowed at least two water beads and was examined and released from an ED without intervention. The child was later admitted to a different hospital where a water bead was removed via endoscopy. The child required a third hospital visit to remove a second water bead via colonoscopy.¹⁷

Water beads that do not pass naturally or cannot be removed can result in small bowel obstructions. Children experiencing a small bowel obstruction have required invasive exploratory laparotomy with small intestine enterotomy¹⁸ under general anesthesia to remove any ingested water beads. For example, in IDI 170802CCC3140, a 13-month-old female became ill after ingesting a water bead. The water bead expanded in her small intestine, causing a blockage. She was transported to a hospital where the water bead was surgically removed under general anesthesia with an exploratory laparotomy and enterotomy.¹⁹

A delay between the time a caregiver or medical provider discovers that a child has ingested a water bead and when the child receives appropriate medical treatment may increase the risk of severe injury or death. Prompt recognition that a child has ingested a water bead enables swift medical treatment and removal of the water bead before the water bead expands, causing gastrointestinal blockages. However, due to the small size of individual water beads, caregivers may not know that a child has swallowed a water bead, so early intervention may not be possible. Even after a child begins to receive medical care, medical providers may have difficulty locating an ingested water bead inside the body because

water beads are radiolucent.²⁰ Radiolucent water beads are not easily identified using routine x-ray radiography because they are not dense, appearing dark or black and almost entirely transparent when the x-ray beam passes through the bead. Incident data and medical literature report children requiring serial x-rays, computer tomography (CT) scans, and ultrasounds to accurately diagnose a water bead bowel obstruction.²¹

Other possible medical outcomes that can occur from a child ingesting water beads include surgery site infection, sepsis, extended hospital stays, and follow up surgeries. For example:

- In IDI 221107CFE0002, a 9-month-old child required five surgeries to remove the small bowel obstruction and treat complications from the initial surgery.²²
- In IDI 220701HFE0002, a 14-month-old child required a second surgery and a small bowel resection at the site of the previous enterotomy after the initial surgery failed to remove all ingested water beads.²³

When reviewing the incident data and conducting laboratory testing, CPSC staff has not identified evidence of water beads sticking together once fully expanded within the gastrointestinal tract to form a congealed water bead mass that is more difficult to pass than individual beads. In an effort to diligently address all potential water bead ingestion hazards, though, CPSC is requesting comment on whether any toy water bead products present adhesive properties that would allow water beads to stick together.

2. Ear Insertion

CPSRMS contains five reports of victims presenting with water beads in the ear canal. All five of the incidents required medical intervention, while two of the five incidents required hospitalization. When reported, children's ages ranged from 3 years old to 9 years old. One incident involved a 22-year-old woman with special needs.

Ear canal insertions are not uncommon for healthcare providers to treat in hospital EDs. Common inserted objects include plastic beads, small toy parts, pebbles, and pieces of food. Many

such cases are evaluated, then treated with irrigation or suction of the ear canal, or using surgical instrumentation, such as forceps or hooks.²⁴ However, it is uniquely challenging to remove water beads from the ear canal.²⁵ For example, water beads should not be removed using irrigation because exposure to water may cause the beads to expand. Medical providers may attempt to remove water beads with tools, but water beads can break during a removal attempt or if a removal attempt fails. Under those circumstances, surgery under sedation or general anesthesia may be necessary to remove water bead fragments. Further, because water beads are radiolucent (*i.e.*, transparent to x-rays) and thus difficult for medical providers to locate and identify, confirmation that a water bead is in the ear canal before attempting removal is difficult. Although medical providers can typically see that something is in the ear canal, x-ray or other imaging technology such as a CT scan are often used to attempt to confirm the object in the ear canal is in fact a water bead, as opposed to a cyst or other object. Because water beads can be difficult to identify on x-rays and the symptoms are ambiguous, cases of insertions into the ear canal have been misdiagnosed as ear infections and treated with topical antibiotics, which can lead to enlargement of the bead and further damage to the ear canal. For similar reasons regarding enlargement, irrigation efforts should be avoided.

Early diagnosis of a suspected water bead insertion is critical for a good health outcome because water beads are highly damaging when they expand into middle ear structures.²⁶ Young children or patients with certain special needs may not be able to communicate well

²⁴ Lotterman S, Sohal M. Ear Foreign Body Removal. [Updated 2022 Nov 28]. In: StatPearls [internet]. Treasure Island (FL): StatPearls Publishing; 2024 Jan-. Available from: <https://www.ncbi.nlm.nih.gov/books/NBK459136/>; Svider PF, Vong A, Sheyn A, et al. What are we putting in our ears? a consumer product analysis of aural foreign bodies. *Laryngoscope*. 2015;125(3):709-714. doi:10.1002/lary.24935.PubMedGoogle ScholarCrossref.

²⁵ Ramgopal S, Ramprasad V, Manole M, Maguire R. Expansile Superabsorbent Polymer Ball Foreign Body in the Ear. *The Journal of Emergency Medicine*. ISSN: 0736-4679, Vol: 56, Issue: 6, Page: e115-e117. 2019; Sterling M, Murnick J, Mudd P. Destructive Otolitic Foreign Body: Dangers of the Expanding Bead. *JAMA Otolaryngol Head Neck Surg*. 2016;142(9):919-920. doi:10.1001/jamaoto.2016.1870; Zalzal HG, Ryan M, Reilly B, Mudd P. Managing the Destructive Foreign Body: Water Beads in the Ear (A Case Series) and Literature Review. *Annals of Otolaryngology & Rhinology & Laryngology*. 2023;132(9):1090-1095. doi:10.1177/00034894221133768.

²⁶ The middle ear is the portion of the ear that is responsible for transferring acoustic energy to the inner ear.

¹⁷ Size of expanded water beads not provided.

¹⁸ An exploratory laparotomy is a general surgical operation where a surgeon opens the abdomen and examines the abdominal organs. This is coupled with a small intestine enterotomy, which is a surgical incision to the intestine wall to remove the foreign body.

¹⁹ Size of expanded water bead not provided. Samples of the product that staff collected for testing shows full expansion being between 13.0 mm and 17.50 mm in diameter.

²⁰ Radiolucent is defined as being transparent to x-rays.

²¹ Kim HB, Kim YB, Ko Y, Choi YJ, Lee J, Kim JH. A case of ingested water beads diagnosed with point-of-care ultrasound. *Clin Exp Emerg Med*. 2020 Dec;7(4):330-333. doi: 10.15441/ceem.20.041. Epub 2020 Dec 31. PMID: 33440112; PMCID: PMC7808832.

²² The IDI confirms that "[m]edical imaging revealed a 2.4 cm [or 24 mm] foreign object blockage."

²³ Size of expanded water beads not provided.

enough to explain that a water bead is lodged in their ear, which leads to delayed diagnosis and a poor treatment outcome. For example, in I2410042A, a 22-year-old female with special needs visited multiple healthcare facilities before diagnosis of a water bead ear insertion.²⁷ Once a water bead expands into the middle ear structure, children can experience ear pain, damage to ear structures, and hearing loss. For example, in IDI 210421HCC1751, a 5-year-old female's ear drum was injured after a water bead expanded in her ear canal.²⁸ Similarly, a case report identifies a 4-year-old female who sustained a small ear drum perforation. The perforation was subsequently repaired during a follow up operation.²⁹

Long-term or permanent hearing loss is possible after a water bead is inserted into the ear canal. For example, in IDI 230613CBB1590, a 3-year-old female reported ear pain for several days. She was initially presumed to have an ear infection and was treated with antibiotics. Thereafter, she began having seizures and was hospitalized. A water bead was removed from her middle ear after it expanded and ruptured the right ear drum.³⁰ The child experienced ongoing seizures, hearing loss, and ear pain at least 14 months after the incident. Another case report describes a 10-year-old female who suffered permanent hearing loss after a water bead remained in her ear canal for at least 10 weeks.³¹

3. Nose Insertion

Four injury incident reports identify children presenting with water beads in the nasal passage. One incident involved a required hospitalization. When a child's age was reported, ages ranged from 3 years old to 11 years old.

Water beads can cause severe tissue damage to the nasal mucosa³² if left in the nasal cavity for prolonged periods of time, such as days or weeks.³³ While it is not uncommon for children to insert foreign bodies into nasal cavities,

children may display significant symptoms from water beads that are not experienced after inserting other objects, such as pieces of food, into the nose. Water bead nasal cavity insertion symptoms include nasal congestion, bleeding, fever, runny nose, and nasal swelling. Because these symptoms can be related to many other causes, caregivers or doctors may not realize that they are due to water beads.

While it may be possible to remove a water bead from a nasal cavity without professional medical intervention or for a water bead to pass naturally, children may still experience symptoms and negative side effects after water beads expand in the nose. For example, in I18C0277A, a 3-year-old male was eventually able to blow out a water bead that had been in his nose for up to two weeks.³⁴ The child had not told his parents he had inserted the water bead into his nose, but the parents later described the child as having had a nosebleed, trouble sleeping, congestion, a small tear in the nasal cavity, and a low-grade fever lasting three days.

Some water bead nose insertions require medical intervention to remove the water bead, sometimes using nasal endoscopy under general anesthesia or sedation.³⁵ For example, in IDI 180104CBB1236, a 4-year-old male was placed under general anesthesia at a local hospital and underwent a nasal endoscopy. The child inserted an unknown number of water beads into his nose. He was successful in blowing out most of the water beads, but a nasal endoscopy revealed a single water bead in the nasal passages. Removal was unsuccessful due to bleeding, so the child was placed under general anesthesia to remove the remaining water bead.³⁶

4. Aspiration

Aspiration is the entry of a foreign body, excess saliva, food, or stomach contents from the upper respiratory tract into the lower respiratory tract, which includes the trachea, bronchi, bronchioles, and lungs. Two reported incidents of aspiration involved a child swallowing and inhaling a water bead that then entered and blocked the child's airway. One incident required ED treatment and the other required hospitalization.

Sudden inhalation of small objects can cause aspiration into the respiratory tract.³⁷ Depending on the object's size,

aspirated foreign bodies tend to pass through the trachea and bronchi mainstream and lodge in areas of the tracheobronchial tree.³⁸ If a water bead becomes lodged in a child's upper airway, particularly after expansion, the child may experience airway obstruction or acute respiratory distress, which may be fatal. Examples of aspirations include:

- In I2310047A, a 20-month-old male aspirated a water bead, which obstructed his airway, necessitating medical intervention.³⁹

- In IDI 201130CCC3196, an 18-month-old male aspirated water beads, which led to an airway obstruction. The child was admitted to the hospital for a bronchoscopy⁴⁰ under general anesthesia, where several water beads were removed from his airway.⁴¹

When a child aspirates a water bead, the initial symptoms range from minor initial choking spells, coughing, or wheezing, to unconsciousness as the water bead obstructs more of the airway for a longer period of time, resulting in the child being unable to breathe and transmit oxygen to the brain. Death versus injury to the child after a water bead aspiration is dependent upon the degree of bronchial obstruction and the time interval between inhalation and extraction of the water bead. Early diagnosis of water bead aspiration allows for a greater likelihood of successful removal and better potential treatment outcome because the water bead may not have yet expanded. Because water beads are radiolucent, they can be difficult to locate within the body and thus difficult to remove,

tracheobronchial tree. *Thorax* 31:365–640, 1976; Aytac, A. Ikizler, C. Inhalation of foreign bodies in children. *J. Thoracic & Cardiovasc. Surgery* 74(1):145–151, 1977; Blazer, S. Naveh, Y., Friedman, A. Foreign body in the airway—a review of 200 cases. *Am. J. Diseases of Children* 134(1):68–71, 1980; Cohen, S.R., Herbert, W.I. Lewis, G.B. Geller, K.A. Foreign bodies in the airway—five-year retrospective study with special reference to management. *Ann. Otol.* 89:437–442, 1980.

³⁸ The tracheobronchial tree is composed of the trachea, the bronchi, and the bronchioles that transport air from the environment to the lungs for gas exchange.

³⁹ Size of expanded water bead not provided.

⁴⁰ A bronchoscopy is an endoscopic technique to visualize the inside of the airways for diagnostic and therapeutic purposes.

⁴¹ IDI included a photo of an expanded water bead from the toy alongside a dime coin to reflect the bead's approximate size. While the expanded sizes of the removed beads are unknown, the mother provided a photo of before and after expansion in water. The photo shows an expanded bead with a diameter about the size of a dime, and much larger than an unexpanded bead next to it. As discussed in section IV of this preamble below, limiting the expansion potential of water bead toys to no more than 50 percent of the original size will help reduce damage from aspiration.

²⁷ Size of expanded water bead not provided.

²⁸ Size of expanded water bead not provided.

²⁹ Ramgopal S, Ramprasad V, Manole M, Maguire R. Expansile Superabsorbent Polymer Ball Foreign Body in the Ear. *The Journal of Emergency Medicine*, ISSN: 0736–4679, Vol: 56, Issue: 6, Page: e115–e117. 2019.

³⁰ The IDI confirms that the “[g]randmother described the extracted water bead as being the size of a pea.”

³¹ Schulze SL, Kerschner J, Beste D. Pediatric external auditory canal foreign bodies: a review of 698 cases. *Otolaryngol Head Neck Surg.* 2002 Jul;127(1):73–8. doi: 10.1067/mhn.2002.126724. PMID: 12161734.

³² The tissue that lines the nasal cavity.

³³ Han S, Chen Y, Xian X, Teng Y. *BMC Pediatrics* (2021) 21:273 <https://doi.org/10.1186/s12887-021-02740-x>.

³⁴ Size of expanded water bead not provided.

³⁵ *Id.*

³⁶ Size of expanded water bead not provided.

³⁷ Abdulmajid, O., Ebeid, A.M, Motaweh, M.M., Kleibo, I.S. Aspirated foreign bodies in the

particularly when the airway obstruction is not complete.

5. Choking

One reported incident identified that a child had choked on a water bead. Choking occurs when a foreign body fully or partially obstructs the airway to compromise oxygen supply to the lungs.⁴² Physical characteristics of objects that pose a choking hazard include, for example, large size, round shape, and smooth texture.

The hazard pattern for choking does not depend upon expansion after the water bead enters the body. Caregivers commonly place water beads in water for prolonged periods of time so the beads can fully expand in advance of a child's playtime. For example, in IDI 180104CBB1236, the child's father placed a number of water beads in water so that they "would grow and be ready to use in the morning." Children may then attempt to swallow the expanded beads. Large, expanded water beads pose a significant choking hazard because they are spherical objects, which can easily roll to the back of the throat and form an air-tight seal with the elastic lining of the airway, thereby causing a complete blockage of the airway and inability to breathe.⁴³ The throat muscles can contract and tightly grip a water bead, which can make removal difficult without medical intervention. If an object completely obstructs the airway at or above the level of the trachea, the rapid loss of oxygen to body tissues can cause irreversible brain damage or death within minutes. If the airway is not completely blocked, the gag reflex will force the object to the back of the throat (the opposite of swallowing) and the cough reflex will bring in air to force the object from the airway in response to choking.

B. National Injury Estimates From NEISS

Based on NEISS data, CPSC estimates 6,300 injuries (sample size = 250, coefficient of variation = 0.27) related to water beads were treated in U.S. hospital EDs over the six-year period from 2017 through 2022.⁴⁴ Of the 250

⁴² Baker, S.P. Childhood asphyxiation by choking or suffocation. *JAMA* 244(12):1343–1346, 1980.

⁴³ Chang DT, Abdo K, Bhatt JM, Huoh KC, Pham NS, Ahuja GS. Persistence of choking injuries in children. *Int J Pediatr Otorhinolaryngol*. 2021 May;144:110685. doi: 10.1016/j.ijporl.2021.110685. Epub 2021 Mar 21. PMID: 33819896; Hayes NM, Chidekel A. Pediatric choking. *Del Med J*. 2004 Sep;76(9):335–40. PMID: 15510972.

⁴⁴ The estimated injuries for this NPR are less than the estimate presented in the public guidance on water beads that can be found on the Commission's website at <https://www.cpsc.gov/Safety-Education/Safety-Education-Centers/Water->

sample NEISS cases, none were fatal. About 42 percent of the estimated injuries involved children ages 2 through 4 years old, while about 15 percent of the estimated injuries involved children under the age of 2 years old. The youngest child was 7 months old. Forty-one (41) percent of those injured were male, while 59 percent were female. Regarding patient disposition, 95 percent were treated at the hospital ED and released; 3 percent were held for observation; 2 percent were admitted for hospitalization; and less than 1 percent left the hospital without care. The following hazard patterns were identified:

- *Ingestion (48 percent)*: the reports stated that the child ingested or swallowed a water bead, possibly ingested a water bead, or had put a water bead in his or her mouth. In all sample cases, the youngest child was 7 months old. Three (3) percent of all estimated injuries due to water bead ingestion involved hospitalizations.

- *Ear insertion (36 percent)*: the reports stated that the child either inserted a water bead into their ear or presented with a water bead stuck in the ear with uncertainty as to how the water bead became inserted. In all sample cases, the child was between the ages of two and 15 years old.

- *Nose insertion (15 percent)*: the reports stated that the child either inserted the water bead into their nose or presented with the water bead stuck in the nose with uncertainty as to how the water bead became inserted. In all sample cases, the child was between the ages of two and 10 years old.

- *Other (<1 percent)*: the remaining reports identified one injury from aspiration and one from eye insertion.

C. Overview of Hazards in Relation to Child Supervision and Behavior

Water bead ingestion, nasal and ear insertion, choking and aspiration can occur in seconds. Many incidents are not witnessed because the caregiver was not directly looking at the child when the ingestion, insertion, initial choking or aspiration occurred. Research indicates that toddlers and preschoolers (ages 2 years old through 5 years old) are out of view of a supervisor for about 20 percent of their awake time at home and are not within visual or hearing

Beads-Information-Center#:-:text=CPSC%20urges%20parents%20and%20caregivers,seek%20medical%20treatment%20right%20away. The difference is mainly due to the NPR excluding incidents with hazard patterns related to rashes or other allergic reactions and incidents involving water bead gel blaster projectiles, which commonly involve eye injury and some of which may not involve children's toys in the scope of this proposed rule.

range for about 4 percent of awake time at home.⁴⁵ A study of 100 parents found that the mean amount of time parents were willing to leave a child unsupervised in low-risk areas, such as a living room, was six minutes before the child was old enough to crawl and four minutes after the child was old enough to crawl, before the child was 2 years old.⁴⁶ Consumers reasonably may not know water beads are hazardous, particularly because they are marketed for children's play.

Research demonstrates that infants and toddlers are likely to mouth objects within reach. Mouthing of non-food items is a normal part of children's exploratory behavior that contributes to incidents of choking and poisoning.⁴⁷ This behavior is part of the reason for the ban on small parts for toys intended for children younger than 3 years of age, for example, and the mandatory small-parts warning for toys and games intended for children ages 3 years old to 6 years old. 16 CFR part 1501. Mouthing non-food items tends to decrease as a child's age increases; however, it is not uncommon for children over the age of 3 years old to experience choking or ingestion episodes with objects other than food.⁴⁸ Children are prone to ingest or insert small, smooth, colorful objects, like water beads or toy parts.⁴⁹ Unintentional foreign body ingestion is a leading causes for nonfatal ED visits in children younger than 9 years old.⁵⁰

⁴⁵ Morrongiello, B. A., Corbett, M., McCourt, M., & Johnston, N. (2006). Understanding unintentional injury-risk in young children I. The nature and scope of caregiver supervision of children at home. *Journal of Pediatric Psychology*, 31(6): 529–539.

⁴⁶ Garzon, D.L., Lee, Dr. R.K., and Homan, S.M. (2007) "There's No Place Like Home: A Preliminary Study of Toddler Unintentional Injury." *Journal of Pediatric Nursing*, 22, 368—375.

⁴⁷ Tulve, N., Suggs, J., McCurdy, T., Cohen-Hubal, E., & Moya, J. (2002). Frequency of mouthing behavior in young children. *Journal of Exposure Analysis and Environmental Epidemiology*. 12, 259–264.

⁴⁸ A-Kader. (2010) Foreign body ingestion: children like to put objects in their mouth. *World J Pediatrics*, Vol 6 No 4 . November 15, 2010. www.wjpc.com; Orsagh-Yentis D, McAdams RJ, Roberts KJ, et al. (2019). Foreign-Body Ingestions of Young Children Treated in US Emergency Departments: 1995–2015. *Pediatrics*. 143(5):e20181988; Reilly, J. (1992, Fall). Airway Foreign Bodies: Update and Analysis. *Int Anesthesiol Clin*.30(4):49–55; Altman, A., Ozanne-Smith, J. (1997). Non-fatal asphyxiation and foreign body ingestion in children 0–14 years. *Injury Prevention*. 3:176–182.

⁴⁹ Svider, P.F., Vong, A., Sheyn, A., Bojrab, D.I., Hong, R. S., Eloy, J.A., and Folbe, A.J. (2015). What are we putting in our ears? A consumer product analysis of aural foreign bodies. *The Laryngoscope*. 125, 709–714; Heim, SW, & Maughan, K.L. (2007). Foreign Bodies in the ear, nose, and throat. *American Academy of Family Physicians*, 76, p.1186–1189.

⁵⁰ Centers for Disease Control and Prevention. Web-based Injury Statistics Query and Reporting

Management and treatment for childhood accidental ingestion is well documented in pediatric medical literature.⁵¹

D. Availability of Incident Data

Upon publication of this NPR in the **Federal Register**, CPSC staff will make available for review and comment the CP SRMS and NEISS incident reports relied upon and discussed in the NPR, to the extent allowed by applicable law, along with the associated IDIs. The data

will be made available by submitting a request to: <https://forms.office.com/g/gSZi1gHic8>. You will then receive a website link to access the data at the email address you provided. If you do not receive a link within two business days, please contact mkresse@cpsc.gov.

E. Recalls

From December 2012 through March 2024, the Commission's Office of Compliance and Field Operations conducted five recalls and issued two

unilateral press release warnings⁵² regarding water bead products. Table 1 below summarizes the seven announcements, including the announcement date, firm/brand, hazard(s), approximate number of units affected, number of reported incidents/injuries, and press release number. The announcements involved one death and five reported injuries, and affected approximately 166,000 units.

TABLE 1—SUMMARY OF WATER BEAD ANNOUNCEMENTS

Announcement date	Firm/brand	Hazard	Number of affected units	Number of incidents (injuries & deaths) ⁵³	Press release No.
December 17, 2012	Dunecraft Inc	Serious Ingestion Hazard	94,799	1 incident (1 injury, 0 deaths)	⁵⁴ 13–071
July 31, 2013	Be Amazing! Toys	Serious Ingestion Hazard	14,200	None Reported	⁵⁵ 13–254
September 10, 2013	Eco-Novelty Corp	Serious Ingestion Hazard	3,500	None Reported	⁵⁶ 13–278
December 12, 2013	Doodlebutt	Serious Ingestion Hazard	1,500	None Reported	⁵⁷ 14–056
September 14, 2023 ...	Buffalo Games, Inc	Serious Ingestion, Choking and Obstruction Hazards.	52,000	2 incidents (1 injury, 1 death)	⁵⁸ 23–286
March 19, 2024	Jangostor Brand	Chemical Toxicity Hazard—Violation of Federal Ban of Hazardous Substances.	Unknown	2 incidents (2 injuries, 0 deaths) ..	⁵⁹ 24–163
March 19, 2024	Tuladuo Brand	Chemical Toxicity Hazard—Violation of Federal Ban of Hazardous Substances.	Unknown	1 incident (1 injury, 0 deaths)	⁶⁰ 24–162

IV. Review of Voluntary Standards—ASTM F963 and EN 71–1

ASTM F963 includes performance requirements and test methods for toys, as well as requirements for warning labels and instructional literature, to reduce or prevent injury to children or death of children from mechanical, chemical, and other hazards associated with toy use. Toys must comply with this standard pursuant to 16 CFR part 1250.

ASTM F963 defines “Expanding Materials” as “any material used in a toy which expands greater than 50% in any dimension from its as-received state.” Section 4.40 of ASTM F963–23 addresses potential hazards associated with expanding materials by requiring that toys and removable components of toys composed of expanding materials which, first, fit entirely within a small parts cylinder while in the toy's as-received size condition, then must, after

expansion, completely pass through a 20.0 mm diameter gauge while applying a force of up to 4.5 lbf (pound-force).

Water beads that expand up to 20.0 mm diameter would meet the ASTM F963–23 “Expanding Material” requirements because they would pass through the gauge, but water beads larger than 20.0 mm diameter would likely fail the requirements because the water beads would fragment once force is applied, as described below in more detail. Yet, as explained in section III of this preamble, incident data show that water beads both larger and smaller than 20.0 mm diameter are hazardous.

Another voluntary standard used primarily in the European Union, EN 71–1, *Safety of Toys—Part 1: Mechanical and Physical Properties*, also provides requirements for expanding materials. Section 3.24 of EN 71–1 defines an “expanding material” as a “material, the volume of which

expands when exposed to water.” Section 4.6 of EN 71–1 establishes performance requirements for expanding materials in toys or components of toys which fit entirely in a 31.7 mm diameter small parts cylinder, the same size as CPSC's small parts cylinder reflected in Figure 9 below, and states they shall not expand more than 50 percent in any dimension when measured after being submerged in demineralized water for 24, 48 and 72 hours. If the expansion in any dimension is more than 50 percent, then the toy does not comply with the expanding material requirement. For example, water beads with an unexpanded diameter of 2.0 mm and expand larger than 3.0 mm diameter would pass through the small parts cylinder in their dehydrated state but expand by more than 50 percent, thus failing the EN 71–1 requirements. Additionally, EN 71–9, *Safety of Toys—*

System (WISQARS) [Online]. (2003). National Center for Injury Prevention and Control, Centers for Disease Control and Prevention. Available from URL: www.cdc.gov/ncipc/wisqars. [10/1/2022].

⁵¹ Kay, M., & Wyllie, R. (2005). Pediatric foreign bodies and their management. 7(3):212–8; Lee, J.H., (2018) Foreign Body Ingestion in Children. *Clinical Endoscopy*, 51:129–136; Kramer et al., 2015; Conners GP, & Mohseni M. Pediatric Foreign Body Ingestion. [Updated 2021 Jul 18]. In: StatPearls [internet]. Treasure Island (FL): StatPearls Publishing; 2022 Jan-. Available from: <https://www.ncbi.nlm.nih.gov/books/NBK430915/>—(accessed 4/12/22) Pediatric Foreign Body Ingestion—StatPearls—NCBI Bookshelf (nih.gov).

⁵² A unilateral press release is a product-related safety warning issued by CPSC that is not issued jointly with a recalling company.

⁵³ When the press release delineates the approximate number of recalled units, number of incidents, or number of injuries by country, this summary only includes the reported United States values.

⁵⁴ <https://www.cpsc.gov/Recalls/2012/dunecraft-recalls-water-balz-skulls-orbs-and-flower-toys-due-to-serious-ingestion>.

⁵⁵ <https://www.cpsc.gov/Recalls/2013/Be-Amazing-Toys-Recalls-Monster-Science-and-Super-Star-Science-Colossal-Water-Balls>.

⁵⁶ <https://www.cpsc.gov/Recalls/2013/Eco-Novelty-Recalls-Jumbo-Size-and-Jumbo-Multipurpose-Cosmo-Beads-Toys>.

⁵⁷ <https://www.cpsc.gov/Recalls/2014/Doodlebutt-Recalls-Jelly-BeadZ-Jumbo-BeadZ-and-Magic-Growing-Fruity-Fun-Toys>.

⁵⁸ <https://www.cpsc.gov/Recalls/2023/Buffalo-Games-Recalls-Chuckle-Roar-Ultimate-Water-Beads-Activity-Kits-Due-to-Serious-Ingestion-Choking-and-Obstruction-Hazards-One-Infant-Death-Reported-Sold-Exclusively-at-Target>.

⁵⁹ <https://www.cpsc.gov/Newsroom/News-Releases/2024/CPSC-Warns-Consumers-to-Immediately-Stop-Using-Jangostor-Water-Beads-Due-to-Chemical-Toxicity-Hazard-Violation-of-Federal-Ban-of-Hazardous-Substances-Sold-on-Amazon-com>.

⁶⁰ <https://www.cpsc.gov/Newsroom/News-Releases/2024/CPSC-Warns-Consumers-to-Immediately-Stop-Using-Tuladuo-Water-Bead-Sets-Due-to-Chemical-Toxicity-Hazard-Violation-of-Federal-Ban-of-Hazardous-Substances-Sold-on-Amazon-com>.

*Part 9: Organic Chemical Compounds—Requirement*⁶¹ provides a test method and a concentration limit for a potentially hazardous chemical, called acrylamide, in toys. The EN standard states that the acrylamide concentration limit has been “calculated based on long-term licking, sucking and chewing of toys that are intended or likely to be mouthed for a significant amount of time. Examples are teethers, rattles and other hand-held soft plastic toys for young children.”

Acrylamide limitations in EN 71–9 were developed to address acrylamide exposure following long-term licking, sucking and chewing of toys that are

intended to be mouthed. In contrast, water bead toys addressed in this NPR are not intended to be mouthed, nor are they likely to be mouthed for a significant amount of time. The hazards this NPR works to address are ingestion, insertion, choking, and aspiration, not mouthing. Therefore, CPSC staff proposes mandating a different acrylamide limit and test method, intended to address the hazards outlined in the NPR, which is discussed in section V of this preamble.

A. Assessment of Current ASTM F963–23 Performance Requirements

The test method for “Expanding Materials” described in section 8.30,

Expanding Materials—Test Method of ASTM F963–23 requires that an expanding material, such as a water bead, first be submerged in deionized water for up to 72 hours in order to reach its largest expansion size. The product is then tested to check whether, at its largest expanded size, the water bead can pass through a gauge with a 20.0 mm (+0.0/–0.1 mm) diameter hole, as is seen in Figure 7, when applying a force of 4.5 lbf (pound-force) to the water bead in the direction of the hole via a rod having a hemispherical end diameter of 10.0 mm.

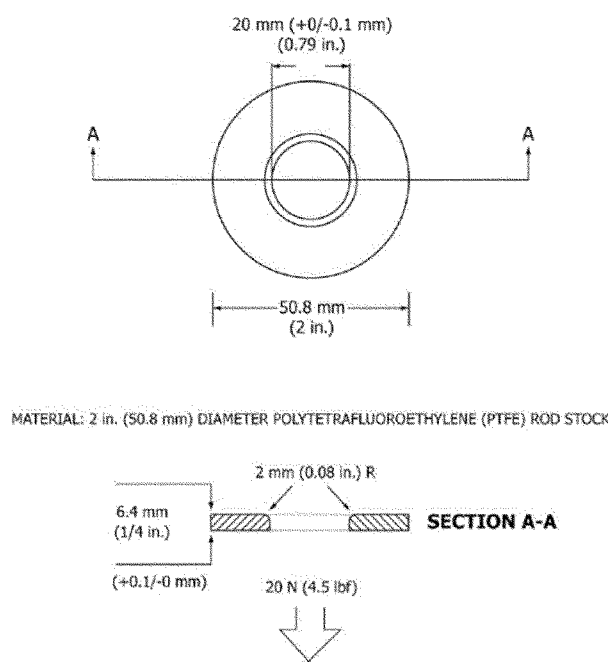

Figure 7: Section 4.40 of ASTM F963–23 Test Gauge and Force Application.⁶²

CPSC staff assessed the current ASTM test method in section 8.30 of ASTM F963–23 and found that using a rod to apply force to an expanded water bead to determine whether the water bead can fit through a test gauge does not realistically represent the compression forces exerted on a water bead when it

is swallowed. The use of a 10.0 mm diameter rod to apply a force when conducting the test causes fragmentation of the water bead (Figure 8), which would be considered a “pass” pursuant to the ASTM test standard. Yet, incident data confirms water beads remain whole after being swallowed,

thus creating a gastrointestinal tract blockage.⁶³ Because the force that the rod exerts can damage the expanded water bead and cause fragmentation, Commission staff has assessed that the current ASTM test method is inadequate to effectively test water beads for an ingestion hazard.

⁶¹EN 71–9 provides requirements and test methods for organic chemical compounds, such as acrylamide. Previously cited EN 71–1 provides requirements and test methods for mechanical and physical properties, such as expansion limits. Both are part of the standard EN 71.

⁶²Reprinted, with permission, from ASTM F963–23 Standard Consumer Safety Specification for Toy Safety, copyright ASTM International, 100 Barr Harbor Drive, West Conshohocken, PA 19428. A copy of the complete standard may be obtained from ASTM International, www.astm.org. A free, read-only copy of the standard is available for

viewing on the ASTM website at <https://www.astm.org/READINGLIBRARY/>.

⁶³Examples include the following IDs: 230727CBB1846, 230707CBB1698, 230613CBB1591, 170802CCC3140 and 221107CFE0002.



Figure 8: Expanded Water Bead After Being Fragmented by 10.0 mm Diameter Rod End.

Staff also analyzed the 20.0 mm (+0.0/−0.1 mm) diameter gauge specified in section 4.40 of ASTM F963–23 and determined that in light of incident data demonstrating how ingestion hazards occur, the gauge diameter should be reduced. The 20.0 mm diameter gauge used in ASTM F963 was selected based on the dimension of the pyloric sphincter⁶⁴ within the gastrointestinal tract of an 18-month-old child because, at the time the “Expanding Materials” requirements were created, the pyloric sphincter was thought by the drafters to be the most likely site where the gastrointestinal blockage would occur. As explained below, however, objects that can cause a gastrointestinal blockage are more likely to occur at either the gastric outlet part of the stomach or the ileocecal valve at the end of the small intestine.⁶⁵

Water beads, like other foreign bodies and food, do not remain in the stomach for long. Therefore, water beads generally do not expand fully in the stomach but pass through the pyloric sphincter and into the small intestine. Water beads continue to expand in the small intestine, where they spend more time and are exposed to liquid that facilitates expansion. After the water beads expand fully in the small intestine, they are unable to pass through the ileocecal valve and into the large intestine, therefore causing a gastrointestinal blockage. CPSC staff evaluated the relevant recent incident data and advises that because the ileocecal valve is often the site of the gastrointestinal blockage when a child ingests a water bead, the ileocecal valve is a more appropriate anatomical structure on which to base the diameter of the funnel test gauge than the pyloric sphincter. Literature on ileocecal valve size indicates valve size will vary based

on age and natural variation within the population,^{66 67} but the Commission has not identified reliable authorities providing ileocecal valve sizes for children between the ages of 9 months old and 3 years old. Accordingly, as explained in section V below, the Commission has based this proposed rule on incident data.

Section 4.40 of ASTM F963–23 also requires that “[t]oys, and removable components of toys, which fit entirely inside the small parts cylinder in their as-received condition, and which are composed of an expanding material, shall completely pass through the gauge when tested.” The referenced small parts cylinder is from 16 CFR 1501.4 and section 4.6.1, *Small Objects* of ASTM F963–23, which provides general safety requirements. Under section 4.6.1, toys intended for children under 36 months of age, “including removable [components], liberated components, or fragments of toys[,] shall [not] be small enough without being compressed to fit entirely within [the small parts cylinder].” This requirement is to minimize choking, ingestion, or inhalation hazards. Most water bead products are intended for children older than 36 months of age, however, and therefore are not subject to requirements in section 4.6.1 of ASTM F963–23.

Finally, to address the potential presence of toxic chemicals in toys, section 4.3 of ASTM F963–23 requires that all toys must comply with the Federal Hazardous Substances Act (FHSA) toxicity and hazardous substances standards. Though there is this generalized FHSA compliance requirement for all of ASTM F963–23, section 4.40, *Expanding Materials* of

ASTM F963–23 does not specifically mandate testing for hazardous chemicals. Water beads are composed of absorbent polymers, which can contain acrylamide monomer—a chemical that can be hazardous when ingested.⁶⁸ ASTM F963–23 does not have any test methods or limits for acrylamide monomer in water beads. Therefore, the current ASTM standard is inadequate to provide the highest level of safety feasible to ensure that the chemicals in water beads are non-toxic. Because water beads containing high levels of acrylamide monomer are toxic, the NPR proposes to establish content limits and test methods to address the toxicity hazard.

B. Assessment of Current EN 71–1 Expanding Materials Requirements

The test method for “Expanding Materials” described in section 8.14 of EN 71–1 requires that an expanding material, such as a water bead, that fits entirely in a small parts cylinder first be measured, using calipers,⁶⁹ to determine its original size in each dimension. Next, the expanding material must be submerged in demineralized water for up to 72 hours to reach its largest expansion size. After expansion, the water bead must be measured again to determine if it has expanded more than 50 percent of its original size in any dimension. If the water bead has expanded more than 50 percent, the expanding material requirements are not met.

The Commission preliminarily determines that the current EN 71–1 expanding material requirement is inadequate as a stand-alone requirement. Staff assesses that an additional maximum size requirement is

⁶⁴ The pyloric sphincter is the valve located at the bottom of the stomach which opens to allow food to pass from stomach to the small intestine.

⁶⁵ The ileocecal valve is a sphincter muscle situated at the junction of the ileum (last portion of the small intestine) and the colon (first portion of the large intestine).

⁶⁶ Tang SJ, Wu R. Ileocecum: A Comprehensive Review. *Can J Gastroenterol Hepatol*. 2019 Feb 3;2019:1451835. doi: 10.1155/2019/1451835. PMID: 30854348; PMCID: PMC6378086.

⁶⁷ Silva AC, Beaty SD, Hara AK, Fletcher JG, Fidler JL, Menias CO, Johnson CD. Spectrum of normal and abnormal CT appearances of the ileocecal valve and cecum with endoscopic and surgical correlation. *Radiographics*. 2007 Jul-Aug;27(4):1039–54. doi: 10.1148/rg.274065164. PMID: 17620466.

⁶⁸ Per the Federal Hazardous Substances Act (FHSA) (16 CFR 1500.3(c)(2)(i)(A)), a substance with a median lethal dose (LD₅₀) between 50 and 5000 mg/kg in rats is “toxic” for acute toxicity. The reported oral LD₅₀ values for undiluted acrylamide in rats range from 150 to 413 mg/kg. See ATSDR *Toxicological Profile for Acrylamide*, available at <https://www.atsdr.cdc.gov/ToxProfiles/tp203.pdf>.

⁶⁹ An instrument used to measure the dimensions of an object.

necessary because as currently written, for example, the standard would allow for a water bead having a diameter of 9.0 mm to expand to 13.5 mm diameter. While this expansion would not be more than 50 percent of the water bead's original size, therefore meeting the EN 71-1 expanding material requirements, the expanded water bead would likely cause a gastrointestinal block if a child ingested it. Indeed, as described in section III of this preamble,⁷⁰ a water bead with 13.0 mm diameter is known to have caused a gastrointestinal block in a 13-month-old female. If the only limitation on compliant water beads was that they do not expand more than 50 percent, the ingestion hazard would still be present.

The 50 percent expansion limit is, however, a beneficial additional safety provision when combined with staff's proposed diameter limit for fully expanded beads. In particular, requiring a reduction in the maximum expansion of water beads reduces the potential damage to inner ear structures or nasal tissue if a child inserts a water bead into their ear or nose because more damage occurs when the water beads are intended to expand to bigger sizes and therefore exert more pressure on the body parts that contain them. Reducing expansion potential will also reduce the degree of bronchial obstruction created when a water bead is aspirated.

C. Assessment of Current ASTM F963-23 Labeling Requirements

Section 5.0, *Labeling Requirements* of ASTM F963-23 contains general labeling requirements that apply to toys, including water beads or toys containing water beads. Still, the requirements in section 5.0 are not specifically referenced in section 4.40, *Expanding Materials*. Only broad warning statements for small part choking hazards and small ball hazards are required for "Expanding Materials." While the warning statements address general choking hazards, they do not address or inform about injuries (e.g., gastrointestinal blockage and nasal tissue damage) and deaths that have occurred when water beads expand after being swallowed or inserted.

D. 2024 Proposed Draft Revisions to ASTM F963

On January 22, 2024, and March 25, 2024, CPSC staff met with the ASTM F15.22 Emerging Hazards Task Group to discuss a possible revision of ASTM F963 to include specific requirements for water beads. CPSC staff and ASTM discussed incident information and the

ASTM 20.0 mm diameter test gauge compared to CPSC's proposed funnel test gauge shown below in Figure 10 and Figure 11. On July 9, 2024, ASTM shared a draft proposal to revise section 4.40 of ASTM F963-23 to include water bead-specific requirements. On July 18, 2024, ASTM submitted a ballot for vote on the proposal, which is available until August 19, 2024.

CPSC staff has reviewed the 2024 draft proposal, finding that it is inadequate to address all known water bead hazards. In the proposed revision, the draft would define a water bead as a "spherical or spheroid water-absorbent object, intended to expand in size when immersed in a liquid." This draft revision would apply to water beads intended to be accessible in dehydrated state and water beads in the expanded state. If the water bead is already expanded, the water bead would be given time to dehydrate before testing. These draft requirements would not apply to water beads that are not intended to be accessible, such as water beads within a squeeze ball.

ASTM's draft performance test proposal requires first measuring the diameter of a dehydrated water bead and then measuring the maximum amount of expansion after soaking the water bead in deionized water at 37 °C. If the maximum expansion is greater than 50 percent in diameter, then the water bead will be placed in a funnel gauge like that in Figure 10 to determine whether it can pass through the gauge under a certain external pressure. If the maximum expansion of the water bead is less than or equal to 50 percent in diameter, no further testing is required. Based on incident data, the ASTM draft proposes use of a funnel test gauge with a 12.0 mm diameter (+0.0/-0.1 mm) as a performance requirement. When attempting to pass an expanded water bead, the proposed test includes applying a force of 0.1 lbf to the water bead in the direction of the 12.0 mm diameter hole with a 10.0 mm diameter rod having a flat end. The ASTM draft states that "a water bead material which breaks or loses integrity during this test is considered to be acceptable," and therefore if the fragmented pieces pass through the funnel, the product still would meet the draft requirement even if the unbroken water bead was larger than 12.0 mm. The draft does not include acrylamide limits or revised labeling requirements.

CPSC staff has reviewed the draft ASTM proposal and finds that a gauge size of 12.0 mm is inadequate to address known hazards from water beads. The draft proposes 12.0 mm in consideration

of one incident,⁷¹ which describes a 13-month-old female who was unable to pass a water bead presumed to be as small as 13.0 mm diameter. However, while staff knows a 13.0 mm sized bead can cause a blockage in a child, this incident does not establish the size of the largest water bead that can safely pass. Further, the draft ASTM requirements leave the potential for a dehydrated water bead of 13.0 mm diameter capable of expanding to 19.5 mm diameter without requiring testing because the water bead would not expand to more than 50 percent of its original size. As explained elsewhere in this preamble, fragmentation of the water bead during testing is not representative of incident data, and testing of water beads within toys, such as squeeze balls, appears necessary to address accessibility incidents. Therefore, while the draft ASTM proposal may be an improvement beyond the current "Expanding Materials" requirements, it would not adequately address known water bead hazards even if adopted.

V. NPR Description of Proposed Provisions and Justification

Based on incident data described in section III of this preamble and CPSC staff's engineering, health sciences, and human factors assessments, the NPR proposes creating a new section 1250.4 to 16 CFR part 1250, Safety Standard Mandating ASTM F963 for Toys, adding performance and labeling requirements for water beads to better address the known water bead hazards and to provide the highest level of safety feasible for such products. Further, this NPR proposes revising the title of part 1250 from "Safety Standard Mandating ASTM F963 for Toys" to "Safety Standard for Toys," to reflect the inclusion of proposed requirements that do not incorporate by reference existing requirements in the ASTM F963 voluntary standard.

A. Performance Requirements To Address Ingestion, Choking, Aspiration, and Insertion Hazards

Under the proposed rule, water beads in the pre-expanded state that fit entirely inside the small part cylinder from 16 CFR 1501.4 (Figure 9) must then, after full expansion, not grow more than 50 percent in any dimension and must remain whole while completely passing through the funnel test gauge depicted in Figure 10 and Figure 11. Instead of using the rod test in ASTM F963-23, the NPR proposes requiring the water bead to pass through

⁷⁰ IDI 170802CC3140.

⁷¹ IDI 170802CCC3140.

a 9.0 mm (+0.0/−0.1 mm) diameter funnel test gauge under its own weight to better reflect the lower range of the compression forces a water bead would experience while passing through a child's gastrointestinal tract.

In the absence of conclusive anatomical evidence, the Commission relies on incident data and CPSC staff's analysis to propose that the funnel test gauge have a 9.0 mm diameter. IDI 170802CCC3140 describes a 13-month-old female who was unable to pass a water bead presumed to range from 13.0 mm to 17.5 mm diameter. Staff purchased a separate sample of the same product that the 13-month-old female ingested and tested the water beads according to the section 4.40 requirements. After testing, the water beads had a dehydrated, as-received diameter ranging between 2.0 mm and 2.50 mm. After hydration and expansion, the size ranged from between 13.0 mm to 17.5 mm diameter. IDI 230707CBB1698 describes a 3-year-old female who ingested but successfully passed approximately 1,200 water beads. The child successfully passed approximately 200 of the water beads naturally and then passed the remaining water beads with the aid of a mineral oil enema. Staff

purchased a separate sample of the same product that the 3-year-old female ingested and tested the water beads according to the requirements in section 4.40. After the testing was completed, the water beads had a dehydrated, as-received diameter ranging between 2.20 mm and 2.40 mm. After hydration and expansion, the diameter of the water beads ranged from between 9.32 mm and 15.20 mm diameter. Based on these investigations, the NPR proposes requiring the use of a 9.0 mm diameter funnel test gauge to ensure the test methods provide the highest level of safety feasible by limiting the gauge size to the size of the smallest water bead that was known to pass through the body without causing an intestinal obstruction.

The proposed 9.0 mm diameter funnel test gauge also would reduce the hazards associated with water beads that are inserted into children's noses and ears. While nose and ear insertion incident data do not indicate the expanded water bead sizes, larger beads can grow further into the nasal cavity and middle ear, causing severe injuries and requiring invasive surgery with sedation and/or general anesthesia to completely remove. The larger water beads are more likely to be removable

only in pieces, as opposed to as a whole, because the bead has expanded deeper into the nasal cavity or inner ear. Removal of smaller water beads tends to be less invasive because they can be removed in one piece by health care professionals, similar to removal efforts of other inserted small objects, like marbles, toy parts, and food.

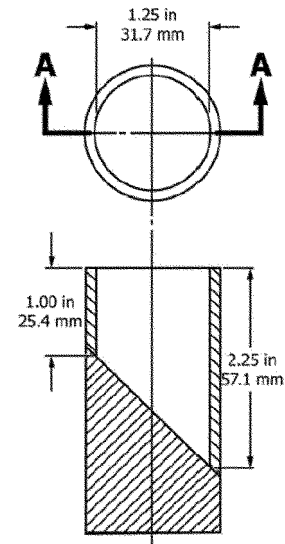

Figure 9: Small Parts Cylinder.

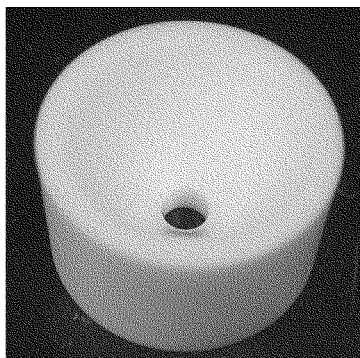

Figure 10: Funnel Test Gauge.

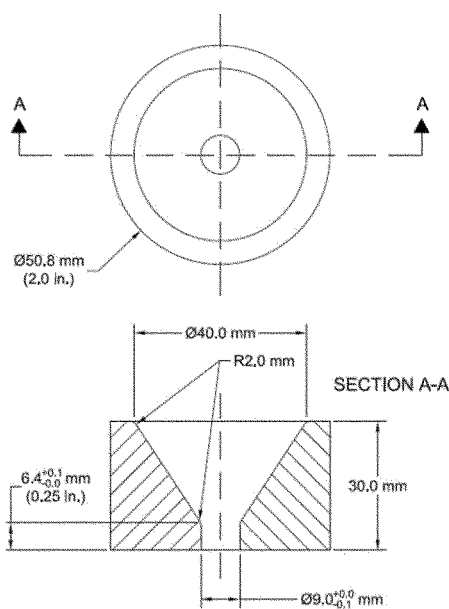

Figure 11: Funnel Test Gauge. Material: Polytetrafluorethylene (PTFE).

The NPR proposes including the “Expanding Materials” test method from section 8.30 of ASTM F963–23, with modifications, in the proposed rule for water beads under § 1250.4. The NPR proposes conditioning the water bead or toy containing the water bead at 20 ± 5 °C (68 ± 9 °F) and at a relative humidity of 40–65 percent for a minimum of seven hours prior to the test. This mirrors the ASTM test method but adds a requirement that if the water bead is partially expanded, or contained within a toy and partially expanded, the water bead should be removed and dehydrated before testing. This simulates the hazard that occurs when a water bead dislodges from the product and then dehydrates. Pursuant to the ASTM test method, the NPR proposes that the water bead should next be submerged in a test bath of deionized water maintained at $37 \text{ °C} \pm 2 \text{ °C}$ ($98.6 \text{ °F} \pm 3.6 \text{ °F}$) for the duration of immersion,

without agitation.⁷² For water beads that exhibit positive buoyancy, the test requires placing weight(s) with mass just sufficient to achieve complete submersion on top of the water bead. The test requires that test labs be careful to minimize contact of the test water bead with the sides or bottom of the container to minimize any interference with expansion. To ensure the water bead is fully expanded, the test requires submersion for 72 hours and to measure the bead’s expansion after 6 hours, 24 hours, 48 hours and then 72 hours. If the greatest expansion was observed at 72 hours, then the testing should proceed. If greatest expansion was observed at another time interval, then a new sample should be conditioned for

⁷² The largest expansion usually occurs in deionized water; therefore, the water bead can grow to its largest potential in deionized water when testing the product in a laboratory. This is a conservative approach, as beads may expand less in digestive fluids.

the time interval when greatest expansion was observed.

Next, the NPR proposes adding a test step based on the “Expanding Materials” requirement from section 4.6 of EN 71–1, which limits water bead expansion to no more than 50 percent in any dimension. After the required period of submersion to reach greatest expansion, the water bead will be measured with calipers to determine whether it has expanded more than 50 percent. Setting this expansion limit will address potential damage to nasal passages and ear cavities, as well as prevent choking or aspiration hazards by limiting water bead growth.

Thereafter, returning to the ASTM framework but instead of using the ASTM F963 rod test, the proposed test in the NPR would require placing the expanded water bead at the top surface of the 9.0 mm diameter gauge’s upper opening (Figure 11) in the orientation least likely to pass through, and releasing the bead to allow it to travel

down until it reaches the lower opening, then observing if the expanded water bead is able to remain whole and completely pass through the lower opening. By testing to observe if the water bead can completely pass through the 9.0 mm diameter funnel test gauge without external force, the test can simulate what occurs in a child's gastrointestinal tract to determine whether the bead will or will not cause a blockage in a child's gastrointestinal tract or, specifically, at the child's ileocecal valve located at the end of the small intestines.

B. Acrylamide Limits and Testing

Water beads are composed of absorbent polymers, such as polyacrylamide and/or polyacrylate polymers. Polyacrylamide is a chemical compound composed of acrylamide monomer units linked together. The polymer form, polyacrylamide, is relatively non-toxic; however, acrylamide monomer alone can be toxic.⁷³ Residual acrylamide monomer can remain after production of polyacrylamide, which can stay in water beads after manufacturing. Human exposure to acrylamide monomer is known to cause negative health effects depending on the amount and duration of exposure.⁷⁴ Chronic, long-term exposure can adversely affect the nervous, gastrointestinal, and reproductive systems and is suspected to be a human carcinogen. Even short-term or one-time exposures have caused acute negative effects in the nervous system.⁷⁵

The United States Food and Drug Administration (FDA) limits the amount of residual acrylamide monomer allowed in polyacrylamide used in food production (21 CFR 176.170, 176.180), processing (21 CFR 173.5, 173.10, 173.315), and packaging (21 CFR

176.110). The FDA has also published guidance on reducing the amount of acrylamide in foods.⁷⁶ Polyacrylamide is commonly used in water and wastewater treatment, and the EPA limits the amount of acrylamide permitted in drinking water.⁷⁷

No CPSC mandatory standard sets acrylamide limits for water beads or any other product; however, toys subject to ASTM F963, including water beads, are subject to the toxicology safety requirements in section 4.3.1, *Hazardous Substances* of ASTM F963–23. Section 4.3.1 stipulates that “[t]oys or materials used in toys shall conform to the FHSA and to the regulations promulgated under that act The regulations define limits for substances that are toxic, corrosive, [or] an irritant” Section 8.2, *Testing for Hazardous Substance Content* in ASTM F963–23 directs readers to review the FHSA to determine whether a product is comprised of hazardous substances. Depending on exposure, acrylamide could be a hazardous substance per 16 CFR 1500.3(b)(4)(i), which defines a hazardous substance as “any substance or mixture of substances which is toxic” Per 16 CFR 1500.3(b)(5), the term ‘toxic’ refers to “any substance (other than a radioactive substance) which has the capacity to produce personal injury or illness to man through ingestion, inhalation, or absorption through any body surface.”

While CPSC does not have incident data reflecting acrylamide poisoning from water beads,⁷⁸ the presence of acrylamide monomers in several water bead products that staff tested demonstrates a potential chemical hazard. CPSC has made efforts to address the potential chemical hazard outside of rulemaking. For example, in March 2024 CPSC announced unilateral warnings for two water bead products that contained levels of acrylamide in violation of the FHSA.⁷⁹ If one of those water beads was ingested, it could pose

a risk of acute toxicity to children from the acrylamide exposure.

Children's possible exposures to acrylamide after ingesting water beads would likely be a single, infrequent event (possibly including multiple beads in a single event). Therefore, the exposure scenario would be acute rather than chronic. The Agency for Toxic Substances and Disease Registry (ATSDR)⁸⁰ created and published an acute-duration oral minimal risk level (MRL) of 0.01 mg/kg-day for acrylamide.⁸¹ The MRL is an acute exposure level at which an exposed person (including a child) is unlikely to experience an adverse health effect.

The Commission proposes that acrylamide limits be set to ensure that if a child ingests multiple water beads, the child's exposure levels would not exceed the acute duration oral MRL for children aged 6 months old.⁸² The NPR proposes that the limit be set to 65 µg acrylamide extractable from 100 small water beads (defined as <4 mm across the smallest diameter of the bead prior to hydration) or one large water bead (defined as ≥4 mm across the smallest diameter of the bead prior to hydration). The quantities of small and large beads assumed to be ingested are based on water bead ingestion incidents and published case reports. Incident data indicate that children tend to ingest only one or two large beads. CPSC therefore proposes an exposure scenario in which a 6-month-old child ingests one large water bead.

Less information is available for incidents of children ingesting small beads. If small beads do not expand enough after ingestion to cause a blockage, a child may not receive medical care. However, two case reports describe a 12-month-old who ingested 12 small water beads⁸³ and a 2-year-old who ingested approximately 100 small beads.⁸⁴ A review of 21 water bead ingestion cases over a 10-year period

⁷³ Per FHSA (16 CFR 1500.3(c)(2)(i)(A)), a substance with a median lethal dose (LD₅₀) between 50 and 5000 mg/kg in rats is “toxic” for acute toxicity. The reported oral LD₅₀ values for undiluted acrylamide in rats range from 150 to 413 mg/kg (source: ATSDR *Toxicological Profile for Acrylamide*, available at <https://www.atsdr.cdc.gov/ToxProfiles/tp203.pdf>).

⁷⁴ ATSDR *Toxicological Profile for Acrylamide*, available at <https://www.atsdr.cdc.gov/ToxProfiles/tp203.pdf>; Internationally Peer Reviewed Chemical Safety Information (INCHEM) Acrylamide Review, available at <https://incchem.org/documents/pims/chemical/pim652.htm>; U.S. Environmental Protection Agency (EPA) Hazard Summary of Acrylamide, available at <https://www.epa.gov/sites/default/files/2016-09/documents/acrylamide.pdf>; U.S. FDA Process Contaminants in Food—acrylamide, available at <https://www.fda.gov/food/process-contaminants-food/acrylamide>.

⁷⁵ Agency for Toxic Substances and Disease Registry (ATSDR) *Toxicological Profile for Acrylamide*, available at <https://www.atsdr.cdc.gov/ToxProfiles/tp203.pdf>.

⁷⁶ U.S. FDA *Guidance for Industry Acrylamide in Foods*, available at <https://www.fda.gov/media/87150/download>.

⁷⁷ U.S. EPA *National Primary Drinking Water Regulations*, available at <https://www.epa.gov/ground-water-and-drinking-water/national-primary-drinking-water-regulations>.

⁷⁸ CPSC has not yet received data demonstrating chronic exposure to acrylamide from water beads.

⁷⁹ <https://www.cpsc.gov/Newsroom/News-Releases/2024/CPSC-Warns-Consumers-to-Immediately-Stop-Using-Jangostor-Water-Beads-Due-to-Chemical-Toxicity-Hazard-Violation-of-Federal-Ban-of-Hazardous-Substances-Sold-on-Amazon-com>; <https://www.cpsc.gov/Newsroom/News-Releases/2024/CPSC-Warns-Consumers-to-Immediately-Stop-Using-Tuladuo-Water-Bead-Sets-Due-to-Chemical-Toxicity-Hazard-Violation-of-Federal-Ban-of-Hazardous-Substances-Sold-on-Amazon-com>.

⁸⁰ ATSDR is a federal public health agency within the United States Department of Health and Human Services. More information about ATSDR is available at <https://www.atsdr.cdc.gov>.

⁸¹ ATSDR *Toxicological Profile for Acrylamide*, available at <https://www.atsdr.cdc.gov/ToxProfiles/tp203.pdf>.

⁸² Six months is the most sensitive age in this range by having the lowest body weights, so the proposed limit of extractable acrylamide from water beads is based on children of this age.

⁸³ Kim HB, Kim YB, Ko Y, Choi YJ, Lee J, Kim JH. A case of ingested water beads diagnosed with point-of-care ultrasound. *Clin Exp Emerg Med*. 2020 Dec;7(4):330–333. doi: 10.15441/ceem.20.041. Epub 2020 Dec 31. PMID: 33440112; PMCID: PMC7808832.

⁸⁴ Jackson J, Randell KA, Knapp JF. Two Year Old With Water Bead Ingestion. *Pediatr Emerg Care*. 2015 Aug;31(8):605–7. doi: 10.1097/PEC.0000000000000520. PMID: 26241717.

(2008 to 2017) reported that the number of water beads swallowed ranged from one to “a handful.”⁸⁵ Although IDI 230707CBB1698 describes a 3-year-old who ingested approximately 1,200 small water beads, this scenario appears to be an extreme occurrence. CPSC therefore proposes for this NPR an exposure scenario in which a 6-month-old child ingests 100 small water beads. The 100 count is within the range of documented ingestion incidents, and it is consistent with the number of small beads that staff uses in the acrylamide extraction test method described below.

An acrylamide exposure limit from ATSDR’s acute-duration oral MRL of 0.01 mg/kg would mean that a child should not be exposed to more than 0.01 mg of acrylamide for each kg of the child’s body weight. When assessing the appropriate limit, staff used the fifth percentile body weight for the youngest female child according to the National Center for Health Statistics.⁸⁶ The fifth percentile body weight of a 6- to 8-month-old female is 6.5 kg. By multiplying the acute-duration oral MRL by the body weight, staff recommends an exposure limit for acrylamide from water beads is 0.065 mg, which is equal to 65 µg of extractable acrylamide. The calculation are:

1. Calculate Acrylamide Exposure Limit:
0.01 mg/kg × 6.5 kg = 0.065 mg
2. Convert mg unit to µg: 0.065 mg × 1000 µg/mg = 65 µg

The amount of extractable acrylamide shall be tested in accordance with the test procedure specified in the proposed 16 CFR 1250.4(c)(2).⁸⁷ The proposed 65 µg acrylamide exposure limit applies to an assumed ingestion of one large bead (defined as ≥4 mm across the smallest diameter of the bead prior to hydration) or 100 small beads (defined as <4 mm across the smallest diameter of the bead prior to hydration). Under the proposal, CPSC would consider less than 65 µg acrylamide extractable from water beads safe in children as young as 6 months old, while water beads containing more than 65 µg pose a risk of acute toxicity. Staff in CPSC’s Division of Chemistry and Directorate for Health Sciences

⁸⁵ Mehmetoğlu F. A Retrospective 10-Year Analysis of Water Absorbent Bead Ingestion in Children. *Emerg Med Int.* 2018 May 6;2018:5910527. doi: 10.1155/2018/5910527. PMID: 29854461; PMCID: PMC5960561.

⁸⁶ U.S. Centers for Disease Control and Prevention (CDC) *Anthropometric Reference Data for Children and Adults: United States, 2015–2018*, available at https://www.cdc.gov/nchs/data/series/sr_03/sr03-046-508.pdf.

⁸⁷ Because the volume of the extraction fluid may be variable, the 65 µg acrylamide limit is the total mass of acrylamide extracted in 24 hours and not a concentration.

developed a test method to determine the levels of extractable acrylamide in water beads. The NPR proposes the following extraction method:

- Perform an extraction test on water beads to determine the amount of acrylamide that leaches from the water beads over a 24-hour period.
- Place dehydrated water beads in a container with pH neutral deionized water and place the container in a shaker bath that heats the water beads to 37 °C while shaking them at 30 RPM for 24 hours.
- For each water bead product, perform three separate extraction trials, or repetitions, concurrently to ensure that all results are reasonably consistent, given any bead-to-bead variation. For large water beads (defined as ≥4 mm across the smallest diameter of the bead prior to hydration), perform three trials using one large bead per trial. For small beads (defined as <4 mm across the smallest diameter of the bead prior to hydration), perform three trials using 100 small beads per trial. If a product contains different sizes of water beads, perform extraction testing for each size.

• Use an appropriate extraction container and volume of deionized water so that all water beads remain covered by water for the duration of the extraction period. Because water beads absorb different volumes of water depending on their size, conduct additional tests before performing final acrylamide extractions, to determine what volume of water best allows for full bead growth without unnecessarily diluting the concentration of extracted acrylamide. Choose containers that will not compress the water beads at any point during the 24-hour extraction period. To prevent water evaporation during the extraction, cover the containers during the extraction.

- Following the extraction period, determine the volume of remaining water for each trial, then analyze the water to determine the mass of acrylamide present using an instrument that is able to quantitate acrylamide at levels equal to or less than the proposed limit. Staff used a liquid chromatography-tandem mass spectrometer (LC–MS/MS) system,⁸⁸ but other instruments may accurately quantify acrylamide at levels equal to or less than the proposed limit.

C. Marking, Labeling, and Instructional Literature Requirements

The ASTM F963–23 standard does not contain marking, warning, or

⁸⁸ LC–MS/MS is an analytical chemistry technique that allows for the physical separation and subsequent identification and quantification of analytes of interest within a solution.

labeling requirements specifically for water beads. While the standard provides broad warning requirements under section 5 of ASTM F963–23, such warnings do not adequately address the hazards associated with water beads. The Commission proposes requiring the following marking, labeling, and instructional literature requirements for all products within scope of the NPR and seeks comment on format, location, and content requirements of proposed warnings.

1. Packaging and Container Marking and Labeling

Warning about a hazard is a less effective method of addressing the hazard, contrasted with either designing the hazard out of a product or guarding consumers from the hazard.⁸⁹ Therefore, when a standard relies on warnings to address a hazard, it is particularly important that the warning statements are noticeable, understandable, and motivational. The primary U.S. voluntary consensus standard for product safety signs and labels, ANSI Z535.4, *American National Standard for Product Safety Signs and Labels*,⁹⁰ recommends that on-product warnings include content that addresses the following three elements:

- a description of the hazard;
- information about the consequences of exposure to the hazard; and
- instructions regarding appropriate hazard-avoidance behaviors.

Providing explicit or detailed information in a warning can increase its effectiveness⁹¹ by enhancing perception of injury severity and perceived hazard.⁹² Vividness of

⁸⁹ Laughery, K.R., & Wogalter, M.S. (2011). The Hazard Control Hierarchy and its Utility in Safety Decisions about Consumer Products. In W. Karwowski, M.M. Soares, & N.A. Stanton (Eds.), *Human Factors and Ergonomics in Consumer Product Design: Uses and Applications* (pp. 33–39). Boca Raton, FL: CRC Press; Williams, D.J., & Noyes, J.M. (2011). Reducing the Risk to Consumers: Implications for Designing Safe Consumer Products. In W. Karwowski, M.M. Soares, & N.A. Stanton (Eds.), *Human Factors and Ergonomics in Consumer Product Design: Uses and Applications* (pp. 3–21). Boca Raton, FL: CRC Press; Vredenburg, A.G., & Zackowitz, I.B. (2006). Expectations. In M.S. Wogalter (Ed.), *Handbook of warnings* (pp. 345–354). Mahwah, NJ: Lawrence Erlbaum Associates.

⁹⁰ ANSI Z535.4, *American National Standard for Product Safety Signs and Labels* is the primary U.S. voluntary consensus standard for the design, application, use, and placement of on-product warning labels when developing or assessing the adequacy of warning labels.

⁹¹ Laughery, Sr., K.R., & Smith, D.P. (2006). Explicit Information in Warnings. In M.S. Wogalter (Ed.), *Handbook of Warnings* (pp. 419–428). Mahwah, NJ: Lawrence Erlbaum Associates.

⁹² DeJoy, D.M. (1999). Motivation. In M.S. Wogalter, D.M. DeJoy, & K.R. Laughery (Eds.),

message content can increase message salience by triggering motivation to act in consideration of the warning.⁹³

The Commission proposes including the following warnings on water bead toys and packaging of toys that contain

water beads. Specifically, packaging would be required to include the warning as shown in Figure 12:

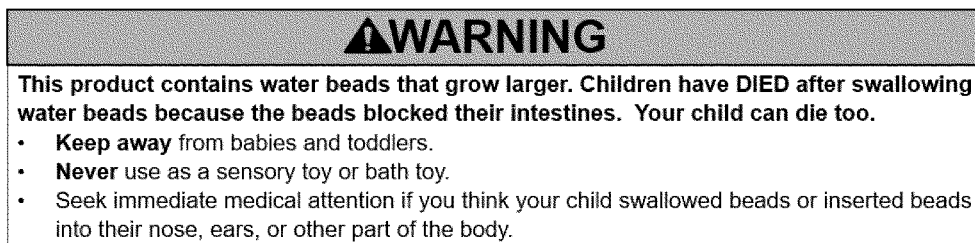

Figure 12. Warning for Water Bead Toys and Packaging of Toys Containing Water

Beads.

Packaging of toys with contained water beads, such as squeeze balls filled with water beads, would be required to

include the warnings as shown in Figure 13:

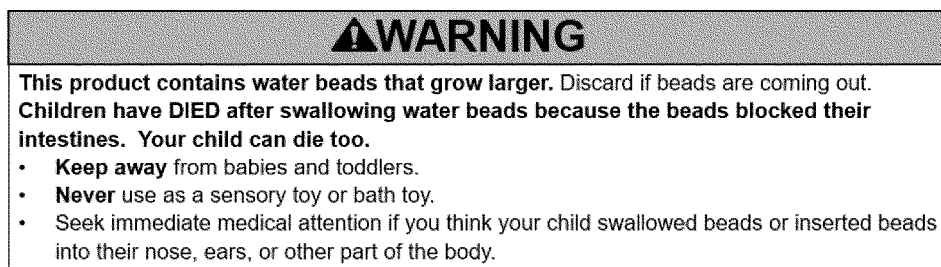

Figure 13. Warnings for Toys Containing Water Beads.

The Commission further proposes that toys containing water beads that are not individually packaged (e.g., multiple squeeze balls sold in a bin/box) would be required to have a hangtag or sticker label affixed on each individual product with the warning shown in Figure 13.

Because CPSC is aware of one death in the U.S. and additional deaths outside of the U.S.,⁹⁴ both warnings labels state, “Children have DIED after swallowing water beads because the beads blocked their intestines. Your child can die too.” The purpose of this statement is to communicate to consumers the consequences of swallowing water beads, as well as clarify that once a water bead enters the

body, water beads pose a danger by expanding inside the body. The additional statements advise consumers how to avoid hazards and what to do if the consumer suspects a child has swallowed or inserted a water bead. The warning for toys with contained water beads (Figure 13) includes the wording, “This product contains water beads that grow larger. Discard if beads are coming out[.]” to ensure consumers are aware that water beads are within the toy, and that exposed water beads are hazardous. Incident data confirm that caregivers may be unaware that toy products purchased contain hazardous water beads.⁹⁵

When developing or assessing the adequacy of a warning, one must consider not only the content of a warning, but also its design or form.⁹⁶ CPSC commonly uses ANSI Z535.4 as a reference for warning formatting requirements. Human factors experts and warnings literature regularly cite ANSI Z535.4 when discussing the design and evaluation of on-product warning labels and generally consider the ANSI Z535 series of requirements as the state-of-the-art, benchmark standards against which warning labels should be evaluated for adequacy.⁹⁷ The scope of ANSI Z535.4 is broad enough to encompass nearly all consumer

Warnings and Risk Communication (pp. 221–243). Philadelphia: Taylor & Francis.

⁹³ Murray-Johnson, L., & Witte, K. (2003). Looking Toward the Future: Health Message Design Strategies. In T.L. Thompson, A. Dorsey, K. I. Miller, & R. Parrott (Eds.), *Handbook of Health Communication* (pp. 473–495). New York: Routledge.

⁹⁴ <https://www.consumerreports.org/babies-kids/toys/water-beads-pose-a-serious-safety-risk-to-children-a6431187819/>.

⁹⁵ Such as incident 20230601–3657B–2147347238 found on *saferproducts.gov*. A 2-year-old child bit

into a stress ball and swallowed the contents requiring medical treatment. The consumer claims to have been unaware that there were water beads inside.

⁹⁶ Laughery, Sr., K.R., & Wogalter, M.S. (2006). The Warning Expert in Civil Litigation. In M.S. Wogalter (Ed.), *Handbook of Warnings* (pp. 605–615). Mahwah, NJ: Lawrence Erlbaum Associates; Madden, M.S. (1999). The Law Relating to Warnings. In M.S. Wogalter, D.M. DeJoy, & K.R. Laughery (Eds.), *Warnings and Risk Communication* (pp. 315–330). Philadelphia: Taylor & Francis; Madden, M.S. (2006). The Duty to Warn

in Products Liability. In M.S. Wogalter (Ed.), *Handbook of Warnings* (pp. 583–588). Mahwah, NJ: Lawrence Erlbaum Associates.

⁹⁷ Vredenburg, A.G., & Zackowitz, I.B. (2005). Human Factors Issues to be Considered by Product Liability Experts. In Y.I. Noy & W. Karwowski (Eds.), *Handbook of Human Factors in Litigation* (Chapter 26). Boca Raton, FL: CRC Press; Wogalter, M.S., & Laughery, K.R. (2005). Effectiveness of Consumer Product Warnings: Design and Forensic Considerations. In Y.I. Noy & W. Karwowski (Eds.), *Handbook of Human Factors in Litigation* (Chapter 31). Boca Raton, FL: CRC Press.

products, including children's products and toys.⁹⁸

Signal words, colors, graphics, and placement all increase conspicuity. The salience of a visual warning can be enhanced using large and bold print, high contrast, color, borders, pictorial symbols, and special effects like flashing lights. Therefore, the NPR proposes warning label design requirements for water bead toys and toys containing water beads that reflect the current recommendations from ASTM's Ad Hoc Language Task Group (Ad Hoc Task Group).⁹⁹ The recommendations provide permanent, conspicuous, and consistently formatted warning labels across juvenile products. Warnings that meet the recommendations address numerous format issues related to capturing consumer attention, improving readability, and increasing hazard perception and avoidance behavior. Such recommendations include requiring that the proposed warnings conform to ANSI NEMA Z535.4—2023, *American National Standard for Product Safety Signs and Labels*, sections 6.1–6.4, 7.2–7.6.3, and 8.1, with the following changes to the ANSI standard:

- In sections 6.2.2, 7.3, 7.5, and 8.1.2, replace the word “should” with “shall;”
- In section 7.6.3, replace the phrase “should (when feasible)” with the word “shall;” and
- Strike the word “safety” when used immediately before a color (e.g., replace “safety white” with “white”).

Further, certain text in the message panel must be in bold and in capital letters as shown in the example warning labels in Figure 12 and Figure 13, to provide emphasis and capture the reader's attention. The signal word “WARNING” must appear in sans serif letters in upper case only, be at least 1/8 inch (3.2 mm) in height, and be center- or left-aligned. The height of the exclamation point inside the safety alert

symbol must be at least half the height of the triangle and be centered vertically inside the triangle, as shown in the example warnings. The message panel text capital letters are no less than 1/16” (1.6mm)¹⁰⁰ and the message panel text is center- or left-aligned, in sans serif letters. Consistent with Ad Hoc, the text in each column should be arranged in list or outline format, with precautionary statements preceded by bullet points. Precautionary statements must be separated by bullet points if paragraph formatting is used.

Warnings that are placed directly on a product and/or the packaging have a higher noticeability rate¹⁰¹ because consumers are more likely to see such warnings when examining the product prior to purchase. ANSI Z535.4 provides general guidance on warning placement, stating that warnings must be “readily visible to the intended viewer” and will “alert the viewer to the hazard in time to take appropriate action.”¹⁰² Similarly, both the Ad Hoc Task Group and section 5.3.6 of ASTM F963–23 require conspicuous warnings. The NPR proposes warning labels be placed on the principal display panel as defined in section 3.1.62 of ASTM F963–23.

2. Instructional Literature

Some water bead toys or toys containing water beads provide instructional literature, such as manuals for use. Instructions or other literature accompanying a water bead product, when provided, shall include directions for use, including the relevant warnings from Figure 12 or Figure 13. The NPR proposes that instructional literature shall include the same warning labels that the NPR proposes for product packaging, with similar formatting requirements, though the literature does not need to be in color.¹⁰³ Still, the Commission proposes that the signal word and safety alert symbol shall contrast with the background of the signal word panel, and the warnings

shall contrast with the background of the instructional literature.¹⁰⁴

VI. Feasibility of Proposed Requirements

Pursuant to section 106(c) of the CPSIA, Congress directed the Commission to “periodically review and revise the rules set forth under this section to ensure that such rules provide the highest level of safety for such products that is feasible.” 15 U.S.C. 2056b(c). The Commission's statutory obligation is to ensure that toys have the highest level of safety that the producers are capable of achieving, considering technological and economic ability. Based on the staff's analysis provided in this NPR, the Commission preliminarily determines that the NPR is technically and economically feasible, and requests comment on this determination.

A. Technological Feasibility

A proposed rule is technically feasible if it is capable of being done. For example, compliant products might already be on the market; or the technology to comply with requirements might be commercially available; or existing products could be made compliant; or alternative practices, best practices, or operational changes would allow manufacturers to comply. See, e.g., 15 U.S.C. 1278a(d) (discussing lead limits). The Commission believes the NPR's proposals meet technical feasibility criteria. For instance, products currently available on the market are within the proposed rule's 9.0 mm size limitation, and there should be multiple means of producing and packaging water bead toys that expand by less than 50 percent. With respect to demonstrating compliance, the proposed funnel test gauge test does not require tools, like a push rod, to determine whether a water bead can pass through the gauge. Further, several testing tools in the NPR (e.g., a small parts cylinder) are already included in CPSC mandatory standards or come from the ASTM F963 standard. Accordingly, much of the technology is already used when testing to section 4.40 of ASTM F963–23 and is commercially available.

B. Economic Feasibility

The draft proposed rule is economically feasible because non-compliant toy products can be redesigned to be compliant, or be repurposed for non-toy uses. Based on CPSC staff's analysis, the Commission expects manufacturers would, to comply with the proposed rule, incur

⁹⁸ Kalsher, M.J., & Wogalter, M.S. (2008). Warnings: Hazard Control Methods for Caregivers and Children. In R. Lueder & V.J.B. Rice (Eds.), *Ergonomics for Children: Designing Products and Places for Toddlers to Teens* (pp. 509–539). New York: Taylor & Francis; Rice, V.J.B. (2012). Designing for Children. In G. Salvendy (Ed.), *Handbook of Human Factors and Ergonomics* (4th ed.) (pp. 1472–1483). Hoboken, NJ: Wiley.

⁹⁹ ASTM Ad Hoc Wording Task Group (Ad Hoc TG) consists of members of various durable nursery product voluntary standards committees, including CPSC staff. The Ad Hoc TG's purpose is to harmonize the wording of common sections (e.g., introduction, scope, protective components) and warning label requirements across nursery product voluntary standards. The latest version of the Ad Hoc-approved recommended language is published in the “Committee Documents” section of the Committee F15 ASTM website.

¹⁰⁰ 1.6mm is the size dimension from the toy standard, 16 CFR part 1250, *Safety Standard Mandating ASTM F963 for Toys*, not from the Ad Hoc Task Group.

¹⁰¹ Wogalter, M.S., Godfrey, S.S., Fontenelle, G.A., Desaulniers, D.R., Rothstein, P., & Laughery, K.R. (1987). Effectiveness of warnings. *Human Factors* 29(5), 599–612; Frantz, J.P.; Rhoades, T.P. (1993). A Task-Analytic Approach to the Temporal and Spatial Placement of Product Warnings. *Human Factors: The Journal of the Human Factors and Ergonomics Society*, 35(4), pp. 719–730.

¹⁰² American National Standards Institute. (2011). *ANSI Z535.4. American national standard: Product safety signs and labels*. Rosslyn, VA: National Electrical Manufacturers Association, Section 9.1.

¹⁰³ ANSI Z535.6, *Product Safety Information in Product Manuals, Instructions and Other Collateral Materials*, allows warning labels to be black and white whereas the NPR mandates color for warning labels packaging.

¹⁰⁴ Ad Hoc section Y.6, Instructional Literature.

material costs to redesign their product and retool their manufacturing processes to produce a compliant product. Staff expect the redesign and retooling costs to be significant for small firms involved in the water bead toy market, with the exception of the labeling requirements, which are negligible (*i.e.*, less than \$0.01 per product). A decline in sales is expected, as many currently available water bead toys would not be compliant with the draft proposed rule. However, while the impact of the proposed rule may be significant, firms could sell compliant water bead toys or sell non-compliant water beads for non-toy purposes, such as agricultural purposes.

VII. Incorporation by Reference

Proposed § 1250.4 would incorporate by reference ANSI Z535.4—2023. The Office of the Federal Register (OFR) has regulations regarding incorporation by reference. 1 CFR part 51. Under these regulations, agencies must discuss, in the preamble to a final rule, ways in which the material the agency incorporates by reference is reasonably available to interested parties, and how interested parties can obtain the material. In addition, the preamble to the final rule must summarize the material. 1 CFR 51.5(b)(3).

In accordance with the OFR regulations, section V of this preamble summarizes the major provisions of ANSI Z535.4—2023 that the Commission proposes to incorporate by reference into proposed § 1250.4. The standard itself is reasonably available to interested parties. By permission of ANSI, the standard can be viewed as a read-only document during the comment period for this NPR, at: <https://ibr.ansi.org/Standards/nema.aspx>. Interested parties can also schedule an appointment to inspect a copy of the standard at CPSC's Office of the Secretary, U.S. Consumer Product Safety Commission, 4330 East West Highway, Bethesda, MD 20814, telephone: (301) 504-7479; email: cpsc-os@cpsc.gov. Alternatively, interested parties can purchase a copy of the standard from ANSI, 1899 L Street NW, 11th Floor, Washington, DC 20036.

VIII. Effective Date

The Administrative Procedure Act (APA) generally requires that the effective date of a rule be at least 30 days after publication of the final rule. 5 U.S.C. 553(d). The Commission proposes a 90-day effective date for this rule. The rule would apply to all water beads manufactured after the effective date. 15 U.S.C. 2058(g)(1).

Although the NPR proposes to add new requirements, most of the test methods and test equipment are not unique, in that the current ASTM toy standard utilizes several similar methods and equipment. For example, as of July 12, 2024, 81 third-party laboratories were already CPSC-accepted to test expanding materials as provided in section 4.40 of ASTM F963–23, as incorporated into part 1250 on January 18, 2024. Additionally, as of July 12, 2024, 153 third-party laboratories were CPSC-accepted to test expanding materials as provided in section 4.40 of ASTM F963–17. While these third-party laboratories may not yet be CPSC-accepted for testing for acrylamide, CPSC expects that these laboratories are competent to conduct the required testing and can have their International Organization for Standardization (ISO) accreditation and CPSC-acceptance updated quickly in the normal course. Additionally, a 90-day effective date allows the proposed standard to coincide with the third-party testing requirements for children's products under section 14(a)(3) of the CPSA, as an NOR date must be no later than 90 days before such rules or revisions take place. 15 U.S.C. 2063(a)(3). The Commission invites comments, particularly from small businesses, regarding the proposed testing and the amount of time needed to come into compliance with a final rule.

IX. Regulatory Flexibility Act (RFA)

The RFA requires that agencies review a proposed rule for the rule's potential economic impact on small entities, including small businesses. Section 603 of the RFA generally requires that agencies prepare an initial regulatory flexibility analysis (IRFA) and make the analysis available to the public for comment when the agency publishes an NPR, unless the rule would not have a significant economic impact on a substantial number of small entities. 5 U.S.C. 603, 605(b). The IRFA must describe the impact of the proposed rule on small entities and identify significant alternatives that accomplish the statutory objectives and minimize any significant economic impact of the proposed rule on small entities.

This proposed rule would have a significant economic impact on a substantial number of small U.S. entities, primarily from redesign costs in the first year that the final rule would be effective. A significant impact would occur for small companies whose products do not meet the proposed requirements. Third-party testing costs

should not be a new significant cost for most small firms, given suppliers should already test to the current mandatory standard in part 1250.

A. Reason for Action, NPR Objectives, Product Description, and Market Description

Section I of this preamble explains why the Commission proposes to establish a mandatory rule for water bead toys and provides a statement of the objectives of, and legal basis for, the proposed rule. Section II of this preamble describes the types of products within the scope of the NPR, the market for water beads, and the use of water beads in the U.S. The proposed requirements in the NPR are more stringent than ASTM F963–23, which the Commission incorporated into the mandatory rule 16 CFR part 1250, Safety Standard Mandating ASTM F963 for Toys, as described in sections IV and V of this preamble. CPSC staff has not identified any other Federal rules that duplicate, overlap, or conflict with the draft proposed rule. The NPR addresses the known hazards presented by water beads, discussed in section III of this preamble, that the current rule does not adequately address.

B. Small Entities To Which the Rule Would Apply

Section II of this preamble describes the products within the scope of the rule and an overview of the market for water beads. This section provides additional details on the market for products within the scope of the rule.

CPSC staff has found that a majority of the firms that sell water bead toys are wholesalers of hobby goods, toys, and plastic products.¹⁰⁵ Retailers of water bead toy products are hobby and toy stores, department stores, and warehouse stores and supercenters.¹⁰⁶ Some of these products may be sold by convenience stores, but staff estimates the number of units sold from such stores is negligible. Water bead toys are

¹⁰⁵ The North American Industry Classification System (NAICS) defines product codes for U.S. firms. Firms advertise water bead products as toys and therefore water beads may be categorized under many NAICS product codes. These firms could be listed in NAICS code 339930 Doll, Toy, and Game Manufacturing but some may also be listed in code 326199 All Other Plastic Product Manufacturing. Importers of these products could also vary among different NAICS codes. A majority of the firms should be listed in the following NAICS codes as wholesalers: 423920 Toy and Hobby Goods and Supplies Merchant Wholesalers, and 424610 Plastics Materials and Basic Forms and Shapes Merchant Wholesalers.

¹⁰⁶ Retailers consist of NAICS codes 459120 Hobby, Toy, and Game Stores, 455110 Department Stores, and 455211 Warehouse Clubs and Supercenters.

small, novelty products which can easily be stored and sold in varying retail channels and, therefore, the described retailers, importers, and manufacturers are not all inclusive but represent the most prominent sources for water bead toys.

Currently, over 30 firms supply water bead toys to the U.S. market. Most of the U.S.-based manufacturers and importers are small companies based on Small Business Administration (SBA) size

standards.¹⁰⁷ The SBA size standards for small entities are based on the number of employees or the annual revenue of the firm, and there is a specific size standard for each 6-digit North American Industry Classification Series (NAICS) category.¹⁰⁸ The U.S. Census Bureau conducts an annual survey of small businesses in the U.S. and counts how many large and small businesses are in each NAICS category.¹⁰⁹ There is no NAICS category

specifically for water bead manufacturing or importing. Companies that manufacture water bead toy products may be categorized as doll, toy, and game manufacturing or under the category “All Other Plastic Product Manufacturing.” Importers are generally considered a type of merchant wholesaler. As seen in the tables below of applicable NAICS categories, the SBA small entity threshold for manufactures is generally 150 to 750 employees.

TABLE 2—ESTIMATE OF NUMBER OF SMALL MANUFACTURERS AND IMPORTERS

NAICS code	Description	SBA size standard for firms (# of employees)	Number of firms that meet size standard (based on SUSB data)
339930	Doll, Toy, and Game Manufacturing	700	7
326199	All Other Plastic Product Manufacturing	750	1
424610	Plastics Materials and Basic Forms and Shapes Merchant Wholesalers	150	4
423920	Toy and Hobby Goods and Supplies Merchant Wholesalers	175	19

TABLE 3—ESTIMATE OF NUMBER OF SMALL RETAILERS

NAICS code	Description	SBA size standard for firms (annual revenue) millions \$	Number of firms that meet size standard (based on SUSB data)
452210	Department Stores	\$40.0	15
452310	General Merchandise Stores, Including Warehouse Clubs and Supercenters ..	47.0	8,006
451120	Hobby, Toy, and Game Stores	35.0	4,660

Based on the Census Bureau’s 2021 Statistics of U.S. Businesses (SUSB) data and a review of publicly available data on annual revenues, staff estimates the number of firms classified as small for the aforementioned NAICS codes to be seven manufacturers, 23 importers, and 12,681 retailers. These firms could be considered small and supply water bead products.

C. Compliance, Reporting, Paperwork, and Recordkeeping Requirements of the Proposed Rule

The proposed rule would require suppliers (manufacturers and importers) of water bead toys to meet performance, warning label, and user instruction requirements, and to conduct third-party testing to demonstrate compliance. This section discusses the reporting and paperwork requirements. Compliance costs are analyzed in detail in section IX.E of this preamble.

Manufacturers must demonstrate that they have met the performance

requirements of the rule by providing a children’s product certificate. As specified in 16 CFR part 1109, suppliers who are not the original manufacturer, such as importers, may rely on the testing or certification suppliers provide, as long as the requirements in part 1109 are met. Manufacturers and importers are required to furnish certificates to retailers and distributors (section 14(g)(3) of the CPSA); retailers are not required to third-party test the children’s products that they sell unless they are also the manufacturer or importer. Under section 14 of the CPSA, manufacturers, importers, and private labelers of water bead products will be required to certify, based on a test of each product conducted by third-party conformity assessment body, that their products comply with the requirements of the proposed rule. Each children’s product certificate must identify the third-party conformity assessment body

that conducted the testing upon which the certificate depends.

D. Potential Impact on Small Entities

Water beads that expand to larger than 9.0 mm or to more than 50 percent greater than their original size in diameter when tested pursuant to section 8.30, *Expanding Materials Test Method* of ASTM F963–23, with modifications proposed in the NPR, would require modification to meet the proposed rule or be taken off the market. Additionally, water beads toys that do not meet the proposed acrylamide limit would require modification or discontinuation.

The Commission assesses it is likely that a substantial number of firms will incur significant costs from redesign, retooling, loss of sales, or the purchase and installation of new components. While some water bead toys are produced at sizes under the proposed maximum water bead diameter limit of 9.0 mm, CPSC staff has not identified

¹⁰⁷ Under SBA standards, a manufacturer, importer, and retailer of a product is categorized as a small entity based on their associated NAICS code. SBA uses the number of employees to determine if a manufacturer or importer is a small entity while SBA uses the amount of annual revenues for retailers.

¹⁰⁸ The North American Industry Classification System (NAICS) is the standard used by Federal statistical agencies in classifying business establishments for the purpose of collecting, analyzing, and publishing statistical data related to the U.S. business economy. For more information, see <https://www.census.gov/naics/>. Some programs

use 6-digit NAICS codes, which provide more specific information than programs that use more general 3- or 4-digit NAICS codes.

¹⁰⁹ <https://www.census.gov/programs-surveys/susb/data/tables.html>.

incidents associated with water beads, CPSC assesses that information and education campaigns have limited effectiveness in adequately addressing the hazard. Therefore, the Commission preliminarily finds that while an information campaign might be helpful, it would be inadequate to address water bead toy hazards.

3. Later Effective Date

The Commission could propose a later effective date that would reduce the burden on entities of all sizes by allowing more time to remove products from the market, repackage, and test products. In addition, testing laboratories need to become accredited to the proposed rule before any product can be tested to the proposed rule. Smaller companies are less likely to have the resources to quickly come into compliance with the proposed rule than larger ones, and a minority of the small U.S. companies that have products in scope of this proposed rule have multiple products that do not appear to meet the new performance requirements. However, the Commission preliminarily finds that providing a longer effective date would allow the hazards of water bead toys to be unaddressed for a later period of time resulting in more deaths and injuries, and thus would unreasonably delay addressing the ingestion hazard associated with water beads.

X. Environmental Consideration

The Commission’s regulations address whether the agency is required to prepare an environmental assessment or an environmental impact statement. Under these regulations, certain categories of CPSC actions normally have “little or no potential for affecting the human environment,” and therefore do not require an environmental assessment or an environmental impact statement. Safety standards providing performance and labeling requirements for consumer products come under this categorical exclusion. 16 CFR 1021.5(c)(1). The NPR falls within the categorical exclusion.

XI. Paperwork Reduction Act

This proposed rule for water beads contains information collection requirements that are subject to public comment and review by the Office of Management and Budget (“OMB”) under the Paperwork Reduction Act of 1995 (44 U.S.C. 3501–3521). In this document, pursuant to 44 U.S.C. 3507(a)(1)(D), we set forth:

- Title for the collection of information;
- Summary of the collection of information;
- Brief description of the need for the information and the proposed use of the information;

- Description of the likely respondents and proposed frequency of response to the collection of information;

- Estimate of the burden that shall result from the collection of information; and

- Notice that comments may be submitted to the OMB.

Title: Safety Standard for Toys: Requirements for Water Beads

Description: As described in section V of this preamble, the proposed rule would require new labeling for water bead toys. CPSC will seek a new OMB control number for this rule in the next PRA update for Third Party Testing of Children’s Products. The NPR proposes that water bead toys meet the proposed requirements of § 1250.4, which are summarized in section V of this preamble. Section 5 of ASTM F963–23 contains requirements for marking, labeling, and instructional literature of children’s toys in general. These requirements fall within the definition of “collection of information,” as defined in 44 U.S.C. 3502(3).

Description of Respondents: Persons who manufacture or import water bead toys or toys that contain water beads.

Estimated Burden: We estimate the burden of this collection of information as follows:

TABLE 4—ESTIMATED ANNUAL REPORTING BURDEN

Burden type	Number of respondents	Frequency of responses	Total annual responses	Hours per response	Total burden hours
Labeling and instructions	30	1	30	2	60

This estimate is based on the following: CPSC estimates there are 30 suppliers that would respond to this collection annually, and that the majority of these entities would be considered small businesses. CPSC assumes that on average each respondent that reports annually would respond once, as product models for water beads are brought to market and new labeling and instruction materials are created, for a total of 30 responses annually (30 respondents × 1 responses per year). CPSC assumes that on average it will take 1 hour for each respondent to create the required label and one hour for them to create the required

instructions, for an average response burden of 2 hours per response. Therefore, the total burden hours for the collection are estimated to be 60 hours annually (30 responses × 2 hours per response = 60 total burden hours).

CPSC estimates the hourly compensation for the time required to create and update labeling and instructions is \$41.55.¹¹¹ Therefore, the estimated annual cost of the burden requirements is \$2,493 (\$41.55 per hour × 60 hours = \$2,493). No operating, maintenance, or capital costs are associated with the collection. Based on this analysis, the proposed revisions to the standard would impose a burden to

industry of 60 hours at a cost of \$2,493 annually.

In accordance with the Paperwork Reduction Act of 1995 (44 U.S.C. chapter 35), CPSC has requested OMB approval of new information collection and recordkeeping requirements related to this proposed rule. CPSC invites comments on this new information collection. All comments received on this information collection will be summarized and included in the final request for OMB approval. Interested persons are requested to submit comments regarding information collection by November 8, 2024 (see the ADDRESSES section at the beginning of

Can-Be-Deadly-if-Swallowed; Water Beads: Harmful if Swallowed, Put in Ears—HealthyChildren.org (2024) https://www.healthychildren.org/English/safety-prevention/at-home/Pages/Water-Beads-Harmful.aspx?gad_source=1; Water Beads |

CPSC.gov (2024) <https://www.cpsc.gov/Safety-Education/Safety-Education-Centers/Water-Beads-Information-Center?language=en>.

¹¹¹ U.S. Bureau of Labor Statistics, “Employer Costs for Employee Compensation,” September

2023, Table 4, total compensation for all sales and office workers in goods-producing private industries: https://www.bls.gov/news.release/archives/ecec_12152023.pdf.

this notice). Pursuant to 44 U.S.C. 3506(c)(2)(A), we invite comments on:

- Whether the collection of information is necessary for the proper performance of the CPSC's functions, including whether the information will have practical utility;
- The accuracy of the CPSC's estimate of the burden of the proposed collection of information, including the validity of the methodology and assumptions used;
- Ways to enhance the quality, utility, and clarity of the information to be collected;
- Ways to reduce the burden of the collection of information on respondents, including the use of automated collection techniques, when appropriate, and other forms of information technology; and
- The estimated burden hours to create and update labeling and instructions, including any alternative estimates.

XII. Preemption

Section 26(a) of the CPSA, 15 U.S.C. 2075(a), states that when a consumer product safety standard is in effect and applies to a product, no state or political subdivision of a state may either establish or continue in effect a standard or regulation that prescribes requirements for the performance, composition, contents, design, finish, construction, packaging, or labeling of such product dealing with the same risk of injury unless the state requirement is identical to the federal standard. Section 106(f) of the CPSIA deems rules issued under that provision "consumer product safety standards." Therefore, once a rule issued under section 106 of the CPSIA takes effect, it will have preemptive effect in accordance with section 26(a) of the CPSA.

XIII. Certification and Notice of Requirements

Section 14(a) of the CPSA imposes the requirement that products subject to a consumer product safety rule under the CPSA, or to a similar rule, ban, standard, or regulation under any other act enforced by the Commission, must be certified as complying with all applicable CPSC-enforced requirements. 15 U.S.C. 2063(a). Section 14(a)(2) of the CPSA requires that certification of children's products subject to a children's product safety rule be based on testing conducted by a CPSC-accepted third-party conformity assessment body. Section 14(a)(3) of the CPSA requires the Commission to publish an NOR for the accreditation of third-party conformity assessment bodies (or laboratories) to assess conformity with a children's product

safety rule to which a children's product is subject. The proposed rule would create a new 16 CFR 1250.4 as part of 16 CFR part 1250. If issued as a final rule, the proposed rule would be a children's product safety rule that requires the issuance of an NOR.

16 CFR part 1112 establishes requirements for accreditation of third-party conformity assessment bodies to test for conformity with a children's product safety rule in accordance with section 14(a)(2) of the CPSA. Part 1112 also codifies all of the NORs issued previously by the Commission. To meet the requirement that the Commission issue an NOR for the proposed standard, the Commission proposes to add water beads to the list of children's product safety rules for which CPSC has issued an NOR.

Testing laboratories applying for acceptance as a CPSC-accepted third-party conformity assessment body to test to the new standard for water beads would be required to meet the third-party conformity assessment body accreditation requirements in part 1112. When a laboratory meets the requirements as a CPSC-accepted third-party conformity assessment body, the laboratory can apply to CPSC to have 16 CFR 1250.4, Safety Standard for Toys: Requirements for Water Beads, included within the laboratory's scope of accreditation of CPSC safety rules listed for the laboratory on the CPSC website at: <https://www.cpsc.gov/cgi-bin/labsearch/>.

Testing laboratories should not be adversely impacted as a result of this rule. Approximately 67 third-party testing laboratories are CPSC-accepted to test compliance with ASTM F963-23. CPSC staff expects that these labs will become accredited and CPSC-accepted to test to this new standard in the normal course of business. CPSC expects that these laboratories will be able to test to a new rule in a short time period. Furthermore, no laboratory is required to provide testing services. The only laboratories that are expected to provide such services are those that anticipate receiving sufficient revenue from the mandated testing to justify procuring the testing equipment and obtaining accreditation.

XIV. Request for Comments

The Commission requests comments on the proposed rule to promulgate a mandatory standard for water beads under section 106 of the CPSIA. During the comment period, ASTM F963-23 is available as a read-only document at: <http://www.astm.org/cpsc.htm>. Comments should be submitted in accordance with the instructions in the

ADDRESSES section at the beginning of this document.

CPSC requests comments on all aspects of this rulemaking and specifically requests comment on the following topics:

A. Water Bead Definition

The proposed rule defines "water bead(s)" as "various shaped, water absorbent polymers, such as, but not limited to polyacrylamides and polyacrylates, which expand when soaked in water." Should the proposed rule use a different definition of water beads?

B. NPR Scope

1. Which, if any, water pellet guns designed to shoot water bead projectiles are not children's toys within the scope of the NPR? Please provide rationale supporting your comment.

2. How, if at all, should color(s) of the water beads factor into the determination of whether they are toys, and therefore within the scope of the proposed rule? Please provide support for your recommendation.

C. Proposed Requirements To Address Ingestion Hazards

1. Are the proposed 9.0 mm diameter funnel test gauge and the 50 percent expansion limit adequate to address the hazards associated with ingestion of the product? If 9.0 mm diameter is not adequate, what size is adequate and why? If a 50 percent expansion limit is not adequate, what expansion limit is adequate and why?

2. Are there any other performance requirements CPSC should consider to address the hazards associated with water bead ingestion?

D. Proposed Requirements To Address Ear Insertion Hazards

1. Is the proposed 9.0 mm diameter funnel test gauge along with the 50 percent expansion limit adequate to address the hazards associated with ear insertion? If 9.0 mm diameter is not adequate, what size is adequate and why? If a 50 percent expansion limit is not adequate, what percentage is adequate and why?

2. What size dehydrated bead is most attractive to children regarding the risk of ear insertions and why?

3. Are there any other performance requirements CPSC should consider to address the hazards associated with ear insertion?

E. Proposed Requirements To Address Nose Insertion Hazards

1. Is the proposed 9.0 mm diameter funnel test gauge along with the 50

percent expansion limit adequate to address the hazards associated with nose insertion? If 9.0 mm diameter is not adequate, what size is adequate and why? If a 50 percent expansion limit is not adequate, what percentage is adequate and why?

2. What size dehydrated bead is most attractive to children regarding the risk of nose insertions and why?

3. Are there any other performance requirements CPSC should consider to address the hazards associated with nose insertion?

F. Proposed Requirements To Address Aspiration Hazards

1. Is the proposed 9.0 mm diameter funnel test gauge along with the 50 percent expansion limit adequate to address the hazards associated with aspiration of the product? If the 9.0 mm diameter is not adequate, what size is adequate and why? If a limit of 50 percent expansion is not adequate, what percentage is adequate and why?

2. Are there any other performance requirements CPSC should consider to address the hazards associated with water bead aspiration?

G. Water Beads Sticking Together

1. Is there evidence of water beads sticking together or are there specific water bead products that have tendency to stick together before, during, or after expansion? If so, please provide further details.

2. Is there an environment or scenario that has successfully caused expanded water beads to aggregate with themselves and/or any other substances, like food or mucus, to cause an obstruction? If so, please provide details.

H. Proposed Acrylamide Limit and Test Method

1. Is the proposed limit of 65 µg extractable acrylamide monomer from 100 small water beads or from one large water bead appropriate to adequately address the hazard of acute toxicity for children who ingest water beads?

2. The 4.0 mm demarcation between the “small” and “large” designations for water beads was selected based on CPSC staff’s observations of water bead samples prior to hydration, which tended to have diameters of equal to or less than 3.0 mm, or equal to or greater than 5.0 mm. Is another metric or method more appropriate to distinguish small and large water beads?

3. Is there an alternative, more appropriate, acute oral toxicity reference value than ATSDR’s the acute-duration oral minimal risk level that is based on valid test methods, relevant health

endpoint(s), and appropriate safety factors?

4. The chosen test value of 100 small water beads when testing for extractable acrylamide was within the range noted in incident case reports of children ingesting water beads. Is another test value for small water beads more appropriate?

5. Is CPSC’s acrylamide limit test method sufficient to evaluate extractable acrylamide in water beads? Are there other tests methods that CPSC should consider?

I. Proposed Warning Label Requirements for Water Beads

1. Are the proposed warnings adequate to address hazards associated with water beads? Should other warnings be considered? Should other warning formats be considered?

2. Regarding the proposed warning for toys that contain water beads, will consumers know what “water beads” are when warned of the dangers of “water beads” that became dislodged from the toy? Is there another term aside from “water bead” that would help consumers better identify what part of the toy is a water bead?

3. Regarding the proposed warning for toys that contain water beads, will consumers know what the warning “Discard if beads are coming out” means? Is there another term aside from “coming out” that would help consumers understand the warning?

J. Initial Regulatory Flexibility Analysis and Other Topics

1. *Significant impact.* Is CPSC’s estimated cost of redesign to achieve compliance accurate? If not, please provide additional information and support for your proposed correction. Also, do the estimated costs represent more than one percent of annual revenue for individual small U.S. manufacturers and importers?

2. *Testing costs.* Will third-party testing costs for water beads increase as a result of the requirements in this NPR, and if so, by how much? Are test labs that are currently accredited to test for ASTM F963–23 equipped to use LC–MS–MS to test for acrylamide in water beads? What other analytical test methods and equipment are appropriate for quantifying acrylamide content in the levels discussed in the NPR?

3. *Effective date.* How much time is required to come into compliance with a final rule (including product compliance and third-party testing), particularly for small businesses? Please provide supporting data with your comment.

4. *Alternatives to reduce the impact on small businesses.* Are there any alternatives to the rule that could reduce the impact on small businesses without reducing safety? Please provide supporting data with your comment, particularly addressing small businesses.

K. Feasibility

Are the proposed requirements in this NPR feasible, both technically and economically?

L. Water Bead Manufacturing

Are manufacturers able to limit the growth of water beads to a specific diameter or specific percentage of growth? If so, what is the process of adjusting growth potential?

List of Subjects

16 CFR Part 1112

Administrative practice and procedure, Audit, Consumer protection, Reporting and recordkeeping requirements, Third-party conformity assessment body.

16 CFR Part 1250

Consumer protection, Incorporation by reference, Infants and children, Labeling, Law enforcement, Toys.

For the reasons discussed in the preamble, the Commission proposes to amend 16 CFR parts 1112 and 1250 as follows:

PART 1112—REQUIREMENTS PERTAINING TO THIRD PARTY CONFORMITY ASSESSMENT BODIES

■ 1. The authority citation for part 1112 is revised to read as follows:

Authority: 15 U.S.C. 2063.

■ 2. Amend § 1112.15 by adding paragraph (b)(32)(ii)(LL) to read as follows:

§ 1112.15 When can a third-party conformity assessment body apply for CPSC acceptance for a particular CPSC rule and/or test method?

* * * * *

(b) * * *

(32) * * *

(ii) * * *

(LL) 16 CFR 1250.4, Requirements for Water Beads.

* * * * *

PART 1250—SAFETY STANDARD FOR TOYS

■ 3. Revise the heading of part 1250 to read as set forth above.

■ 4. The authority citation for part 1250 is revised to read as follows:

Authority: 15 U.S.C. 2056b.

■ 5. Revise § 1250.1 to read as follows:

§ 1250.1 Scope.

This part establishes a consumer product safety standard for toys.

■ 6. Add § 1250.4 to read as follows:

§ 1250.4 Requirements for water beads.

(a) *Scope and purpose.* This section establishes performance and labeling requirements for water bead toys and toys containing water beads to minimize the risk of children ingesting, inserting, aspirating, and choking on water beads. The provisions of this part are intended to eliminate or adequately reduce the risk of injury and death to children from water bead toy hazards. This section adds requirements for water bead toys in addition to the requirements of § 1250.2.

(b) *Definitions.* In addition to the definitions incorporated by reference in § 1250.2(a), the following definitions apply for purposes of this section:

Aspiration hazard means a hazard caused by a child inhaling a water bead whereby the water bead can become lodged in the respiratory tract and can potentially cause death or injury.

Choking hazard means a hazard caused by a child attempting to swallow a water bead whereby the water bead can become lodged in the throat and can potentially cause death or injury.

Ingestion hazard means a hazard caused by a child swallowing a water bead whereby the water bead can become lodged in the digestive tract and can potentially cause death or injury.

Insertion hazard means a hazard caused by a child putting a water bead in the ear canal or nasal passage of the body and can potentially cause injury or death.

Water bead means a various shaped water absorbent polymer, such as, but not limited to, polyacrylamide and polyacrylate, which expands when soaked in water.

(c) *Performance requirements.* In addition to the requirements of § 1250.2, all water bead toys and toys containing water beads within the scope of the rule must meet the performance requirements in this section to minimize the risk of children ingesting, inserting, aspirating, and choking on water beads.

(1) Water beads as received or water beads removed from a toy, which fit entirely inside the small parts cylinder as shown in Figure 1 to paragraph (c)(1) (16 CFR 1501.4) shall not expand more than 50 percent in any dimension and shall remain whole while also completely passing through the funnel test gauge as shown in Figure 2 to paragraph (c)(1), under its own weight

after expansion, when tested in accordance with the following test procedure:

Figure 1 to Paragraph (c)(1)—Small Parts Cylinder.

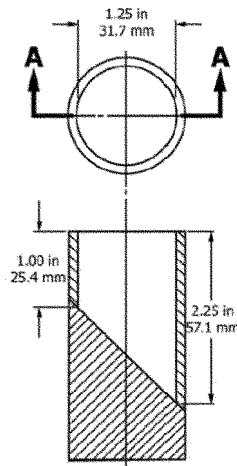
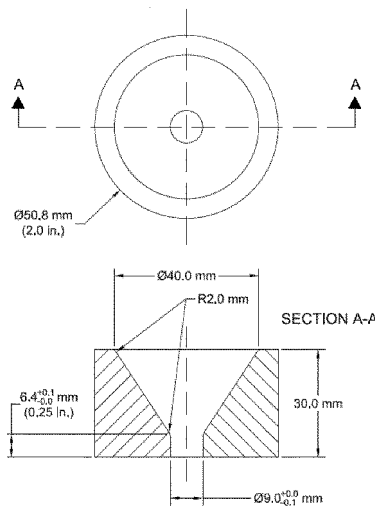

Figure 2 to Paragraph (c)(1)—Funnel Test Gauge. Material: Polytetrafluorethylene (PTFE).



(i) *Test method.* Condition the water bead or toy containing the water bead, at 20 ± 5 °C (68 ± 9 °F) and at a relative humidity of 40–65 percent for a minimum of seven hours prior to the test.

(ii) If the water bead is partially expanded, or contained within a toy and partially expanded, remove the water bead for testing and allow 120 hours to dehydrate.

(iii) Measure the bead using calipers to determine the dehydrated dimensions. If not spherical, measure in all dimensions. When measuring with calipers, do not compress the bead in a manner that will change its shape.

(iv) Submerge the water bead under a test bath of deionized water maintained at 37 ± 2 °C (98.6 ± 3.6 °F) for the

duration of immersion, without agitation. For water beads that exhibit positive buoyancy, place weight(s) (with mass just sufficient to achieve complete submersion) atop the water bead. Care should be taken to minimize contact of the test water bead with the sides or bottom of the container.

(v) Maintain submersion for 72 hours, measuring the water bead dimensions at 6 hours, 24 hours, 48 hours and 72 hours duration. If the greatest expansion was observed at 72 hours of submersion, proceed to immediately test the expanded water bead. If the greatest expansion was observed at another time interval, condition and submerge a new water bead per paragraph (c)(1)(i)–(iv) for the time interval at which the greatest expansion was observed. Then immediately test the expanded water bead.

(vi) Remove the expanded water bead and using calipers, calculate the expansion amount in all dimensions as a percentage of the dehydrated dimensions and determine whether the bead has expanded more than 50 percent in any dimension. When measuring with calipers, do not compress the bead in a manner that will change its expanded shape.

(vii) Place the expanded water bead at the top surface of the gauge's upper opening in the orientation least likely to pass through, and release allowing it to travel down until it reaches the lower opening. The expanded water bead shall remain whole and completely pass through the lower opening.

(2) *Acrylamide Limit Requirements.* Water beads shall not have more than 65 µg acrylamide extractable from 100 small water beads (defined as <4 mm across the smallest diameter of the bead prior to hydration) or from one large water bead (defined as ≥ 4 mm across the smallest diameter of the bead prior to hydration) in the test procedure described below:

(i) *Acrylamide test procedure.* To determine the amount of extractable acrylamide in water beads, first place the water beads (one large water bead or 100 small water beads) as received in a container with pH neutral deionized water.

(ii) Situate the container(s) in a shaker bath that can heat the water beads to 37 °C and shake them at a rate of 30 RPM. Leave the water beads untouched for 24 hours.

(iii) Multiple concurrent trials, or sequential repetitions, must be performed to ensure that results are reasonably consistent, given any bead-to-bead variation. For large water beads, perform three trials with one large bead per trial. For small water beads, perform

three trials with 100 small beads per trial.

(iv) Use an extraction container and volume of deionized water so that all water beads remain covered by water for the duration of the extraction period. Because water beads absorb water differently depending on their various sizes, additional tests may need to be conducted before starting the extractions to determine a volume of water that allows for full growth and coverage of the water beads without unnecessarily diluting the concentration of extracted acrylamide. Select containers that will not compress the

water beads at any point during the 24-hour extraction period.

(v) Cover the containers to prevent evaporation of the water during the extraction.

(vi) Following the extraction, determine the volume of remaining water for each trial. Analyze the remaining water to determine the mass of acrylamide present using an instrument that can quantitate acrylamide at levels equal to or less than the limit.

(d) *Labeling requirements.* All water bead toys and packaging of toys containing water beads within the scope

of the rule must meet the marking, labeling, and instructional literature requirements in this section to minimize the risk of children ingesting, inserting, aspirating, and choking on water beads.

(1) *Requirements for Marking and Labeling.* (i) Water bead toys, packaging of water bead toys, and the container of water beads, if provided, must include the safety alert symbol, signal word, and word message as shown in Figure 3 to paragraph (d)(1)(i).

Figure 3 to Paragraph (d)(1)(i)—Warning for Water Bead Toys and Packaging.

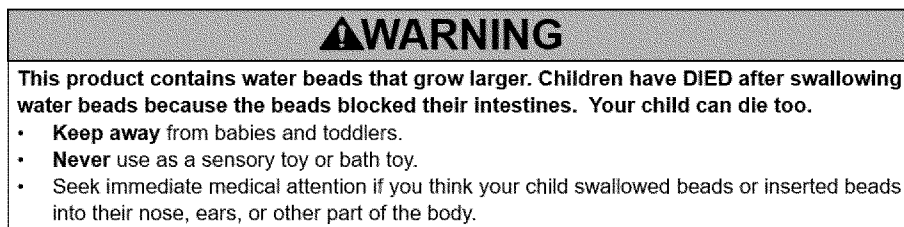

(ii) Products with contained water beads, such as balls filled with water beads, and the packaging must include

the safety alert symbol, signal word, and word message as shown in Figure 4 to paragraph (d)(1)(ii):

Figure 4 to Paragraph (d)(1)(ii)—Toys That Contain Water Beads.

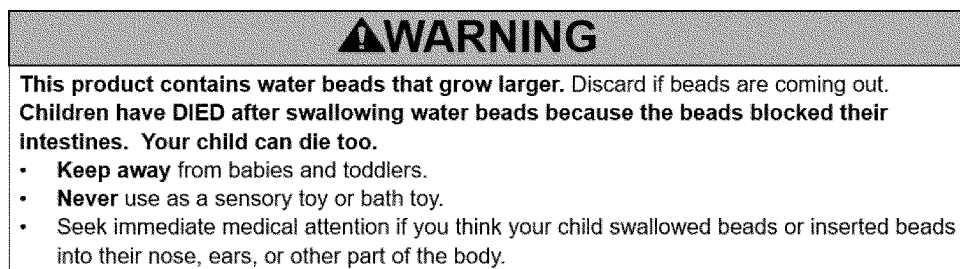

(iii) Products with contained water beads that do not have packaging must have a hangtag or sticker label with the full warnings. Multiple products sold in a package or bin must be individually labeled with a hangtag or sticker.

(iv) The warnings shall be in the English language at a minimum.

(v) The warnings shall be conspicuous and permanent on the principal display panel as defined in section 3.1.62 of the version of ASTM F963 incorporated by reference in § 1250.2(a) and in a distinct color contrasting to the background on which it appears.

(vi) The warnings shall conform to ANSI Z535.4–2023, sections 6.1–6.4, 7.2–7.6.3, and 8.1, with the following changes:

(A) In sections 6.2.2, 7.3, 7.5, and 8.1.2, of ANSI Z535.4–2023 replace the word “should” with the word “shall.”

(B) In section 7.6.3 of ANSI Z535.4–2023, replace the phrase “should (when feasible)” with the word “shall.”

(C) In section X of ANSI Z535.4–2023, strike the word “safety” when used immediately before a color (for example, replace safety white” with “white”).

(vii) Certain text in the message panel must be in bold and in capital letters as shown in the example warning labels in figures 3 and 4 to paragraph (d)(1)(ii). Text must use black lettering on a white background or white lettering on a black background.

(viii) The message panel text shall appear in sans serif letters and be center or left aligned. Text with precautionary (hazard avoidance) statements shall be preceded by bullet points.

(ix) Multiple precautionary statements shall be separated by bullet points if paragraph formatting is used.

(x) The safety alert symbol  and the signal word “WARNING” shall appear in sans serif letters and be at least 1/8” (3.2mm) high and be center or left aligned. The remainder of the text shall be in characters whose upper case shall be at least 1/16” (1.6mm) high.

(xi) The safety alert symbol, an exclamation mark in a triangle, when used with the signal word, must precede the signal word. The base of the safety alert symbol must be on the same horizontal line as the base of the letters of the signal word. The height of the safety alert symbol must equal or exceed the signal word letter height. The exclamation mark must be at least half the size of the triangle centered vertically.

(2) *Requirements for Instructional Literature.* Instructions shall have the same warning labels that must appear on the product packaging, with similar formatting requirements, but without the need to be in color. However, the signal word and safety alert symbol shall contrast with the background of the signal word panel, and the warnings shall contrast with the background of the instructional literature.

(e) *Incorporation by reference.* The Director of the Federal Register approves the incorporation by reference of ANSI Z535.4–23, *American National Standard for Product Safety Signs and Labels* (approved December 14, 2023) in paragraph (d) of this section in accordance with 5 U.S.C. 552(a) and 1 CFR part 51. This material is available for inspection at the U.S. Consumer Product Safety Commission and at the National Archives and Records Administration (NARA). Contact the U.S. Consumer Product Safety Commission at: the Office of the Secretary, U.S. Consumer Product Safety Commission, 4330 East West Highway, Bethesda, MD 20814, telephone (301) 504–7479, email: cpsc-os@cpsc.gov. For information on the availability of this material at NARA, email fr.inspection@nara.gov, or go to: www.archives.gov/federal-register/cfr/ibr-locations.html. A free, read-only copy of the standard is available for viewing on the ANSI website at <https://ibr.ansi.org/Standards/nema.aspx>. You may also obtain a copy from American National Standards Institute (ANSI), 1899 L Street NW, 11th Floor, Washington, DC 20036, www.ansi.org.

Alberta E. Mills,

Secretary, Consumer Product Safety Commission.

[FR Doc. 2024–19286 Filed 9–6–24; 8:45 am]

BILLING CODE 6355–01–P

DEPARTMENT OF THE TREASURY

Alcohol and Tobacco Tax and Trade Bureau

27 CFR Parts 4, 5, 19, 24, 26, and 27

[Docket No. TTB–2022–0004; Notice No. 210A, Ref: Notice No. 210]

RIN 1513–AC86

Standards of Fill for Wine and Distilled Spirits

AGENCY: Alcohol and Tobacco Tax and Trade Bureau, Treasury.

ACTION: Supplemental notice of proposed rulemaking; reopening of comment period.

SUMMARY: The Alcohol and Tobacco Tax and Trade Bureau (TTB) is reopening the comment period for a proposed rule (Notice No. 210) published on May 25, 2022, which proposed changes to the authorized standards of fill for wine and distilled spirits, to solicit comments on additional suggestions raised in public comments made in response to Notice No. 210 that go beyond the scope of the original proposal. In Notice No. 210, TTB proposed to add 10 authorized standards of fill to those already authorized for wine, and alternatively, eliminating all but a minimum standard of fill for wine containers and all but a minimum and maximum for distilled spirits containers. TTB did not propose any specific standards of fill for distilled spirits as an alternative to generally eliminating them. TTB received a number of comments in response to the notice of proposed rulemaking requesting that TTB add specific new standards of fill for distilled spirits, as well as for wine, and also requesting that TTB consider eliminating the distinction between the standards of fill for distilled spirits in cans and those for distilled spirits in containers other than cans. TTB is now reopening the public comment period based on these suggestions, to provide notice to stakeholders that TTB is considering these additional requests for potential inclusion in the final rule and to also provide an opportunity for stakeholders to submit additional information to assist TTB in assessing whether to incorporate some, all, or none of these proposals into the final rule.

DATES: The comment period for the proposed rule published on May 25, 2022 (87 FR 31787), is reopened. TTB must receive your comments on or before October 9, 2024.

ADDRESSES: You may electronically submit comments to TTB on this document, and view copies of this document, the original notice of proposed rulemaking, supporting materials, and any comments TTB receives on it within Docket No. TTB–2022–0004 as posted at <https://www.regulations.gov>. A direct link to that docket is available on the TTB website at <https://www.ttb.gov/laws-regulations-and-public-guidance/laws-and-regulations/all-rulemaking> under Notice No. 210A. Alternatively, you may submit comments via postal mail to the Director, Regulations and Ruling Division, Alcohol and Tobacco Tax and Trade Bureau, 1310 G Street NW, Box 12, Washington, DC 20005. Please see the Public Participation section of this document for further information on the comments requested regarding this proposal and on the submission, confidentiality, and public disclosure of comments.

FOR FURTHER INFORMATION CONTACT: Caroline Hermann, Regulations and Rulings Division, Alcohol and Tobacco Tax and Trade Bureau, 1310 G Street NW, Box 12, Washington, DC 20005; phone 202–453–1039, ext. 175.

SUPPLEMENTARY INFORMATION:

I. Background

A. Authority

The Alcohol and Tobacco Tax and Trade Bureau (TTB) administers regulations setting forth standards of fill for containers of beverage distilled spirits and wine products distributed within the United States.

The authority to establish these standards is based on two provisions of law: (1) Section 5301(a) of the Internal Revenue Code of 1986 (IRC), codified at 26 U.S.C. 5301(a) in the case of distilled spirits,¹ and (2) section 105(e) of the Federal Alcohol Administration Act (FAA Act), codified at 27 U.S.C. 205(e), for both distilled spirits and wine.

¹ Sections 5041(e) and 5368 of the IRC also provide the Secretary the authority to set forth tax tolerances for containers of wine products.