

June 1996

NAVY AVIATION

F/A-18E/F will Provide Marginal Operational Improvement at High Cost





United States
General Accounting Office
Washington, D.C. 20548

National Security and
International Affairs Division

B-260367

June 18, 1996

Congressional Committees



The F/A-18E/F program is one of the Department of Defense's most costly tactical aviation programs. We reviewed the F/A-18E/F program as part of our overall review of the Navy's efforts to modernize its tactical aircraft fleet. We included the F/A-18C/D, F/A-18E/F, and DOD's plans for the next generation Joint Strike Fighter in our review.

Our review objectives were to (1) determine whether operational deficiencies in the F/A-18C/D cited by the Navy to justify the need for the F/A-18E/F have materialized and, if they have, the extent to which the E/F would correct them, (2) ascertain whether the F/A-18E/F will provide an appreciable increase in operational capability over the F/A-18C/D, and (3) review the reliability of the cost estimates for the F/A-18E/F and compare those estimates with the costs of potential alternatives to the E/F program.

Given the high cost and marginal operational improvements that the F/A-18E/F would provide, this report recommends that the Secretary of Defense reconsider the decision to produce the F/A-18E/F aircraft and, instead, consider procuring additional F/A-18C/Ds until the next generation strike fighter achieves operational capability. We also suggest that the Congress, in considering DOD's fiscal year 1997 budget request, may wish to direct that no funds may be obligated for procurement of the F/A-18E/F until alternatives to the E/F program are fully considered.

We believe that implementing our suggested approach could result in savings of almost \$17 billion. We are addressing this report to you because of your jurisdiction over this issue.

Please contact me at (202) 512-4841 if you or your staff have any questions concerning this report. Major contributors to this report are listed in appendix IV.

Louis J. Rodrigues
Director, Defense Acquisitions Issues

B-260367

List of Congressional Committees

The Honorable Strom Thurmond
Chairman
The Honorable Sam Nunn
Ranking Minority Member
Committee on Armed Services
United States Senate

The Honorable Ted Stevens
Chairman
The Honorable Daniel K. Inouye
Ranking Minority Member
Subcommittee on Defense
Committee on Appropriations
United States Senate

The Honorable Floyd Spence
Chairman
The Honorable Ronald V. Dellums
Ranking Minority Member
Committee on National Security
House of Representatives

The Honorable C.W. Bill Young
Chairman
The Honorable John P. Murtha
Ranking Minority Member
Subcommittee on National Security
Committee on Appropriations
House of Representatives

Executive Summary

Purpose

The F/A-18E/F program, at a projected total program cost of \$63.09 billion (fiscal year 1996 dollars)/\$89.15 billion (then-year dollars),¹ is one of the most costly aviation programs in the Department of Defense (DOD). It is the successor to several unsuccessful attempts to modernize the Navy's tactical aviation fleet and is intended to complement and eventually replace the Navy's F/A-18C/D and F-14 aircraft. GAO's review focused on determining whether continued development of the F/A-18E/F is the most cost-effective approach to modernizing the Navy's tactical aircraft fleet. Specific objectives were to (1) determine whether operational deficiencies in the F/A-18C/D cited by the Navy to justify the need for the F/A-18E/F have materialized and, if they have, the extent to which the E/F would correct them, (2) ascertain whether the F/A-18E/F will provide an appreciable increase in operational capability over the F/A-18C/D, and (3) review the reliability of the cost estimates for the F/A-18E/F and compare those estimates with the costs of potential alternatives to the E/F program.

Background

The Navy performs its carrier-based missions with a mix of fighter (air-to-air), strike (air-to-ground), and strike/fighter (multirole) aircraft. Currently, carrier-based F-14 fighter aircraft perform the air-to-air missions; A-6Es perform the air-to-ground missions; and F/A-18s perform the air-to-air and air-to-ground missions.

Since the late 1980s, the Navy has participated in several unsuccessful joint service programs to replace its A-6E attack aircraft with stealth aircraft. Initial efforts began with the A-12 program, but that program was terminated in 1991 for technical and cost reasons. The Navy continued its modernization efforts through a new program designated the A/F-X, and requested funding to upgrade its F/A-18² through a modification program designated the F/A-18E/F. In 1993, DOD's Bottom-Up Review concluded that DOD could not afford all of its aviation programs and recommended termination of the A/F-X program. However, the Bottom-Up Review recommended that the F/A-18E/F program continue and that a new program, the Joint Advanced Strike Technology (JAST) program, be

¹Then-year dollar expenditures include estimated inflation for the years in which the expenditures are expected to occur; constant dollar expenditures, by holding purchasing power constant, eliminate the effect of inflation. The total program cost has recently been reduced to \$80.96 billion (then-year dollars) based on revised economic assumptions that lowered annual inflation indexes from 3 percent to 2.2 percent.

²The first major upgrade to the F/A-18 fleet resulted in the F/A-18C/D. First delivery of the C/Ds began in late 1987.

initiated to seek ways to make the services' next generation strike aircraft more affordable.

The F/A-18E/F program, which originated from the 1988 Hornet 2000 study conducted by the Naval Air Systems Command and McDonnell Douglas Aerospace Corporation, was approved as a Major Modification program on May 12, 1992. The total program cost, estimated to be \$63.09 billion (fiscal year 1996 dollars)/\$89.15 billion (then-year dollars), is comprised of \$5.783 billion (fiscal year 1996 dollars)/\$5.803 billion (then-year dollars) in development costs, and \$57.31 billion (fiscal year 1996 dollars)/\$83.35 billion (then-year dollars) in procurement costs for 1,000 aircraft. Initial operational capability is scheduled for 2000, with fielding of the first operational carrier-based squadron scheduled for 2003. Procurement of the E/F is scheduled to continue through 2015.

The Commission on Roles and Missions of the Armed Forces, in its May 1995 report, concluded that DOD may have greater quantities of strike aircraft and other deep attack weapon systems than it needs. The commission recommended, and DOD agreed to conduct, a DOD-wide cost-effectiveness study focused on finding the appropriate combination and quantities of deep attack capabilities currently fielded and under development by all the services.

In conducting its review, GAO acquired Navy data that the service used to project operational deficiencies in the F/A-18C/D and compared that data with the current C/D operational performance to determine whether the projected deficiencies had materialized; evaluated the Hornet 2000 study, acquisition reports, operational requirements documents, and engineering and test data that DOD used in justifying the F/A-18E/F program; and obtained and evaluated E/F procurement cost data that the Navy provided to the Congress.

Results in Brief

As of December 31, 1995, the Navy had spent about \$3.75 billion (then-year dollars) on the development phase of the F/A-18E/F program. DOD's next major decision is whether to proceed into the estimated \$57.31 billion (fiscal year 1996)/\$83.35 billion (then-year dollars) procurement program to manufacture 1,000 aircraft.

The operational deficiencies in the F/A-18C/Ds that the Navy cited in justifying the F/A-18E/F either have not materialized as projected or can be corrected with nonstructural changes to the C/D. Furthermore, E/F

operational capabilities will only be marginally improved over the C/D model. In addition, although the E/F will have increased range over the C/D model, the C/D's range will exceed the range required by the E/F's system specifications and the E/F's range increase is achieved at the expense of its aerial combat performance. Also, modifications to increase the E/F's payload have created a problem when weapons are released from the aircraft that may reduce the E/F's potential payload capability.

Over the years, the Navy has improved the operational capabilities of the F/A-18C/D so that procuring more of them, rather than the new model E/F aircraft, could be the most cost-effective approach to modernizing the Navy's tactical aircraft fleet in the mid-term. In that regard, additional upgrades, should they be needed, could be made to the F/A-18C/D, which would further improve its capabilities. These upgrades include such things as a larger fuel tank for more range and strengthened landing gear and other changes to increase carrier recovery payload. Then, for the long term, the JAST program's newly designated Joint Strike Fighter could be an alternative to the F/A-18E/F. The Joint Strike Fighter operational capabilities are projected by the JAST office to be equal or superior to the F/A-18E/F at a lower unit cost.

DOD's \$43.6 million (fiscal year 1996 dollars) unit recurring flyaway cost³ estimate for the F/A-18E/F is understated. The estimate is based on a total buy of 1,000 aircraft—660 for the Navy and 340 for the Marine Corps—and an eventual annual production rate of 72 aircraft per year. However, the total number of aircraft to be procured and the annual production rate are overstated. The Marine Corps does not plan to buy the F/A-18E/F aircraft, and in 1992, the Congress questioned whether an annual production rate of 72 aircraft was affordable. GAO calculations show that reducing the number of aircraft to be procured and the annual production rate to more realistic levels will increase the unit recurring flyaway cost of the aircraft from about \$44 million to \$53 million (fiscal year 1996 dollars). This compares to \$28 million (fiscal year 1996 dollars) for the F/A-18C/D. GAO calculated that the Navy could save almost \$17 billion (fiscal year 1996 dollars) in recurring flyaway costs by buying 660 new F/A-18C/D model aircraft instead of 660 F/A-18E/F model aircraft.

³GAO used recurring flyaway costs because DOD has consistently maintained that these costs are the most appropriate to compare the costs of different aircraft. Recurring flyaway costs include costs related to the production of the basic aircraft and do not include all procurement costs. Appendix I contains a more detailed discussion of what makes up various costs and how they are calculated.

Principal Findings

F/A-18E/F Will Provide Marginal Improvements Over F/A-18C/D

The Navy justified the need for the F/A-18E/F in three key areas: increased range, the capability to return to the carrier with unused weapons and stores (referred to as carrier recovery payload), and improved survivability.

Although the F/A-18E/F range will be greater than the F/A-18C/D, the C/D could achieve strike ranges far greater than the target distances stipulated in the E/F's system specifications by flying the same high-altitude missions as the E/F. Further range improvements, should the Navy decide they are necessary, can be made to the C/D by using the larger 480-gallon external fuel tanks that are planned to be used on the E/F. Furthermore, even with increased range, both the C/D and E/F will require aerial refueling to hit most targets if low-altitude missions are flown rather than the higher altitude missions now being planned for. Additionally, the E/F's increased range is achieved at the expense of combat performance. Specifically, the E/F's limited improvement in engine thrust, coupled with the fact that the E/F is a larger aircraft than the C/D, results in the E/F having less air-to-air combat capability in sustained turn rate, maneuvering, and acceleration than the C/D.

The F/A-18C carrier recovery payload deficiency has not occurred as the Navy had predicted in 1992 when the F/A-18E/F was approved. F/A-18Cs operating in support of Bosnian operations are now routinely returning to the carrier with operational loads that exceed the Navy's stated carrier recovery payload capacity. This carrier recovery payload is currently greater than when the F/A-18C/D was introduced into the fleet in fiscal year 1988. With landing gear and other modifications, the C/D's carrier recovery payload capacity would be greater than the carrier recovery payload sought for the F/A-18E/F.

Although improvements are planned for the F/A-18E/F to increase its survivability in combat, the need for the aircraft was not justified to counter threats that could not be countered with existing or improved F/A-18C/Ds. Also, the effectiveness of the stealth improvements planned for the E/F is questionable and might better be attained at less cost with the next generation Joint Strike Fighter. For example, unlike the F/A-18E/F, which will carry all of its weapons externally, the Joint Strike Fighter will likely carry at least two air-to-ground and two air-to-air

weapons internally. This configuration will allow the Joint Strike Fighter to maximize its stealthiness and thus increase its survivability in the high-threat, early stages of a conflict.

C/D Has Space for Growth and E/F Must Resolve Payload Problems

The Navy stated that by the mid-1990s, the C/D would not have space required for new avionics systems. GAO determined that the growth deficiency has not occurred as projected and that the C/D does have space for growth. Furthermore, the use of miniaturization and modularization in future upgrades to the C/D are expected to increase the C/D's capacity to incorporate additional avionics systems.

The Navy also stated that the F/A-18E/F would provide increased payload capacity. GAO found that projected F/A-18E/F payload improvements may not occur. The E/F, with its two additional wing stations, will have increased payload capacity over the C/D. However, air flow problems around the fuselage and weapons stations, as well as the proposed E/F weapons carrying configuration that places the weapons closer to the center fuselage and closer to each other than is the case with C/D models, may preclude the E/F from safely deploying the larger payload. Furthermore, a 1,150-pound weight limitation on each of the two additional E/F stations will not allow the E/F to carry any more of the heavy precision weapons than the C/D can carry. These weapons, which include the Harpoon, Standoff Land Attack Missile, Laser Guided MK-84, Guided Bomb Unit-24, and WALLEYE II, are needed to destroy hardened targets and to maintain stand-off distances needed for improved survivability.

Joint Strike Fighter Is Predicted to Be Less Costly and More Capable Than the F/A-18E/F

Contractor concept exploration and demonstration studies for the JAST program indicated that an affordable Joint Strike Fighter can be built that would be less expensive and more capable than the F/A-18E/F. The JAST office stated that affordability is a critical characteristic for the Joint Strike Fighter. Accordingly, it has established a program objective that the Navy's version of the Joint Strike Fighter will have a unit recurring flyaway cost of \$32 million to \$40 million (fiscal year 1996 dollars) compared to \$53 million for the F/A-18E/F, depending on which contractor's concept is chosen. According to the JAST office's Joint Initial Requirements Document, the Joint Strike Fighter cost objectives are based on projected budget constraints and service needs. The Navy version of the Joint Strike Fighter is scheduled to begin delivery in 2007. It is expected to be a stand alone, stealthy, first-day-of-the-war, survivable aircraft that will not be as

dependent on other support aircraft for its survivability as the F/A-18E/F is expected to be. The operational capabilities of the Navy's Joint Strike Fighter are expected to be comparable to what DOD planned to achieve in the A/F-X aircraft. It is too soon to determine the extent to which the Joint Strike Fighter cost and performance goals will be achieved.

F/A-18E/F Will Cost More Than Currently Estimated

The F/A-18E/F production estimate is based on a total program buy of 1,000 aircraft (660 for the Navy and 340 for the Marine Corps) and an eventual annual production rate of 72 aircraft. Flyaway and total program costs vary with the total number of aircraft bought and the annual production rate. According to Marine Corps officials and the Marine Corps Aviation Master Plan, the Corps does not intend to buy any F/A-18E/Fs. Therefore, the 1,000-aircraft buy is overstated by 340 aircraft.

Furthermore, the Congress questioned whether an annual production rate of 72 aircraft is realistic, and it directed the Navy to calculate costs based on more realistic estimates of 18, 36, and 54 aircraft per year. The Navy has not yet reported revised cost estimates based on this change to production rates. However, DOD planning documents show that the annual production rate of the E/F will be cut to 36 aircraft once the Joint Strike Fighter becomes available. GAO calculated that a reduction in the total F/A-18E/F program buy to 660 aircraft and at an annual production rate of 36 aircraft would increase the aircraft's unit recurring flyaway cost from \$43.6 million to \$53.2 million (fiscal year 1996 dollars).

In fiscal year 1996 dollars, the F/A-18C/D has a unit recurring flyaway cost of \$28 million based on an annual production rate of 36 aircraft. This cost difference in unit recurring flyaway cost would result in a savings of almost \$17 billion (fiscal year 1996 dollars) if the Navy were to procure 660 F/A-18C/Ds rather than 660 F/A-18E/Fs. GAO's estimated savings do not include the cost of C/D upgrades, such as the larger 480-gallon external fuel tanks for improved range or the strengthened landing gear to increase carrier recovery payload. However, GAO's estimated savings are conservative because they also do not include planned E/F upgrades and are based on recurring flyaway costs that do not include the other items that make up total procurement costs. (See app. I for a discussion of how unit costs are computed.) Additionally, GAO's estimated savings do not include savings that would accrue from having fewer models of F/A-18 aircraft in the inventory. The cost benefits would result from having common aircraft spare parts, simplified technical specifications, and

reduced support equipment variations, as well as reductions in aircrew and maintenance training requirements.

Recommendation

Given the cost and the marginal improvements in operational capabilities that the F/A-18E/F would provide, GAO recommends that the Secretary of Defense reconsider the decision to produce the F/A-18E/F aircraft and, instead, consider procuring additional F/A-18C/Ds. The number of F/A-18C/Ds that the Navy would ultimately need to procure would depend upon when the next generation strike fighter achieves operational capability and the number of those aircraft the Navy decides to buy.

Agency Comments and GAO'S Evaluation

In its comments on GAO's draft report, DOD said that it is convinced that the fundamental reasons for developing the F/A-18E/F remain valid. Since DOD provided no data or information that GAO had not acquired and analyzed during its review, GAO has not changed its position that procuring the E/F is not the most cost-effective approach to modernizing the Navy's tactical aircraft fleet. GAO recognizes that the E/F will provide some improvements over the C/D. However, the C/D's current capabilities are adequate to accomplish its assigned missions. Based on the marginal nature of the improvements and the E/F's projected cost compared to the alternatives discussed in the GAO report, GAO believes that its recommendation that DOD reconsider its decision to produce the F/A-18E/F aircraft and, instead, consider procuring additional C/D aircraft until the next generation strike fighter becomes operationally available represents sound fiscal planning. GAO formulated its position within the context of current budget constraints, the decreased military threat environment, and statements by DOD officials, such as the Chairman of the Joint Chiefs of Staff, that DOD's current plans to upgrade its tactical aircraft fleet will not be affordable. Additionally, as GAO pointed out, the national military strategy directs that major new investments should have substantial payoff. GAO does not believe that procuring the F/A-18E/F would meet this test.

DOD's entire comments on the draft report and GAO's evaluation are included in appendix III. DOD's specific comments and GAO's evaluation regarding the key areas that DOD has cited in justifying the E/F—range, carrier recovery payload, and survivability—are summarized in the following sections.

Regarding the comparative range of the C/D and E/F, DOD stated that the F/A-18E/F Early Operational Assessment verified that the E/F will

outperform the C/D in range by 40 to 50 percent. Although GAO also reported that the E/F will have a range greater than the C/D, its analysis of the Early Operational Assessment showed that the E/F's potential range improvements are not as great as DOD claimed. The specific range data are classified, but GAO's analysis showed that the E/F's range advantage over the C/D is about half of DOD's claim. Given that the E/F will have some range advantage over the C/D, the issue is whether the E/F's range advantage justifies buying the E/F at a unit cost of about \$53 million instead of buying the C/D at a unit cost of about \$28 million (1996 dollars for 660 aircraft). In that regard, the Secretary of the Navy has stated that about 85 percent of the service's targets are within 200 miles of shore and are, therefore, within the C/D's range.⁴ Additionally, other DOD assets will be available to engage targets beyond the C/D's range. Consequently, GAO questions whether the E/F's potential range advantage justifies the increased procurement cost.

Regarding carrier recovery payload, according to DOD's comments, payload of the F/A-18C is 6,281 pounds. This shows that carrier recovery payload has not declined to 5,785 pounds as the Navy had projected. Furthermore, a waiver currently permits the F/A-18C aircraft in Bosnia to return to the carrier with more payload weight than the Navy projected would be available. However, DOD stated this waiver increases risk and would adversely affect airframe structural life—particularly in the future when heavier precision-guided munitions are deployed on the aircraft. DOD also stated that the C/D landing gear would require strengthened metal to accommodate the future munitions. The Naval Air Systems Command officials told GAO that the waiver to increase the C/D carrier landing weight has been approved as a permanent change in carrier operations. GAO's analysis of E/F program management reviews showed that newer, stronger metals will be used to produce E/F landing gear. DOD did not comment on why those metals could not also be used to strengthen the C/D landing gear if greater maximum carrier landing weight is needed.

Regarding survivability, DOD stated that the E/F has a balanced design, of which radar cross-section reduction is only one part. It cited decreases in vulnerable areas and an integrated defensive electronic warfare suite as additional survivability contributors. GAO noted that these additional survivability contributors were evaluated as part of the E/F Early Operational Assessment. The specific results of the assessment are classified, but GAO's review of the Early Operational Assessment report

⁴See U.S. Combat Air Power: Reassessing Plans to Modernize Interdiction Capabilities Could Save Billions (GAO/NSIAD-96-72, May 13, 1996).

showed that development issues associated with these contributors need to be resolved before they will be operationally effective. GAO is currently reviewing these efforts and will be reporting on them separately. Additionally, comparisons of E/F and C/D survivability also need to consider survivability enhancements that have been or are planned for the C/D. These include such things as the Enhanced Performance Engine, the ALR-67 (V)3 Advanced Special Radar Warning Receiver, and the use of standoff weapons. DOD's comments did not address these C/D survivability enhancements.

DOD also stated in its comments that GAO's recommendation was premature because the decision to procure the E/F will not be made until the first quarter of calendar year 1997, when a Defense Acquisition Board will convene for a low-rate initial production (LRIP) milestone decision. GAO does not believe that DOD should delay the decision on whether to produce the E/F until after a LRIP review. GAO's concern is not whether the E/F will ultimately be able to successfully meet its requirements, which would be a legitimate consideration for an LRIP decision. Rather, GAO believes that the comparative operational and cost data for the F/A-18C/D and E/F that it presents in its report provides an adequate basis for DOD and the Congress to make an informed decision on whether procuring the E/F is the most fiscally sound approach to providing the Navy with adequate numbers of operationally effective tactical aircraft.

Matters for Congressional Consideration

DOD requested funding in its fiscal year 1997 budget request to begin procurement of the F/A-18E/F. The Congress may wish to direct that no funds may be obligated for procurement of the F/A-18E/F until it has fully examined the alternatives to the E/F program. In that regard, the House National Defense Authorization Act for Fiscal Year 1997 (H.R. 3230, sec. 220) directed such an examination, and a DOD deep strike study is expected to be completed by the end of 1996. Delaying the authority to begin procuring the E/F would allow DOD to complete its study and time for the Congress to assess the results of the DOD study and the information in this report as it decides whether DOD should be provided funding to proceed with the F/A-18E/F program.

Contents

Executive Summary		3
Chapter 1		16
Introduction	Navy Tactical Aircraft Modernization Efforts	16
	F/A-18 Modernization Effort	17
	Objectives, Scope, and Methodology	18
Chapter 2		21
F/A-18E/F Will Provide Marginal Improvements Over F/A-18C/D	Increased Combat Range While Maintaining Combat Performance Sought for the F/A-18E/F	21
	F/A-18E/F Survivability Improvements	34
Chapter 3		39
F/A-18C/D Space Deficiency Has Not Occurred and F/A-18E/F Payload Problems Must Be Resolved	Growth Space Deficiency Has Not Occurred as Predicted	39
	F/A-18E/F Has Weapons Release Problems and Provides a Marginal Increase in Lethality	41
Chapter 4		44
The Joint Strike Fighter Is Predicted to Be More Affordable and More Capable Than the F/A-18E/F	JSF Is Predicted to Cost Less and Be More Capable Than the F/A-18E/F	44
Chapter 5		48
F/A-18E/F Will Cost More to Procure Than Currently Estimated	DOD and Congressional Concerns About F/A-18E/F Program Cost	48
	Unit Acquisition Costs Will Be Greater Than Projected	49

<hr/>			
Chapter 6 Conclusions and Recommendation	Recommendation	52	
	Agency Comments and Our Evaluation	53	
	Matters for Congressional Consideration	54	
		54	
<hr/>			
Appendixes	Appendix I: F/A-18E/F and F/A-18C/D Acquisition Cost Comparison	56	
	Appendix II: Joint Advanced Strike Technology Program	61	
	Appendix III: Comments From the Department of Defense	63	
	Appendix IV: Major Contributors to This Report	101	
<hr/>			
Tables	Table 2.1: Comparison of F/A-18C/D and F/A-18E/F Uninstalled Thrust	29	
	Table 2.2: Projected and Current Carrier Recovery Payload Capacity for Fiscal Year 1993 Procurement F/A-18Cs	32	
	Table 2.3: Routine Payload Recovery for F/A-18Cs Operating in Bosnia	34	
	Table 3.1: Effect of Replacing Avionics Systems on the F/A-18 Hornet	40	
	Table 3.2 Comparison of Selected Payloads for the F/A-18E/F and F/A-18C/D	43	
	Table I.1: Navy Unit Cost Estimates for the F/A-18E/F	58	
	Table I.2: Costs of Producing 660 F/A-18E/Fs or 660 F/A-18C/Ds in Then-Year Dollars	59	
	Table I.3: Costs of Producing 660 F/A-18E/Fs or 660 F/A-18C/Ds in Constant Fiscal Year 1996 Dollars	59	
	Table I.4: Comparison of Costs to Produce 660 F/A-18E/Fs and 660 F/A-18C/Ds in Then-Year and Constant Fiscal Year 1996 Dollars	60	
	Table II.1: Projected JSF Acquisitions by Service	61	
	<hr/>		
	Figures	Figure 2.1: F/A-18C/D and F/A-18E/F Range Comparison: Low-Altitude Mission Profile	24
Figure 2.2: F/A-18C/D and F/A-18E/F Range Comparison: High-Altitude Mission Profile		26	
Figure 2.3: F/A-18 Aircraft		28	
Figure 2.4: F/A-18C Landing on a Carrier During Bosnia Operations		33	
Figure 3.1: F/A-18C/D Weapon Stations		41	
Figure 3.2: F/A-18E/F Weapon Stations		42	

Figure 4.1: JSF Family of Three Aircraft	45
Figure I.1: Breakout of Various Program Costs	57

Abbreviations

AMRAAM	Advanced Medium Range Air-to-Air Missile
CNA	Center for Naval Analysis
DOD	Department of Defense
EOA	Early Operational Assessment
EPE	Enhanced Performance Engine
GAO	General Accounting Office
HARM	High-Speed Anti-Radiation Missile
JAST	Joint Advanced Strike Technology
JSF	Joint Strike Fighter
JSOW	Joint Standoff Weapon
LRIP	low-rate initial production
NAVAIR	Naval Air Systems Command

Introduction

The F/A-18E/F program is the successor to prior unsuccessful attempts to modernize the Navy's tactical aviation fleet. The Navy's initial focus was on replacing its high-end¹ A-6 attack aircraft. The programs that were initiated in that regard—the A-12 and then the A/F-X—were eventually canceled. The Navy also initiated studies to upgrade its multirole F/A-18 low-end² tactical aircraft. The upgraded F/A-18 effort was designated the F/A-18E/F. At a projected total program cost of \$63.09 billion (fiscal year 1996 dollars)/\$89.15 billion (then-year dollars)³ the F/A-18E/F program is one of the Department of Defense's (DOD) most costly aviation programs.

Navy Tactical Aircraft Modernization Efforts

In January 1988, the Navy awarded a fixed-price incentive contract to McDonnell Douglas Aerospace and General Dynamics Corporation to develop the Advanced Tactical Aircraft, later designated the A-12. In June 1988, the Navy and McDonnell Douglas also completed a study, known as Hornet 2000, to study upgrade options to the F/A-18 because of the long development cycle of planned future fighter aircraft. The A-12 was to begin replacing A-6Es in the mid-1990s. The Air Force was also considering a version of the A-12 to replace its high-end F-15E, and F-111 strike aircraft. On January 7, 1991, after making almost \$2.7 billion (then-year dollars) in progress payments, the Navy terminated the A-12 program because of technical and cost reasons.

Almost immediately after terminating the A-12 program, the Navy requested funding to modernize the F/A-18. A new joint Air Force and Navy program—designated A-X and later A/F-X—was also initiated to replace their high-end attack/strike aircraft with more advanced stealthy aircraft. The A/F-X was to begin fielding a more affordable Navy A-6E replacement aircraft around 2008. The A/F-X program office estimated it would cost \$22.8 billion (then-year dollars) to develop the A/F-X and \$50 million to \$100 million to procure each aircraft.

¹According to the February 1993 Report of the Defense Science Board Task Force on Aircraft Assessment, high-end tactical aircraft are used for the most demanding missions, such as theater air-superiority and autonomous deep strike.

²F/A-18A/B/C/D low-end multirole aircraft are used to handle the less demanding low-end aspects of both air-to-air and air-to-ground missions. Low-end multirole aircraft have historically cost half as much as high-end aircraft and because of this they have provided a much more affordable means of achieving an adequate force structure.

³Then-year dollar expenditures include estimated inflation for the years in which the expenditures are expected to occur; constant dollar expenditures, by holding purchasing power constant, eliminate the effect of inflation. The total program cost has recently been reduced to \$80.96 billion (then-year dollars) based on revised economic assumptions that lowered annual inflation indexes from 3 percent to 2.2 percent.

In 1993, DOD's Bottom-Up Review concluded that DOD had too many new aircraft programs and that future defense budgets would not support both the F/A-18E/F and the A/F-X program. Therefore, in accordance with the review's recommendations, the Secretary of Defense announced that the A/F-X advanced tactical aviation program would be canceled, the F/A-18E/F program would continue, and the services' efforts to field a next generation joint strike fighter aircraft would be pursued through a Joint Advanced Strike Technology (JAST) program. The family of three common aircraft that is to ultimately result from the JAST effort is called the Joint Strike Fighter (JSF).

The three JSF variants are intended to be (1) a first-day-of-the-war, survivable strike fighter aircraft to complement the F/A-18E/F for the Navy, (2) an advanced short-takeoff and vertical-landing aircraft to replace the AV-8B and F/A-18 for the Marine Corps, and (3) a multirole aircraft (primary air-to-ground) to replace the Air Force F-16 and A-10 aircraft.

F/A-18 Modernization Effort

In May 1992, the Under Secretary of Defense for Acquisition approved the Navy's Milestone IV, Major Modification F/A-18E/F. A \$5.783 billion (fiscal year 1996 dollars)/\$5.803 billion (then-year dollars) F/A-18E/F development estimate was based on the combined cost to develop the airframe and the engine and to pay other government costs. The airframe development contract was awarded to McDonnell Douglas Aerospace, with Northrop Grumman Corporation as the prime subcontractor. McDonnell Douglas makes the forward fuselage, the wings, and the aft wing/horizontal stabilizers. Northrop Grumman makes the forward center fuselage, the aft center and aft fuselage sections, and the aft fuselage vertical tail sections. The Navy has contracted with General Electric Corporation to develop the F/A-18E/F's engine. The engine will be provided to McDonnell Douglas Aerospace as a government-furnished item. Most of the avionics development costs for F/A-18E/F are not included in the E/F's development cost estimate.

As of December 31, 1995, the Navy had spent about \$3.75 billion on the development phase of the F/A-18E/F program. Initial operational capability of the F/A-18E/F is scheduled for 2000, and fielding of the first operational carrier-based squadron is scheduled for 2003. Procurement of 1,000 aircraft for the Navy and the Marine Corps is planned through 2015.

Objectives, Scope, and Methodology

We initiated this review because of the magnitude of funds involved in the F/A-18E/F program. We included the F/A-18C/D, F/A-18E/F, and JSF in our review to determine whether continued development of the F/A-18E/F is the most cost-effective approach to modernizing the Navy's tactical aircraft fleet.

In conducting our work, we evaluated data used to justify the F/A-18E/F program. We reviewed various documents, including the Hornet 2000 study; Navy documents such as acquisition reports; the Operational Requirements Document; and related cost, engineering, and test data supporting the decision to develop the F/A-18E/F. This data showed that the F/A-18E/F was approved to correct deficiencies in current F/A-18s that the Navy said existed or were projected to materialize. The F/A-18 deficiencies cited were in range, carrier recovery payload, and survivability. Improvements in F/A-18E/F growth space and payload over the F/A-18C/D were also cited by the Navy in seeking E/F approval. Our specific objectives were to

- determine whether the operational deficiencies in the F/A-18C/D that the Navy cited in justifying the E/F program have materialized and, if they have, the extent to which the F/A-18E/F would correct them;
- ascertain whether the F/A-18E/F will provide an appreciable increase in operational capability over the F/A-18C/D; and
- review the reliability of the cost estimates for the F/A-18E/F and compare those estimates with the costs of potential alternatives to the E/F program.

To accomplish these objectives, we acquired data on the current operational capabilities of the F/A-18s and the status of the F/A-18E/F development effort from the Naval Air Systems Command (NAVAIR) and the builders of the F/A-18s: McDonnell Douglas Aerospace, Northrop Grumman Corporation, and General Electric Corporation.

We obtained various studies, test results, performance data reports and interviewed Navy and contractor officials. Using these data, we conducted various analyses and calculations, which are explained in the appropriate sections of our report, to verify the deficiencies in range, carrier recovery payload and survivability predicted for the C/D, and to ascertain the probability that the E/F would correct those deficiencies.

To ascertain whether the F/A-18E/F will provide an appreciable increase in operational capability over the F/A-18C/D we focused on payload capacity and growth potential. These areas were also cited by the Navy in justifying

the E/F program. We interviewed Navy and contractor officials and reviewed data from contractor studies, system specifications, and Navy reports. We evaluated the Navy's projections that indicated that the C/D would have no growth potential to accommodate future avionics requirements. We also compared the weapons capacity of the C/D with the potential capacity of the E/F.

Additional information concerning F/A-18C/D operational deficiencies and the need for the E/F was obtained from documents and interviews with officials from the Center for Naval Analysis and the Defense Intelligence Agency.

To evaluate the validity of the F/A-18E/F procurement cost estimates, we examined the assumptions on which the estimates were based in terms of numbers of aircraft to be procured and the number of aircraft to be produced each year. We made these analyses because the Congress and DOD have expressed concerns in the past that the Navy's assumptions were not realistic, given the probable limited availability of annual funding. To make this evaluation, we acquired data and interviewed officials in the Naval Warfare's Aviation Requirements and Aviation Inventory directorates, and the Office of the Deputy Chief of Staff For Aviation within the Marine Corps. We obtained procurement cost data provided to the Congress in the annual Selected Acquisition Report and aircraft inventory data used by the Navy to calculate the E/F's projected procurement cost, which is based on a combined Navy and Marine Corps buy of 1,000 aircraft. From this data, we developed and then compared F/A-18C/D and E/F recurring flyaway cost projections.

We also compared projected E/F operational and cost projections with those of the JAST JSF. This information was acquired from the JAST program office, the Advanced Research Projects Agency (their Marine Corps Short-Takeoff Vertical Landing Strike Fighter effort was combined with JAST), and the contractor teams working on the JSF effort. The contractors are a consortium of McDonnell Douglas Aerospace, Northrop Grumman Corporation, and British Aerospace; Boeing Corporation; and Lockheed Martin Corporation. We obtained the contractors' and the JAST program office's estimates for the future JSF and calculated the cost of continuing procurement of the F/A-18C/D in lieu of proceeding with the F/A-18E/F program. Our methodology for calculating comparative costs for the C/D and E/F programs is explained in detail in appendix I where we present those cost comparisons.

Chapter 1
Introduction

DOD provided written comments on a draft of this report. The comments are presented and evaluated in their entirety in appendix III.

We conducted our review from December 1994 through December 1995 in accordance with generally accepted government auditing standards.

F/A-18E/F Will Provide Marginal Improvements Over F/A-18C/D

The F/A-18E/F is intended to replace current F/A-18C/D aircraft and to perform Navy and Marine Corps fighter escort, strike, fleet air defense, and close air support missions. The current F/A-18C/Ds have proven their value to the battle commander by providing the capability to perform diverse missions and excellent payload flexibility under dynamic wartime conditions. However, the Navy stated that in order to maintain a superior level of combat performance into the 21st century, the F/A-18 will require increased range, increased carrier recovery payload, and improved survivability. Our review determined that:

- The Navy's F/A-18 strike range requirements can be met by either the F/A-18E/F or F/A-18C/Ds. The increased range of the E/F is achieved at the expense of aerial combat performance, and even with increased range, each aircraft will still require aerial refueling for low-altitude missions against most targets.
- F/A-18C carrier recovery payload deficiency has not occurred as the Navy predicted. F/A-18Cs operating in support of Bosnian operations routinely return to the carrier with operational loads that exceed the Navy's stated carrier recovery payload capability.
- Although survivability improvements are planned for the F/A-18E/F, the aircraft was not justified to counter threats that could not be countered with existing or improved F/A-18C/Ds. Also, the effectiveness of a survivability improvement planned for the E/F is questionable and might better be attained at less cost with the next generation JSF.

Increased Combat Range While Maintaining Combat Performance Sought for the F/A-18E/F

The Navy is reporting that F/A-18E/F strike ranges are significantly greater than the specifications require. Those E/F strike range projections are based on a high-altitude mission, which results in increased fuel efficiency and range, whereas the E/F contract stipulates specifications for a low-altitude strike mission. McDonnell Douglas Aerospace data show that the F/A-18C/D can also achieve the E/F's low-altitude strike range specification if it carried the larger external fuel tanks that are planned to be used on the E/F. Navy data also shows that the C/D, without the larger external tanks, could exceed the target distances stipulated in the E/F system specifications by flying the same high-altitude mission as the E/F. Also, we found that the design changes needed to achieve the F/A-18E/F's range improvements will adversely affect its aerial combat performance relative to the F/A-18C/D. Should the Navy not be able to fly the more fuel-efficient, high-altitude mission profiles, both the E/F and the C/D will need aerial refueling to reach a majority of targets in many of the likely wartime scenarios that either aircraft would be employed.

F/A-18C/D's Strike Range
Will Exceed F/A-18E/F
Specifications

In justifying the F/A-18E/F, the Navy cited, among other factors, the F/A-18C/D's inability to perform long-range unrefueled missions against deep, high-value targets. The Navy incorporated major airframe modifications to the F/A-18E/F to increase its long-range strike capability. However, we found that the F/A-18C/D can achieve greater ranges without making modifications to its airframe. These ranges will exceed the F/A-18E/F's low-altitude range specifications.

F/A-18E/F specifications call for the aircraft to have a range of 390 nautical miles while performing low-altitude bombing with four 1,000-pound gravity bombs and using two 480-gallon external fuel tanks. This strike range is 65nm longer than the reported 325nm low-altitude strike range of the F/A-18C/D using two smaller 330-gallon external fuel tanks and carrying four 1,000-pound gravity bombs. The F/A-18E/F will achieve its greater strike range primarily from its greater internal fuel capacity and larger wings, and its larger 480-gallon external fuel tanks. In total, F/A-18E/Fs will carry 980 gallons more fuel (450 gallons external/530 gallons internal) than F/A-18C/Ds.

Larger External Fuel Tanks Will
Increase F/A-18C/D's Range

The 480-gallon tank planned to be used on the F/A-18E/F uses new filament-winding technology and a toughened resin system to produce a lightweight external fuel tank. It carries 45 percent more fuel than the 330-gallon tank, but its diameter is only 3.1 inches greater and it has the same empty weight as the 330-gallon tank. F/A-18 E/F program officials informed us that the 480-gallon tanks planned for the E/F cannot be carried by the C/D. Furthermore, current Navy operational documents will not allow 480-gallon external tanks on the C/Ds. However, we have identified McDonnell Douglas and Navy studies that state that the larger 480-gallon external fuel tanks can be used on existing F/A-18C/D aircraft.

The 1988 Hornet 2000 study, prepared by a team led by the Naval Air System Command with the Center for Naval Analyses and McDonnell Douglas assisting, addressed the issue of carrying larger 480-gallon external fuel tanks on existing F/A-18C/Ds. The study reports that "Range/radius improvements can be achieved with larger external fuel tanks. The 480 gallon fuel tank rather than the 330 gallon can be accommodated on inboard wing stations of all configurations, including the baseline."

The Office of the Secretary of Defense's March 1992 F/A-18E/F Technical Risk Assessment Team report also addressed the use of 480-gallon external fuel tanks on the E/F. This report stated that

“The 480-gallon fuel tank was initially designed for carrier use, but the production version has been modified for use on the Canadian CF-18. Additional testing must be completed to requalify the fuel tank for carrier use and the aft pylon attach point will require strengthening for the carrier environment. The modifications appear to be low risk.”

A 1991 McDonnell Douglas report, “480 Gallon External Fuel Tank,” concluded that the 480-gallon external fuel tank can be carried on the F/A-18C/D inboard wing stations for carrier operations. According to the report, use of the 480-gallon tank on the C/D does not require any structural changes to the aircraft and the 480-gallon tank can be used with all weapons qualified for the F/A-18C/D. The report also stated that the new 480-gallon tank increases the multimission capability and flexibility of the F/A-18 fighter. As shown in figure 2.1, the 480-gallon fuel tank extends the C/D strike interdiction range flying low-altitude missions with two external tanks from 325nm to 393nm.¹ This increased range exceeds the 390nm specification range for the F/A-18E/F flying the low-altitude strike mission profile.

¹According to the report, adding a 330-gallon external fuel tank to the C/D’s centerline station, with the two 480-gallon tank configuration, would further increase its range to 437nm.

Figure 2.1: F/A-18C/D and F/A-18E/F Range Comparison: Low-Altitude Mission Profile

Low-Altitude Mission Profile

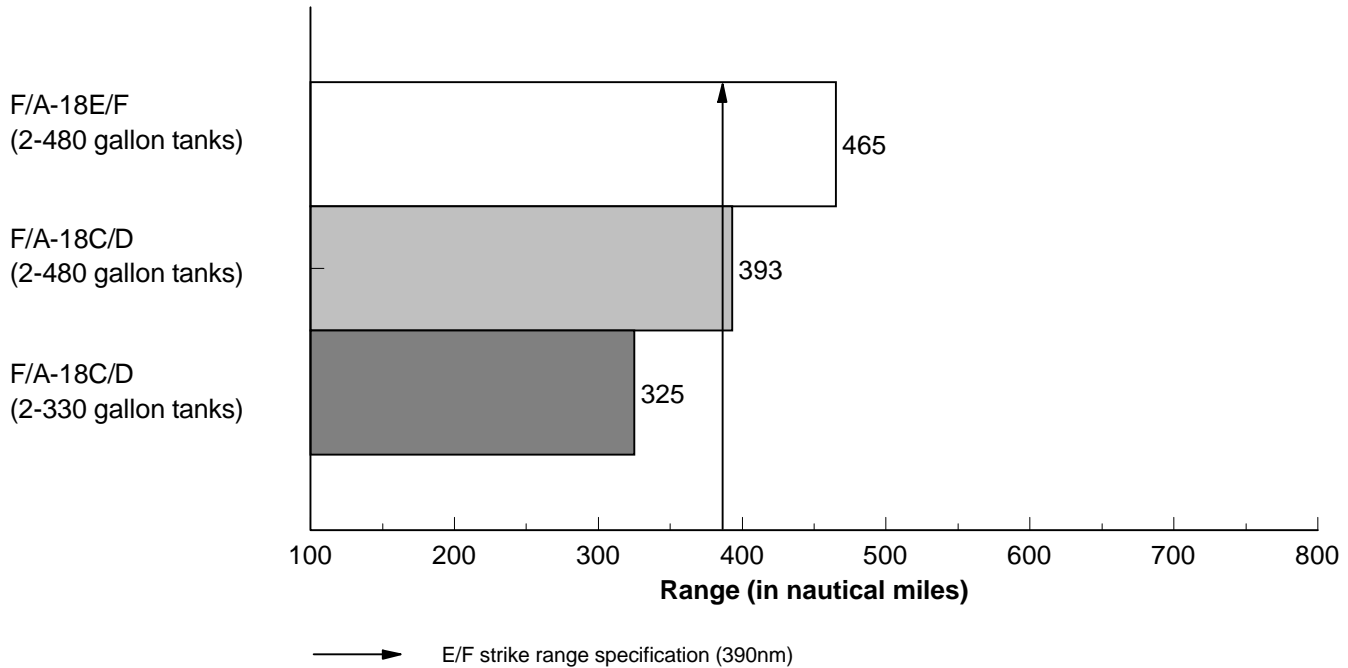

Source: McDonnell Douglas and NAVAIR.

Additionally, the McDonnell Douglas report stated that the 480-gallon tanks increase the deck cycle² time of the F/A-18C/Ds configured for a fighter escort mission, to over 3 hours. Also, the report noted that two 480-gallon tanks on the C/D effectively replace three 330-gallon tanks. This gives the mission planner the option to have the C/Ds carry additional weapons, sensors, or fuel on the centerline station.

²Deck cycle refers to the time required to launch and recover aircraft. The greater the cycle time, the more flexibility the carrier commander has to safely conduct aircraft sorties.

Flying E/F's Mission Profile
Will Also Significantly Increase
the C/D's Range

Recent Navy range predictions show that the F/A-18E/F is expected to have a 683nm strike range, carrying two 2,000-pound precision-guided bombs. The Navy plans to achieve this significant range, a range that approaches that planned for the canceled A/F-X program and the Navy's JAST variant, by flying F/A-18E/F strike missions with the larger 480-gallon tank and using a more fuel-efficient, survivable, and lethal high-altitude mission profile rather than the specified low-altitude profile.

However, as shown in figure 2.2, the same Navy predictions show that F/A-18C/D's strike ranges also increase significantly when flying at high altitudes because of increased fuel efficiency at higher altitudes. According to Navy data, the F/A-18C/D flying at high altitudes with its normal configuration of three 330-gallon external fuel tanks has a range of 566nm—176nm more than the F/A-18E/F's strike range specification.

Figure 2.2: F/A-18C/D and F/A-18E/F Range Comparison: High-Altitude Mission Profile

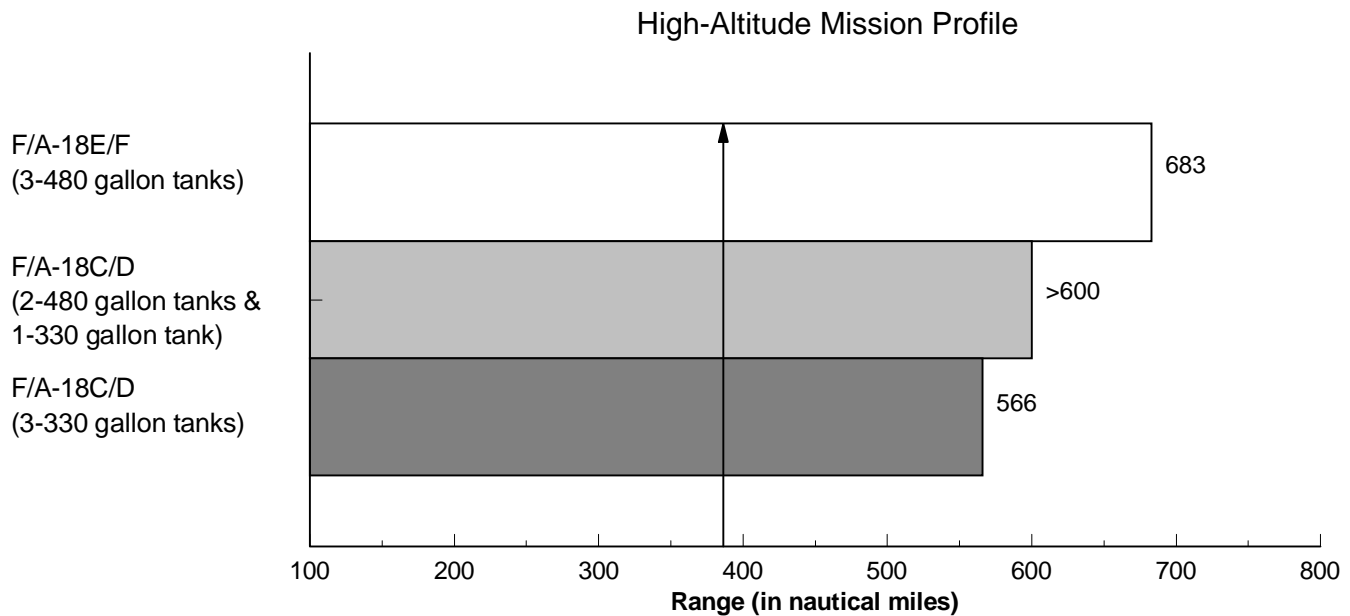

Source: NAVAIR.

**F/A-18E/F Range Increase
 Achieved at the Expense of
 the Aircraft’s Aerial
 Combat Performance**

According to Navy and contractor documents, key factors in determining combat performance of an aircraft are thrust, turn rate, and acceleration. The Navy stated that to maintain the combat performance of the larger and heavier F/A-18E/F relative to the F/A-18C/D, it would develop and incorporate new higher thrust engines. However, program data shows that the range improvements sought by the larger and heavier F/A-18E/F will be achieved at the expense of the aircraft’s combat performance and that the F/A-18E/F’s aerial combat performance in key areas will be inferior to current F/A-18C/Ds.

The F/A-18E/F’s larger fuel capacity, due to its larger size, allows the aircraft to achieve greater range than the F/A-18C/Ds. The F/A-18E’s empty weight without fuel and ordinance is about 6,100 pounds heavier than that

Chapter 2
F/A-18E/F Will Provide Marginal
Improvements Over F/A-18C/D

of the C's. The E is 4.3 feet longer than the C, and its wing area is 25 percent greater. The F/A-18E can carry about 6,600 more pounds of fuel than the F/A-18C. The F414-GE-400 engine being developed for the E/F by General Electric is designed to provide added thrust to compensate for the added weight of the aircraft and fuel. (See fig. 2.3.)

Figure 2.3: F/A-18 Aircraft



Source: McDonnell Douglas.

According to program documents, the F414-GE-400 engine generates about 22,000 pounds of uninstalled thrust,³ a 37.5-percent increase over the F404-GE-400 engine used in the F/A-18A/B and some early F/A-18C/D aircraft. However, technical manuals show that the F/A-18E/F's F414-GE-400 engine develops only 20,727 pounds of uninstalled thrust. Furthermore, the latest F/A-18C/Ds are equipped with an enhanced version of the F404 engine, known as the F404-GE-402 Enhanced Performance Engine. This new engine that was developed to meet foreign buyers' requirements for better combat performance has been adopted for Navy use. The enhanced engine increased the uninstalled thrust from 16,000 to 17,754 pounds. Consequently, as shown in table 2.1, the F/A-18E/F has about a 17-percent improvement in uninstalled thrust over the C/Ds fitted with the F404-GE-402 Enhanced Performance Engine, rather than 37.5-percent reported in program documents.

Table 2.1: Comparison of F/A-18C/D and F/A-18E/F Uninstalled Thrust

Engine	Uninstalled thrust ^a
F/A-18C/D (F404-GE-402, enhanced performance engine)	17,754
F/A-18E/F (F414-GE-400 engine)	20,727
Difference	17 percent

^aSea Level, Standard Day.

Source: NAVAIR.

This limited improvement in uninstalled thrust, coupled with a much heavier operationally loaded F/A-18E/F, means that the E/F will have less air-to-air combat capability in its sustained turn rate, maneuvering, and acceleration than F/A-18C/Ds with the enhanced performance engines.

Sustained turn rate,⁴ maneuvering,⁵ and acceleration contribute to an aircraft's combat performance and survivability by increasing its ability to

³Static, sea level, maximum power, standard day.

⁴Sustained turn rate is the maximum rate of turn, measured in degrees per second, the aircraft can sustain without losing speed.

⁵Maneuvering is expressed as instantaneous bleed rate, which is a measure of how quickly an aircraft loses speed during maneuvering.

maneuver in either offensive or defensive modes. Navy data⁶ comparing the F/A-18C to the F/A-18E shows the following:

- At sea level, the F/A-18C's sustained turn rate is 19.2 degrees per second, while the F/A-18E's sustained rate is 18 degrees per second. The instantaneous bleed rate of the F/A-18C is 54 knots per second, whereas the F/A-18E will lose 65 knots per second in a turn.
- At 15,000 feet, the F/A-18C's sustained turn rate is 12.3 degrees per second, while the F/A-18E's sustained rate is 11.6 degrees per second. The instantaneous bleed rate of the F/A-18C is 62 knots per second, whereas the F/A-18E will lose 76 knots per second in a turn.

Aircraft acceleration affects an aircraft's combat performance in a number of ways, ranging from how quickly the aircraft can reach its area of operation to its ability to close the gap in air-to-air engagements or to evade air-to-ground missiles. Navy data shows the following:

- At 5,000 feet at maximum thrust, the F/A-18C accelerates from 0.8 Mach to 1.08 Mach⁷ in 21 seconds, whereas the F/A-18E will take 52.8 seconds.
- At 20,000 feet at maximum thrust, the F/A-18C accelerates from 0.8 Mach to 1.2 Mach in 34.6 seconds, whereas the F/A-18E takes 50.3 seconds.
- At 35,000 feet at maximum thrust, the F/A-18C accelerates from 0.8 Mach to 1.2 Mach in 55.80 seconds, whereas the F/A-18E takes 64.85 seconds. The F/A-18C accelerates from 0.8 Mach to 1.6 Mach in 2 minutes 12 seconds, whereas the F/A-18E takes 3 minutes and 4 seconds.

All F/A-18s Will Need Aerial Refueling to Attack Most Targets for Low-Altitude Missions

In justifying the low-altitude 390nm strike range specification for the F/A-18E/F, the Navy cited the F/A-18C/D's shorter strike range (325nm flying the low-altitude mission profiles) and its inability to perform long-range unrefueled missions. Current Navy modeling projects that the F/A-18E/F will have a strike range of 465nm when flying the specified low-altitude mission profile, or 75nm greater than the 390nm development specification. However, the Center for Naval Analysis reported that with these ranges, the F/A-18E/F and F/A-18C/D will both need aerial refueling to reach most targets in two of the most likely wartime scenarios if high-altitude mission profiles are not flown.

⁶Weapons load is 2 AIM-9 and 2 AIM-120 carried externally, no external fuel tanks and 60 percent fuel remaining. F/A-18E data are Navy estimates.

⁷At sea level, the maximum speed of the F/A-18 is limited and cannot reach 1.2 Mach.

A 1993 Center for Naval Analysis⁸ report indicates that the E/F, even with its range improvement over the F/A-18C/D, would require in-flight refueling to reach a majority of targets in many of the likely wartime scenarios in which the E/F would be employed. The Center's 1993 report was consistent with its 1989⁹ report that concluded that an upgrade to the F/A-18C/D (now identified as the F/A-18E/F) would probably retain its need for in-flight refueling. Therefore, according to the 1989 report, the desire for additional internal fuel should not be the driving force in the design of the F/A-18E/F.

F/A-18C Carrier Recovery
Payload Deficiency Has
Not Occurred as Predicted

The Navy cited an anticipated deficiency in F/A-18C carrier recovery payload capacity¹⁰ as one of the primary reasons for developing the F/A-18E/F. In 1992, when seeking approval for the F/A-18E/F, the Navy stated that F/A-18Cs procured in fiscal year 1988 had a total carrier recovery payload capacity of 6,300 pounds. However, it projected that F/A-18C enhancements planned through the fiscal year 1993 procurement (delivery in fiscal year 1995)(Lot XVII) would increase the aircraft's operating weight and decrease its total carrier recovery capacity to 5,785 pounds. It said this condition would constrain the ability of the carrier's air wing to fulfill its full spectrum of training requirements—especially under the worse case scenario of conducting night training and carrying greater amounts of reserve fuel needed for a divert field landing.

As shown in table 2.2, the F/A-18C carrier recovery payload capacity is substantially greater than the Navy projected it would be and, in fact, is greater than when the F/A-18C was introduced into the fleet in late 1987.

⁸Analysis of AX Design Range, Center for Naval Analysis (CRM 93-2, Mar. 1993).

⁹F/A-18 Upgrade Project, Center for Naval Analysis (CRM 88-74, Mar. 1989).

¹⁰Carrier recovery payload is defined as the amount of fuel, weapons, and external equipment (such as navigation and targeting pods) that an aircraft can carry when landing on a carrier. It is the computed difference between maximum landing weight and the aircraft operating weight.

Table 2.2: Projected and Current Carrier Recovery Payload Capacity for Fiscal Year 1993 Procurement F/A-18Cs

Capacity in pounds	F/A-18C carrier recovery payload	
	Projected capacity ^a (Navy's estimate)	Current capacity (our calculation)
Maximum carrier landing weight	33,000	34,000
Total operating weight	-27,215	-26,987
Total carrier recovery payload	5,785^b	7,013^b

^aBased on Navy's 1992 projection of mid-1990's capacity.

^bIncludes 5,000 pounds of reserve fuel.

As indicated in table 2.2, current F/A-18Cs have 7,013 pounds of carrier recovery payload capacity, rather than the 5,785 pounds the Navy predicted. The higher carrier recovery payload capacity calculation is the result of

- the Navy, in 1994, increasing the F/A-18C's maximum allowable carrier landing weight from 33,000 to 34,000 pounds, thereby adding 1,000 pounds to the payload and
- (1) replacement of the canceled Advanced Self Protection Jammer with a lighter system, the ALQ-126 and (2) a prior overestimate of weight needed for contingencies.

The F/A-18C's better than projected carrier recovery payload is being demonstrated during actual flight experience of the F/A-18Cs flying military operations in Bosnia. (See fig. 2.4.)

Figure 2.4: F/A-18C Landing on a Carrier During Bosnia Operations



Source: Reuters/Archive Photos.

According to data provided by the F/A-18 program office, as shown in table 2.3, F/A-18Cs routinely bring back 7,156 pounds of recovery payload.

**Table 2.3: Routine Payload Recovery
for F/A-18Cs Operating in Bosnia**

Weight in pounds	
Item	Weight
1 High-speed anti-radiation missile	778
2 Guided bomb unit-12s	1,220
Forward looking infrared radar pod	371
2 AIM-9 Sidewinders	390
3 External tanks	897
Total munitions	3,656
Fuel reserve	3,500
Total carrier recovery payload	7,156

The Navy achieved this recovery payload by increasing the F/A-18C's maximum landing weight to 34,000 pounds and decreasing the reserve fuel level from 5,000 to 3,500 pounds.

The Navy has stated that although it is currently able to bring back a full operational load of existing weapons, it will not be able to bring back the heavier, more expensive precision-guided munitions planned for the future. Because the Navy has demonstrated the ability to manage the recovery payload of the F/A-18C by increasing the maximum landing weight of the F/A-18C by 1,000 pounds for Bosnian operations, we attempted to determine whether the maximum landing weight could be further increased to compensate for future munitions. Navy program officials did not know whether the maximum landing weight could be increased further; however, the Hornet 2000 Technical Report states that the carrier landing design gross weight of the F/A-18C can be increased to 37,000 pounds with landing gear and other changes, thereby providing an additional 3,000 pounds of recovery payload. Adding this weight to the total carrier recovery payload shown in table 2.2 would result in a total recovery payload of 10,013 pounds for the F/A-18C. That amount of carrier payload recovery for the F/A-18C is greater than the 9,000 pounds of payload sought for the F/A-18E/F.

F/A-18E/F Survivability Improvements

The Navy is seeking to improve F/A-18E/F survivability compared to the current F/A-18C/D by reducing its detectability and the probability of it being destroyed. Although survivability improvements for the F/A-18E/F are planned, the F/A-18E/F was not justified to counter a particular military threat that could not be met with current F/A-18C/Ds or F/A-18C/Ds that will be enhanced by additional planned survivability features. In addition, the effectiveness of an F/A-18E/F survivability improvement is questionable. Moreover, the JSF represents an alternative,

affordable next generation aircraft that is projected to surpass the survivability of the F/A-18E/F at less cost.

F/A-18E/F Survivability Increases Not Driven by F/A-18C/D Survivability Deficiency

In August 1993, we reported¹¹ that the F/A-18E/F was not justified to counter a particular military threat that could not be met with current capabilities. In responding to our report, the Under Secretary of Defense for Acquisition disagreed with our conclusion that the F/A-18E/F decision was not threat based. He referred to the April 1993 “Report to Congress on Fixed-Wing Tactical Aviation Modernization,” which he stated included intelligence data on projected threats in the post-year 2000 period, which require improvements in the survivability of tactical fixed-wing aircraft. He stated that these improvements were part of the process for approving the modification of the F/A-18C/D to the F/A-18E/F. We reviewed this report and found that although this study discussed future threats, it was in system-to-system engagements, not as part of a force package where other assets are used to increase aircraft survivability. According to Navy officials, the F/A-18E/F will be operated as part of a force package—just as the F/A-18C/D currently operates. These aircraft will not operate alone as the stealthy F-22 and the Navy’s JSF are planned to be. (Chapter 4 discusses the JSF and its planned survivability features.)

The relative importance of a threat-based justification for the E/F is also supported by a March 24, 1992, memorandum from the Vice Chairman of the Joint Chiefs of Staff to the Under Secretary of Defense for Acquisition. It said that the main consideration in the timing of buying the F/A-18E/F was not an emerging threat. This is consistent with statements contained in the May 1992 F/A-18E/F Cost and Operational Effectiveness Analysis Summary.

According to the summary, the Navy’s current F/A-18 warfighting capability was expected to be adequate in dealing with the projected threat beyond the turn of the century. Further, the key components of potential threats have stabilized in response to East European political economic shifts. Also, the Commonwealth of Independent States’ emphasis on development and deployment of advanced air, ground, and naval weapons had greatly declined, particularly the anti-air warfare threat.

¹¹Naval Aviation: Consider All Alternatives Before Proceeding With the F/A-18E/F (GAO/NSIAD-93-144, Aug. 27, 1993).

Additional Features Planned to Enhance F/A-18C/D Survivability

According to the May 1992 F/A-18E/F Acquisition Plan, the aircraft's weapon system architecture was to be essentially the same as the F/A-18C/D Night Attack aircraft. An October 1995 F/A-18 program brief and a more recent Naval Intelligence study on strike warfare state that the F/A-18C is survivable against all current air-to-air threats. The October brief further states that the F/A-18C Night Strike Hornet (compared with previous F/A-18s) increased the exchange rate against the MiG-29 by a factor of 4, increased survivability against surface threats, and is 23 percent more effective in strike warfare.

Additional improvements have subsequently been made or are planned for the F/A-18C/D to enhance its survivability. For example, according to Navy program documents, improvements were made to reduce its radar detectability. Although these improvements are classified and cannot be discussed in this report, Navy and contractor officials agreed that the radar detectability has been reduced. Other improvements to the F/A-18C/D include the following:

- The F404-GE-402 Enhanced Performance Engine to provide increased combat performance and, therefore, increased survivability.
- The ALR-67(V)3 Advanced Special Warning Receiver and the ALE-47 Countermeasures Dispensing System (chaff and flares) will be installed on new F/A-18C/Ds to alert the aircrew of potential threats and automatically deploy countermeasures, thereby decreasing the probability of the aircraft being hit should it be fired on.
- Standoff weapons, such as the Joint Standoff Weapon (JSOW), Standoff Land Attack Missile-Expanded Response, improved Advanced Medium Range Air-to-Air Missile (AMRAAM), and AIM-9X to be installed on the F/A-18C/D will improve its standoff range from the threat and thus further improve its survivability.

F/A-18E/F Survivability Improvements Are Questionable

The Navy listed reduced aircraft radar signature as an objective and key measure of aircraft survivability when discussing F/A-18E/F survivability improvements. Navy and McDonnell Douglas officials said they have significantly reduced the F/A-18E/F's frontal radar signature compared to the C/D model. The specifics of how radar signature reduction is achieved are classified. However, according to Center for Naval Analysis and Navy officials, the F/A-18E/F's reduced radar signature only helps it penetrate slightly deeper than the F/A-18C/D into an integrated defensive system before being detected.

When Navy officials referred to the F/A-18E/F's reduced frontal radar signature, they cite low observability improvements made to the aircraft structure. However, because the F/A-18E/F will be carrying weapons and fuel externally, it will diminish the radar signature reduction improvements derived from the structural design of the aircraft. The need to carry weapons and fuel internally to maintain an aircraft's low observability is consistent with low observability or stealthy aircraft designs, such as the F-117, the A-12, the A/F-X, the F-22, and the B-2, all designed to carry fuel and weapons internally.

A 1994 Lockheed Corporation briefing document entitled "The Value of Stealth," discussed the value of frontal radar signature reduction and the impact on detection ranges when such things as pylons, munitions, and fuel tanks are carried externally. The brief stated that:

"While very beneficial in a one-on-one engagement, nose-on to the threat, treatments to enhance the survivability of a conventional aircraft by reducing the forward aspect observable level is not sufficient to successfully penetrate a typical threat environment. The long detection and engagement range of modern threat systems against the side sector of an Enhanced Conventional Aircraft will significantly decrease the likelihood of a successful mission."

"Further, the addition of external stores to enable an Enhanced Conventional Aircraft to accomplish a military objective, may well eliminate much of what is gained in reduced threat capability, even in the nose region."

This is further validated by the current JAST program commitment to designing its JSF to carry its weapons internally because carrying weapons externally does not meet the Navy's reduced signature needs for first day survivability. The JAST office concluded that the treatment of external equipment, to limit their negative effect on radar signature reduction, would be expensive and would have a negative effect on aircraft performance, supportability, and deployability. In summary, the JAST office has concluded that the most cost-effective and overall operational beneficial solution if low observability is required, appears to be carrying weapons and other equipment internally.

In December 1995, the F/A-18E/F program office asked McDonnell Douglas to define the work necessary to develop simple, affordable, low-observable treatments for certain equipment that will be carried externally on the E/F aircraft. The program office stated that the E/F program has produced a low-observable aircraft, but that low-observable

Chapter 2
F/A-18E/F Will Provide Marginal
Improvements Over F/A-18C/D

externally carried equipment and weapons were outside the scope of the E/F program. The program office stated that this equipment, when installed on the E/F with low-observable compatible weapons, would be necessary to yield a low-observable weapon system.

F/A-18C/D Space Deficiency Has Not Occurred and F/A-18E/F Payload Problems Must Be Resolved

In addition to the operational capability improvements discussed in the preceding chapter, the Navy also stated that the E/F (1) was needed to provide critically needed space for avionics growth and (2) with its two additional weapons stations, would be more lethal. However, our review indicates that

- the decline in avionics growth space has not occurred as predicted, and
- weight limitations, problems when weapons are released from the aircraft, and the limited increase in weapons payload associated with the new weapons stations raises concerns about how much increased lethality the E/F will have.

Growth Space Deficiency Has Not Occurred as Predicted

In justifying the need for the F/A-18E/F, the Navy stated that the additional space to be provided by the F/A-18E/F was critically needed because by the mid-1990s, the F/A-18C/Ds would not have space to accommodate some additional new weapons and systems under development without removing an existing capability. However, as previously discussed, an increased threat is not driving decisions to add new systems. Furthermore, the growth space deficiency anticipated for the F/A-18C/D has not occurred as predicted.

According to 1992 Navy predictions, by fiscal year 1996, the ongoing program to upgrade the F/A-18C/D's avionics would result in an aircraft with only 0.2 cubic feet of space available for future growth. However, in 1995, McDonnell Douglas representatives indicated that the F/A-18C had at least 5.3 cubic feet of space available for system growth. This additional space is available from the following two sources:

- Replacing the F/A-18C/D's ammunition drum with a linear linkless feed system would provide 4 cubic feet of additional space in the gun bay.
- The right leading edge extension on the F/A-18C, which is an extension of the frontal aspect of the wing, has 1.3 cubic feet of space available for growth.

Furthermore, indications are that technological advancements will result in additional avionics growth space. The effect of these advancements, which include such things as miniaturization, modularity, and consolidation, are indicated in some upgraded avionics systems employed on the F/A-18C/D. We reviewed the changes scheduled for the F/A-18C/D between fiscal years 1992 and 1996 and identified seven upgrade replacement systems that would be used in the latest versions of the

**Chapter 3
F/A-18C/D Space Deficiency Has Not
Occurred and F/A-18E/F Payload Problems
Must Be Resolved**

F/A-18C/D and the F/A-18E/F. We found that because of the reduced size of modern avionics systems, in total, the new systems provided 3 cubic feet of additional space and reduced the total avionics systems' weight by about 114 pounds. Table 3.1 shows the details of this calculation.

Table 3.1: Effect of Replacing Avionics Systems on the F/A-18 Hornet

Equipment	Old system	Replacement system	Weight (pounds)	Volume (cubic feet)
Radar	APG-65	APG-73	-12.0	-0.90
Communication receiver/ transmitter	ARC-182 (2)	ARC-210 (2)	+5.6	+0.12
Chaff countermeasures set	AN/ALE-39	AN/ALE-47	+22.7	-0.14
Missile command launch computer	AWG-25	AWG-25 MOD Downsized HARM	-11.0	+0.01
Weapon station management system	SMS	SMS (upgrade)	-71.9	-1.20
Countermeasures receiving set	ALR-67(V)2	ALR-67(V)3	-8.4	-0.30
Global positioning system	MAGR	EGI Combined GPS/INS	-38.6	-0.63
Inertial navigation system	ASN-139A			
Total			-114.0	-3.0

Source: McDonnell Douglas.

The Navy also contends that the availability for growth on the F/A-18C/D is not possible due to the lack of sufficient power and cooling capability. However, according to McDonnell Douglas engineering representatives, the F/A-18C/D's power and cooling needs have not been validated through an actual test. Rather, the statements that the C/D has no more growth capability are based on analysis using estimated and outdated data. Additionally, the Hornet 2000 study suggested options to increase power and cooling capacity within the current space/volume of the baseline F/A-18 aircraft. To increase the aircraft's power capacity, the report suggested

- a new generator system with more than a 30-percent increase in power capacity and/or
- a monitored bus system capable of shedding selected loads when one generator becomes inoperative.

To increase the F/A-18C/D's cooling capacity, the Hornet 2000 report stated that the air cooling system could be modified to increase capacity by 47 percent.

F/A-18E/F Has Weapons Release Problems and Provides a Marginal Increase in Lethality

The F/A-18E/F is designed to have more payload capacity than current F/A-18C/Ds as a result of adding two new wing weapon stations—referred to as the outboard weapon stations. However, unless the current problems when weapons are released from the aircraft are resolved, the types and amounts of external weapons that the E/F can carry may be restricted. Also, while the E/F will provide a marginal increase in air-to-air capability, it will not increase its ability to carry the heavier air-to-ground weapons that are capable of hitting fixed-targets and mobile hard targets and the heavier stand-off weapons that will be used to increase aircraft survivability.

Weapons Release Problems

As illustrated in figures 3.1 and 3.2, airframe modifications, such as larger geometrically shaped engine inlets and additional weapon stations, have reduced the critical distance between several F/A-18E/F weapon stations.

Figure 3.1: F/A-18C/D Weapon Stations

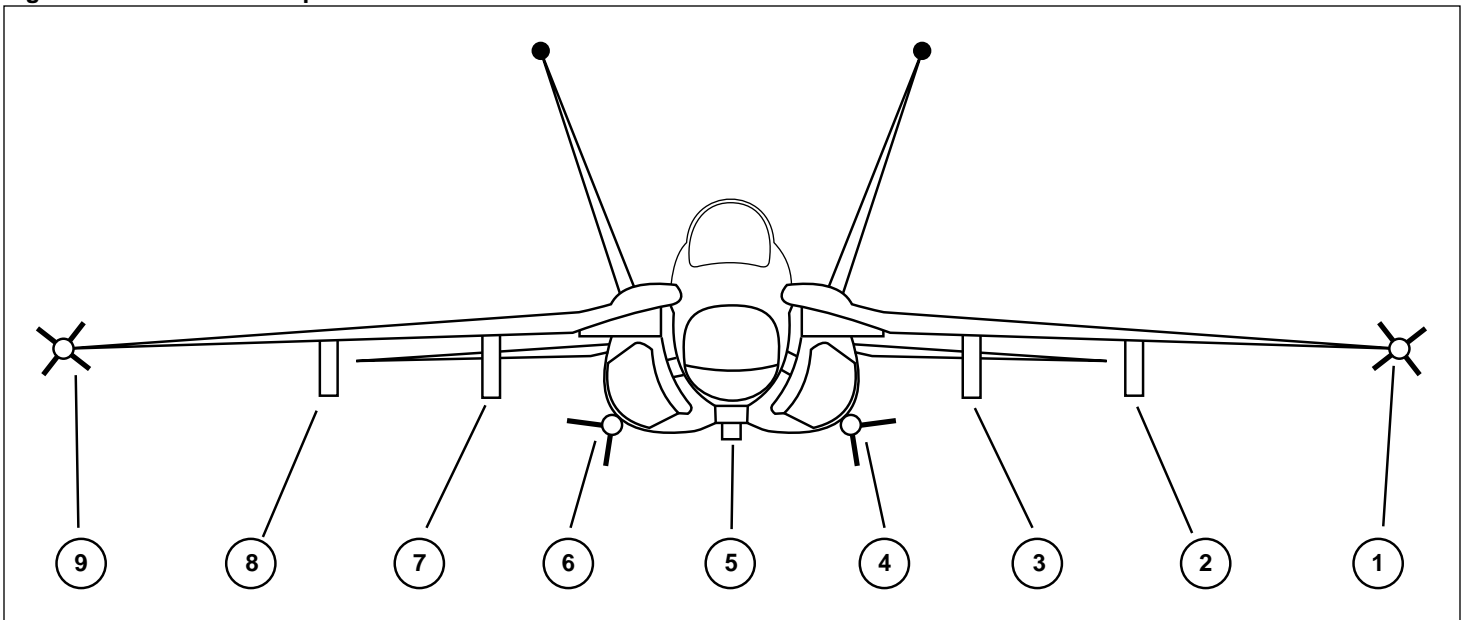

Source: NAVAIR.

Chapter 3
F/A-18C/D Space Deficiency Has Not
Occurred and F/A-18E/F Payload Problems
Must Be Resolved

Figure 3.2: F/A-18E/F Weapon Stations

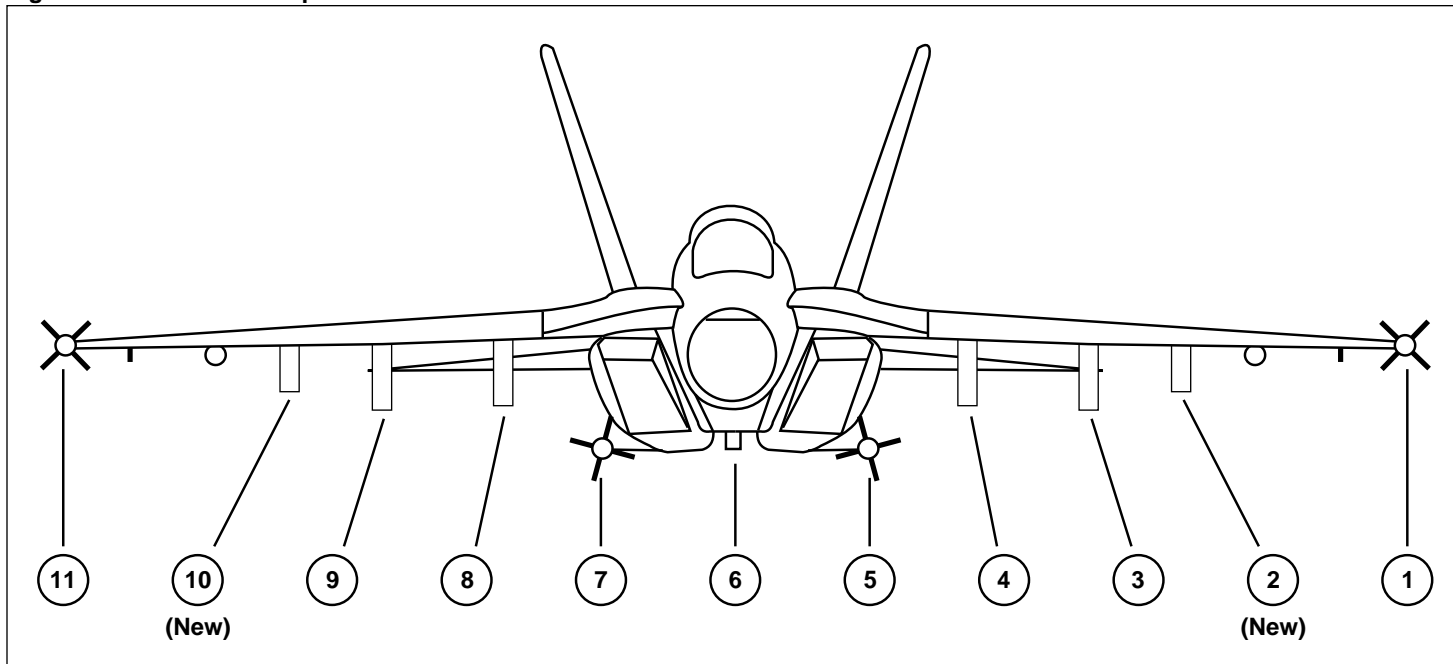

Source: NAVAIR.

A NAVAIR representative stated that it has been estimated that the distance between the inboard weapon stations and the engine inlet stations on the E/F has been reduced by about 5 inches compared to the C/D. The distance between the new outboard (stations 2 and 10) and mid-board stations (stations 3 and 9) is smaller than between the mid-board (stations 3 and 9) and inboard stations (stations 4 and 8), 35 inches versus 46 inches, respectively.

The space reduction adversely affects the E/F's capabilities. For example, wind tunnel tests show that an external 480-gallon fuel tank or a MK-84 2,000-pound bomb, carried on the inboard station, will hit the side of the aircraft's fuselage or make contact with other weapons when released. Additionally, according to the representative, the limited distance between the new outboard and mid-board stations, coupled with outboard pylons that are shorter and closer to the wing, will cause problems when releasing large, finned weapons, such as the High-Speed Anti-Radiation Missile (HARM).

Chapter 3
F/A-18C/D Space Deficiency Has Not
Occurred and F/A-18E/F Payload Problems
Must Be Resolved

F/A-18E/F airframe changes have also increased adverse airflows that exacerbate these problems. Wind tunnel testing shows that the F/A-18E/F is experiencing increased yaw and pitch motion¹ of its external equipment. The increased yaw motion is the result of increased air outflow at the nose of a weapon and increased inflow at the tail of a weapon, causing the tail of the weapon to make contact with the aircraft. Similarly, the increased pitching results from the air sweeping over the nose of a store in a downward direction while an upward airflow causes the tail of the store to make contact with the aircraft.

The Navy and McDonnell Douglas are studying a number of airframe fixes to correct the airflow problem. They are also studying options that place tactical restrictions on weapon deployments. These options include reducing the number of weapons the E/F carries and reducing the speed the aircraft is flying when the weapons are released.

Improvements in
F/A-18E/F Weapons
Carrying Capacity Are
Marginal

Our analysis showed that the F/A-18E/F will provide a limited increase in payload over the C/D model. In the air-to-air role, as shown in table 3.2, the F/A-18E/F will have a two-missile advantage over the F/A-18C/D.

The F/A-18E/F's new outboard stations are limited to carrying weapons weighing no more than 1,150 pounds per station. In the air-to-ground role, this precludes the F/A-18E/F from carrying a number of heavy precision-guided munitions such as the Harpoon, Standoff Land Attack Missile, Laser Guided MK-84, Guided Bomb Unit-24, and WALLEYE II that weigh more than the weapon station weight limit. Consequently, because of these limitations, the F/A-18E/F will carry the same number of these heavier precision-guided munitions as the F/A-18C/D.

Table 3.2 Comparison of Selected Payloads for the F/A-18E/F and F/A-18C/D

Weapon	F/A-18C/D	F/A-18E/F	Difference
AIM-120 AMRAAM	6	8	+2
AIM-9 Sidewinder	6	8	+2
AIM-7 Sparrow	4	6	+2

Source: McDonnell Douglas and NAVAIR.

¹Yaw is the side-to-side movement, and pitch is the up-and-down movement of the nose and tail of external equipment.

The Joint Strike Fighter Is Predicted to Be More Affordable and More Capable Than the F/A-18E/F

The JAST program office is developing technology for a family of affordable next generation JSF aircraft for the Air Force, Marine Corps, and Navy. (See app. II for a discussion of JAST program objectives and approach.) The Navy plans to procure 300 JSFs and use them as a stand alone, first-day survivable (stealthy) complement to the F/A-18E/F. The first Navy JSF aircraft is scheduled to be delivered in 2007. On the basis of contractor trade studies and a recent Naval Intelligence assessment, JSF is projected to have an overall combat effectiveness greater than the F/A-18E/F. JSF is also projected to have a lower unit flyaway cost than the E/F.

JSF Is Predicted to Cost Less and Be More Capable Than the F/A-18E/F

Concept exploration and development trades studies from three major potential aircraft production contractors—Boeing Corporation; Lockheed Martin Corporation; and a consortium of McDonnell Douglas Aerospace, Northrop Grumman, and British Aerospace Corporations—indicated that an affordable family of stealthy strike aircraft could be built on a single production line with a high degree of parts and cost commonality. (See fig. 4.1 for JAST concept.) According to the JAST Joint Initial Requirements Document, the recurring flyaway cost of the Navy variant will range from \$33 million to \$40 million (in fiscal year 1996 dollars), depending on which contractor design is chosen. The JAST office projects that the Navy's JSF variant will have operational capabilities, especially range and survivability, that will be superior to the F/A-18E/F. It is too soon to determine the extent to which the JSF cost and performance goals will be achieved.

Chapter 4
**The Joint Strike Fighter Is Predicted to Be
 More Affordable and More Capable Than the
 F/A-18E/F**

Figure 4.1: JSF Family of Three Aircraft

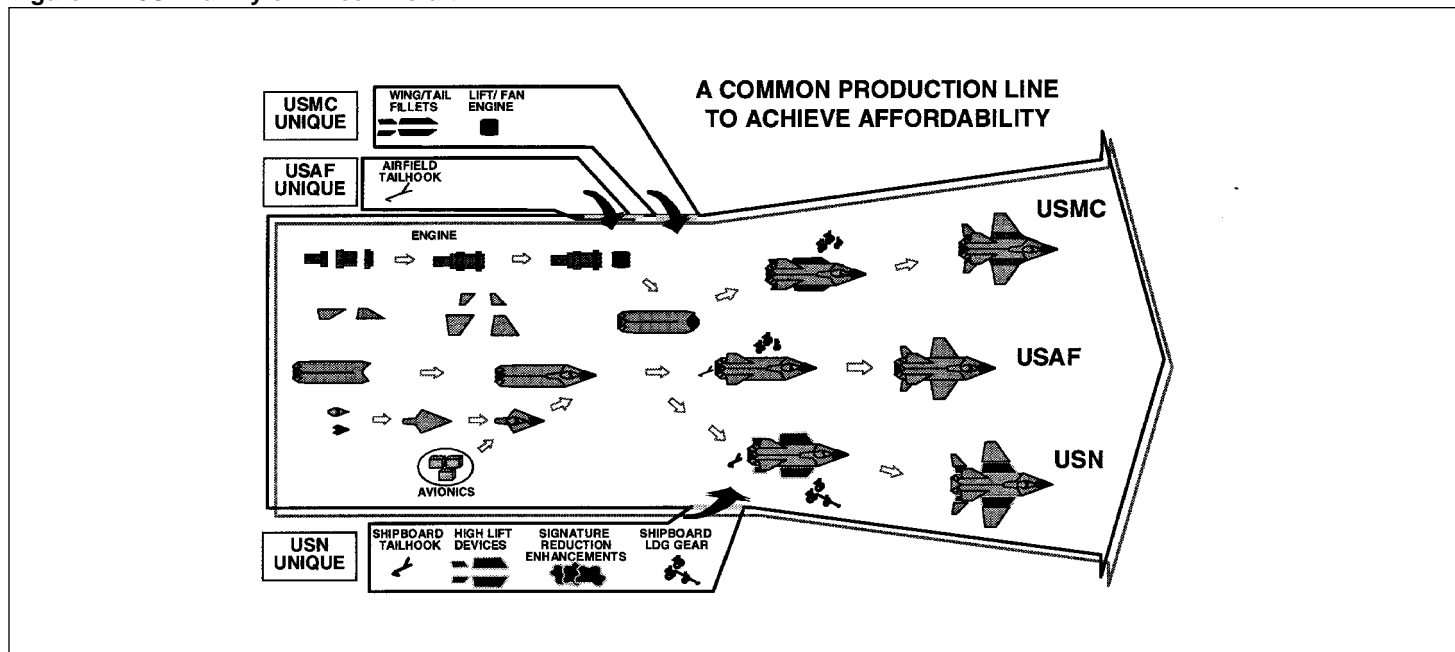

Source: JSF Program Office.

**JSF Predicted to Cost Less
 Than the F/A-18E/F**

The driving focus of JAST is affordability. Contractor studies indicate that JAST has the potential to reduce total life-cycle cost by approximately 40 percent. Life-cycle cost is made up of research and development costs, production costs, and operations and support costs. According to a McDonnell Douglas study, their JAST proposal would have a flyaway cost 14 percent lower than the F/A-18E/F. To arrive at these goals, the contractor studies concluded that the family of aircraft would have to contain such features as:

- a single, common engine;
- use of advanced avionics and exploitation of off-board sensors;
- advanced diagnostics to reduce supportability costs;
- maximum commonality to include a common fuselage for all service variants that could be built on a common production line; and
- affordable requirements.

According to the participating contractors and the JAST program office, tri-service commonality is the key factor in achieving JSF affordability

goals, and if this commonality is to occur, the services must compromise on operational needs.

The Navy's JSF variant is expected to be the most costly of the three service variants due in part to carrier suitability features and the greater operational capability in range and internal payload proposed for the Navy's variant. Current unit recurring flyaway cost objectives for the Navy variant range between \$33 million and \$40 million (fiscal year 1996 dollars), based on a total buy of 2,816 aircraft for the three services. This compares to \$53 million per unit recurring flyaway (fiscal year 1996 dollars) for the F/A-18E/F based on total procurement of 660 E/F's at 36 per year. According to the JAST office's Joint Initial Requirements Document, the JSF cost objectives are based on projected budget constraints and service needs.

The JAST program office projects that significant life-cycle savings for JSF are achievable through implementation of new acquisition processes, technologies, manufacturing processes, and maintenance processes being developed as part of the JAST program. Depending on the degree of commonality between the service variants and the ability to implement other cost-saving measures, the JAST office projects the total life-cycle cost could be as much as 55-percent less than if it used traditional acquisition and production processes.

JSF Predicted to Have Better Performance Than the F/A-18E/F

The participating contractors presented the results of their concept development studies to the JAST office and the Under Secretary of Defense (Acquisitions and Technology) in August 1995. The presentations outlined the latest design capabilities and projected costs for each of the services' JSF designs. The JSF is expected to have an overall combat effectiveness greater than any projected threat and greater than the F/A-18E/F. The Navy's JSF variant is also expected to have longer ranges than the F/A-18E/F to attack high-value targets, such as command and control bunkers, without using external tanks or tanking.

Unlike the F/A-18E/F, which will carry all of its weapons externally, the Navy's JSF variant will carry at least two air-to-ground and two air-to-air weapons internally. By carrying its weapons internally, the JSF will maximize its stealthiness and thus increase its survivability in the high threat early stages of a conflict.

Chapter 4
The Joint Strike Fighter Is Predicted to Be
More Affordable and More Capable Than the
F/A-18E/F

The Navy expects that its JSF variant will have the capability to go into high-threat environments without accompanying electronic warfare support aircraft in the first day or early phase of a conflict and be survivable. For example, the JSF would have the capability to attack these high-threat targets without jamming support from EA-6B aircraft that the F/A-18E/F would need to be survivable against integrated air defense systems and sophisticated aircraft that would still be operating during the early stages of a conflict.

Combat range improvement was a primary objective of the F/A-18E/F program. JAST program contractor studies indicated that the Navy variant would have significantly greater range than the F/A-18E/F using internal fuel only and even greater range after the enemy threat is reduced and the aircraft can use external fuel tanks.

F/A-18E/F Will Cost More to Procure Than Currently Estimated

The potential cost of the F/A-18E/F aircraft has been a source of debate among the Congress, DOD, and the Navy for many years, starting before the program was formally approved. Our review indicated that the Navy's cost estimates to procure the F/A-18E/F are still questionable.

The \$43.6 million (fiscal year 1996 dollars) unit recurring flyaway cost¹ estimate for the F/A-18E/F is understated. The estimate is based on a 1,000-aircraft total buy that is overstated by at least one-third because the Marine Corps does not plan to buy the E/F and an annual production rate that the Congress has stated is probably not possible due to funding limitations. Reducing the total buy and annual production rate will increase the unit recurring flyaway cost of the F/A-18E/F from \$43.6 to \$53.2 million (fiscal year 1996 dollars).

DOD and Congressional Concerns About F/A-18E/F Program Cost

In May 1992, the Office of the Secretary of Defense approved the Navy's request that the F/A-18E/F be approved as a Milestone IV, Major Modification program, even though some Defense Acquisition Board participants had the following concerns about the program:

- E/F development cost projections had increased from \$4.5 billion to \$5.8 billion (then-year dollars);
- the unit cost of the E/F was estimated to be 65 percent greater than F/A-18C/D unit cost;
- the projected development cost of \$5.8 billion (then-year dollars) was underfunded by as much as \$1 billion;
- the cost of E/F pre-planned product improvements are not included in either development or production estimates; and
- the E/F was considered an upgrade to the F/A-18C/D rather than a new start, even though the E/F airframe was projected to be only 15-percent common to the C/D.

In evaluating the fiscal year 1993 DOD budget request, the Congress addressed its F/A-18E/F concerns and established a number of fiscal limits on the program. The \$5.783 billion (fiscal year 1996 dollars)/\$5.803 billion (then-year dollars) F/A-18E/F development estimate, presented to the Defense Acquisition Board, was established as a funding ceiling for development costs. Also, the Congress stated that F/A-18E/F unit flyaway

¹We used recurring flyaway costs because DOD has consistently maintained that these costs are the most appropriate to compare the costs of different aircraft. Recurring flyaway costs include costs related to the production of the basic aircraft and do not include all procurement costs. Appendix I contains a more detailed discussion of what makes up various costs and how they are calculated.

costs should be no greater than 125 percent of the F/A-18C/D's unit flyaway cost.

Congressional concern about E/F unit cost projections was based in part on the high annual production rate that the Navy used in arriving at its per unit procurement estimates. The Navy projected that beginning in 2007, and continuing through 2015, it would procure 72 F/A-18E/Fs per year. The Congress believed this was unrealistic and directed that DOD calculate a range of unit costs based on production rates of 18, 36, and 54 aircraft per year. According to program officials, they are not required to report revised cost estimates based on the change to production rates until an early operational assessment is completed in the spring of 1996.

Unit Acquisition Costs Will Be Greater Than Projected

DOD's F/A-18E/F unit recurring flyaway cost estimate is \$43.6 million (fiscal year 1996 dollars). This cost is understated because

- the total F/A-18E/F procurement levels and annual production rates that are essential for predicting acquisition unit costs are overstated and
- contract estimates for initial production aircraft are higher than projected.

Procurement Levels and Production Rates

In calculating the F/A-18E/F unit acquisition costs, the Navy assumed it would procure 1,000 aircraft from 1997 through 2015—approximately 660 for the Navy and 340 for the Marine Corps at a high annual production rate of 72 aircraft. However, the Marine Corps does not plan to purchase any F/A-18E/Fs, and indications are that once the Navy's JAST variant becomes available fewer F/A-18E/Fs will be procured annually.

The Marine Corps Aviation Plan and the Marine Corps Deputy Chief of Staff for Aviation in a 1994 memorandum and in 1995 testimony² before the Congress stated that the Corps plans to "neck down" to one aircraft in the future. It plans to replace all of its current F/A-18C/D and AV-8B aircraft with the Advanced Short-Takeoff and Vertical-Landing aircraft now under management of the JAST program. Because the Marine Corps does not plan to procure any F/A-18E/Fs—data from a Navy's program cost analysis report and discussions with NAVAIR cost officials and confirmed by the Marine Corps identifies 340 aircraft as the programmed Marine Corps buy—the total F/A-18E/F buy would be reduced from 1,000 to 660 aircraft. The likelihood that fewer F/A-18E/Fs will be procured is

²Statement before the Airland Forces Subcommittee of the Senate Armed Services Committee, Mar. 29, 1995.

possible once the JSF, projected to be more capable and less costly than the E/F, becomes available around 2007.

Additionally, the E/F unit cost is affected by a lower-than-projected annual production rate. The Navy's unit cost calculations assumed an annual peak production rate of 72 aircraft for 8 years, representing over half the production run. The Congress, in its fiscal year 1993 Authorization Conference Report, questioned whether an annual production rate of 72 aircraft was realistic and directed the Navy to provide cost-estimates for smaller production quantities (18, 36, and 54) with the results of the F/A-18E/Fs initial operational assessment, which is scheduled for the spring of 1996. However, data shows that E/F production rate is expected to be lowered to only 36 F/A-18E/Fs annually rather than 72.

Historically, reductions in annual production rates have increased the per unit procurement cost of aircraft. The Navy has not provided us the increased unit cost based on reduced annual production rates. Therefore, we approximated what the unit cost increase would be based on a total procurement of 660 rather than 1,000 aircraft and an annual production rate of 36 rather than 72 aircraft. Using the A/F-X cost model to predict the effect of total buy and annual production rate changes on recurring flyaway cost, we calculated that the F/A-18E/F unit recurring flyaway cost would be \$53.2 million (fiscal year 1996 dollars) rather than the \$43.6 million (fiscal year 1996 dollars) estimated by DOD. The \$53.2 million unit recurring flyaway cost for the F/A-18E/F indicates that the E/F would have a unit recurring flyaway cost that is 189 percent of the F/A-18C/D's unit recurring flyaway cost (\$53 million compared to \$28 million). As shown in appendix I, this cost difference in unit recurring flyaway would result in a savings of almost \$17 billion (fiscal year 1996 dollars) or savings of over \$24 billion when expressed in then-year dollars, if the Navy were to procure 660 F/A-18C/Ds rather than 660 F/A-18E/Fs. Our estimated savings do not include the cost of C/D upgrades, such as the larger 480-gallon external fuel tanks for improved range nor the strengthened landing gear to increase carrier recovery payload. However, our estimated savings are conservative because they also do not include planned E/F upgrades and are based on recurring flyaway costs that do not include the other items that make up total procurement costs. (See app. I for a discussion of how unit costs are computed.) Additionally, our estimated savings do not include savings that would accrue from having fewer type model F/A-18 aircraft in the inventory. The cost benefits would result from having common aircraft spare parts, simplified technical specifications, and

reduced support equipment variations, as well as reductions in aircrew and maintenance training requirements.

Also, there are other indications that F/A-18E/F procurement costs could increase further. According to contractor estimates, the cost of LRIP for the E/F is currently projected to be 8.5-percent greater than estimates provided to the Congress.

Conclusions and Recommendation

DOD faces funding challenges as it attempts to modernize its tactical aircraft fleet through the Air Force's F-22 program, the Navy's F/A-18E/F program, and the tri-service JSF program. Various DOD officials have recognized that funding for each of these programs may not be forthcoming. In that event, DOD will be forced to make some funding trade-offs among these three competing aircraft programs.

In prior reports,¹ we offered alternative procurement strategies for the Air Force's F-22 program. Regarding the Navy's F/A-18E/F program, DOD's next major decision is whether to proceed into production. The Navy has spent about \$3.75 billion (then-year dollars) on the E/F engineering and manufacturing development effort and plans to spend \$57.31 billion (fiscal year 1996 dollars)/ \$83.35 billion (then-year dollars) to procure 1,000 aircraft. This report demonstrates that the justification for the E/F is not as evident as perhaps it was when the program was approved in 1992 because the E/F was justified, in large part, on projected operational deficiencies in the C/D aircraft that have not materialized. This report also demonstrates that proceeding with the E/F program is not the most cost-effective approach to modernizing the Navy's tactical aircraft fleet. Therefore, the information provided in this report should be fully considered before a production decision is made on the E/F. Such consideration should take into account the following.

- Operational deficiencies in the F/A-18C/D cited by the Navy in justifying the need for the F/A-18E/F—range, carrier recovery payload, survivability, and system growth—either have not materialized as projected or can be corrected with nonstructural changes to the F/A-18C/D. Furthermore, E/F operational capabilities will only be marginally improved over the C/D model. The E/F's increased range is achieved at the expense of combat effectiveness and increased F/A-18E/F payload capability has created weapons release problems that, if not resolved, will reduce the F/A-18E/F's payload capability compared to the F/A-18C/D.
- A more cost-effective approach to modernizing the Navy's tactical aircraft fleet exists. In the short term, the Navy could continue to procure the F/A-18C/D aircraft. In the mid-term, upgrades could be made to the C/Ds to further improve the C/D's operational capabilities. These upgrades could include such things as: using the larger 480-gallon external fuel tanks to achieve more range; modifying landing gear to increase carrier recovery payload; using advanced avionics that require less space, cooling and power; and incorporating add-on survivability features.

¹Tactical Aircraft: F-15 Replacement Is Premature as Currently Planned (GAO/NSIAD-94-118, Mar. 25, 1994) and Tactical Aircraft: Concurrency in Development and Production of F-22 Aircraft Should Be Reduced (GAO/NSIAD-95-59, Apr. 19, 1995).

- For the long term, the Navy is considering JSF as a complement to the F/A-18E/F. DOD is predicting that the next generation strike fighter will provide more operational capability at less cost than the E/F. Therefore, the next generation fighter should be considered as an alternative to the F/A-18E/F.
- The F/A-18E/F will cost more to procure than DOD currently projects. The \$43.6 million (fiscal year 1996 dollars) unit recurring flyaway cost estimate is based on a total buy of 1,000 aircraft—660 for the Navy and 340 for the Marine Corps—at a high annual production rate of 72 aircraft per year. However, the Marine Corps does not plan to buy the F/A-18E/F aircraft and the Congress has stated that an annual production rate of 72 aircraft is not realistic. Reducing the number of aircraft to be procured and the annual production rate to more realistic levels would reduce the total program cost but would increase the unit recurring flyaway cost of the aircraft to about \$53 million (fiscal year 1996 dollars).
- In a related report on the F/A-18E/F,² we stated that the Navy’s plan to procure the E/F appears to contradict the national military strategy, which cautions against making major new investments unless there is “substantial payoff.” We pointed out that Navy data show both the C/D and E/F are expected to hit the same ground targets with the same weapons.

Pursuing other alternatives, rather than proceeding with the F/A-18E/F program, would save billions of dollars. Continued procurement of the Navy’s less expensive F/A-18C/D aircraft (the fiscal year 1996 unit recurring flyaway cost of F/A-18C/Ds is \$28 million compared to \$53 million for the F/A-18E/F) could be done only to the level needed to sustain inventories until the next generation strike fighter becomes available. Furthermore, reliance on the more affordable next generation strike fighter as the Navy’s primary tactical aircraft would help keep that aircraft affordable by increasing the total buy.

Recommendation

Given the cost and the marginal improvements in operational capabilities that the F/A-18E/F would provide, we recommend that the Secretary of Defense reconsider the decision to produce the F/A-18E/F aircraft and, instead, consider procuring additional F/A-18C/Ds. The number of F/A-18C/Ds that the Navy would ultimately need to procure would depend

²Combat Airpower: Reassessing Plans to Modernize Interdiction Capabilities Could Save Billions (GAO/NSIAD-96-72, May 13, 1996).

upon when the next generation strike fighter achieves operational capability and the number of those aircraft the Navy decides to buy.

Agency Comments and Our Evaluation

In its comments on a draft of this report, DOD said that it is convinced that the fundamental reasons for developing the F/A-18E/F remain valid. Since DOD provided no data or information that we had not acquired and analyzed during our review, we have not changed our position that procuring the E/F is not the most cost-effective approach to modernizing the Navy's tactical aircraft fleet. We recognize that the E/F will provide some improvements over the C/D. However, the C/D's current capabilities are adequate to accomplish its assigned missions. Based on the marginal nature of the improvements and the E/F's projected cost compared to the alternatives discussed in this report, we believe that our recommendation that DOD reconsider its decision to produce the F/A-18E/F aircraft and, instead, consider procuring additional C/D aircraft until the next generation strike fighter becomes operationally available represents sound fiscal planning. We formulated our position within the context of current budget constraints, the decreased military threat environment, and statements by DOD officials, such as the Chairman of the Joint Chiefs of Staff, that DOD's current plans to upgrade its tactical aircraft fleet will not be affordable. Additionally, as we pointed out in our report, the national military strategy directs that major new investments should have substantial payoff. We do not believe that procuring the F/A-18E/F would meet this test.

DOD's entire comments and our evaluation are included in appendix III.

Matters for Congressional Consideration

DOD requested funding in its fiscal year 1997 budget request to begin procurement of the F/A-18E/F. The Congress may wish to direct that no funds may be obligated for procurement of the F/A-18E/F until it has fully examined the alternatives to the E/F program. In that regard, the House National Defense Authorization Act for Fiscal Year 1997 (H.R. 3230, sec. 220) directed such an examination, and a DOD deep strike study is expected to be completed by the end of 1996. Delaying the authority to begin procuring the E/F would allow DOD to complete its study and time for the Congress to assess the results of the DOD study and the information in this report as it decides whether DOD should be provided funding to proceed with the F/A-18E/F program.

F/A-18E/F and F/A-18C/D Acquisition Cost Comparison

In annual selected acquisition reports to the Congress, the Department of Defense (DOD) provides F/A-18E/F program cost data in both fiscal year 1990 base year and inflated then-year dollars. The report provides various procurement data from recurring flyaway costs to program costs. Figure I.1 lists the items that make up the various aircraft unit acquisition costs and demonstrates how DOD can present different procurement values.

**Appendix I
F/A-18E/F and F/A-18C/D Acquisition Cost
Comparison**

Figure I.1: Breakout of Various Program Costs

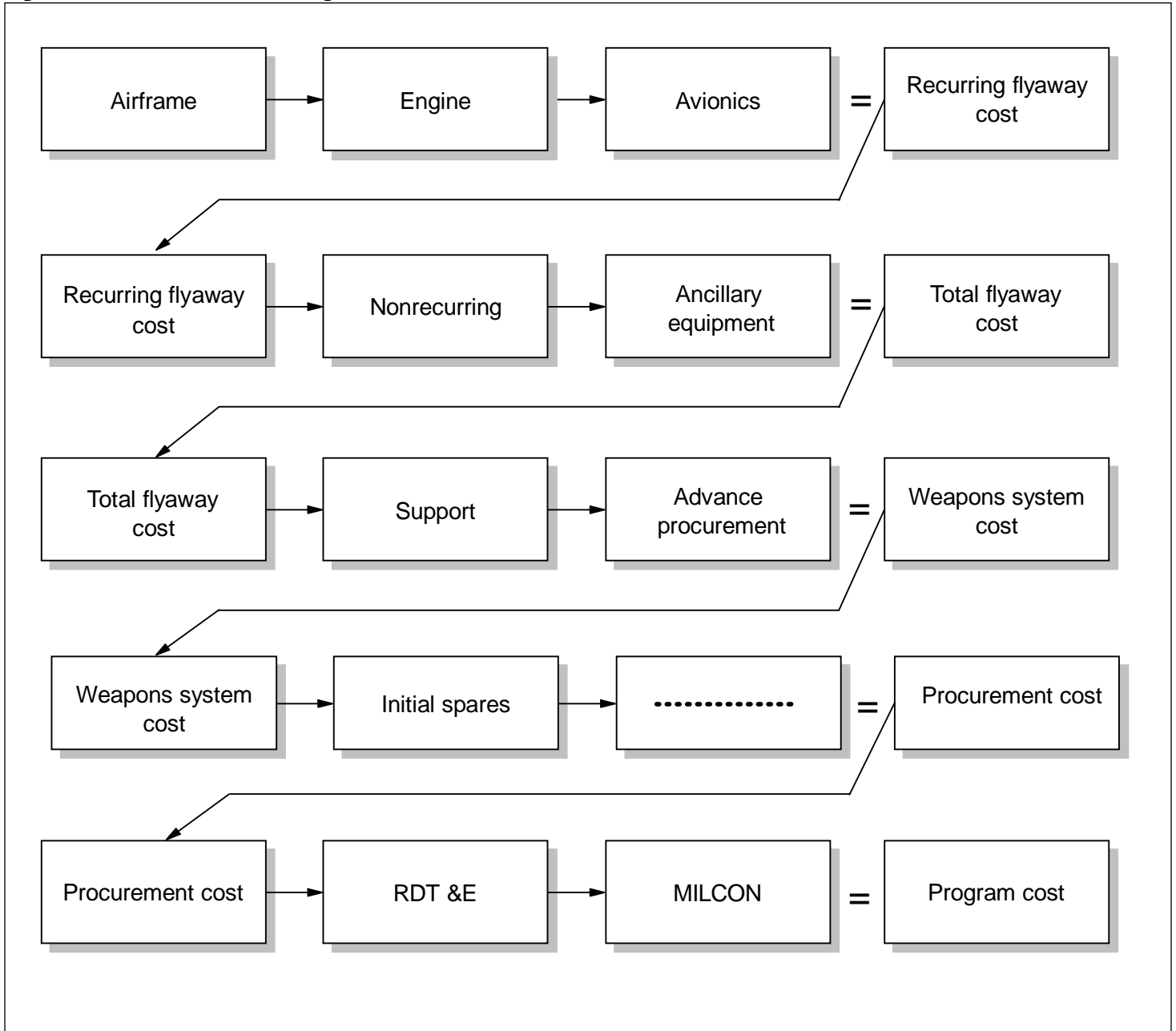

Source: Naval Air Systems Command (NAVAIR).

**Appendix I
F/A-18E/F and F/A-18C/D Acquisition Cost
Comparison**

Table I.1 shows F/A-18E/F unit cost estimates based on Navy data (1,000-aircraft buy and a high annual production rate of 72 aircraft) escalated to fiscal year 1996 dollars and in then-year dollars.

Table I.1: Navy Unit Cost Estimates for the F/A-18E/F

Dollars in millions		
	In fiscal year 1996 dollars	In then-year dollars
Recurring flyaway cost (Airframe, engine and avionics costs)	43.60	62.20
Total flyaway cost (Recurring flyaway, nonrecurring flyaway, and ancillary equipment costs)	48.70	69.50
Total procurement cost (Total flyaway, initial spares and support costs)	57.31	83.35
Program cost (procurement and RDT&E costs)	63.09	89.15

In chapter 5, we provided a comparison of F/A-18C/D versus F/A-18E/F per unit recurring flyaway costs in fiscal year 1996 dollars to place better focus on the cost difference between these two aircraft. Table I.2 shows the annual and total recurring flyaway cost in then-year dollars of procuring 660 F/A-18C/Ds or F/A-18E/Fs starting in 1997. The cost figures for the C/D are based on an annual procurement rate of 36 aircraft and a per unit cost extrapolated from actual fiscal year 1994 unit costs escalated using Navy supplied inflation factors. The cost figures for the E/F buy are based on an adjusted procurement schedule that assumes that funding limitations would only allow a high annual production rate of 36 aircraft. Table I.3 shows the cost of producing 660 F/A-18E/Fs and 660 F/A-18C/Ds in constant fiscal year 1996 dollars.

Table I.4 shows the recurring flyaway cost savings that would accrue from the Navy procuring an equal number (660) of F/A-18C/Ds rather than E/Fs. As table I.4 shows, continued procurement of the F/A-18C/D would result in a savings of almost \$17 billion (fiscal year 1996 dollars) or over \$24 billion (then-year dollars) based on recurring flyaway costs.

**Appendix I
F/A-18E/F and F/A-18C/D Acquisition Cost
Comparison**

Table I.2: Costs of Producing 660 F/A-18E/Fs or 660 F/A-18C/Ds in Then-Year Dollars

Dollars in millions

Fiscal year	F/A-18E/F			F/A-18C/D		
	Number of aircraft produced ^a	Average recurring flyaway cost	Total recurring flyaway cost	Number of aircraft produced	Average recurring flyaway cost ^b	Total recurring flyaway cost
1997	12	\$54.8	\$ 658	36	\$28.5	\$1,026
1998	24	56.4	1,354	36	29.4	1,058
1999	36	58.1	2,092	36	30.3	1,091
2000	36	59.9	2,156	36	31.2	1,123
2001	36	61.6	2,218	36	32.1	1,156
2002	36	63.5	2,286	36	33.1	1,192
2003	36	65.4	2,354	36	34.1	1,228
2004	36	67.4	2,426	36	35.1	1,264
2005	36	69.4	2,498	36	36.1	1,300
2006	36	71.5	2,574	36	37.2	1,339
2007	36	73.6	2,650	36	38.3	1,379
2008	36	75.8	2,729	36	39.5	1,422
2009	36	78.1	2,812	36	40.7	1,465
2010	36	80.4	2,894	36	41.9	1,508
2011	36	82.9	2,984	36	43.2	1,555
2012	36	85.3	3,071	36	44.5	1,602
2013	36	87.9	3,164	36	45.8	1,649
2014	36	90.5	3,258	36	47.2	1,699
2015	36	93.3	3,359	12	48.6	583
2016	12	96.0	1,152	0	0	0
Total	660		\$48,689	660		\$24,639

^aInitial production of F/A-18E/F aircraft is limited to 12 and 24 aircraft for the first 2 years.

^bBased on a fiscal year 1994, \$26.175-million average recurring flyaway cost for 36 aircraft escalated by inflation factors provided by the Navy.

Table I.3: Costs of Producing 660 F/A-18E/Fs or 660 F/A-18C/Ds in Constant Fiscal Year 1996 Dollars

Dollars in millions

Fiscal years	F/A-18E/F			F/A-18C/D		
	Number of aircraft produced ^a	Average recurring flyaway cost	Total recurring flyaway cost	Number of aircraft produced	Average recurring flyaway cost ^b	Total recurring flyaway cost
1997-2016	660	\$53.2	\$35,112	660	\$27.7	\$18,282

Appendix I
F/A-18E/F and F/A-18C/D Acquisition Cost
Comparison

Table I.4: Comparison of Costs to Produce 660 F/A-18E/Fs and 660 F/A-18C/Ds in Then-Year and Constant Fiscal Year 1996 Dollars

Dollars in millions			
Type of Dollars	F/A-18E/F	F/A-18C/D	Difference in total flyaway cost
	Total recurring flyaway costs	Total recurring flyaway costs	
Then-year	\$48,689	\$24,639	\$24,050
Constant fiscal year 1996	\$35,112	\$18,282	\$16,830

Joint Advanced Strike Technology Program

The Joint Advanced Strike Technology (JAST) program’s objective is to develop a technically superior but less costly, more affordable aircraft than today’s strike aircraft. The basis for this objective is to be able to affordably meet potential future threats that cannot be met by today’s aircraft. The aircraft that will evolve from the JAST program has been designated the Joint Strike Fighter (JSF).

As of November 1995, the total number of JSF aircraft projected to be acquired is shown in table II.1.

Table II.1: Projected JSF Acquisitions by Service

Service	Requirement	Number of aircraft
Air Force	Conventional takeoff and landing multirole aircraft to replace the F-16 and A-10 aircraft	1,874
Navy	First-day-of-the-war survivable, carrier-suitable aircraft to complement the F/A-18E/F	300
Marine Corps	Short-takeoff and vertical-landing aircraft to replace the F/A-18 and AV-8B	642
Total		2,816

In addition, the United Kingdom is participating in the program and is expected to buy an unspecified number of the short-takeoff and vertical-landing versions.

The JAST Program Is Using Cost-Cutting Development Methods

To create the building blocks for an affordable, successful development of next generation strike weapon systems, the JAST office is using joint service teams to implement a series of new weapon systems development processes and techniques. This new process is aimed at developing innovative means to significantly lower the life-cycle costs of developing, producing, and maintaining an advanced strike aircraft; identify weapons systems requirements; and identify, develop, and demonstrate advanced technologies for the aircraft that could be matured to a low-risk level heading into a decision to contract for the engineering and development of a new aircraft.

To accomplish its development objectives, the JAST office is implementing a three-phase program, after which it expects to enter into the engineering and manufacturing development phase of an aircraft acquisition program

for a Joint Strike Fighter. This approach is designed to develop requirements for the fighter and demonstrate technology and operational concepts in the areas of propulsion, flight systems, weapons, structures and materials, avionics, manufacturing, and supportability. The three phases are as follows:

Concept exploration. Studying innovative, high-payoff advanced technologies and system concepts that would reduce costs for joint strike warfare. This phase, from May 1994 to November 1994, involved 12 exploration contracts for \$10.5 million.

Concept development. Further defining concepts and conducting additional cost and design trade-off analyses, design research, and technology maturation research. This phase, scheduled from January 1995 to March 1996, involves 26 contracts for \$127.2 million, 4 of which were contracts to major potential aircraft producers to refine cost and design trade studies and aircraft concept designs. Subsequent to the awards, two of the major contractors—McDonnell Douglas and Northrop Grumman—teamed together with British Aerospace to develop a single concept design and perform cost and design trade studies.

Concept demonstration. Demonstrating weapon systems concepts and leveraged technologies with flying concept demonstration aircraft. This phase is scheduled to occur from mid-fiscal year 1996 to mid-fiscal year 2000. During this phase, two contractors will each build and demonstrate two flying concept aircraft that would include demonstration of short takeoff and vertical landing. One of these teams will be chosen to enter into a low-risk engineering and manufacturing development phase in 2000.

Comments From the Department of Defense

Note: DOD's comments in its transmittal letter and attachment 1 are restated in attachment 2 of its comments. Therefore, GAO's evaluation of the comments is presented in attachment 2.



ACQUISITION AND
TECHNOLOGY

OFFICE OF THE UNDER SECRETARY OF DEFENSE

3000 DEFENSE PENTAGON
WASHINGTON DC 20301-3000



20 MAY 1996

Mr. Louis J. Rodrigues
Director, Defense Acquisitions Issues
National Security and International
Affairs Division
U.S. General Accounting Office
Washington, D. C. 20548

Dear Mr. Rodrigues:

This is the Department of Defense (DoD) response to the General Accounting Office (GAO) draft report, "NAVY AVIATION: Decision to Procure F/A-18E/F Should Be Reconsidered," April 15, 1996, (GAO Code 707072), OSD Case 1125. The Department nonconcurs with the report.

The DoD is convinced that the fundamental reasons for the decision to develop the F/A-18E/F remain valid. The DoD believes that the GAO has erred in its assessment of the program by failing to acknowledge existing and future F/A-18C/D fleet operational limitations; by understating the F/A-18E/F's superior performance characteristics over the C/D; and by assuming total program and annual buy figures that are inconsistent with current plans.

To date the F/A-18E/F has been a "model" acquisition program. The program is meeting or exceeding all program requirements.

The GAO recommendation that the Secretary of Defense reconsider the decision to produce the F/A-18E/F is premature because the decision on whether or not to proceed with production of the aircraft has not been made. The F/A-18E/F is scheduled for its Low Rate Initial Production (LRIP) milestone decision in the first quarter of calendar year 1997. At that time, the Defense Acquisition Board will convene for a thorough program review including consideration of the rationale for the program; the technical status; the progress in development testing; the fiscal status; the schedule status; and the service buy plans in preparation for the award of full funding for LRIP aircraft.

The detailed DoD comments to the GAO report recommendation are provided in Attachment 1 and to its principal findings in



Appendix III
Comments From the Department of Defense

Attachment 2. The Department appreciates the opportunity to provide these comments on the draft report.

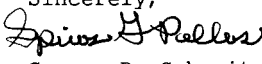
Sincerely,

for George R. Schneider
Director
Strategic and Tactical Systems

Attachment 1

GAO Draft Report

“NAVY AVIATION: Decision to Procure F/A-18E/F Should Be Reconsidered,” (GAO Code 707072)

DoD Response to the GAO Recommendation

Recommendation: Given the cost and the marginal improvements in operational capabilities that the F/A-18E/F would provide, we recommend that the Secretary of Defense reconsider the decision to produce the F/A-18E/F aircraft and, instead, consider procuring additional F/A-18C/Ds. The number of F/A-18C/Ds that the Navy would ultimately need to procure would depend upon when the next generation strike fighter achieves operational capability and the number of those aircraft the Navy decides to buy.

DoD Response: At the time of the Milestone IV decision, the stated rationale for the F/A-18E/F was to correct fleet deficiencies in the areas of: mission radius, recovery payload, payload flexibility, volume for potential system growth, and survivability characteristics. The DoD believes that these fundamental reasons for the decision to develop the F/A-18E/F still remain valid.

Operational limitations do exist in the F/A-18C/D fleet that need to be corrected. The F/A-18E/F outperforms the C/D in range by 40-50 percent in either the high altitude or HI-Lo-Lo-Hi profile. The F/A-18E/F does possess superior performance characteristics over the C/D that will significantly improve operational effectiveness. For fixed mission radius, the F/A-18E/F offers enhanced maneuverability. For increased radius of operation, the E/F offers similar combat performance to the C/D.

Available contour plots that compare the installed engine performance of the E/F to the C/D show that the E/F significantly outperforms the C/D at all points in the flight envelope. This is a more relevant comparison since it takes into account the losses due to aircraft installation as well as how the engine compensates for them.

The E/F provides an approximately 80 percent increase in payload recovery capability compared to the C/D. Current increased landing weight waivers for the C/D for Operation Southern Watch support operations were achieved at the expense of increased operational risk such as increased wind over deck requirements, restricted glide slopes and asymmetric store limits on the outboard pylon. All of these factors affect the way the carrier Commanding Officer operates his ship, the Air Wing Commander and Planning staffs plan missions, and the way pilots fly their aircraft. While these waivers are currently implemented fleet-wide with the same restrictions, continuing them increases risk and adversely affects airframe structural life, particularly since heavier more expensive “smart” weapons will form the bulk of carrier load out in the future. The combination of larger gross landing weights and slower approach speeds were among the reasons for the E/F.

The need for managing avionics growth and finding usable space for modifications remains an issue for the F/A-18. Congress was keenly interested at the outset that the program not pursue costly new avionics. One of the principal requirements for the E/F was to retain 90 percent commonality with C/D avionics so as to provide a cost effective design without the need for costly avionics redesign and integration. The location of avionics bays on aircraft is governed to a great extent by the environment. It is undesirable to expose avionics to harsh thermal and vibratory environments if they are to retain their performance and high reliability. Much of the so-called available space on the C/D identified by the GAO for avionics falls into the category of non-usable space because of the harsh environment. Congressionally mandated capabilities such as Global Positioning System, Positive Identification System, and Digital Communications are currently undergoing costly integration and redesign because of lack of space on the C/D. The E/F provides the usable space needed for potential system/subsystem growth.

While the E/F or C/D would normally operate as a part of a force package, it does not follow that this is sufficient rationale to preclude the need for individual aircraft survivability. This would ignore the possibility of a section of aircraft encountering mobile or unknown threats that might precipitate classic "one-on-one" encounters for which the E/F has been improved. The E/F design has made possible a synergistic approach to survivability improvement. The balanced design includes radar cross section reduction, decreases in vulnerable area, and an integrated defensive electronic warfare suite to provide an affordable answer to the predicted threat.

The GAO implication that the Secretary of Defense has already made a decision to produce the F/A-18E/F is incorrect. The Low Rate Initial Production (LRIP) milestone decision on the F/A-18E/F is scheduled to be conducted by the Defense Acquisition Board in the first quarter of calendar year 1997. This thorough review will address the rationale for the program; will assess the technical, schedule, and fiscal status of the program against the requirements and program objectives/thresholds; and will review service buy plans and affordability considerations prior to any decision to proceed with LRIP of the aircraft.

Finally, to continue to buy additional C/Ds until the Joint Strike Fighter (JSF) comes to fruition as the GAO recommends, would only serve to perpetuate the deficiencies in the fleet that need correcting now. While the JSF appears promising as a multi-service aircraft, that program has yet to enter and successfully complete the rigorous development process. To advocate that the Navy put all its "eggs into that basket" is not prudent planning, ignores the possibility that the JSF schedule could slip, and certainly does not address the deficiencies that exist now.

Attachment 2
GAO Draft Report
"NAVY AVIATION: Decision to Procure the F/A-18E/F Should Be
Reconsidered,"
(GAO Code 707072)

DoD Comments to Principal GAO Findings

FINDING 1: F/A-18E/F Will Provide Marginal Improvements Over F/A-18C/D

DOD RESPONSE:

GAO correctly states that the F/A-18E/F is achieving significantly greater ranges than the specification requires. GAO asserts this performance improvement over the F/A-18C/D is based on an interdiction mission high altitude profile, not the HI-Lo-Lo-Hi specification profile. The GAO assertion is false. The E/F outperforms the C/D in range by 40-50% in either profile (50% with 2 external tanks, 40% with three external tanks). GAO asserts that the C/D can meet the E/F interdiction mission specification range, if it could use 480 gallon external tanks and fly the high profile as opposed to the specified HI-Lo-Lo-Hi profile. The F/A-18C/D cannot utilize 480 gallon tanks in the carrier environment without significant design modifications to the airframe (replacing spars, ribs in the wing and requalifying both in static and fatigue testing) and strengthening the pylons. The F/A-18C/D with either two or three external 330 gallon tanks, (the tanks cleared for C/D) does not meet the specified E/F range for interdiction.

In specifying range for F/A-18E/F, the primary missions of the aircraft were identified referencing standard profiles in order to get an apples to apples valid comparison with other platforms. For the F/A-18E/F, there are three specified missions identified with range requirements: Fighter Escort; Interdiction, using the HI-Lo-Lo-Hi profile; and Tactical Reconnaissance. These specified missions identify the aircraft load out based on mission requirements and equipment or stores that are cleared for use on the aircraft. The GAO claim that the C/D can meet the E/F interdiction range, if only it had the 480 gallon external fuel tank and flew a different (high altitude) profile, is invalid. GAO states its objective is to determine if the performance enhancements of the E/F over the C/D are significant enough to justify the investment, yet they propose to do this with a test that is unequal.

The 480 gallon tank will not physically fit on the C/D centerline station and clear the carrier deck launch hardware during catapult. A significant modification to C/D wing structure and a pylon redesign would have to be accomplished for 480 gallon tank usage on the wing pylons.

**Appendix III
Comments From the Department of Defense**

The Early Operational Assessment (EOA) verified F/A-18E/F range performance models with flight test data taken from the first two flight test aircraft. The chart below summarizes interdiction range differences between the F/A-18C/D and F/A-18E/F:

Hi-Lo-Lo-Hi Interdiction Mission

(2)AIM-9 SIDEWINDERS, FLIR/NAVFLIR, (4)MK-83LDGP (1000 LB. Bombs)

<u>F/A-18E</u>	<u>SPEC</u>	<u>CDR^{Note 1}</u>	<u>% OVER C/D</u>
2(480 TANKS)	390	468	54%
3(480 TANKS)		524	42%

<u>F/A-18C (LOT XIX)</u>	<u>ACTUAL</u>
2(330 TANKS)	304
3(330 TANKS)	369

Hi-Hi-Hi Interdiction Mission

(2)AIM-9 SIDEWINDERS, FLIR/NAVFLIR, (4)MK-83LDGP (1000 LB. Bombs)

<u>F/A-18E</u>	<u>CDR^{Note 1}</u>	<u>% OVER C/D</u>
2(480 TANKS)	597	51%
3(480 TANKS)	666	42%

<u>F/A-18C (LOT XIX)</u>	<u>ACTUAL</u>
2(330 TANKS)	395
3(330 TANKS)	470

Note: (1) Status based on design and simulation at Critical Design Review. Models used to predict range were verified via flight test during EOA Jan - Feb 1996.

The F/A-18A/B/C/D was designed and cleared to use the 330 gallon external fuel tank to the operating limits of the aircraft. In the early 1980's, McDonnell Douglas (MDA) approached the Navy about designing a 480 gallon tank for the F/A-18A/B. That project was terminated by MDA for USN applications before completion. Catapult loads for a full 480 gallon tank were discovered to be 72% above design limit load for the pylon aft attach point. To accommodate these increased loads, structural modifications would have been required to the pylon, the wings aft two spars and ribs, followed by complete structural testing and flight test verification for carrier suitability.

However, MDA pursued this design with two foreign customers with land based applications for the A/B/C/D. One country, developing the centerline application, dropped out before completion leaving Canada as the only participant owning 480 gallon tanks. Their use was restricted to ferry flights only, because of flight maneuver limitations as specified in the 1987 seven page flight clearance document for the 480 gallon tank. This flight clearance identifies tank conditions of full, partially empty, and empty in conjunction with either wing or centerline pylon verses speed, "G" limitation, roll rate, yaw rate, angle of attack, fuel sequencing, and center of gravity. One small part of the clearance, for example, limits positive "G" to 4.0 with tank fuel greater than 250 gallons at speeds between 425 and 550 knots. After deriving little operational benefit given the restricted operating limits, Canada is now removing the tanks from inventory.

The GAO concern, based on Center for Naval Analysis (CNA) comments that tanking will be required for both C/D and E/F" to reach a majority of targets in many of likely wartime scenarios", is difficult to address unless the CNA assumptions were known. However, given interdiction profiles and the carrier standing off 250 miles, the F/A-18E/F with its improvement in range will be able to engage 52% more targets unrefueled than the F/A-18C/D based on government developed target distribution data. In addition, the E/F returns tactical mission tanking capability to the carrier air wing unavailable since the retirement of the A-6. The larger E/F airframe and redesign of the E/F wing (aerodynamically and structurally) to utilize the 480 gallon tank facilitates an in flight refueling capability not feasible on the F/A-18C/D. The E/F will be capable of carrying a four 480 gallon tank configuration on inboard and mid-board pylons with an air refueling store on centerline. This capability will increase the F/A-18E/F interdiction range out over 880 miles with organic assets. With Standoff Land Attack Missile- Expanded Response (SLAM-ER), F/A-18E/F can engage targets at an effective range of 1000 miles.

GAO RESPONSE:

Our report did not state that the C/D must fly a high-altitude mission profile and use larger 480-gallon tanks in order to meet E/F specification ranges. We stated that, based on Navy C/D range data, by flying the high mission profile and carrying 330-gallon external fuel tanks, the C/D will be able to reach targets significantly greater than 390nm miles away--the distance specified for the E/F. However, if more range is needed or the lower mission profiles must be flown, McDonnell Douglas reports state that the C/D can increase its range by flying the larger 480-gallon external fuel tanks that the E/F will use. Regarding the low mission profile, according to Navy officials, future interdiction missions will not fly the low-altitude mission profile if there is a significant ground threat. This is supported by mission effectiveness analysis, conducted by CNA, which concluded that tactical aircraft will be more survivable and thus more effective if aircraft fly at higher altitudes in the target area rather than at low altitudes. According to a recent Naval Intelligence

assessment, which looked at worldwide challenges to naval strike warfare, most strike aircraft lost during Desert Storm were lost to anti-aircraft artillery and man-portable air defense systems, which are especially hazardous for tactical aircraft when flying the low-altitude mission profiles. Also, the use of higher mission profiles is supported by the JAST program. As we state in our report, the JAST program office has directed that a higher mission profile, not the low mission profile, be used by the contractor teams when they predict and report ranges for their respective JSF concepts. As we report, by flying this higher mission profile, the C/D will be able to reach targets significantly further than 390nm from the carrier. However, according to McDonnell Douglas reports, if low-altitude missions were flown, the F/A-18C/D could fly the specified 390nm combat radius by also using the larger 480-gallon external fuel tank that will be used on the F/A-18E/F. The larger 480-gallon external tanks would also increase C/D ranges flying the higher mission profiles.

In addition, our report acknowledged that the E/F will have ranges greater than the C/D. However, the interdiction range values reported by DOD in its comments do not reflect the range data in the E/F Early Operational Assessment (EOA). We cannot address the specific difference between the ranges because range values in the EOA have been classified. However, the 40-50 percent improvement in E/F ranges over the C/D is not supported by EOA data. This data shows that the E/F interdiction range improvements over the C/D are approximately half what DOD stated in its comments. Also, DOD focused on the E/F and C/D carrying a weapons load of four 1,000-pound general purpose bombs as well as two or three external fuel tanks. This load out requires the C/D to carry the four 1,000-pound bombs on two weapon stations using higher drag pylons. These pylons reduce the C/D's range relative to the E/F, which does not require the higher drag pylons to carry this weapons load. However, other weapons loads that the Navy plans to use on the C/D and E/F do not require the C/D to use these higher drag attachments. For example, the MK-84 2,000-pound class smart bomb, briefed to us by F/A-18E/F program management to demonstrate the E/F's superior range, does not require the higher drag pylons when used on the C/D. Consequently, this load out results in increased range for the C/D relative to the E/F specification. This better performance is shown in figure 2.2 of our report and would be representative of the heavier smart weapons, such as JSOW, that the Navy states will form the bulk of future carrier aircraft weapons loads.

Use of 480-Gallon External Fuel Tanks

In its comments, DOD stated that extensive structural modifications would be needed for the C/D to accommodate the 480-gallon external fuel

tank. This statement is not consistent with Navy and McDonnell Douglas studies cited in our report that address the use of the 480-gallon external fuel tank on the C/Ds. Furthermore, in 1984, 1987, and 1990 reports, McDonnell Douglas cited the use of the larger 480-gallon external fuel tanks on the F/A-18A/B/C/Ds. According to a senior McDonnell Douglas engineer responsible for the F/A-18 program, the Navy has not used the larger external fuel tanks on the F/A-18C/Ds because of logistics concerns with storing the larger tanks in addition to the smaller 330-gallon tanks currently used on the carriers.

DOD states that the C/D cannot carry the 480-gallon external fuel tank on its centerline station. We did not state that the 480-gallon external tank can be carried on the centerline station. Rather, according to information in the Hornet 2000 study, which we cite in our report, the 480-gallon tanks could be flown on the inboard wing stations of the C/D. McDonnell Douglas, in its 1991 "480-Gallon External Fuel Tank" study, reported C/D range values flying two 480-gallon tanks and one 330-gallon tank. The 330-gallon tank would be flown on the centerline station. According to the 1990 McDonnell Douglas report, "The F/A-18 Hornet Multimission Strike Fighter," increased external fuel capacity is available for the F/A-18 with larger 480-gallon external fuel tanks. This report states that the F/A-18 with two AIM-7 and two AIM-9 missiles, as well as six MK-82 LDGP (500-pound) flying two 330-gallon external fuel tanks has a range of about 450nm flying the Hi-Lo-Lo-Hi mission profile. Its range would be extended to approximately 525nm if 480-gallon external fuel tanks are used rather than the 330-gallon tanks. This is significantly greater than the E/F specified range of 390nm.

In its comments, DOD cited Canadian CF-18 flight restrictions flying the 480-gallon external fuel tank as the basis for Canada removing the 480-gallon external tanks from its inventories. Canadian officials told us that they planned to use the 480-gallon external tank operationally when CF-18s were stationed in Europe. However, the Canadian requirement for a 480-gallon tank was dropped when they redeployed their CF-18s back to Canada. According to these officials, there were no operational restrictions placed on the use of the 480-gallon tanks that compelled them to abandon the use of the tanks. According to the Canadian officials, the fuel in the external tanks is used first and would be empty by the time the aircraft reached its target. Consequently, they would be under the same flight restrictions as empty 330-gallon external fuel tanks.

Statements from the Canadian officials are consistent with a 1991 McDonnell Douglas report on the 480-gallon tanks that stated that the 480-gallon tank was certified for flight on the CF-18 and can be carried on F/A-18s without making structural changes. This report also stated that as a result of over 100 test flights and other operational testing, the 480-

gallon external fuel tank successfully passed all qualification tests, including a test to withstand acceleration loads due to catapult and arrestment. The report stated that the study demonstrated load carrying capability without damage and that the flying qualities with the 480-gallon tank are equivalent and comparable to 330-gallon tank loadings.

Aerial Refueling

DOD stated that the E/F, with its increased range, will not need aerial refueling to strike targets. However, as stated in our report, CNA concluded that the C/D and E/F will both require aerial refueling if low mission profiles are flown to conduct operations in the most likely conflicts. Also, operational range, which is less than straight line range and takes into account distances for threat avoidance, will further reduce the E/F's range and thus increase its reliance on aerial refueling.

DOD also stated that the E/F will provide the carrier with an aerial refueling capability that has not been available since retirement of the A-6E. However, we noted that the E/F may have problems operating in the tanker role. According to the F/A-18E/F Technical Review, deployment and retraction of the refueling drogue may contact the bottom of the aircraft and may cause damage to the composite material used in the E/F. Furthermore, in addition to A-6s, there are S-3s on the carrier that are used as tankers and are scheduled for tanker missions for the next 15-20 years. Also, the Navy plans to develop a Common Support Aircraft, a derivative of which will be used in the future for carrier-based tanking.

DOD stated that, if used, tanking and standoff weapons would increase the E/F range significantly. Tanking and standoff weapons will also increase the C/D's range. According to CNA, aerial refueling on the outbound leg of a mission will increase C/D strike ranges by 56 percent over nonrefueled ranges. Furthermore, increases in the E/F's strike range associated with E/F using standoff weapons would also apply to and increase the C/D's range since it too can fly the standoff weapons.

DOD RESPONSE:

GAO Contends that range increases were at the expense of performance

GAO states that the increase in F/A-18E/F range comes at the expense of performance. The DOD does not concur. The range improvements and payload flexibility of the F/A-18E/F will enable it to meet or exceed the turn performance of the F/A-18C/D in the face of real world mission requirements. In addition, the GAO contends that thrust improvement of the F414 equipped F/A-18E/F is not as significant as claimed. Installed thrust improvement of the F414 engine relative to the F404-GE-402 equipped

Appendix III
Comments From the Department of Defense

F/A-18C/D varies throughout the flight envelope, and is scheduled as a trade-off between improved thrust and stall margin.

In terms of combat performance, installed thrust is the key factor in comparing the F/A-18E/F to the F/A-18C/D. It is important to understand how installed thrust combines with air vehicle capabilities to deliver fleet capabilities. What the E/F brings to fleet operations is mission flexibility. For example, a real world scenario may call for a mix of F/A-18C/D & F/A-18E/F to perform a Fighter Escort mission with a fixed combat radius of 550 NM. Both aircraft can perform this mission, however, the increased range, capability inherent in the E/F design allows for a more favorable combat load out than the C/D aircraft thus allowing for a more favorable combat performance. The charts below illustrate the improved Turn Rate of the F/A-18E/F over a -402 equipped F/A-18C/D.

F/A-18E Offers Enhanced Maneuverability for Fixed Mission Radius

(2)AIM-9 + (2)AIM-120 +
Fuel for 550 NM Fighter Escort Mission

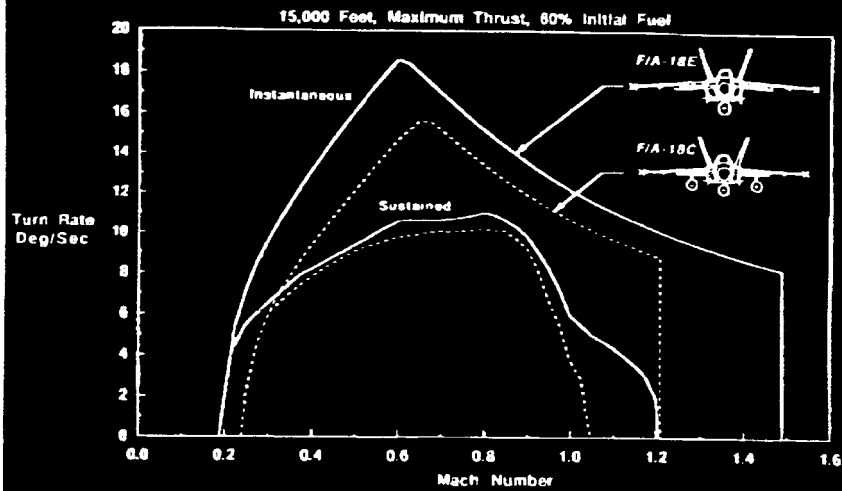

F/A-18E Offers Enhanced Maneuverability for Fixed Mission Radius

(2)AIM-9 + (4)MK-83LD + FLIR + NAVFLIR +
Fuel for 370 NM Interdiction Mission

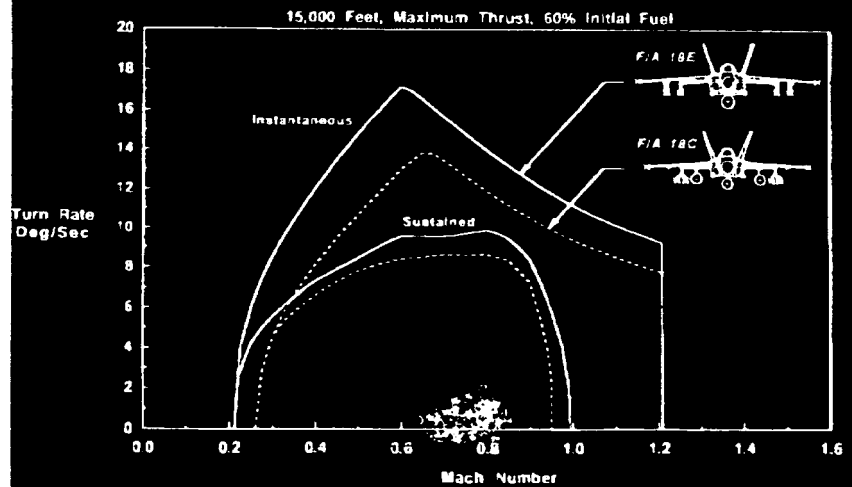

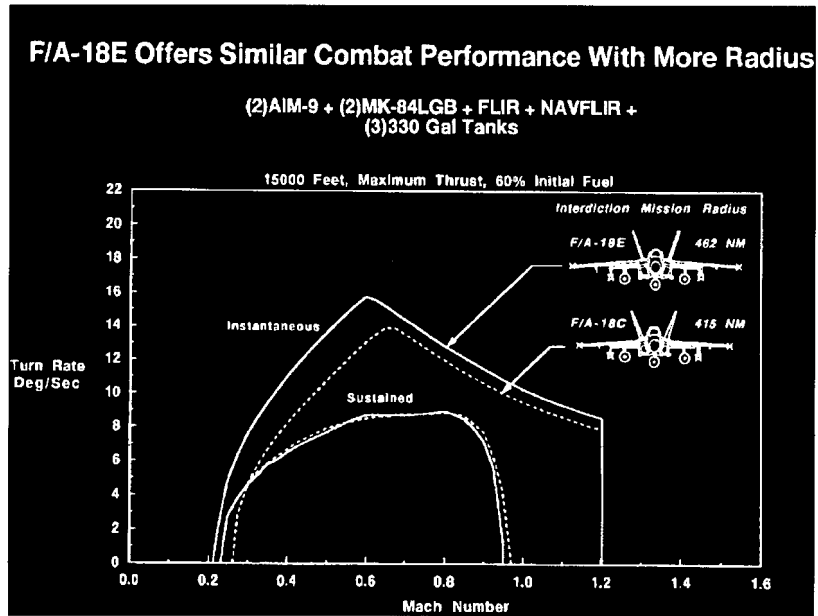

The GAO states findings that the F414 engine with an uninstalled sea level static rating in afterburner of 20,727 lb. shows only a 17% improvement over the F404-GE-402 engine's 17,754 pounds of thrust at the same condition, contrary to program document claims of a 37% thrust improvement. While it is accurate that, at this condition there is only a 17% improvement for a specific portion of the operating envelope, a more relevant comparison of the two is in installed engine performance, which takes into account losses because of aircraft installation as well as how the engine compensates for the installation. The F414 engine employs a Full Authority Digital Engine Control (FADEC) which automatically compensates for losses and constantly adjusts control parameters to optimize performance and retain design thrust levels. This, in addition to the increased airflow afforded by the F/A-18E/F's redesigned inlets, allows the F414 engine to provide between 15% to 20% improvement in installed thrust over the F404-GE-402 and a 25% to 40% improvement over the F404-GE-400 in the combat corridor at 10Kft/0.4 MACH to 35Kft/1.6 MACH (approximately 80% of the currently operating fleet of F/A-18A/B/C/D aircraft are powered by -400s). This improvement is illustrated by the charts on pages 6 and 7. These charts plot engine performance contours which compare the installed performance of the F414-GE-400 to the F404-GE-400 and F404-GE-402 respectively at standard day conditions. Data that compares installed performance for the rest of the flight envelope is shown in tabular form on page 8.

Now on p. 79.

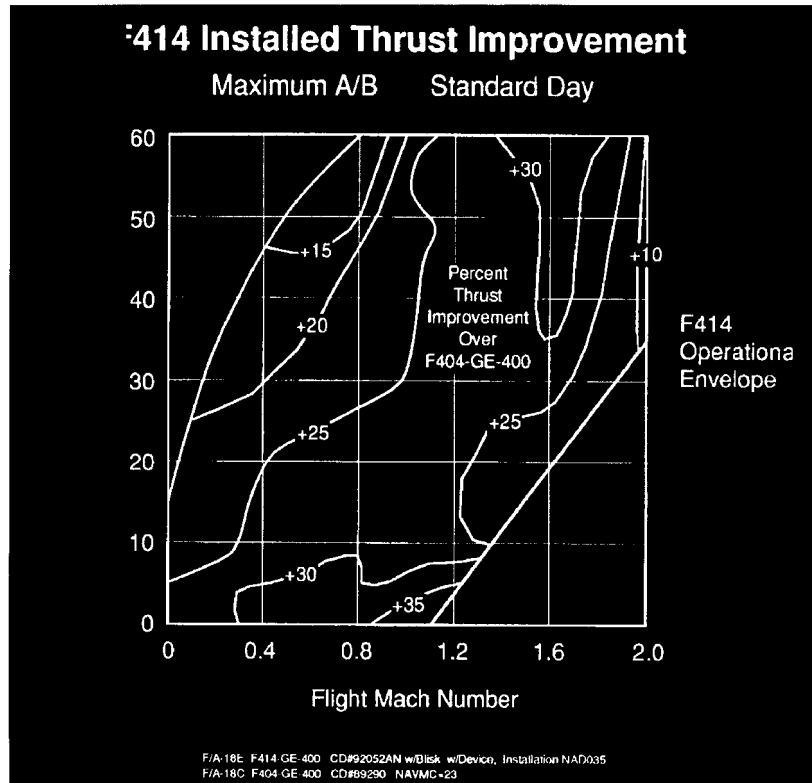

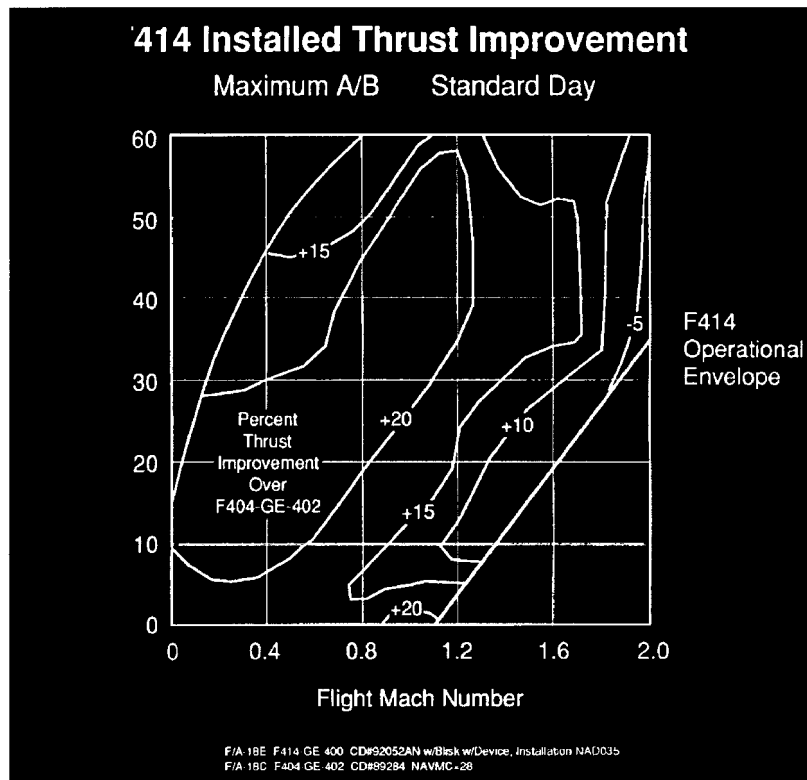

**Appendix III
Comments From the Department of Defense**

The GAO report states that "According to program documents, the F414-GE-400 engine generates about 22,000 pounds of thrust" contrary to technical manuals that show "the F414-GE-400 engine develops only 20,727 pounds of uninstalled thrust." In actuality, the F414 is a 22,000 pound "thrust class" engine; and is capable of generating 22,000 pounds of thrust. During Concept Evaluation and Pre-E&MD program phase, the engine was scheduled to produce 22,025 lb. thrust in average trim, and 21,366 lb. thrust for minimum engine requirement (Scheduling is the mechanism used to govern engine performance parameters at specific power settings). As aircraft design requirements matured, MDA/Navy/GE rescheduled sea level static thrust to 20,727 as the aircraft did not require the additional thrust at this condition. This rescheduling improved fan stall margin which is desirable in an area where the aircraft may encounter steam ingestion and sea level static inlet distortion. In effect, the Navy made a conscious decision to trade excess thrust at this "non combat" point for improved operational safety margin.

F414 Installed MAX A/B Thrust Comparison

Sea Level Standard Day Max A/B	F404-GE-400 SDX_89290 NAVMC-23 (lb)	F404-GE-402 EPE_89284 NAVMC-28 (lb)	F414-GE-400 NAVAIR Minimum NAD066 (lb)	F414-GE-400 PFQ Average NAD088 (lb)
Mach 0.8	17182	19342	22299	22895
Mach 0.9	16927	19310	23249	23375
Mach 1.0	16488	19062	23158	22975
Mach 1.1	15487	18213	20813	21008
Mach 1.2	14500	17376	19226	19815
		(%Δ)	(%Δ)	(%Δ)
Mach 0.8	"	18.57	29.78	33.25
Mach 0.9	"	14.08	37.35	39.27
Mach 1.0	"	15.61	40.33	39.35
Mach 1.1	"	17.60	34.39	35.64
Mach 1.2	"	8.63	32.59	36.65

GAO RESPONSE:

In its response, DOD recognized that both the C/Ds and E/Fs can perform their anticipated real world fighter escort with a combat radius of 550nm. The charts that DOD provided as part of its comments show weapons loads for the E/F and C/D that DOD described as real world mission requirements. The charts show the E/F's and the C/D's turn rates with both carrying external fuel tanks. In the comparisons, the C/Ds have more external tanks than the E/Fs (three vs one) and thus will have greater drag. The impact of this drag is shown in both sustained and instantaneous turn rate values. In the charts where the C/D and E/F both have the same number of external tanks, the turn rate performance of the C/D and E/F is almost identical. However, in our report, we used data provided by the Navy to show the combat performance difference between the E/F and C/D without external tanks. According to aviators we discussed this issue with, in a real world mission where the aircraft is threatened and the pilot needs to exercise the aircraft's full flight envelope to survive, they would jettison their tanks. Our comparison isolates and compares the C/D to the E/F in an air-to-air configuration, and based on Navy-provided data comparing C/Ds with E/Fs, the C/D would have the better combat performance characteristics, as we have shown in our report.

In its comments, DOD stated that in terms of combat performance, installed thrust rather than uninstalled thrust would be a more relevant comparison of the C/D and E/F aircraft. We used uninstalled static thrust in our report because in program management documents, the E/F F414 engine has been compared to the C/D in terms of uninstalled static thrust. However, using Navy data, a comparison of the C/D with the EPE engines to the E/F with the F414 engine reveals that the installed static thrust value (at sea level) increase of the E/F's F414 engine over the EPE engine is also not 36 percent but 17 percent greater. Furthermore, DOD, in its comments, only reported installed thrust at sea level. As can be seen in table III.1, compiled from Navy data, the percentage improvement of the E/F's F414 engine's installed thrust over the EPE engine in the C/D falls below 17 percent at 5,000 feet and, at some speeds, falls below 17 percent at higher altitudes when the E/F flies at 1.0 mach or greater.

Table III.1: Comparison of F414-GE-400 and F404-GE-402 Engine Maximum Thrust at Different Speeds and Altitudes

In pounds of engine thrust

Aircraft engine	F/A-18 C/D F404-GE-402	F/A-18 E/F F414-GE-400	%Δ
Sea level standard day			
0.8 Mach ^a	19,342	22,299	15
0.9 Mach	19,310	23,249	20
1.0 Mach	19,062	23,158	21
1.2 Mach ^b	17,376	19,226	11
5,000 feet			
0.8 Mach	17,612	20,112	14
0.9 Mach	18,261	20,622	13
1.0 Mach	18,907	21,208	12
1.2 Mach	18,172	20,576	13
20,000 feet			
0.8 Mach	11,152	13,475	20
0.9 Mach	12,202	14,402	18
1.0 Mach	13,232	15,339	16
1.2 Mach	14,982	16,756	12
1.4 Mach	16,652	17,426	5
40,000 feet			
0.8 Mach	4,665	5,681	22
0.9 Mach	5,134	6,301	23
1.0 Mach	5,631	6,983	24
1.2 Mach	6,993	8,481	21
1.4 Mach	8,678	10,048	16
1.6 Mach	9,740	10,920	12

^a Sea level standard day data provided in DOD comments.

^b 1.2 Mach used in DOD table is above flight limits for both aircraft.

Note: Source of data for thrust levels for 5,000, 20,000 and 40,000 feet is NAVAIR.

Installed thrust-to-weight, which is defined as the thrust of the aircraft's engine divided by the aircraft's weight, is used by DOD as a measure of performance capability in comparing fighter aircraft. The aircraft with the higher thrust-to-weight ratio is the more capable aircraft. The E/F is

8,698 pounds or 26 percent heavier than the C/D. As shown in table III.1, the heavier E/F with its F414 engine is delivering installed thrust that, depending on altitude and speed, is from 5 percent to 24 percent greater than the Enhanced Performance Engine that is used on the most recently procured C/Ds. Table III.2 shows that the C/D, with the EPE engine, has a higher thrust-to-weight ratio compared to the E/F at all altitudes.

Table III.2: Maximum Thrust-To-Weight Comparison Between F/A-18C and F/A-18E

Aircraft combat weight	F/A-18C (33,325 lbs)	F/A-18E (42,023 lbs)	%Δ
Sea level standard day (static)	0.911	0.845	-7.24
5,000 feet (0.9 mach)	1.096	0.981	-10.49
20,000 feet (0.9 mach)	0.732	0.685	-6.42
35,000 feet (0.9 mach)	0.397	0.385	-3.02
Conditions: 60 percent internal fuel remaining, 2 AIM-9, 2 AIM-120			

Source: NAVAIR.

Also, specific excess power, which is a contract specification measurement, assesses the effect of engine thrust when installed in the aircraft. Table III.3 shows that the C/D with the EPE engine has a higher specific excess power than the E/F with the F414 engine.

Table III.3: Specific Excess Power Comparison Between F/A-18C and F/A-18E

In feet per second

Aircraft Combat weight	F/A-18 C (33,325 lbs)	F/A-18 E (42,023 lbs)	%Δ
Fighter escort, at 10,000 feet ^a	699	663	-5.15
Fighter escort, at 20,000 feet	512	480	-6.25
Fighter escort, at 35,000 feet	247	234	-5.26
Conditions: 1 g level flight, 0.9 mach, maximum thrust, 60 percent total fuel remaining, 2 AIM-9, 2 AIM-120			

Source: NAVAIR.

Note: Specific excess power is defined as the time rate of change of specific energy and is a measure of the capability of the aircraft to change energy levels for a specified configuration, altitude, speed, and thrust (power) setting. Specific Excess Power is usually expressed as feet per second.

^a F/A-18 E/F system specification

The higher specific excess power for the C/D allows the aircraft to perform better than the E/F. The following diagram, which was provided by NAVAIR, shows that the C/D with the EPE will have a better air speed flight envelope than the E/F.

Appendix III
Comments From the Department of Defense

Diagram III.I Air Speed Envelope Comparison Between C/D and E/F.

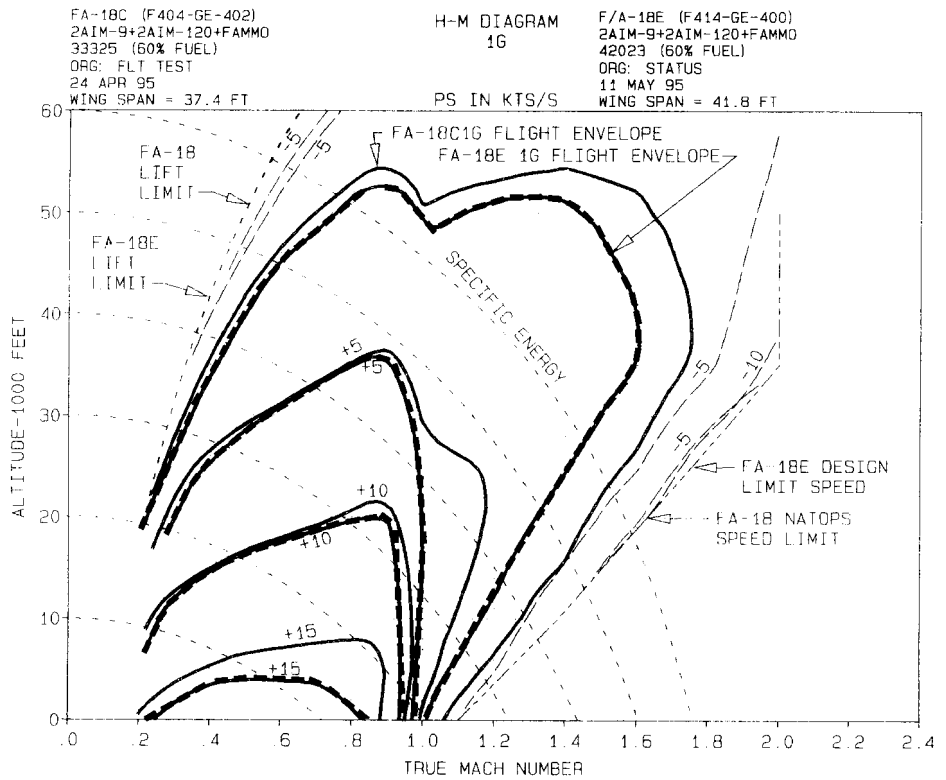

Note: Source of data is NAVAIR

FINDING 2: C/D Has Space for Growth and E/F Must Resolve Payload Problems

DOD RESPONSE:

GAO states that the bring back deficiency for the F/A-18C/D has not materialized, and that the Navy increased the carrier landing weight of the F/A-18C/D thus alleviating the problem. The Navy, in responding to a fleet request during Operation Southern Watch, increased the Carrier Landing Gross Weight for the F/A-18C/D from 33,000 lbs. to 34,000 lbs. The GAO has failed to recognize that increasing the weight came with operational limitations, such as increased wind over deck requirements, restricted glide slopes and asymmetric store limits on the outboard pylon. Further increases are not possible without prohibitive restrictions that would not be acceptable to fleet commanders, nor consistent with the structural airframe service life.

The F/A-18C/D was designed to a Carrier Landing Design Gross Weight (CLDGW) of 32,120 lbs. which was later increased to 33,000 lbs. based on the results of the original Full Scale Development phase. During Southern Watch, as stated above, the CLDGW was increased to 34,000 lbs. with restrictions. These restrictions affect the way the Carrier Commanding Officer operates his ship, the Air Wing Commander and Planning Staffs plan missions and the way pilots fly their aircraft. The decision to approve the request was made after an extensive evaluation of the risks associated with the heavier loads on the aircraft. It remains in effect today, with these limitations, at the discretion of the Carrier Group Commander as operational necessity dictates.

To explain the trade off a pilot or mission planning staff has to perform every operational day on a carrier the following itemized weight breakout is offered. It describes the F/A-18C/D weight picture trying to bring back (two) 500 lb. Laser Guided Bombs, a HARM Missile and two Sidewinders to the carrier. The fuel the pilot has on his first attempt to land, as shown below, is well below fleet operating procedures:

**Appendix III
Comments From the Department of Defense**

This is the "Bosnia" configuration GAO states has solved the bring-back problem

Operating Weight Empty (LOT XVIII)	24,372	
Crew	180	
Crew Equipment	59	
Unusable Fuel	207	
Engine Fluids	114	
Gun	204	
400 rounds Ammo (cases only)	100	
Harm Launcher & Pylon	413	
GBU 12 Racks & Pylon	512	
FLIR Station 4	371	
Launchers AIM-9(2)	174	
Tank pylons (3)	759	
Missile Well Cover Station 6	12	
ALQ-126	190	
Chaff	<u>52</u>	
 Mission, weight before Stores & Fuel	 27,719	 27,719
 GAO Weapons Load out Example:	 (1) HARM	 778
	(2) GBU-12	1,210
	(3) Tanks	897
	(2) Sidewinders	<u>390</u>
	Total Stores wgt	3,275
	Total 9 (less fuel)	<u>3,275</u>
		30,994
 Unrestricted CLDGW	 33,000 lbs.	 Restricted
	<u>30,994 lbs.</u>	34,000 lbs.
		<u>30,994 lbs.</u>
 First Pass Fuel	 2,006 lbs.	 3,006 lbs.

GAO believes that this is not a deficiency in the F/A-18C/D. The DoD believes otherwise. Air Wings consistently set operating procedures for first pass fuel at 4,000 lbs. day/5,000 lbs. night. during early work ups. As the experience base increases, first pass fuel is brought down to 3,500 lbs. day/4,500 lbs. night. There are options to off load weapons such as, Sidewinders and HARMs, to alleviate the weight problem, but the aircraft no longer has the ordnance to fulfill its multi-mission role. Eliminating the two GBU-12s, in the example above, and replacing with two JSOWs would further reduce the bring back fuel of 3,006 lbs. to approximately 2,006 lbs. A GBU-24 could not be carried, at all, with the asymmetric store restrictions of the outboard pylon. F/A-18E/F's bring back capability alleviates concerns and allows for growth. To say that F/A-18C/D bring back deficiencies have not materialized, shows a lack of

understanding and a failure to appreciate the significance of these restrictions to the C/D as it flies today. Additionally it ignores the Department of Defense and Navy foresight in initiating the F/A-18E/F program as a remedy for future increased restrictions when heavier more expensive "smart" weapons such as GB-24, Joint Stand Off Weapon (JSOW), SLAM-ER and Joint Direct Attack Munition (JDAM) form the bulk of our carrier load out. Several of these heavier weapons, such as the GBU-24, were added to the Navy's inventory as a direct result of Desert Storm lessons learned to make the Battle Group better suited to contingency response needs in a major Regional Contingency against enemy land forces. On-going research into munitions and explosives could some day lead to smaller weapons with effectiveness equal to today's larger weapons, but these concepts are many years from development.

GAO raised the proposal that the F/A-18C/D could be modified at low risk to accept 37,000 lbs, capable landing gear as described in the Hornet 2000 study. The Hornet 2000 study did investigate increased capability landing gear, however, when the study was taken to conclusion the present C/D landing gear would have to be sized to absorb 27% more energy. That size landing gear could not fit in the gear opening existing in the C/D. To increase strength and retain the same size gear opening would have required stronger metals that are not developed or qualified. A 37,000 pound landing gear without a redesign to increase the size of the wing to allow for slower approach speeds, would increase wind over deck requirements to an unacceptable 38 knots. Given this situation, in low wind conditions carriers would be unable to generate enough wind over deck to recover the F/A-18C/D. The combination of larger gross landing weights and slower approach speeds is among the reasons for the development of the F/A-18E/F.

GAO RESPONSE:

As stated in our report, the weapons load out example, or "Bosnia Configuration" that DOD cites from our report, is not GAO data, but was provided to us by the F/A-18 Class Desk. We asked for this data in response to a published photo we had seen that showed an F/A-18C landing on a carrier after conducting operations over Bosnia with what appeared to be a load out that would weigh in excess of the ordnance payload the Navy had predicted the F/A-18C would have by the mid-1990s. The Navy then provided us the specifics of routine load outs used for these type of operations.

DOD stated that we failed to recognize the operational limitations resulting from the increase in carrier landing gross weight from 33,000 pounds to 34,000 pounds. In attachment 1, DOD described the increase as a waiver and stated that the fleet commanders were operating with these restrictions, but that further increases in carrier landing gross weight would not be acceptable. According to a Navy official in the Deputy Chief of Naval Operations (Resources, Warfare Requirements & Assessments) Air Warfare Division and F/A-18 program management, the

initial waiver in F/A-18C/D carrier landing gross weight to 34,000 pounds has now been approved as a permanent change in F/A-18C carrier operations. We asked for, but never received this permanent change related to the F/A-18Cs increase in maximum landing weight.

In addressing the anticipated carrier recovery payload deficiency issue, we compared the current status of the F/A-18C's recovery payload with (1) the carrier recovery payload the F/A-18C was operating with in 1992 and (2) the carrier recovery payload the Navy anticipated would occur at the point the Navy stated a recovery payload deficiency would occur. DOD agreed that the F/A-18Cs carrier recovery payload has not declined to the level the Navy predicted it would by the mid-1990s. According to the DOD response, the F/A-18C's carrier recovery payload is 6,281 pounds (3,275 pounds total stores weight plus 3,006 pounds first pass fuel). This carrier recovery payload is almost equal to the 6,300 pounds of carrier recovery payload when the Night Attack F/A-18 was introduced into the fleet in 1988 and greater than the 5,785 pounds of recovery payload capacity that the Navy predicted would constitute a deficiency by the mid-1990s.

In addition, we recently received Navy data that lists an even higher level of carrier recovery payload capacity for the F/A-18C. In January 1996, the Deputy Chief of Naval Operations (Resources, Warfare Requirements & Assessments) reported that the last F/A-18Cs planned for production, which will be heavier than the operating weight of current F/A-18Cs, based on a constant 5,000 pounds of night recovery fuel, have approximately 2,300 pounds of weapons/stores bring-back for a total carrier recovery payload of 7,300 pounds.

Reserve Fuel

DOD stated that, in the future, the bulk of the Navy's carrier load out will include heavier, more expensive "smart" weapons needed to respond to a major regional contingency against land forces. In its response, DOD questioned whether 3,006 pounds first pass reserve fuel is adequate, especially given that this heavier ordnance, such as the 1,000-pound class JSOW, will further reduce the bring-back fuel amount to 2,006 pounds. DOD cites in support of this concern the 4,000 pounds day/5,000 pounds night reserve fuel DOD stated is needed during early workups. However, F/A-18E/F mission range specifications have a much lower first pass fuel reserve than the 5,000 pounds cited for considering carrier recovery payload. According to NAVAIR data, in the E/F Early Operation Assessment, the E/F's first pass fuel level for determining combat range varies from approximately 1,900 pounds to about 2,200 pounds, depending on the mission profile. If the higher 5,000-pound reserve fuel DOD stated

is needed for carrier recovery payload were used for range calculations, the range would be lower than reported.

In our report, we discussed the possibility, outlined in the Hornet 2000 report, of raising the C/D maximum landing weight by strengthening its landing gear. DOD stated that the McDonnell Douglas study that proposed strengthening the C/D landing gear to increase the carrier landing gross weight to 37,000 pounds was preliminary. DOD stated that subsequent analysis to the Hornet 2000 study concluded that this could only be accomplished if the landing gear size were increased, requiring structural changes to the C/D or stronger metals to be used. However, according to E/F program data, newer, stronger metals are now available and will be used in the production of the landing gear for the heavier E/F, which will have a carrier landing gross weight 8,900 pounds heavier than the C/D.

DOD RESPONSE:

GAO contends that F/A-18E/F payload increases may have trouble with stores separation

During the data gathering phase for this report, GAO personnel were invited to attend some F/A-18E/F team meetings. At one or more of these meetings, certain developmental issues with stores clearances were addressed. Apparently the GAO came away thinking that potential design solutions for store clearance tolerances might not be available. This is not the case.

Increasing the size of the F/A-18E/F fuselage while maintaining the pylon distance location from centerline led to stores separation issues anticipated from program inception. The potential for risk in this area was accepted in the final design trade studies. Risk mitigation was applied by commencing early weapons separation testing to identify problem areas. The aircraft flow field was measured and discovered to cause potential weapon to weapon or weapon to aircraft contact. After identifying all of the questionable store release combinations, trade studies were performed to identify the potential design solutions. A year and a half of wind tunnel runs, and flight and ground tests yielded three strong design alternatives for correcting the problem. Following completion of the most recent applicable wind tunnel testing for stores separation in February 1995, a solution was selected. The solution, slightly toeing the pylons 4 degrees outboard, indicates through analysis that full carriage capability will be regained with minimal range and performance impact (7-15 miles depending on mission profile). Flight separation testing begins this year on aircraft F-1; early in 1997 on E-5 and F-2; and progresses throughout the remainder of E&MD into FOT&E to complete the full stores carriage envelope for the aircraft. The aircraft is expected to exceed specification.

GAO RESPONSE:

We met with McDonnell Douglas engineering representatives to discuss the stores separation problems. The information in our report is presented as provided to us.

Subsequent to the release of our draft report to DOD for comment, McDonnell Douglas identified several unique solutions to correct the stores separation problem. We have since determined that a preferred solution has been selected. DOD stated this solution was identified in February 1995 and flight test separation will begin in 1996. However, contractor officials told us that the preferred solution was not selected until April 1996 and the E/F test schedule shows that tests will not take place until 1998 to validate how well the proposed weapons separation remedy works.

The stores separation issue was addressed in the E/F Early Operational Assessment. The EOA also identified another problem with E/F stores carriage. According to the EOA, the larger 480-gallon external fuel tanks are not compatible with the aircraft's sensors and may hinder aircraft operations.

DOD RESPONSE:

GAO contends that F/A-18E/F new outboard wing stations have limited value

GAO asserts that since the outboard pylons are limited to 1,150 lbs. that the "F/A-18E/F will carry the same number of heavier precision guided munitions as the F/A-18C/D."

GAO fails to credit the F/A-18E/F's ability to carry the heavier precision weapons while carrying self protection weapons such as HARM, AMRAAM, and Sidewinder on the outboard pylon. The C/D would have to give up use of a heavy store pylon to carry the same protection. The outboard pylons were specifically designed for weapons mix flexibility and self protection, not for the heavier munitions (See Figure 1). The comparison below shows how the E/F carries more heavier precision weapons when going into a high threat area requiring HARM missiles.

Now on p. 92.

Appendix III
Comments From the Department of Defense

F/A-18C/D F/A-18E/F
(4) JSOW (4) JSOW
(2) Sidewinder (2) HARM
 (2) Sidewinder

F/A-18C/D F/A-18E/F
(2) JSOW (4) JSOW
(2) HARM (2) HARM
(2) Sidewinder (2) Sidewinder

Appendix III
Comments From the Department of Defense

DOD Figure 1: F/A-18E/F Maximum Possible Carriage of Specified Weapons

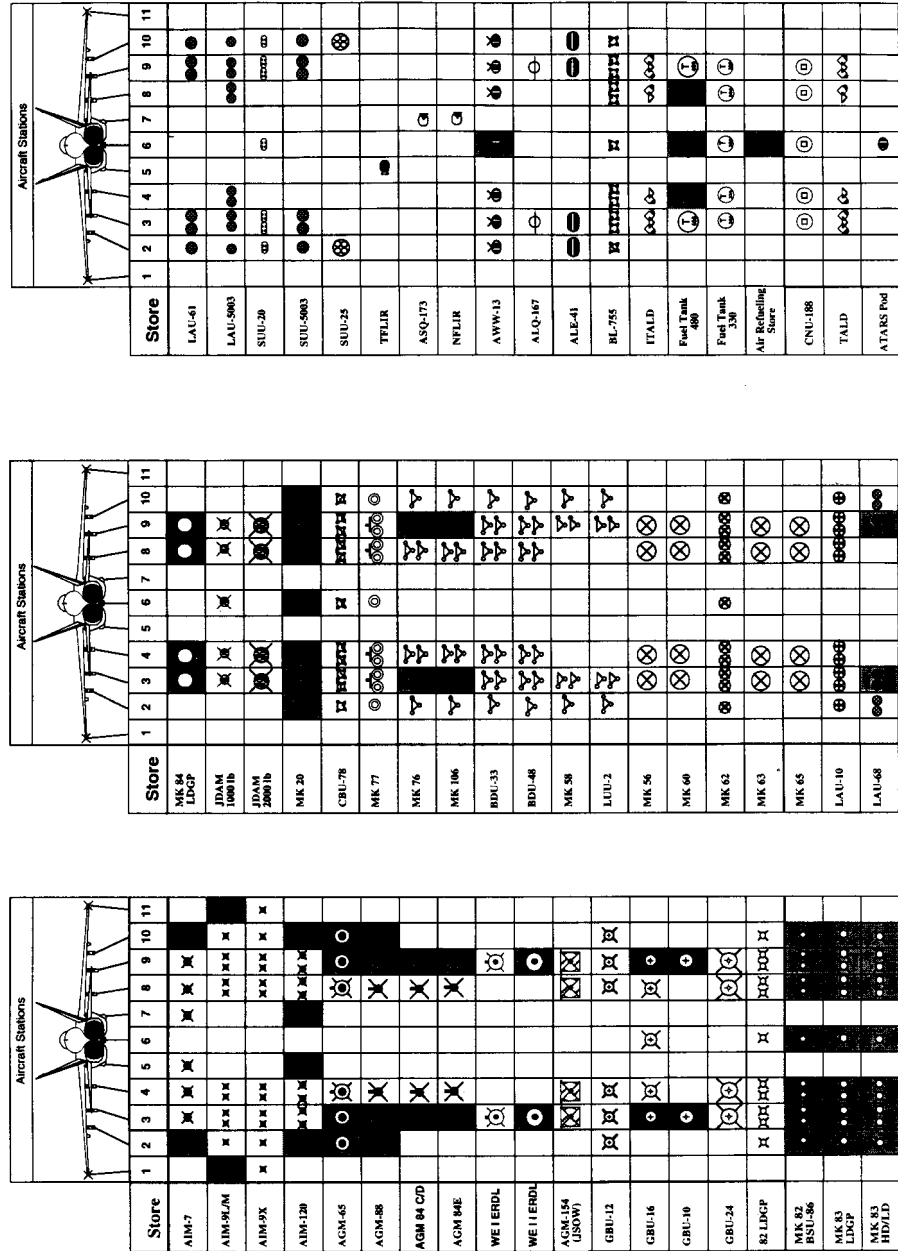

GAO RESPONSE:

DOD's data show that, as we reported, the E/F will not be able to carry any more of the heavier precision-guided munitions than the C/D. However, DOD stated that we failed to recognize that the E/F, with its two additional weapons stations, will be able to carry more HARM self-protection missiles than the C/D. We question whether carrying more HARM missiles can be considered a cost-effective improvement in capability. Because the F/A-18 aircraft used to launch the HARM missile have very limited ability to locate threat radars, the Navy uses a tactic known as preemptive suppression. Instead of waiting for a radar to begin emitting and then attacking it, the F/A-18 aircraft preemptively launch HARM missiles at known enemy radar sites so that the missiles will arrive at the time Navy strike aircraft are performing missions in their vicinity. The Navy's intent is that the HARM will attack the radar if it is emitting or force the radar to either shutdown or not turn on while the Navy aircraft are in the area. Using HARM missiles in such a low-probability-of-kill scenario may not be cost-effective. At a cost of about \$317,000 a missile, the HARM may be too expensive to be used in such a manner on a regular basis.

Additionally, McDonnell Douglas data and the data provided in DOD's response is not conclusive on the E/F's capability to carry additional HARM missiles. According to McDonnell Douglas weapons carriage profiles comparing the E/F with the C/D, the E/F will be able to carry HARM missiles on the outboard wing stations, but launching the HARM from these stations would violate clearance criteria. Furthermore, information in a DOD document, entitled "F/A-18E/F Maximum Possible Carriage of Specified Weapons," stated that carriage of the HARM on the outboard E/F stations will have to be demonstrated during engineering and manufacturing technical evaluation flight testing.

DOD RESPONSE:

GAO contends that F/A-18 growth space deficiency has not developed as predicted

GAO states that there is more than two tenths ft³ of volume for avionics in the F/A-18C/D. GAO claims that MDA representatives told them an additional 5.3ft³ exists. Of that 5.3 ft³, 4.0 ft³ is attributed to a proposed change in the gun bay and 1.3 ft³ in the right leading edge extension. The proposed design change to the gun ammunition drum, if it were to be approved, would only allow 1.4 ft³ of usable space, and that space would be in the harsh vibration environment of the gun bay, not suitable for avionics. It would also take up the same space reserved for the tactical reconnaissance pallet. In reviewing the 3.0 ft³ additional space identified by GAO (page 27) for avionics, similar non-usable situations exist. The difficulty of managing

Now on p. 40.

avionics growth in the F/A-18C/D is identifying usable space. The F/A-18 program has struggled finding usable space for modifications. Because of the lack of space on the F/A-18C/D, costly integration and redesign efforts are currently underway to accommodate Congressionally mandated capabilities such as Global Positioning System (GPS), and Positive Identification System (a new IFF interrogator), along with Digital Communications (for Close Air Support).

GAO asserts that miniaturization of electronics could have taken the place of F/A-18E/F designing in volume to accommodate systems growth. This may be true, however, the design to cost guidelines that were imposed by the Navy to meet the Navy's investment criteria prohibited a complete redesign of the avionics suite to the JIAWG architecture that was being pursued at the time of the decision to enter E&MD on the E/F. Displays were the only new equipment developed for the E/F program to meet Operational Requirements Document requirements to improve aircrew situational awareness. The combination of airframe design changes for increased range and bring back while maintaining 90% commonality with F/A-18C/D state of the art avionics, miniaturized where possible, provides the most cost effective design while not having to endure costly avionics redesign and integration.

GAO RESPONSE:

DOD comments concerning the limited amount of usable space that would result from modifying the gun bay to accommodate a Linear Linkless feed system are not supported by the McDonnell Douglas F/A-18E/F Baseline Configuration Study. This study stated that 4 cubic feet of "usable" space would be available from this modification. Furthermore, this area is one of the areas in which the additional E/F growth space was to be derived, and the study identifies Navy plans to position avionics in this space. Also, in its comments, DOD stated that the same space will be used to house the reconnaissance avionics package for the C/D. According to McDonnell Douglas officials, the reconnaissance avionics package is only planned for the F/A-18D model.

We did not determine whether the 3 cubic feet of space derived from replacing older systems with new less space demanding systems was usable or not. However, we were told that the Navy considered 0.25 cubic feet of space and above as usable for avionics systems. Furthermore, as stated in our report and confirmed in the DOD comments, miniaturization and modularization of avionics has and will provide additional space for growth should it be needed. However, according to E/F system specifications, while E/F design has resulted in growth space, the amount required is significantly less than what the Navy states is available. According to program documents, only 5.3 cubic feet of space is needed to accommodate systems that are unique to the E/F. Also, program documents list E/F growth space at 17 cubic feet when compared to the baseline fiscal year 1988 C/D. Systems have been added to the

baseline since it was established. This will result in less than 17 cubic feet of space available for added growth once the E/F is fielded.

DOD's implication that we proposed a wholesale miniaturization of avionics in order to meet the growth space needs for the F/A-18E/F is not accurate. In our report, we show specific examples, using McDonnell Douglas-provided data, how over time growth space availability has increased as a result of the reduced space needed for the newer, smaller replacement avionics. Furthermore, this trend in smaller and lighter aircraft avionics is supported by JAST trade studies. In a concept exploration trade study for the JAST program, McDonnell Douglas concluded that shared radio frequency apertures/sensors technology, integrated on-board/off-board sensors, weapons/weapons integration-advanced terminal guidance, and flight systems-subsystem and power technology would, in addition to reduced volume, save over 2,200 pounds of system weight. This weight-saving would be beneficial to many areas of C/D carrier suitability improvements, including reduced wind-over-deck and increased carrier recovery payload, as well as improved aircraft performance.

FINDING 3: Joint Strike Fighter Is Predicted to Be Less Costly and More Capable Than the F/A-18E/F

DOD RESPONSE:

The Joint Strike fighter (JSF) shows great promise for meeting multi-service requirements in the future. At no time has the JSF been considered as a replacement to the F/A-18 in the fleet. The Navy has always envisioned the JSF as a complement to the F/A-18E/F. This fact is reflected in the JSF Joint Initial Requirements Document. The long term Navy force modernization plans are to replace the C/Ds with E/Fs, and to replace the F-14s with F/A-18Fs.

The JSF is in the early stages of the development process. Concept Development is scheduled to begin in FY97. The JSF is not scheduled to enter the rigorous Engineering and Manufacturing Development phase until FY 01. While the JSF contains features (such as a single engine) that would tend to reduce unit cost, and it has stealth features designed in from the start, the system must prove that it can meet all of the objectives established for it.

The F/A-18E/F is planned to enter service soon after the turn of the century. The JSF currently is expected to lag the E/F in fleet service by almost a decade, several years later than the 2007 date suggested in the GAO report. Given the greater schedule risk involved in the less well-defined JSF program, that gap could increase. The JSF is not a near-term successor to the F/A-18E/F.

GAO RESPONSE:

We did not address whether the JSF is appropriately identified as a complement to the E/F. However, according to the recent Naval Intelligence report "Worldwide Challenges To Naval Strike Warfare," the JSF will have better overall combat effectiveness than the E/F. Also, the JAST program is focused on reducing the procurement cost of the JSF relative to the cost of current aircraft. According to JAST data, which is based on concept exploration and concept development trade studies, the cost of the Navy's version of the JSF is projected to be less than the cost of the E/F.

While the JSF will not enter engineering and manufacturing development until calendar year 2001, it will do so only after 3 years of concept exploration and concept development analysis by industry and a 4-year concept demonstration effort. The concept demonstration phase will have two contractor teams build ground and flight conventional takeoff and landing and short takeoff and vertical-landing variant demonstrators for the three services. The focus of this effort is to reduce the engineering and manufacturing development risk.

During recent Senate Armed Services Committee hearings, the services discussed their support for the JAST/JSF effort. The Navy's Director, Air Warfare Division, testified that the Navy was firmly committed to JAST as the key to fulfilling both the Navy's requirement for a "first day survivable, stand-alone, strike-fighter" and the Marine Corps' requirement to replace both their AV-8s and F/A-18s with a highly capable advanced short takeoff and vertical-landing aircraft.

FINDING 4: F/A-18E/F Will Cost More Than Currently Estimated
DOD RESPONSE:

GAO asserts that the F/A-18E/F will not achieve its projected average unit flyaway cost because the program will not achieve its buy of 1,000 aircraft. GAO states that of the 1000 aircraft, 340 are for the Marine Corps, who are no longer in the program.

During initial planning, the program utilized many factors to estimate total aircraft quantities. While DoD anticipated for several years that the Marine Corps would acquire the F/A-18E/F, and the Defense Program Projection (DPP) was based on that assumption until this year, the planning assumptions that exist now have changed dramatically since the late 1980's. There are currently other Navy force option possibilities that will be reviewed by DoD as a part of PM 98. Should these options favorably compete for funds, the projected Navy-only requirement could increase. In addition, any delays in the JSF Initial Operational Capability, will result in the need for additional F/A-18E/Fs to sustain force structure. The uncertainty in defense budget projections out to the year 2015 is shared equally by the F/A-18E/F program, making

the total buy a matter of conjecture at this time. As the defense budgets are formulated, the Department will assess, the impact of lower total buys on the F/A-18E/F unit cost. In addition, other options for maintaining and/or reducing unit cost will also be assessed. At the approved budget/program procurement rate for a total buy of 1000 aircraft, the unit recurring flyaway cost is \$43.4M (FY96 dollars).

Also, the potential for future Foreign Military Sales (FMS) must be given consideration. Similar FMS benefits were attributed to the F/A-18A/B/C/D program where FMS accounted for more than 430 aircraft in a total buy of 1434. At the height of USN F/A-18A/B procurement of 84 per year, FMS procurement drove the annual production to 144. Even as recently as FY94 when the program dropped to 36 per year, FMS procurement kept the yearly buy at 84 and in FY95 when USN procurement went to 24, FMS increased that number to 43. FMS interest is high for the E/F and the Navy anticipates similar FMS sales to that of the A/B/C/D program.

GAO claims the contractor indicates Low Rate Initial Production (LRIP) cost estimates are projected 10% higher than those reported to Congress. This is not true. LRIP 1 initial pricing estimates, the product of a combined Navy/Contractor team, were received in 1995 and indicated that unit flyaway costs were within Defense Acquisition Board profiles. Formal RFP response and LRIP I negotiations have given additional insight into the veracity of the estimates and are consistent with a contract price at or below current estimates for unit flyaway cost. This estimate is for a cost type contract that has yet to be definitized, however, the maturity of the estimates provides strong confidence that LRIP 1 will meet its cost targets.

GAO RESPONSE:

We did not assert that the E/F will not achieve its projected unit flyaway cost, but, based on the Navy's own data, the E/F average unit flyaway cost will exceed the congressionally mandated E/F cost cap (125 percent of C/D cost). Using the Navy's E/F average unit flyaway cost of \$43.4 million (fiscal year 1996 dollars), which is lower than the \$43.6 million figure previously provided to us in February 1996, compared to the C/D's \$28 million (fiscal year 1996 dollars), the E/F cost will be 155 percent rather than 125 percent of C/D cost. However, this cost will further increase if the E/F total buy and/or the annual production rate declines. According to the Marine Corps, it does not plan to procure the E/F.

In its response, DOD agreed with our report concerning Marine Corps procurement of the E/F. DOD stated that Marine Corps procurement of the E/F has been factored out of the program buy, but stated that the total E/F buy may not decline even without the Marine Corps should the JSF initial operational capability be delayed. The Navy's current plan is to have future carrier airwings made up of 36 F/A-18s (either C/Ds or E/Fs) and 14 F-14s, but the Navy is studying the impact on E/F procurement if carrier airwings were comprised entirely of E/Fs. Going

to all E/F airwings would appear to require the early retirement of F/A-C/Ds and F-14s because the C/D is projected to be in the Navy's inventory until 2020 and improvements are being made to the F-14, which industry states will be supported until at least 2010. Also, questions concerning the probability of the JSF meeting its projected initial operational capability should be tempered with the fact that the JSF industry teams have been working on future stealth aircraft for some time, have been focusing extensively on reducing aircraft unit cost since the A/F-X program began in 1991, and are planning to focus on JSF risk reduction extensively during the 4-year concept demonstration phase where prototypes will be flown. Furthermore, as DOD stated, the total E/F buy is a matter of conjecture at this time. DOD anticipates that a new Bottom-Up Review will be done to address the cost of future defense systems given the anticipated reduced defense budgets.

DOD stated that the impact of foreign military sales on E/F production cost should be given consideration. DOD cited past F/A-18A/B/C/D foreign military sales production and the impact it had on annual production rates. However, according to McDonnell Douglas Program Management, the E/F, which is described as having a low observable airframe, may not be suited for foreign military sales. Consequently, reliance on foreign military sales is uncertain and inclusion of it to project a lower E/F unit cost would be speculative at this point.

DOD stated that our information that the anticipated 10-percent increased cost of acquiring LRIP I production E/F aircraft did not occur and that the LRIP I unit flyaway costs are within DAB profiles. After obtaining additional contractor documents, we determined that the increase was 8.5 percent, not the 10 percent we originally reported in our draft. However, we have since learned that about 1 year ago, McDonnell Douglas accepted a goal from NAVAIR to reduce the E/F's LRIP I cost by 15 percent. In a February 1996 letter to NAVAIR, McDonnell Douglas stated it had exceeded this goal by a combination of internal efforts to reduce cost, eliminate and modify unnecessary requirements, and deferment of certain efforts to future time periods. An attachment to this letter lists the cost reduction initiatives that have been reviewed by Navy personnel and deemed acceptable. This list is made up of deleted and deferred tasks associated with the E/F LRIP I initiative. We do not know the impact of the deleted tasks on the E/F program; however, the cost of the deferred tasks will be realized at some later point.

DOD RESPONSE:

GAO contends that survivability improvements not needed

GAO states that the F/A-18E/F was not justified on the need to counter a particular military threat that could not be countered by the F/A-18C/D as enhanced by additional planned survivability features.

GAO, however, also cites the Under Secretary of Defense for Acquisition's, April 1993 "Report to Congress on Fixed-Wing Tactical Aviation Modernization" which identified threats beyond 2000 that would require improvements in Tactical Fixed Wing Aircraft, including the F/A-18. The F/A-18E/F Operational Requirements Document (ORD) reflects this position and has as one of its three prime requirements, improved survivability over the F/A-18C/D.

GAO in saying that improvements were not justified, seems to draw a distinction that the analysis from the USD(A) report was based on system versus system analysis. GAO claims that while the F/A-18 E/F and F/A-18C/D were identified as needing improvement in that study, they both operate as part of a force package so individual aircraft improvement is not needed. While both aircraft will operate as part of a force package, they will not always have the benefits of that support. The F/A-18E/F has improved survivability to counter the improved threats that it may have to face in a classic one vs one encounter. The redesign of the F/A-18E/F made possible a synergistic improvement to survivability. The balanced design includes radar cross section (RCS) reduction, decreases in vulnerable area, and an integrated defensive electronic warfare suite to provide an affordable answer to the projected threat. The E/F was designed within an affordability box that is demonstrating through test that the E/F will be significantly more survivable, and have an RCS an order of magnitude lower than the F/A-18C/D for threats predicted through 2015. The Department firmly believes that the aviators who fly our combat aircraft should not be shortchanged when it comes to survivability.

GAO RESPONSE:

We did not state that survivability improvements to the C/D or the E/F are not needed. What we stated was that, according to Navy statements, improvements in the E/F's radar cross section resulting from airframe modifications may not be fully realized due to the carriage of external stores on the E/F. These concerns were recently raised in the E/F EOA report. We also cited JAST conclusions, which are consistent with past stealth aircraft development, that external stores carriage will not allow an aircraft to be low observable (stealthy). As we stated in our report, E/F program management recently stated that ways to treat the E/F's external stores and equipment would have to be developed to realize the benefits of radar cross section reduction to the airframe. Furthermore, as we stated in our report, the E/F radar cross section improvements are

in the frontal aspect of the aircraft. This would increase the aircraft's survivability in air-to-air engagements, but could be limited against ground threats (integrated air defense systems) in which the frontal radar cross section reduction would be less effective.

In its response, DOD stated that the E/F has a balanced design, of which radar cross section reduction is only one part. DOD cited decreases in vulnerable area and an integrated defensive electronic warfare suite as additional survivability contributors. We noted that these additional survivability contributors were evaluated as part of the E/F Early Operational Assessment. The specific results of the assessment are classified, but our review of the EOA report showed that development issues associated with these contributors need to be resolved before they will be operationally effective. We are currently reviewing these efforts and will be reporting on them separately. Additionally, the larger size of the E/F over the C/D may increase the E/F's vulnerability during visual engagements in which first look could mean first kill. Furthermore, in our report we cited the survivability improvements/enhancements made or planned for the C/D that are not related to signature reduction, such as the enhanced performance engine, the ALR-67 (V)3 advance special radar warning receiver, or the use of standoff weapons. Also, as we stated in our report, Navy data show that the E/F will have reduced air-to-air combat performance compared to the C/D as a result of increased weight and less-than-expected engine thrust.

Major Contributors to This Report

**National Security and
International Affairs
Division, Washington,
D.C.**

Steven F. Kuhta
Jerry W. Clark
William J. Gillies
Charles R. Climpson

**Kansas City Regional
Office**

Lawrence A. Dandridge
Lillian I. Slodkowski

Ordering Information

The first copy of each GAO report and testimony is free. Additional copies are \$2 each. Orders should be sent to the following address, accompanied by a check or money order made out to the Superintendent of Documents, when necessary. VISA and MasterCard credit cards are accepted, also. Orders for 100 or more copies to be mailed to a single address are discounted 25 percent.

Orders by mail:

U.S. General Accounting Office
P.O. Box 6015
Gaithersburg, MD 20884-6015

or visit:

Room 1100
700 4th St. NW (corner of 4th and G Sts. NW)
U.S. General Accounting Office
Washington, DC

Orders may also be placed by calling (202) 512-6000
or by using fax number (301) 258-4066, or TDD (301) 413-0006.

Each day, GAO issues a list of newly available reports and testimony. To receive facsimile copies of the daily list or any list from the past 30 days, please call (202) 512-6000 using a touchtone phone. A recorded menu will provide information on how to obtain these lists.

For information on how to access GAO reports on the INTERNET, send an e-mail message with "info" in the body to:

info@www.gao.gov

or visit GAO's World Wide Web Home Page at:

<http://www.gao.gov>

**United States
General Accounting Office
Washington, D.C. 20548-0001**

**Bulk Rate
Postage & Fees Paid
GAO
Permit No. G100**

**Official Business
Penalty for Private Use \$300**

Address Correction Requested

