

NISTIR 7880-25

**NIST Micronutrients Measurement
Quality Assurance Program
Winter and Summer 1999
Comparability Studies**

Results for Round Robin XLV and XLVI
Fat-Soluble Vitamins and Carotenoids in Human Serum
and Round Robin 12 Ascorbic Acid in Human Serum

David L. Duewer
Sam A Margolis (Retired)
Katherine E. Sharpless
Jeanice B. Thomas

<http://dx.doi.org/10.6028/NIST.IR.7880-25>

NIST
**National Institute of
Standards and Technology**
U.S. Department of Commerce

NISTIR 7880-25

NIST Micronutrients Measurement Quality Assurance Program Winter and Summer 1999 Comparability Studies

Results for Round Robin XLV and XLVI
Fat-Soluble Vitamins and Carotenoids in Human Serum
and Round Robin 12 Ascorbic Acid in Human Serum

David L. Duewer
Sam A Margolis (Retired)
Katherine E. Sharpless
Jeanice B. Thomas
*Chemical Sciences Division
Materials Measurement Laboratory*

<http://dx.doi.org/10.6028/NIST.IR.7880-25>

June, 2013



U.S. Department of Commerce
Penny Pritzker, Secretary

National Institute of Standards and Technology
Patrick D. Gallagher, Under Secretary of Commerce for Standards and Technology and Director

(This page intentionally blank)

Abstract

The National Institute of Standards and Technology coordinates the Micronutrients Measurement Quality Assurance Program (MMQAP) for laboratories that measure fat- and water-soluble vitamins and carotenoids in human serum and plasma. This report describes the design of and results for the Winter and Summer 1999 MMQAP measurement comparability improvement studies: 1) Round Robin XLV Fat-Soluble Vitamins and Carotenoids in Human Serum, 2) Round Robin XLVI Fat-Soluble Vitamins and Carotenoids in Human Serum, and Round Robin 12 Vitamin C in Human Serum. The materials for Round Robin XLV were shipped to participants in January 1999; participants were requested to provide their measurement results by April 2, 1999. The materials for Round Robin XLVI were shipped to participants in June 1999; participants were requested to provide their measurement results by September 10, 1999. The sample materials for Round Robin 12 were distributed in February 1999 with results due by March 26, 1999; a "Final Report" that combined results for Round Robins 11 and 12 was distributed in August 1999.

Keywords

Human Serum

Retinol, α -Tocopherol, γ -Tocopherol, Total and *Trans*- β -Carotene
Ascorbic Acid, SRM 970

Table of Contents

Abstract	iii
Keywords	iii
Table of Contents	iv
Introduction	1
Round Robin XLV: Fat-Soluble Vitamins and Carotenoids in Human Serum	1
Round Robin XLVI: Fat-Soluble Vitamins and Carotenoids in Human Serum	2
Round Robin 12: Vitamin C in Human Serum	2
References	3
Appendix A. Shipping Package Inserts for RR45	A1
Appendix B. Final Report for RR45	B1
Appendix C. “All-Lab Report” for RR45	C1
Appendix D. Representative “Individualized Report” for RR45	D1
Appendix E. Shipping Package Inserts for RR46	E1
Appendix F. Final Report for RR46	F1
Appendix G. “All-Lab Report” for RR46	G1
Appendix H. Representative “Individualized Report” for RR46	H1
Appendix I. Shipping Package Inserts for RR12	I1
Appendix J. Combined Final Report for the RR11 and RR12	J1
Appendix K. Representative “Individualized Report” for the Combined RR11 and RR12 ...	K1

Introduction

Beginning in 1988, the National Institute of Standards and Technology (NIST) has coordinated the Micronutrients Measurement Quality Assurance Program (MMQAP) for laboratories that measure fat- and water-soluble vitamins and carotenoids in human serum and plasma. The MMQAP provides participants with measurement comparability assessment through use of interlaboratory studies, Standard Reference Materials (SRMs) and control materials, and methods development and validation. Serum-based samples with assigned values for the target analytes (retinol, alpha-tocopherol, gamma/beta-tocopherol, *trans*- and total beta-carotene, and ascorbic acid) and performance-evaluation standards are distributed by NIST to laboratories for analysis.

Participants use the methodology of their choice to determine analyte content in the control and study materials. Participants provide their data to NIST, where it is compiled and evaluated for trueness relative to the NIST value, within-laboratory precision, and concordance within the participant community. NIST provides the participants with a technical summary report concerning their performance for each exercise and suggestions for methods development and refinement. Participants who have concerns regarding their laboratory's performance are encouraged to consult with the MMQAP coordinators.

All MMQAP interlaboratory studies consist of individual units of batch-prepared samples that are distributed to each participant. For historical reasons these studies are referred to as "Round Robins". The MMQAP program and the nature of its studies are described elsewhere. [1,2]

Round Robin XLV: Fat-Soluble Vitamins and Carotenoids in Human Serum

Participants in the MMQAP Fat-Soluble Vitamins and Carotenoids in Human Serum Round Robin XLV comparability study (hereafter referred to as RR45) received four lyophilized human serum test samples for analysis. Unless multiple vials were previously requested, participants received one vial of each serum. These sera were shipped on dry ice to participants in January 1999. The communication materials included in the sample shipment are provided in Appendix A.

Participants are requested to report values for all fat-soluble vitamin-related analytes that are of interest to their organizations. Not all participants report values for the target analytes, and many participants report values for non-target analytes.

The final report delivered to every participant in RR45 consists of three documents:

- A cover letter for the current study, a brief description of the other two documents, and a discussion of our analysis of the overall results that may be of broad interest. This cover letter is reproduced as Appendix B.
- The "All-Lab Report" that lists all of the reported measurement results, a number of consensus statistics for analytes reported by more than one participant, and the mean median and pooled SD from any prior distributions of the serum. This report also provides a numerical "score card" for each participant's measurement comparability for the more commonly reported analytes. This report is reproduced as Appendix C.

- An “Individualized Report” that graphically analyzes each participant’s results for selected analytes. This report also provides a graphical summary of their measurement comparability. The graphical tools used in this report are described in detail elsewhere [3]. An example “Individualized Report” is reproduced as Appendix D.

Round Robin XLVI: Fat-Soluble Vitamins and Carotenoids in Human Serum

Participants in the MMQAP Fat-Soluble Vitamins and Carotenoids in Human Serum Round Robin XLVI comparability study (hereafter referred to as RR46) received four lyophilized human serum test samples for analysis. Unless multiple vials were previously requested, participants received one vial of each material. These sample materials were shipped on dry ice to participants in June 1999. The communication materials included in the sample shipment are provided in Appendix E.

Participants are requested to report values for all fat-soluble vitamin-related analytes that are of interest to their organizations. Not all participants report values for the target analytes, and many participants report values for non-target analytes.

The final report delivered to every participant in RR46 consists of three documents:

- A cover letter for the current study, a brief description of the other two documents, and a discussion of our analysis of overall results that may be of broad interest. This cover letter is reproduced as Appendix F.
- The “All-Lab Report” that lists all of the reported measurement results, a number of consensus statistics for analytes reported by more than one participant, and the mean median and pooled SD from any prior distributions of the serum. This report also provides a numerical “score card” for each participant’s measurement comparability for the more commonly reported analytes. This report is reproduced as Appendix G.
- An “Individualized Report” that graphically analyzes each participant’s results for selected analytes. This report also provides a graphical summary of their measurement comparability. The graphical tools used in this report are described in detail elsewhere [3]. An example “Individualized Report” is reproduced as Appendix H.

Round Robin 12: Vitamin C in Human Serum

Participants in the MMQAP Vitamin C in Human Serum Round Robin 12 comparability study (hereafter referred to as RR12) received four frozen serum test samples and a solid ascorbic acid control material for analysis. Two of the test samples were identified as levels 1 and 2 of SRM 970. The other two samples were also levels 1 and 2 of SRM 970, but were identified only as “Unknowns”. These sample materials were shipped on dry ice to participants in February 1999. The communication materials included in the sample shipment are provided in Appendix I.

Participants were asked to provide two results for each vial and were asked to prepare and evaluate a standard solution of 50 μmol ascorbic acid (AA) per L solution of 5 % by mass metaphosphoric acid.

No report on participant results was prepared for just RR12. Rather, a “Final Report” for the combination of RR11 and RR12 was distributed to all participants in RR11 and/or RR12 in August 1999. This report consisted of:

- A cover letter and summary analysis of the results from RR11 and/or RR12. This report is reproduced as Appendix J. It contains the following tables and figure:
 - a. Table 1: Round Robin 11 and 12 for the Measurement of AA in Human Serum.
 - b. Table 2: Vitamin C Round Robin 11.
Note: Table 2 is equivalent to the usual “All Lab Report” for RR11.
 - c. Table 3: Vitamin C Round Robin 12.
Note: Table 3 is equivalent to the usual “All Lab Report” for RR12.
 - d. Figure 1: Distribution of Participant Results in Round Robins 11 and 12.

- An “Individualized Report” that graphically analyzes each participant’s results including a graphical summary of their measurement comparability. The graphical tools used in this report are described in detail elsewhere [3]. An example “Individualized Report” is reproduced as Appendix K.

With certified values based partially on the results from RR11 and RR12, SRM 970 was released for sale on May 18, 2000.

References

- 1 Duewer DL, Brown Thomas J, Kline MC, MacCrehan WA, Schaffer R, Sharpless KE, May WE, Crowell JA. NIST/NCI Micronutrients Measurement Quality Assurance Program: Measurement Repeatabilities and Reproducibilities for Fat-Soluble Vitamin-Related Compounds in Human Sera. *Anal Chem* 1997;69(7):1406-1413.
- 2 Margolis SA, Duewer DL. Measurement Of Ascorbic Acid in Human Plasma and Serum: Stability, Intralaboratory Repeatability, and Interlaboratory Reproducibility. *Clin Chem* 1996;42(8):1257-1262.
- 3 Duewer DL, Kline MC, Sharpless KE, Brown Thomas J, Gary KT, Sowell AL. Micronutrients Measurement Quality Assurance Program: Helping Participants Use Interlaboratory Comparison Exercise Results to Improve Their Long-Term Measurement Performance. *Anal Chem* 1999;71(9):1870-1878.

Appendix A. Shipping Package Inserts for RR45

The following two items were included in each package shipped to an RR45 participant:

- Cover letter
- Datasheet

The cover letter and datasheet were enclosed in a sealed waterproof bag along with the samples themselves.



UNITED STATES DEPARTMENT OF COMMERCE
National Institute of Standards and Technology
Gaithersburg, Maryland 20899-

January 25, 1999

Dear Colleague:

Enclosed is the set of samples for the first quality assurance round robin exercise (Round Robin XLV) for FY99. You will find one vial of each of four lyophilized serum samples for analysis along with a form for reporting your results. When reporting your results, please submit one value for each analyte for a given serum sample. If an obtained value is below your limit of quantitation, please indicate this result on the form by using NQ (*Not Quantitated*). For analytes not measured, please leave a blank. Results are due to NIST by **April 2, 1999**. Results received two weeks after the due date will not be included in the summary report for this round robin study. The feedback report concerning the study will be provided around the end of April.

Samples should be reconstituted with 1.0 mL of HPLC-grade water or equivalent. We recommend that dissolution be facilitated with 3 to 5 min agitation in an ultrasonic bath or at least 30 min at room temperature with intermittent swirling. (CAUTION: Vigorous shaking will cause foaming and possibly interfere with accurate measurement. The rubber stopper contains phthalate esters that will leach into the sample upon intermittent contact of the liquid sample with the stopper. These esters absorb strongly in the UV region and elute very near retinol in most LC systems creating analytical problems.) Pipette a known volume of serum from the vial for analysis. (The final volume of the reconstituted sample is greater than 1.0 mL.). For consistency, we request that laboratories use the following absorptivities (E 1% cm) in ethanol: retinol, 1843 at 325 nm; retinyl palmitate, 975 at 325 nm; α -tocopherol, 75.8 at 292 nm; γ -tocopherol, 91.4 at 298 nm; α -carotene, 2800 at 444 nm (in hexane); β -carotene, 2560 at 450 nm (in ethanol), 2592 at 452 nm (in hexane); lycopene, 3450 at 472 nm (in hexane).

Please mail or fax your results for Round Robin XLV to:

Micronutrients Measurement Quality Assurance Program
NIST
100 Bureau Drive Stop 8392
Gaithersburg, MD 20899-8392
Fax: (301) 977-0685

If you have questions regarding this round robin exercise, please call me at (301) 975-3120; e-mail me at jeanice.brownthomas@nist.gov; or mail/fax queries to the above address.

Sincerely,

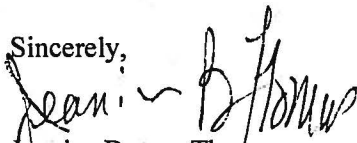
Jeanice Brown Thomas
Research Chemist
Analytical Chemistry Division
Chemical Science and Technology Laboratory

Enclosures

cc: S. Wise
L. Sander

NIST

NIST
Micronutrients Measurement Quality Assurance Program

Round Robin XLV Results from Laboratory #_____

Analyte	Serum				Units*
	251	252	253	254	
retinol					
retinyl palmitate					
α-tocopherol					
γ-tocopherol					
δ-tocopherol					
total β-carotene					
trans-β-carotene					
total cis-β-carotene					
total α-carotene					
trans-α-carotene					
total lycopene					
trans-lycopene					
β-cryptoxanthin					
α-cryptoxanthin					
“lutein”					
“zeaxanthin”					
“lutein&zeaxanthin”					

Other Analytes?					

* We prefer mg/mL

Today's Date:

Comments?

Appendix B. Final Report for RR45

The following ten pages are the final report as provided to all participants:

- Cover letter
- An information sheet that:
 - describes the contents of the “All-Lab” report
 - describes the content of the “Individualized” report
 - describes the nature of the test samples and details any previous distributions
 - summarizes aspects of the study that we believe may be of interest to the participants



May 19, 1999

Dear Colleague:

Enclosed is the summary report of the results for Round Robin XLV (RR 45). Included in this report are: a summary of data for all laboratories; the measurement comparability summary for evaluating laboratory performance; a summary of individual laboratory performance and interlaboratory accuracy and precision; and a summary of the NIST assigned value (NAV) vs. your laboratory value for the analytes measured. As in previous reports, the NIST assigned values are derived from the equally weighted results from the analyses performed by NIST and the laboratories that participated in this interlaboratory comparison exercise.

Serum samples (Sera 251-254) distributed in RR 45 were also analyzed in previous round robin exercises. Serum 25 was distributed as Serum 242 in RR 42. Serum 252 was originally prepared in 1987 as Control D and was distributed as Serum 78 in RR 12 and as Serum 163 in RR 24. Serum 253 was previously distributed as Sera 182 and 185 (blind replicates) in RR 28 and as Serum 216 in RR 36. Serum 254 was previously distributed as Serum 192 in RR 30.

Data for evaluating laboratory performance in RR 45 are provided in the comparability summary (Score Card) on page 6 of the "All Lab Report." Laboratory comparability is summarized as follows: results rated 1-3 are within 1-3 standard deviation(s) of the assigned value; those rated 4 are >3 standard deviations from the assigned value.

If you have concerns regarding your laboratory performance, we suggest that you obtain a unit of SRM 968b, Fat-Soluble Vitamins and Cholesterol in Human Serum, and analyze all three levels. If your measured values do not agree with the certified values, we suggest that you contact us for consultation.

The QA workshop was held on April 16 prior to Experimental Biology '99 in Washington, DC. There were more than 50 people in attendance; the exchange of information and ideas was invaluable. QA participants suggested that we continue to hold future workshops in conjunction with Experimental Biology. We tentatively plan to hold the next workshop in 2001 in Orlando, FL.

In the last correspondence, I mentioned that we plan to make available, at a nominal cost, a limited supply of well-characterized serum pools that were used in previous intercomparison exercises for the QA program. These samples are currently being evaluated for value assignment. Once the evaluation is complete, we will notify you when the samples are available.

We plan to hold the tutorial for Fat-Soluble Vitamin and Carotenoid Analysis on October 18, 1999 at NIST. This tutorial will be primarily for new laboratories and/or lab personnel, or for those currently experiencing difficulties with analysis. As in the past, this session will include a discussion of calibration, sample preparation, and chromatographic techniques for measuring fat-

soluble vitamins and carotenoids in serum. In addition, we will also hold a session for ascorbic acid analysis if there is sufficient interest. There will be no fee for these sessions. We will provide you with more details as we finalize the plans.

Enclosed you will also find reprints on the preparation and value assignment of Standard Reference Material 2383 (Baby Food Composite) and on the use of interlaboratory comparison exercise results.

The next set of samples for the fat-soluble vitamins in serum analysis will be distributed during the week of June 21, 1999. Results will be due September 10; written feedback will be provided during the first week in October.

If you have any questions regarding this report, please contact me at 301/975-3120; FAX: 301/977-0685; e-mail: jeanice.brownthomas@nist.gov.

Sincerely,

A handwritten signature in cursive script that reads "Jeanice Brown Thomas". The signature is written in black ink and is positioned to the right of the word "Sincerely,".

Jeanice Brown Thomas
Research Chemist
Analytical Chemistry Division
Chemical Science and Technology Laboratory

cc: S. A. Wise
L. C. Sander

Enclosures

The NIST M²QAP Round Robin XLV (RR45) report includes the usual

Page	“All Lab” Report
1-4	A listing of all results and statistics for analytes reported by at least two laboratories
5	A list of results for the analytes reported by only one laboratory and a legend for the above two lists
6	The “Measurement Comparability Summary” (or “Score Card”)

and a completely redesigned

Page	“Individualized” Report
1	Your values, the number of labs reporting values, and our assigned values.
2+	“Four Plot” summaries of your current and past measurement performance, one page for each analyte you report that is also reported by at least 10 other participants.

The design and interpretation of the “Four Plot” graphical tools is discussed in detail in: Duewer DL, Kline MC, Sharpless KE, Brown Thomas J, Gary KT. Micronutrients Measurement Quality Assurance Program: Helping Participants Use Interlaboratory Comparison Exercise Results to Improve Their Long-term Measurement Performance. *Anal Chem* 1999; 71:1074-9.

Samples. Four “old” sera were distributed in RR45. The sera were selected from our -80 °C archives to: 1) monitor interference-artifacts from low-level plasticizer components, 2) evaluate analyte stability in our lyophilized sera, and 3) evaluate interlaboratory performance at low and high analyte levels.

Serum #251 is a manipulated serum, augmented with many analytes. We now know it has low levels of plasticizer components from the blood bank’s original storage bag. This serum was originally distributed as #242 (RR42,4/98).

Serum #252 is a native serum, originally prepared as the low-analyte level “Control D” back in 1987. In addition to its use as a control material, this serum was distributed as #78 (RR12,4/88) and #163 (RR24,4/92).

Serum #253 is a low-to-medium-analyte level native serum, previously distributed as the blind replicates #182 and #185 (RR28,6/93) and as #216 (RR36,3/96).

Serum #254 is a medium-to-high-analyte level augmented serum, previously distributed as #192 (RR30,3/94). Approximately 30% of the “retinol” in this serum is a mixture of *cis*-retinol isomers.

Qualitative Results.

- 1) Three participants noted the presence of one or more unusual peaks in serum #251 eluting between retinol and their retinyl acetate internal standard (IS). Many more participants reported these peaks when this serum was distributed in RR42. Rather than reflecting chromatographic changes, this lower observation rate is most likely related to #251 being the only contaminated sample in RR45 rather than the all four of RR42.

You may be able to identify whether or not your system is subject to plasticizer interference by examining your relative concordances of serum #251 relative to those of #252-254. If all analytes normalized to (one of) your IS(s) are unusually low, it’s likely that there is an interferent coeluting

with the IS peak. If just one analyte is unusually high in #251, the interferent coelutes with that analyte. If you suspect that you do have an unrecognized problem, double-check your chromatograms for odd asymmetries. Although these specific interferences may not be important to you, your measurement system should routinely recognize and report unusual performance.

- 2) On detailed examination of the RR42 and RR45 retinol data for serum #254, a number of participants (including NISTb) have twice reported the same quite low [retinol]. This suggests a systematic sample-specific discordance. NISTb and one other participant noted small peaks before/in the leading edge of the retinol peak in all four sera, with an exceptionally large shoulder on the retinol in #254.

On reanalysis of the retinol peak in serum #254, we believe more than one-third of the total area is attributable to a mixture of *cis*-retinol isomers. It is probable that the retinol used to spike serum #254 contained little or no *trans*-retinol: that was in late 1993 and the actual spiking material used is depleted. The “true” level of retinol in serum #254 ranges from about 0.65 µg/mL (*trans*-retinol) to 1.1 µg/mL (total retinol). We expect the reported values for non-specific retinol in serum #254 to depend upon separation conditions and/or integration parameters: the “Score Card” evaluation for retinol thus does **not** include serum #254.

While there are numerous literature methods for separating the retinol isomers (see, just for instance: MacCrehan WA, Schonberger E. Reversed-phase high-performance liquid chromatographic separation and electrochemical detection of retinol and its isomers. *J Chromatogr* 1987;417(1):65-78), there is little on their clinical/nutritive activities other than the rat bioassay potencies reported in: Weiser H, Somorjai G. Bioactivity of *cis* and *di-cis* isomers of vitamin A esters. *Int J Vit Nutr Res* 1992;62(3):201-8. There are two AOAC methods for retinol, one explicitly weighting the retinol isomers by the biological activities reported by Weiser and the other adding all isomers with equal weight. We have limited information on the prevalence of *cis*-retinol in “real” samples, but two participants have confirmed that they occasionally do see small peaks or shoulders on the retinol leading edge. The literature suggests *cis*-retinols can be at least 40% of the “total retinol” in high-temperature-processed and/or bio-converted milk products.

The majority of M²QAP participants appear to be observing and reporting “total retinol”; however, it is clear that we need explicitly to make clear what analyte(s) are actually being reported. Starting with RR46, we will provide space for both “total retinol” and “*trans*-retinol” in the reports. We ask that you examine your chromatograms and integration protocol and determine which form you actually measure.

Note: In an attempt to avoid further confusion, we now explicitly state what we believe is “the form” of *all* analytes having geometric isomers. If you disagree with our assignments for your measurements (i.e., you have been measuring “*trans*-β-cryptoxanthin” but we have assigned it as “Total β-cryptoxanthin”), please let us know and we will correct the historical data.

Quantitative Results

- 1) The only noted interference artifacts are discussed above.
- 2) There is no evidence for any analyte that any of the four sera have significantly degraded in storage, either in change of medians or in increased interlaboratory variability. Note that serum #252 has been in storage at -80 °C for more than a decade.
- 3) Due to shipping errors on our part, both Prof. Olmedilla (Clínica Puerta de Hierro, Madrid) and Neal Matthews (Medical Research Council - Resource Centre for Human Nutrition Research, Cambridge) received sets of RR45 sera that had been at or above room temperature for several days. They

graciously agreed to analyze these “aged” sera in tandem with sets shipped and received on dry ice. They observed no significant differences in [retinol], [α -tocopherol], or [γ -tocopherol] in any sera. They did observe significant decreases in [β -carotene] and [retinyl palmitate] in the “aged” sera, particularly in serum #251. Thus there may be a serum-matrix specific “aging” problem with the most hydrophobic analytes. If someone is interested in doing a **designed** accelerated aging study, we will enthusiastically collaborate!

- 4) Figures 1a and 1b present our newly-revised expected relationships between interlaboratory measurement standard deviation (SD) and the interlaboratory median levels. These plots use only data from the 12 most recent M²QAP exercises: RR33 through RR45. For details of the interpretation of these plots, please see: Duewer DL, Brown Thomas J, Kline MC, MacCrehan WA, Schaffer R, Sharpless KE, May WE, Crowell JA. NIST/NCI Micronutrients Measurement Quality Assurance Program: Measurement Repeatabilities And Reproducibilities For Fat-Soluble Vitamin-Related Compounds In Human Sera. *Anal Chem* 1997;69;1406-13.
- 5) Figures 2a through 2c introduce our current investigations into diagnostic tools for improving measurement performance, displaying the median comparability, (absolute value of) concordance (|Con|), and apparent precision (AP) for three analytes in past M²QAP interlaboratory exercises. The x-axis is the approximate exercise completion date; the y-axis is in “expected interlaboratory SD” units as defined in Figures 1a and 1b. (For definitions of these terms, see *Anal Chem* 1999; 71:1074-9.)

Figure 2a displays the performance metrics for total β -carotene for all fat-soluble RRs. (Retinol and α -tocopherol look very similar.) Comparability improved continuously during the first few years of the program, was “best” during the period in which control materials were distributed along with the unknowns, rose slowly after the (free) control materials were discontinued after the (not free) SRM 968 materials became available, and has settled to a nearly constant level since 1993. Note that AP is the limiting component of comparability for this analyte. There is general agreement among laboratories; comparability is limited by among-sample differences: heterogeneity, matrix effects, and/or within-laboratory measurement variability.

Figure 2b displays the same metrics for total lycopene. Note that comparability appears to be slowly improving but is limited by discordance among laboratories. Different laboratories are using disparate calibration materials and/or including different mixes of lycopene isomers (and/or other carotenoids) in their reported values. Individual laboratories may be more consistently reporting the same mix of “lycopene” components in different samples but more uniform analytical techniques and materials must be adopted to improve interlaboratory comparability for this analyte.

Figure 2c displays the metrics for total α -carotene. In contrast to lycopene, comparability does not appear to have much improved over time and appears to be limited by among-sample rather than among-laboratory measurement differences.

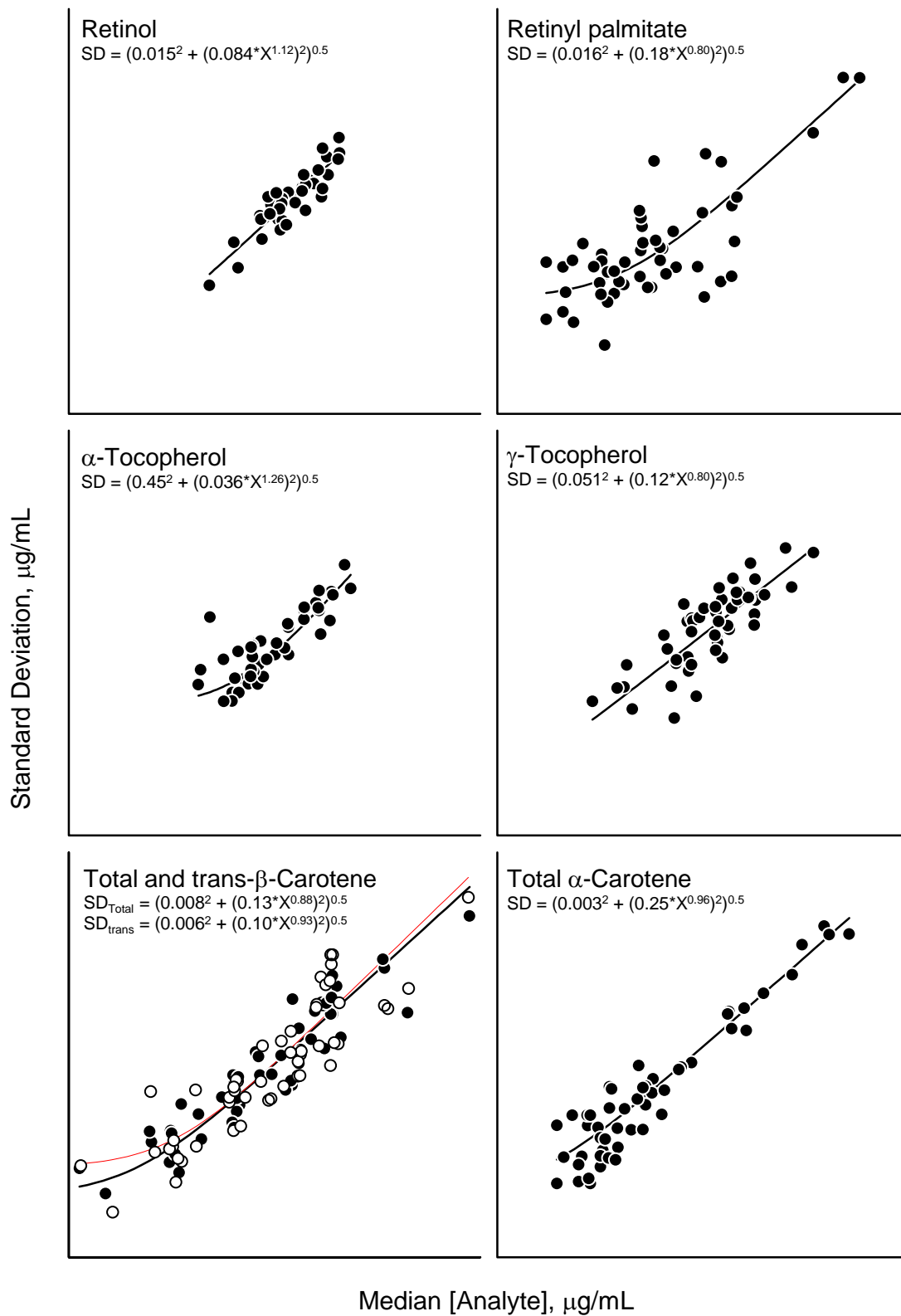

Figure 1a

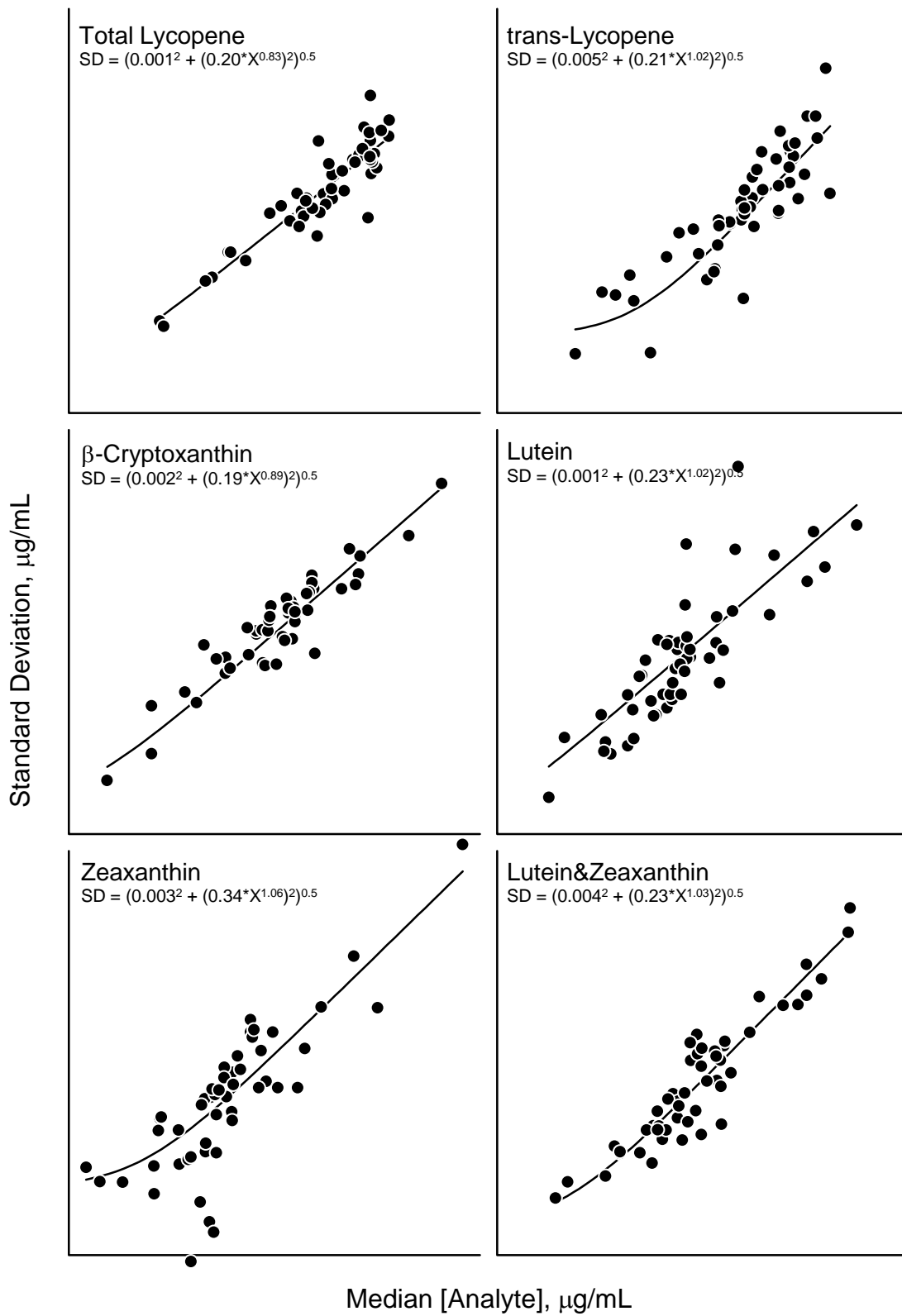
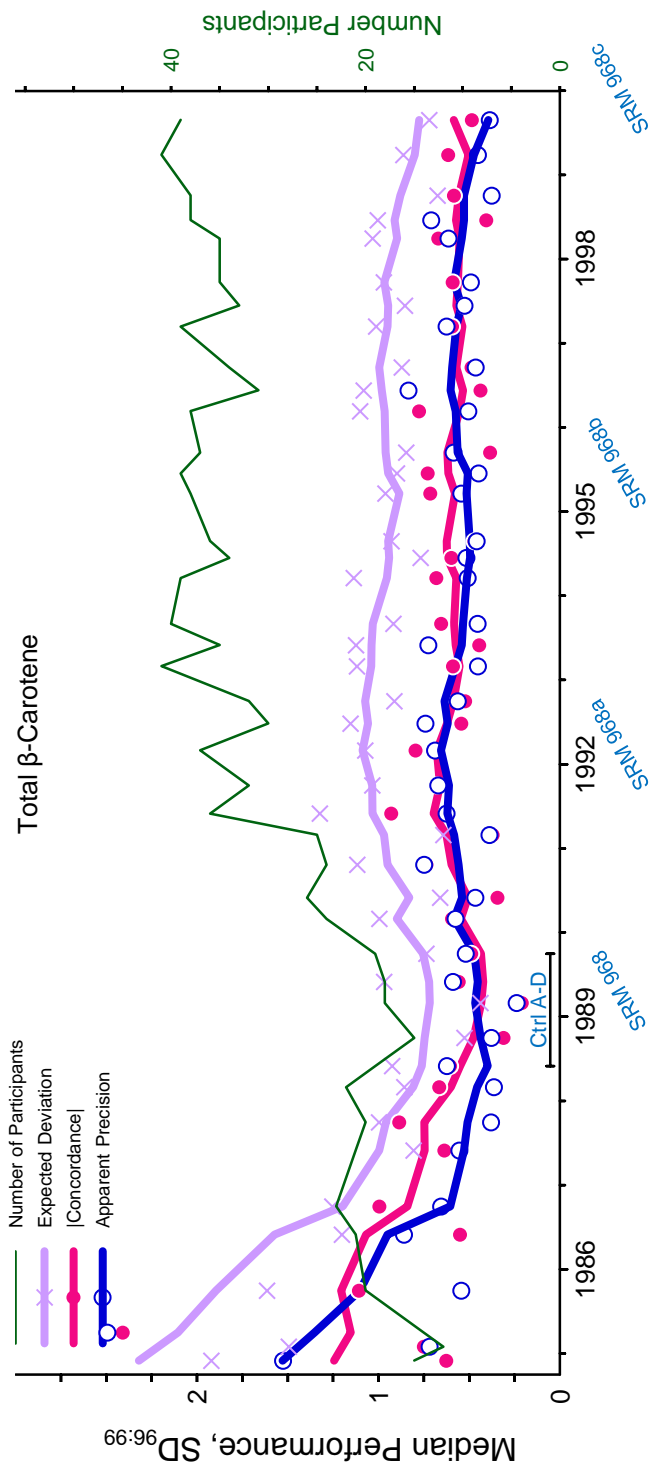
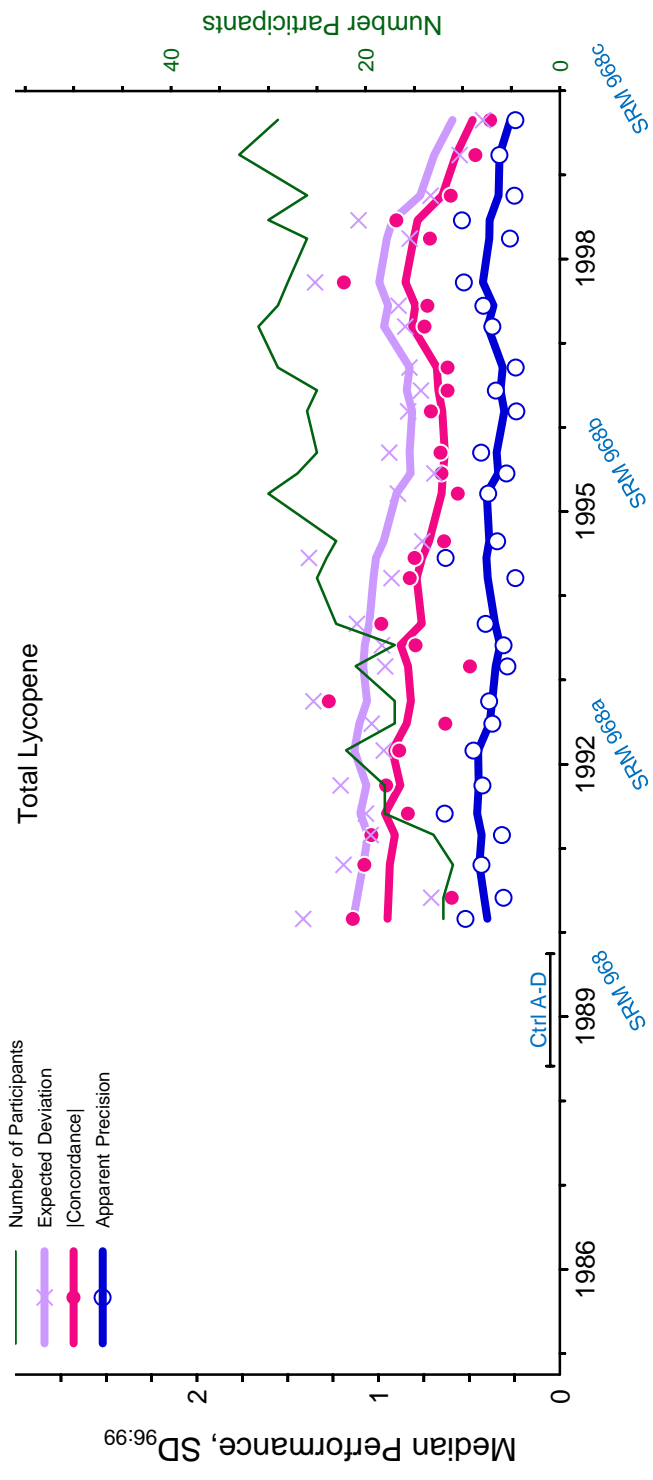

Figure 1b



Date Study Completed

Figure 2a



Date Study Completed

Figure 2b

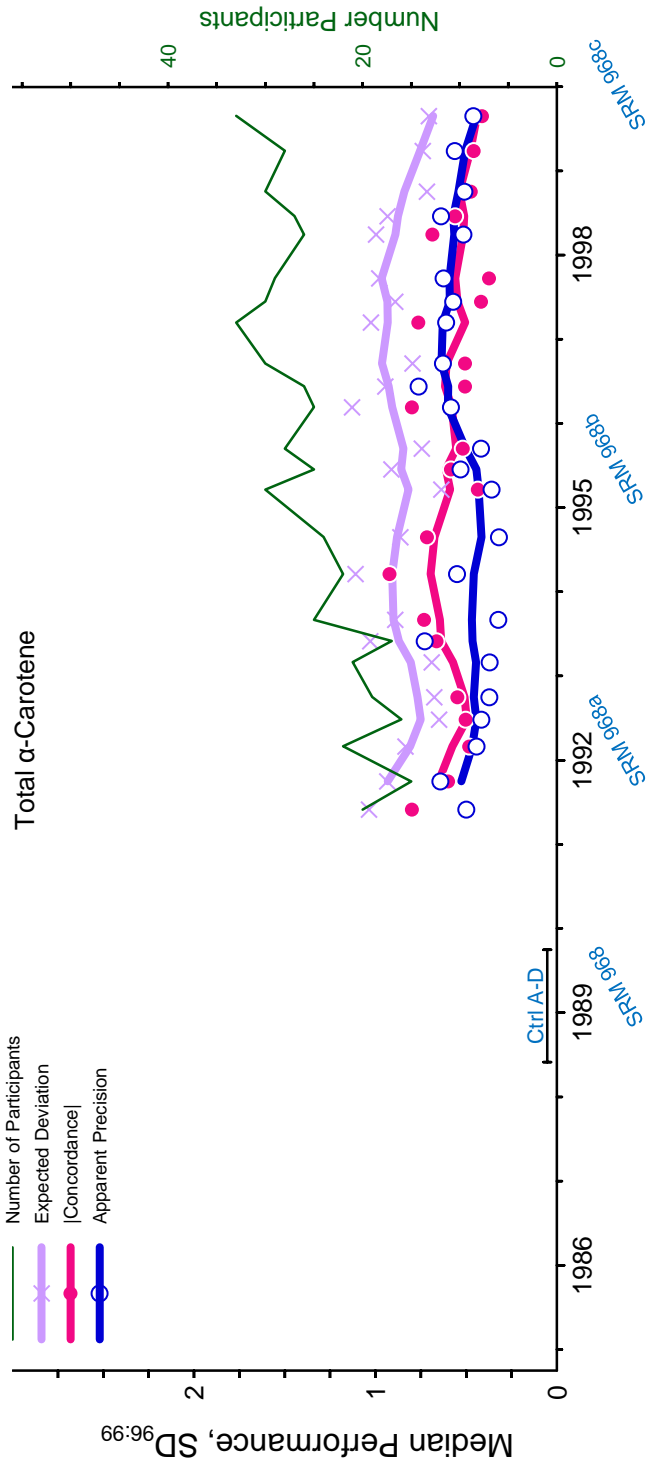

Date Study Completed

Figure 2c

Appendix C. “All-Lab Report” for RR45

The following six pages are the “All-Lab Report” as provided to all participants, with two exceptions:

- the participant identifiers (Lab) have been altered.
- the order in which the participant results are listed has been altered.

The data summary in the “All-Lab Report” has been altered to ensure confidentiality of identification codes assigned to laboratories. The only attributed results are those reported by NIST. The NIST results are not used in the assessment of the consensus summary results of the study.

Round Robin XLV Laboratory Results

All Values in µg/mL

Lab	Retinol				Retinyl Palmitate				α-Tocopherol				γ-Tocopherol				δ-Tocopherol					
	251	252	253	254	251	252	253	254	251	252	253	254	251	252	253	254	251	252	253	254		
FSV-BA	0.952	0.394	0.571	1.210	0.068	0.022	0.065	0.071	19.42	5.48	5.56	25.56	1.78	3.32	2.51	5.86						
FSV-BB	0.975	0.402	0.619	1.171	0.040	0.016	0.048	0.037	20.28	5.22	5.27	25.13	1.63	3.16	2.37	5.69						
FSV-BBa									21.48	5.35	5.46	26.00	1.56	3.09	2.32	5.51						
FSV-BD	0.856	0.360	0.514	1.015					20.30	5.60	5.50	26.10										
FSV-BE	0.909	0.380	0.511	1.028					20.89	5.75	5.43	26.99	1.56	3.63	2.50	6.36						
FSV-BF	0.943	0.394	0.445	1.024	0.06	0.02	0.03	0.04	23.36	5.72	4.85	29.42	1.73	3.26	2.19	6.06						
FSV-BG	0.939	0.390	0.543	1.105	0.08	0.04	0.07	0.08	21.74	5.58	5.64	27.52	1.69	3.50	2.61	6.41						
FSV-BGa	1.027	0.388	0.555	1.150	0.07	0.03	0.06	0.05	21.97	5.72	5.65	28.06	1.55	3.11	2.37	5.30						
FSV-BH	0.872	0.342	0.492	0.870	nq	nq	nq	nq	20.35	5.39	5.32	25.63	1.45	2.82	2.11	5.08						
FSV-BI	0.929	0.405	0.581	1.118	nd	nd	0.05	nd	21.94	6.43	6.04	27.28	1.80	3.41	2.58	6.13						
FSV-BJ	0.901	0.378	0.532	1.091	nq	nq	nq	nq	22.98	6.08	5.68	29.06	1.99	3.77	2.69	6.76						
FSV-BK	0.930	0.385	0.547	1.075					20.30	5.60	5.50	25.70										
FSV-BL	0.920	0.320	0.490	0.630					19.38	4.31	3.88	11.20										
FSV-BM	0.904	0.386	0.549	1.109					21.70	5.40	5.60	27.20										
FSV-BN	0.954	0.389	0.547	1.116	0.03	0.02	0.07	0.02	20.71	5.18	5.33	26.09	1.65	3.08	2.29	5.38	0.699	0.215	0.205	0.638		
FSV-BO	0.832	0.335	0.458	0.716					21.10	5.60	5.73	26.75										
FSV-BP	0.957	0.411	0.590	1.113					19.52	5.21	5.18	25.12										
FSV-BQ	0.990	0.386	0.558	1.156					18.80	5.00	5.00	24.20										
FSV-BR	1.030	0.430	0.630	1.200																		
FSV-BS	1.198	0.452	0.617	0.831																		
FSV-BT	0.723	0.364	0.497	0.975	0.03	0.01	0.04	0.02	17.58	4.69	4.56	23.13	1.54	2.93	2.15	5.73	1.297	0.492	0.465	0.818		
FSV-BU	0.960	0.405	0.574	1.164					22.04	6.26	5.94	29.19	2.65	4.34	3.59	7.06						
FSV-BV	1.020	0.440	0.620	1.160					20.45	5.94	5.41	25.15	1.59	3.29	2.46	5.63						
FSV-BW	0.958	0.384	0.533	1.042	0.03	nd	0.06	0.03	19.76	5.17	5.21	26.45	1.54	3.15	2.34	5.80						
FSV-BX	0.924	0.402	0.579	1.017					21.47	6.05	6.06	28.27	1.70	3.55	2.69	6.23						
FSV-BZ									19.50	5.00	6.10	26.50	2.60	2.80	3.20	5.00						
FSV-CB	1.028	0.409	0.590	1.101					21.01	5.58	5.55	26.81										
FSV-CC	0.913	0.373	0.566	0.857					21.83	5.62	5.57	26.30										
FSV-CD	0.833	0.312	0.437	0.906	0.10	0.01	0.06	0.10	20.10	5.29	5.21	26.13	1.43	3.08	2.23	5.70						
FSV-CE	0.864	0.346	0.496	0.977					19.99	5.29	5.36	26.04										
FSV-CF	0.984	0.403	0.582	1.130					22.40	6.00	6.00	28.40										
FSV-CG	1.175	0.445	0.631	1.152					20.76	5.51	5.75	26.10	2.01	3.51	2.80	6.23	1.576	0.530	0.448	0.870		
FSV-CH	0.724	0.315	0.501	0.875					19.86	5.60	6.31	24.91	1.40	2.78	2.33	4.87						
FSV-CI	1.030	0.380	0.560	0.770	0.05	0.03	0.04	0.06	18.90	4.90	4.60	26.80	1.40	3.00	2.20	5.80						
FSV-CL	0.611	0.289	0.424	0.951					22.71	5.82	6.38	32.58	0.94	2.83	2.29	6.19						
FSV-CP									18.95	5.14	4.71	23.72	1.82	2.92	2.07	5.40						
FSV-CR	1.020	0.410	0.570	1.080					19.80	5.90	5.40	26.00					0.700	<0.3	<0.3	<0.3		
FSV-CS	0.922	0.385	0.550	1.125					21.60	5.21	5.02	27.52	1.60	3.20	2.29	6.18						
FSV-CU	0.868	0.369	0.523	1.087	0.05	0.05	0.07	0.08	16.91	5.12	5.71	25.19										
FSV-CV	0.951	0.399	0.573	1.104	0.03	0.01	0.04	0.01	17.21	6.12	5.99	20.70	1.71	3.54	2.59	12.36						
FSV-CX	0.870	0.300	0.390	0.440					20.42	5.56	5.51	26.33										
FSV-DB	0.899	0.371	0.526	1.050					18.27	4.79	4.73	24.32										
FSV-DF	0.806	0.294	0.519	1.029																		
FSV-DH	0.930	0.400	0.570	1.110					21.55	5.95	5.92	29.27	1.76	3.50	2.50	6.31						
FSV-DK	0.970	0.400	0.550	1.100	0.12	0.42	0.37	0.16	18.90	5.34	5.12	25.13	2.62	4.14	3.38	6.61						
FSV-DP	0.834	0.356	0.505	0.974																		
FSV-DR	1.020	0.415	0.630	1.140					24.17	5.99	6.28	29.81										
FSV-DU	1.150	0.380	0.490	0.990					25.05	5.40	5.10	28.31										
FSV-EH	0.918	0.399	0.542	1.019	0.04	0.03	0.07	0.03	22.87	4.98	4.82	30.46	1.57	3.27	2.29	6.49	0.641	0.213	0.165	0.424		
FSV-EM	0.950	0.430	0.610	1.060					16.40	5.33	4.44	21.76										
FSV-EQ	0.899	0.414	0.571	0.991					22.70	6.46	6.35	27.34										
FSV-ES	0.994	0.424	0.596	1.210					21.00	6.16	6.01	29.00										
N	49	49	49	49	14	13	15	14	48	48	48	48	28	28	28	28	5	4	4	4		
Min	0.611	0.289	0.390	0.440	0.027	0.008	0.033	0.010	16.40	4.31	3.88	11.20	0.94	2.78	2.07	4.87	0.641	0.213	0.165	0.424		
Median	0.930	0.388	0.550	1.075	0.052	0.022	0.059	0.043	20.58	5.54	5.50	26.31	1.64	3.23	2.37	5.96	0.700	0.353	0.326	0.728		
Max	1.198	0.452	0.631	1.210	0.122	0.418	0.374	0.161	25.05	6.46	6.38	32.58	2.65	4.34	3.59	12.36	1.576	0.530	0.465	0.870		
eSD	0.063	0.027	0.050	0.105	0.028	0.010	0.015	0.037	1.67	0.46	0.47	1.84	0.17	0.33	0.23	0.54	0.444					
eCV	7	7	9	10	54	47	25	86	8	8	8	7	11	10	10	9	63					
N _{past}	47	38	46	44	9	0	10	6	46	35	45	44	21	16	18	20	0	0	5	0		
Median _{past}	0.914	0.394	0.544	1.027	0.067		0.069	0.048	20.78	5.55	5.47	27.13	1.67	3.26	2.49	6.38			0.183			
SD _{past}	0.081	0.040	0.050	0.107	0.019		0.016	0.055	1.62	0.69	0.40	2.55	0.25	0.29	0.24	0.64			0.076			
NISTa	0.935	0.377	0.585	0.977					20.24	5.07	5.15	26.44	1.53	3.25	2.34	5.42	0.438	nq	nq	0.249		
NISTb	0.845	0.353	0.501	0.879					21.43	5.50	5.24	27.18	1.70	3.40	2.46	6.25	0.685	0.192	0.121	0.406		
N _{NIST}	4	4	4	4					4	4	4	4	4	4	4	4	4	2	2	4		
Mean	0.890	0.365	0.543	0.928					20.84	5.28	5.20	26.81	1.61	3.32	2.40	5.84	0.562	0.192	0.121	0.328		
S _{rep}	0.010	0.029	0.014	0.060					0.79	0.22	0.06	0.73	0.02	0.07	0.04	0.12	0.020	0.001	0.008	0.031		
S _{het}	0.015	0.009	0.006	0.011					0.05	0.04	0.05	0.51	0.03	0.04	0.02	0.06	0.023	0.004	0.007	0.022		
S _{ant}	0.064	0.017	0.060	0.069					0.84	0.31	0.06	0.52	0.12	0.10	0.08	0.59	0.175			0.111		
S _{NIST}	0.066	0.035	0.062	0.093					1.16	0.38	0.10	1.03	0.13	0.13	0.09	0.60	0.177	0.004	0.011	0.117		
NAV	0.910	0.377	0.546	1.004	0.052	0.022	0.059	0.043	20.71	5.43	5.35	26.56	1.63	3.28	2.38	5.90	0.631					
NAU	0.084	0.039	0.062	0.150	0.028	0.010	0.015	0.037	1.68	0.58	0.59	2.27	0.19	0.36	0.25	0.61	0.455					

Round Robin XLV Laboratory Results

All Values in µg/mL

Lab	Total β-Carotene				trans-β-Carotene				Total cis-β-Carotene				Total α-Carotene			
	251	252	253	254	251	252	253	254	251	252	253	254	251	252	253	254
FSV-BA	0.628	0.193	0.411	0.396	0.602	0.181	0.393	0.374	0.026	0.012	0.018	0.022	0.076	0.007	0.014	0.012
FSV-BB	0.681	0.188	0.415	0.391	0.655	0.179	0.403	0.348	0.026	0.009	0.012	0.058	0.076	0.008	0.012	0.010
FSV-BBa	0.595	0.167	0.366	0.316	0.572	0.159	0.355	0.297	0.023	0.008	0.011	0.025				
FSV-BD	0.73	0.19	0.37	0.30												
FSV-BE	0.696	0.195	0.419	0.439												
FSV-BF																
FSV-BG	0.720	0.201	0.417	0.359									0.096	0.016	0.016	0.026
FSV-BGa	0.726	0.219	0.457	0.426									0.080	0.019	0.015	0.050
FSV-BH	0.425	0.181	0.397	0.377	0.405	0.171	0.382	0.344	0.020	0.010	0.015	0.033	0.120	0.009	0.014	0.014
FSV-BI	0.698	0.184	0.396	0.356									0.094	0.008	0.012	0.010
FSV-BJ	0.540	0.184	0.407	0.370									0.091	<i>nq</i>	<i>nq</i>	<i>nq</i>
FSV-BK																
FSV-BL																
FSV-BM																
FSV-BN	0.752	0.187	0.360	0.358	0.696	0.163	0.351	0.312	0.057	0.032	0.042	0.052	0.109	0.012	0.016	0.014
FSV-BO	0.523	0.158	0.349	0.344									0.131	0.009	0.015	0.013
FSV-BP	0.563	0.197	0.419	0.440									0.025	0.024	0.020	0.104
FSV-BQ																
FSV-BR																
FSV-BS	0.643	0.146	0.370	0.327												
FSV-BT	0.604	0.151	0.312	0.297	0.581	0.143	0.299	0.269	0.022	0.008	0.013	0.027				
FSV-BU	0.711	0.200	0.430	0.389									0.111	0.014	0.017	0.016
FSV-BV	0.790	0.190	0.420	0.380									0.120	0.008	0.012	0.009
FSV-BW	0.559	0.160	0.352	0.357									0.097	0.008	0.011	0.010
FSV-BX	0.726	0.209	0.405	0.382	0.671	0.181	0.380	0.315	0.055	0.027	0.025	0.067	0.102	0.017	0.018	0.021
FSV-BZ	0.590	0.387	0.533	0.543	0.560	0.370	0.520	0.510	0.030	0.017	0.013	0.033	0.067	0.034	0.036	0.037
FSV-CB	0.661	0.182	0.388	0.376									0.073	0.008	0.012	0.012
FSV-CC																
FSV-CD	0.506	0.119	0.264	0.241									0.149	0.013	0.021	0.016
FSV-CE	0.658	0.177	0.379	0.335												
FSV-CF																
FSV-CG	0.701	0.194	0.432	0.408	0.669	0.180	0.413	0.374	0.032	0.014	0.019	0.034	0.128	0.011	0.015	0.016
FSV-CH	0.460	0.119	0.249	0.246									0.077	0.105	0.011	0.010
FSV-CI																
FSV-CL	0.561	0.150	0.326	0.346									0.108	0.006	0.010	0.009
FSV-CP	0.549	0.173	0.377	0.341									0.084	<i>nd</i>	0.009	0.010
FSV-CR																
FSV-CS	0.561	0.171	0.429	0.371	0.520	0.159	0.397	0.332	0.041	0.012	0.032	0.039	0.128	0.009	0.016	0.012
FSV-CU																
FSV-CV	0.588	0.169	0.464	0.366												
FSV-CX					0.300	0.130	0.360	0.290								
FSV-DB	0.588	0.159	0.397	0.346												
FSV-DF																
FSV-DH	0.702	0.231	0.565	0.435	0.663	0.213	0.533	0.374	0.039	0.018	0.032	0.061	0.083	0.100	0.015	0.012
FSV-DK	0.310	0.149	0.332	0.287									0.083	0.010	0.011	0.006
FSV-DP																
FSV-DR	1.060	0.270	0.470	0.370												
FSV-DU					0.380	0.090	0.260	0.200								
FSV-EH	0.698	0.213	0.405	0.376	0.668	0.201	0.387	0.350	0.030	0.012	0.018	0.026	0.142	0.001	0.010	0.008
FSV-EM	0.410	0.144	0.343	0.286									0.075	0.008	0.011	0.090
FSV-EQ	0.775	0.189	0.411	0.365									0.119	0.011	0.014	0.012
FSV-ES					0.471	0.138	0.317	0.261								
N	36	36	36	36	15	15	15	15	12	12	12	12	27	25	26	26
Min	0.310	0.119	0.249	0.241	0.300	0.090	0.260	0.200	0.020	0.008	0.011	0.022	0.025	0.001	0.009	0.006
Median	0.636	0.184	0.401	0.366	0.581	0.171	0.382	0.332	0.030	0.012	0.018	0.034	0.096	0.010	0.014	0.012
Max	1.060	0.387	0.565	0.543	0.696	0.370	0.533	0.510	0.057	0.032	0.042	0.067	0.149	0.105	0.036	0.104
eSD	0.107	0.026	0.041	0.033	0.126	0.022	0.035	0.051	0.011	0.005	0.010	0.020	0.030	0.006	0.004	0.004
eCV	17	14	10	9	22	13	9	15	35	46	56	58	32	59	25	37
N _{past}	30	27	33	35	9	7	8	10	6	12	7	8	25	16	17	20
Median _{past}	0.626	0.194	0.417	0.375	0.572	0.191	0.393	0.323	0.025	0.012	0.018	0.048	0.086	0.010	0.016	0.015
SD _{past}	0.083	0.022	0.071	0.063	0.126	0.049	0.026	0.047	0.008	0.006	0.010	0.039	0.029	0.003	0.005	0.005
NISTa	>0.593	>0.159	>0.371	>0.326	0.593	0.159	0.371	0.326	<i>nq</i>	<i>nq</i>	<i>nq</i>	<i>nq</i>	0.105	<i>nq</i>	<i>nq</i>	<i>nq</i>
NISTb	>0.572	>0.171	>0.356	0.376	0.572	0.171	0.356	0.320	<i>nq</i>	<i>nq</i>	<i>nq</i>	0.055	>0.106	>0.009	>0.011	<i>nq</i>
N _{NIST}				2	4	4	4	4					2			1
Mean	0.583	0.165	0.364	0.351	0.583	0.165	0.364	0.323				0.055	0.105	0.009	0.011	0.028
S _{rep}				0.008	0.025	0.005	0.010	0.014				0.017	0.009			0.000
S _{het}				0.022	0.012	0.008	0.007	0.006				0.017	0.005			0.000
S _{anal}					0.015	0.009	0.011	0.004								
S _{NIST}				0.024	0.031	0.013	0.017	0.016				0.024	0.011			0.000
NAV	0.613	0.175	0.384	0.358	0.587	0.170	0.374	0.330	0.030	0.012	0.018	0.045	0.100	0.009	0.013	0.020
NAU	0.113	0.033	0.066	0.055	0.102	0.022	0.044	0.051	0.011	0.005	0.010	0.029	0.032	0.006	0.006	0.012

Round Robin XLV Laboratory Results

All Values in µg/mL

Lab	trans- α -Carotene				Total Lycopene				trans-Lycopene				Total β -Cryptoxanthin			
	251	252	253	254	251	252	253	254	251	252	253	254	251	252	253	254
FSV-BA									0.291	0.086	0.139	0.276	0.172	0.033	0.044	0.052
FSV-BB					0.504	0.163	0.230	0.479	0.243	0.080	0.146	0.253	0.194	0.034	0.046	0.052
FSV-BBa					0.535	0.163	0.230	0.525	0.284	0.093	0.170	0.296	0.142	0.025	0.038	0.040
FSV-BD					0.351	0.129	0.158	0.405					0.097	0.013	0.025	0.025
FSV-BE																
FSV-BF																
FSV-BG					0.445	0.210	0.298	0.658	0.260	0.101	0.175	0.337	0.162	0.020	0.031	0.037
FSV-BGa					0.467	0.219	0.228	0.620								
FSV-BH					0.468	0.153	0.222	0.495					0.179	0.032	0.045	0.061
FSV-BI					0.450	0.151	0.193	0.439					0.156	0.028	0.044	0.042
FSV-BJ					0.399	0.146	0.198	0.494					0.167	0.025	0.043	0.044
FSV-BK																
FSV-BL																
FSV-BM																
FSV-BN					0.494	0.163	0.209	0.468	0.230	0.081	0.126	0.235	0.160	0.020	0.035	0.034
FSV-BO					0.524	0.167	0.241	0.564					0.153	0.023	0.034	0.044
FSV-BP					0.294	0.137	0.196	0.368					0.073	0.023	0.032	0.042
FSV-BQ																
FSV-BR																
FSV-BS					0.444	0.138	0.199	0.526	0.188	0.064	0.113	0.189	0.114	0.031	0.041	0.040
FSV-BT	0.080	0.008	0.012	0.013	0.304	0.125	0.165	0.381	0.254	0.103	0.134	0.306	0.159	0.027	0.040	0.045
FSV-BU					0.438	0.126	0.194	0.572					0.191	0.020	0.044	0.079
FSV-BV					0.450	0.150	0.220	0.480					0.127	0.015	0.028	0.025
FSV-BW					0.414	0.136	0.193	0.485								
FSV-BX					0.464	0.186	0.258	0.508	0.242	0.081	0.145	0.242	0.122	0.025	0.034	0.033
FSV-BZ					0.450	0.280	0.330	0.510								
FSV-CB					0.478	0.171	0.232	0.539					0.135	0.034	0.043	0.044
FSV-CC																
FSV-CD					0.423	0.122	0.187	0.350					>0.128	>0.024	>0.039	>0.038
FSV-CE																
FSV-CF																
FSV-CG					0.547	0.169	0.236	0.538	0.248	0.079	0.136	0.262	0.205	0.038	0.054	0.070
FSV-CH					0.636	0.195	0.311	0.617								
FSV-CI																
FSV-CL					0.467	0.140	0.229	0.581					0.121	0.026	0.053	0.071
FSV-CP					0.209	0.081	0.123	0.252					0.143	0.030	0.042	0.047
FSV-CR																
FSV-CS					0.478	0.156	0.229	0.489					0.131	0.022	0.033	0.038
FSV-CU																
FSV-CV					0.477	0.198	0.319	0.743								
FSV-CX	0.060	0.010	0.010	0.020					0.200	0.060	0.130	0.210	0.130	0.020	0.040	0.030
FSV-DB					0.525	0.190	0.253	0.515					0.148	0.027	0.040	0.041
FSV-DF																
FSV-DH					0.692	0.260	0.429	0.800	0.530	0.197	0.330	0.558				
FSV-DK																
FSV-DP																
FSV-DR																
FSV-DU																
FSV-EH					0.726	0.228	0.309	0.786	0.332	0.081	0.166	0.366	0.110	0.016	0.026	0.029
FSV-EM					0.340	0.109	0.167	0.349					0.136	0.018	0.031	0.033
FSV-EQ					0.503	0.168	0.231	0.512					0.190	0.024	0.041	0.038
FSV-ES	0.102	<i>nq</i>	0.016	0.014	0.251	0.098	0.143	0.302	0.170	0.050	0.100	0.181	0.135	0.024	0.039	0.040
N	3	2	3	3	32	32	32	32	13	13	13	13	27	27	27	27
Min	0.060	0.008	0.010	0.013	0.209	0.081	0.123	0.252	0.170	0.050	0.100	0.181	0.073	0.013	0.025	0.025
Median	0.080	0.009	0.012	0.014	0.466	0.160	0.229	0.509	0.248	0.081	0.139	0.262	0.143	0.025	0.040	0.041
Max	0.102	0.010	0.016	0.020	0.726	0.280	0.429	0.800	0.530	0.197	0.330	0.558	0.205	0.038	0.054	0.079
eSD					0.061	0.037	0.037	0.078	0.040	0.010	0.027	0.053	0.027	0.006	0.007	0.008
eCV					13	23	16	15	16	13	19	20	19	26	18	18
N _{past}	0	0	0	0	26	20	19	24	9	0	8	0	25	14	14	18
Median _{past}					0.427	0.135	0.212	0.490	0.286		0.157		0.142	0.035	0.043	0.053
SD _{past}					0.102	0.042	0.052	0.139	0.072		0.009		0.032	0.013	0.012	0.012
NISTa													0.150	0.018	0.037	0.033
NISTb	0.106	0.009	0.011	<i>nq</i>	0.615	0.181	0.261	0.626	0.241	0.080	0.139	0.262	0.126	0.024	0.033	0.038
N _{NIST}	2	1	2	1	2	1	2	2	2	2	2	2	4	4	4	4
Mean	0.106	0.009	0.011	0.018	0.461	0.181	0.261	0.626	0.241	0.080	0.139	0.262	0.138	0.021	0.035	0.036
S _{rep}	0.005	0.001	0.004	0.000	0.294	0.017	0.035	0.016	0.003	0.002	0.003	0.012	0.003	0.002	0.002	0.003
S _{het}	0.001	0.000	0.001	0.000	0.238	0.000	0.014	0.037	0.009	0.003	0.003	0.003	0.003	0.002	0.001	0.003
S _{ant}													0.017	0.004	0.003	0.003
S _{NIST}	0.005	0.001	0.004	0.000	0.378	0.017	0.038	0.040	0.010	0.004	0.004	0.013	0.018	0.005	0.004	0.005
NAV					0.464	0.172	0.245	0.567	0.245	0.081	0.139	0.262	0.140	0.023	0.037	0.038
NAU					0.378	0.045	0.061	0.139	0.051	0.017	0.029	0.054	0.033	0.008	0.011	0.011

Round Robin XLV Laboratory Results

All Values in µg/mL

Lab	Total α-Cryptoxanthin				Total Lutein				Total Zeaxanthin				Total Lutein&Zeaxanthin			
	251	252	253	254	251	252	253	254	251	252	253	254	251	252	253	254
FSV-BA													0.679	0.079	0.087	0.136
FSV-BB	0.034	0.019	0.018	0.020	0.578	0.060	0.057	0.089	0.068	0.021	0.029	0.032	0.646	0.081	0.086	0.121
FSV-BBa	0.026	0.016	0.015	0.016	0.516	0.056	0.052	0.088	0.065	0.020	0.025	0.030	0.581	0.076	0.077	0.118
FSV-BD					0.492	0.045	0.047	0.097	0.063	0.017	0.021	0.021	0.555	0.062	0.068	0.118
FSV-BE																
FSV-BF																
FSV-BG					0.445	0.044	0.040	0.075	0.098	0.010	0.010	0.020	0.548	0.064	0.055	0.109
FSV-BGa																
FSV-BH					0.387	0.036	0.035	0.048	0.052	0.017	0.027	0.025	0.439	0.053	0.062	0.073
FSV-BI					0.479	0.049	0.046	0.057	0.056	0.019	0.026	0.022	0.535	0.068	0.072	0.079
FSV-BJ													0.348	0.049	0.045	0.063
FSV-BK																
FSV-BL																
FSV-BM																
FSV-BN	0.023	0.012	0.009	0.010	0.358	0.036	0.029	0.059	0.054	0.012	0.019	0.023	0.390	0.047	0.045	0.067
FSV-BO					0.660	0.056	0.052	0.072	0.068	0.018	0.026	0.029	0.728	0.074	0.078	0.101
FSV-BP																
FSV-BQ																
FSV-BR																
FSV-BS					0.392	0.044	0.040	0.066	0.048	<i>nq</i>	0.029	0.030				
FSV-BT	0.029	0.020	0.016	0.024	0.333	0.049	0.057	0.062	0.029	0.018	0.024	0.024	0.362	0.066	0.081	0.085
FSV-BU													0.364	0.079	0.106	0.134
FSV-BV													0.470	0.069	0.079	0.090
FSV-BW																
FSV-BX					0.298	0.034	0.039	0.047	0.068	0.019	0.022	0.026	0.366	0.053	0.061	0.073
FSV-BZ					0.260	0.063	0.058	0.086								
FSV-CB						0.041	0.040	0.053		0.018	0.026	0.026	0.536	0.059	0.066	0.079
FSV-CC																
FSV-CD	0.050	0.025	0.023	0.029									0.452	0.066	0.094	0.127
FSV-CE																
FSV-CF													0.489	0.075	0.091	0.104
FSV-CG																
FSV-CH																
FSV-CI																
FSV-CL	0.051	0.018	0.016	0.040									0.296	0.051	0.058	0.075
FSV-CP													0.460	0.068	0.074	0.087
FSV-CR																
FSV-CS													0.428	0.063	0.076	0.081
FSV-CU																
FSV-CV					0.467	0.059	0.058	0.075								
FSV-CX					0.350	0.030	0.030	0.040	0.050	0.010	0.020	0.020	0.400	0.040	0.050	0.060
FSV-DB													0.345	0.057	0.064	0.078
FSV-DF																
FSV-DH					0.442	0.039	0.039	0.052	0.047	0.013	0.019	0.019	0.489	0.052	0.058	0.071
FSV-DK																
FSV-DP																
FSV-DR																
FSV-DU																
FSV-EH					0.418	0.050	0.046	0.061	0.057	0.019	0.026	0.025	0.475	0.069	0.072	0.086
FSV-EM													0.350	0.045	0.052	0.078
FSV-EQ													0.291	0.050	0.059	0.026
FSV-ES					0.432	0.042	0.034	0.052	0.050	0.017	0.021	0.023	0.482	0.059	0.055	0.075
N	6	6	6	6	17	18	18	18	15	15	16	16	27	27	27	27
Min	0.023	0.012	0.009	0.010	0.260	0.030	0.029	0.040	0.029	0.010	0.010	0.019	0.291	0.040	0.045	0.026
Median	0.032	0.019	0.016	0.022	0.432	0.045	0.043	0.061	0.056	0.018	0.024	0.024	0.460	0.063	0.068	0.081
Max	0.051	0.025	0.023	0.040	0.660	0.063	0.058	0.097	0.098	0.021	0.029	0.032	0.728	0.081	0.106	0.136
eSD	0.014	0.002	0.002	0.008	0.090	0.011	0.010	0.017	0.012	0.003	0.004	0.004	0.127	0.012	0.015	0.024
eCV	46	12	11	36	21	25	22	27	22	17	16	16	28	19	22	30
N _{past}	0	0	0	0	11	10	9	14	9	5	15	6	23	6	11	10
Median _{past}					0.397	0.049	0.040	0.073	0.051	0.015	0.026	0.030	0.472	0.066	0.079	0.099
SD _{past}					0.041	0.040	0.012	0.045	0.017	0.007	0.002	0.011	0.077	0.006	0.011	0.016
NISTa					0.518	0.052	0.062	0.068	0.020	<i>nq</i>	<i>nq</i>	0.019	0.538	>0.052	>0.062	0.081
NISTb					0.439	0.054	0.045	0.075	0.070	0.027	0.030	0.047	0.509	0.081	0.075	0.122
N _{NIST}					4	4	4	4	4	2	2	4	4	2	2	4
Mean					0.479	0.053	0.054	0.071	0.045	0.027	0.030	0.033	0.523	0.066	0.069	0.102
S _{rep}					0.014	0.001	0.002	0.003	0.005	0.002	0.002	0.001	0.015	0.002	0.004	0.008
S _{net}					0.003	0.001	0.000	0.002	0.000	0.001	0.001	0.001	0.003	0.001	0.000	0.006
S _{anal}					0.056	0.001	0.012	0.005	0.035		0.020		0.021			0.029
S _{NIST}					0.058	0.002	0.012	0.006	0.035	0.002	0.002	0.020	0.026	0.002	0.004	0.031
NAV					0.455	0.049	0.049	0.066	0.050	0.022	0.027	0.029	0.498	0.065	0.068	0.091
NAU					0.104	0.013	0.014	0.018	0.036	0.009	0.008	0.021	0.120	0.014	0.015	0.034

Round Robin XLV Laboratory Results

All Results in µg/mL

Analytes Reported By One Laboratory

Analyte	Code	251	252	253	254
9-cis-β-Carotene	FSV-DH	0.016	0.005	0.010	0.022
13-cis-β-Carotene	FSV-DH	0.023	0.013	0.022	0.039
9-cis-Lycopene	FSV-DH	0.070	0.029	0.038	0.105
13-cis-Lycopene	FSV-DH	0.088	0.031	0.056	0.128
15-cis-Lycopene	FSV-DH	0.004	0.003	0.005	0.009
3-cis-β-Cryptoxanthin	FSV-CD	0.128	0.024	0.039	0.038
Total cis-β-Cryptoxanthin	FSV-BT	0.022	0.007	0.009	0.021
Total Cryptoxanthin	FSV-DH	0.264	0.062	0.090	0.096
Total anhydro-Lutein	FSV-BT	0.051	0.024	0.016	0.036
Coenzyme Q10	FSV-CH	0.367	0.716	0.499	0.511

Legend

Term	Definition
N	Number of (non-NIST) quantitative values reported for this analyte
Min	Minimum (non-NIST) quantitative value reported
Median	Median (non-NIST) quantitative value reported
Max	Maximum (non-NIST) quantitative value reported
eSD	Standard deviation for (non-NIST) results: $0.741 \times (\text{3rd Quartile} - \text{1st Quartile})$
eCV	Coefficient of Variation for (non-NIST) results: $100 \times \text{SD} / \text{Median}$
N_{past}	Mean of N(s) from past RR(s)
$\text{Median}_{\text{past}}$	Mean of Median(s) from past RR(s)
SD_{past}	Pooled SD from past RR(s)
N_{NIST}	Number of vials analyzed in duplicate by NIST analyst(s)
Mean	Mean of the NIST-analyzed vial means
S_{rep}	Within-vial pooled standard deviation
S_{het}	Among-vial pooled standard deviation
S_{anl}	Between NIST analyst standard deviation
S_{NIST}	Total standard deviation for NIST analyses: $(S_{\text{rep}}^2 + S_{\text{het}}^2 + S_{\text{anl}}^2)^{0.5}$
NAV	NIST Assigned Value = (Median + Mean)/2 for analytes reported by NIST analyst(s) = Median for analytes reported by ≥ 10 labs but not NIST
NAU	NIST Assigned Uncertainty: $(S^2 + S_{\text{btw}}^2)^{0.5}$ S is the maximum of (0.05*NAV, SD, S_{NIST} , eSD) and S_{btw} is the standard deviation between Median and Mean. The expected long-term SD, eSD, is defined in: Duewer, et al. Anal Chem 1997;69(7):1406-1413.
nd	Not detected (i.e., no detectable peak for analyte)
nq	Detected but not quantitatively determined
<x	Concentration below the limit of quantification, x
>x	Concentration greater than x
<i>italics</i>	Not explicitly reported but calculated by NIST from reported values

Round Robin XLV Laboratory Results

Comparability Summary

Lab	R	aT	gT	bC	tbC	aC	Ly	bX
FSV-BA	1	2	1	1		1	1	1
FSV-BB	1	1	1	1		2	1	1
FSV-BBa	2	1	1	2		3	2	
FSV-BD	1	1		2			2	2
FSV-BE	1	2	1	3	4	4	3	
FSV-BF	2	2	1					
FSV-BG	1	1	1	2				
FSV-BGa	2	1	1	1	1	1		2
FSV-BH	2	1	1	1	1	1	1	2
FSV-BI		1	1	1	1		1	1
FSV-BJ	1	1	2	2	2	1	1	2
FSV-BK	1	2	2	2	1	2	1	1
FSV-BL		2	4	4	4	4	3	
FSV-BM	2	4						
FSV-BN	1	2	2	1		1	1	1
FSV-BO	1	1						
FSV-BP	1	3	4	2			2	
FSV-BQ	1	3						
FSV-BR		2	2	1		1	3	1
FSV-BS	3	2	2	2		4	2	
FSV-BT	4	3	4	1		1	1	3
FSV-BU	3	1			3			1
FSV-BV	2	1		1		1	1	2
FSV-BW	1	1		2		4	2	2
FSV-BX	1	1	1	2	2	1	1	1
FSV-BZ	4			1			1	2
FSV-CB	2	1		1		1	1	1
FSV-CC	3	2	1	2	2		2	1
FSV-CD	2							
FSV-CE	2	2						
FSV-CF	4	1	2	1	1	1	1	3
FSV-CG	1	1						
FSV-CH	2	1						
FSV-CI	2	1	2	3		2	2	
FSV-CL	1	2	4	3		2		
FSV-CP	1	2		1			1	1
FSV-CR	1	2	4	1		1	2	4
FSV-CS	1							
FSV-CU	2	1	1	2		1	1	2
FSV-CV	1	2	1	2	2	2	2	2
FSV-CX	1	1						
FSV-DB	1	1	1	1		1	1	
FSV-DF	1	2						
FSV-DH	1	1	1	1	1	1	1	1
FSV-DK	3	3			4			
FSV-DP	2	3		4				
FSV-DR	2	3		2		4	2	1
FSV-DU	2	2	2					
FSV-EH	1	1		1				
FSV-EM	2	2			2		2	1
FSV-EQ	3							
FSV-ES	1	2		2		1	1	2
NISTa	1	1	1		1	1		1
NISTb	1	1	1	1	1		1	1
n	49	48	28	36	15	27	32	27

Label	Definition
Lab	laboratory number
R	"Standard Score" for Retinol
aT	"Standard Score" for α -Tocopherol
gT	"Standard Score" for γ -Tocopherol
bC	"Standard Score" for Total β -Carotene
tbC	"Standard Score" for trans- β -Carotene
aC	"Standard Score" for Total α -Carotene
Ly	"Standard Score" for Total Lycopene
bX	"Standard Score" for β -Cryptoxanthin
n	number of laboratories providing data for this analyte

"Standard Score"
Given that our knowledge of the shape, location, and width of the measurement distributions is approximate and that a limited number of labs are involved, we summarize comparability with the following four-level "Standard Score" (StS)...

StS	Definition
1	All StV within $\pm t(1-0.683, n-1)$ { ± 1 SD}
2	All StV within $\pm t(1-0.954, n-1)$ { ± 2 SD}
3	All StV within $\pm t(1-0.997, n-1)$ { ± 3 SD}
4	At least one StV $> \pm t(1-0.997, n-1)$ { > 3 SD}

where:

StV	Standardized Value, the distance in standard deviation units your value is from the "true" concentration: $StV = (your\ value - NAV) / NAU$
NAV	NIST Assigned Value, our estimate of the "true" analyte concentration
NAU	NIST Assigned Uncertainty, our estimate of the total measurement standard deviation (serum heterogeneity, analytical repeatability, and among-laboratory reproducibility)
$t(1-\alpha, n-1)$	Two-tailed Student's t for coverage of ± 1 , ± 2 , and ± 3 NAU about NAV, assuming a normal population of size n

StS	% Observed								Expected
1	51	48	54	47	40	59	56	52	68.2 %
2	33	38	29	39	33	19	34	37	27.3 %
3	10	13	0	8	13	4	9	7	4.3 %
4	6	2	18	6	13	19	0	4	0.3 %

These are the observed and normal-population-expected proportions of each Standard Score (StS), based upon each laboratory's largest StV for the four sera.

Appendix D. Representative “Individualized Report” for RR45

Each participant in RR45 received an “Individualized Report” reflecting their reported results. Each report included a detailed analysis of the results they reported for the following analytes:

- Retinol
- Retinyl Palmitate
- α -Tocopherol
- γ -Tocopherol
- Total β -Carotene
- *trans*- β -Carotene
- Total *cis*- β -Carotene
- Total α -Carotene
- Total Lycopene
- *trans*-Lycopene
- Total β -Cryptoxanthin
- Total Lutein
- Total Zeaxanthin
- Total Lutein & Zeaxanthin

The following 12 pages are the “Individualized Report” for the analytes evaluated by participant FSV-BA.

Individualized Round Robin XLV Report: FSV-BA

Summary

Analyte	Serum 251			Serum 252			Serum 253			Serum 254		
	You	NAV	n	You	NAV	n	You	NAV	n	You	NAV	n
Retinol	0.952	0.910	50	0.394	0.377	50	0.571	0.546	50	1.210	1.004	50
Retinyl Palmitate	0.068	0.052	14	0.022	0.022	13	0.065	0.059	15	0.071	0.043	14
α-Tocopherol	19.42	20.71	48	5.5	5.4	48	5.6	5.4	48	25.56	26.56	48
γ-Tocopherol	1.78	1.63	28	3.32	3.28	28	2.51	2.38	28	5.86	5.90	28
Total β-Carotene	0.628	0.613	36	0.193	0.175	36	0.411	0.384	36	0.396	0.358	36
trans-β-Carotene	0.602	0.587	15	0.181	0.170	15	0.393	0.374	15	0.374	0.330	15
Total cis-β-Carotene	0.026	0.030	12	0.012	0.012	12	0.018	0.018	12	0.022	0.045	12
Total α-Carotene	0.076	0.100	27	0.007	0.009	25	0.014	0.013	26	0.012	0.020	26
trans-Lycopene	0.291	0.245	13	0.086	0.081	13	0.139	0.139	13	0.276	0.262	13
Total β-Cryptoxanthin	0.172	0.140	27	0.033	0.023	27	0.044	0.037	27	0.052	0.038	27
Total Lutein&Zeaxanthin	0.679	0.498	27	0.079	0.065	27	0.087	0.068	27	0.136	0.091	27

D2

You : Your reported values for the listed analytes (micrograms/milliliter)

NAV : NIST Assigned Values, equal to (NIST's average-of-averages + this RR's median) / 2

n : Number of non-NIST laboratories reporting quantitative values for this analyte in this serum

Please check our records against your records. Send corrections and/or updates to...

Micronutrients Measurement Quality Assurance Program
National Institute of Standards and Technology
100 Bureau Drive Stop 8392
Gaithersburg, MD 20899-8392 USA

Tel: (301) 975-3935
Fax: (301) 977-0685
Email: david.duewer@nist.gov

Individualized RR XLV Report: FSV-BA

Retinol

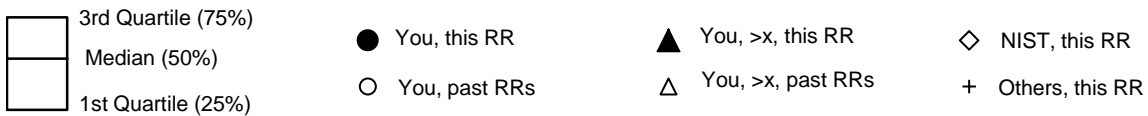
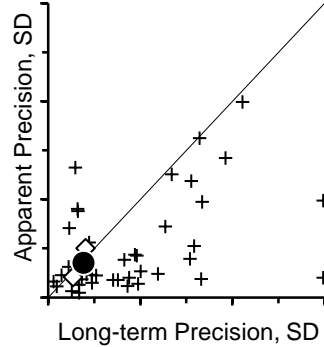
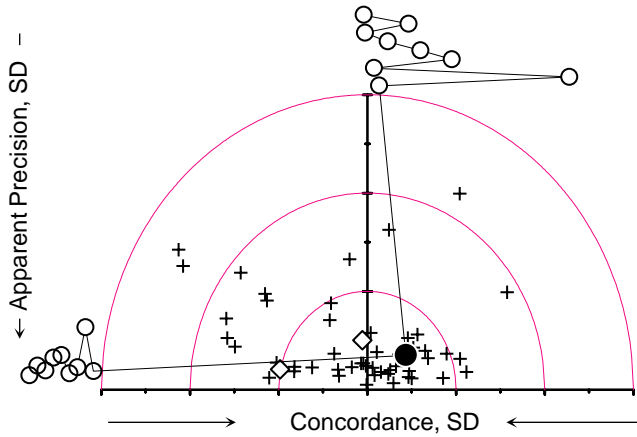
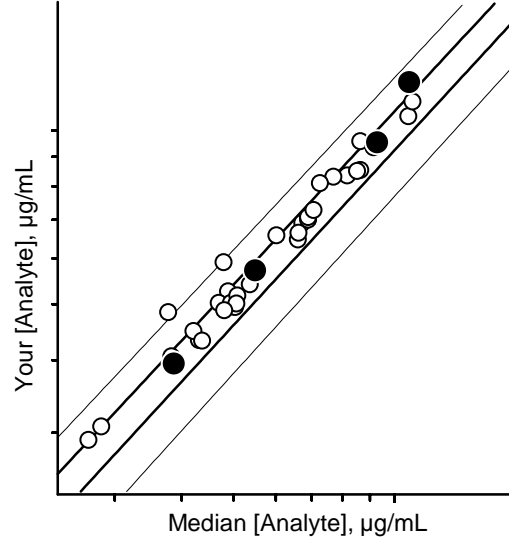
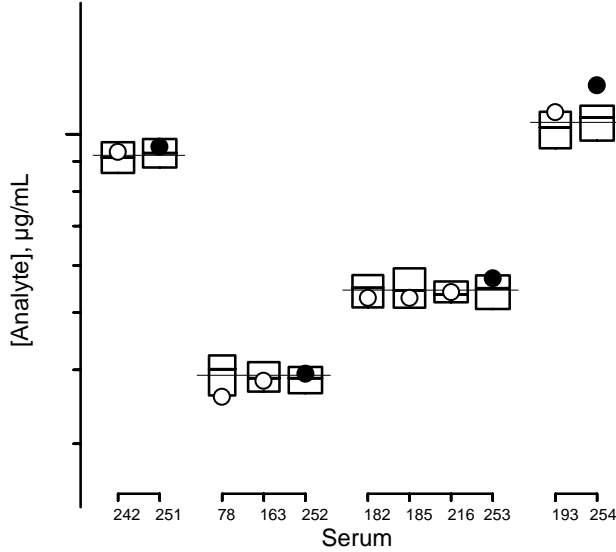

For details of the construction and interpretation of these plots, see:
 Duewer, Kline, Sharpless, Brown Thomas, Gary, Sowell. Anal Chem May 1, 1999.

Serum

#251	#242 in RR42 (4/98)
#252	#78 in RR12 (4/88), #163 in RR24 (4/92)
#253	#182&185 in RR28 (6/93), #216 in RR36 (3/96)
#254	#193 in RR30 (3/94)

History

Comments

Potential plasticizer interferent(s)
 Originally issued as "Control D"

Individualized RR XLV Report: FSV-BA

Retinyl Palmitate

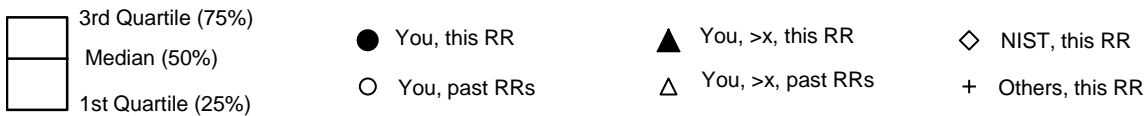
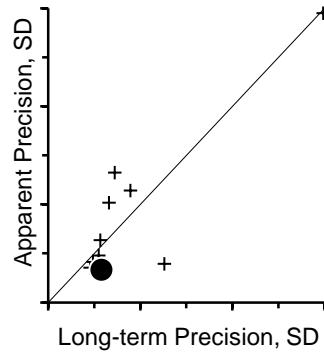
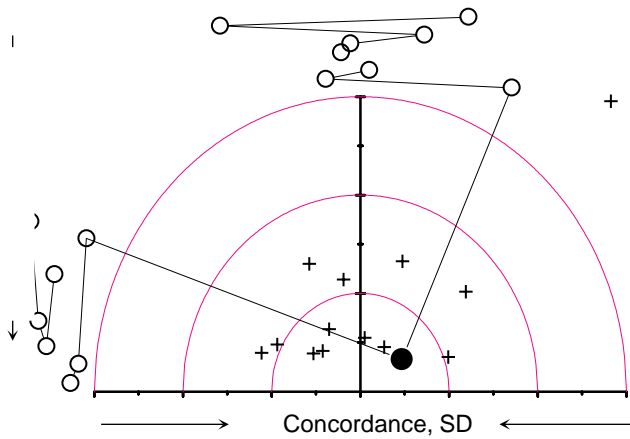
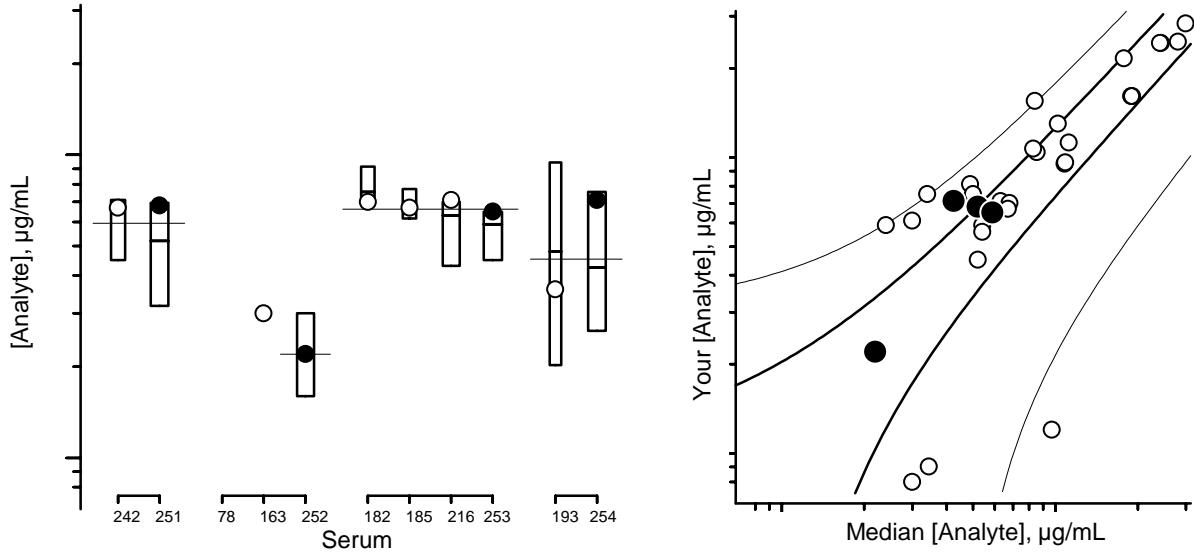

For details of the construction and interpretation of these plots, see:
 Duewer, Kline, Sharpless, Brown Thomas, Gary, Sowell. Anal Chem May 1, 1999.

Serum

#251	#242 in RR42 (4/98)
#252	#78 in RR12 (4/88), #163 in RR24 (4/92)
#253	#182&185 in RR28 (6/93), #216 in RR36 (3/96)
#254	#193 in RR30 (3/94)

History

Comments

Potential plasticizer interferent(s)
 Originally issued as "Control D"

Individualized RR XLV Report: FSV-BA

α -Tocopherol

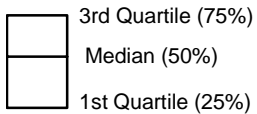
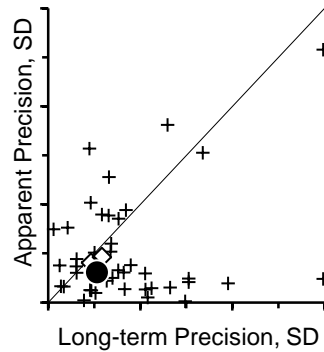
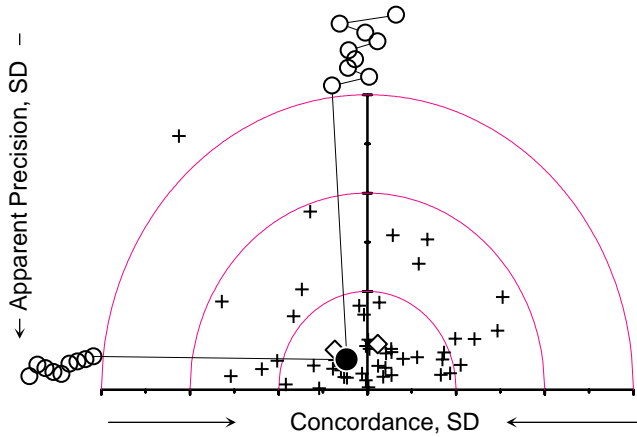
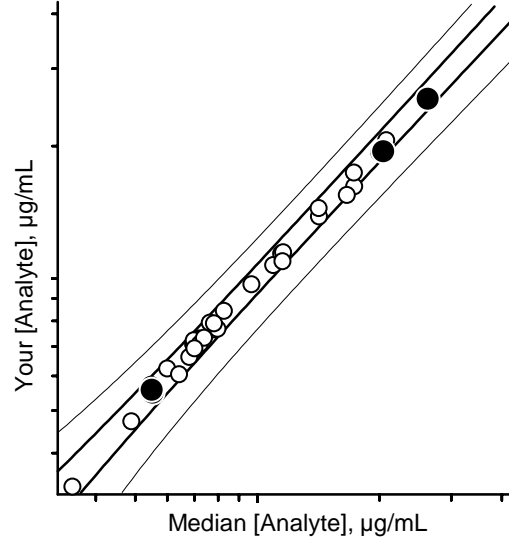
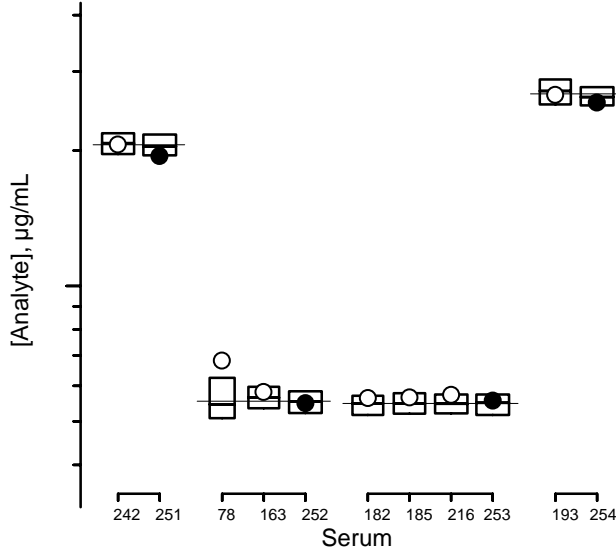

● You, this RR
○ You, past RRs

▲ You, >x, this RR
△ You, >x, past RRs

◇ NIST, this RR
+ Others, this RR

For details of the construction and interpretation of these plots, see:
Duewer, Kline, Sharpless, Brown Thomas, Gary, Sowell. Anal Chem May 1, 1999.

Serum

Serum	History
#251	#242 in RR42 (4/98)
#252	#78 in RR12 (4/88), #163 in RR24 (4/92)
#253	#182&185 in RR28 (6/93), #216 in RR36 (3/96)
#254	#193 in RR30 (3/94)

Comments

Potential plasticizer interferent(s)
Originally issued as "Control D"

Individualized RR XLV Report: FSV-BA

γ-Tocopherol

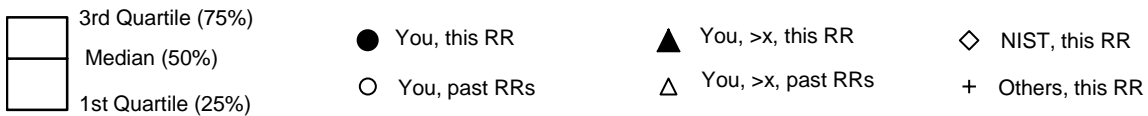
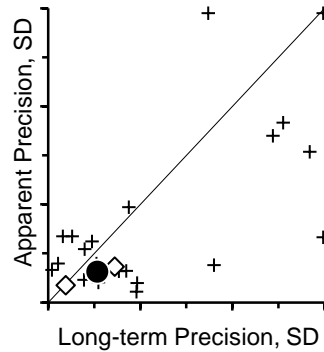
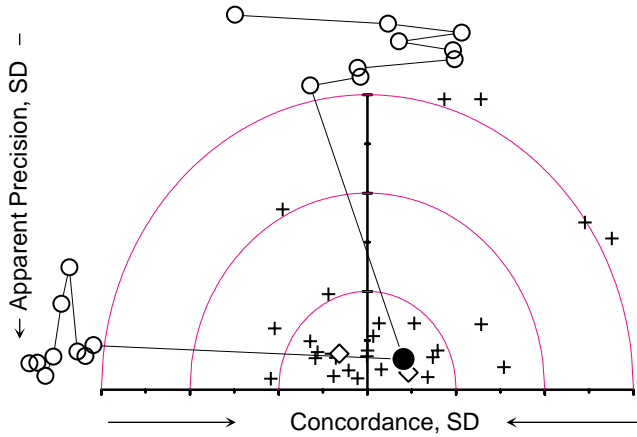
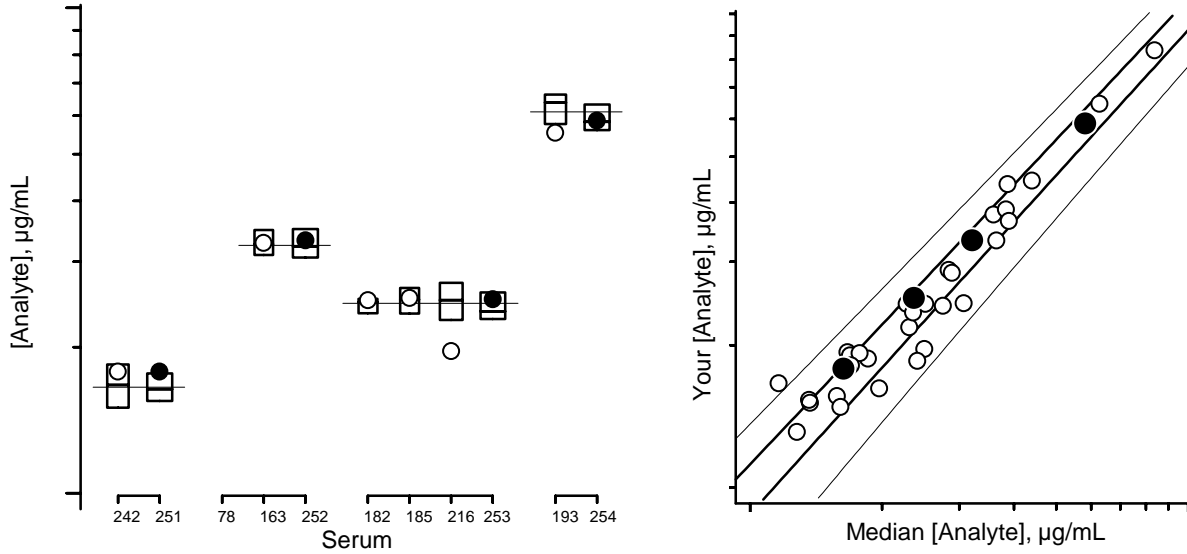

For details of the construction and interpretation of these plots, see:
 Duewer, Kline, Sharpless, Brown Thomas, Gary, Sowell. Anal Chem May 1, 1999.

Serum

Serum	History
#251	#242 in RR42 (4/98)
#252	#78 in RR12 (4/88), #163 in RR24 (4/92)
#253	#182&185 in RR28 (6/93), #216 in RR36 (3/96)
#254	#193 in RR30 (3/94)

Comments

Potential plasticizer interferent(s)
 Originally issued as "Control D"

Individualized RR XLV Report: FSV-BA

Total β -Carotene

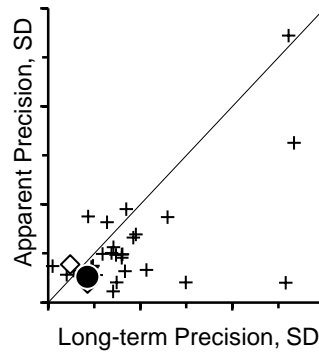
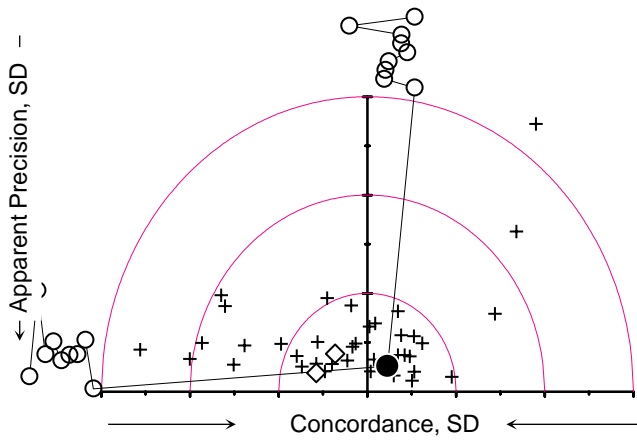
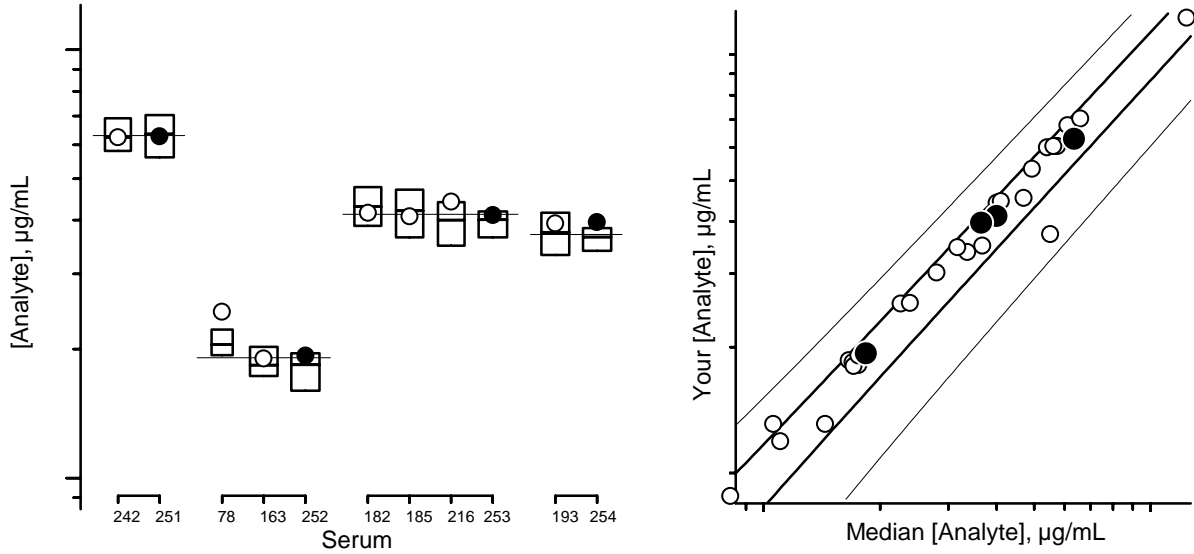

For details of the construction and interpretation of these plots, see:
 Duewer, Kline, Sharpless, Brown Thomas, Gary, Sowell. Anal Chem May 1, 1999.

Serum

#251	#242 in RR42 (4/98)
#252	#78 in RR12 (4/88), #163 in RR24 (4/92)
#253	#182&185 in RR28 (6/93), #216 in RR36 (3/96)
#254	#193 in RR30 (3/94)

History

Comments

Potential plasticizer interferent(s)
 Originally issued as "Control D"

Individualized RR XLV Report: FSV-BA

trans-β-Carotene

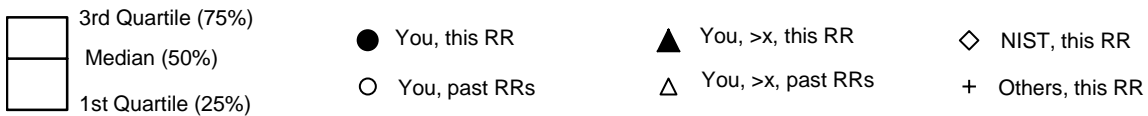
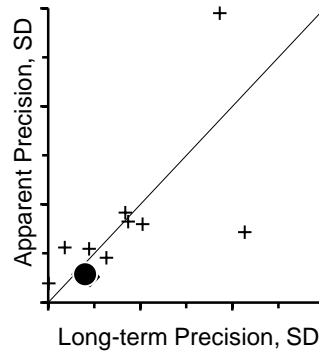
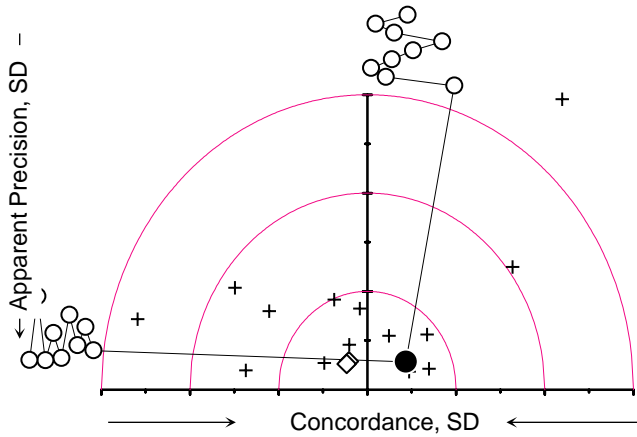
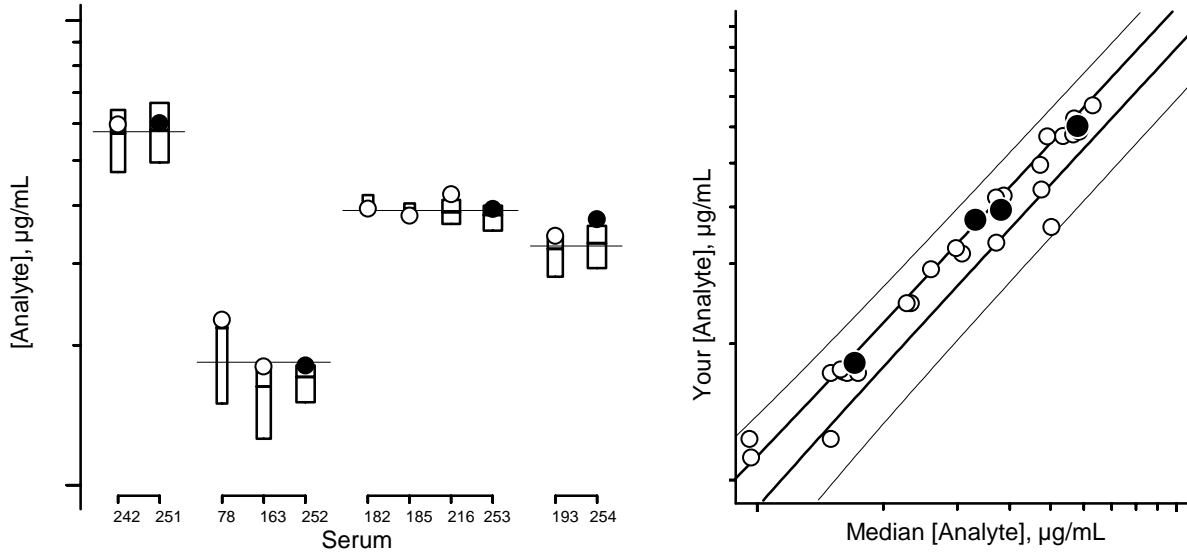

For details of the construction and interpretation of these plots, see:
 Duewer, Kline, Sharpless, Brown Thomas, Gary, Sowell. Anal Chem May 1, 1999.

Serum

#251	#242 in RR42 (4/98)
#252	#78 in RR12 (4/88), #163 in RR24 (4/92)
#253	#182&185 in RR28 (6/93), #216 in RR36 (3/96)
#254	#193 in RR30 (3/94)

History

Comments

Potential plasticizer interferent(s)
 Originally issued as "Control D"

Individualized RR XLV Report: FSV-BA

Total cis-β-Carotene

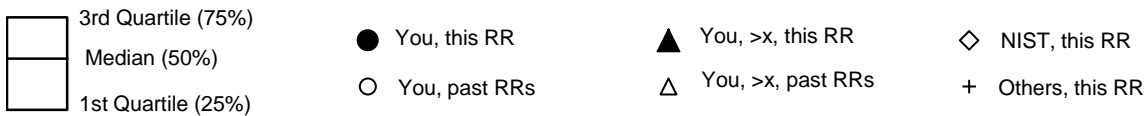
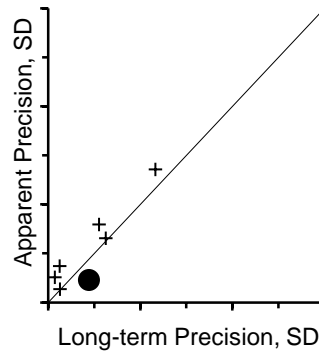
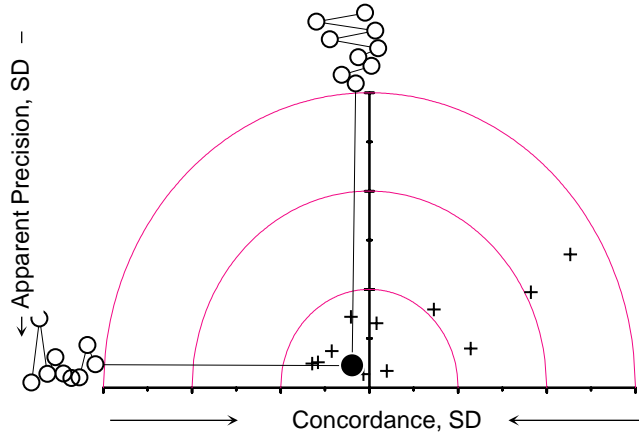
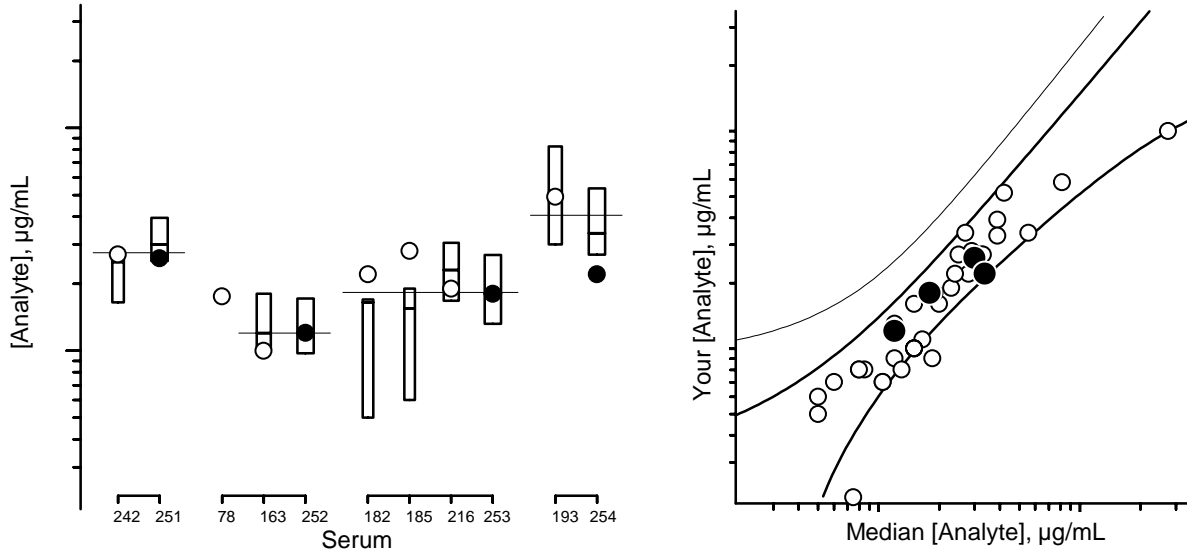

For details of the construction and interpretation of these plots, see:
 Duewer, Kline, Sharpless, Brown Thomas, Gary, Sowell. Anal Chem May 1, 1999.

Serum

#251	#242 in RR42 (4/98)
#252	#78 in RR12 (4/88), #163 in RR24 (4/92)
#253	#182&185 in RR28 (6/93), #216 in RR36 (3/96)
#254	#193 in RR30 (3/94)

History

Comments

Potential plasticizer interferent(s)
 Originally issued as "Control D"

Individualized RR XLV Report: FSV-BA

Total α -Carotene

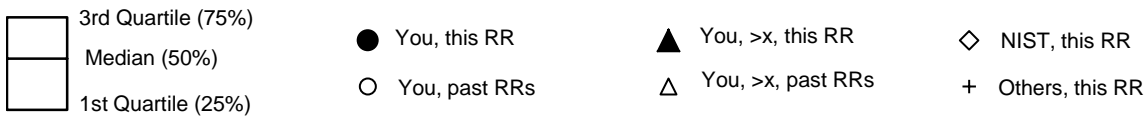
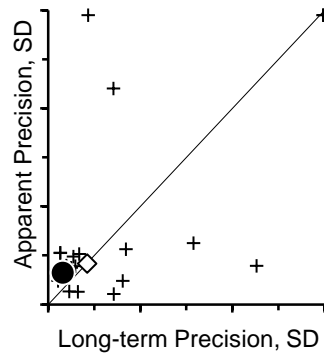
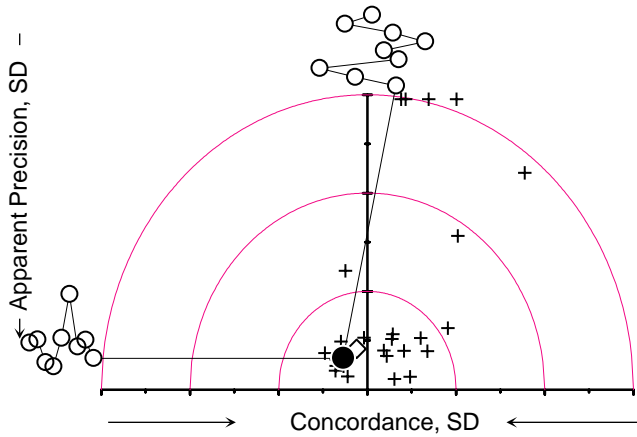
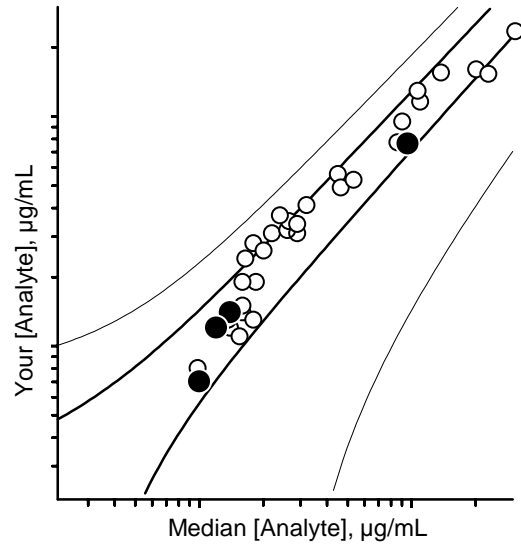
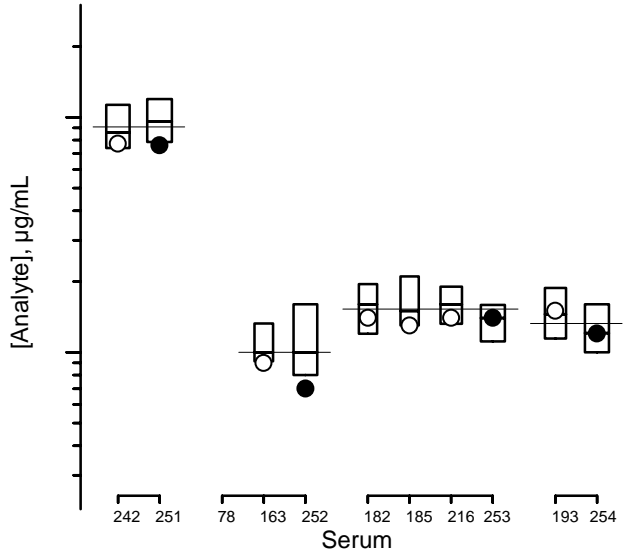

For details of the construction and interpretation of these plots, see:
 Duewer, Kline, Sharpless, Brown Thomas, Gary, Sowell. Anal Chem May 1, 1999.

Serum

#251	#242 in RR42 (4/98)
#252	#78 in RR12 (4/88), #163 in RR24 (4/92)
#253	#182&185 in RR28 (6/93), #216 in RR36 (3/96)
#254	#193 in RR30 (3/94)

History







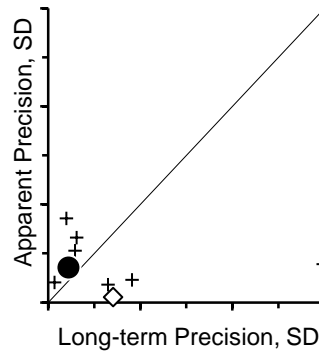
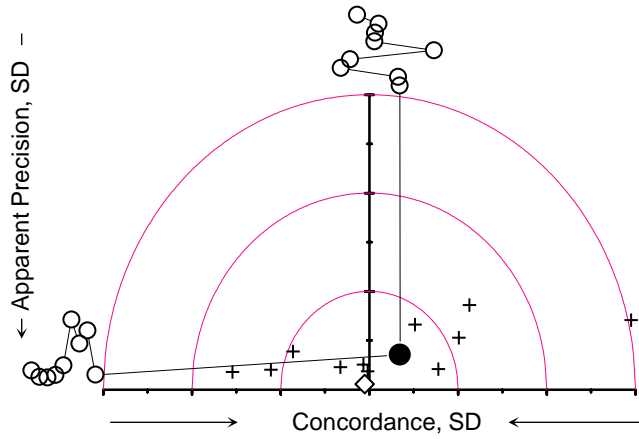
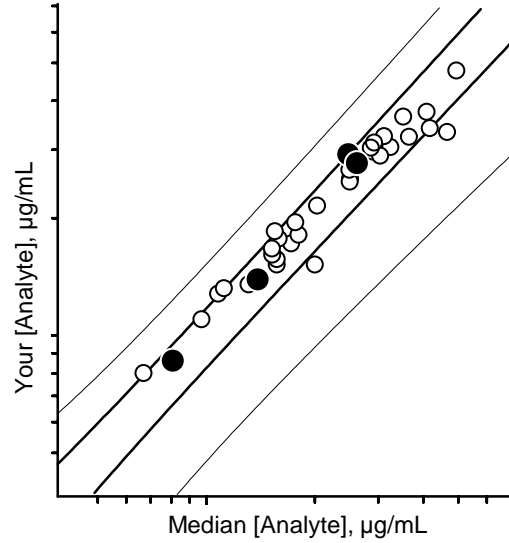
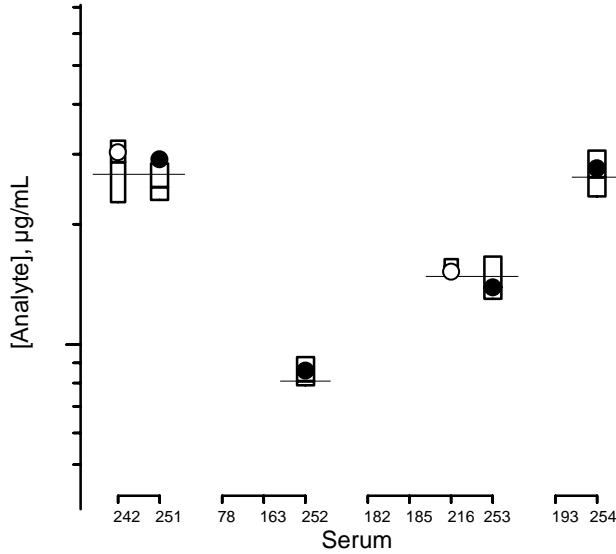

Comments

Potential plasticizer interferent(s)
 Originally issued as "Control D"

Individualized RR XLV Report: FSV-BA

trans-Lycopene



- | | | | |
|--|---|---|---|
|  3rd Quartile (75%) |  You, this RR |  You, >x, this RR |  NIST, this RR |
|  Median (50%) |  You, past RRs |  You, >x, past RRs |  Others, this RR |
|  1st Quartile (25%) | | | |

For details of the construction and interpretation of these plots, see:
 Duewer, Kline, Sharpless, Brown Thomas, Gary, Sowell. Anal Chem May 1, 1999.

Serum

#251	#242 in RR42 (4/98)
#252	#78 in RR12 (4/88), #163 in RR24 (4/92)
#253	#182&185 in RR28 (6/93), #216 in RR36 (3/96)
#254	#193 in RR30 (3/94)

History

Comments

Potential plasticizer interferent(s)
 Originally issued as "Control D"

Individualized RR XLV Report: FSV-BA

Total β -Cryptoxanthin

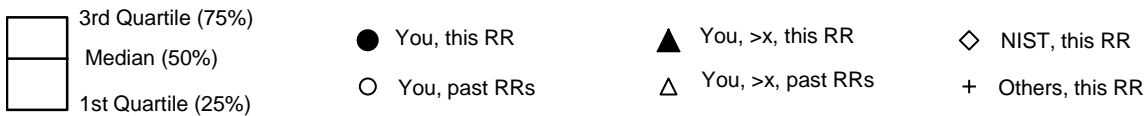
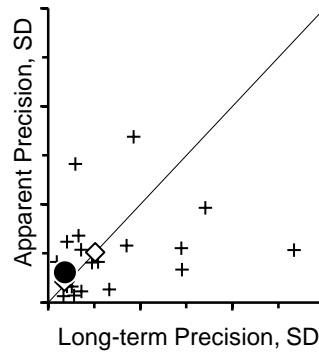
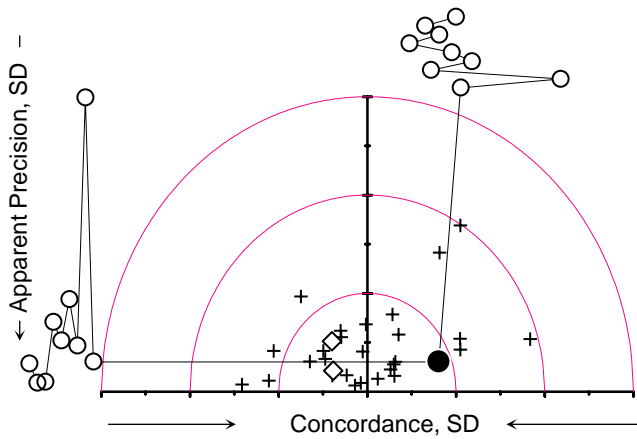
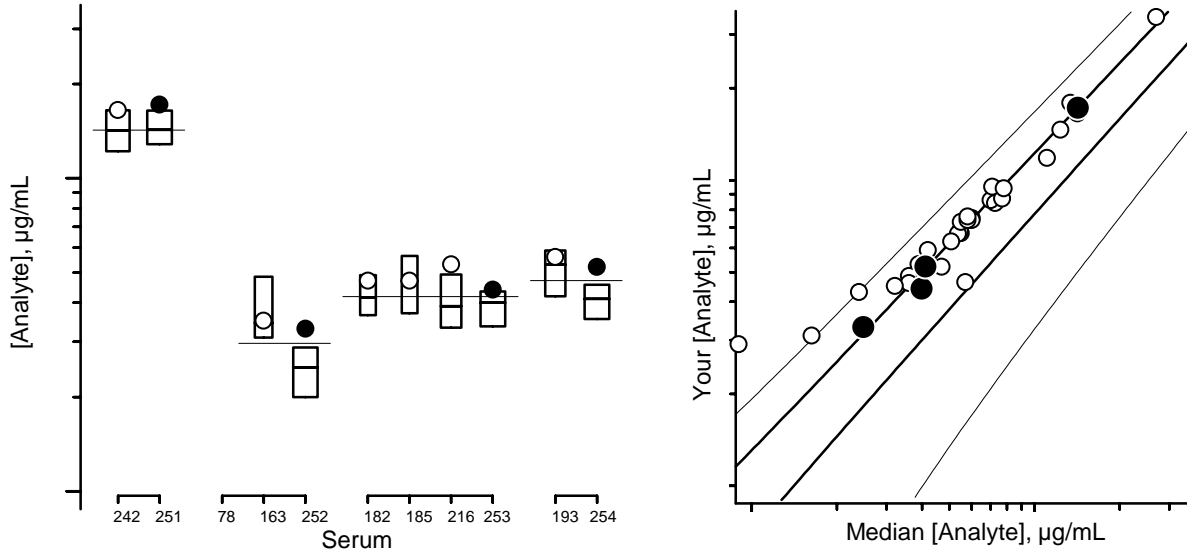

For details of the construction and interpretation of these plots, see:
 Duewer, Kline, Sharpless, Brown Thomas, Gary, Sowell. Anal Chem May 1, 1999.

Serum

#251	#242 in RR42 (4/98)
#252	#78 in RR12 (4/88), #163 in RR24 (4/92)
#253	#182&185 in RR28 (6/93), #216 in RR36 (3/96)
#254	#193 in RR30 (3/94)

History

Comments

Potential plasticizer interferent(s)
 Originally issued as "Control D"

Individualized RR XLV Report: FSV-BA

Total Lutein&Zeaxanthin

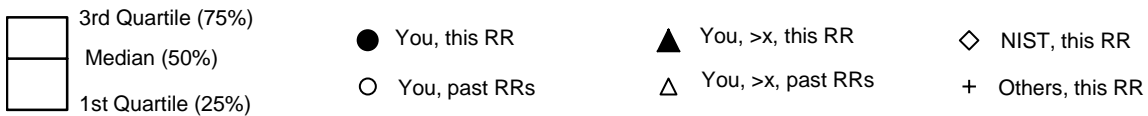
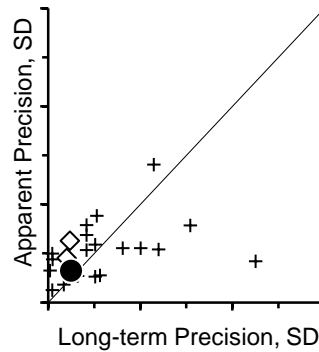
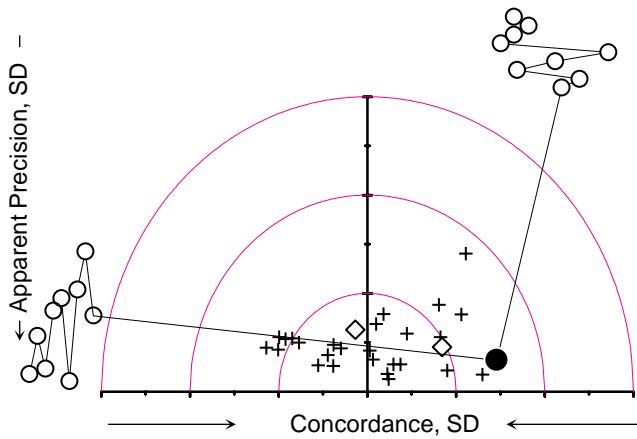
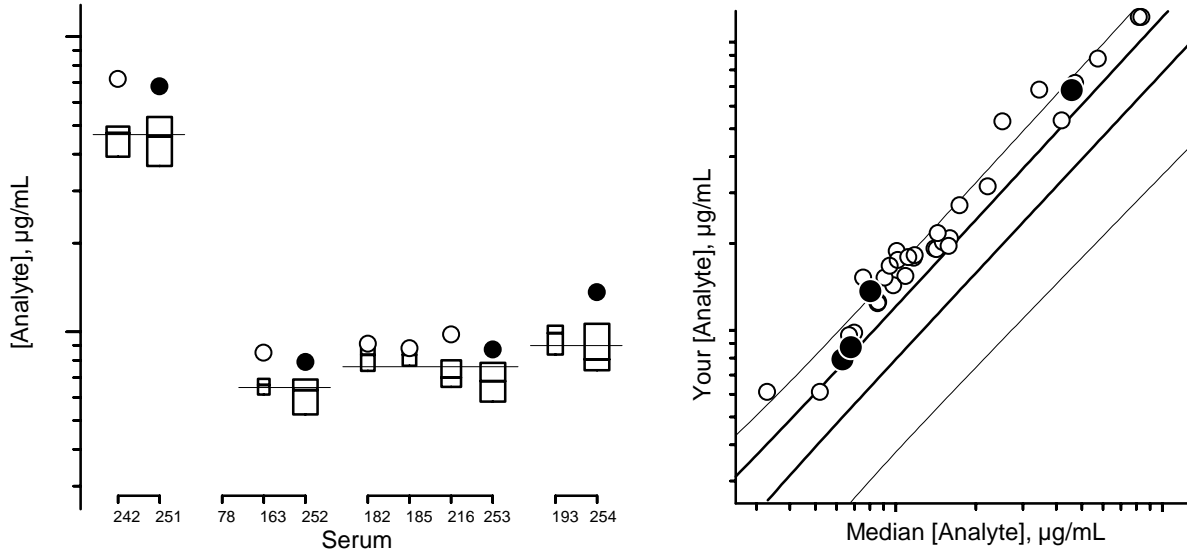

For details of the construction and interpretation of these plots, see:
 Duewer, Kline, Sharpless, Brown Thomas, Gary, Sowell. Anal Chem May 1, 1999.

Serum

#251	#242 in RR42 (4/98)
#252	#78 in RR12 (4/88), #163 in RR24 (4/92)
#253	#182&185 in RR28 (6/93), #216 in RR36 (3/96)
#254	#193 in RR30 (3/94)

History

Comments

Potential plasticizer interferent(s)
 Originally issued as "Control D"

Appendix E. Shipping Package Inserts for RR46

The following three items were included in each package shipped to an RR46 participant:

- Cover letter
- Datasheet

The cover letter and datasheet were enclosed in a sealed waterproof bag along with the samples themselves.



UNITED STATES DEPARTMENT OF COMMERCE
National Institute of Standards and Technology
Gaithersburg, Maryland 20899-

June 14, 1999

Dear Colleague:

Enclosed is the set of samples for the second quality assurance round robin exercise (Round Robin XLVI) for FY 99. You will find one vial of each of four lyophilized serum samples for analysis along with a form for reporting your results. When reporting your results, please submit one value for each analyte for a given serum sample. If an obtained value is below your limit of quantitation, please indicate this result on the form by using NQ (*Not Quantitated*). For analytes not measured, please leave a blank. Results are due to NIST by **September 10, 1999**. Results received two weeks after the due date will not be included in the summary report for this round robin study. The feedback report concerning the study will be provided around the first week of October.

Samples should be reconstituted with 1.0 mL of HPLC-grade water or equivalent. We recommend that dissolution be facilitated with 3 to 5 min agitation in an ultrasonic bath or at least 30 min at room temperature with intermittent swirling. (CAUTION: Vigorous shaking will cause foaming and possibly interfere with accurate measurement. The rubber stopper contains phthalate esters that will leach into the sample upon intermittent contact of the liquid sample with the stopper. These esters absorb strongly in the UV region and elute very near retinol in most LC systems creating analytical problems.) Pipette a known volume of serum from the vial for analysis. (The final volume of the reconstituted sample is greater than 1.0 mL.). For consistency, we request that laboratories use the following absorptivities (E 1% cm) in ethanol: retinol, 1843 at 325 nm; retinyl palmitate, 975 at 325 nm; α -tocopherol, 75.8 at 292 nm; γ -tocopherol, 91.4 at 298 nm; α -carotene, 2800 at 444 nm (in hexane); β -carotene, 2560 at 450 nm (in ethanol), 2592 at 452 nm (in hexane); lycopene, 3450 at 472 nm (in hexane).

Please mail or fax your results for Round Robin XLVI to:

Micronutrients Measurement Quality Assurance Program
NIST
100 Bureau Drive Stop 8392
Gaithersburg, MD 20899-8392
Fax: (301) 977-0685

If you have questions regarding this round robin exercise, please call me at (301) 975-3120; e-mail me at jbthomas@nist.gov; or mail/fax queries to the above address.

Sincerely,

Jeanice Brown Thomas

Research Chemist

Analytical Chemistry Division

Chemical Science and Technology Laboratory

Enclosures

cc: L. C. Sander

NIST

NIST Micronutrients Measurement Quality Assurance Program

Round Robin XLVI Results from Laboratory # _____

Analyte	Serum				Units*
	255	256	257	258	
total retinol					
trans-retinol					
retinyl palmitate					
α-tocopherol					
γ-tocopherol					
δ-tocopherol					
total β-carotene					
trans-β-carotene					
total cis-β-carotene					
total α-carotene					
trans-α-carotene					
total lycopene					
trans-lycopene					
total β-cryptoxanthin					
total α-cryptoxanthin					
total lutein					
total zeaxanthin					
total lutein&zeaxanthin					
Other Analytes?					

* We prefer µg/mL

Today's Date:

Comments?

Appendix F. Final Report for RR46

The following three pages are the final report as provided to all participants:

- Cover letter
- An information sheet that:
 - describes the contents of the “All-Lab” report
 - describes the content of the “Individualized” report
 - describes the nature of the test samples and details any previous distributions
 - summarizes aspects of the study that we believe may be of interest to the participants



UNITED STATES DEPARTMENT OF COMMERCE
National Institute of Standards and Technology
Gaithersburg, Maryland 20899

October 22, 1999

Dear Colleague:

Enclosed is the summary report of the results for Round Robin XLVI (RR 46). Included in this report are: a summary of data for all laboratories; the measurement comparability summary for evaluating laboratory performance; a summary of individual laboratory performance and interlaboratory accuracy and precision; and a summary of the NIST assigned value (NAV) vs. your laboratory value for the analytes measured. As in previous reports, the NIST assigned values are derived from the equally weighted means of the medians from this interlaboratory comparison exercise and the means from the analyses performed by NIST.

Data for evaluating laboratory performance in RR 46 are provided in the comparability summary (Score Card) on page 6 of the "All Lab Report." Laboratory comparability is summarized as follows: results rated 1 to 3 are within 1 to 3 standard deviation(s) of the assigned value; those rated 4 are >3 standard deviations from the assigned value.

If you have concerns regarding your laboratory performance, we suggest that you obtain and analyze a unit of SRM 968c, Fat-Soluble Vitamins, Carotenoids, and Cholesterol in Human Serum, when it becomes available. If your measured values do not agree with the certified values, we suggest that you contact us for consultation.

We are in the process of evaluating the QA program for FY 2000 and will inform you in a forthcoming letter of the decision regarding its continuance. If it is decided that the program will continue through FY 2000, an Intent-to-Participate form, which will provide us with formal notification of your intent to participate in the program for the upcoming year, will be mailed to you.

If you have any questions regarding this report, please contact me at 301/975-3120; fax: 301/977-0685; or e-mail: jeanice.brownthomas@nist.gov.

Sincerely,

Jeanice Brown Thomas
Research Chemist
Analytical Chemistry Division
Chemical Science and Technology Laboratory

cc: L. C. Sander

Enclosures

NIST

The NIST M²QAP Round Robin XLVI (RR46) report includes:

Page	“All Lab” Report
1-4	A listing of all results and statistics for analytes reported by at least two laboratories
5	A list of results for the analytes reported by only one laboratory and a legend for the above two lists
6	The “Measurement Comparability Summary” (or “Score Card”)

Page	“Individualized” Report
1	Your values, the number of labs reporting values, and our assigned values.
2+	“Four Plot” summaries of your current and past measurement performance, one page for each analyte you report that is also reported by at least 6 other participants.

See Anal Chem 1999; 71:1074-9 for details of the design and interpretation of the “Four Plot” graphics.

Samples. Four sera from previous Round Robin exercises were distributed in RR46. The sera were selected from our -80 °C archives to: 1) confirm analyte stability in our SRM 968c sera and 2) further explore “total retinol” vs. “*trans*-retinol” issues with a serum believed to have a very high *trans*-retinol level and a Report data sheet that separately lists the two measurands.

Serum #255 is a medium-to-high-analyte level augmented serum, previously distributed as #193 (RR30,3/94) and #254 (RR45,3/99). Approximately 30% of the total retinol in this serum is a mixture of *cis*-retinol isomers.

Serum #256 is Level II of SRM 968c, previously distributed as #249 (RR44,10/98). This material is a blended serum with native carotenoid levels and augmented levels of α - and δ -tocopherol.

Serum #257 is native serum, previously distributed as #171 (RR26,10/92) and as #176 (RR27,3/93).

Serum #258 is Level I of SRM 968c, previously distributed as #249 (RR44,10/98). This material is a blended serum with native carotenoid levels and augmented levels of retinol and γ -tocopherol.

Qualitative Results.

- 1) One participant noted that sera #255 and #258 “yielded extremely dense suspensions quite unlike a normal serum sample; they had the appearance of ... samples which have been repeatedly sampled and refrozen over an extended period of time”. Since these two sera are quite unrelated and of very different vintage and this was the only comment of this nature, we do not believe this indicates a general problem. However, **whenever** one of the M²QAP samples is “odd”, **please** note the particulars on the report sheet or in a cover letter!
- 2) Analyst NISTb changed from a C₁₈ to a C₃₀ column for all M²QAP analyses in this exercise. To our distress, both sera #256 and #258 contain presumptively plasticizers that fluoresce at λ_{ex} 295 nm, λ_{em} 335 nm. On retrospective examination of the chromatograms from last year’s analysis of these materials, these compounds elute on C₁₈ columns well before the tocopherols. Since the distributions of the RR44 and RR46 tocopherol data for these two sera are quite routine, we believe these compounds are tocopherol interferents **only** with the C₃₀ column and perhaps only when using fluorescence detection.

Quantitative Results

- 1) The only noted interference artifact is discussed above.
- 2) There is no evidence for any analyte that any of the four sera have significantly degraded in storage, either in change of medians or in increased interlaboratory variability.
- 3) Note that serum #255 is a repeat of RR45's #254. We believe that this serum contains about 70% *trans*- and 30% *cis*-retinol. Examination of your data in the summary box plot for "total retinol" may help you evaluate whether what you report is what you are actually measuring. If you report "total retinol", your values should be in about the same location relative to the interlaboratory median for all four sera. If your data for sera #254 and #255 are relatively lower than the other three sera, you may not be accounting for the *cis*-retinol isomers. If you report *trans*-retinol, the relative location of your values for #254 and #255 (plotted as triangles, signifying ">x" values for total retinol) should be relatively lower than the other three. If your values for this material are too concordant with the other sera, you are not resolving the isomers.

For those of you who are interested in the mathematics of analytical calibration – hopefully, at least all of you who “do your own” rather than using procedures built-in to commercial chromatographic software systems – we strongly encourage you to read: “Guidelines for Calibration in Analytical Chemistry. Part 1. Fundamentals and Single Component Calibration”, Klaus Danzer and Lloyd A. Currie (Analytical Chemistry Division, Commission on General Aspects of Analytical Chemistry, IUPAC), *Pure & Applied Chemistry*, Vol. 70 No. 4, pp. 993-1014, 1998. This article clearly presents the appropriate nomenclature, implementation equations, and summary statistics for a number of different calibration models.

Appendix G. “All-Lab Report” for RR46

The following six pages are the “All-Lab Report” as provided to all participants, with two exceptions:

- the participant identifiers (Lab) have been altered.
- the order in which the participant results are listed has been altered.

The data summary in the “All-Lab Report” has been altered to ensure confidentiality of identification codes assigned to laboratories. The only attributed results are those reported by NIST. The NIST results are not used in the assessment of the consensus summary results of the study.

Round Robin XLVI Laboratory Results

All values in µg/mL

Lab	Total Retinol				trans-Retinol				Retinyl Palmitate				α-Tocopherol				γ-Tocopherol				
	255	256	257	258	255	256	257	258	255	256	257	258	255	256	257	258	255	256	257	258	
FSV-BA	1.089	0.467	0.504	0.787					0.076	0.125	0.186	0.058	28.12	17.89	5.23	7.50	5.81	1.53	1.96	3.54	
FSV-BB	1.152	0.473	0.525	0.848					0.051	0.070	0.161	0.031	27.34	17.28	4.92	7.66	5.65	1.45	1.88	3.59	
FSV-BD	1.033	0.456		0.813									26.50	15.90		7.90					
FSV-BE	1.049	0.462	0.528	0.835									26.99	17.67	5.26	7.89	6.26	1.38	2.04	3.92	
FSV-BF	1.030	0.515	0.525	0.905					0.051	0.074	0.070	0.097	27.35	16.55	4.70	7.60	5.87	1.55	1.96	3.82	
FSV-BG	1.049	0.455	0.512	0.804					0.023	0.105	0.166	0.048	28.37	17.51	4.94	7.98	6.16	1.60	2.05	3.87	
FSV-BGa	1.081	0.461	0.509	0.825					0.028	0.088	0.171	0.041	28.40	16.73	4.89	7.60	5.41	1.57	2.02	3.46	
FSV-BH	0.871	0.460	0.520	0.772					nq	0.066	0.191	nq	26.24	16.64	4.75	7.38	6.42	1.74	2.20	4.13	
FSV-BI	1.071	0.477	0.542	0.851					nd	0.110	0.230	0.042	28.62	16.55	4.99	7.44	6.20	1.46	1.96	3.80	
FSV-BJ	1.096	0.491	0.533	0.832					nq	0.076	0.212	nq	28.77	17.71	5.05	7.81	6.46	1.67	2.06	3.98	
FSV-BK	>1.190	>0.521	>0.575	>0.903	1.190	0.521	0.575	0.903					27.30	16.90	5.00	7.40					
FSV-BL	0.830	0.430	0.520	0.800									27.56	15.94	5.17	7.75					
FSV-BM	1.000	0.510	0.568	0.900									29.20	16.40	4.90	7.32					
FSV-BN	1.048	0.459	0.540	0.847					0.019	0.073	0.220	0.030	28.25	17.69	5.05	7.99	5.65	1.47	1.81	3.63	
FSV-BO	0.980	0.458	0.533	0.845									26.30	16.28	5.00	7.58					
FSV-BP	0.934	0.445	0.508	0.769									25.94	16.52	5.25	7.29					
FSV-BQ	1.021	0.501	0.536	0.985									25.24	15.31	4.52	7.73					
FSV-BR	>1.20	>0.53	>0.58	>1.09	1.200	0.530	0.580	1.090													
FSV-BS	0.840	0.772	0.820	1.309																	
FSV-BT	1.106	0.428	0.624	1.093					0.018	0.087	0.176	0.020	21.09	11.39	3.57	4.73	5.15	1.90	1.58	2.75	
FSV-BU	1.061	0.471	0.562	0.845									27.19	16.99	6.07	8.45	5.57	2.00	2.34	3.70	
FSV-BV	0.698	0.352	0.387	0.686									23.30	14.77	4.10	6.78	5.57	1.41	1.88	3.86	
FSV-BW	1.133	0.498	0.550	0.830					nd	0.113	0.245	0.043	27.00	17.16	4.76	7.37	6.11	1.60	2.06	3.73	
FSV-BX	1.080	0.471	0.574	0.887									26.44	16.56	5.07	7.74	5.88	1.58	2.16	3.92	
FSV-BZ													24.10	13.00	4.10	6.10	4.00	1.70	1.80	3.80	
FSV-CB	1.032	0.480	0.571	0.868									24.92	15.54	5.82	7.39					
FSV-CC	1.100	0.550	>0.55	0.910	1.000	0.520	0.550	0.830					27.70	17.24	4.85	7.09					
FSV-CD	1.029	0.514	0.543	0.902					0.046	0.104	0.122	0.042	27.06	16.58	4.94	7.23	5.93	1.47	1.95	3.76	
FSV-CE	1.058	0.477	0.537	0.829									28.47	17.24	4.88	7.29					
FSV-CF	0.976	0.500	0.555	0.850									28.90	18.10	5.50	8.30					
FSV-CG	1.037	0.553	0.542	0.907									25.54	16.59	4.79	7.45	6.04	1.84	2.12	4.14	
FSV-CH	1.009	0.429	0.492	0.793									25.73	16.05	5.52	8.05	5.27	1.33	1.69	3.34	
FSV-CI	0.730	0.600	0.720	0.890					0.070	0.080	0.180	0.030	28.00	15.10	4.40	5.20	6.50	1.50	2.00	2.90	
FSV-CK	1.074	0.504	0.630	1.031									26.75	17.06	5.34	8.74	6.46	1.67	2.46	4.96	
FSV-CL	0.975	0.453	0.541	0.804									34.40	22.70	7.14	10.51	7.32	2.17	2.63	4.64	
FSV-CN	1.063	0.484	0.554	0.969									27.78	17.54	5.07	8.75	6.03	1.54	2.05	4.40	
FSV-CR	1.130	0.470	0.500	0.850									30.50	18.00	4.80	7.80					
FSV-CS	1.007	0.579	0.665	1.063									29.31	17.65	5.03	8.67	6.48	1.59	2.02	4.22	
FSV-CT	1.069	0.482	0.528	0.803									28.36	17.91	6.22	8.72					
FSV-CV	0.597	0.557	0.550	0.735					0.007	0.079	0.163	0.022	16.16	18.77	4.99	6.57	3.39	1.63	2.01	3.25	
FSV-CX	>0.44	>0.44	>0.51	>0.76	0.440	0.440	0.510	0.760					26.46	16.59	4.89	7.45	5.77	1.40	1.94	3.72	
FSV-DB	1.165	0.499	0.539	0.881									28.05	17.14	4.82	7.63					
FSV-DD	1.093	0.476	0.523	0.799																	
FSV-DF	1.005	0.441	0.492	0.797	1.005	0.441	0.492	0.797													
FSV-DH	0.950	0.380	0.470	0.720									23.15	12.72	4.14	4.25	4.28	0.96	1.42	2.77	
FSV-DK	1.090	0.440	0.510	0.840					0.011	0.034	0.065	0.015	24.98	14.84	3.79	5.87	5.55	1.34	1.54	2.98	
FSV-DP	>0.971	>0.485	>0.534	>0.842	0.971	0.485	0.534	0.842													
FSV-DR	1.040	0.435	0.490	0.830									27.86	16.38	4.48	7.01					
FSV-DU	1.540	0.480	0.610	1.010									38.10	26.40	8.53	11.60					
FSV-EH	0.906	0.418	0.519	0.792					0.038	0.074	0.135	0.042	38.02	21.42	5.47	8.41	4.81	1.24	1.47	2.87	
FSV-EM	1.200	0.530	0.770	0.860									24.76	16.75	5.19	6.29					
FSV-EQ	1.016	0.481	0.610	0.811									22.24	13.82	4.20	6.34					
FSV-ES	>0.898	>0.465	>0.516	>0.813	0.898	0.465	0.516	0.813					22.07	14.88	4.54	6.90					
FSV-FG	0.830	0.490	0.550	0.880									21.70	14.10	3.60	5.60					
N	48	48	46	48	7	7	7	7	12	16	16	14	49	49	48	49	29	29	29	29	
Min	0.597	0.352	0.387	0.686	0.440	0.440	0.492	0.760	0.007	0.034	0.065	0.015	16.2	11.4	3.6	4.3	3.4	1.0	1.4	2.7	
Median	1.039	0.477	0.538	0.845	1.000	0.485	0.534	0.830	0.033	0.080	0.173	0.042	27.2	16.6	4.9	7.5	5.9	1.6	2.0	3.8	
Max	1.540	0.772	0.820	1.309	1.200	0.530	0.580	1.090	0.076	0.125	0.245	0.097	38.1	26.4	8.5	11.6	7.3	2.2	2.6	5.0	
eSD	0.077	0.033	0.030	0.066	0.121	0.050	0.037	0.050	0.024	0.023	0.031	0.009	2.1	1.2	0.3	0.6	0.5	0.2	0.1	0.3	
eCV	7	7	6	8	12	10	7	6	73	28	18	22	8	7	7	8	8	10	7	9	
N _{past}	47	46	40	46	0	0	0	0	10	15	9	13	46	46	39	46	24	23	14	23	
Median _{past}	1.047	0.481	0.541	0.853					0.045	0.083	0.192	0.030	26.72	16.63	4.93	7.40	6.11	1.61	2.11	3.90	
SD _{past}	0.106	0.043	0.043	0.047					0.047	0.021	0.028	0.013	2.22	1.46	0.49	0.84	0.59	0.12	0.25	0.32	
NISTa	0.984	>0.500	>0.585	0.905	0.840	0.500	0.585	0.867					27.83	17.50	4.87	7.53	6.32	1.54	2.05	3.98	
NISTb	>0.913	>0.466	>0.537	>0.815	0.913	0.466	0.537	0.815					29.90		5.27		6.05		1.98		
N _{NIST}	6	6	6	6	6	6	6	6					6	3	6	3	6	3	6	3	
Mean _{NIST}	0.941	0.483	0.561	0.858	0.876	0.483	0.561	0.839					28.79	17.50	5.08	7.53	6.16	1.55	2.02	3.98	
S _{rep}	0.017	0.007	0.011	0.025	0.047	0.007	0.011	0.022					0.24	0.23	0.13	0.08	0.06	0.02	0.07	0.07	
S _{het}	0.058	0.005	0.007	0.019	0.073	0.005	0.007	0.017					0.49	0.15	0.15	0.08	0.11	0.03	0.04	0.05	
S _{anal}	0.058	0.025	0.034	0.067	0.034	0.025	0.034	0.040					1.42		0.26		0.18		0.05		
S _{NIST}	0.084	0.026	0.037	0.074	0.093	0.026	0.037	0.048					1.52	0.27	0.33	0.12	0.22	0.04	0.10	0.09	
NAV	0.990	0.480	0.549	0.851	0.938	0.484	0.547	0.835	0.033	0.080	0.173	0.042	27.99	17.07	5.01	7.51	6.01	1.55	2.01	3.87	
NAU	0.109	0.039	0.046	0.074	0.150	0.050	0.047	0.065	0.024	0.025	0.043	0.019	2.48	1.43	0.49	0.62	0.53	0.17	0.21	0.38	

Round Robin XLVI Laboratory Results

All values in µg/mL

Lab	α-Tocopherol				Total β-Carotene				trans-β-Carotene				Total cis-β-Carotene			
	255	256	257	258	255	256	257	258	255	256	257	258	255	256	257	258
FSV-BA					0.399	0.488	0.411	0.186	0.362	0.453	0.382	0.173	0.037	0.034	0.029	0.013
FSV-BB					0.334	0.413	0.377	0.167	0.311	0.393	0.354	0.157	0.024	0.020	0.023	0.010
FSV-BD																
FSV-BE					0.322	0.341	0.318	0.151								
FSV-BF					0.367	0.389	0.375	0.187								
FSV-BG					0.396	0.497	0.428	0.206								
FSV-BGa					0.377	0.465	0.395	0.196								
FSV-BH					0.366	0.439	0.384	0.156	0.337	0.411	0.353	0.156	0.029	0.028	0.031	<i>nq</i>
FSV-BI					0.383	0.433	0.393	0.184								
FSV-BJ					0.428	0.480	0.435	0.171								
FSV-BK																
FSV-BL																
FSV-BM																
FSV-BN	0.722	0.904	0.171	0.096	0.368	0.436	0.391	0.190	0.321	0.406	0.346	0.164	0.038	0.020	0.035	0.017
FSV-BO					0.327	0.383	0.323	0.158	0.311	0.368	0.311	0.153	0.016	0.016	0.012	0.005
FSV-BP																
FSV-BQ																
FSV-BR																
FSV-BS					0.247	0.347	0.295	0.140								
FSV-BT	0.386	1.962	0.175	0.220	0.289	0.308	0.294	0.139	0.264	0.283	0.275	0.132	0.025	0.025	0.020	0.007
FSV-BU					0.273	0.356	0.370	0.186								
FSV-BV					0.408	0.474	0.426	0.203								
FSV-BW					0.410	0.440	0.370	0.165								
FSV-BX									0.312	0.426	0.370	0.182				
FSV-BZ					0.351	0.480	0.392	0.213	0.320	0.450	0.380	0.200	0.031	0.030	0.012	0.013
FSV-CB					0.430	0.483	0.429	0.208								
FSV-CC																
FSV-CD					0.387	0.439	0.347	0.180								
FSV-CE					0.361	0.449	0.351	0.169								
FSV-CF																
FSV-CG	1.043	1.244	0.575	0.633	0.403	0.490	0.412	0.192	0.355	0.452	0.378	0.177	0.048	0.038	0.034	0.015
FSV-CH					0.356	0.418	0.372	0.175								
FSV-CI																
FSV-CK					0.483	0.521	0.456	0.166								
FSV-CL					0.347	0.410	0.360	0.151								
FSV-CN					>0.346	>0.427	>0.375	>0.197	0.346	0.427	0.375	0.197				
FSV-CR	0.700	0.700	0.300	<0.3												
FSV-CS					0.387	0.432	0.402	0.200	0.345	0.387	0.363	0.187	0.042	0.045	0.039	0.013
FSV-CT					0.327	0.450	0.318	0.170								
FSV-CV					0.197	0.440	0.385	0.147								
FSV-CX	0.400	0.580	0.120	0.130					0.280	0.340	0.300	0.150				
FSV-DB					0.348	0.424	0.354	0.158								
FSV-DD																
FSV-DF																
FSV-DH					>0.395	>0.410	>0.397	>0.183	0.353	0.380	0.369	0.166	>0.042	>0.030	>0.028	>0.017
FSV-DK					0.383	0.489	0.415	0.188								
FSV-DP																
FSV-DR					0.348	0.426	0.312	0.167								
FSV-DU					0.390	0.350	0.300	0.160								
FSV-EH	0.246	0.391	0.085	0.129	0.366	0.448	0.431	0.224	0.340	0.420	0.398	0.203	0.026	0.028	0.033	0.021
FSV-EM					0.302	0.402	0.368	0.165								
FSV-EQ					0.436	0.418	0.407	0.161								
FSV-ES					>0.289	>0.389	>0.337	>0.171	0.289	0.389	0.337	0.171				
FSV-FG																
N	6	6	6	5	34	34	34	34	15	15	15	15	10	10	10	9
Min	0.246	0.391	0.085	0.096	0.197	0.308	0.294	0.139	0.264	0.283	0.275	0.132	0.016	0.016	0.012	0.005
Median	0.550	0.802	0.173	0.130	0.367	0.438	0.381	0.171	0.321	0.406	0.363	0.171	0.030	0.028	0.030	0.013
Max	1.043	1.962	0.575	0.633	0.483	0.521	0.456	0.224	0.362	0.453	0.398	0.203	0.048	0.045	0.039	0.021
eSD	0.243	0.407	0.101	0.067	0.042	0.045	0.043	0.022	0.026	0.032	0.026	0.021	0.009	0.009	0.010	0.004
eCV	44	51	58	52	12	10	11	13	8	8	7	12	30	31	33	29
N _{past}	0	0	0	0	36	31	34	31	13	14	0	14	10	10	0	9
Median _{past}					0.370	0.411	0.402	0.176	0.327	0.371		0.158	0.041	0.033		0.015
SD _{past}					0.050	0.051	0.068	0.022	0.049	0.025		0.012	0.031	0.012		0.005
NISTa	0.346	0.534	<i>nq</i>	0.140	0.369	0.411	0.340	0.171	0.344	0.405	0.336	0.168	0.025	0.006	0.003	0.003
NISTb	0.463		0.148		>0.362	>0.442	>0.380	>0.179	0.362	0.442	0.380	0.179				
N _{NIST}	6	3	3	3	3	3	3	3	6	6	6	6				
Mean _{NIST}	0.347	0.534	0.148	0.140	0.368	0.411	0.340	0.170	0.355	0.424	0.358	0.173				
S _{rep}	0.148	0.020	0.006	0.000	0.006	0.012	0.005	0.004	0.016	0.010	0.009	0.004				
S _{net}	0.064	0.010	0.006	0.004	0.013	0.016	0.013	0.003	0.010	0.010	0.016	0.002				
S _{ant}	0.164								0.011	0.026	0.031	0.008				
S _{NIST}	0.229	0.022	0.009	0.004	0.015	0.020	0.014	0.005	0.022	0.030	0.036	0.009				
NAV	0.448	0.668	0.160	0.135	0.367	0.424	0.360	0.170	0.338	0.415	0.361	0.172	0.030	0.028	0.030	0.013
NAU	0.282	0.449	0.102	0.068	0.052	0.064	0.061	0.027	0.042	0.045	0.039	0.021	0.011	0.010	0.011	0.005

Round Robin XLVI Laboratory Results

All values in µg/mL

Lab	Total α-Carotene				trans-α-Carotene				Total Lycopene				trans-Lycopene				Total β-Cryptoxanthin			
	255	256	257	258	255	256	257	258	255	256	257	258	255	256	257	258	255	256	257	258
FSV-BA	0.008	0.095	0.011	0.010									0.289	0.244	0.114	0.185	0.030	0.026	0.030	0.085
FSV-BB	0.014	0.087	0.011	0.013					0.456	0.386	0.182	0.295	0.227	0.192	0.095	0.147	0.038	0.031	0.032	0.071
FSV-BD																				
FSV-BE																				
FSV-BF	0.013	0.117	0.011	0.016					0.577	0.450	0.182	0.357					0.032	0.023	0.022	0.066
FSV-BG	0.023	0.114	0.022	0.029					0.526	0.396	0.181	0.312	0.270	0.210	0.101	0.168	0.039	0.037	0.036	0.084
FSV-BGa	0.028	0.087	0.015	0.021					0.561	0.435	0.175	0.327								
FSV-BH	0.011	0.101	0.016	0.011					0.521	0.434	0.183	0.322					0.053	0.046	0.042	0.091
FSV-BI	0.013	0.098	0.015	0.018					0.469	0.371	0.162	0.286					0.043	0.035	0.042	0.093
FSV-BJ	nq	0.120	nq	nq					0.547	0.454	0.191	0.342					0.042	0.030	0.036	0.095
FSV-BK																				
FSV-BL																				
FSV-BM																				
FSV-BN	0.004	0.086	0.009	0.007					0.528	0.409	0.200	0.328	0.255	0.199	0.098	0.159	0.025	0.016	0.019	0.075
FSV-BO	0.014	0.132	0.017	0.019					0.789	0.634	0.258	0.478					0.031	0.024	0.027	0.065
FSV-BP																				
FSV-BQ																				
FSV-BR																				
FSV-BS	0.045	0.078	0.043	0.040					0.417	0.382	0.293	0.300	0.127	0.119	0.067	0.087	0.028	0.026	0.030	0.049
FSV-BT	0.011	0.070	0.010	0.015					0.368	0.284	0.125	0.238	0.302	0.227	0.106	0.194	0.066	0.057	0.044	0.095
FSV-BU	0.014	0.088	0.016	0.023					0.293	0.256	0.071	0.249					0.012	0.011	0.017	0.070
FSV-BV	0.008	0.080	0.009	0.011					0.467	0.383	0.161	0.306					0.021	0.014	0.016	0.053
FSV-BW	0.012	0.107	0.013	0.015					0.570	0.438	0.173	0.290								
FSV-BX	0.023	0.096	0.024	0.028									0.228	0.207	0.108	0.166	0.031	0.030	0.028	0.070
FSV-BZ	0.020	0.044	0.023	0.022									0.370	0.370	0.230	0.300				
FSV-CB	0.011	0.099	0.012	0.013					0.499	0.414	0.177	0.310					0.030	0.024	0.024	0.062
FSV-CC																				
FSV-CD	0.007	0.150	0.014	0.018					0.435	0.383	0.172	0.270					0.029	0.027	0.024	0.051
FSV-CE																				
FSV-CF																				
FSV-CG	0.015	0.112	0.015	0.016					0.535	0.448	0.189	0.323	0.259	0.218	0.101	0.161	0.043	0.037	0.029	0.067
FSV-CH	0.021	0.092	0.021	0.015					0.406	0.312	0.150	0.244								
FSV-CI																				
FSV-CK	0.252	0.123	0.027	0.021					0.472	0.370	0.150	0.188					0.039	0.036	0.032	0.023
FSV-CL	0.014	0.146	0.017	0.016					0.547	0.460	0.183	0.314					0.033	0.028	0.029	0.066
FSV-CN	0.011	0.097	0.011	0.018					0.555	0.480	0.211	0.415					0.042	0.034	0.036	0.086
FSV-CR																				
FSV-CS	0.013	0.120	0.014	0.018					0.494	0.397	0.180	0.330					0.044	0.034	0.033	0.082
FSV-CT													0.265	0.269	0.127	0.164	0.048	0.048	0.039	0.080
FSV-CV									0.318	0.596	0.271	0.363								
FSV-CX	>0.02	>0.08	>0.01	>0.02	0.020	0.080	0.010	0.020					0.200	0.180	0.090	0.140	0.040	0.030	0.030	0.070
FSV-DB									0.591	0.470	0.202	0.368					0.038	0.030	0.034	0.081
FSV-DD																				
FSV-DF																				
FSV-DH	0.017	0.108	0.019	0.019									0.170	0.122	0.061	0.098				
FSV-DK	0.009	0.100	0.017	0.019																
FSV-DP																				
FSV-DR																				
FSV-DU																				
FSV-EH	0.007	0.143	0.010	0.007					0.744	0.634	0.270	0.525	0.364	0.304	0.138	0.261	0.038	0.033	0.029	0.068
FSV-EM	0.013	0.085	0.014	0.011					0.373	0.327	0.177	0.256					0.033	0.028	0.031	0.070
FSV-EQ	0.015	0.107	0.016	0.015					0.529	0.409	0.174	0.276					0.064	0.037	0.028	0.096
FSV-ES	>0.012	>0.104	>0.014	>0.018	0.012	0.104	0.014	0.018	0.309	0.290	0.120	0.229	0.192	0.178	0.082	0.143	0.029	0.027	0.029	0.066
FSV-FG																				
N	29	30	29	29	2	2	2	2	28	28	28	28	14	14	14	14	28	28	28	28
Min	0.004	0.044	0.009	0.007	0.012	0.080	0.010	0.018	0.293	0.256	0.071	0.188	0.127	0.119	0.061	0.087	0.012	0.011	0.016	0.023
Median	0.013	0.099	0.015	0.016	0.016	0.092	0.012	0.019	0.510	0.409	0.181	0.311	0.257	0.209	0.101	0.162	0.038	0.030	0.030	0.070
Max	0.252	0.150	0.043	0.040	0.020	0.104	0.014	0.020	0.789	0.634	0.293	0.525	0.370	0.370	0.230	0.300	0.066	0.057	0.044	0.096
eSD	0.005	0.022	0.004	0.004					0.088	0.053	0.018	0.043	0.058	0.042	0.016	0.027	0.009	0.007	0.005	0.014
eCV	37	22	29	27					17	13	10	14	22	20	16	17	24	23	17	19
N _{past}	23	26	17	26	0	0	0	0	28	25	18	25	13	12	0	12	23	27	10	27
Median _{past}	0.013	0.091	0.014	0.016					0.499	0.398	0.170	0.314	0.262	0.203	0.152	0.047	0.032	0.047	0.078	
SD _{past}	0.005	0.024	0.004	0.004					0.112	0.094	0.046	0.075	0.053	0.040	0.034	0.010	0.008	0.016	0.009	
NISTa	>0.031	>0.116	>0.021	>0.022	0.031	0.116	0.021	0.022	0.560	0.448	0.199	0.316	0.172	0.145	0.077	0.105	0.038	0.034	0.029	0.066
NISTb	>0.015	>0.085	>0.014	>0.013	0.015	0.085	0.014	0.013	0.560	0.448	0.199	0.316	0.172	0.145	0.077	0.105	0.035	0.026	0.030	0.066
N _{NIST}	6	6	6	6	6	6	6	6	3	3	3	3	3	3	3	3	6	6	6	6
Mean _{NIST}	0.023	0.101	0.018	0.017	0.023	0.101	0.018	0.017	0.562	0.448	0.198	0.313	0.173	0.145	0.077	0.105	0.037	0.030	0.030	0.065
S _{rep}	0.003	0.005	0.002	0.004	0.003	0.005	0.002	0.004	0.006	0.016	0.016	0.025	0.005	0.003	0.004	0.007	0.002	0.002	0.004	0.005
S _{het}	0.004	0.002	0.001	0.003	0.004	0.002	0.001	0.003	0.017	0.025	0.031	0.016	0.001	0.004	0.004	0.003	0.002	0.003	0.004	0.003
S _{ant}	0.012	0.022	0.005	0.007	0.012	0.022	0.005	0.007									0.001	0.006	0.001	0.000
S _{NIST}	0.014	0.023	0.006	0.008	0.014	0.023	0.006	0.008	0.018	0.030	0.035	0.030	0.005	0.005	0.006	0.007	0.003	0.007	0.005	0.006
NAV	0.018	0.100	0.016	0.017					0.536	0.428	0.189	0.312	0.215	0.177	0.089	0.134	0.037	0.030	0.030	0.068
NAU	0.015	0.028	0.006	0.008					0.111	0.092	0.047	0.070	0.083	0.062	0.024	0.050	0.010	0.008	0.008	0.017

Round Robin XLVI Laboratory Results

All values in µg/mL

Lab	Total α-Cryptoxanthin				Total Lutein				Total Zeaxanthin				Total Lutein&Zeaxanthin				Coenzyme Q10								
	255	256	257	258	255	256	257	258	255	256	257	258	255	256	257	258	255	256	257	258					
FSV-BA	0.009	0.013	0.014	0.028												0.096	0.116	0.073	0.101						
FSV-BB	0.016	0.016	0.016	0.016	0.075	0.101	0.054	0.058	0.042	0.036	0.027	0.041	0.117	0.137	0.081	0.099									
FSV-BD																									
FSV-BE																									
FSV-BF																									
FSV-BG					0.072	0.071	0.044	0.060	0.014	0.022	0.010	0.011	0.094	0.107	0.061	0.077									
FSV-BGa																									
FSV-BH					0.060	0.087	0.049	0.052	0.032	0.026	0.028	0.038	0.092	0.113	0.077	0.090									
FSV-BI					0.062	0.091	0.047	0.067	0.022	0.018	0.019	0.040	0.084	0.109	0.066	0.107									
FSV-BJ																									
FSV-BK																									
FSV-BL																									
FSV-BM																									
FSV-BN					0.040	0.057	0.026	0.041	0.049	0.031	0.018	0.037	0.091	0.093	0.047	0.080									
FSV-BO					0.062	0.084	0.043	0.052	0.026	0.024	0.026	0.038	0.088	0.108	0.068	0.089									
FSV-BP																									
FSV-BQ																									
FSV-BR																									
FSV-BS													0.054	0.077	0.059	0.091									
FSV-BT	0.023	0.023	0.017	0.024	0.072	0.084	0.070	0.103	0.026	0.028	0.019	0.045	0.098	0.112	0.089	0.148									
FSV-BU													0.056	0.080	0.075	0.106									
FSV-BV													0.075	0.100	0.064	0.090									
FSV-BW																									
FSV-BX					0.041	0.069	0.043	0.044	0.028	0.027	0.024	0.030	0.069	0.096	0.067	0.075									
FSV-BZ					0.062	0.086	0.057	0.071																	
FSV-CB					0.063	0.098	0.048	0.058	0.028	0.027	0.025	0.034	0.091	0.125	0.073	0.093									
FSV-CC																									
FSV-CD	0.011	0.009	0.011	0.010									0.081	0.112	0.068	0.095									
FSV-CE																									
FSV-CF																									
FSV-CG													0.100	0.129	0.082	0.118									
FSV-CH																									
FSV-CI																									
FSV-CK													0.097	0.135	0.092	0.133									
FSV-CL	0.045	0.043	0.024	0.034									0.075	0.106	0.076	0.091									
FSV-CN													0.092	0.110	0.078	0.117									
FSV-CR																									
FSV-CS													0.095	0.119	0.081	0.116									
FSV-CT					0.120	0.159	0.091	0.128	0.087	0.071	0.049	0.086	0.207	0.230	0.140	0.214									
FSV-CV					0.041	0.097	0.060	0.062																	
FSV-CX					0.050	0.060	0.040	0.040	0.020	0.020	0.020	0.030	0.070	0.080	0.060	0.070	0.180	0.403	0.438	0.213					
FSV-DB													0.088	0.106	0.070	0.096									
FSV-DD																									
FSV-DF																									
FSV-DH					0.052	0.063	0.042	0.020	0.021	0.017	0.021	0.029	0.073	0.080	0.063	0.049									
FSV-DK																									
FSV-DP																									
FSV-DR																									
FSV-DU																									
FSV-EH					0.060	0.084	0.053	0.055	0.027	0.019	0.024	0.035	0.087	0.103	0.077	0.090									
FSV-EM													0.078	0.114	0.076	0.098									
FSV-EQ													0.129	0.135	0.062	0.117									
FSV-ES					0.052	0.069	0.039	0.043	0.024	0.021	0.021	0.030	0.077	0.090	0.060	0.072									
FSV-FG																									
N	5	5	5	5	16	16	16	16	14	14	14	14	29	29	29	29	2	2	2	2					
Min	0.009	0.009	0.011	0.010	0.040	0.057	0.026	0.020	0.014	0.017	0.010	0.011	0.054	0.077	0.047	0.049	0.180	0.403	0.438	0.213					
Median	0.016	0.016	0.016	0.024	0.061	0.084	0.047	0.057	0.027	0.025	0.023	0.036	0.088	0.109	0.072	0.095	0.591	0.776	0.864	0.494					
Max	0.045	0.043	0.024	0.034	0.120	0.159	0.091	0.128	0.087	0.071	0.049	0.086	0.207	0.230	0.140	0.214	1.002	1.148	1.289	0.774					
eSD	0.009	0.007	0.002	0.009	0.010	0.017	0.009	0.014	0.006	0.006	0.005	0.007	0.016	0.017	0.010	0.013									
eCV	57	45	14	37	17	20	19	25	23	22	20	19	18	16	14	14									
N _{past}	6	6	0	6	16	16	12	17	11	15	10	16	19	24	8	23	0	0	0	0					
Median _{past}	0.022	0.019		0.020	0.067	0.085	0.053	0.055	0.027	0.024	0.028	0.032	0.090	0.112	0.074	0.095									
SD _{past}	0.008	0.006		0.004	0.034	0.015	0.013	0.019	0.008	0.009	0.014	0.009	0.020	0.035	0.008	0.020									
NISTa					0.068	0.091	0.055	0.059	0.017	0.018	0.014	0.020	0.086	0.109	0.070	0.079									
NISTb					>0.056	>0.076	>0.045	>0.052	0.027	0.020	0.025	0.033	>0.083	>0.095	>0.071	>0.085									
N _{NIST}					6	6	6	6	6	6	6	6	6	6	6	6									
Mean _{NIST}					0.062	0.083	0.050	0.056	0.021	0.019	0.020	0.026	0.083	0.102	0.070	0.082									
S _{rep}					0.003	0.003	0.003	0.004	0.002	0.003	0.002	0.005	0.005	0.005	0.004	0.009									
S _{het}					0.003	0.002	0.002	0.001	0.003	0.001	0.002	0.003	0.006	0.003	0.003	0.003									
S _{and}					0.009	0.011	0.007	0.005	0.007	0.002	0.007	0.009	0.002	0.010	0.000	0.004									
S _{NIST}					0.010	0.012	0.008	0.006	0.008	0.003	0.008	0.011	0.008	0.011	0.005	0.010									
NAV					0.061	0.084	0.049	0.056	0.024	0.022	0.021	0.031	0.086	0.106	0.071	0.088									
NAU					0.013	0.017	0.010	0.014	0.009	0.008	0.008	0.013	0.019	0.023	0.015	0.022									

Round Robin XLVI Laboratory Results

All Values in µg/mL

Analytes Reported By One Laboratory

Analyte	Code	255	256	257	258
9-cis-β-Carotene	FSV-DH	0.013	0.008	0.006	0.004
13-cis-β-Carotene	FSV-DH	0.029	0.022	0.022	0.013
9-cis-Lycopene	FSV-DH	0.032	0.021	0.007	0.020
13-cis-Lycopene	FSV-DH	0.040	0.031	0.012	0.026
15-cis-Lycopene	FSV-DH	0.004	0.003	0.001	0.002
Total cis-β-Cryptoxanthin	FSV-BT	0.018	0.017	0.009	0.021
Total Cryptoxanthin	FSV-DH	0.043	0.033	0.039	0.088
trans-Lutein	NISTa	0.056	0.076	0.045	0.052
Total anhydro-Lutein	FSV-BT	0.038	0.038	0.024	0.032
Phytoene	FSV-CL	<i>nd</i>	0.163	0.180	<i>nd</i>
Phytofluene	FSV-CL	0.085	0.068	0.123	0.052

Legend

Term	Definition
N	Number of (non-NIST) quantitative values reported for this analyte
Min	Minimum (non-NIST) quantitative value reported
Median	Median (non-NIST) quantitative value reported
Max	Maximum (non-NIST) quantitative value reported
eSD	Standard deviation for (non-NIST) results: $0.741 \times (\text{3rd Quartile} - \text{1st Quartile})$
eCV	Coefficient of Variation for (non-NIST) results: $100 \times \text{eSD} / \text{Median}$
N_{past}	Mean of N(s) from past RR(s)
$\text{Median}_{\text{past}}$	Mean of Median(s) from past RR(s)
SD_{past}	Pooled SD from past RR(s)
N_{NIST}	Number of vials analyzed in duplicate by NIST analyst(s)
$\text{Mean}_{\text{NIST}}$	Mean of the NIST-analyzed vial means
S_{rep}	Within-vial pooled standard deviation
S_{het}	Among-vial pooled standard deviation
S_{anl}	Between NIST analyst standard deviation
S_{NIST}	Total standard deviation for NIST analyses: $(S_{\text{rep}}^2 + S_{\text{het}}^2 + S_{\text{anl}}^2)^{0.5}$
NAV	NIST Assigned Value = (Median + Mean)/2 for analytes reported by NIST analyst(s) = Median for analytes reported by ≥ 10 labs but not NIST
NAU	NIST Assigned Uncertainty: $(S^2 + S_{\text{btw}}^2)^{0.5}$ S is the maximum of (0.05*NAV, SD, S_{NIST} , eSD) and S_{btw} is the standard deviation between Median and Mean. The expected long-term SD, eSD, is defined in: Duewer, et al. Anal Chem 1997;69(7):1406-1413.
<i>nd</i>	Not detected (i.e., no detectable peak for analyte)
<i>nq</i>	Detected but not quantitatively determined
<x	Concentration below the limit of quantification, x
>x	Concentration greater than x
<i>italics</i>	Not explicitly reported but calculated by NIST from reported values

Round Robin XLVI Laboratory Results

Comparability Summary

Lab	TR	aT	gT	bC	tbC	aC	Ly	bX	Label	Definition
FSV-BA	1	1	1	1	1	1	1	2	Lab	laboratory number
FSV-BB	2	1	1	1	1	2	1	1	TR	"Standard Score" for Total Retinol
FSV-BD	1	1				1	1		aT	"Standard Score" for α -Tocopherol
FSV-BE	1	1	1	2					gT	"Standard Score" for γ -Tocopherol
FSV-BF	1	1	1	1		1			bC	"Standard Score" for Total β -Carotene
FSV-BG	1	1	1	2		1	1	2	tbC	"Standard Score" for trans- β -Carotene
FSV-BGa	1	1	2	1					aC	"Standard Score" for Total α -Carotene
FSV-BH	2	1	2	1	1	1		1	Ly	"Standard Score" for Total Lycopene
FSV-BI	1	1	1	1		1	1	1	bX	"Standard Score" for β -Cryptoxanthin
FSV-BJ	1	1	1	2		1	1	2	n	number of laboratories providing data for this analyte
FSV-BK		1				4	2	3		
FSV-BL	2	1				2		1		"Standard Score"
FSV-BM	1	1				2				Given that our knowledge of the shape, location, and width of the measurement distributions is approximate and that a limited number of labs are involved, we summarize comparability with the following four-level "Standard Score" (StS)...
FSV-BN	1	1	1	1	1					
FSV-BO	1	1		1	2	1	1	2		
FSV-BP	2	1								
FSV-BQ	2	2					2			
FSV-BS	4			3		1	2			
FSV-BT	4	4	3	2	3	2	1	1		
FSV-BU	1	3	3	2				1		
FSV-BV	4	2	1	2		1	1	1		
FSV-BW	2	1	1	1						
FSV-BX	1	1	1		1	2	1	2		
FSV-BZ		3	4	2	2	4	3	2		
FSV-CB	1	2		2				3		
FSV-CC	2	1				2	3	1		
FSV-CD	1	1	1	1		2	2	4		
FSV-CE	1	1		1						
FSV-CF	1	2				1	1	1		
FSV-CG	2	1	2	2	1					
FSV-CH	2	2	2	1						
FSV-CI	4	4	3			2	1	1		
FSV-CK	3	2	3	3		1				
FSV-CL	1	4	4	1			1	1		
FSV-CN	2	2	2		2	1	3	3		
FSV-CR	2	2				2	1	2		
FSV-CS	3	2	1	2	1	2	3	1		
FSV-CT	1	3		1		1	2	2		
FSV-CV	4	4	4	4						
FSV-CX		1	1		2	1	1			
FSV-DB	2	1		1						
FSV-DD	1					1	1	1		
FSV-DF	2									
FSV-DH	3	4	4		1					
FSV-DK	2	3	3	1		1	2	1		
FSV-DR	2	2		1						
FSV-DU	4	4		2						
FSV-EH	2	4	3	2	2					
FSV-EM	4	2		2			2	1		
FSV-EQ	2	3		2						
FSV-ES		3			2	1	1	3		
FSV-FG	2	3								
NISTa	1	1	1	1	1			1		
NISTb		1	1		1		1	1		
n	48	49	29	34	15	30	28	28		

StS	Definition
1	All StV within $\pm t(1-0.683, n-1)$ { ± 1 SD }
2	All StV within $\pm t(1-0.954, n-1)$ { ± 2 SD }
3	All StV within $\pm t(1-0.997, n-1)$ { ± 3 SD }
4	At least one StV $> \pm t(1-0.997, n-1)$ { > 3 SD }

where:

StV Standardized Value, the distance in standard deviation units your value is from the "true" concentration: $StV = (your\ value - NAV) / NAU$

NAV NIST Assigned Value, our estimate of the "true" analyte concentration

NAU NIST Assigned Uncertainty, our estimate of the total measurement standard deviation (serum heterogeneity, analytical repeatability, and among-laboratory reproducibility)

$t(1-a, n-1)$ Two-tailed student's t for coverage of ± 1 , ± 2 , and ± 3 NAU about NAV, assuming a normal population of size n

StS	% Observed								Expected
1	42	49	48	50	53	60	61	54	68.2 %
2	38	22	17	41	40	33	25	29	27.2 %
3	6	14	21	6	7	0	14	14	4.3 %
4	15	14	14	3	0	7	0	4	0.3 %

These are the observed and normal-population-expected proportions of each Standard Score (StS), based upon each laboratory's largest StV for the four sera.

Appendix H. Representative “Individualized Report” for RR46

Each participant in RR46 received an “Individualized Report” reflecting their reported results. Each report included a detailed analysis of the results they reported for the following analytes:

- Total Retinol
- Retinyl Palmitate
- α -Tocopherol
- γ -Tocopherol
- Total β -Carotene
- *trans*- β -Carotene
- Total α -Carotene
- Total Lycopene
- *trans*-Lycopene
- Total β -Cryptoxanthin
- Total Lutein
- Total Zeaxanthin
- Total Lutein & Zeaxanthin

The following 12 pages are the “Individualized Report” for the analytes evaluated by participant FSV-BA.

Individualized Round Robin XLVI Report: FSV-BA

Summary

Analyte	Serum 255			Serum 256			Serum 257			Serum 258		
	You	NAV	n	You	NAV	n	You	NAV	n	You	NAV	n
Total Retinol	1.089	0.990	48	0.467	0.480	48	0.504	0.549	46	0.787	0.851	48
Retinyl Palmitate	0.08	0.03	12	0.1	0.1	16	0.2	0.2	16	0.06	0.04	14
α-Tocopherol	28.12	27.99	49	17.89	17.07	49	5.23	5.01	48	7.50	7.51	49
γ-Tocopherol	5.815	6.015	29	1.532	1.549	29	1.955	2.009	29	3.538	3.870	29
Total β-Carotene	0.399	0.367	34	0.488	0.424	34	0.411	0.360	34	0.186	0.170	34
trans-β-Carotene	0.362	0.338	15	0.453	0.415	15	0.382	0.361	15	0.173	0.172	15
Total cis-β-Carotene	0.037	0.030	10	0.034	0.028	10	0.029	0.030	10	0.013	0.013	9
Total α-Carotene	0.008	0.018	29	0.095	0.100	30	0.011	0.016	29	0.010	0.017	29
trans-Lycopene	0.289	0.215	14	0.244	0.177	14	0.114	0.089	14	0.185	0.134	14
Total β-Cryptoxanthin	0.030	0.037	28	0.026	0.030	28	0.030	0.030	28	0.085	0.068	28
Total α-Cryptoxanthin	0.009		5	0.013		5	0.014		5	0.028		5
Total Lutein&Zeaxanthin	0.096	0.086	29	0.116	0.106	29	0.073	0.071	29	0.101	0.088	29

You : Your reported values for the listed analytes (micrograms/milliliter)

NAV : NIST Assigned Values, equal to (NIST's average-of-averages + this RR's median) / 2

n : Number of non-NIST laboratories reporting quantitative values for this analyte in this serum

Please check our records against your records. Send corrections and/or updates to...

Micronutrients Measurement Quality Assurance Program
National Institute of Standards and Technology
100 Bureau Drive Stop 8392
Gaithersburg, MD 20899-8392 USA

Tel: (301) 975-3935
Fax: (301) 977-0685
Email: david.duewer@nist.gov

Individualized RR XLVI Report: FSV-BA

Total Retinol

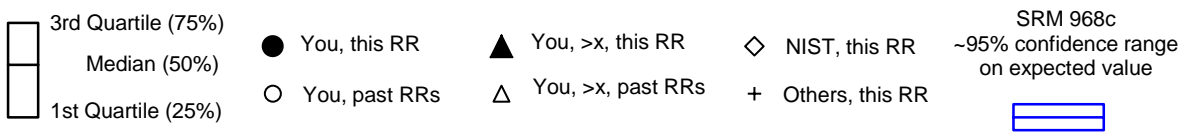
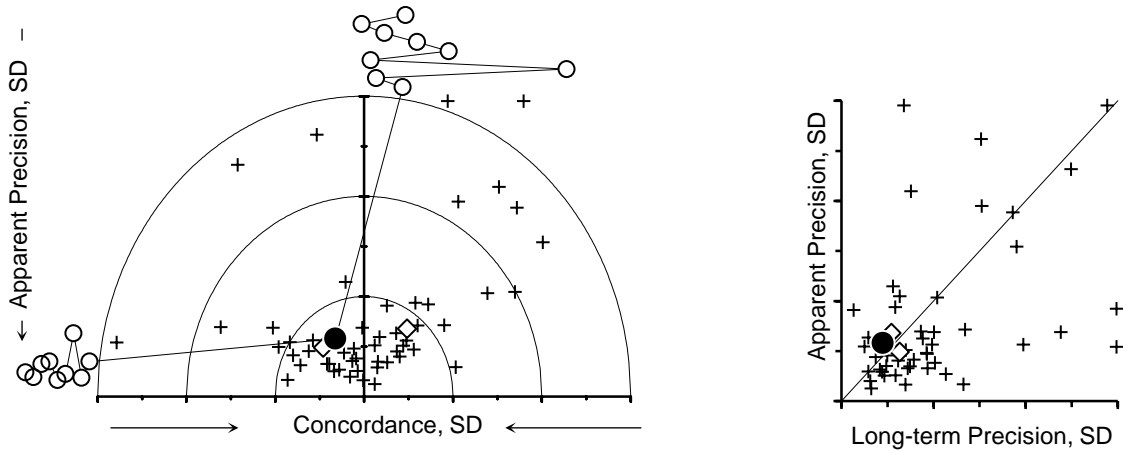
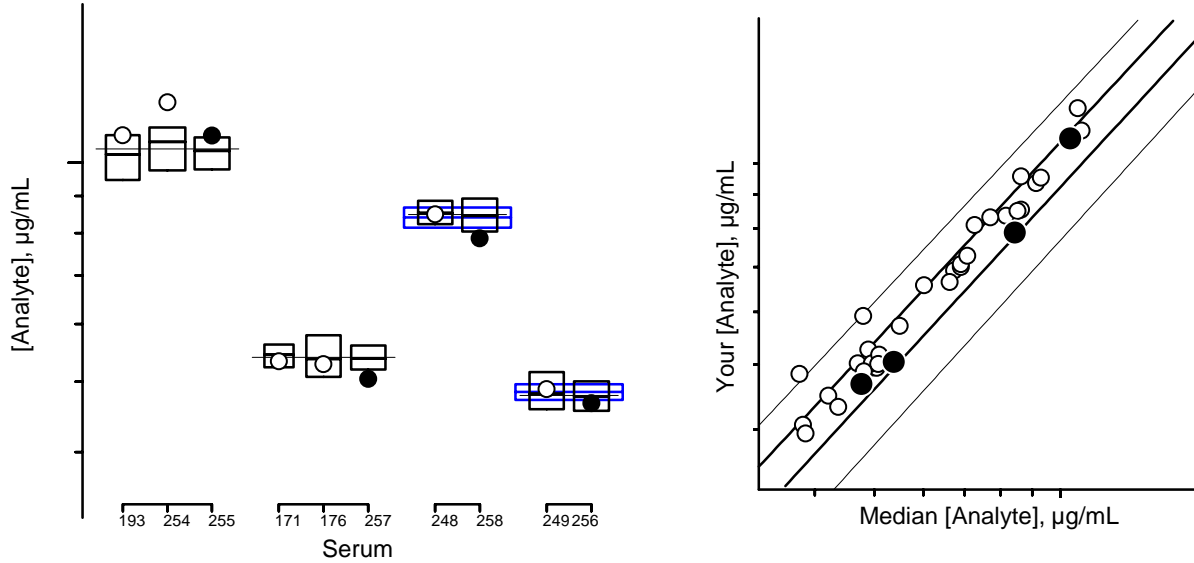

For details of the construction and interpretation of these plots, see:
 Duewer, Kline, Sharpless, Brown Thomas, Gary, Sowell. Anal Chem May 1, 1999.

Serum

#255	#193 in RR30 (3/94), #254 in RR45 (3/99)
#257	#171 in RR26 (10/92), #176 in RR27 (3/93)
#258	#248 in RR44 (9/98)
#256	#249 in RR44 (9/98)

History

Comments

SRM 968c, Level I
 SRM 968c, Level II

Individualized RR XLVI Report: FSV-BA

Retinyl Palmitate

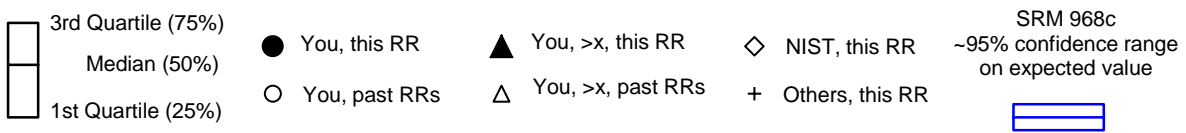
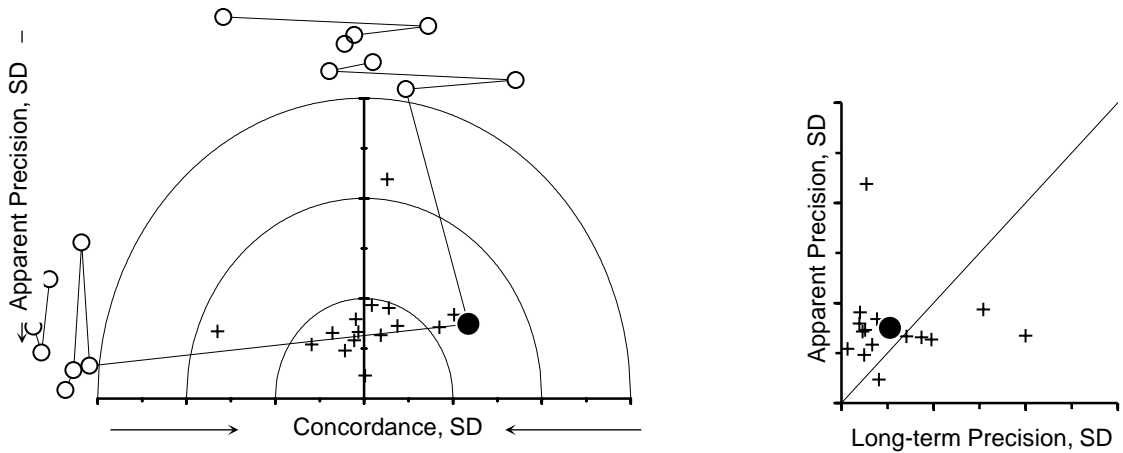
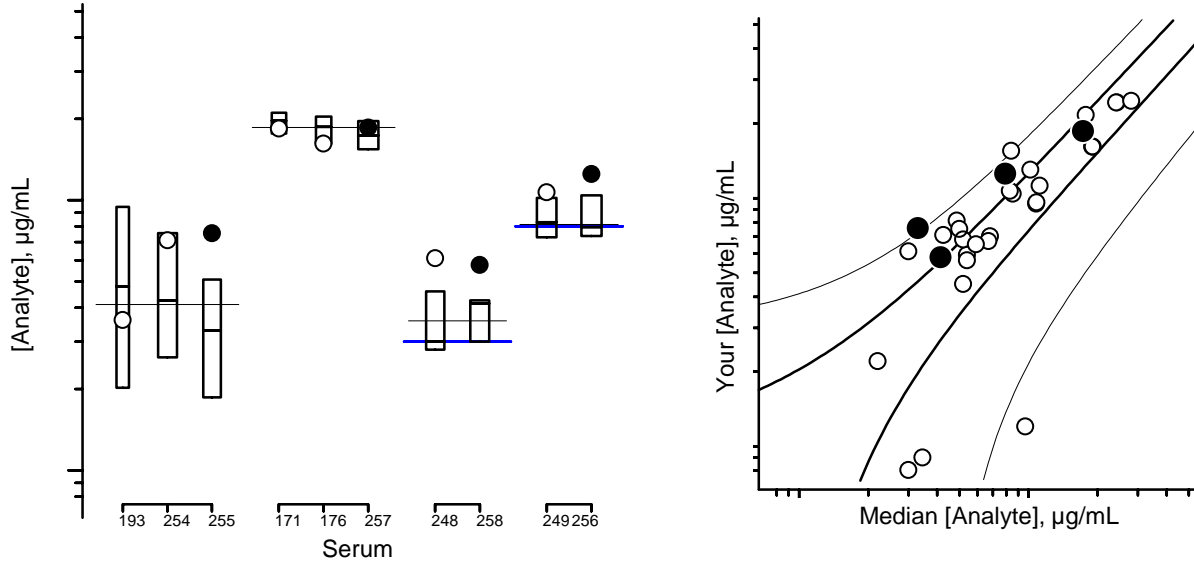

For details of the construction and interpretation of these plots, see:
 Duewer, Kline, Sharpless, Brown Thomas, Gary, Sowell. Anal Chem May 1, 1999.

Serum

#255	#193 in RR30 (3/94), #254 in RR45 (3/99)
#257	#171 in RR26 (10/92), #176 in RR27 (3/93)
#258	#248 in RR44 (9/98)
#256	#249 in RR44 (9/98)

History

Comments

SRM 968c, Level I
 SRM 968c, Level II

Individualized RR XLVI Report: FSV-BA

α -Tocopherol

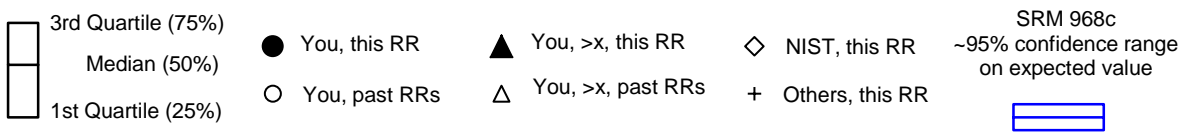
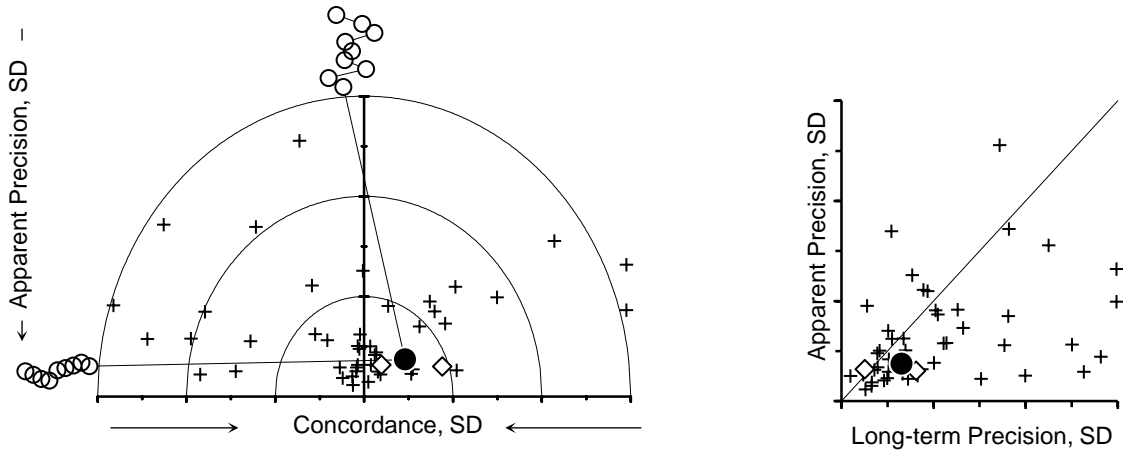
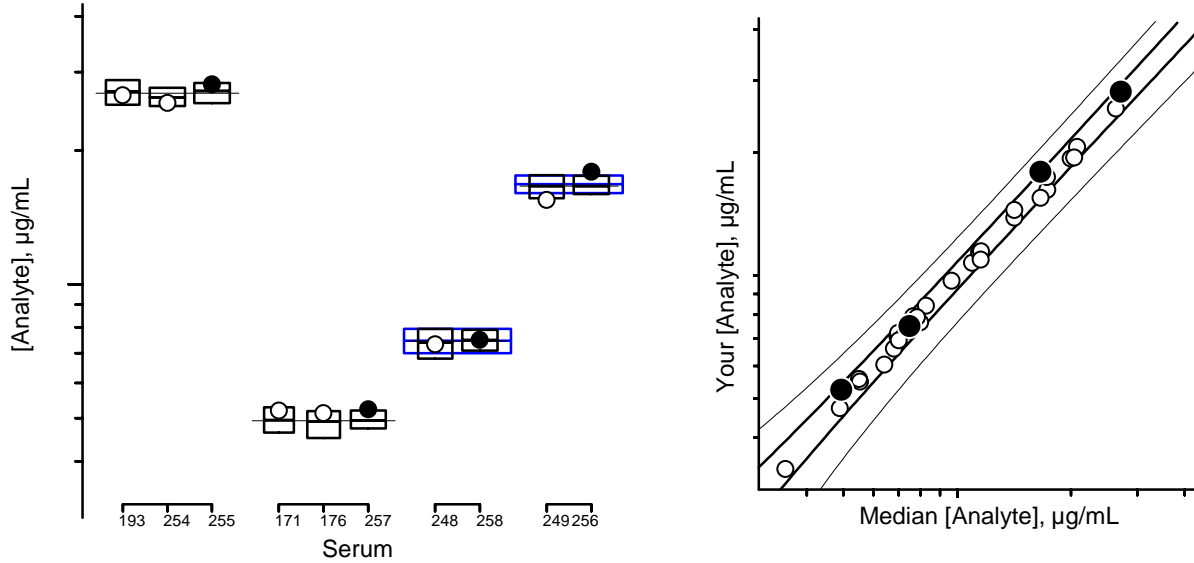

For details of the construction and interpretation of these plots, see:
 Duewer, Kline, Sharpless, Brown Thomas, Gary, Sowell. Anal Chem May 1, 1999.

Serum

#255 #193 in RR30 (3/94), #254 in RR45 (3/99)
 #257 #171 in RR26 (10/92), #176 in RR27 (3/93)
 #258 #248 in RR44 (9/98)
 #256 #249 in RR44 (9/98)

History

Comments

SRM 968c, Level I
 SRM 968c, Level II

Individualized RR XLVI Report: FSV-BA

γ-Tocopherol

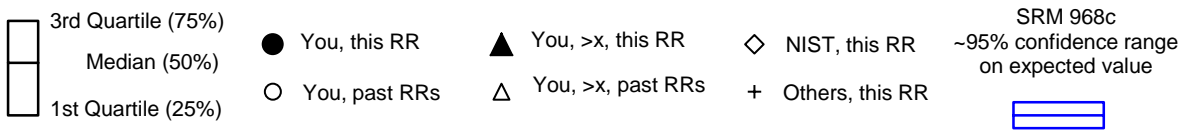
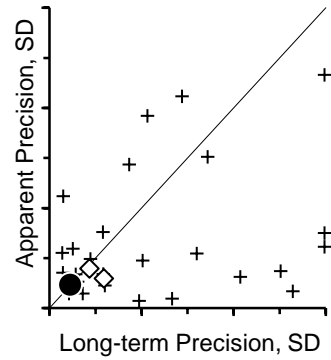
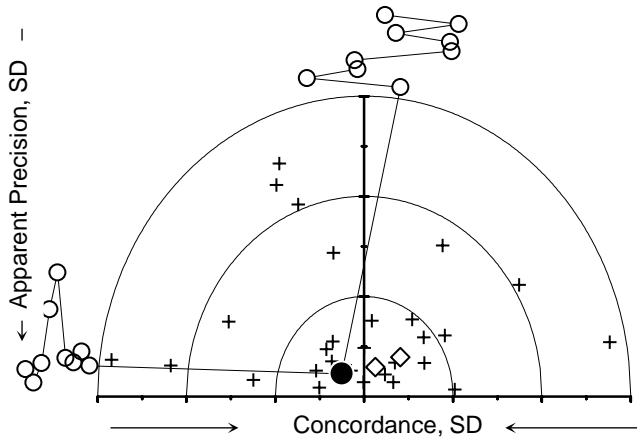
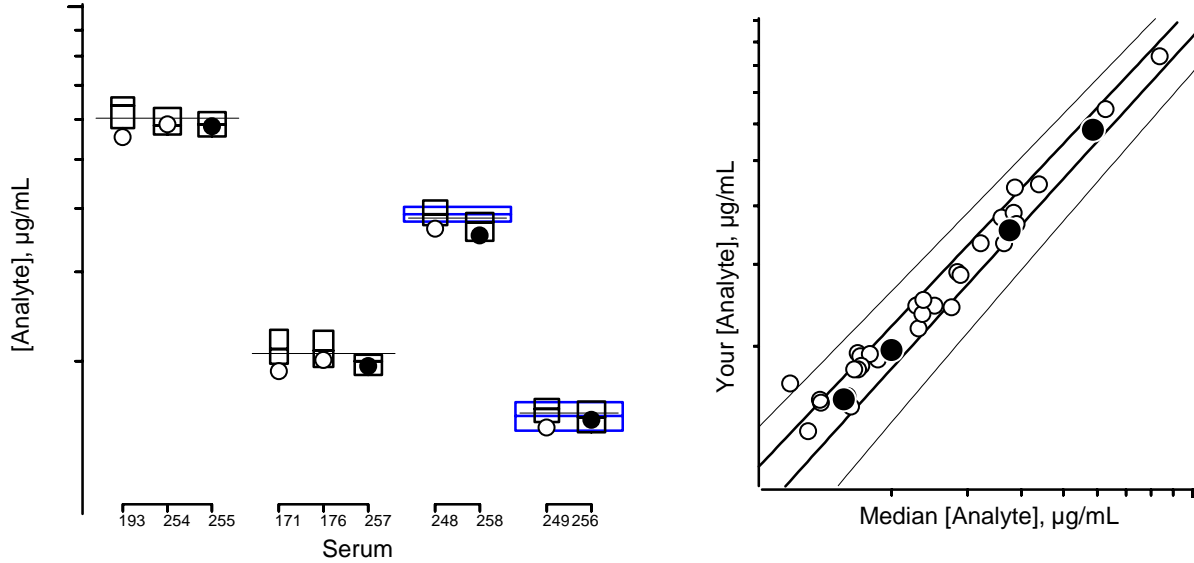

For details of the construction and interpretation of these plots, see:
 Duewer, Kline, Sharpless, Brown Thomas, Gary, Sowell. Anal Chem May 1, 1999.

Serum

#255
 #257
 #258
 #256

History

#193 in RR30 (3/94), #254 in RR45 (3/99)
 #171 in RR26 (10/92), #176 in RR27 (3/93)
 #248 in RR44 (9/98)
 #249 in RR44 (9/98)

Comments

SRM 968c, Level I
 SRM 968c, Level II

Individualized RR XLVI Report: FSV-BA

Total β -Carotene

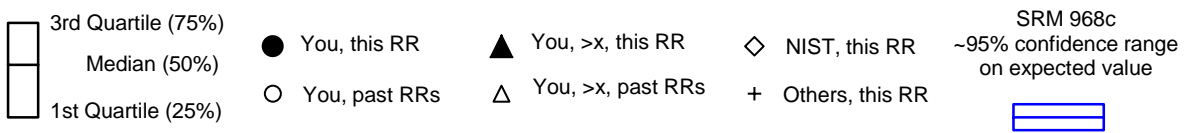
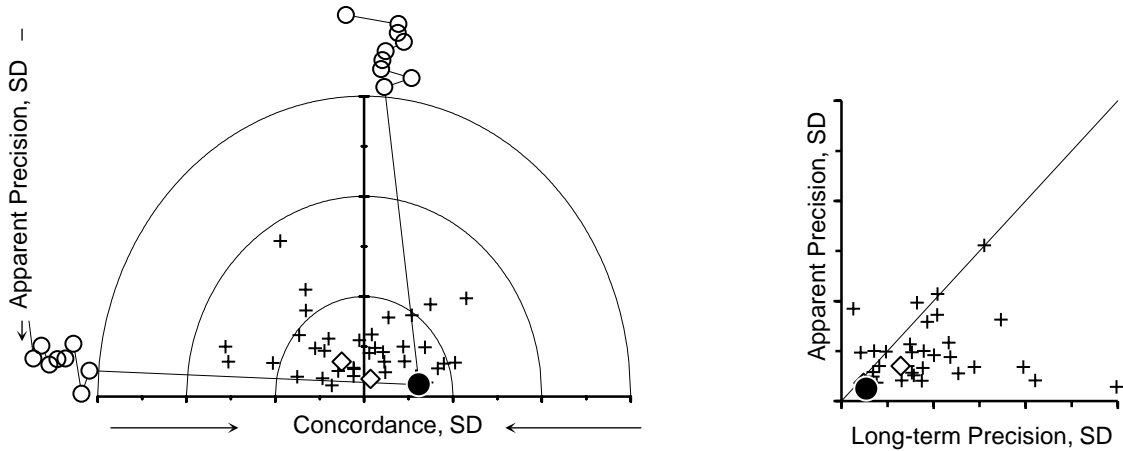
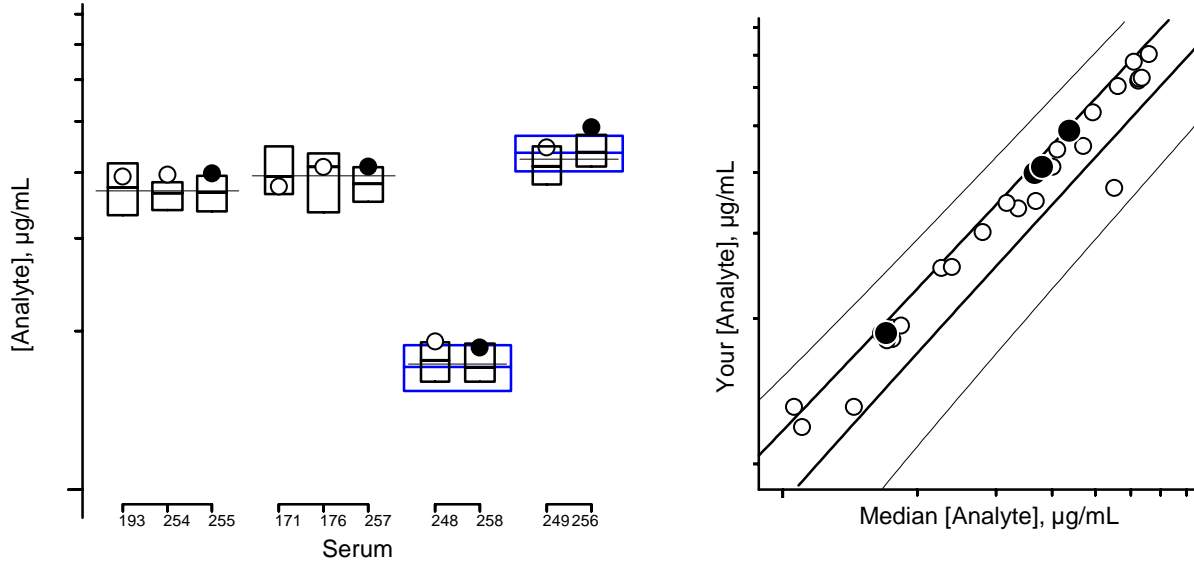

For details of the construction and interpretation of these plots, see:
 Duewer, Kline, Sharpless, Brown Thomas, Gary, Sowell. Anal Chem May 1, 1999.

Serum

#255 #193 in RR30 (3/94), #254 in RR45 (3/99)
 #257 #171 in RR26 (10/92), #176 in RR27 (3/93)
 #258 #248 in RR44 (9/98)
 #256 #249 in RR44 (9/98)

History

Comments

SRM 968c, Level I
 SRM 968c, Level II

Individualized RR XLVI Report: FSV-BA

trans-β-Carotene

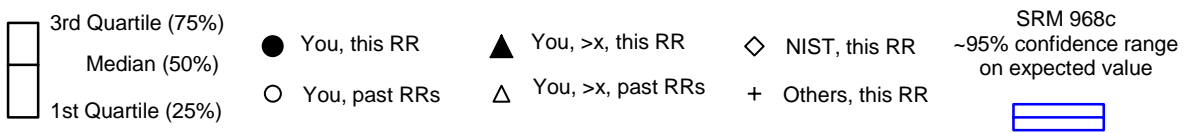
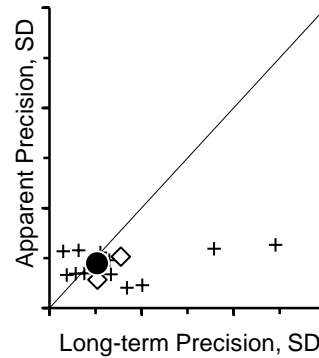
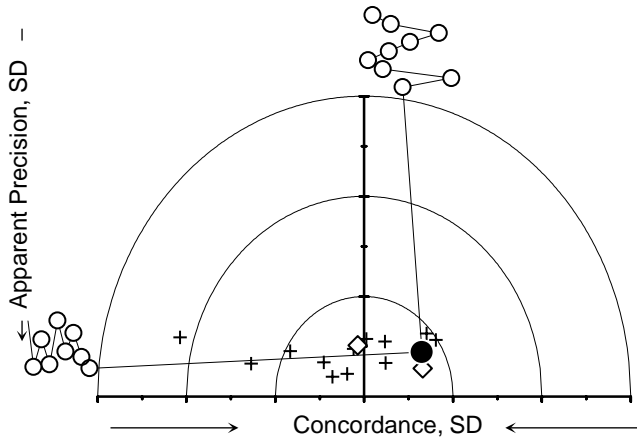
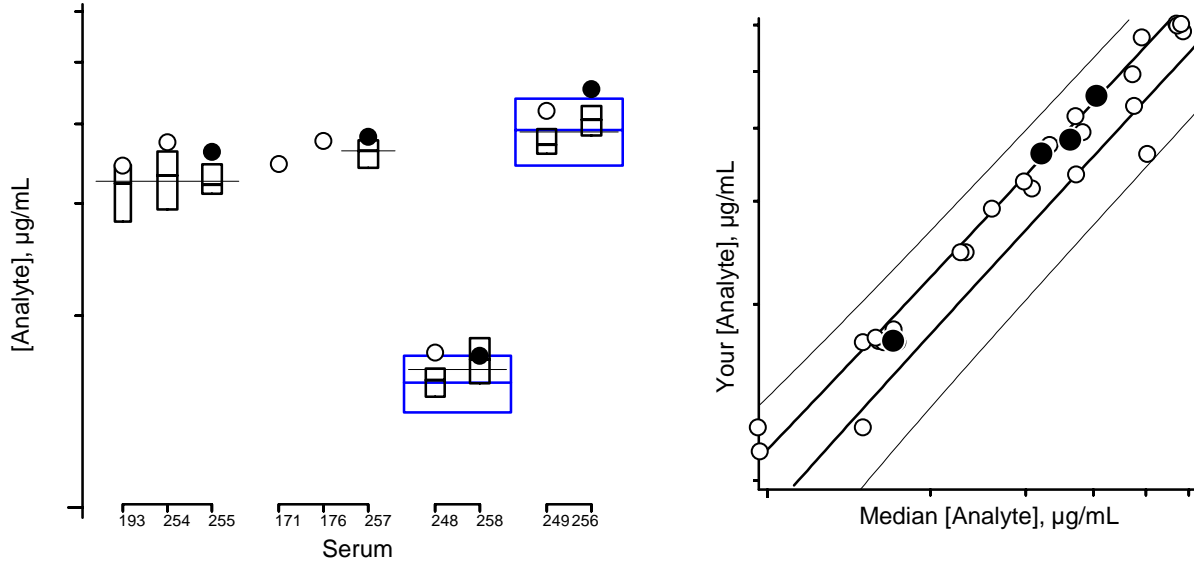

For details of the construction and interpretation of these plots, see:
 Duewer, Kline, Sharpless, Brown Thomas, Gary, Sowell. Anal Chem May 1, 1999.

Serum

#255	#193 in RR30 (3/94), #254 in RR45 (3/99)
#257	#171 in RR26 (10/92), #176 in RR27 (3/93)
#258	#248 in RR44 (9/98)
#256	#249 in RR44 (9/98)

History

Comments

SRM 968c, Level I
 SRM 968c, Level II

Individualized RR XLVI Report: FSV-BA

Total cis-β-Carotene

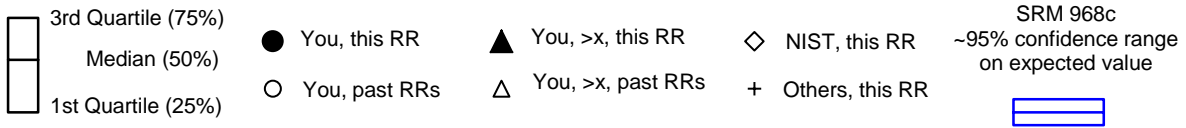
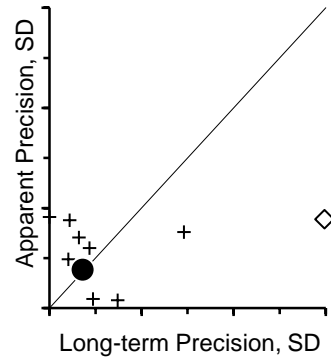
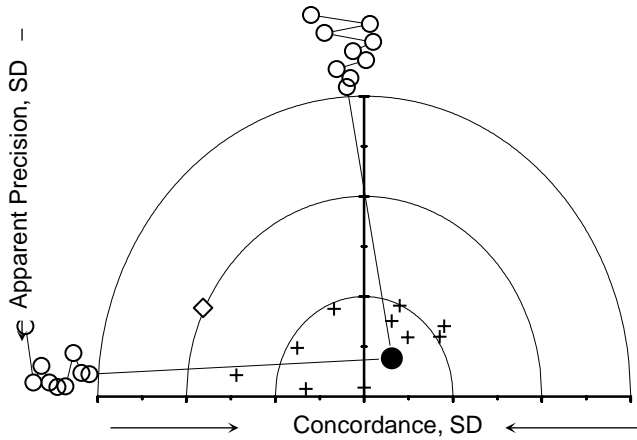
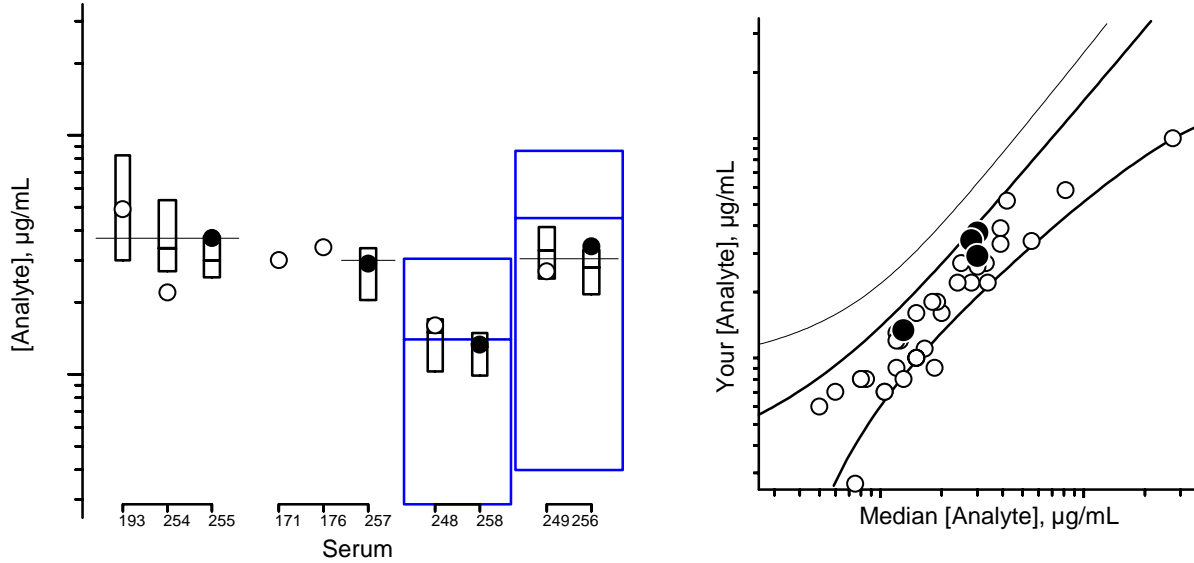

For details of the construction and interpretation of these plots, see:
 Duewer, Kline, Sharpless, Brown Thomas, Gary, Sowell. Anal Chem May 1, 1999.

Serum

#255
 #257
 #258
 #256

History

#193 in RR30 (3/94), #254 in RR45 (3/99)
 #171 in RR26 (10/92), #176 in RR27 (3/93)
 #248 in RR44 (9/98)
 #249 in RR44 (9/98)

Comments

SRM 968c, Level I
 SRM 968c, Level II

Individualized RR XLVI Report: FSV-BA

Total α -Carotene

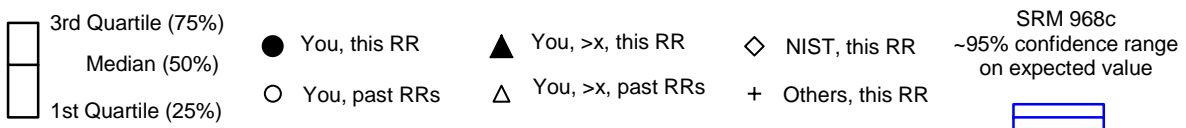
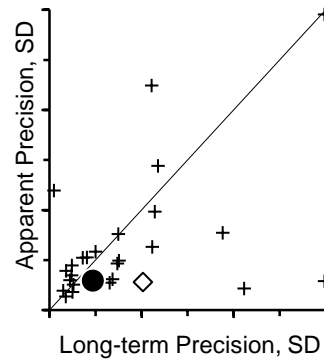
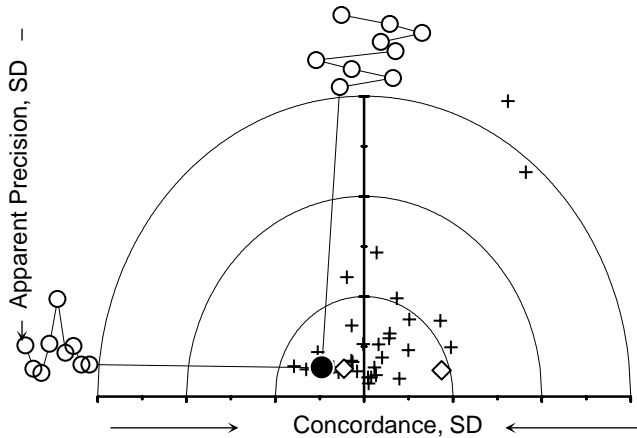
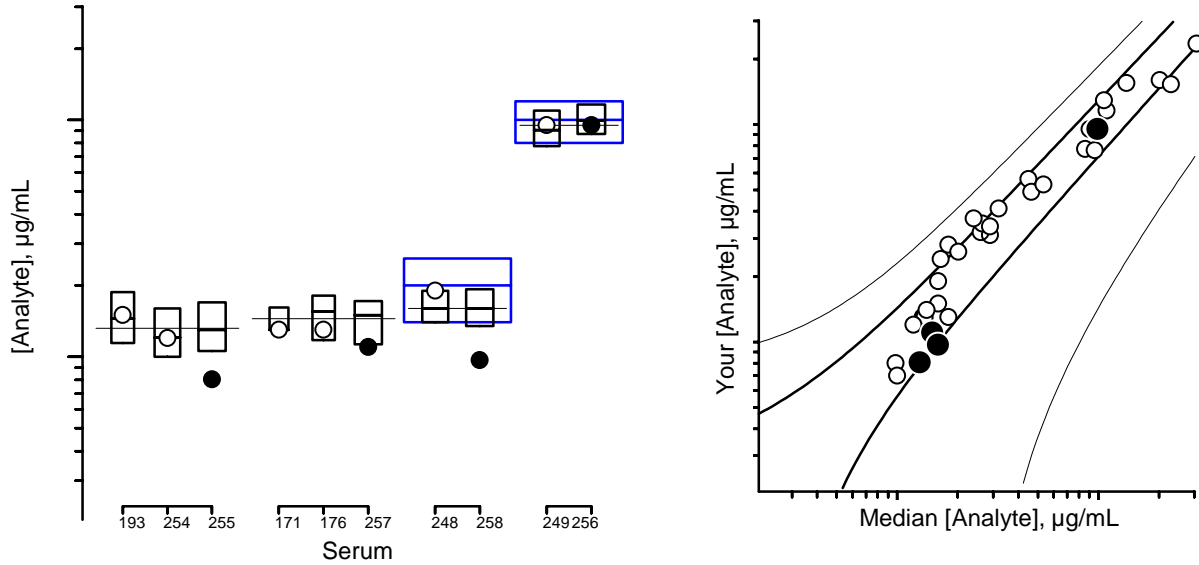

For details of the construction and interpretation of these plots, see:
 Duewer, Kline, Sharpless, Brown Thomas, Gary, Sowell. Anal Chem May 1, 1999.

Serum

#255	#193 in RR30 (3/94), #254 in RR45 (3/99)
#257	#171 in RR26 (10/92), #176 in RR27 (3/93)
#258	#248 in RR44 (9/98)
#256	#249 in RR44 (9/98)

History

Comments

SRM 968c, Level I
 SRM 968c, Level II

Individualized RR XLVI Report: FSV-BA

trans-Lycopene

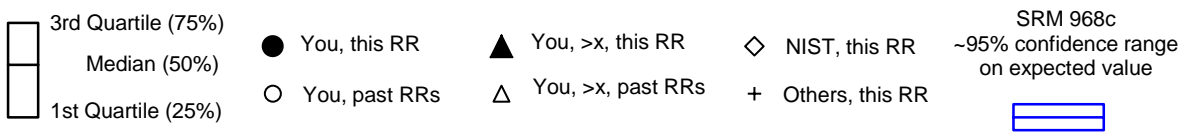
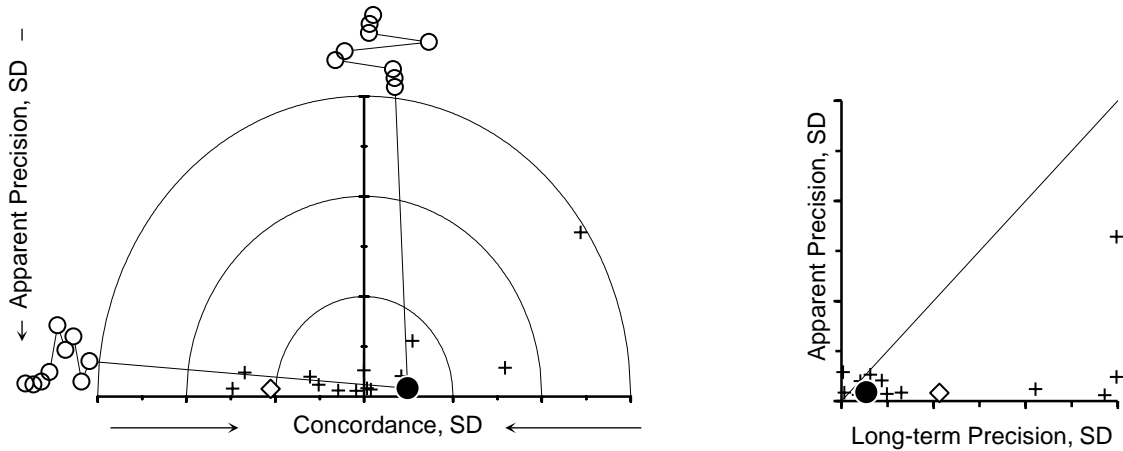
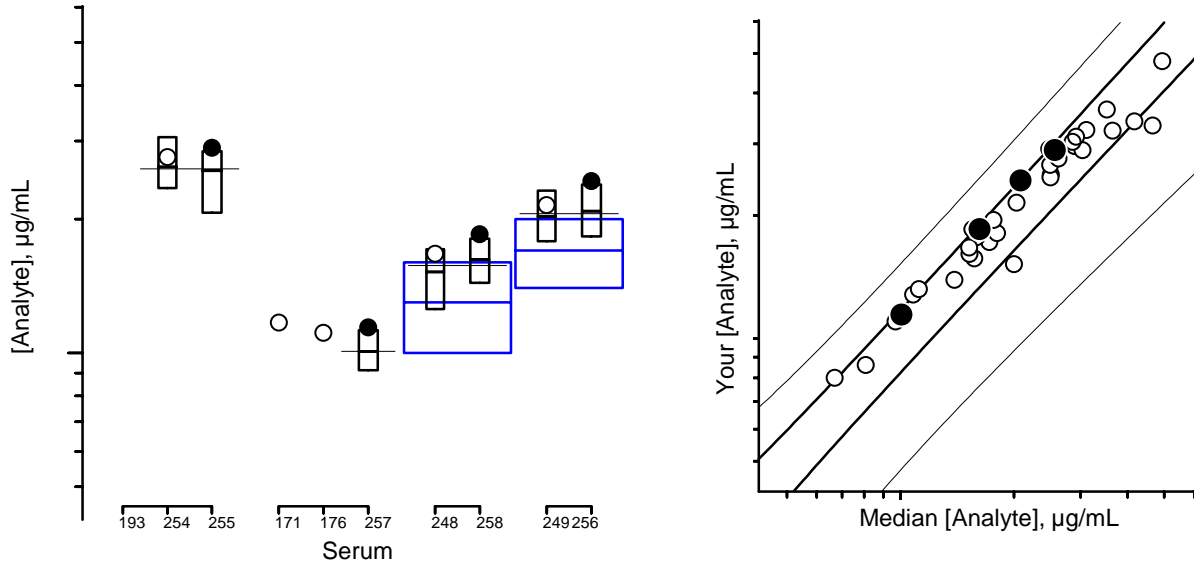

For details of the construction and interpretation of these plots, see:
 Duewer, Kline, Sharpless, Brown Thomas, Gary, Sowell. Anal Chem May 1, 1999.

Serum

#255
 #257
 #258
 #256

History

#193 in RR30 (3/94), #254 in RR45 (3/99)
 #171 in RR26 (10/92), #176 in RR27 (3/93)
 #248 in RR44 (9/98)
 #249 in RR44 (9/98)

Comments

SRM 968c, Level I
 SRM 968c, Level II

Individualized RR XLVI Report: FSV-BA

Total β -Cryptoxanthin

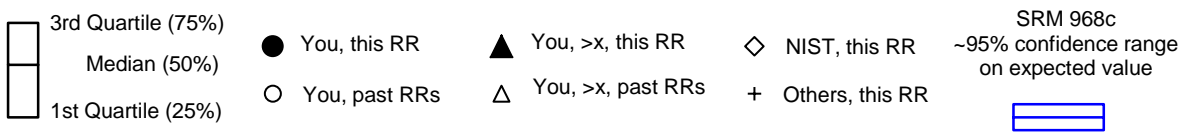
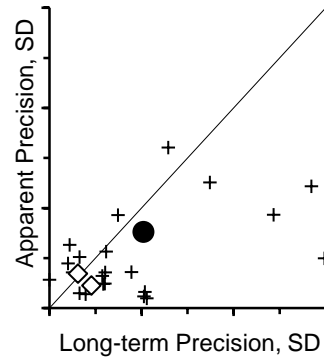
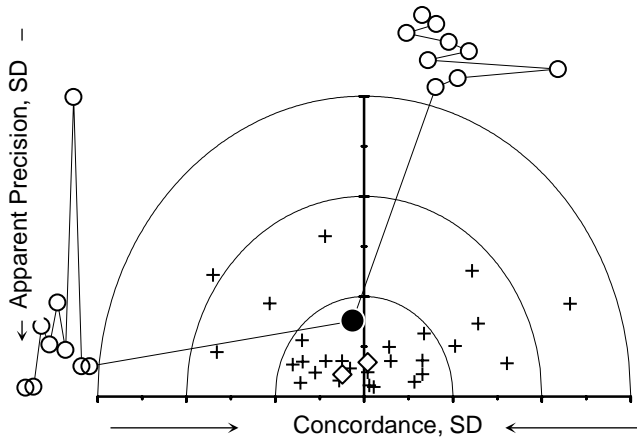
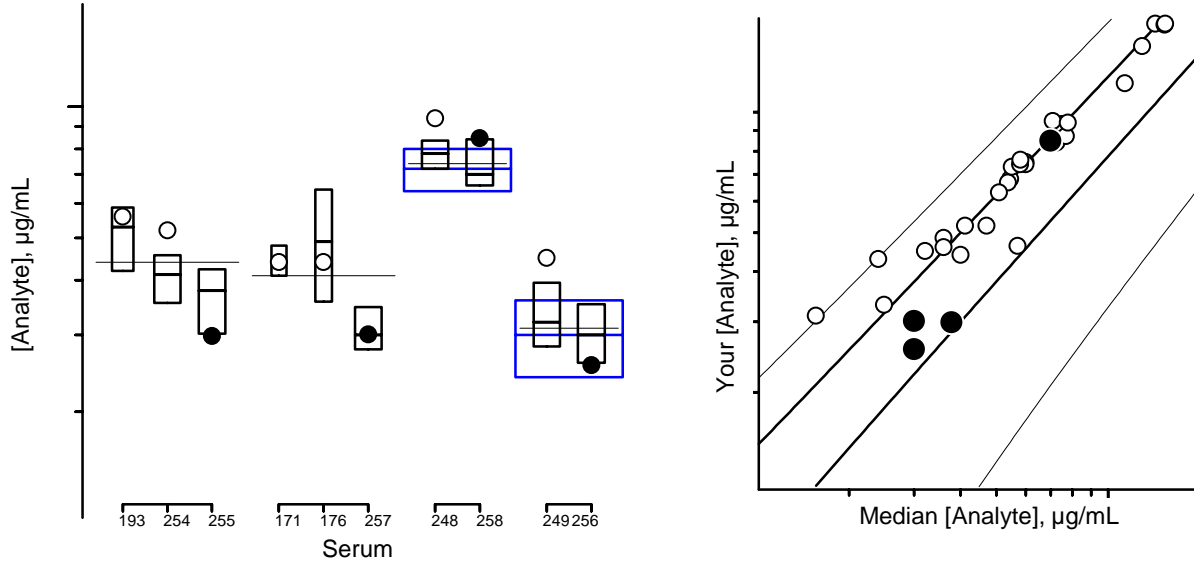

For details of the construction and interpretation of these plots, see:
 Duewer, Kline, Sharpless, Brown Thomas, Gary, Sowell. Anal Chem May 1, 1999.

Serum

#255	#193 in RR30 (3/94), #254 in RR45 (3/99)
#257	#171 in RR26 (10/92), #176 in RR27 (3/93)
#258	#248 in RR44 (9/98)
#256	#249 in RR44 (9/98)

History

Comments

SRM 968c, Level I
 SRM 968c, Level II

Individualized RR XLVI Report: FSV-BA

Total Lutein&Zeaxanthin

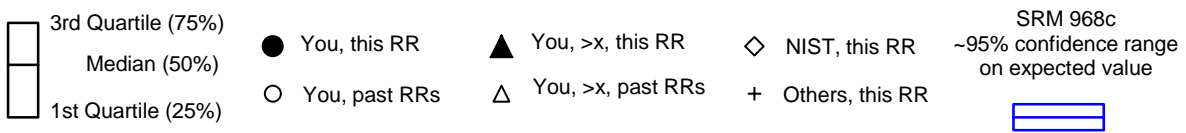
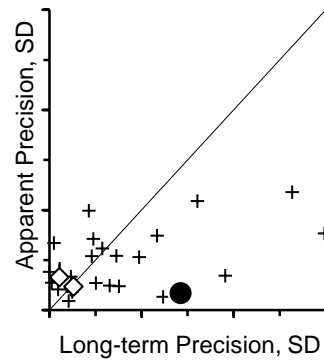
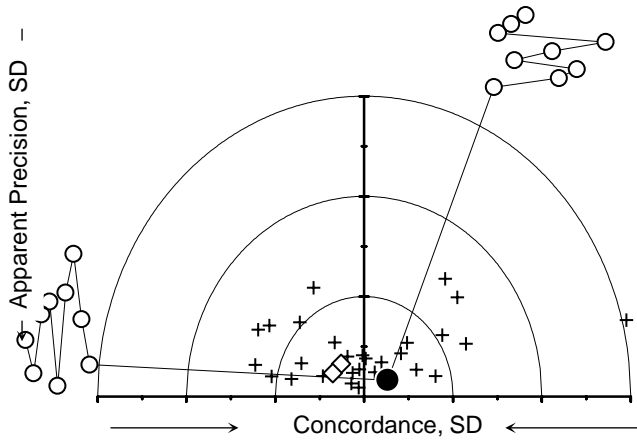
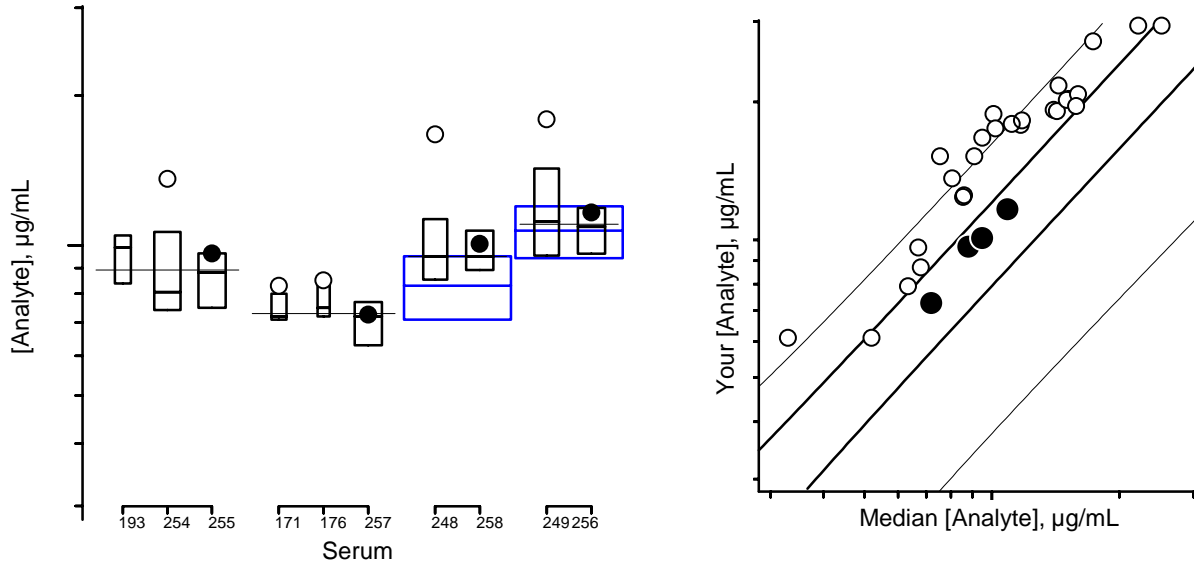

For details of the construction and interpretation of these plots, see:
 Duewer, Kline, Sharpless, Brown Thomas, Gary, Sowell. Anal Chem May 1, 1999.

Serum

#255	#193 in RR30 (3/94), #254 in RR45 (3/99)
#257	#171 in RR26 (10/92), #176 in RR27 (3/93)
#258	#248 in RR44 (9/98)
#256	#249 in RR44 (9/98)

History

Comments

SRM 968c, Level I
 SRM 968c, Level II

Appendix I. Shipping Package Inserts for RR12

The following four items were included in each package shipped to each RR12 participant:

- Cover letter
- Protocol for analyzing samples
- Preparation of Stock Solution and Diluted Solution Datasheet
- Results Datasheet

The cover letter, protocol, and datasheet were enclosed in a sealed waterproof bag along with the samples themselves.



UNITED STATES DEPARTMENT OF COMMERCE
National Institute of Standards and Technology
Gaithersburg, Maryland 20899-

February 19, 1999

Dear Colleague:

For the past 14 years the National Institute of Standards and Technology (NIST) has coordinated a Micronutrients Measurement Quality Assurance (QA) Program for laboratories making vitamin measurements in human serum. Frozen and/or freeze dried sera are sent to laboratories for analysis as an interlaboratory comparison exercise. Results are returned to NIST for data tabulation and evaluation. Value-assignment of the sample pools is based on the median of all the laboratory results, with confirmation based on measurements at NIST. We provide consultation and trouble-shooting regarding methods of analysis, and a certificate of participation in the QA program is issued at the end of each calendar year. We also host a micronutrient analysis QA workshop for fat-soluble vitamin, carotenoid, and ascorbic acid measurements in serum.

The enclosed set of samples constitute the round robin exercise for vitamin C (Round Robin XII) for 1999. Four vials of frozen serum *test samples* (two serum samples of candidate SRM 970 and two unknown serum samples) and a vial of solid ascorbic acid (a *control sample*) are enclosed. Please follow the attached protocol when you analyze these samples.

Report your results using the attached form by **March 26, 1999**. We also request that you send us a representative chromatogram from the analysis of each sample and indicate whether peak height or peak area was used in the calculation of the ascorbic acid concentration. Your results will be kept confidential. Results received two weeks after the due date will not be included in the summary report of this round robin study. The summary report concerning this study will be provided near the end of April.

Results may be faxed to (301) 977-0685 or mailed to:

Micronutrients Measurement Quality Assurance Program
NIST
100 Bureau Drive, Stop 8392
Gaithersburg, MD 20899-8392

If you have any questions, I can be reached at (301) 975-3137. Please let us know if the samples do not arrive frozen so that a duplicate set can be shipped.

Thank you for your participation and we look forward to receiving your results.

Sincerely,

Sam A. Margolis, Ph.D.
Research Chemist
Analytical Chemistry Division
Chemical Science and Technology Laboratory

Enclosures

Protocol for analyzing samples

The control sample consists of a sample of solid ascorbic acid in an amber vial and should be used in the following manner (please record your weights on the attached report form):

1. Prepare 250 mL of 5% metaphosphoric acid (MPA) in distilled water.
2. Weigh out **180-220 mg** of the solid ascorbic acid sample to 0.1 mg (if possible) and dissolve it in 100 mL of 5% MPA using a 100 mL volumetric flask. **Weigh the amount of MPA solution that was added.** This will be referred to as the Stock Solution.
3. Dilute the Stock Solution by **weighing** 0.5 mL of the stock solution into a 100 mL volumetric flask. Then add 5% MPA solution to 100 mL and **weigh the amount of MPA solution that was added.**
4. Record the ultraviolet spectrum of the diluted solution against 5% MPA solution as the blank using paired cuvettes.
5. Record the absorbance of the sample at 243 and 244 nm.
6. Measure the concentration of the ascorbic acid in the **dilute solution** in duplicate along with the ampuled Test Samples.

The Test Samples are in sealed ampules and were prepared by adding equal volumes of 10% metaphosphoric acid to spiked human serum. We have checked the samples for stability and homogeneity and the total ascorbic acid appears to be sufficiently stable however, these samples contain some dehydroascorbic acid. The Test Samples should be defrosted by warming at 20 °C for not more than 10 min otherwise some oxidation of ascorbic acid may occur.

Each ampule should contain between **10 and 120 μmol of ascorbic acid/ L** of diluted serum and each ampule should be analyzed in duplicate by the method(s) used in your laboratory (preferably one measuring total ascorbic acid).

REPORT OF ANALYSIS

NAME:

ADDRESS:

Telephone no.: _____

Fax no.: _____

Method of Analysis:

Please attach representative chromatograms.

Method used for calculating ascorbic acid concentration.

Peak height _____ Peak area _____

Manufacturer of ascorbic acid used to make in-house standards _____

Date of Analysis: _____

PREPARATION OF STOCK SOLUTION AND DILUTED SOLUTIONS

STOCK SOLUTION

Weight of ascorbic acid in the Stock Solution _____ mg

Weight of 5% MPA added to the 100 mL volumetric flask _____ g

DILUTE SOLUTION

Weight of added stock solution (0.5 mL) _____ mg

Weight of 5% MPA added to the 100 mL volumetric flask _____ g

Absorbance of Dilute Solution 1 at **243 nm** _____

Absorbance of Dilute Solution 1 at **244 nm** _____

COMMENTS:

REPORT OF ANALYSIS

RESULTS ($\mu\text{mol/L}$)

CONTROL SAMPLE 1

REPLICATE 1 _____ $\mu\text{mol/L}$

REPLICATE 2 _____ $\mu\text{mol/L}$

TEST SAMPLE LOW VIAL # _____

REPLICATE 1 _____ $\mu\text{mol/L}$

REPLICATE 2 _____ $\mu\text{mol/L}$

TEST SAMPLE HIGH VIAL # _____

REPLICATE 1 _____ $\mu\text{mol/L}$

REPLICATE 2 _____ $\mu\text{mol/L}$

UNKNOWN VIAL # _____

REPLICATE 1 _____ $\mu\text{mol/L}$

REPLICATE 2 _____ $\mu\text{mol/L}$

UNKNOWN VIAL # _____

REPLICATE 1 _____ $\mu\text{mol/L}$

REPLICATE 2 _____ $\mu\text{mol/L}$

Appendix J. “Final Report” for RR11 and RR12

The following seven pages are the “Final Report” as provided to all participants in RR11 and/or RR12, with the following exceptions:

- the participant identifiers (Lab) have been altered.
- the order in which the participant results are listed has been altered.
- the Figure and Tables have been updated to report results in units of “ $\mu\text{mol/L sample}$ ” rather than the original “ $\mu\text{mol/L serum}$ ”, where:
 $\mu\text{mol/L sample} = (\mu\text{mol/L serum})/2$.
- some of the results listed in the current Tables and Figure differ from those in the original “Final Report” because of later-resolved confusion in the reporting units. Note, however, that the results discussed in the Dr. Margolis’s text have **not** been updated or corrected.

The data summary in the “Final Report” has been altered to ensure confidentiality of identification codes assigned to laboratories. The only attributed results are those reported by NIST. The NIST results are not used in the assessment of the consensus summary results of the study.

August 9, 1999

Dr. Margolis printed a separate cover letter for each participant. The words within the "«»" are parameters for a mail-merge macro routine.

«Name»
« Company»
«Address»

Dear «Name»:

This report describes the overall-group and your laboratory performance in Round Robin 11 (RR11) and Round Robin 12 (RR12) for the measurement of ascorbic acid (AA) in human plasma. These studies involved both the duplicate analyses of two samples of candidate SRM 970 Ascorbic Acid in Human Serum and a solid ascorbic acid sample as a standard. Your results are designated as Lab. No(s). «Lab No.» in the tables and figures.

Table 1 provides a summary of the data submitted by the participating laboratories (the NIST data were not included in the statistical analysis). Three laboratories submitted two sets of measurements, each done by a different method. As shown in Table 1, the among-laboratory coefficient of variation (CV) for levels 1 and 2 were 24% and 15% for RR11, and 23% and 12% for RR12. The median within-laboratory measurement-repeatability CV for levels 1 and 2 were less than 5% for both levels in both exercises.

These results indicate that the within-laboratory variation remains essentially unchanged from the two previous round robins. However, the among-laboratory CV may have slightly increased from RR10. The box plots in your report graphically summarize the results, the box contains the values from 50% of the data sets distributed closest to the median. The NIST mean value for the "total" ascorbic acid (ascorbic acid + dehydroascorbic acid) is represented by a solid line and the NIST mean for ascorbic acid (alone) is represented by the dashed line. The horizontal line in the 50% boxes represents the median interlaboratory values. The distribution of the laboratory results is illustrated in Figure 1. These plots suggest that many of the laboratories are not measuring all of the dehydroascorbic acid.

We asked each of you to make up a solution from solid ascorbic acid, measure its UV absorbance, and assay the ascorbic acid content. We also asked you to weigh all of the solutions used to make this standard. The purpose of this segment of the study was to try to evaluate the role that your standards and your measurement technique might be playing in the accuracy and precision of your measurement process. The results of the measurements on ascorbic acid solutions are summarized in Tables 2 and 3. The ascorbic acid concentrations were calculated from the weights that you reported, and the volume of metaphosphoric acid (MPA) was calculated by using a density of 1.004 g/L (21 °C) for 5% MPA. The analysis of the weights of a 500 mL aliquot of the AA stock solution gave a mean of 519.4 mg, SD 8.8, CV 1.7 (range 507 - 540 mg) for RR11 and a mean of 515.4 mg, SD 9.2, CV 1.8 (range 500 - 527 mg) for RR12. The volumes were calculated from the weighed amounts of 100 mL of MPA into the 100 mL volumetric flask using the density of 5% MPA. The results of this calculation gave a mean of

102.3 g, SD 0.5, and CV 0.5 (range 101.6-103.7 g) for RR11 and 102.6 g, SD 0.2, and CV 0.2 (range 100.3-102.9 g) for RR12. These data indicate that you are able to accurately weigh samples between 0.500 and 100 g. It also indicates that the pipettes that were used to measure sub-mL volumes are biased high by $\approx 4\%$ at 500 mL. An important question that is not answered in this study is whether this is a constant bias or proportional to the volume being measured. However, it strongly suggests that each laboratory should calibrate its micropipettes over the range that they are used. One way to do this is to weigh a series of aliquots (5-10) of a liquid such as water, convert the weights to volumes using the density of water (at the appropriate temperature), and calculate the accuracy and precision of the pipette and pipetting technique (see ASTM method for a detailed method).

Using the data that you submitted to us, we calculated the concentration of the AA in the standard solution (the "Calc." columns, Table 1) which each of you made and assumed that the error in concentration was no greater than the error in weighing 0.5 to 100 g. The amount of AA that you actually measured in your assay of the standard solution is listed in the "Meas." columns of Table 1. To compare the measurements on the standard solutions, we normalized all of the data obtained by assaying the standard solution to a starting concentration of 50 mmol/L using the equation:

$$\begin{aligned} \text{assayed [AA]} &= \text{normalized [AA]} \\ \text{weighed [AA]} &= 50 \end{aligned}$$

The mean of these data is 51.3, SD 4.6, CV 9.0 (range 42.7 - 57.5 mmol/L) for RR11 and 50.9, SD 4.9, CV 9.6 (range 42.7 - 57.5 mmol/L) for RR12. If the estimated error in weighing and in filling the volumetric flasks is small (1 - 2%), then the major source of error is in the assay itself. This would include: 1) the accuracy of the pipets, 2) the accuracy of the standards (particularly if they are diluted), 3) the accuracy of the volume of the sample standard and/or serum delivered to the assay mixture, and 4) the accuracy of any constants used in the calculation of the concentration of the analyte from the results of the assay.

Finally we asked each of you to measure the absorbance of your standard solution at 243 nm and 244 nm. At these wavelengths we determined, on a spectrophotometer calibrated for wavelength and absorbance accuracy, that ascorbic acid in MPA exhibits its maximum absorbance. Every laboratory obtained similar values at each wavelength indicating that the wavelength was correct; however, the mean $E^{1\%}$ for a 1 cm cell was 581 AU/mole/cm, SD 34, CV 5.8 in RR11 and 563 AU/mole/cm, SD 15, CV 2.7 in RR12. At NIST the $E^{1\%}$ was determined for Fisher and Sigma samples of AA and the values were 529 and 533 AU/mole/cm respectively. The reported values for the Fisher ascorbic acid varied from 525 to 668 AU/mole/cm for RR11 and 540 to 584 AU/mole/cm for RR12. These results indicate that there is a need among some laboratories to calibrate their spectrophotometers with absorbance standards such as NIST SRM 2031. For those laboratories whose $E^{1\%}$ was at the high or low end of the distribution curve, we recommend checking the wavelength accuracy of the spectrophotometer.

In conclusion we can identify the following sources of systematic bias in the measurements:

1. The spectroscopic error in the measurement of the absorbance of a standard solution at a specified wavelength (CV = 9-10).
2. The pipetting of aqueous solutions (mean 3-4% above expected value).

3. The weighing of samples 0.5-100 g (CV of 1 and 2% respectively).
4. The measurement of the concentration of a 50 mmol/L standard solution (mean = 51 mmol/L, CV= 9-10%). The mean value is close to the expected value; therefore the error probably lies in the accuracy of the measurement of the sample or the calculation constants.
5. The measurement of the serum AA. This could either reflect inaccurate dispensing of the total sample to the assay because of the viscosity of the sample, inaccurate constants used in calculating the AA concentration, or incomplete reduction of the dehydroascorbic acid.

If your values differed from those of NIST by more than 5%, we suggest that you evaluate whether you accurately deliver the correct sample volume which can vary either as a function of the sample viscosity or the accuracy of the pipette. Alternatively, we suggest that you evaluate the accuracy of the constants that you use in converting the assay results to a final AA concentration in the serum or the completeness of the reduction of the dehydroascorbic acid or the oxidation of the ascorbic acid. If your results deviate significantly from the assigned values, we suggest that you reexamine your methods for possible systematic errors.

The next set of samples (RR13) will be shipped during January 2000. If you have any questions concerning the previous round robins please contact me at 301/975-3137 or by e-mail at sam.margolis @nist.gov.

Sincerely ,

Sam A. Margolis, Ph.D.
Research Chemist
Analytical Chemistry Division
Chemical Science and Technology Laboratory

Enclosures

Table 1: Round Robin 11 and 12 for the Measurement of AA in Human Serum

		Ascorbic Acid ($\mu\text{mol/L}$ Sample)							
		Round Robin 11				Round Robin 12			
Lab.No.	Method ^a	Standard		SRM 970		Standard		SRM 970	
		Calc.	Meas.	Level 1	Level 2	Calc.	Meas.	Level 1	Level 2
VC-MA	HPLC-EC	57.8	6.1	7.2	25.2		54.3	7.7	23.7
VC-MB	Enz-OPD	57.8	64.0	12.4	31.5	58.3	54.3	9.0	27.4
VC-MC	HPLC-EC	57.9	71.4	12.0	35.8	57.4	63.7	11.5	32.3
VC-MD	DNPH		48.8	7.0	34.3		48.6	8.7	34.0
VC-ME	HPLC-UV	56.9	54.6	7.3	27.1				
VC-MF	Enz-OPD		55.3	8.1	27.1				
VC-MH	HPLC-EC					56.8	58.0	8.6	26.2
VC-MI	HPLC-UV					59.3	62.2	8.7	29.8
VC-ML	HPLC-UV	56.3	57.0	9.9	28.5	55.0	52.3	7.0	25.4
VC-MO	HPLC-OPD	53.0	53.8	7.2	24.6	56.3	58.0	8.0	26.7
VC-MQ	DCIP					57.7	68.1	6.5	33.3
VC-MT	HPLC-EC					62.9	67.4	11.4	31.7
VC-MV	HPLC-EC	56.4	61.4	9.0	28.7				
VC-MW	DNPH	55.4	59.5	8.0	21.1				
VC-MX	HPLC-EC	56.3	56.6	11.4	25.2				
VC-MZ	HPLC-EC	57.3	57.2	8.2	28.1				
VC-NA	HPLC-EC	54.6	50.8	8.6	14.2				
VC-MG	HPLC-UV						54.8	5.5	26.8
VC-NC	DNPH	55.9	63.6	13.6	36.3				
VC-ND	HPLC-EC	58.4	48.6	12.1	28.1				
VC-NI	Enz-OPD					55.2	48.7	8.6	30.0
VC-NJ	Enz-OPD	62.4	70.1	8.7	28.4				
VC-NO	HPLC-UV	63.0	56.3	10.0	26.9				
VC-NQ	HPLC-OPD					56.7	52.7	7.9	26.7
VC-NV	HPLC-?					56.0	46.6	12.4	25.6
NIST ^b	HPLC-EC			9.5	31.7			10.3	32.2
	N	15	17	17	17	11	14	14	14
	Median	56.9	56.6	8.7	28.1	56.8	54.5	8.6	27.1
	eSD	1.5	7.0	2.1	4.3	1.4	6.9	1.2	3.2
	eCV	2.6	12.3	24.1	15.3	2.5	12.7	14.3	11.9

^a AA = Ascorbic acid; DNPH = 2,4-Dinitrophenylhydrazine; EC = Electrochemical detector; Enz = Enzymatic assay; DCIP = Dichloroindophenol; HPLC = Liquid chromatography; OPD = Orthophenylenediamine; TAA = Total ascorbic acid; UV = Ultraviolet absorbance

^b Not included in the summary statistics

Table 2: Vitamin C Round Robin 11

Lab	Method	Control Solution				SRM 970, $\mu\text{mol/L}$ Sample																	
		Spectroscopy		AA, $\mu\text{mol/L}$		Level 1			Level 2														
		OD ₂₄₃	OD ₂₄₄	E %	Calc	Avg	S _{dup}	Vial 1	Avg	S _{dup}	Vial 2	Avg	S _{dup}	Mean	S _{dup}	S _{tot}							
VC-MA	HPLC-EC	0.053	0.053	52	57.8	6.1	0.3	7.4	0.6	7.1	0.2	7.2	0.4	0.2	0.4	24.6	1.1	25.7	1.8	25.2	1.5	0.8	1.7
VC-MB	Enz-OPD	0.566	0.569	556	57.8	64.0	0.0	12.5	0.0	12.3	0.4	12.4	0.3	0.2	0.3	31.3	0.4	31.8	0.4	31.5	0.4	0.4	0.5
VC-MC	HPLC-EC	0.568	0.567	556	57.9	71.4	0.1	11.6	0.5	12.5	0.0	12.0	0.4	0.6	0.7	35.9	0.2	35.7	0.9	35.8	0.7	0.1	0.7
VC-MD	DNPH					48.8	0.5	7.0	0.8	7.0	1.0	7.0	0.9	0.0	0.9	34.5	0.1	34.1	0.5	34.3	0.4	0.2	0.4
VC-ME	HPLC-UV	0.569	0.574	567	56.9	54.6	0.1	6.4	0.5	8.1	0.6	7.3	0.5	1.2	1.3	27.4	0.2	26.8	0.3	27.1	0.2	0.4	0.5
VC-MF	Enz-OPD					55.3	0.3	8.2	0.0	8.0	0.1	8.1	0.1	0.2	0.2	27.1	0.0	27.0	0.1	27.1	0.1	0.0	0.1
VC-ML	HPLC-UV	0.568	0.565	573	56.3	57.0	1.5	10.1	0.5	9.6	0.3	9.9	0.4	0.3	0.5	28.6	0.9	28.5	0.5	28.5	0.8	0.1	0.8
VC-MO	HPLC-OPD	0.034	0.032	36	53.0	53.8	0.5	7.2	0.1	7.2	0.1	7.2	0.1	0.0	0.1	24.8	1.2	24.5	0.3	24.6	0.8	0.2	0.9
VC-MV	HPLC-EC	0.569	0.572	573	56.4	61.4	0.8	9.5	0.6	8.5	0.4	9.0	0.5	0.7	0.9	28.0	0.6	29.4	1.0	28.7	0.8	1.0	1.3
VC-MW	DNPH	0.542	0.541	556	55.4	59.5	0.1	8.3	0.1	7.6	0.2	8.0	0.2	0.5	0.6	21.2	0.2	21.0	0.2	21.1	0.2	0.1	0.2
VC-MX	HPLC-EC	0.621	0.621	627	56.3	56.6	1.5	11.3	0.3	11.4	0.3	11.4	0.3	0.1	0.3	25.2	1.0	25.2	1.0	25.2	1.0	0.1	1.0
VC-MZ	HPLC-EC	0.573	0.570	568	57.3	57.2	3.3	8.1	0.1	8.2	0.2	8.2	0.1	0.1	0.2	28.3	0.5	28.0	0.9	28.1	0.7	0.2	0.8
VC-NA	HPLC-EC	0.560	0.536	582	54.6	50.8	0.8	9.4	0.0	7.8	0.2	8.6	0.2	1.1	1.1	14.1	0.0	14.4	0.1	14.2	0.1	0.2	0.2
VC-NC	DNPH	0.587	0.595	597	55.9	63.6	0.3	13.8	0.3	13.5	0.2	13.6	0.2	0.2	0.3	36.4	0.9	36.2	0.7	36.3	0.8	0.1	0.8
VC-ND	HPLC-EC	0.572	0.570	556	58.4	48.6	1.2	12.6	0.5	11.6	0.0	12.1	0.4	0.7	0.8	28.3	0.0	28.0	0.2	28.1	0.2	0.2	0.3
VC-NJ	Enz-OPD	0.613	0.613	558	62.4	70.1	0.4	8.8	0.4	8.5	0.0	8.7	0.3	0.2	0.3	28.7	0.4	28.1	0.4	28.4	0.4	0.4	0.6
VC-NO	HPLC-UV	0.735	0.735	662	63.0	56.3	1.1	10.0	0.0	10.1	0.4	10.0	0.0	0.0	0.0	24.3	6.7	29.5	2.1	26.9	5.0	3.7	6.2
NIST	HPLC-EC			529				9.0	0.2	10.1	0.4	9.5	0.3	0.8	0.9	31.0	0.1	32.5	1.2	31.7	0.8	1.0	1.3
		15	15	15	15	17	17					17											
	Min	0.034	0.032	36	53.0	6.1	0.0					7.0	0.0	0.0	0.0					14.2	0.1	0.0	0.1
	Median	0.569	0.570	567	56.9	56.6	0.5					8.7	0.3	0.2	0.4					28.1	0.7	0.2	0.7
	Max	0.735	0.735	662	63.0	71.4	3.3					13.6	0.9	1.2	1.3					36.3	5.0	3.7	6.2
	eSD	0.013	0.037	17	1.5	7.0						2.1								4.3			
	ECV	2.3	6.4	3.0	2.6	12.3						24.1								15.3			

Figure 1: Distribution of Participant Results in Round Robins 11 and 12

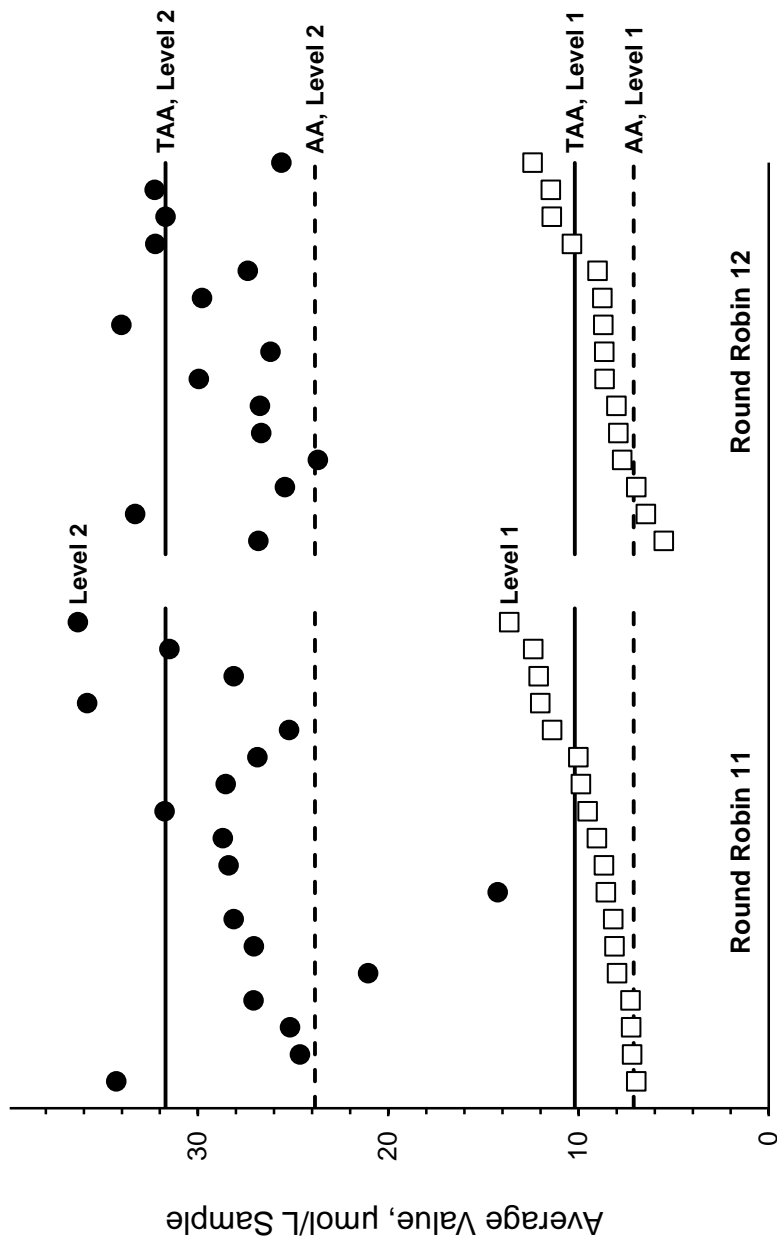

Participants, Rank-Ordered by Level 1

Summary of the Round Robin 11 and Round Robin 12 results on the Measurement of Ascorbic Acid in SRM 970. Each point represents the average of two measurements on each of two vials. The dashed lines represent NIST-determined values for ascorbic acid (AA) by itself. The solid lines represent NIST-determined values for total ascorbic acid (TAA, AA + dehydroascorbic acid).

Appendix K. Representative “Individualized Report” for RR11 and RR12

Each participant in either RR11 and/or RR12 received an “Individualized Report” reflecting their reported results. The following two pages are the “Individualized Report” for participant VC-MA.

Individualized RR(Vitamin C) 11 & 12 Report: VC-MA

Date	Method	Sample	AA		MPA		Stock		MPA		[AA]		A ₂₄₃		A ₂₄₄		E ^{1%} _{max} dL/gcm
			mg	g	g	mg	g	mg	g	mmol/L	mmol/L	OD	OD	OD	OD		
RR 11: 09/23/98	HPLC-EC (Height)	Control	200	103.09	526	102.45					57.8			0.0525	0.0527		
RR 12: 04/02/99	HPLC-EC (Height)	Control	215	103.1	517.1	102.52				61.1			0.0721	0.0721			
			Combined		Combined		Combined		Combined		59.5						

Date	Method	Sample	Replicates, [AA] μmol/L						Duplicates, [AA] μmol/L									
			Rep ₁		Rep ₂		Factor		Mean		SD _{dup}		Mean		SD _{dup}		SD _{het}	
			Rep ₁	Rep ₂	Rep ₁	Rep ₂	Factor	Factor	Mean	SD _{dup}	Mean	SD _{dup}	Mean	SD _{dup}	Mean	SD _{dup}	Mean	SD _{het}
RR 11: 09/23/98	HPLC-EC (Height)	SRM Lv 1, A	15.5	13.9	0.5	0.5	7.4	0.6			7.2	0.4	0.2	0.0	0.3			
RR 11: 09/23/98	HPLC-EC (Height)	SRM Lv 1, B	14.0	14.5	0.5	0.5	7.1	0.2										
RR 12: 04/02/99	HPLC-EC (Height)	SRM Lv 1, A	14.5	15.8	0.5	0.5	7.6	0.5			7.7	0.4	0.1	0.0	0.3			
RR 12: 04/02/99	HPLC-EC (Height)	SRM Lv 1, B	16.1	15.1	0.5	0.5	7.8	0.3			7.5	0.4	0.4	0.3	0.5			
			Combined		Combined		Combined		Combined									
RR 11: 09/23/98	HPLC-EC (Height)	SRM Lv 2, A	50.7	47.7	0.5	0.5	24.6	1.1			25.2	1.5	0.8	0.0	1.3			
RR 11: 09/23/98	HPLC-EC (Height)	SRM Lv 2, B	54.0	54.0	0.5	0.5	25.7	1.8										
RR 12: 04/02/99	HPLC-EC (Height)	SRM Lv 2, A	49.5	45.9	0.5	0.5	23.9	1.3			23.7	1.0	0.2	0.0	0.7			
RR 12: 04/02/99	HPLC-EC (Height)	SRM Lv 2, B	47.9	47.9	0.5	0.5	23.5	0.6			24.4	1.3	1.4	1.0	1.6			
			Combined		Combined		Combined		Combined									
RR 11: 09/23/98	HPLC-EC (Height)	Control	6.3	5.9	1.0	1.0	6.1	0.3			29.6	0.2	33.3	33.3	33.3			
RR 12: 04/02/99	HPLC-EC (Height)	Control	53.3	53.0	1.0	1.0	53.1	0.2										

Please check our records against your records. Send corrections and/or updates to...

Micronutrients Measurement Quality Assurance Program
 National Institute of Standards and Technology
 100 Bureau Drive Stop 8392
 Gaithersburg, MD 20899-8392 USA



Tel: (301) 975-3935
 Fax: (301) 977-0685
 Email: david.duewer@nist.gov

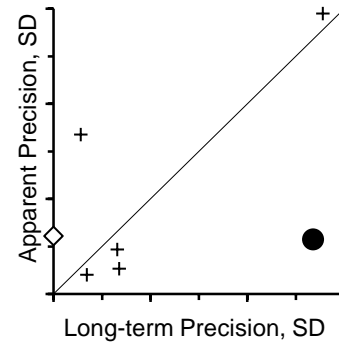
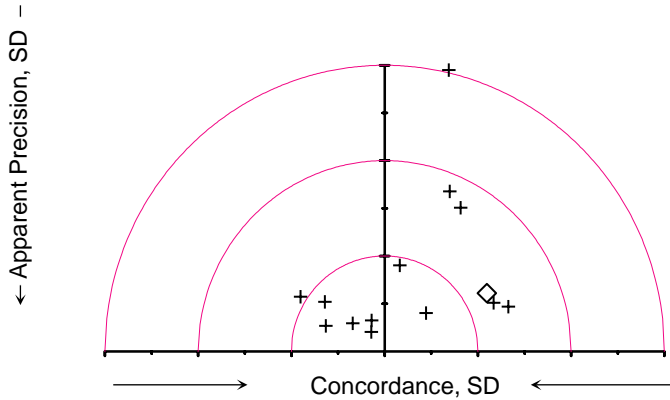
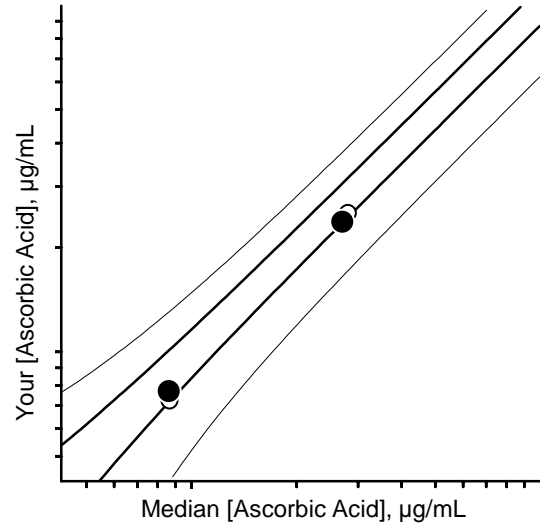
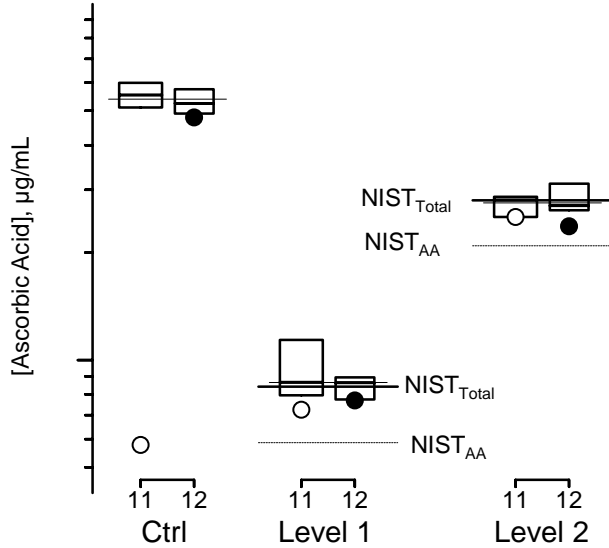

Individualized RR(Vitamin C) 11 &12 Report: VC-MA

Ascorbic Acid



 3rd Quartile (75%)
 Median (50%)
 1st Quartile (25%)

 You, RR 12
 You, RR 11

 NIST, RR 12
 Others, RR 12

For details of the construction and interpretation of these plots, see:
 Duewer, Kline, Sharpless, Brown Thomas, Gary, Sowell. Anal Chem May 1, 1999.

Sample

Comments

Ctrl Nominal 100 mg/L (56 µmol/mL) standard "control" solution prepared by participant from solid ascorbic acid provided by NIST. This material was from the same lot of material used to augment the SRM plasma pools and to prepare the gravimetric calibration solutions.

SRM_{Lo} SRM 970 Level 1: Values are the mean of replicate determinations for two vials of each material

SRM_{Hi} SRM 970 Level 2: Values are the mean of replicate determinations for two vials of each material