

A11102 977897

NIST
PUBLICATIONS

NAT'L INST OF STANDARDS & TECH R.I.C.



A11102977897

DEPARTMENT OF COMMERCE

NATIONAL INSTITUTE OF STANDARDS AND TECHNOLOGY
(formerly National Bureau of Standards)

NIST Technical Note 1253

*An Electrochemical Technique for Rapidly Evaluating
Protective Coatings on Metals*

Changjian Lin and Tinh Nguyen

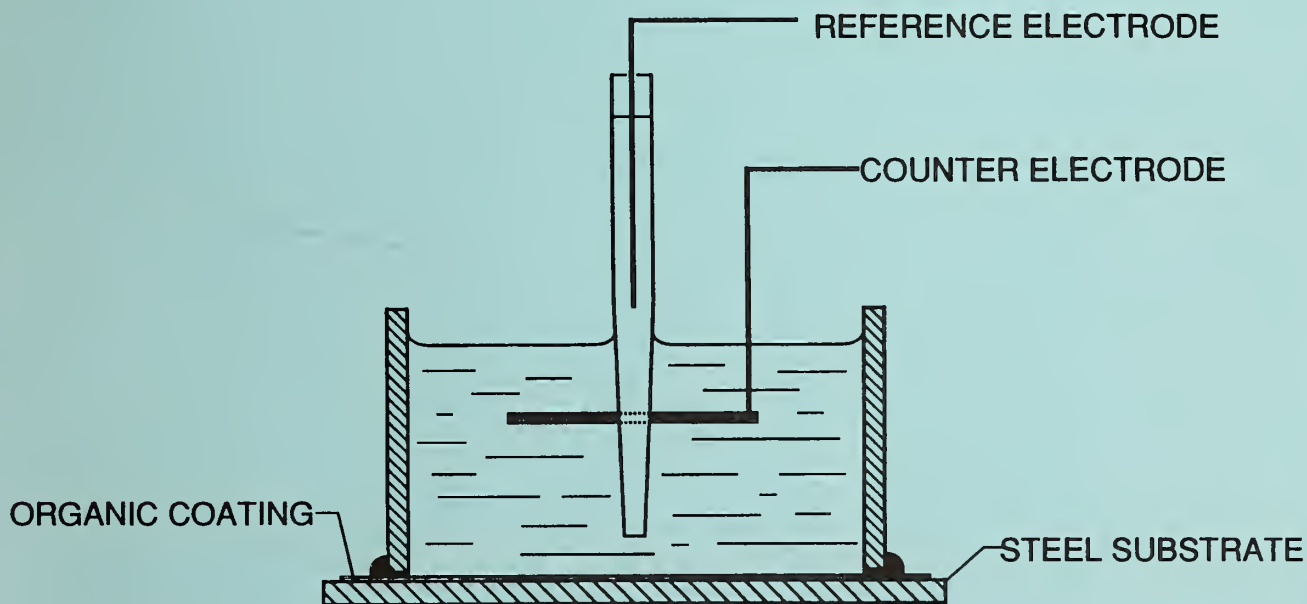

-QC
100
.U5753
No.1253
1988
c.2

NATIONAL INSTITUTE OF STANDARDS &
TECHNOLOGY
Research Information Center
Gaithersburg, MD 20899

NISTC
QC100
. U5753
no. 1253
1988
C.2

NIST Technical Note 1253

An Electrochemical Technique for Rapidly Evaluating Protective Coatings on Metals

Changjian Lin

Xiamen University
People's Republic of China

Tinh Nguyen

Building Materials Division
Center for Building Technology
National Engineering Laboratory
National Institute of Standards and Technology
Gaithersburg, MD 20899

October 1988



NOTE: As of 23 August 1988, the National Bureau of Standards (NBS) became the National Institute of Standards and Technology (NIST) when President Reagan signed into law the Omnibus Trade and Competitiveness Act.

U.S. Department of Commerce
C. William Verity, Secretary

National Institute of Standards and Technology
(formerly National Bureau of Standards)
Ernest Ambler, Director

National Institute of Standards
and Technology
Technical Note 1253
Natl. Inst. Stand. Technol.
Tech. Note 1253
23 pages (Oct. 1988)
CODEN: NTNOEF

U.S. Government Printing Office
Washington: 1988

For sale by the Superintendent
of Documents
U.S. Government Printing Office
Washington, DC 20402

Contents

	Page
1. Introduction	1
2. Multicyclic Potentiodynamic Polarization (MCPDP) Technique.....	2
2.1 Basics of Electrochemical Measurements.....	2
2.2 Multicyclic Potentiodynamic Polarization (MCPDP) Technique	2
3. Experimental Procedures.....	4
3.1 Specimen Preparation	4
3.2 Electrochemical Instrumentation Set-Up and Measurements.....	4
4. Results and Discussion	6
4.1 Effects of Coating Integrity on MCPDP Results.....	6
4.2 Evaluation of the Effect of Coating Type on Corrosion Protection of Organic Coatings on Steel	8
4.3 Evaluation of the Effect of Coating Thickness on Corrosion Protection of Organic Coatings on Steel.....	8
4.4 Evaluations of the Effect of Contaminants on Corrosion Protection of Organic Coatings on Steel	12
4.5 Evaluation of the Effect of Defects in the Coatings on Corrosion Protection of Organic Coatings on Steel.....	12
4.6 Evaluation of the Effect of Curing Time on Corrosion Protection of Organic Coatings on Steel	18
5. Conclusions	19
6. Acknowledgment	19
7. References	19

An Electrochemical Technique for Rapidly Evaluating Protective Coatings on Metals

Changjian Lin* and Tinh Nguyen

*National Institute of Standards and Technology
Gaithersburg, MD 20899*

A new electrochemical technique based on multicyclic scanning potentials applied to a specimen in an electrolyte was developed and evaluated as a method for rapidly evaluating the corrosion protection performance of organic coatings on metal. Opaque alkyd and clear acrylic coated steel samples prepared at different thicknesses, curing conditions, defect inclusions, and contamination concentrations were used for the evaluation. The applied potentials were between -1.8 and $+1.8$ V, and the electrolyte was a 3% NaCl solution. Preliminary results indicate that this technique is useful for evaluating the corrosion protection properties of organic coatings on steel. The technique appears to offer a number of advantages: fast and in situ measurements, good reproducibility, high sensitivity, and minimal damage to the coating.

Key words: accelerating test method; coating; contamination; corrosion; electrochemical; evaluation; multicyclic polarization.

1. Introduction

The yearly cost of all forms of metallic corrosion in the United States has been estimated at 4.2% of the gross national product [1]. The use of organic coatings is the most common method for protecting metal structures against corrosion. It has been suggested that approximately one-half of corrosion control costs are related to the use of organic protective coatings [2]. Despite such widespread application of organic coatings for corrosion control, no acceptable technique exists for rapidly evaluating their performance. One of the reasons for this is that the failure of a protective coating is a complex process depending on many factors, including the metal substrate, the coating, the metal/coating interaction, and the service environment [3].

Techniques for evaluating the corrosion protection properties of organic coatings on metals can be divided into two main types: nonelectrochemical and electrochemical. Applications of these techniques to coated metals have been adequately reviewed [4–10]. Since failures of a coating system, such as blistering, cathodic delamination, and corrosion, are affected by the conductivity of the coating and the electrochemical processes occurring at the metal/coating interface [11], evaluation techniques based on electrochemical principles may be useful.

Five main electrochemical and electrical measurement techniques have been used for predicting the corrosion protective ability of organic coatings on metals [5–10]; these are dc electrical resistance, corrosion potential, polarization resistance, polarization curve, and ac impedance. The last technique has been considered as one of the most promising [7]. Although these techniques have been useful for understanding the corrosion mechanisms of metals, with and without coatings, and for providing information on the protective properties of organic coatings, each has shortcomings.

One of the main disadvantages of the corrosion potential, polarization resistance and ac impedance techniques is the long immersion time of the coated sample in the test environment before any change in the signal is observed. For example, Walter [7] reported that corrosion potentials could not be measured on a 25- μm vinyl coating on aluminum sample in 5% NaCl solution until the 41st day of immersion. Similarly, Skerry and Eden [12] indicated that it took about 9 months immersion in a 0.6 M NaCl solution before a 60 μm (total thickness), commercial-quality alkyd top coat over an alkyd primer on a steel substrate showed any resistive change by the ac impedance technique. In addition, the interpretation of the results obtained by the ac impedance technique is often difficult, and the equipment required is complex and expensive. On the other hand, the dc resistance technique does not provide a true result of the corrosion protection ability of a coating

* Guest Scientist from Xiamen University, People's Republic of China.

because it only measures the resistance of the coating, and gives no information on the complicated reactions occurring at the metal/coating interface [13]. Furthermore, much of the dc resistance work has been on free standing films, which do not always provide a reliable guide to the performance of a coating system [14]. The main objection to the polarization curve techniques is the use of a single dynamic scan, which may produce the desired currents for bare metals but may not be able to cause current flow in coated metals because of the high resistivity of the coatings. In order to produce current in a coated specimen with a single scan, the applied potential must be high. This might cause changes in the properties of the coatings and the metal/coating interface [7].

Since no single technique is adequate, it is necessary to combine various techniques to effectively evaluate the corrosion protection performance of coated metals. This paper reports on a new electrochemical technique, the multicyclic potentiodynamic polarization (MCPDP) technique.

2. Multicyclic Potentiodynamic Polarization (MCPDP) Technique

2.1 Basics of Electrochemical Measurements

When a piece of metal corrodes, it has cathodic and anodic sites. For example, for steel immersed in water containing oxygen, the primary reaction (oxidation reaction) at the anode is:

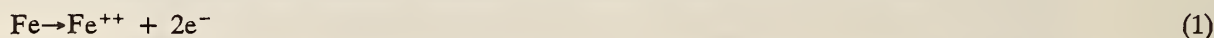

This leads to the dissolution of the steel. The primary reactions (reduction reactions) at the cathode are:

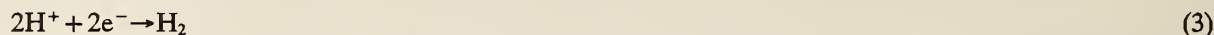
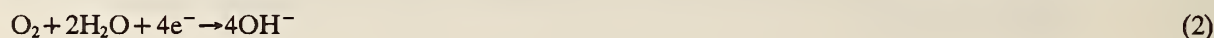

Electrochemical techniques provide a means to accelerate these corrosion processes and at the same time examine them. The two fundamental quantities used to characterize an electrochemical reaction are potential and current. Potential can be a result of the natural reaction (as from corrosion reactions at equilibrium), or can be imposed by an external source. In the latter case, the external source stimulates either the oxidation or the reduction reactions.

As an oxidation or reduction reaction occurs at the metal surface, a flow of electrons (either to or from the metal) gives rise to a current. The current can be related to the rate of the electrochemical reaction because it is a measure of the number of electrons that flow in a given period of time. The potential at which a given metal specimen is at equilibrium with its environment is called the corrosion potential, E_{corr} ; there is no net current flow at this potential because the oxidation and reduction currents are equal in magnitudes. An electrode that is maintained at a potential other than E_{corr} by an external instrument is said to be polarized. When the specimen is polarized in the positive direction (with respect to E_{corr}), the anodic current (oxidation reaction) predominates. Similarly, when a negative potential (relative to E_{corr}) is applied, the cathodic current predominates.

2.2 Multicyclic Potentiodynamic Polarization (MCPDP) Technique

In a multicyclic potentiodynamic polarization (MCPDP) experiment, the first applied potential scan starts at E_{corr} (the corrosion potential), and continues in the negative (cathodic) direction. When it reaches a preprogrammed negative value, it is reversed and begins in a positive (anodic) direction, past E_{corr} . When it reaches a preprogrammed positive potential, it is reversed and scans in the negative direction again to the preprogrammed negative potential to complete a cycle. The cycle may be repeated many times until measurable polarization currents occur. The scanning times and the polarization currents are recorded and presented in a typical potential/current plot. The currents and scanning times are compared for a set of samples. The lower the polarization current at the same scanning time, or the longer the scanning time at the same polarization current, the better the corrosion resistance of the specimen. This procedure is similar to cyclic voltammetry in electrochemistry.

It should be mentioned here that the MCPDP technique differs from the cyclic polarization technique commonly used for measuring the pitting tendency of a specimen in a given bare metal-solution system. In the cyclic polarization technique, a potential is applied until a large increase in current occurs (instead of to a predetermined potential value as in MCPDP); when the current reaches a certain value, the potential reverses

and scans in the opposite direction. In the cyclic polarization technique, only one cycle of potential is used, and it does not provide adequate driving force to produce a detectable change in the current in a coated metal specimen. Another difference is that, in the cyclic polarization technique, the shape of the loop between the forward and backward scans, and the critical potentials are the two primary concerns. In the MCPDP technique, the resulting current levels and the time required to produce a specific current value are the most important measurement results.

The parameters of measurement used in an MCPDP experiment can be changed depending upon the requirements of the samples. For steel coated specimens, the maximum positive potentials can be selected in the range between 0.5 and 1.8 V and the negative potentials can be selected in the range between -0.5 and -1.8 V depending on the thickness, type, and physical condition of the coating, and the type and concentration of the electrolyte. The scanning rates are typically between 0.01 and 0.1 V per second, which are about 60 to 600 times faster than the scanning rates recommended by the ASTM G5-87 method [15]. The fast scanning rate used in the MCPDP technique should force the specimen to follow its corrosion reaction pattern before it has the opportunity to passivate or return to equilibrium with the environment [16].

Although the actual physical process involved is not completely understood, the MCPDP technique seems to perform the functions of a number of testing methods that have been very useful for studying the corrosion of bare and organic coated metals. When the applied potential is scanned in the positive direction, the MCPDP technique utilizes the potentiodynamic anodic polarization technique, i.e., the specimen is forced to act as an anode such that it corrodes. This technique can be used to determine the corrosion behaviors of a metal in an environment of interest. When the applied potential is scanned in the negative direction, the specimen acts as a cathode thus accelerating the reduction reactions at the surface of the substrate. When the scan is in the negative direction, it utilizes the potentiodynamic cathodic polarization technique, which is useful for studying the reduction characteristics of a metal in an environment. By using the negative applied potential, the MCPDP technique also utilizes the principle used in the ASTM G8-85 standard test method for cathodic disbonding of pipeline coatings, which evaluates the protective performance of a pipeline coating on steel substrates under the influence of an electrical stress in a conductive alkaline electrolyte [17]. The electrical stress, which accelerates the disbonding of the coated panel near the perforated area, is provided by means of a sacrificial magnesium anode or from a cathodic potential. The disbonding of the coating in this case is due to the attack of the coating/steel bonds by the highly alkaline environment caused by the OH^- ions formed on the surface of the steel as a result of the reduction reaction (Reaction 2) [3,18]. The applied cathodic potential can increase the size of the existing defects, such as holidays, and in some cases, can induce defects in a coated specimen.

Besides accelerating the processes at the metal/coating interface, the MCPDP technique may also accelerate the migration of corrosive elements from the environment through the coatings to the metal/coating interface. For example, Leidheiser [3] reported that, in the presence of an applied cathodic potential of -0.8 V (vs. SCE), the diffusion coefficients of Na^+ and water were increased by one order of magnitude as compared to those in the absence of the applied potential. The applied anodic potential may also provide the driving force to accelerate the movement of anions through certain coatings [19]. Another important advantage of the MCPDP technique is that the procedure is simple and takes a short time, sometimes only a few minutes, to complete the measurements.

Under certain experimental conditions, the potential/current curves obtained by the MCPDP technique may provide information on the polarization resistance and corrosion rates of coated metals using the same principle described for the polarization resistance technique. This technique has been useful to obtain quantitative information on the corrosion of metals in solutions.

The main disadvantage of the MCPDP technique may be the relatively large excursions of the applied potential relative to the corrosion potential. This may disturb the coating barrier properties and nature of substrate surface during testing as discussed earlier for the polarization curve techniques. However, in the MCPDP technique, although there are somewhat larger excursions from E_{corr} than in the polarization resistance technique, the applied potentials are lower than those employed in the polarization curve technique that has been used for evaluating coating systems [7]. Further, in an MCPDP experiment, the ion movement in the anodic direction is quickly balanced by the ion movement in the opposite direction; the net effect is probably minimal. The fast scanning rate used in an MCPDP experiment may also reduce the possibility of introducing physical change in the coating and metal/coating interface during testing. From the above discussion, it appears that the MCPDP technique may potentially become a valuable technique for (1) evaluating the corrosion resistance performance of protective coatings and coating systems, (2) predicting the performance of coating systems in service, (3) screening coatings and corrosion inhibitors, and (4) optimizing parameters in coating formulations and development.

3. Experimental Procedures

3.1 Specimen Preparation

Rough, AISI 1010, 75 × 125 mm, cold-rolled steel panels with various coatings were used for the evaluation. One white alkyd and one clear acrylic coatings were used. Prior to applying the coating, steel surface was cleaned repeatedly with acetone and methanol and blown dry with dry air. The coating applications were carried out using appropriate blade applicators. To test the usefulness of the MCPDP technique, the following experimental parameters were varied in the samples: film thickness, coating curing conditions, defects in coatings, and substrate surface contamination concentration. A thickness gage was used for the coating thickness measurements. No attempt was made to optimize the curing conditions of the coated panels used in this work. The characteristics of the tested specimens are summarized in table 1. Except for the specimens used in figures 3 and 4, where the defect-free areas were selected for the test, the testing areas of other specimens were selected randomly; that is, the selected test areas may contain minor defects such as particle inclusion, air bubbles, etc.

Table 1. Preparation conditions of organic coated steel specimens

Fig. No.	Coating Type	Thickness	Cured Condition	Contaminant/Defects
3	opaque alkyd	130 μm	20 days, ambient	—
4	clear acrylic	70 μm	6 days, ambient	—
5a	opaque alkyd	60 μm	2 h, 90 °C air-circ.	—
5b	clear acrylic	70 μm	2 h, 90 °C air-circ.	—
6a	clear acrylic	95 μm	5 days, ambient	—
6b	clear acrylic	70 μm	5 days, ambient	—
6c	clear acrylic	30 μm	5 days, ambient	—
8a	opaque alkyd	130 μm	8 days, ambient	—
8b	opaque alkyd	75 μm	8 days, ambient	—
9a	opaque alkyd	60 μm	5 days, ambient	without cont.
9b	opaque alkyd	60 μm	5 days, ambient	0.00001 M, KHSO_4
9c	opaque alkyd	60 μm	5 days, ambient	0.001 M, KHSO_4
10a	clear acrylic	30 μm	2 h, 90 °C	without chip
10b	clear acrylic	30 μm	2 h, 90 °C	chip inclusions
10c	clear acrylic	30 μm	2 h, 90 °C	chip inclusions
12	clear acrylic	60 μm	6 days, ambient	air bubbles
14a	opaque alkyd	50 μm	2 h, 90 °C air-circ.	—
14b	opaque alkyd	50 μm	24 h, 90 °C air-circ.	—

3.2 Electrochemical Instrumentation Set-Up and Measurements

All electrochemical measurements were carried out in a 50-mm diameter by 25-mm height poly(methyl-methacrylate) cylinder cell, which was mounted on the specimen by a silicone rubber adhesive. The area of the specimen under test was 1960 mm². The reference electrode was a Ag/AgCl wire in 1N KCL solution and the counter electrode was a platinum plate. The configuration of the test cell and the electrodes are illustrated in figure 1. All measurements presented in this report were taken at room temperature (24 °C) using 3% NaCl (by mass) as the electrolyte.

To provide the dynamic applied potentials, we use a potentiostat system equipped with a microprocessor. The system allowed automatic control of the scanning rate and potential magnitudes. An X-Y recorder was employed to record the potential/current signal. Figure 2 shows the schematic diagram of the measurement system. Before each measurement, the specimen was allowed to stand in the electrolyte for several minutes to attain a relatively stable E_{corr} . The experiment began with a scan in the negative direction, starting from E_{corr} (about -0.5 V vs. Ag/AgCl for most of the specimens). When reaching the preset -1.8 V potential, it reversed the direction and scanned toward the positive potential, going through E_{corr} . When reaching the

preset +1.8 V potential, it reversed the direction and scanned toward the negative potential again. This cycle between -1.8 and +1.8 V potentials was repeated until a preselected value of the polarization current was attained or a desired testing time was reached. (The current was read directly from the potential/current chart.) A scanning rate of 0.1 V/s was used throughout the study. High stable and current interruption modes were used to stabilize the small signal generated and to compensate for the ohmic potential drop, respectively. The polarization current values presented in this report were derived from the corresponding maximum applied potentials, which are -1.8 V for the negative potential and +1.8 V for positive potential.

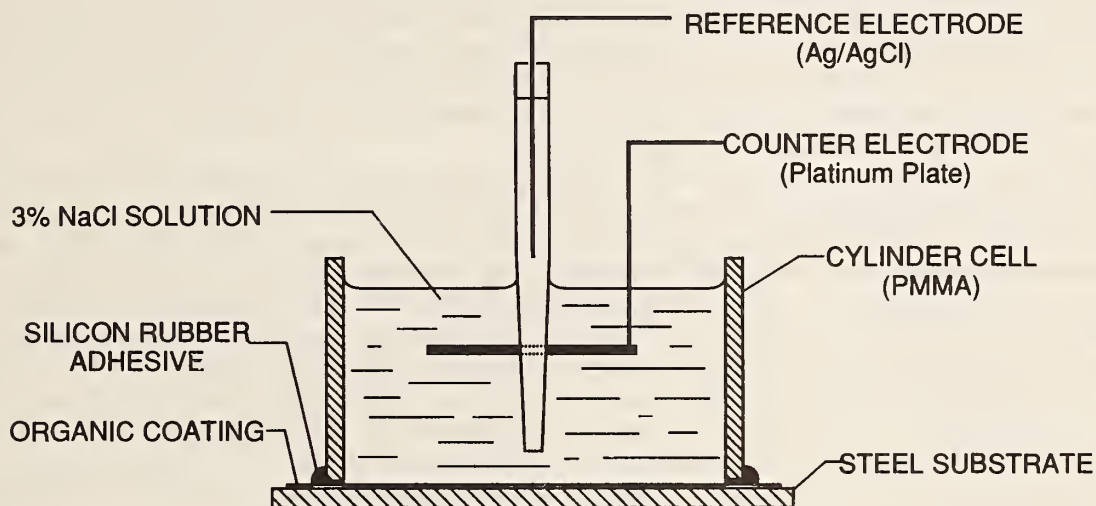

Figure 1. Electrochemical test cell.

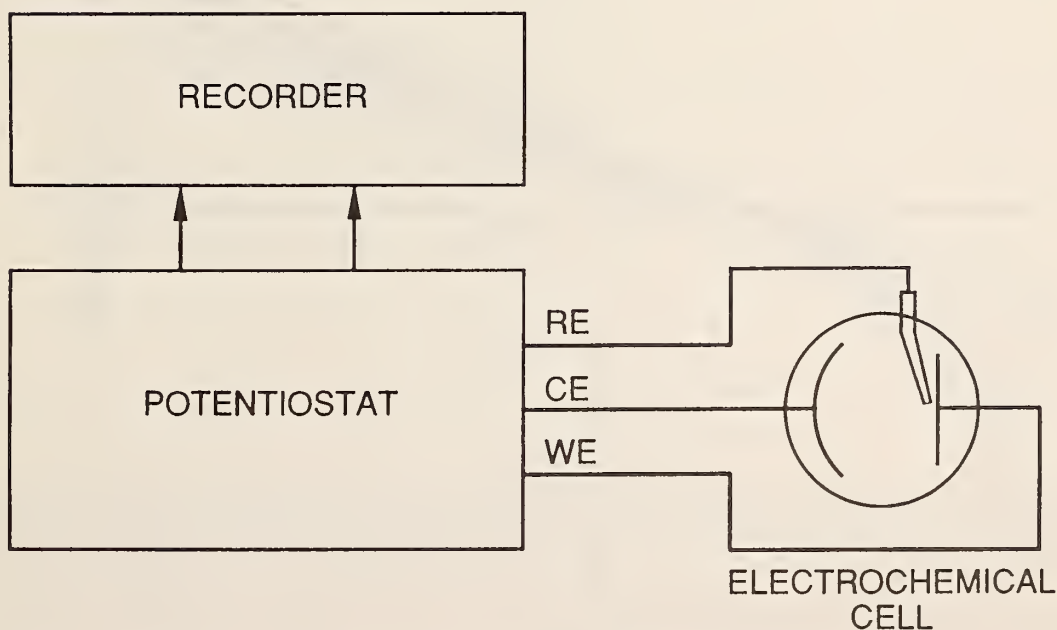

Figure 2. Schematic diagram of the multicyclic potentiodynamic polarization measurement system.

4. Results and Discussion

4.1 Effects of Coating Integrity on MCPDP Results

As indicated earlier, the primary concern about the MCPDP technique is that the applied potentials may damage the coatings. To address this question, two apparently defect-free (as observed by an optical microscope) coated specimens, one opaque and one clear, were subjected to the MCPDP test for an extended period in 3% NaCl solution. The polarization currents were constantly monitored during this period. At the end of the period, the sample was gently pricked with a fine needle, and the MCPDP test resumed.

Figure 3 shows the MCPDP curves of a 20-day, air-cured, 130- μm , white alkyd coating on steel that was subjected to the MCPDP test for 3 hours and then pricked with a needle. The dark line on the horizontal axis is from the repeated scans during the 3-hour test, and the curves away from the horizontal axis are for scans at various times after the specimen was pricked. Figure 3 indicates that no detectable current flowed during the 3 hours when there were no conductive paths in the coating, and that polarization currents (anodic and cathodic) occurred as soon as the coating was damaged.

Figure 4 presents similar curves for a 70- μm , clear acrylic coating on steel subjected to the MCPDP test for 90 minutes (dark line on the horizontal axis) before being pricked with a needle (curves away from the horizontal axis). Similarly to the alkyd coated specimen, the currents increased sharply due to the presence of a breakthrough defect in the coating, and no current flowed when there was no continuous conductive path between the substrate and the solution. The immediate occurrence of currents in these samples after pricking indicated that corrosion had occurred on metal at the exposed area (pricked area). This was seen clearly by a microscopic examination after withdrawing the electrolyte and exposing the specimens to the air for a few hours. No corrosion was observed if the specimen was not pricked with a needle. The results shown in figures 3 and 4 suggest that the MCPDP technique caused very minimum, if any, physical damage to the coatings during testing. It should be noted that the polarization resistance at any time of the pricked, coated samples may be estimated from figures 3 and 4 by using the narrow range in the vicinity of E_{corr} on the MCPDP curves.

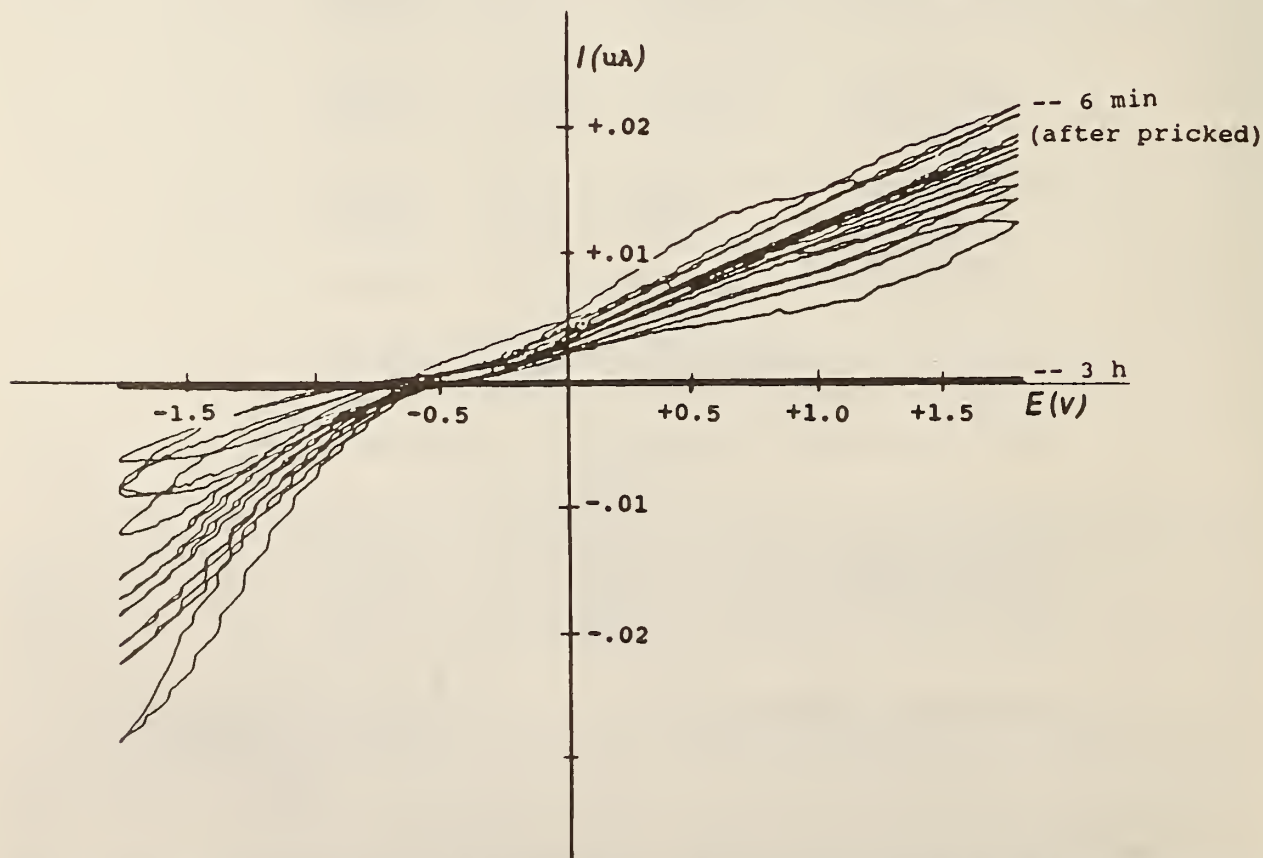

Figure 3. MCPDP curves for a 130- μm , opaque alkyd coating on steel in 3% NaCl solution before (dark line on the horizontal axis) and after pricking with a needle (curves away from the horizontal axis).

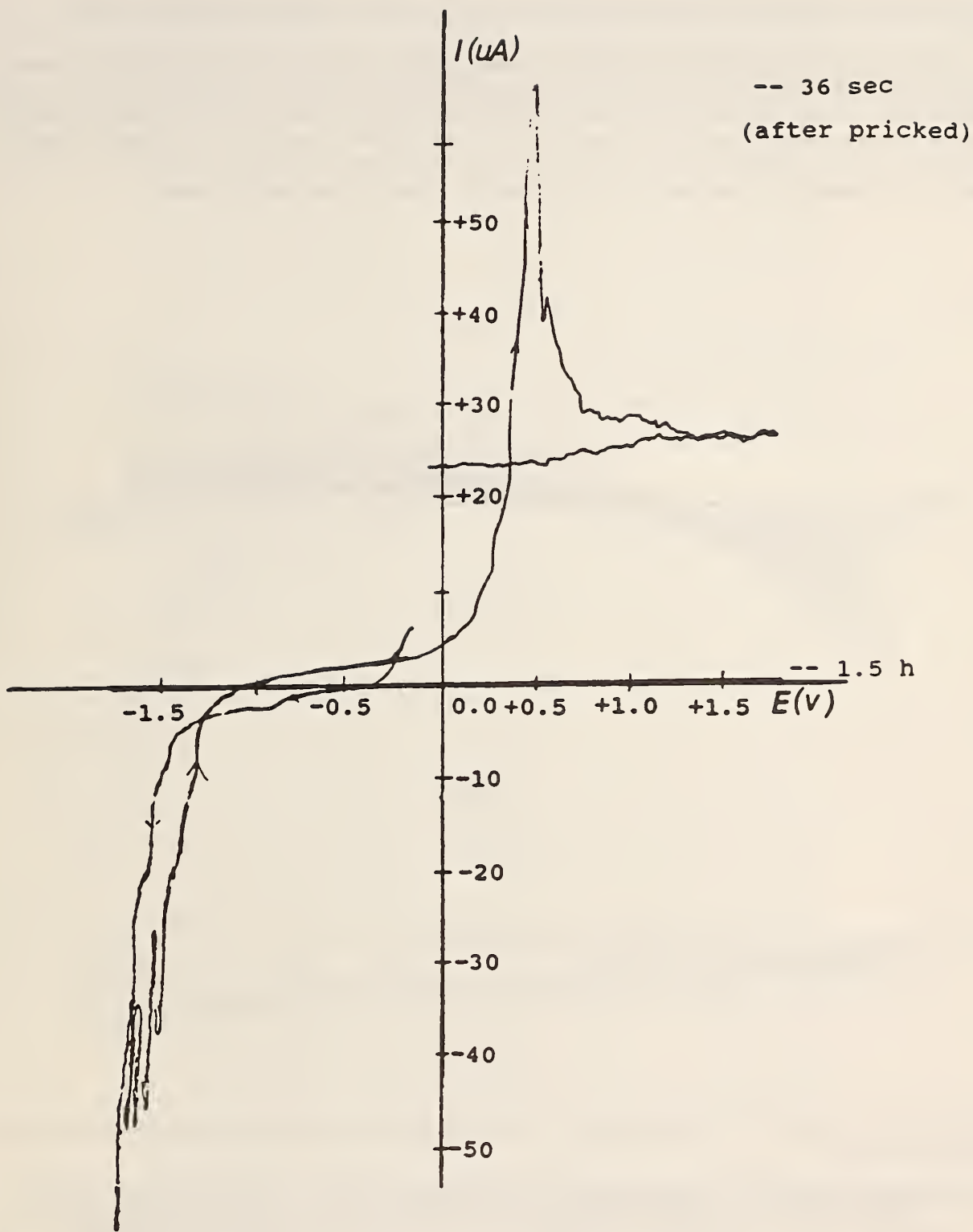

Figure 4. MCPDP curves for a 70- μm , clear acrylic coating on steel in 3% NaCl solution before (dark line on the horizontal axis) and after pricking with a needle (curves away from the horizontal axis).

4.2 Evaluation of the Effect of Coating Type on Corrosion Protection of Organic Coatings on Steel

Figure 5a is the MCPDP curve of a 60- μm , opaque alkyd coating on steel that was cured for 2 hours at 90 °C in an air-circulated oven, and figure 5b illustrates the MCPDP curves of a 70- μm , clear acrylic coating on steel that went through the same curing schedule. It took 40 minutes under the MCPDP test to generate an anodic current of 0.003 μA for the opaque alkyd coating. On the other hand, it took only 4 minutes to produce an anodic current of 0.014 μA for the clear acrylic coating. Obviously, the tested alkyd coating, despite being thinner, provided better corrosion protection than the tested acrylic coating.

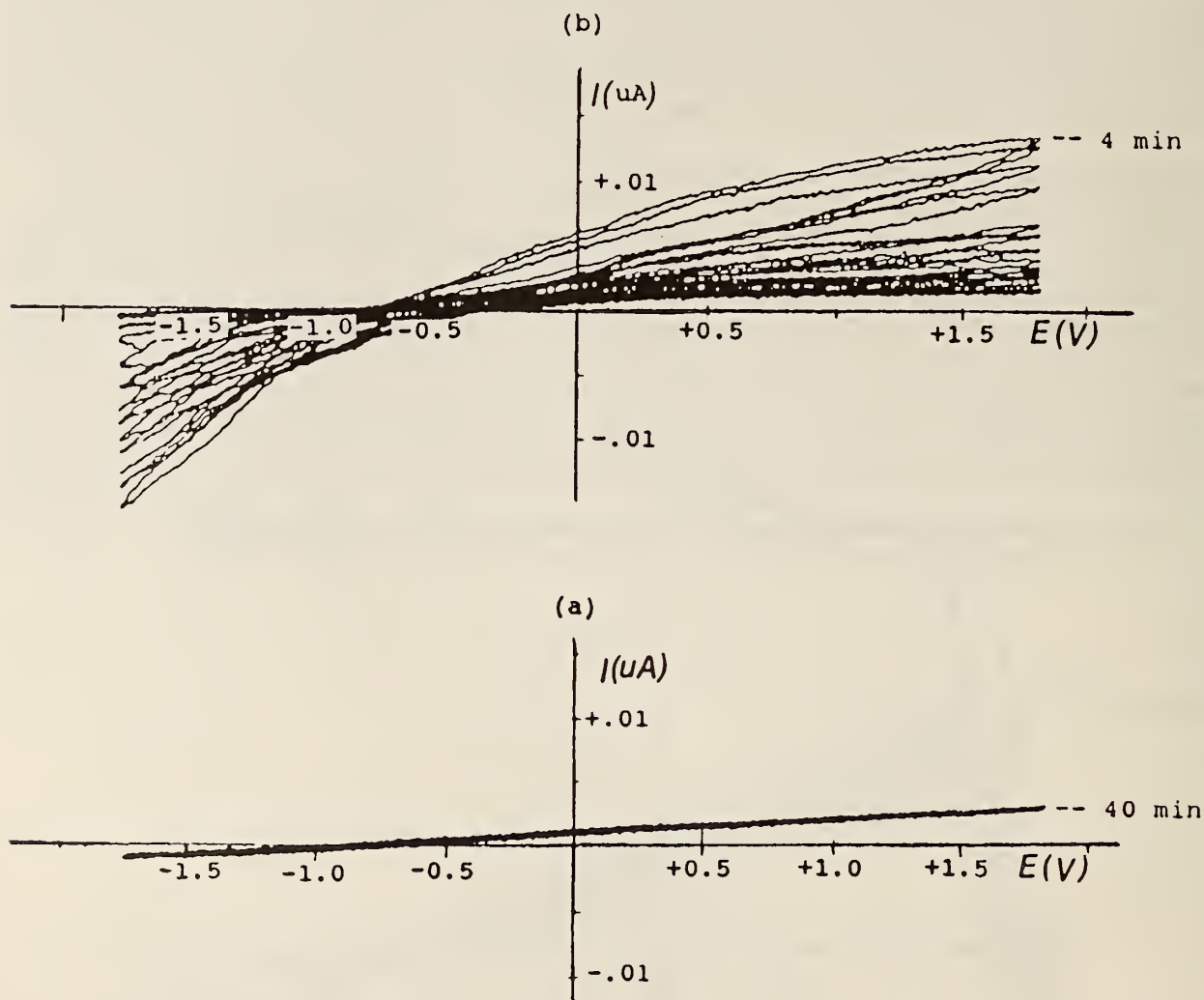

Figure 5. MCPDP curves for steel coated with different coatings in 3% NaCl solution: (a) 60- μm , opaque alkyd coating, (b) 70- μm , clear acrylic coating.

4.3 Evaluation of the Effect of Coating Thickness on Corrosion Protection of Organic Coatings on Steel

The thickness of a coating on a metal surface is an important factor in determining the protective properties of the coating. Figure 6 presents the MCPDP curves for a clear acrylic coating having thicknesses of 95, 70 and 30 μm on steel. These coatings were cured for 5 days at ambient environment (24 °C and 50% RH). The 95- μm coated specimen gave rise to an anodic current of 0.003 μA after 3 hours of testing (fig. 6a), while the 70- μm coated specimen produced an anodic current of 0.004 μA after 90 minutes of testing (fig. 6b). The 30- μm coated specimen produced a 0.015 μA anodic current and 0.034 μA cathodic current after only 4 minutes of MCPDP testing. Even after polarization currents had occurred in these clear coating specimens, the corrosion products could not be seen, even under a microscope at 60X. The corrosion products were

observed only after further immersion in the electrolyte. This can be seen from figure 7. These results indicated that the MCPDP technique is very sensitive to corrosion reactions at the metal/coating interface. Not only does it accelerate the corrosion reactions but it also detects the resulting currents as soon as there is continuous pathway through the coating to conduct the currents from the metal to the solution. This technique may, therefore, provide early information rapidly about the corrosion protection of a coating in the medium of interest.

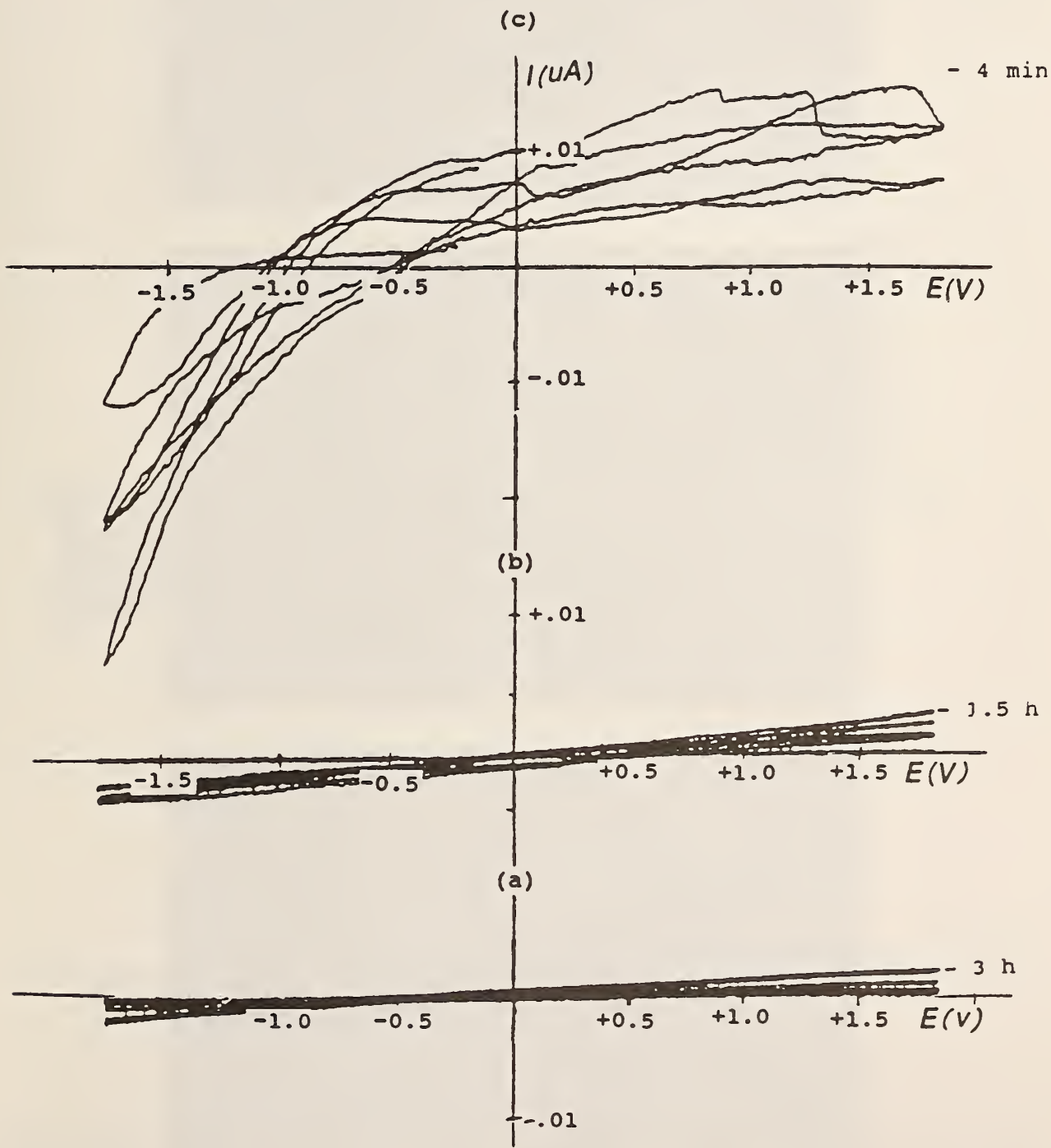
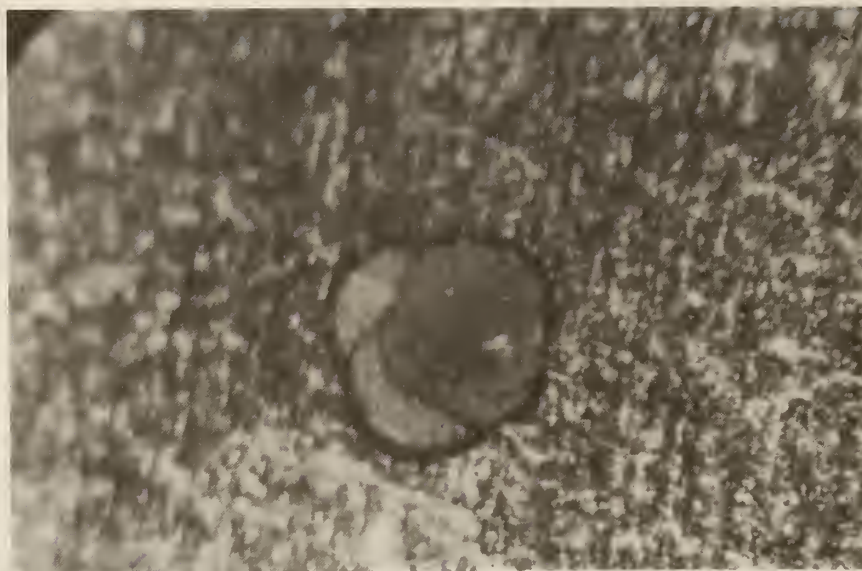

Figure 6. MCPDP curves for steel coated with a clear acrylic coating at different film thicknesses in 3% NaCl solution: (a) 95 μm , (b) 70 μm , (c) 30 μm .

(c)



(b)



(a)



Figure 7. Photographs of corrosion of the samples corresponding to the results presented in figure 6.

Figure 8 presents similar results for 130- and 70- μm films of an opaque alkyd coating on steel. These coated specimens had been cured for 8 days at ambient conditions. The 130- μm coated specimen produced only 0.002- μA anodic current after 30 minutes of testing (fig. 8a), while the 75- μm coated specimen gave rise to 0.022- μA anodic current after the same period. (The difference in corrosion protection between the specimen whose result is illustrated in fig. 8a and that shown in fig. 3 may be due to the shorter curing time or the inclusion of minor defects in the former.) The results in figures 6 and 8 indicate that the MCPDP method can provide very useful information on the variation of one or more properties of a coating that affect its corrosion protection performance.

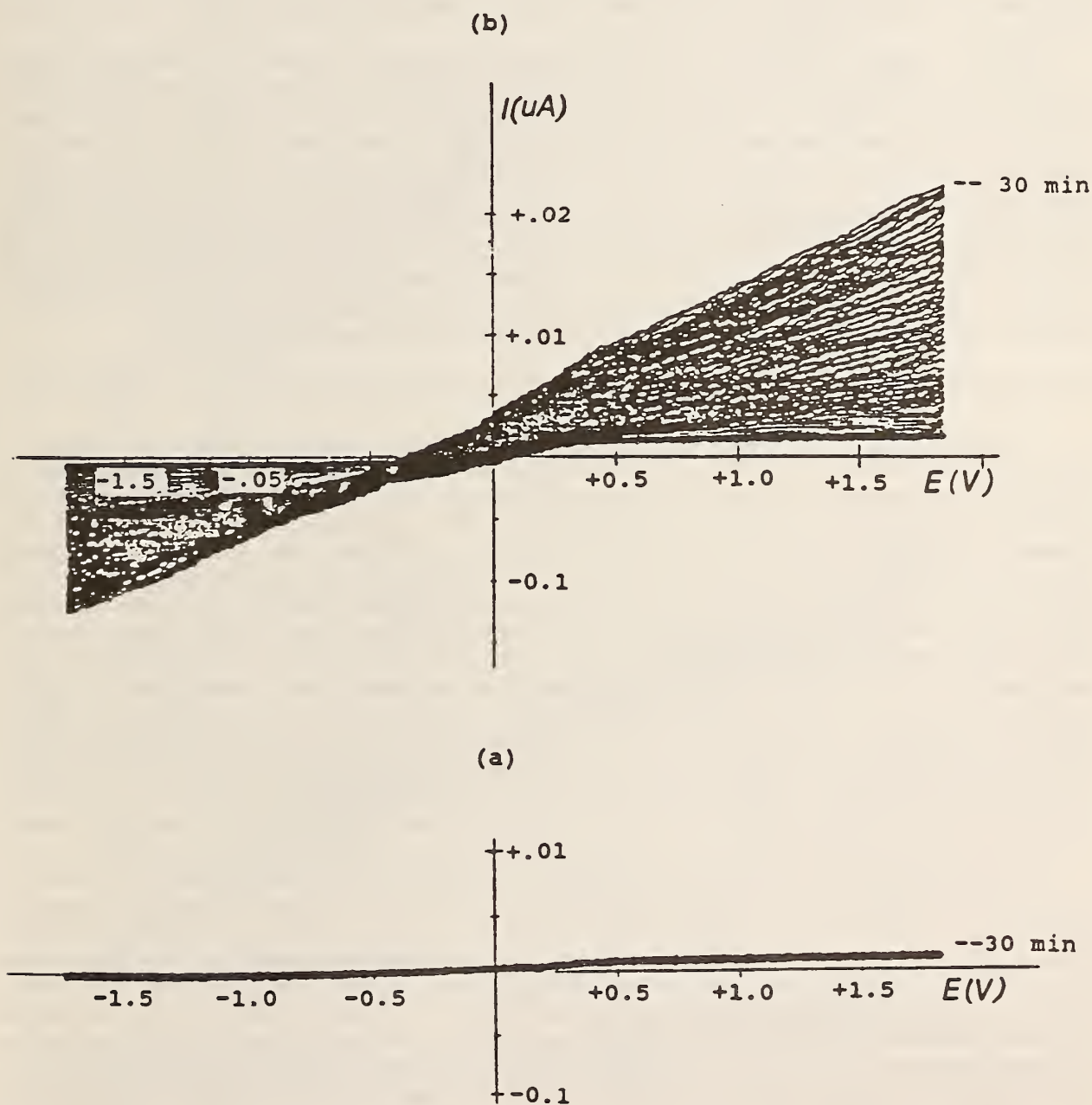

Figure 8. MCPDP curves for steel coated with an opaque alkyd coating at different film thicknesses in 3% NaCl solution: (a) 130 μm , (b) 75 μm .

4.4 Evaluations of the Effect of Contaminants on Corrosion Protection of Organic Coatings on Steel

Contaminants present on a metal surface before or after coating application are one of the main factors contributing to the early failure of a protective coating system [20]. Contaminants can affect the performance of a coating by accelerating the corrosion of the substrate, and promoting the blistering and adhesion failure of the coating. Development of a method that can provide information on the effects of contaminants on the performance of a protective coating should have many uses, such as for evaluating surface preparation and cleaning methods, and investigating the effects of acid rain and marine deposits. Figure 9 provides one example that demonstrates the use of the MCPDP technique for rapidly evaluating the effects of contaminants on the corrosion protection property of an opaque alkyd coating on steel. Coating thicknesses of these samples were about 60 μm . The contamination was introduced by depositing two ca. 5-mm diameter drops of KHSO_4 solution on the cleaned substrate surface, then drying in a desiccator for 1 day before the coating application. The electrochemical test cells were mounted so that the contaminant spots were within the testing area.

Figure 9a presents the MCPDP curves of a coated specimen in the absence of a contaminant on the substrate surface. This figure shows an anodic current of only about 0.007 μA after 10 minutes of the MCPDP test. When the steel surface was contaminated with 0.00001 M KHSO_4 solution, the anodic current increased to 0.017 μA after only 5 minutes under the MCPDP test (fig. 9b); and when the KHSO_4 contamination concentration increased from 0.00001 to 0.001 M, the anodic current increased nearly three times at +1.2 V applied potential after about 4 minutes of testing (fig. 9c). Figure 9 indicates that, within the concentration range studied, the higher the KHSO_4 concentration, the shorter the time required for corrosion of steel under the coating to occur. The results also indicate that the higher the KHSO_4 concentration the higher the rate of corrosion. It is interesting to note that, at higher contamination concentrations, the anodic processes of steel under a coating in NaCl electrolyte became more complicated than the cathodic processes under the same conditions, as evidenced by the erratic behaviors of the currents in the anodic region (fig. 9c).

4.5 Evaluation of the Effect of Defects in the Coatings on Corrosion Protection of Organic Coatings on Steel

The performance of an organic protective coating depends on its barrier properties. The presence of defects, such as pinholes, air bubbles, and particle inclusions, will provide pathways for corrosive agents to reach the metal surface. This will result in premature failure of a coating system. Figures 10 and 12 are presented to demonstrate the ability of the MCPDP technique to detect the effects of air bubbles and chip inclusions on the performance of a clear acrylic protective coating. Figures 11 and 13 are the corresponding photographs of the defect-included samples, which show the sites where corrosion starts and the direction of its propagation. The clear coating was selected so that the defects could be observed with either the naked eye or an optical microscope. For obtaining a bubble-free coating on steel, the coated specimen was cured for 1 day at ambient conditions then 2 hours at 90 $^\circ\text{C}$ in an air-circulated oven. The chip inclusion specimens were also prepared in the same manner, except that the chips (from the partially cured, gummy resins around the opening of the can containing the coating) were mixed with the coating before the coating application. These chips were not obvious to the naked eye before the testing because they were small and not very different in appearance from the coating. The air bubbles were introduced in the specimens by mixing the viscous coating vigorously just before the coating application. The distribution of the bubbles on the panel was not uniform. However, the test area on the panel was selected, by moving the test cell around, so as to include the desired air bubbles. The dry coating thicknesses of these samples were about 30 μm .

The coated specimen without chip inclusion (fig. 11a) produced an anodic current of 0.002 μA after 10 minutes of the MCPDP test as presented in figure 10a. The chip-included specimen illustrated in figure 11b gave rise to an anodic current of 0.010 μA (fig. 10b) after 8 minutes of testing. Another chip-included specimen (fig. 11c) produced an anodic current of 0.025 μA after 5 minutes of testing (fig. 10c). These results suggested that the chip inclusion in the specimen shown in figure 11c caused this specimen to be less corrosion resistant than the chip-included specimen presented in figure 11b. Figures 11b and 11c show the greenish corrosion products developed around the chips; the anodes are at the chip sites and the cathodes are at the periphery. Apparently, the coating and the partially cured chip particles did not form a continuous phase, thus allowing the corrosive elements to reach the metal surface quickly at the chip sites. The photographs presented in figures 11b and 11c were taken after 3 hours of testing; and the greenish corrosion products could be seen by the naked eye about 1 hour before that. Figures 10b and 10c, however, showed the polarization currents only after very short testing periods, suggesting again that this technique is very sensitive to electrochemical changes resulting from corrosion reactions, and could be used for detecting corrosion long before it can be seen by the microscope or visually.

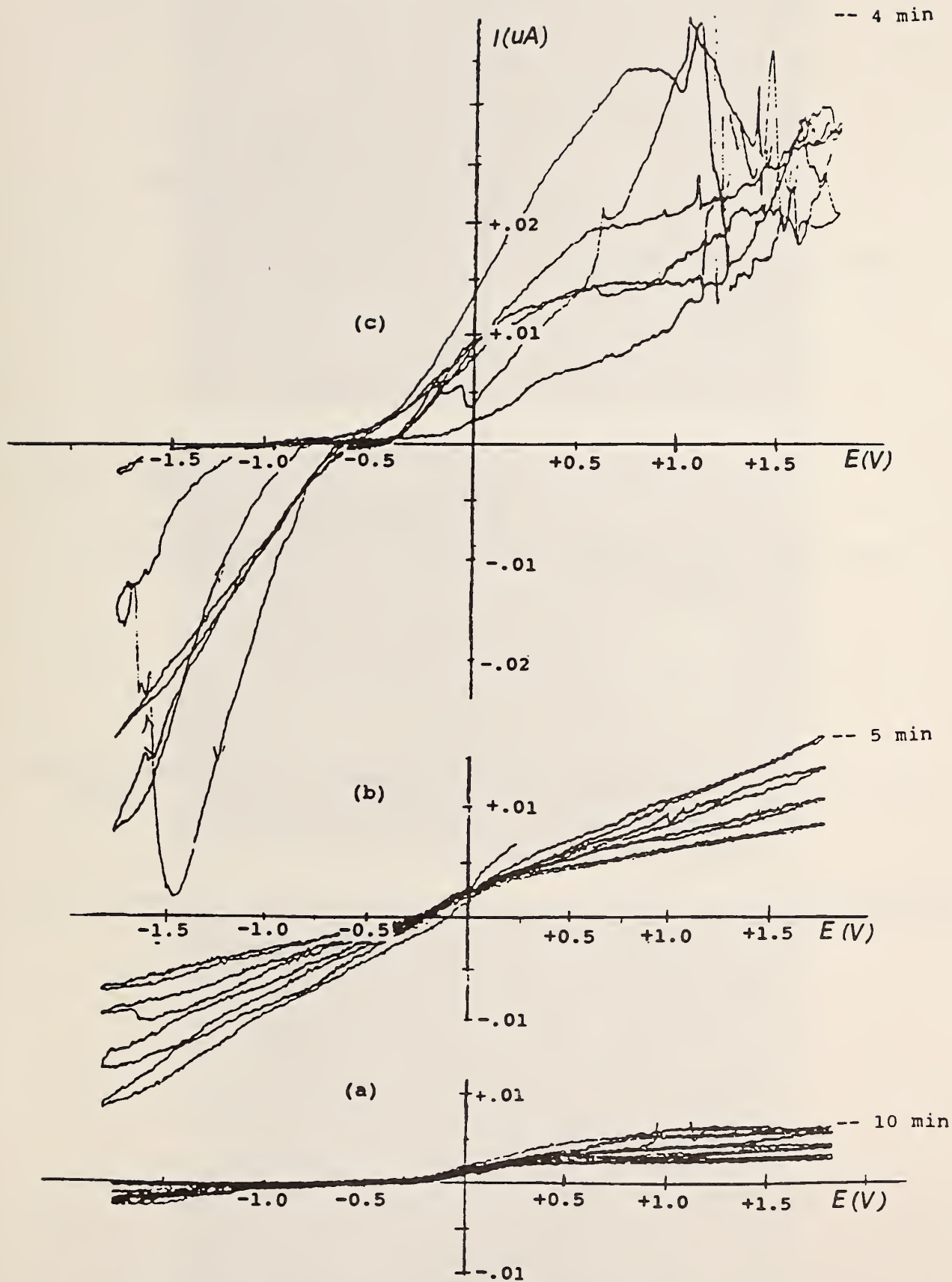

Figure 9. MCPDP curves for steel contaminated with different concentrations of KHSO_4 solution then coated with a 60- μm , opaque alkyd coating: (a) no contamination, (b) 0.00001 M KHSO_4 , (c) 0.001 M KHSO_4 .

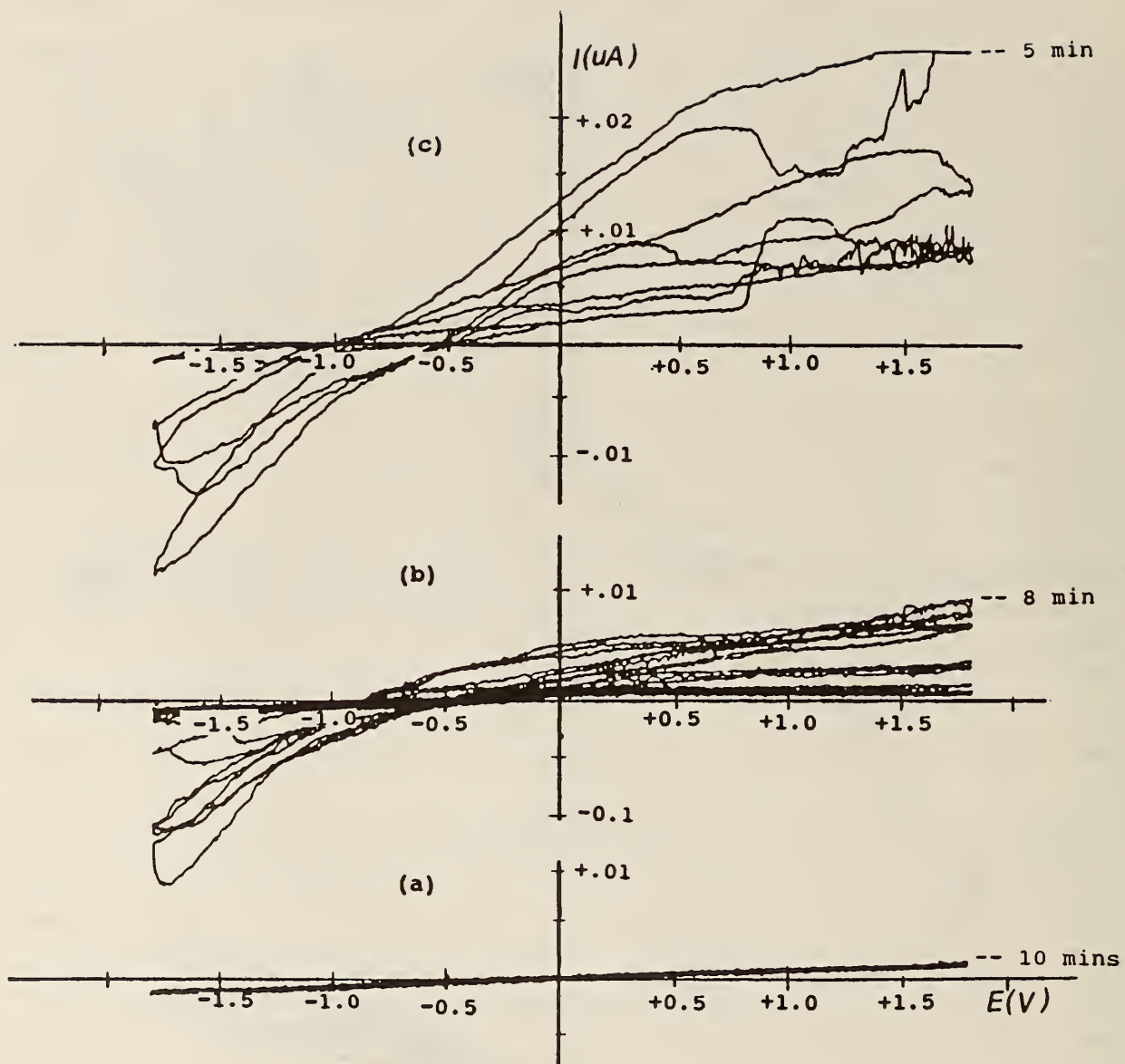
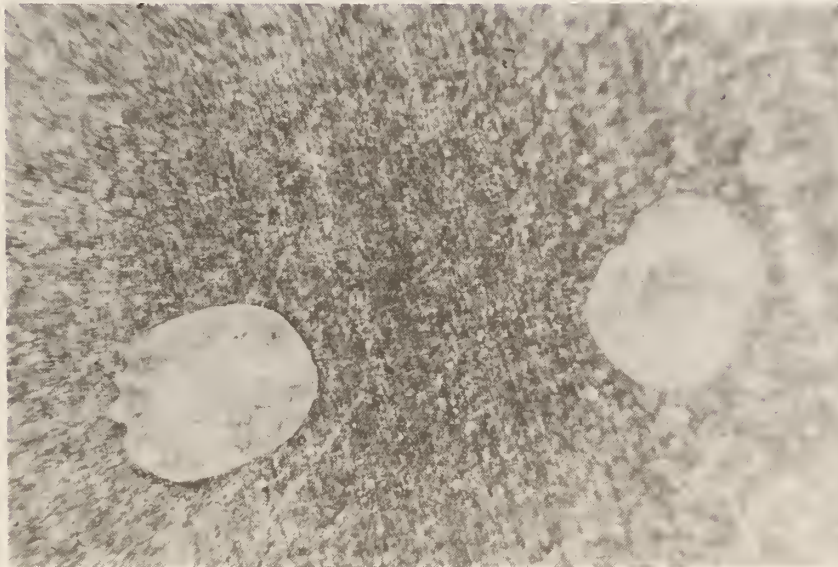

Figure 10. MCPDP curves for steel coated with a 30- μm , clear acrylic coating with and without chip inclusions in the samples: (a) without chip inclusion, (b and c) with chip inclusions.

(c)



(b)



(a)

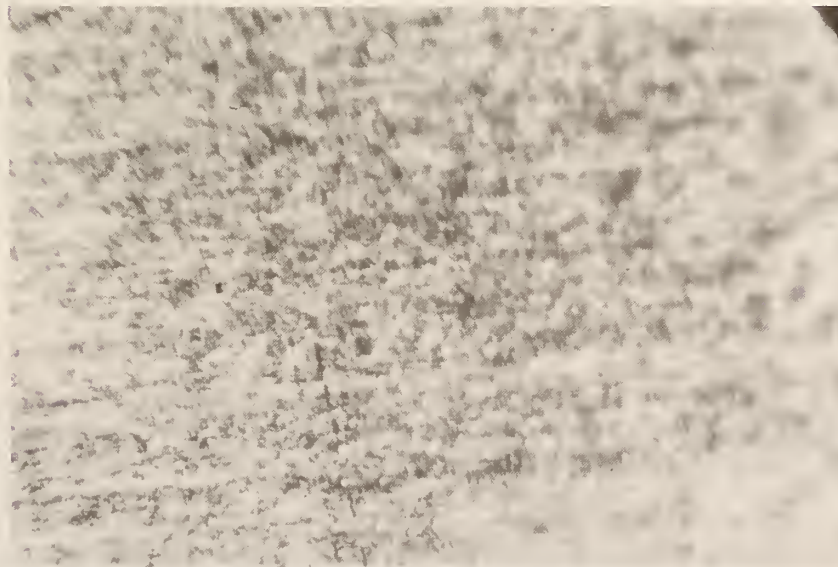

Figure 11. Photographs of corrosion of the samples corresponding to the results presented in figure 10.

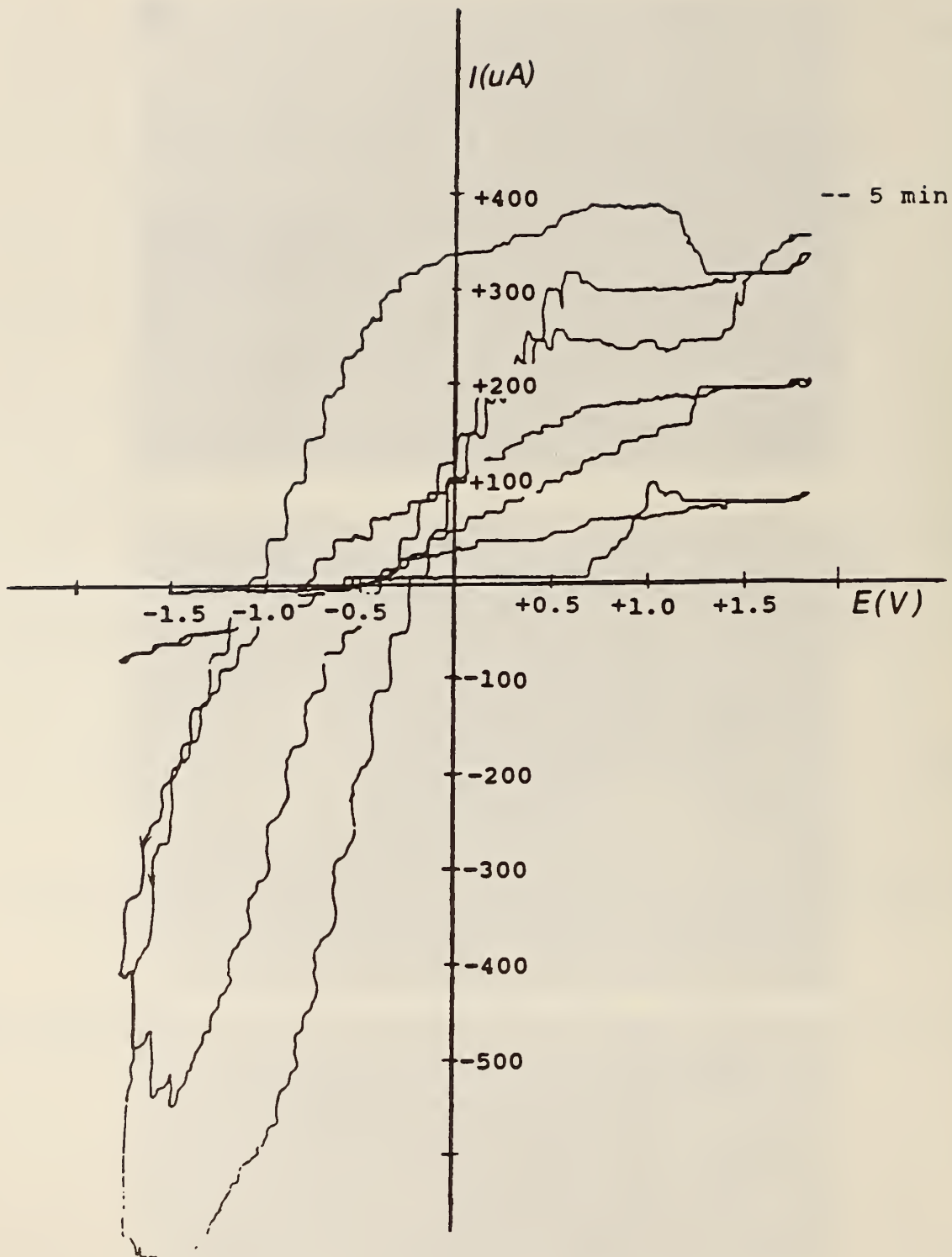

Figure 12. MCPDP curves for steel coated with a 60- μm , clear acrylic coating containing air bubbles.

Figure 12 presents the MCPDP curves of an air-bubble-inclusion specimen. The corrosion started in the air bubble and expanded to areas around the bubble as seen in figure 13. However, corrosion did not spread symmetrically around the bubble but seemed to prefer one side. Figure 12 shows that the polarization currents rose sharply after only 5 minutes of testing suggesting that there may be a breakthrough hole at the bubble. The curves of figure 12 indicate that the cathodic currents were much higher than the anodic currents for the duration of testing, suggesting that the reduction reactions were the more favorable reactions for corrosion in the air bubble. The availability of large amount of oxygen in the bubble may be the contributing factor.

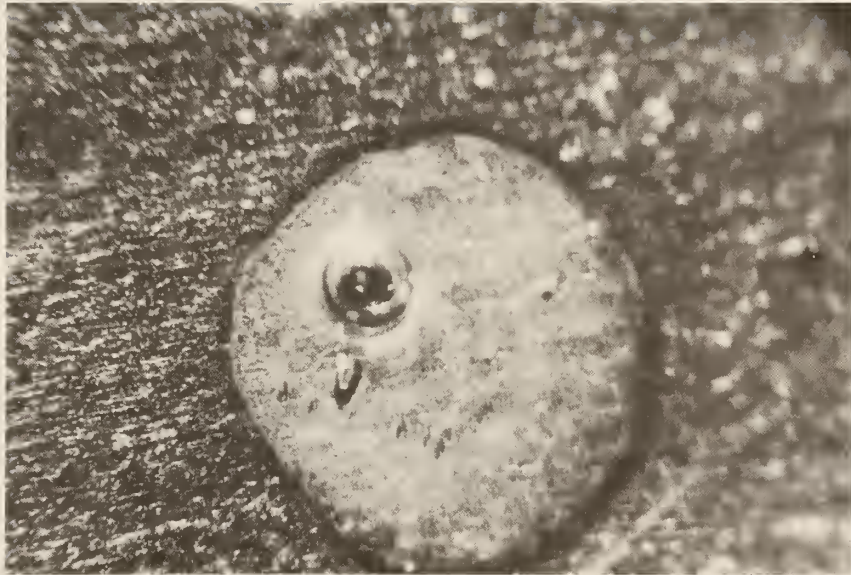

Figure 13. Photograph of corrosion of the sample corresponding to the results shown in figure 12.

4.6 Evaluation of the Effect of Curing Time on Corrosion Protection of Organic Coatings on Steel

The state of cure in a coating also has a great influence on the performance of a protective coating on metal. Under-cured coatings tend to allow faster permeation of corrosive elements, such as water, oxygen, and ions, through the coatings. Figure 14 illustrates an example of the use of the MCPDP technique for studying the effect of curing time on corrosion resistance properties of an opaque alkyd coating on steel. Figure 14a shows the MCPDP curves of a coated steel specimen that was cured for 2 hours at 90 °C in an air-circulated oven. Figure 14b is from the coated specimen that had the same film thickness (50 μm) and was cured at the same temperature but for a longer time, 24 hours. As evident in figure 14, both specimens produced almost the same polarization currents at the beginning of the test. However, the polarization currents of the 2-hour-cured specimen increased at a faster rate, to 0.008 μA , as compared to 0.005 μA for the 24-hour-cured specimen, after 30 minutes of testing. These results suggest that the 24-hour-cured, coated specimen has better corrosion resistance properties than the 2-hour-cured, coated specimen. This technique is thus potentially helpful for optimizing the curing conditions and other experimental variables in the development and formulation of protective coatings.

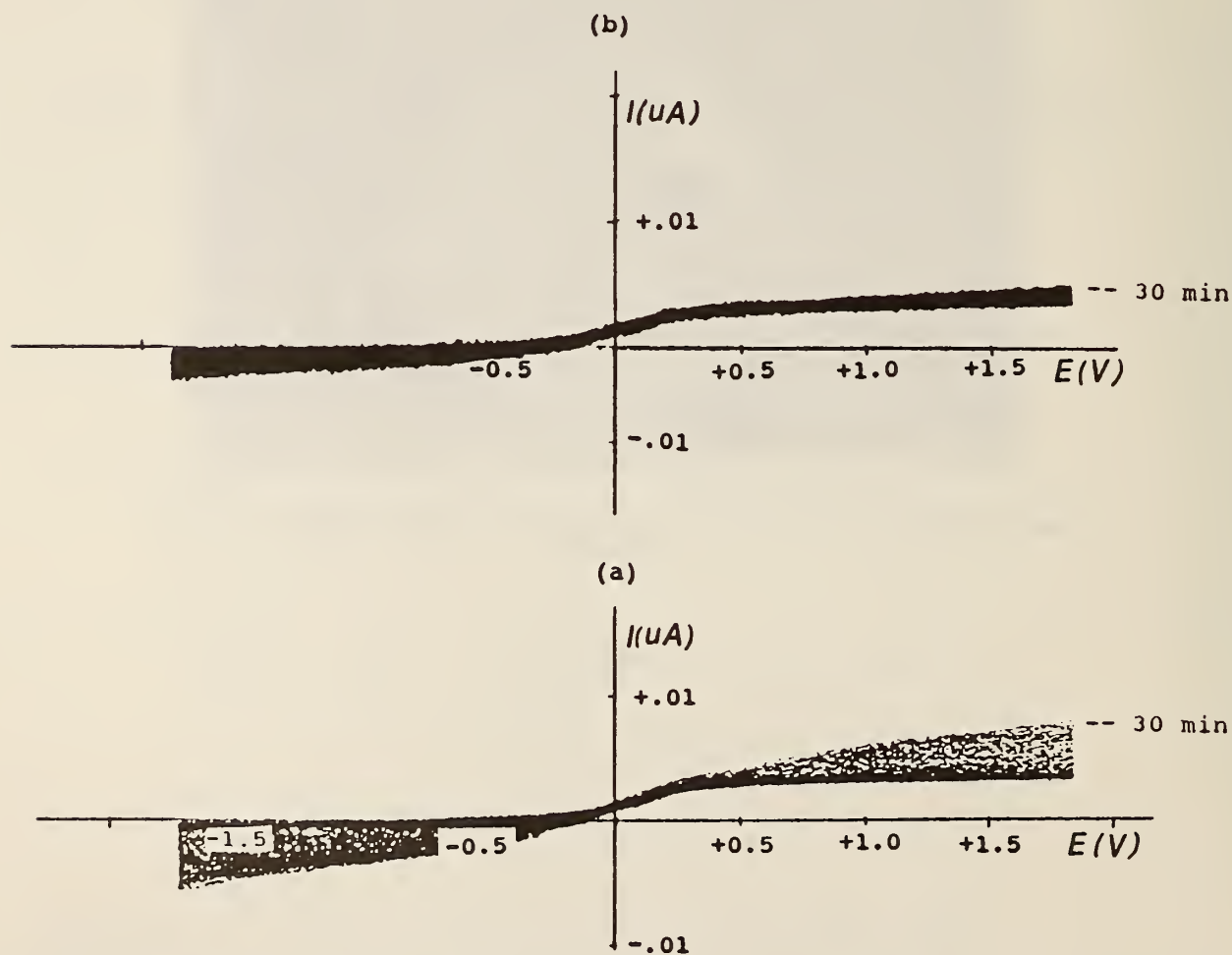

Figure 14. MCPDP curves for steel coated with a 50- μm , opaque alkyd coating cured for different times at 90 °C: (a) 2 hours, (b) 24 hours.

5. Conclusions

A new electrochemical technique based on repeated cycling of the applied scanning potentials for evaluating the corrosion resistance of a coating system was developed. The technique not only accelerates the corrosion processes and measures the magnitudes of the corresponding currents, but also provides the driving force to accelerate the movements of corrosive elements through the coatings. Preliminary results indicated that the technique is very sensitive to electrochemical processes at the metal surface. The technique also produces quick, reproducible and in situ results with very little damage to the coatings. The testing procedure is simple and uses commonly available instrumentation. This technique seems to possess most of the elements of a good accelerated method, as well as a good measuring technique for studying the corrosion protection and degradation mechanisms of a coating system in a corrosive environment. Further exploratory experiments, and work on the relationship between the results obtained by this technique and those from actual exposures are needed before the full potential of the technique can be determined.

6. Acknowledgment

We would like to express our thanks to Mr. Larry Masters, Dr. Mary McKnight and Dr. Geoffrey Frohnsdorff of the Building Materials Division, National Institute of Standards and Technology (NIST), for their many helpful discussions and suggestions. We also thank Dr. Anna Fraker, Metallurgy Division, NIST, and EG&G Princeton Applied Research for kindly making the instruments available during the course of this study, and Mr. Jim Seiler and Mr. Ned Embree, Building Materials Division, NIST, for their technical assistance.

7. References

- [1] L. H. Bennett, et al., Natl. Bur. Stand. (U.S.), Spec. Publ. 511-1, 1978.
- [2] G. Wranglen, An Introduction to Corrosion and Protection of Metals, Inst. for Metallskydd, Stockholm, 1972, p. 191.
- [3] H. Leidheiser, Jr., Corrosion 39, 189 (1983).
- [4] M. E. McKnight, T. Nguyen and J. W. Martin, Natl. Bur. Stand. (U.S.), NBSIR 85-3293, 1986.
- [5] J. Wolstenholme, Corrosion Science 13, 521 (1973).
- [6] H. Leidheiser, Jr., Progr. Organic Coatings 7, 79 (1979).
- [7] G. W. Walter, Corrosion Science 26, 39 (1986).
- [8] G. W. Walter, Corrosion Science 26, 681 (1986).
- [9] T. Szauer, Progr. Organic Coatings 10, 157 (1982).
- [10] T. Szauer, Progr. Organic Coatings 10, 171 (1982).
- [11] J. E. O. Mayne, J. Oil Colour Chemist Assoc. 40, 183 (1957).
- [12] B. S. Skerry and D. A. Eden, Progr. Organic Coatings 15, 269 (1987).
- [13] J. D. Scantlebury, K. N. Ho and D. A. Eden, Electrochemical Corrosion Testing, ASTM STP 727, F. Mansfeld and U. Bertocci, Eds., ASTM, Philadelphia, 1981, p. 187.
- [14] D. C. Mills and J. E. O. Mayne, in "Corrosion Control by Organic Coatings," H. Leidheiser, Jr., Ed., NACE, Houston, 1981, p. 12.
- [15] ASTM G5-87, Annual Book of ASTM, 1987, vol. 03.02, p. 124.
- [16] O. W. Siebert, Laboratory Corrosion Tests and Standards, ASTM STP 866, G. S. Haynes and R. Baboian, Eds., ASTM, Philadelphia, 1985, p. 65.
- [17] ASTM G8-85, Annual Book of ASTM, 1988, vol. 06.01, p. 895.
- [18] H. Leidheiser, Jr., W. Wang and L. Igetoft, Progr. Organic Coatings 11, 19 (1983).
- [19] H. Leidheiser, Jr., private communication.
- [20] A. R. Appleman, J. Protective Coatings and Linings 4, 68 (1987).

U.S. DEPT. OF COMM. BIBLIOGRAPHIC DATA SHEET <i>(See instructions)</i>	1. PUBLICATION OR REPORT NO. NIST/TN-1253	2. Performing Organ. Report No.	3. Publication Date October 1988
4. TITLE AND SUBTITLE An Electrochemical Technique for Rapidly Evaluating Protective Coatings on Metals			
5. AUTHOR(S) Changjian Lin and Tinh Nguyen			
6. PERFORMING ORGANIZATION <i>(If joint or other than NBS, see instructions)</i> NATIONAL INSTITUTE OF STANDARDS AND TECHNOLOGY (formerly NATIONAL BUREAU OF STANDARDS) U.S. DEPARTMENT OF COMMERCE GAITHERSBURG, MD 20899			7. Contract/Grant No. 8. Type of Report & Period Covered Final
9. SPONSORING ORGANIZATION NAME AND COMPLETE ADDRESS <i>(Street, City, State, ZIP)</i> SAME AS ITEM #6 ABOVE			
10. SUPPLEMENTARY NOTES <input type="checkbox"/> Document describes a computer program; SF-185, FIPS Software Summary, is attached.			
11. ABSTRACT <i>(A 200-word or less factual summary of most significant information. If document includes a significant bibliography or literature survey, mention it here)</i> <p>A new electrochemical technique based on multicyclic scanning potentials applied to a specimen in an electrolyte was developed and evaluated as a method for rapidly evaluating the corrosion protection performance of organic coatings on metal. Opaque alkyd and clear acrylic coated steel samples prepared at different thicknesses, curing conditions, defect inclusions, and contamination concentrations were used for the evaluation. The applied potentials were between -1.8 and +1.8 V, and the electrolyte was a 3% NaCl solution. Preliminary results indicate that this technique is useful for evaluating the corrosion protection properties of organic coatings on steel. The technique appears to offer a number of advantages: fast and in situ measurements, good reproducibility, high sensitivity, and minimal damage to the coating.</p>			
12. KEY WORDS <i>(Six to twelve entries; alphabetical order; capitalize only proper names; and separate key words by semicolons)</i> accelerating test method; coating; contamination; corrosion; electrochemical; evaluation; multicyclic polarization			
13. AVAILABILITY <input checked="" type="checkbox"/> Unlimited <input type="checkbox"/> For Official Distribution. Do Not Release to NTIS <input checked="" type="checkbox"/> Order From Superintendent of Documents, U.S. Government Printing Office, Washington, D.C. 20402. <input checked="" type="checkbox"/> Order From National Technical Information Service (NTIS), Springfield, VA. 22161			14. NO. OF PRINTED PAGES 23 15. Price

U.S. Department of Commerce
National Institute of Standards and Technology
(formerly National Bureau of Standards)
Gaithersburg, MD 20899

Official Business
Penalty for Private Use \$300



Stimulating America's Progress
1913-1988