

**Technical Note 1471**

# **A Review of Building Evacuation Models**

Erica D. Kuligowski  
Richard D. Peacock

**NIST**

**National Institute of Standards and Technology**  
Technology Administration, U.S. Department of Commerce



**Technical Note 1471**

# **A Review of Building Evacuation Models**

Erica D. Kuligowski  
Richard D. Peacock

*Fire Research Division  
Building and Fire Research Laboratory*

July 2005



**U.S. DEPARTMENT OF COMMERCE**

*Donald L. Evans, Secretary*

**TECHNOLOGY ADMINISTRATION**

*Phillip J. Bond, Under Secretary of Commerce for Technology*

**NATIONAL INSTITUTE OF STANDARDS AND TECHNOLOGY**

*Arden L. Bement, Jr., Director*

Disclaimer

Certain commercial entities, equipment, products, or materials are identified in this document in order to describe a procedure or concept adequately or to trace the history of the procedures and practices used. Such identification is not intended to imply recommendation, endorsement, or implication that the entities, products, materials, or equipment are necessarily the best available for the purpose.

Disclaimer

The policy of NIST is to use the International System of Units (metric units) in all publications. In this document, however, units are presented in metric units or the inch-pound system, whichever is prevalent to the discipline.

National Institute of Standards and Technology Technical Note 1471  
Natl. Inst. Stand. Technol. Tech. Note 1471, 156 pages (July 2005)  
CODEN: NSPUE2

U.S. GOVERNMENT PRINTING OFFICE  
WASHINGTON: 2005

---

For sale by the Superintendent of Documents, U.S. Government Printing Office  
Internet: [bookstore.gpo.gov](http://bookstore.gpo.gov) — Phone: (202) 512-1800 — Fax: (202) 512-2250  
Mail: Stop SSOP, Washington, DC 20402-0001

# Contents

1	Introduction.....	1
2	Features of Egress Models.....	3
2.1	Availability to the Public.....	4
2.2	Modeling Method.....	4
2.3	Purpose.....	4
2.4	Grid/Structure.....	5
2.5	Perspective of the Model/Occupant.....	5
2.6	Behavior.....	6
2.7	Movement.....	6
2.8	Fire Data.....	7
2.9	CAD.....	8
2.10	Visual.....	8
2.11	Validation.....	9
2.12	Summary of Category Labels.....	9
3	Summary of Egress Model Features.....	12
3.1	Tables.....	12
3.2	Overview of Model Features.....	19
3.3	Additional Egress Models.....	20
4	Conclusion.....	22
5	References.....	23
	Appendix A, Detailed Review of Available Egress Models.....	A-1

## Tables

Table 1. Overall features of egress models.....	13
Table 2. Models Available to the Public.....	14
Table 3. Model Available on a Consultancy Basis.....	16
Table 4. Models Not Yet Released .....	17
Table 5. Models No Longer in Use.....	18
Table 6. Models - Availability Unknown .....	18

## **Acknowledgements**

Dr. James Milke, Dr. John Bryan, both from the University of Maryland, and Dr. Kathy Notarianni (Worcester Polytechnic Institute) provided guidance and overall direction for the report, along with detailed and insightful review of the report. Dr. Rita Fahy from the National Fire Protection Association (developer of EXIT89), Dr. Peter Thompson from Integrated Environmental Solutions (developer of Simulex), Dr. Steve Gwynne from the University of Greenwich, Dr. Ed Galea from the University of Greenwich, and Dr. David Purser from the Building Research Establishment provided guidance in the use of their models and egress modeling in general.

In addition, the authors acknowledge the support of all of the model developers who aided in the understanding of their individual models by answering emails, phone calls, and/or sending publications.





# A Review of Building Evacuation Models

Erica D. Kuligowski and Richard D. Peacock  
Fire Research Division; Building and Fire Research Laboratory

## 1 Introduction

Evacuation calculations are increasingly becoming a part of performance-based analyses to assess the level of life safety provided in buildings<sup>1</sup>. In some cases, engineers are using back-of-the-envelope (hand) calculations to assess life safety, and in others, evacuation models are being used. Hand calculations usually follow the equations given in the Emergency Movement Chapter of the Society of Fire Protection Engineers (SFPE) Handbook<sup>2</sup> to calculate mass flow evacuation from any height of building. The occupants are assumed to be standing at the doorway to the stair on each floor as soon as the evacuation begins. The calculation focuses mainly on points of constriction throughout the building (commonly the door to the outside) and calculates the time for the occupants to flow past these points and to the outside.

To achieve a more realistic evacuation calculation, engineers have been looking to evacuation computer models to assess a building's life safety. Currently, there are a number of evacuation models to choose from, each with unique characteristics and specialties. The purpose of this paper is to provide a comprehensive model review of 30 past and current evacuation models for current and potential model users. With this information, a user can select the model or models appropriate for his/her design.

In order to be most useful to model users, this review categorizes the models initially by their availability; i.e. whether they are available to the public, via a consultancy basis, not yet released, or no longer in use. Once the models have been categorized by availability, information is provided for many features of each model, such as the modeling method, purpose, model structure and perspective, methods for simulating movement and behavior, output, use of fire data, use of visualization and CAD drawings.

Four evacuation model reviews are available which were significant in the terminology, organization, and data gathering found in this report. The most substantial review to date was performed by Gwynne and Galea<sup>3</sup> at the University of Greenwich, which largely influenced the model review featured in this paper. This report offers a review of 16 evacuation models and is referenced throughout this section. Second, Combustion Science and Engineering released an article on a review of fire and evacuation models, as well as developed a website where this information is available to the public<sup>4,5</sup>. Also, a review was performed by Watts<sup>6</sup> which introduced early network algorithm models, queuing models, and "simulation" models and provided examples of each type. Lastly, Friedman<sup>7</sup> also reviewed egress models, much in the same fashion as was performed by Gwynne and Galea.

In addition to the previously mentioned model reviews, there was a need for an updated, unbiased, and more detailed review to aid evacuation model users in choosing the appropriate model for their particular project. The previous four reviews listed were written before some of the newer models were developed, showing a need for a more updated review. Also, the previous model reviews could be expanded to provide additional detailed information for each model. Therefore, this review provides information on newly developed evacuation models, a more detailed explanation of model features, the inner workings of each model, and each model's validation methods and limitations.

## 2 Features of Egress Models

This review covers a total of 30 computer models that focus on providing evacuation data from buildings. Many of the models reviewed can also simulate evacuation from other types of structures; however evacuation from buildings is the main focus of this review. The models are organized in the review by their method of availability: available to the public, on a consultancy basis, not yet released, no longer in use, and unknown. A list of the models in the review is provided here in the order that they appear in the detailed review:

- Models available to the public: FPETool<sup>8</sup>, EVACNET4<sup>9, 10</sup>, TIMTEX<sup>11</sup>, WAYOUT<sup>12</sup>, STEPS<sup>13-17</sup>, PedGo<sup>18-20</sup>, PEDROUTE/PAXPORT<sup>21-27</sup>, Simulex<sup>28-35</sup>, GridFlow<sup>36</sup>, ASERI<sup>37-40</sup>, buildingEXODUS<sup>3, 41-43</sup>, EXITT<sup>44, 45</sup>, Legion<sup>46-48</sup>.
- Models available on a consultancy basis: PathFinder<sup>49</sup>, EESCAPE<sup>50</sup>, Myriad<sup>51, 52</sup>, ALLSAFE<sup>53-55</sup>, CRISP<sup>56-59</sup>, EGRESS<sup>60-62</sup>.
- Models not yet released: SGEM<sup>63, 64</sup>, Egress Complexity Model<sup>65, 66</sup>, EXIT89<sup>67-73</sup>, BGRAF<sup>74-77</sup>, EvacSim<sup>78, 79</sup>.
- Models no longer in use: Takahashi's Fluid Model<sup>80</sup>, EgressPro<sup>81</sup>, BFIRE-2<sup>82-84</sup>, VEgAS<sup>51, 52, 85</sup>.
- Models whose availability is unknown: Magnetic Model<sup>86</sup>, E-SCAPE<sup>87</sup>.

For each model, a special feature section is included in the review. The special features section verifies whether the model is capable of simulating at least one of the following list of ten specialized features. The specific features included in the review are as follows.

- Counterflow
- Manual exit block/obstacles
- Fire conditions affect behavior
- Defining groups
- Disabilities/slow occupant groups
- Delays/pre-movement times
- Elevator use
- Toxicity of the occupants
- Impatience/drive variables
- Route choice of the occupants/occupant distribution

For each model in the review, the feature is listed and described only if the model has the capability of simulating it in some way. Also, for each model, the method of simulating route choice is listed and described.

In the appendix of this report, each model is reviewed by providing information on a series of evacuation modeling categories, such as model availability, purpose, behavioral methods, etc. In addition, Table 1 of this report provides a brief summary of abbreviations of the categories for each model in the appendix. The following section of the report describes each category in detail and outlines how the models will be distinguished in both Table 1 and in the appendix.

## **2.1 Availability to the Public**

The category of availability is used as the main category of the model review because the user needs to first be aware of how the model can be accessed for a specific project. Even though there is a fair amount of literature on some models, they may be not yet released or even taken off of the market and no longer used. Also, it is important for the user to understand whether they will be able to purchase the model for their own personal use or if the model is used by the developing company only on a consultancy basis. In this category, some models are available to the public for free or a fee and are labeled (Y). Others are not available due to the following circumstances: the company uses the model for the client on a consultancy basis (N1), the model has either not yet been released (N2), or the model is no longer in use (N3). If the status of the model is unknown, it is labeled as (U) in Table 1.

## **2.2 Modeling Method**

In previous reviews, evacuation models have been categorized using a primary category labeled modeling method<sup>3</sup>. This category describes the method of modeling sophistication that each model uses to calculate evacuation times for buildings. Under the modeling method category, models are assigned one of the following three labels:

- Behavioral models (B): those models that incorporate occupants performing actions, in addition to movement toward a specified goal (exit). These models can also incorporate decision-making by occupants and/or actions that are performed due to conditions in the building. For those models that have risk assessment capabilities, a label of (B-RA) is given.
- Movement models (M): those models that move occupants from one point in the building to another (usually the exit or a position of safety). These models are key in showing congestion areas, queuing, or bottlenecks within the simulated building. For those models that are specifically optimization models (models that aim to optimize time in an evacuation), a label of (M-O) is given.
- Partial behavior models (PB): those models that primarily calculate occupant movement, but begin to simulate behaviors. Possible behaviors could be implicitly represented by pre-movement time distributions among the occupants, unique occupant characteristics, overtaking behavior, and the introduction of smoke or smoke effects to the occupant. These are models capable of simulating an entire building, and occupants' movements throughout the model are based on observed human behavior data.

## **2.3 Purpose**

This subcategory describes the use of the model as it pertains to certain building types. Some of the models in this review focus on a specific type of building and others can be used for all building types. The main purpose in using this as a category is to understand if the model can simulate the user's chosen building design.

The current model categories for purpose, as labeled in Table 1, involve models that can simulate any type of building (1), models that specialize in residences (2), models that specialize in public transport stations (3), models that are capable of simulating low-rise buildings (under 22.9 meters) only (4), and models that only simulate 1-route/exit of the building (5).

## **2.4 *Grid/Structure***

The subcategory of grid/structure is used to assess the method of occupant movement throughout the building. A fine network (F) model divides a floor plan into a number of small grid cells that the occupants move to and from. The coarse network (C) models divide the floor plan into rooms, corridors, stair sections, etc. and the occupants move from one room to another. A continuous (Co.) network model applies a 2D (continuous) space to the floor plans of the structure, allowing the occupants to walk from one point in space to another throughout the building. Fine and continuous networks have the ability to simulate the presence of obstacles and barriers in building spaces that influence individual path route choice, whereas the coarse networks “move” occupants only from one portion of a building to another.

## **2.5 *Perspective of the Model/Occupant***

The perspective subcategory explains 1) how the model views the occupants and 2) how the occupants view the building.

- 1) There are two ways that a model can view the occupant; globally (G) and individually (I). An individual perspective of the model is where the model tracks the movement of individuals throughout the simulation and can give information about those individuals (ex. their positions at points in time throughout the evacuation). When the model has a global view of the occupants, the model sees its occupants as a homogeneous group of people moving to the exits. It is clear to see that an individual perspective of the occupants is more detailed, but it depends on the purpose of the simulation as to which alternative is best. If the user is not interested in knowing the position of each occupant throughout the simulation or assigning individual characteristics to the population, then a global view is sufficient.
- 2) The occupant can view the building in either a global (G) or individual (I) way. An occupant’s individual view of the building is one where the occupant is not all knowing of the building’s exit paths and decides his/her route based on information from the floor, personal experience, and in some models, the information from the occupants around him/her. A global perspective of the occupants is one where the occupants automatically know their best exit path and seem to have an “all knowing” view of the building.

## 2.6 Behavior

The behavior of the occupants is represented in many different ways by the evacuation models in this review. The labels associated with this sub category are the following:

- *No behavior* (N) denotes that only the movement aspect of the evacuation is simulated
- *Implicit behavior*<sup>3</sup> (I) represents those models that attempt to model behavior implicitly by assigning certain response delays or occupant characteristics that affect movement throughout the evacuation
- *Conditional (or rule)* (C) behavior reflects models that assign individual actions to a person or group of occupants that are affected by structural or environmental conditions of the evacuation (as an “if, then” behavioral method)
- *Artificial Intelligence* (AI) resembles the models that attempt to simulate human intelligence throughout the evacuation.
- *Probabilistic* (P) represents that many of the rules or conditional-based models are stochastic, allowing for the variations in outcome by repeating certain simulations.

Some models have the capability of assigning probabilities of performing certain behaviors to specific occupant groups. Many of the partial behavioral models allow for a probabilistic distribution (P) of the pre-evacuation times, travel speeds, and/or smoke susceptibility.

## 2.7 Movement

The movement subcategory refers to how the models move occupants throughout the building. For most models, occupants are usually assigned a specific unimpeded (low density) velocity by the user or modeling program. The differences in the models occur when the occupants become closer in a high density situation, resulting in queuing and congestion within the building. The different ways that models represent occupant movement and restricted flow throughout the building are listed here:

- *Density correlation* (D): The model assigns a speed and flow to individuals or populations based on the density of the space. When calculating movement dependent on the density of the space, three sources of occupant movement data are typically used in evacuation models. These are Fruin<sup>88</sup>, Pauls<sup>89,90</sup>, and Predtechenskii and Milinskii<sup>91</sup>
- *User's choice* (UC): The user assigns speed, flow, and density values to certain spaces of the building

- *Inter-person distance (ID)*: Each individual is surrounded by a 360° “bubble” that allows them only a certain minimum distance from other occupants, obstacles, and components of the building (walls, corners, handrails, etc.)
- *Potential (P)*: Each grid cell in the space is given a certain number value, or potential, from a particular point in the building that will move occupants throughout the space in a certain direction. Occupants follow a potential map and attempt to lower their potential with every step or grid cell they travel to. Potential of the route can be altered by such variables as patience of the occupant, attractiveness of the exit, familiarity of the occupant with the building, etc. (which are typically specified by the user).
- *Emptiness of next grid cell (E)*: In some models, the occupant will not move into a grid cell that is already occupied by another occupant. Therefore, the occupant will wait until the next cell is empty, and if more than one occupant is waiting for the same cell, the model will resolve any conflicts that arise when deciding which occupant moves first.
- *Conditional (C)*: With conditional models, movement throughout the building is dependent upon the conditions of the environment, the structure, the other evacuees, and/or fire situation. For this designation only, not much emphasis is placed on congestion inside the space.
- *Functional analogy (FA)*: The occupants follow the movement equations specified by the topic area, such as fluid movement or magnetism. In some cases, the equations depend on the density of the space.
- *Other model link (OML)*: The movement of the occupants is calculated by another model, which is linked to the evacuation model reviewed.
- *Acquiring knowledge (Ac K)*: Movement is based solely on the amount of knowledge acquired throughout the evacuation. For this model, there is no real movement algorithm because evacuation time is not calculated; only areas of congestion, bottlenecks, etc.
- *Unimpeded flow (Un F)*: For this model, only the unimpeded movement of the occupants is calculated. From the calculated evacuation time, delays and improvement times are added or subtracted to produce a final evacuation time result.
- *Cellular automata (CA)*: The occupants in this model move from cell/grid space to another cell by the simulated throw of a weighted die<sup>5</sup>.

## **2.8 Fire Data**

The fire data subcategory explains whether the model allows the user to incorporate the effects of fire into the evacuation simulation. However, the models incorporate fire data in a variety of ways and it is important for the user to understand the complexity of the coupling. The model can incorporate fire data in the following ways: Importing fire data from another model (Y1), allowing the user to input specific fire data at certain times throughout evacuation (Y2), or the

model may have its own simultaneous fire model (Y3). If the model cannot incorporate fire data, it simply runs all simulations in “drill” or non-fire mode (N). “Drill” mode is the equivalent of a fire drill taking place in a building, without the presence of a fire.

The purpose for evacuation models to include such data is to assess the safety of the occupants who travel through degraded conditions. Purser has developed a model to calculate a fractional incapacitating dose for individuals exposed to CO, HCN, CO<sub>2</sub>, and reduced O<sub>2</sub><sup>92,93</sup>. Many models that incorporate a fire’s toxic products throughout the building spaces use Purser’s model to calculate time to incapacitation of the individual occupants. Purser also developed mechanisms for models to calculate certain effects due to heat and irritant gases.

Some models use data collected by Jin<sup>94</sup> on the physical and physiological effects of fire smoke on evacuees. Jin performed experiments with members of his staff, undergraduates, and housewives subjected to smoke consisting of certain levels of density and irritation. He tested visibility and walking speed through irritant smoke in 1985<sup>94</sup> and correct answer rate and emotional stability through heated, thick, irritant smoke-filled corridors in the late 1980s<sup>94</sup>. These data are used in certain models to slow occupant movement through smoke and also to change occupant positioning in certain spaces to a crawl position, instead of upright.

Bryan and Wood concentrated on the correlation between visibility distance in the smoke and the percentage of occupants within that smoke that would move through it<sup>95</sup>. This work was done in the US (Bryan) and the UK (Wood) and was obtained by occupant self-reporting. These data are used by current models to assess when certain occupants will turn back, instead of move forward into the smoke-filled space.

## **2.9 CAD**

The CAD subcategory identifies whether the model allows the user to import files from a computer-aided design (CAD) program into the model. In many instances, this method is time saving and more accurate. If a user can rely on accurate CAD drawings instead of laying out the building by hand, there is less room for input error of the building. If the model allows for the input of CAD drawings, the label (Y) is used in Table 1. On the other hand, the label of (N) is used when the model does not have that capability. In some instances, the model developer is in the process of upgrading their model to include this capability, which is labeled as (F).

## **2.10 Visual**

The visualization subcategory identifies whether the model allows the user to visualize the evacuation output from the structure. Visualizations of the evacuation allow the user to see where the bottlenecks and points of congestion are located inside the space. Many of the models allow for at least 2-D visualization (2-D), and recently more have released versions or collaborate with other virtual programs that will present results in 3-D (3-D). Other models do not have any visualization capabilities (N).



## ***2.11 Validation***

The models are also categorized by their method of validation. The current ways of validating evacuation models are listed here: validation against code requirements (C), validation against fire drills or other people movement experiments/trials (FD), validation against literature on past evacuation experiments (flow rates, etc) (PE), validation against other models (OM), and third party validation (3P). For some models, no indication of validation of the model is provided (N). Some of the behavioral models will perform a qualitative analysis on the behaviors of the population. Although problematic since occupant behaviors are often difficult to obtain in fire drills, past drill survey data is sometimes used to compare with model results.

In the appendix, if published validation work is available for a specific model, some examples are given to explain the study and provide a set of results (or multiple sets of results). However, the user should evaluate the appropriateness of the validation efforts to the project involved and question how the results were obtained. In the cases where the appendix only contains one example or one set of results from a validation exercise, it is up to the user to obtain and review other validation studies (many of which will be referenced throughout the appendix).

## ***2.12 Summary of Category Labels***

### *Availability to the Public:*

- (Y): The model is available to the public for free or a fee
- (N1): The company uses the model for the client on a consultancy basis
- (N2): The model has not yet been released
- (N3): The model is no longer in use
- (U): Unknown

### *Modeling Method:*

- (M): Movement model
- (M-O): Movement/optimization models
- (PB): Partial Behavioral model
- (B): Behavioral model
- (B-RA): Behavioral model with risk assessment capabilities

### *Purpose:*

- (1) Models that can simulate any type of building
- (2) Models that specialize in residences
- (3) Models that specialize in public transport stations
- (4) Models that are capable of simulating low-rise buildings (under 15 stories)
- (5) Models that only simulate 1-route/exit of the building.

*Grid/Structure:*

- (C): Coarse network
- (F): Fine network
- (Co): Continuous

*Perspective of the model/occupant:*

- (G): Global perspective
- (I): Individual perspective

Each model is categorized by both the perspective of the model and of the occupant. If only one entry is listed in this column, both the model and occupant have the same perspective.

*Behavior:*

- (N): No behavior
- (I): Implicit
- (R): Rule-based
- (C): Conditional
- (AI): Artificial intelligence
- (P): Probabilistic

*Movement:*

- (D): Density
- (UC): User's choice
- (ID): Inter-person distance
- (P): Potential
- (E): Emptiness of next grid cell
- (C): Conditional
- (FA): Functional analogy
- (OML): Other model link
- (Ac K): Acquired knowledge
- (Un F): Unimpeded flow
- (CA): Cellular automata

*Fire Data:*

- (N): The model cannot incorporate fire data
- (Y1): The model can import fire data from another model
- (Y2): The model allows the user to input specific fire data at certain times throughout the evacuation
- (Y3): The model has its own simultaneous fire model

*CAD:*

- (N): The model does not allow for importation of CAD drawings
- (Y): The model does allow for importation of CAD drawings
- (F): This feature is in development

*Visual:*

- (N): The model does not have visualization capabilities

(2-D): 2-Dimension visualization available  
(3-D): 3-Dimension visualization available

*Validation:*

(C): Validation against codes

(FD): Validation against fire drills or other people movement experiments/trials

(PE): Validation against literature on past experiments (flow rates, etc.)

(OM): Validation against other models

(3P): 3<sup>rd</sup> party validation

(N): No validation work could be found on the model

## **3 Summary of Egress Model Features**

### ***3.1 Tables***

As mentioned earlier, the appendix includes comprehensive details of the individual characteristics of each model. The level of detail included is only as high in quality as could be extracted from publications on the model and communication with model developers.

However, Tables 1 to 6 were produced to summarize the detailed data presented in the appendix and to provide a quick reference guide to model users. Table 1 details the overall organization of the categorical data for each model. Tables 2 through 6 divide the models by their availability and focus on the special features of each model. The abbreviations used in Table 1 corresponding to each category are explained in Section 2.

Table 1. Overall features of egress models

Model	Available to public	Modeling Method	Purpose	Grid/ Structure	Perspective of M/O	Behavior	Movement	Fire data	CAD	Visual	Valid
FPETool	Y	M	1	N/A	G	N	UC	N	N	N	N
EVACNET4	Y	M-O	1	C	G	N	UC	N	N	N	FD
TIMTEX	Y	M	4	C	G/I	N	D	N	N	N	PE
WAYOUT	Y	M	5	C	G	N	D	N	N	2-D	FD
STEPS	Y	M/PB	1	F	I	N/I	P, E	N	Y	3-D	C
PedGo	Y	M/PB	1	F	I	I	P,E (CA)	N	Y	2-D	FD
PED/PAX	Y/N3	PB	3	C	G	I	D	N	Y	2,3-D	N
Simulex	Y	PB	1	Co.	I	I	ID	N	Y	2-D	FD,PE
GridFlow	Y	PB	1	Co.	I	I	D	N	Y	2,3-D	FD, PE
ASERI	Y	B-RA	1	Co.	I	R/C, P	ID	Y1,2	N, F	2,3-D	FD
BldEXO	Y	B	1	F	I	R/C, P	P, E	Y1,2	Y	2,3-D	FD
EXITT	Y	B	2	C	I	R/C	C	Y1,2	N	2-D	N
Legion	Y	B	1	Co.	I	AI	D,C	Y2	Y	2,3-D	FD,OM
PathFinder	N1	M	1	F	I/G	N	D	N	Y	2-D	N
EESCAPE	N1	M	5	C	G	N	D	N	N	N	FD
Myriad	N1	M	1	N/A	I	N	D	N	Y	2-D	3P
ALLSAFE	N1	PB	5	C	G	I	Un F	Y1,2	N	2-D	OM
CRISP	N1	B-RA	1	F	I	R/C, P	E,D	Y3	Y	2,3-D	FD
EGRESS 2002	N1	B	1	F	I	R/C, P	P,D (CA)	Y2	N	2-D	FD
SGEM	N2	M/PB	1	F	I	N/I	E,D (CA)	N	Y	2-D	FD, OM
Egress Complexity	N2	M/PB	5	C	G/I	N	Ac K, FA	N	N	N	OM
EXIT89	N2	PB	1	C	I	I/C(smK)	D	Y1	N	N	FD
BGRAF	N2	B	1	F	I	R/C, P	UC?	Y1,2	N, F	2-D?	FD
EvacSim	N2	B	1	F	I	R/C, P	D	Y2	N	N	N
Takahashi's Fluid	N3	M-O	1	C	G	N	FA-D	N	N	2-D	FD
EgressPro	N3	M	5	C	G	N	D	Y2	N	N	N
BFIRES- 2	N3/U	B-RA	4	F	I	R/C, P	UC	Y2	N	N	N
VEgAS	N3/U	B	1	F	I	AI	ID	Y1?	Y	3-D	N
Magnetic Model	U	M	1	F	I	I	FA	N	N	2-D	N
E-SCAPE	U	B	1	C	I	R/C, P	OML	Y2	N	2-D	N

? indicates that a category is unclear or unknown

**Table 2. Models Available to the Public**

<b>Characteristics/Model</b>	<b>FPETool</b>	<b>EVACNET4</b>	<b>TIMTEX</b>	<b>WAYOUT</b>
<b>Avail to public</b>	Y	Y	Y	Y
<b>Method</b>	Movement	Movement-O	Movement	Movement
<b>Structure</b>	N/A	Coarse	Coarse	Coarse
<b>Perspective of M/O</b>	Global	Global	G/I	Global
<b>People Beh</b>	None	None	None	None
<b>Import CAD drawings</b>	N	N	N	N
<b>Visual Simulation</b>	N	N	N	Y
<b>Counterflow</b>	N	N	N	N
<b>Manual exit block</b>	N	N	N	N
<b>Fire Conditions</b>	N	N	N	N
<b>Defining Groups</b>	N	N	N	N
<b>Disabl/Slow Occ grps</b>	Y	N	N	N
<b>Delays/Pre-movement</b>	N	N	N	Y
<b>Rte. Choice</b>	Most efficient	Optimal	Split choice	1 route, flows merge
<b>Elevator use</b>	N	Y	N	N
<b>Toxicity to occ</b>	N	N	N	N
<b>Impatience/Drive</b>	N	N	N	N
<b>Occ. Distribution</b>	Even	Optimization	User chooses flow split	1 choice only
<b>Characteristics/Model</b>	<b>STEPS</b>	<b>PedGo</b>	<b>PED/PAX</b>	<b>Simulex</b>
<b>Avail to public</b>	Y	Y	Y/N3	Y
<b>Method</b>	Movement/PB	Movement/PB	Partial Behavior	Partial Behavior
<b>Structure</b>	Fine	Fine	Coarse	Continuous
<b>Perspective of M/O</b>	Individual	Individual	Global	Individual
<b>People Beh</b>	None/Implicit	Implicit	Implicit	Implicit
<b>Import CAD drawings</b>	Y	Y	Y	Y
<b>Visual Simulation</b>	Y	Y	Y	Y
<b>Counterflow</b>	N	N?	N	N
<b>Manual exit block</b>	Y	N?	N	Y
<b>Fire Conditions</b>	N	N	N	N not yet
<b>Defining Groups</b>	Y	Y	Y	Y
<b>Disabl/Slow Occ grps</b>	Y	Y	Y	Y
<b>Delays/Pre-movement</b>	Y	Y	Y	Y
<b>Rte. Choice</b>	Score	Probabilistic/ Conditional	Quickest route, optimize, or follow signs	Shortest distance or altered distance map
<b>Elevator use</b>	Y	N	N	N
<b>Toxicity to occ</b>	N	N	N	N
<b>Impatience/Drive</b>	Y	Y	N	N
<b>Occ Distribution</b>	Score/user chooses target	Various	3 choices?	2 choices

**Table 2. Models Available to the Public, continued**

<b>Characteristics/Model</b>	<b>GridFlow</b>	<b>ASERI</b>	<b>bldgEXODUS</b>
<b>Avail to public</b>	Y	Y	Y
<b>Method</b>	Partial Behavior	Behavioral-RA	Behavioral
<b>Structure</b>	Continuous	Continuous	Fine
<b>Perspective of M/O</b>	Individual	Individual	Individual
<b>People beh</b>	Implicit	Conditional	Conditional
<b>Import CAD drawings</b>	Y	N, F	Y
<b>Visual simulation</b>	Y	Y	Y
<b>Counterflow</b>	Y	N	Y
<b>Manual exit block</b>	Y	Y	Y
<b>Fire conditions</b>	N, only FED input	Y	Y
<b>Defining groups</b>	Y	Y	Y
<b>Disabl/Slow occ grps</b>	Y	Y	Y – mobility
<b>Delays/Pre-evacuation</b>	Y	Y	Y
<b>Rte. choice</b>	Shortest distance, random, or user-defined	Shortest or user-defined, then conditional	Conditional
<b>Elevator use</b>	N	N	N
<b>Toxicity to occ</b>	Y	Y	Y
<b>Impatience/Drive</b>	N	N	Y
<b>Occ distribution</b>	3 choices	Various	Various
<b>Characteristics/Model</b>	<b>EXITT</b>	<b>Legion</b>	
<b>Avail to public</b>	Y	Y	
<b>Method</b>	Behavior	Behavioral	
<b>Structure</b>	Coarse	Continuous	
<b>Perspective of M/O</b>	Individual	Individual	
<b>People beh</b>	Conditional	AI	
<b>Import CAD drawings</b>	N	Y	
<b>Visual simulation</b>	Y	Y	
<b>Counterflow</b>	N	Y	
<b>Manual exit block</b>	Y	Y	
<b>Fire conditions</b>	Y	N, not yet	
<b>Defining groups</b>	Y	Y	
<b>Disabl/Slow occ grps</b>	Y	Y	
<b>Delays/Pre-evacuation</b>	Y	Y	
<b>Rte. choice</b>	Conditional	Conditional	
<b>Elevator use</b>	N	Y	
<b>Toxicity to occ</b>	N	N	
<b>Impatience/Drive</b>	N	Y – alternate naming of variables	
<b>Occ distribution</b>	Various	Various	

**Table 3. Model Available on a Consultancy Basis**

<b>Characteristics/Model</b>	<b>PathFinder</b>	<b>EESCAPE</b>	<b>Myriad</b>
<b>Avail to public</b>	N1	N1	N1
<b>Method</b>	Movement	Movement	Movement
<b>Structure</b>	Fine	Coarse	N/A
<b>Perspective of M/O</b>	I/G	Global	Individual
<b>People beh</b>	None	None	None
<b>Import CAD drawings</b>	Y	N	Y
<b>Visual simulation</b>	Y	N	Y
<b>Counterflow</b>	N	N	Y – congestion
<b>Manual exit block</b>	N	N	N
<b>Fire conditions</b>	N	N	N
<b>Defining groups</b>	N	N	N
<b>Disabl/Slow occ grps</b>	N	N	N
<b>Delays/Pre-movement</b>	N	N	Y – interaction related
<b>Rte. choice</b>	2 Choices	1-route	Available
<b>Elevator use</b>	N	N	N
<b>Toxicity to occ</b>	N	N	N
<b>Impatience/Drive</b>	N	N	N
<b>Occ. distribution</b>	UC – 2 choices	1 choice only	Various
<b>Characteristics/Model</b>	<b>ALLSAFE</b>	<b>CRISP</b>	<b>EGRESS</b>
<b>Avail to public</b>	N1	N1	N1
<b>Method</b>	Partial Behavior	B-RA	Behavioral
<b>Structure</b>	Coarse	Fine	Fine
<b>Perspective of M/O</b>	Global	Individual	Individual
<b>People beh</b>	Implicit	Conditional	Conditional
<b>Import CAD drawings</b>	N	Y	N
<b>Visual simulation</b>	Y	Y	Y
<b>Counterflow</b>	N	Y	Y
<b>Manual exit block</b>	N	Y	Y
<b>Fire conditions</b>	Y	Y – not in drill mode	Y
<b>Defining groups</b>	Y	Y	Y
<b>Disabl/Slow occ grps</b>	N	Y	Y
<b>Delays/Pre-movement</b>	Y	Y	Y
<b>Rte. choice</b>	All to 1 exit	Shortest, user defined door difficulty	Conditional
<b>Elevator use</b>	N	N	N
<b>Toxicity to occ</b>	N	Y – not in drill	Y
<b>Impatience/Drive</b>	N	N	N
<b>Occ distribution</b>	1 choice	Conditional	Various



**Table 4. Models Not Yet Released**

<b>Characteristics/Model</b>	<b>SGEM</b>	<b>Egress Complex.</b>	<b>EXIT89</b>
<b>Avail to public</b>	N2	N2	N2
<b>Method</b>	Movement/PB	Movement/PB	Partial Behavior
<b>Structure</b>	Fine	Coarse	Coarse
<b>Perspective of M/O</b>	Individual	G/I	Individual
<b>People beh</b>	None/Implicit	None	Implicit/C (smk)
<b>Import CAD drawings</b>	Y	N	N
<b>Visual simulation</b>	Y	N	N
<b>Counterflow</b>	Y	N	Y
<b>Manual exit block</b>	Y	N, Y with improvements	Y
<b>Fire conditions</b>	N	N	Y, CFAST
<b>Defining groups</b>	N	N	N
<b>Disabl/Slow occ grps</b>	Y	N, Y with improvements	Y
<b>Delays/Pre-movement</b>	Y	N	Y
<b>Rte. choice</b>	Minimum Dist./Conditional	1 exit	Shortest distance or user-defined
<b>Elevator use</b>	N	N	N
<b>Toxicity to occ</b>	N	N	N
<b>Impatience/Drive</b>	Y	N	N
<b>Occ. distribution</b>	Various	1 choice	2 choices
<b>Characteristics/Model</b>	<b>BGRAF</b>	<b>EvacSim</b>	
<b>Avail to public</b>	N2	N2	
<b>Method</b>	Behavioral	Behavioral	
<b>Structure</b>	Fine	Fine	
<b>Perspective of M/O</b>	Individual	Individual	
<b>People beh</b>	Conditional	Conditional	
<b>Import CAD drawings</b>	N, F	N	
<b>Visual simulation</b>	Y	N	
<b>Counterflow</b>	N	N	
<b>Manual exit block</b>	N	Y-locked doors	
<b>Fire conditions</b>	Y	Y – user	
<b>Defining groups</b>	Y	Y	
<b>Disabl/Slow occ grps</b>	Y	Y	
<b>Delays/Pre-movement</b>	Y	Y	
<b>Rte. choice</b>	Conditional	Conditional	
<b>Elevator use</b>	N	Y	
<b>Toxicity to occ</b>	Y	N	
<b>Impatience/Drive</b>	N	N	
<b>Occ distribution</b>	Various	Various	

**Table 5. Models No Longer in Use**

<b>Characteristics/Model</b>	<b>Fluid</b>	<b>EgressPro</b>	<b>BFIRES-2</b>	<b>VEgAS</b>
<b>Avail to public</b>	N3	N3	N3/U	N3/U
<b>Method</b>	Movement-O	Movement	Behavioral-RA	Behavioral
<b>Structure</b>	Coarse	Coarse	Fine	Fine
<b>Perspective of M/O</b>	Global	Global	Individual	Individual
<b>People beh</b>	None	None	Conditional	AI
<b>Import CAD drawings</b>	N	N	N	Y
<b>Visual simulation</b>	Y	N	N	Y
<b>Counterflow</b>	N	N	N	N
<b>Manual exit block</b>	N	N	Y	Y
<b>Fire conditions</b>	N	Y	Y	Y
<b>Defining groups</b>	N	N	N	Y
<b>Disabl/Slow occ grps</b>	N	N	Y	N
<b>Delays/Pre-evacuation</b>	Y	Y	Y	Y
<b>Rte. choice</b>	Optimal	1 route	Conditional	User-dfnd/Cond
<b>Elevator use</b>	N	N	N	N
<b>Toxicity to occ</b>	N	N	Y-smk tolerance	Y
<b>Impatience/Drive</b>	N	N	N	N
<b>Occ distribution</b>	Optimization from rooms and to exits	1 choice only	Various	Various

**Table 6. Models - Availability Unknown**

<b>Characteristics/Model</b>	<b>Magnetic Model</b>	<b>E-SCAPE</b>
<b>Avail to public</b>	U	U
<b>Method</b>	Movement	Behavioral
<b>Structure</b>	Fine	Coarse
<b>Perspective of M/O</b>	Individual	Individual
<b>People beh</b>	Implicit	Conditional
<b>Import CAD drawings</b>	N	N
<b>Visual simulation</b>	Y	Y
<b>Counterflow</b>	N	N
<b>Manual exit block</b>	N	N
<b>Fire conditions</b>	N	Y
<b>Defining groups</b>	Y	Y
<b>Disabl/Slow occ grps</b>	Y	N
<b>Delays/Pre-evacuation</b>	Y	Y
<b>Rte. choice</b>	3 choices	Conditional
<b>Elevator use</b>	N	N
<b>Toxicity to occ</b>	N	N
<b>Impatience/Drive</b>	N	N
<b>Occ distribution</b>	UC – 3 choices	Various

### 3.2 Overview of Model Features

The purpose of this section is to generally describe the models that fall into the two main availability categories that users would be interested in: available to the public and available on a consultancy basis. As Table 1 shows, there are 13 evacuation models that are available to the public and 6 evacuation models available on a consultancy basis that are featured in this model review.

#### *Models Available to the Public*

Of the models available to the public, there are 6 movement models, 3 partial behavioral, and 4 behavioral models listed in Table 1. As mentioned earlier, the movement method is used to describe the sophistication of the model's simulation techniques, i.e. the complexity of the modeling techniques used to simulate the egress situation and the occupant behavior throughout the evacuation. Table 1 also shows that two of the models, STEPS and PedGo, are labeled as both movement and partial-behavioral models. In STEPS, the use of groups with different characteristics, pre-evacuation times, and visualization could categorize this model as a partial-behavioral model. However, due to the basic movement and behavioral techniques used in both of these models, the movement category still applies. PedGo is a cellular automata model where one set of rules applies to all occupants regarding their movement, which is the reason to categorize the model as movement. However, the model is also labeled as partial behavioral because of the individual inputs that the user can assign to certain occupants, such as patience and reaction (assigned in seconds) and dawdle and sway (assigned stochastically to a certain percentage of the population). Generally, by labeling a model as "movement," there are no behavioral options available to the user. The majority of the movement models contains coarse grid structures, contain global perspectives, do not incorporate fire data, and do not use CAD drawings. The STEPS and PedGo models are the exception here, allowing for a fine grid, individual perspectives, implicit behavior, and the use of CAD drawings. Lastly, the majority of the movement models do not allow for visualization, with the exception being WAYOUT, STEPS, and PedGo.

There are three partial behavioral models that are available to the public. Of these, two of these move people continuously through the building with individual perspectives, whereas one of them, PEDROUTE, contains a coarse network with global perspectives. All three incorporate implicit behavior, the use of CAD drawings, and visualization, however none of them incorporate fire data.

Lastly, there are four behavioral models that fall under the category of available to the public. The behavioral models contain a variety of different grid structures; however they all contain individual perspectives, have the capability of simulating fire situations, and visualize the evacuation. These models may or may not allow for the use of CAD drawings and range in the behavioral method from rules/conditional to artificial intelligence.

Overall, independent of modeling method, these 13 models vary widely in their purpose, movement method, and validation techniques. With any ranking according to sophistication, the user should be aware that just because a particular input is available does not mean that the

developer has the appropriate data to support the option. For this reason, the validation techniques used by each model are very important and should be examined accordingly.

#### *Models Available on a Consultancy Basis*

There are six models featured in Table 1 that are available on a consultancy basis to the clients/users. Among the six models, there are three movement models, one partial behavioral model, and two behavioral models. Two out of the three movement models seem to contain more capabilities than those movement models listed in the Available to the Public category by providing fine networks and individual perspectives, the use of CAD drawings, and the capability of 2-D visualization. However, like the publicly available models, the three movement models do not allow for the simulation of the fire environment.

The partial behavioral model, ALLSAFE may seem to have many of the characteristics generally attributed to movement models, such as a coarse network and global perspectives. However, the behavior is labeled as implicit because the model allows for input data that affect evacuation, such as background noise, language of the occupants, voice alarms systems, etc. The model incorporates fire data and provides a visualization of the evacuation.

There are two behavioral models that fall under the consultancy category of availability, as shown in Table 1. These models, CRISP and EGRESS, both contain fine networks and individual perspectives. Also, these models incorporate rule-based behavior, fire data, and visualization.

Similar to the publicly available models, the consultancy based models also vary in purpose, movement method, and validation techniques.

#### *Special Features*

As an additional way to describe the capabilities of each model, Tables 2 through 6 are included to identify any special features of the model that users may be interested in simulating. These tables are included for users interested in simulating certain evacuation scenarios and/or for users to understand the differences in model sophistication. It can be seen that the number of special features simulated by the model increase as the level of sophistication increases.

### **3.3 Additional Egress Models**

In addition to evacuation models that can simulate egress from buildings, there are many other evacuation models that can simulate evacuation from different types of structures/scenarios, such as elevator evacuation and evacuation of occupants from aircraft, rail systems, marine structures/ships, and cities. Although this evacuation model review focuses specifically on evacuation models that simulate building emergencies, some of these models highlighted in this review and others not mentioned are used to simulate evacuation from other types of structures.

If the user has a project that involves egress from these types of structures, there are other evacuation model reviews<sup>96-98</sup> that would be useful to obtain before choosing a model.

## **4 Conclusion**

This report provides model users with the information to narrow down choices on the appropriate model or models to use for specific projects. It is up to the model user to review the details placed in the appendix and make a final and informed decision as to which model(s) is best for the project at hand.

As time passes, more evacuation models will be developed and many of the current models will be updated by developers. It should be noted that this review will require updates as new models are used and older ones retire. It is up to the user to take the model version, the publish date of the report, and any more recent publications on particular evacuation models into account when choosing the appropriate model.

## 5 References

1. Custer, R. L. P. & Meacham, B. J. (1997). *Introduction to Performance-Based Fire Safety* Bethesda, MD: Society of Fire Protection Engineers.
2. Nelson, H. E. & Mowrer, F. W. (2002). Emergency Movement. In P.J.DiNenno & W. D. Walton (Eds.), *The SFPE Handbook of Fire Protection Engineering* (Third ed., pp. 3-367-3-380). Bethesda, MD: Society of Fire Protection Engineers.
3. Gwynne, S., Galea, E. R., Lawrence, P. J., Owen, M., & Filippidis, L. (1999). A Review of the Methodologies used in the Computer Simulation of Evacuation from the Built Environment. *Building and Environment*, 34, 741-749.
4. Fire Model Survey (2002). <http://www.firemodelsurvey.com/EgressModels.html> [On-line]. Available: <http://www.firemodelsurvey.com/EgressModels.html>
5. Olenick, S. M. & Carpenter, D. J. (2003). Updated International Survey of Computer Models for Fire and Smoke. *Journal of Fire Protection Engineering*, 13, 87-110.
6. Watts, J. M. (1987). Computer Models for Evacuation Analysis. *Fire Safety Journal*, 12, 237-245.
7. Friedman, R. (1992). An International Survey of Computer Models for Fire and Smoke. *Journal of Fire Protection Engineering*, 4, 81-92.
8. Deal, S. (1995). *Technical Reference Guide for FPETool Version 3.2* (Rep. No. NISTIR 5486-1). Natl. Inst. Stand. Technol.
9. Francis, R. L. & Saunders, P. B. (1979). *EVACNET: Prototype Network Optimization Models for Building Evacuation* (Rep. No. NBSIR 79-1593). Natl. Bur. Stand., (U.S.).
10. Kisko, T. M., Francis, R. L., & Nobel, C. R. (1998). *EVACNET4 User's Guide, Version 10/29/98* University of Florida.
11. Harrington, S. S. (1996). *TIMTEX: A Hydraulic Flow Model for Emergency Egress*. MSci Department of Fire Protection Engineering, University of Maryland.
12. Shestopal, V. O. & Grubits, S. J. (1994). Evacuation Model for Merging Traffic Flows in Multi-Room and Multi-Story Buildings. In *Fire Safety Science -- Proceedings of the 4th International Symposium* (pp. 625-632).
13. Wall, J. M. & Waterson, N. P. Predicting Evacuation Times -- A Comparison of the STEPS Simulation Approach with NFPA 130. *Fire Command Studies*, (in press).
14. MacDonald, M. (2003). STEPS Simulation of Transient Evacuation and Pedestrian Movements User Manual. Unpublished Work

15. Hoffman, N. A. & Henson, D. A. (1997). Simulating Emergency Evacuation in Stations. In *APTA Rapid Transit Conference* Washington, DC: American Public Transit Association.
16. Hoffman, N. A. & Henson, D. A. (1997). Simulating Transient Evacuation and Pedestrian Movement in Stations. In *3rd International Conference on Mass Transit Management* Kuala Lumpur, Malaysia.
17. Hoffman, N. A. & Henson, D. A. (1998). Analysis of the Evacuation of a Crush Loaded Train in a Tunnel. In *3rd International Conference on Safety in Road and Rail Tunnels* Nice, France.
18. TraffGO product information - PedGo. (2005). Pamphlet
19. Klupfel, H. & Meyer- König, T. (2003). Characteristics of the PedGo Software for Crowd Movement and Egress Simulation. In *2nd International Conference in Pedestrian and Evacuation Dynamics (PED)* (pp. 331-340). London, U.K.: University of Greenwich.
20. Meyer- König, T., Klupfel, H., & Schreckenberg, M. (2001). A microscopic model for simulating mustering and evacuation process onboard passenger ships. In *Proceedings of the International Emergency Management Society Conference*.
21. Pedestrian Planning for the Olympic Park Railway Station, Sydney - Transport planning for the Olympic Games (2004).  
<http://www.arup.com/insite/feature.cfm?featureid=38> [On-line].
22. PAXPORT and PEDROUTE brochures (2004). <http://www.halcrow.com> [On-line].
23. Barton, J. and Leather, J. (1995). Paxport -- Passenger and Crowd Simulation. *Passenger Terminal '95*, 71-77.
24. Buckmann, L. T. & Leather, J. (1994). Modelling Station Congestion the PEDROUTE Way. *Traffic Engineering and Control*, 35, 373-377.
25. Clifford, P. & du Sautoy, C. Pedestrian and Passenger Activity Modeling. Vineyard House, 22 Brook Green, Hammersmith, London, Halcrow Fox. Generic
26. du Sautoy, C. (5-16-2003). Internet Communication
27. Transport Strategies Limited (2004). A Guide to Transport Demand Forecast Models: PEDROUTE & PAXPORT. <http://www.tsl.dircon.co.uk/dempedroute.htm> [On-line].
28. IES. (2000). Simulex Technical Reference; Evacuation Modeling Software. Integrated Environmental Solutions, Inc. Generic



29. IES. (2001). Simulex User Manual; Evacuation Modeling Software. Integrated Environmental Solutions, Inc. Generic
30. Thompson, P. A. & Marchant, E. W. (1994). Simulex; Developing New Computer Modelling Techniques for Evaluation. In *Fire Safety Science -- Proceedings of the 4th International Symposium* (pp. 613-624).
31. Thompson, P. A. & Marchant, E. W. (1995). A Computer Model for the Evacuation of Large Building Populations. *Fire Safety Journal*, 24, 131-148.
32. Thompson, P. A. & Marchant, E. W. (1995). Testing and Application of the Computer Model 'SIMULEX'. *Fire Safety Journal*, 24, 149-166.
33. Thompson, P. A. (1995). *Developing New Techniques for Modelling Crowd Movement*. PhD Department of Building and Environmental Engineering, University of Edinburgh, Scotland.
34. Thompson, P. A., Wu, J., & Marchant, E. W. (1996). Modelling Evacuation in Multi-storey Buildings with Simulex. *Fire Engineering*, 56, 7-11.
35. Thompson, P. A. (2003). Internet Communication
36. Bensilum, M. & Purser, D. A. (2002). Gridflow: an object-oriented building evacuation model combining pre-movement and movement behaviours for performance-based design. In *7th International Symposium on Fire Safety Science* Worcester, MA: Worcester Polytechnic Institute.
37. ASERI (Advance Simulation of Evacuation of Real Individuals) A model to simulate evacuation and egress movement based on individual behavioural response (2004). <http://www.ist-net.de> [On-line].
38. Schneider, V. (2001). Application of the Individual-Based Evacuation Model ASERI in Designing Safety Concepts. In *2nd International Symposium on Human Behaviour in Fire* (pp. 41-51). Boston, MA.
39. Schneider, V. & Konnecke, R. (2001). Simulating Evacuation Processes with ASERI. In *Tagungsband International Conference on Pedestrian Evacuation Dynamics (PED)* Duisburg.
40. Schneider, V. (5-19-2003). Internet Communication
41. Gwynne, S., Galea, E. R., Lawrence, P., & Filippidis, L. (1998). A Systematic Comparison of Model Predictions Produced by the buildingEXODUS Evacuation Model and the Tsukuba Pavilion Evacuation Data. *Applied Fire Science*, 7, 235-266.
42. Gwynne, S., Galea, E. R., Owen, M., Lawrence, P., & Filippidis, L. (1998). A Comparison of Predictions from the buildingEXODUS Evacuation Model with Experimental Data. In J. Shields (Ed.), (pp. 711-721). University of Ulster.

43. Parke, J., Gwynne, S., Galea, E. R., & Lawrence, P. (2003). Validating the building EXODUS Evacuation Model using Data from an Unannounced Trial Evacuation. In (pp. 295-306). University of Greenwich, UK: CMS Press.
44. Levin, B. M. (1988). *EXITT: A Simulation Model of Occupant Decisions and Actions in Residential Fires* (Rep. No. NBSIR 88-3753). Natl. Inst. Stand. Technol.
45. Levin, B. M. (1988). EXITT - A Simulation Model of Occupant Decisions and Actions in Residential Fires. In *Fire Safety Science - Proceedings of the Second International Symposium* (pp. 561-570).
46. Legion International, L. (2003). <http://www.legion.biz/system/research.cfm>.  
<http://www.legion.biz/system/research.cfm> [On-line].
47. Williams, A. (2005). Go with the Flow. *The Architect's Journal*.
48. Kagarlis, M. A. (2004). Movement of an autonomous entity through an environment. WO 2004/023347 A2. Patent
49. Cappuccio, J. (2000). Pathfinder: A Computer-Based Timed Egress Simulation. *Fire Protection Engineering*, 8, 11-12.
50. Kendik, E. (1995). Methods of Design for Means of Egress: Towards a Quantitative Comparison of National Code Requirements. In *Fire Safety Science -- Proceedings of the 1st International Symposium* (pp. 497-511).
51. Still, G. K. (2004). VEGAS (Virtual Egress and Analysis System).  
<http://www.crowddynamics.com> [On-line]. Available:  
<http://www.crowddynamics.com>
52. Still, G. K. (2003). Internet Communication
53. [http://www.cibprogram.dbce.csiro.au/program/survey\\_view.cfm?S\\_ID=55](http://www.cibprogram.dbce.csiro.au/program/survey_view.cfm?S_ID=55) (2003).  
[http://www.cibprogram.dbce.csiro.au/program/survey\\_view.cfm?S\\_ID=55](http://www.cibprogram.dbce.csiro.au/program/survey_view.cfm?S_ID=55) [On-line].
54. Heskestad, A. W. & Meland, O. J. (1998). Determination of Evacuation Times as a Function of Occupant and Building Characteristics and Performance of Evacuation Measures. In *Human Behaviour in Fire -- Proceedings of the 1st International Symposium* (pp. 673-680).
55. Jensen, G. (2003). Internet Communication
56. Boyce, K., Fraser-Mitchell, J., & Shields, J. (1998). Survey Analysis and Modelling of Office Evacuation Using the CRISP Model. In T. J. Shields (Ed.), *Human Behaviour in Fire -- Proceedings of the 1st International Symposium* (pp. 691-702).

57. Fraser-Mitchell, J. (2001). Simulated Evacuations of an Airport Terminal Building, Using the CRISP Model. In *2nd International Symposium in Human Behaviour in Fire* (pp. 89-100). Boston, MA.
58. Fraser-Mitchell, J. (2003). 'CRISP' Fire Risk Assessment by Simulation. Presentation given at the University of Greenwich. Generic
59. Fraser-Mitchell, J. (2003). Internet Communication
60. AEA Technology (2002). *A Technical Summary of the AEA EGRESS Code* Warrington, UK: AEA Technology.
61. Ketchell, N., Cole, S. S., & Webber, D. M. (1994). The EGRESS Code for Human Movement and Behaviour in Emergency Evacuation. In R.A.Smith & J. F. Dickie (Eds.), *Engineering for Crowd Safety* (pp. 361-370). London: Elsevier.
62. Ketchell, N., Bamford, G. J., & Kandola, B. (1995). Evacuation Modelling: A New Approach. In *ASIAFLAM '95, Proceedings of the 1st International Conference on Fire Science and Engineering* (pp. 499-505).
63. Lo, S. M., Fang, Z., & Zhi, G. S. (2004). An Evacuation Model: the SGEM package. *Fire Safety Journal*, 169-190.
64. Lo, S. M. & Fang, Z. (2000). A Spatial-Grid Evacuation Model for Buildings. *Journal of Fire Sciences*, 18, 376-394.
65. Donegan, H. A., Pollock, A. J., & Taylor, I. R. (1994). Egress Complexity of a Building. In *Fire Safety Science -- Proceedings of the 4th International Symposium* (pp. 601-612).
66. Donegan, H. A. & Taylor, I. R. (1998). How Complex is the Egress Capability of your Design? In T. J. Shields (Ed.), *Human Behaviour in Fire, Proceedings of the First International Symposium*.
67. Fahy, R. F. (1994). EXIT89 -- An Evacuation Model for High-rise Buildings -- Model Description and Example Applications. In *Fire Safety Science -- Proceedings of the 4th International Symposium* (pp. 657-668).
68. Fahy, R. F. (1996). EXIT89 -- High-rise Evacuation Model -- Recent Enhancements and Example Applications. In *Interflam '96, International Interflam Conference -- 7th Proceedings* (pp. 1001-1005). Cambridge, England.
69. Fahy, R. F. (1999). *User's Manual, EXIT89 v 1.01, An Evacuation Model for High-Rise Buildings* Quincy, Ma: National Fire Protection Association.
70. Fahy, R. F. (1999). *Development of an Evacuation Model for High-Rise Buildings, Volume 1 of 2*. DPhil by published works School of the Built Environment, Faculty of Engineering of the University of Ulster.

71. Fahy, R. F. (2001). Verifying the Predictive Capability of EXIT89. In *2nd International Symposium on Human Behaviour in Fire* (pp. 53-63).
72. Fahy, R. F. (2003). Calculation Methods for Egress Prediction. In *Fire Protection Handbook* (19th ed., Quincy, MA: National Fire Protection Association).
73. Fahy, R. F. (5-2-2003). Internet Communication
74. Ozel, F. (1985). A Stochastic Computer Simulation of the Behavior of People in Fires: An Environmental Cognitive Approach. In *Proceedings of the International Conference on Building Use and Safety Technology*.
75. Ozel, F. (1991). Simulation of Processes in Buildings as a Factor in the Object Representation of Built Environments. In *Proceedings of Building Simulation '91* (pp. 250-256).
76. Ozel, F. (1993). Computer Simulation of Behavior in Spaces. In R.W.Marans & D. Stokols (Eds.), *Environmental Simulation: Research and Policy Issues* (pp. 191-204). New York: Plenum Press.
77. Ozel, F. (2003). Internet Communication
78. Poon, L. S. (1994). EvacSim: A Simulation Model of Occupants with Behavioural Attributes in Emergency Evacuation of High-Rise Buildings. In *Fire Safety Science -- Proceedings of the 4th International Symposium* (pp. 681-692).
79. Poon, L. S. (4-1-2003). Internet Communication
80. Takahashi, K., Tanaka, T., & Kose, S. (1988). An Evacuation Model for Use in Fire Safety Designing of Buildings. In *Fire Safety Science -- Proceedings of the 2nd International Symposium* (pp. 551-560).
81. Semenko, P. (5-13-2003). Internet Communication
82. Stahl, F. I. (1979). *Final Report on the 'BFIRES/VERSION 1' Computer Simulation of Emergency Egress Behavior During Fires: Calibration and Analysis* (Rep. No. NBSIR 79-1713). Natl. Bur. Stand., (U.S.).
83. Stahl, F. I. (1982). BFIRES-II: A Behavior Based Computer Simulation of Emergency Egress During Fires. *Fire Technology*, 18, 49-65.
84. Stahl, F. I. (1980). *BFIRES/Version 2: Documentation of Program Modifications* (Rep. No. NBSIR 80-1982). Natl. Bur. Stand., (U.S.).
85. Still, G. K. (1993). New Computer System Can Predict Human Behavioural Response During Building Fires. *Fire*, 85, 40-42.

86. Okazaki, S. & Matsushita, S. (2004). A Study of SIMulation Model for Pedestrian Movement with Evacuation and Queing. <http://www.anc-d.fukui-u.ac.jp/~sat/ECS93.pdf> [On-line].
87. Reisser-Weston, E. (1996). Simulating Human Behaviour in Emergency Situations. In *RINA, International Conference of Escape, Fire, and Rescue*.
88. Fruin, J. J. (1987). *Pedestrian Planning and Design*. (Revised Edition ed.) Mobile, AL: Elevator World, Inc.
89. Pauls, J. (1995). Movement of People. In P.J.DiNenno, C. L. Beyler, R. L. P. Custer, W. D. Walton, J. M. Watts, D. Drysdale, & J. R. Hall (Eds.), *The SFPE Handbook of Fire Protection Engineering* (Second ed., pp. 3-263-3-285). Bethesda, MD: Society of Fire Protection Engineers.
90. Pauls, J. (1980). Effective-Width Model for Crowd Evacuation Flow in Buildings. In *Proceedings: Engineering Applications Workshop* Boston, MA: Society of Fire Protection Engineers.
91. Predtechenskii, V. M. & Milinskii, A. I. (1978). *Planning for Foot Traffic in Buildings*. New Delhi: Amerind Publishing Co. Pvt. Ltd.
92. Purser, D. A. (2002). Toxicity Assessment of Combustion Products. In P.J.DiNenno & C. L. Beyler (Eds.), *The SFPE Handbook of Fire Protection Engineering* (Third ed., pp. 2-83-2-171). Bethesda, MD: Society of Fire Protection Engineers.
93. Klote, J. H. & Milke, J. A. (2002). *Principles of Smoke Management*. Atlanta, GA: American Society of Heating, Refrigeration, and Air-Conditioning Engineers, Inc.
94. Jin, T. (1997). Studies on Human Behavior and Tenability. In *Fire Safety Science - Proceedings of the Fifth International Symposium* (pp. 3-21).
95. Bryan, J. L. (2002). Behavioral Response to Fire and Smoke. In P.J.DiNenno & W. D. Walton (Eds.), *The SFPE Handbook of Fire Protection Engineering* (Third ed., pp. 3-315-3-340). Bethesda, MD: Society of Fire Protection Engineers.
96. Davis Associates, L. (2003). *Managing Large Events and Perturbations at Stations, Passenger Flow Modeling Technical Review* (Rep. No. RS021/R.03).
97. Hamacher, H. W. & Tjandra, S. A. (2000). Mathematical Modelling of Evacuation Problems: A State of the Art. In M.Schreckenber & S. D. Sharma (Eds.), *Proceedings of Pedestrian and Evacuation Dynamics* (Duisburg, Germany: Springer-Verlag).
98. Sharp, G., Gwynne, S., & Galea, E. R. (2003). *The Effects of Ship Motion on the Evacuation Process, Subsection 3.1, Critical review on model of evacuation analysis* (Rep. No. RESEARCH PROJECT 490, Report for the MCA by the Fire Safety Engineering Group). University of Greenwich.



# Appendix A. Details of Model Review

## Contents

A.1	Egress Section in FPETool .....	2
A.2	EVACNET4 .....	5
A.3	TIMTEX .....	8
A.4	WAYOUT .....	10
A.5	STEPS .....	12
A.6	PedGo .....	16
A.7	PEDROUTE and PAXPORT .....	20
A.8	Simulex .....	23
A.9	GridFlow .....	30
A.10	ASERI .....	34
A.11	buildingEXODUS .....	40
A.12	EXITT .....	45
A.13	Legion .....	48
A.14	PathFinder .....	51
A.15	EESCAPE (Emergency Escape) .....	53
A.16	Myriad .....	55
A.17	ALLSAFE .....	59
A.18	CRISP3 .....	62
A.19	EGRESS .....	66
A.20	Spatial-Grid Evacuation Model (SGEM) Package .....	71
A.21	Egress Complexity Model .....	75
A.22	EXIT89 .....	78
A.23	BGRAF .....	83
A.24	EvacSim .....	87
A.25	Takahashi's Fluid Model .....	91
A.26	EgressPro .....	94
A.27	BFIRES-2 .....	96
A.28	VEgAS .....	101
A.29	Magnetic Model .....	104
A.30	E-SCAPE .....	106
A.31	References .....	110

# Models Publicly Available

## A.1 Egress Section in FPETool

Developer: H.E. Nelson, National Bureau of Standards, U.S.

**Purpose of the model:** The purpose of FPETool<sup>1,2</sup> is to estimate the time needed for an occupant or group of occupants to exit an area.

**Availability to the public for use:** This model is available under the fire modeling software topic area from NIST at <http://fire.nist.gov>.

**Modeling method:** Movement model

**Structure of model:** N/A. The distance of the route including the distance traveled over stairwells is input by the user to describe the building.

**Perspective of model:** The model views the occupants as a mass of people (global) flowing through doorways with a specified rate. The occupants also have a global view of the building, since the most efficient exit paths are chosen for egress time calculations.

**Occupant behavior:** None.

**Occupant movement:** The flow rates through doors are assumed to be one person/second/door leaf. In the case that a door leaf is less than 34 inches wide, the flow rates may be less. The model also incorporates effective widths into the exit path. The user of the model inputs the following items into FPETool:

- Travel speed on level routes (m/min)
- Travel speed on stairs (vertical travel)
- Flow rate through doors (people/min/exit door width)
- Flow rate on stairs (people/min/m  $W_{\text{effective}}$ )
- Total number of occupants using the evacuation routes
- Whether disabled occupants are included in the simulation
- The speed of the slowest evacuee
- The number of exit door leaves available to the occupants
- Total length of the route
- Vertical distance moved on stairwell
- Number of stairways used (total width)
- Stairway width (mm)
- Stairway tread depth

Since the model can handle only one stairway width, if a building contains greater than one stairway with different widths, the user will need to enter an average width for the stairways of the building. This model does not incorporate queuing through various portions of the building,



since the building is only represented by the travel route distance, the number of stairwells, the exit door width, and the geometry of the stair. Congestion occurs only at the doors or stairwells. The equations below make up the calculations made by FPETool to provide egress times (as shown in Figure A.1).

$$t_{unimpeded} = \frac{(t_{horizontal} + t_{vertical})}{\chi_{mobility}} \quad (1)$$

$$\chi_{mobility} = \frac{X}{100} \quad (2)$$

$$t_{horizontal} = \frac{X_{horizontal}}{v_{able}} \quad (3)$$

$$t_{vertical} = \frac{z_{vertical}}{v_{stair}} \sqrt{\frac{11}{7} \frac{z_{riser}}{x_{tread}}} \quad (4)$$

$$t_{exit-opening} = \frac{N_{people}}{N_{exitleaves}} \left( \frac{\text{exit leaf} \cdot \text{sec}}{1 \text{ person}} \right) \quad (5)$$

$$t_{stair} = \frac{N_{people}}{W_{effective}} \frac{1}{\dot{Q}_{stair}} \quad (6)$$

$N_{exit\ leaves}$	Total number of door leaves from the building to the outside
$N_{people}$	Total evacuating population
$\dot{Q}_{stair}$	People flow rate in a stairway enclosure (default 60 people/min/m <sub>w, eff</sub> )
$t$	Exit time (sec)
$W_{effective}$	Effective width of an exit passageway (see Section 3.6.3) (m)
$X_{horizontal}$	Total horizontal distance traversed by the evacuee (m)
$v_{able}$	Speed of an able evacuee moving on flat, dry surface (m/s)
$v_{stair}$	Speed of an able evacuee moving in a vertical means of egress (m/s)
$x_{tread}$	Depth of the tread from riser to riser (m)
$X$	Speed of the slowest evacuee as a percentage of able evacuee speed
$z_{riser}$	Height of the riser from tread to tread (m)
$z_{vertical}$	Total vertical traverse distance (not distance along a sloped incline) (m)

Figure A.1: FPETool egress equations <sup>2, p.33</sup>

Equations 1, 5, and 6 (together) provide a first-order estimate of area evacuation times.

**Use of fire data:** None.

**Output:** The output for the model is the following in min:

- Horizontal and stair travel time – this includes the time for a person to traverse all stair and horizontal paths without queuing.
- Time required to pass all occupants through the building exit doors – the time for the entire population to pass through the exit doors
- Time required to pass all occupants through the building stair exit doors.

**Import CAD drawings:** No. The user enters the capacity of the nodes and the initial contents. Building data is not necessarily supplied because the dynamic capacity (flow) and the traversal times specified in the input move people throughout the building at evacuation time progresses.

**Visualization capabilities:** None.

**Validation studies:** None known of at this time.

**Special features:**

*Disabilities/slow occupant groups* - The user can input the speed of the slowest evacuee as a percentage of an able evacuee's speed.

*Route choice of the occupants/occupant distribution* – Most efficient

**Limitations:** There are many assumptions made by the model. These assumptions are the following: the most efficient exit paths are chosen, no actions such as investigation, way-finding, etc. are incorporated, flow is ideal without congestion, and there is no adjustment to flow speed due to density. Nelson notes that it is reasonable to expect evacuation times that are two to three times greater than the nominal evacuation time obtained from FPETool<sup>2</sup>.

## A.2 EVACNET4

Developers: Kisko, Francis, and Nobel, University of Florida, U.S.

**Purpose of the model:** EVACNET4<sup>3-5</sup> can be used for any type of building, such as office buildings, hotels, skyscrapers, auditoriums, stadiums, retail establishments, restaurants, and schools. The purpose of the model is to describe an optimal evacuation from a building, meaning that the model minimizes the time to evacuate the building. EVACNET4 replaces the previous version, EVACNET+.

**Availability to the public for use:** Yes, the model is available for public use for free.

**Modeling method:** Movement model

**Structure of model:** This is a coarse network model. Figure A.2 shows the nodes designations in the rectangles connected by arcs (arrows). Examples of node types are WP (workplaces or rooms), HA (hallway), SW (stairwell), LO (lobby), and DS (destination node or the outside). The numbers assigned to each node and arc are provided by the user and are explained in the movement section of this review.

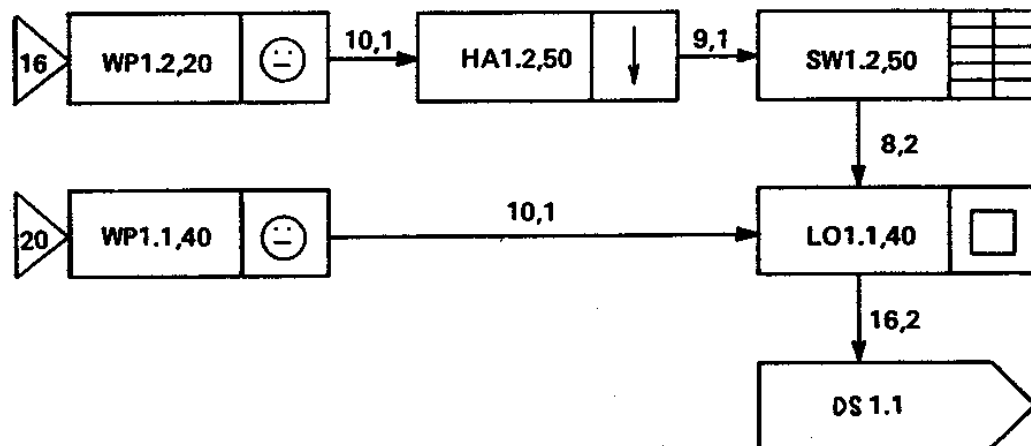

Figure A.2: EVACNET4 building structure - nodes and arcs <sup>4, p. 3</sup>

**Perspective of model:** The model views the occupants as a mass of people (global), and the occupants have a global view of the building, since occupants will move in the most optimal way throughout the space. Even though this movement may not be the shortest route, occupants are moved in a certain direction only to achieve occupant distributions that produce minimal evacuation time. In other words, all exits will have a similar time of use during the evacuation.

**Occupant behavior:** None.

**Occupant movement:** For each node, the user specifies its capacity and initial contents, in number of people. For each arc, the user supplies an arc traversal time and arc flow capacity. The traversal time is the number of time periods it takes to traverse the passageway (represented

by the arc), which is calculated by using the distance of the arc and the speed of the occupants. The arc flow capacity is the upper limit on the number of people that can traverse the passageway per time period, which is calculated using the width of the arc and the flow (persons/foot-minute) of the occupants through that space. The data (speed and flow) is provided by the user, meaning that the source of the movement data is left up to the user to decide. And, once specified for the occupants of the simulation, the data (speed and flow) remain constant.

**Use of fire data:** None.

**Output:** The output is organized and explained in Table A.1.

Table A.1: EVACNET4 Output

Parameter	Description
General overview	Time to evacuate the building, time of uncongested evacuation, the congestion factor (building evacuation time divided by uncongested evacuation time), the average time for an evacuee to egress the building, the average number of evacuees per specified time period, the number of successful evacuees
Destination node distribution	Number of evacuees that passed through that exit to safety
Total arc movement	List of arcs and the number of people traveling through each one
Identification of bottlenecks	List of arcs that had bottlenecks (queues) and the corresponding time periods that the arc was a bottleneck
Floor clearing time	Time period that the last evacuee left that floor
Node clearing time	Time period that the last evacuee left the node
Uncongested evacuation time by node	Number of time periods that the node was uncongested
Building evacuation profile	Number of evacuees per time period
Destination evacuation profile	Number of evacuees per exit per time period
Node contents profile	Number of people waiting at the end of a time period for a specified node
Arc movement profile	Number of people moving at the end of a time period for a specific arc, respectively
Bottleneck information for a specific arc	Number of people waiting at a specific node
Node contents snapshot	Number of people at a specific node at a specified time period
Non-evacuee allocation	Number of people not evacuated by a particular time period

**Use of fire data:** None.

**Import CAD drawings:** No. The user enters capacity of the nodes and the initial contents. Building data is not necessarily supplied because the dynamic capacity (flow) and the traversal times specified in the input move people throughout the building as evacuation time progresses.

**Visualization capabilities:** None.

**Validation studies:** Johnson, et al<sup>5</sup>, provides validation for EVACNET+ (a previous version of EVACNET4) from an unsuspected evacuation from the National Gallery of Victoria involving 1014 people. Gwynne<sup>6</sup> explains the biases in the write-up due to the fact that information which would not have been known before the evacuation was entered into the model, such as the information that one exit was not used, the under-use of another exit, etc). Gwynne also notes that because EVACNET optimizes an evacuation, any overestimation by the model is a large error. The results are shown below in Table A.2:

Table A.2: Results of validation study for EVACNET+

Exit	Evacuation Time (s)	EVACNET+ time (s)
A	420	424
B	420	424
C	480	521
D	480	512
Total time	480	521

**Special features:**

*Elevator use* – Yes. The inputs required includes the "down" travel time, the "up" travel time, the time of the first "down" departure, and the elevator capacity. Given this information, EVACNET4 runs the elevator on the defined schedule for the duration of the evacuation. Passengers are carried only on "down" trips. This is shown in Figure A.3.

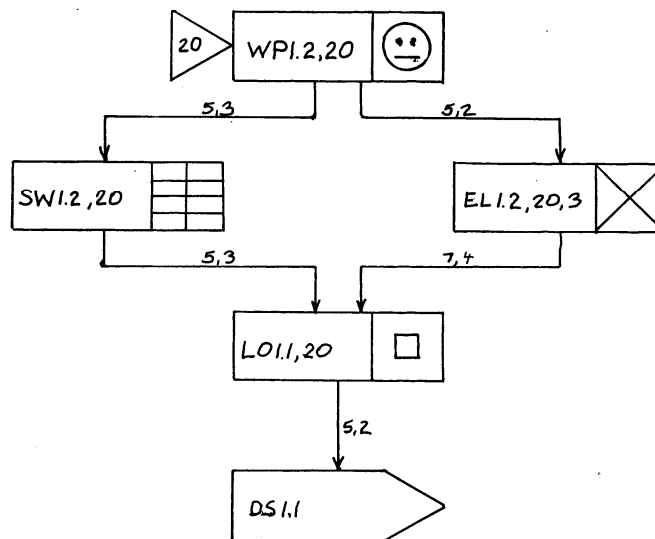

Figure A.3: EVACNET diagram incorporating elevator use <sup>4, p. 66</sup>

*Route choice of the occupants/occupant distribution* – Optimal route only

**Limitations:** The model's array sizes can be accustomed to fit needs of building. This simply requires a larger memory. The text input files are arduous to assemble for a complex building.

### A.3 TIMTEX

Developer: S.S. Harrington, University of Maryland, U.S.

**Purpose of the model:** The TIMTEX model was developed to model evacuation from buildings 4 to 15 stories high with consideration of certain human factors, such as occupant decision on stair use<sup>7</sup>.

**Availability to the public for use:** Since it was released as a Master's thesis, this model is inherently available to the public.

**Modeling method:** This is a movement model.

**Structure of model:** This is a coarse network system. Instead of acknowledging the entire floor plan, TIMTEX concentrates on movement from the corridor on the floor to the stairs and then to the exits. The model mainly focuses on the corridor and stair sections of the building.

**Perspective of model:** The model views the occupants globally as a certain number of occupants per floor moving as a homogeneous mass to the exits. The model sees all occupants as alert and able bodied. The occupants view the building with an individual perspective because the user can choose the flow split of occupants to the stairs. The occupants will not necessarily move to the closest stair. Instead, the user can either claim that a stair is frequently used and TIMTEX will use the default percentage use of the popular stair, which is a 64 % increase, or the user can enter any kind of flow split they want for the floor plans. In this case, it would be possible for the user to model a certain percentage of the population using the main exit, which may be the most familiar.

**Occupant behavior:** None.

**Occupant movement:** TIMTEX uses the equations specified in the SFPE Handbook<sup>8</sup> to move occupants throughout the corridors and stair systems. The speed and flow are dependent upon density through each component. Also, the model uses the Handbook's rules to handle all transition points (i.e., merging streams, where egress elements dimensions change, etc.). Flow up stairs is 10 % slower than down stairs, as specified by Pauls<sup>9</sup>. If queuing occurs in the stairs, the model assumes that the upper floors dominate the flow. There are no variations in the speed, dependent upon the conditions or types of occupants. Instead, flow and density calculations are based on values from the Handbook (which have been averaged among occupant types). The user enters in either the building population per floor or the area of each floor, and the model will enter in the number of occupants for that occupancy type (building occupancy uses 212 ft<sup>2</sup>/person, as an example). Again, it is up to the user to accept the flow split generated by TIMTEX or enter a new split.

**Output:** Total evacuation time and individual floor clearing times are included in the output and are shown in Figure A.4.

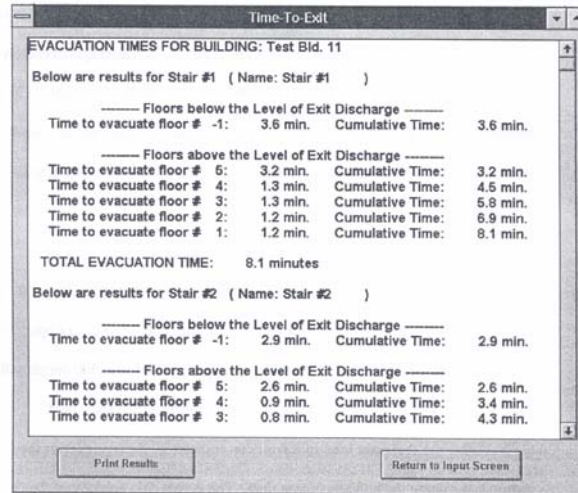

Figure A.4: Window from output of TIMTEX <sup>7</sup>, p. 55

**Use of fire data:** None.

**Import CAD drawings:** No. The user supplies the following data to the model: the corridor length and width, the stair width, the stair door width, the landing length and width, the floor to floor height, and the riser/tread dimensions. Boundary layers are automatically subtracted from the building components. The user also supplies the number of stories and if a stair is frequently used.

**Visualization capabilities:** None.

**Validation studies:** The model has been validated for buildings under 15 stories by comparing results to the work done by Pauls<sup>8,10</sup>.

**Special features:**

*Route choice of the occupants/occupant distribution* – User chooses the flow split of occupants on the floor.

**Limitations:** This model does not actually move people throughout the floor plan, but rather occupants begin at the entrance to the staircase.

## A.4 WAYOUT

Developer: V.O. Shestopal, Fire Modelling & Computing, AU

**Purpose of the model:** WAYOUT has been created to compute traffic flow in emergency situations from a multi-room or multi-story building. In this model, only merging flows are considered<sup>11, 12</sup>.

**Availability to the public for use:** The model is available from Fire Modelling & Computing in Australia as part of FireWind (18 programs) and the price is negotiable.

**Modeling method:** Movement model

**Structure of model:** This is a coarse network system. The model labels each compartment of constant width with a number and refers to this compartment as a “twig.” If the compartment has a variable width, it is divided into multiple twigs. For a building evacuation with multiple exits, it is up to the user to draw “watersheds” to divide the flows (on the basis of psychological or other considerations) and compute the route separately. The method of labeling nodes in WAYOUT is shown in Figure A.5.

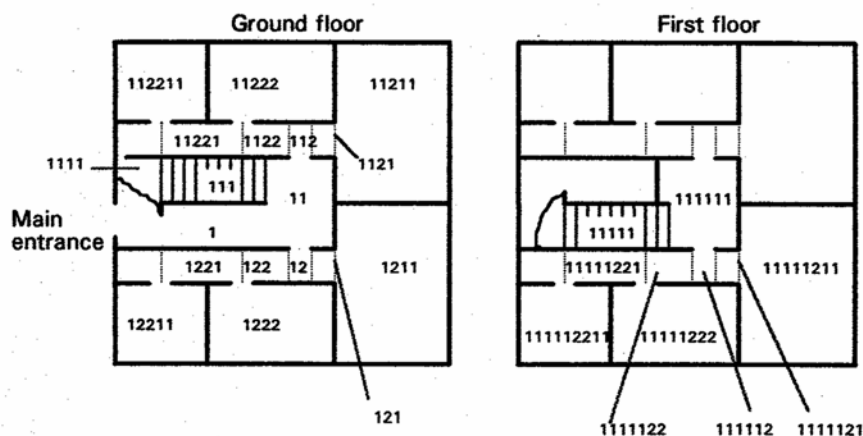

FIGURE 2. Two-storey building used in the example calculation. Twig numbers marked.

Figure A.5: Example of how nodes are labeled in WAYOUT<sup>12, p. 628</sup>

**Perspective of model:** The model views the occupants globally as “packs.” And, since the occupants have only one route to choose from, the occupants’ perspective will be labeled as global, also.

**Occupant behavior:** None.

**Occupant movement:** The movement of the occupants is based on density versus speed data collected by Predtechenskii and Milinskii<sup>13</sup>. Density is defined as  $D=Nf/wL$ , where  $N$  is the



number of people in the stream,  $f$  is the area of horizontal projection of a person,  $w$  is the width of the stream, and  $L$  is the length of the stream of people. The maximum density of their results is  $0.92 \text{ m}^2/\text{m}^2$ , and WAYOUT uses the adult in mid-season dress ( $0.113 \text{ m}^2$ ) to calculate  $f$ . Density is monitored on each building section (Predtechenskii and Milinskii data distinguishes between travel on horizontal components, through doorways, down stairs and up stairs). WAYOUT considers flows throughout the route from door to door of each compartment.

**Output:** The output from this model is the complete movement time and individual times when each twig is evacuated.

**Use of fire data:** None.

**Import CAD drawings:** No. The user inputs geometrical configuration, including the length and width of twigs, width of doors, and the population numbers in each twig.

**Visualization capabilities:** 2-D visualization of the evacuation tree is provided.

**Validation studies:** An evacuation study was performed on the Milburn House in Newcastle, UK as a fire drill. The results are provided in Table A.3. The number of evacuees was monitored at each exit. The fire drill and simulation results are provided below for this 7-story building:

Table A.3: Milburn House validation results for WAYOUT

	# of Evacuees	Time of the gap in flow (s)		Time of evacuation (s)	
		Tested	Computed	Tested	Computed
Exit 4	40	-	-	60	40 – 99
Exit 8	48	-	-	156	164
Exit 10	248	220	168	266	243

The calculations shown in the table were made for those exits which a large number of occupants used. The developers note that the occupants may not be moving as fast as they may in an actual evacuation because of the fact that their movement was a drill. This may be an explanation for the computed values providing a shorter evacuation time in most cases. Some difficulties in this validation work were the incomplete response of all occupants involved, and minor discrepancies in the records of occupants passing through certain stairs and exit doors. The developers note, though, that this comparison “seems to be satisfactory.”

**Special features:**

*Delays/pre-movement time* – Yes, user enters start time for evacuation if the twig is a blind end. This is so the user can incorporate time delays in receiving the alarm cue.

*Route choice of the occupants/occupant distribution* – Only 1-route

**Limitations:** Only merging flows are considered. The model allows for up to 400 “twigs.”

## A.5 STEPS

Developer: Mott MacDonald, UK

**Purpose of the model:** The purpose of this model is to simulate occupants in a normal or emergency situation within different types of buildings, such as stadiums or office buildings<sup>14-20</sup>.

**Availability to the public for use:** The model is available for use by the end user from Mott MacDonald.

**Modeling method:** This is a movement/partial behavioral model. It contains pre-movement abilities, occupant characteristics, patience factor, and family behavior.

**Structure of model:** This is a fine network system made up of a series of grid cells, in which only one occupant can occupy each cell. The default grid cell size is 0.5m by 0.5 m. Another “fine grid” option is available where more than one person can occupy a grid cell, but this option is still in test mode.

**Perspective of model:** The model views the occupants individually and allows the user to give individual traits to each person or groups of people in the simulation. The occupants also have an individual view of the building, because the user can specify each occupant’s (or group’s) “target” or checkpoint (exit), allowing for the user to aid in the mapping of a defined route for certain groups of people. Also, for each target, each occupant group is assigned an awareness factor between 0 and 1, specifying the fraction of that group which knows about the exit. If a 0 is specified for the occupant group and target, that denotes that no one in the group knows about the target or exit, and the label of 1 would specify that everyone in the group knows about the target or exit. The occupants choose the exit that they travel to according to the score assigned to each exit. This score is based on the following four factors: 1) the shortest distance to the exit, 2) familiarity with the exit, 3) the number of occupants around the exit, and 4) the number of exit lanes.

**Occupant behavior:** No behavior is simulated using this model. From the publications, it can be argued that the behavior borders on implicit with the use of inputs such as patience and the action of family groups moving together before exiting, however there was not enough evidence of this capability to categorize this model as implicit.

**Occupant movement:** In high density situations or queuing, the movement speed is affected by the availability of the next grid cell. In a grid cell, the individual has 8 possible decisions surrounding the grid cell and the decision of where to go is based on which of the adjacent grid cells has the lowest potential. When specifying an exit in STEPS, the program will calculate the Potential Table which will provide the shortest distance from each grid cell to the target. A recursive algorithm will be used by the program to find the distance from each grid cell to the exit. The potential for exit cells is 0, and the program then jumps to each adjacent cell to calculate its potential. If the program jumps to a cell using a diagonal move, STEPS will add (Grid Size value\*(Sqrt. 2)) to the cell’s current potential, and if the program jumps to a cell using a horizontal or vertical move, STEPS will add the Grid Size value to the cell’s current potential.

When occupants are deciding which route to take or which exit to use, they choose the path with the lowest score. If multiple paths have the same score, the occupants randomly chose between them. STEPS uses an algorithm to score each Target for each individual, and this algorithm is divided into 8 stages:

- Time needed to reach the target.
- Time needed to queue at the target.
- Adjustment of the walking time to take into account the time that is not actually walked to reach the end of the queue.
- Calculation of the real time needed to reach the end of the queue.
- Adjustment of the queuing time to take into account the people that will get out while the person is walking.
- Calculation of the real time to queue.
- Incorporate patience levels.
- Calculation of the final score

To calculate the time needed to reach the target,  $T_{walk}$ , the distance to the target ( $D$ , obtained from the potential table described above) is divided by the person’s walking speed ( $W$ , entered by the user). This is shown in Equation (A.1).

$$T_{walk} = D/W \tag{A.1}$$

The time needed to queue at the target ( $T_{queue}$ ) divides the number of people that will reach the target before the current person ( $N$ , by comparing the “time needed to reach the target” of the current person with all others in the same plane) by the flow rate of the target ( $F$ , also specified by the user in p/s). This is shown in Equation (A.2).

$$T_{queue} = N/F \tag{A.2}$$

All occupants with a lower  $T_{walk}$  are considered to be in front of the current person. Since  $T_{walk}$  gives the total time to walk to the target if there was no queuing, the additional of  $T_{walk}$  and  $T_{queue}$  would give a larger evacuation time than needed for the occupant to reach the exit. The program makes adjustments to these values, naming them “real time to walk” and “real time to queue.” The “real time to walk” is found by subtracting off the time to walk through the area where the queue has formed, resulting in the time to walk until reaching the end of the queue for that current person. The queue time also has to be adjusted because while the person is walking to the queue, others are leaving through the exit, reducing the queue. The “real time to queue” is calculated by subtracting the time it takes for those occupants to leave through the exit before the current person joins the queue. Patience coefficients are also factored into the score and influence how long the occupant will wait in the queue. There are also walking and queuing coefficients that are not quite explained in the users manual that also play a role in the score for route choice.

The user specifies (or maintains the default values for) a number of attributes for the people, such as body width, depth, and height, patience, walking speed, and their people type/group.

Occupants can also be introduced into the simulation at a certain time and place, after the evacuation has begun. When family groups are specified in STEPS, the family moves throughout the simulation to meet at a certain position in the building before evacuating.

**Output:** STEPS output includes the total evacuation time, numbers of occupants in certain areas, planes, paths, and the entire simulation and the number of people that have left these different fields vs. time.

**Use of fire data:** None.

**Import CAD drawings:** Yes, CAD drawings are input in DXF file format.

**Visualization capabilities:** 3-D visualization.

**Validation studies:** STEPS simulations have been compared to the method of evacuation calculations outlined by NFPA 130<sup>21</sup>. This report outlines two examples that demonstrate STEPS' applicability to station geometries. The first case, shown in Figure A.6, involves a center-platform station in which the platform is raised above the concourse (at grade level) as shown in the figure. By using the NFPA calculations for Case 1, the total time to clear the platform is 190.7 s and the total time to evacuate the station is 239.9 s.

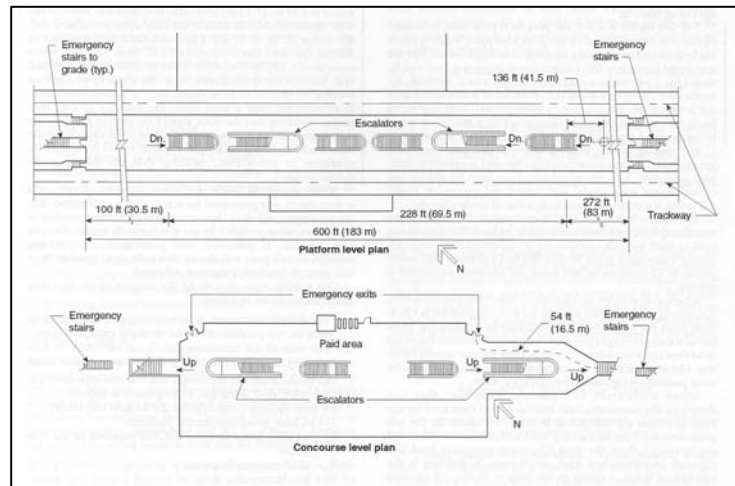

**Figure A.6: Case Study 1** <sup>21</sup>, p. 130-30

When the identical model of this station is simulated with STEPS, the mean time to clear the platform is 212.4 s and the mean evacuation time is 257.4 s. This case shows a difference of 7.3 % to 11.4 % between NFPA 130 and STEPS. Also, STEPS is able to model the natural imbalance of exit use, while NFPA 130 calculations assume that all exits are used optimally.

Case 2 involves a more complex station with a side-platform. As shown in Figure A.7, the concourse is below grade level and the platform is below the level of the concourse. Using NFPA 130, the total time to clear the platform is 179.8 s and the total evacuation of the station is 369.8 s. Also, when recalculating NFPA evacuation times using a different, more realistic split, the result is found to be 306.3 s. When modeled in STEPS, a mean platform clearing time of 181.4 s is achieved and a mean total evacuation time was 313.2 s. This shows a 0.9 % to 2.3 % difference between STEPS and NFPA 130 calculation methods.

In both cases, STEPS has given the more conservative result. This comparison has that STEPS can reproduce similar evacuation times when compared with NFPA 130. It is not clear what this type of validation exercise shows.

**Special features:**

*Manual exit block/obstacles* – Yes, the user can enter blockages at specific points throughout the floor plan.

*Defining groups* – Yes.

*Disabilities/slow occupant groups* – Yes.

*Delays/pre-movement time* – Yes, this is specified by the user.

*Elevator use* – Yes.

*Impatience/drive variables* – There is an impatience factor of 0 to 1 and represents how prepared the occupants are to queue at the target. The patient people will wait longer before moving to another target. This coefficient affects the queuing time calculation for the occupant.

*Route choice of the occupants/occupant distribution* – The route choice is varied by the score of target or is user-defined.

**Limitations:** One of the limitations of this model is the fact that occupants move only according to availability of next grid cell. There is no limit on the number of floors to use. However, the real strain on the computer comes from the number of grid cells and the number of people specified in the model. If the user has a particularly fast computer, there is no limit.

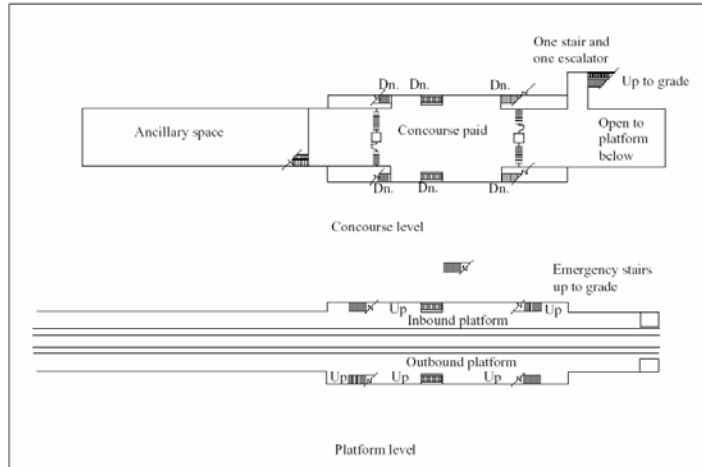

Figure A.7: Case Study 2 <sup>21</sup>, p. 130-32

## A.6 PedGo

Developer: TraffGo

**Purpose of the model:** To model crowd movement, to simulate the evacuation of pedestrians from buildings, ships, aircraft, and other kinds of public transportation systems<sup>22-24</sup>.

**Availability to the public for use:** Yes, there are software licenses available for the PedGo model via the company, TraffGo.

**Modeling method:** Movement/Partial Behavioral Model

**Structure of model:** This is a fine network model that divides the floor plan into – 0.4 x 0.4 m grid cells – represent the space taken up by a person. The walls, furniture and any other obstacles are represented by cells which are occupied at all times throughout the simulation.

**Perspective of model:** This model is labeled as a microscopic model, meaning that each person is represented individually. Therefore the perspective of the model is individualistic. And, since the user can specify egress routes for the occupants, the occupants' perspective of the building is also individualistic.

**Occupant behavior:** Implicit behavior. The model begins to offer implicit behavioral inputs, such as the individual inputs of pre-evacuation delays, patience, reaction, dawdle, and sway. This set of parameters is used for characterization of behavior and are assigned to individuals in the simulation according to a normal distribution. Two of these parameters, delay time and sway are stochastic. These parameters, as shown in Figure A.8 (reference 24 below), are the following:

- Maximum walking speed (cells)
- Patience (s) – the time a person is willing to wait until choosing another escape route
- Look (cells) – a factor describing visual perception of the environment
- Reaction (s) – a factor describing the inertia of a person's movement
- Dawdle (%) – stopping for one timestep (stochastic)
- Sway (%) – deviation from a straightforward path to the exit (stochastic).

**Occupant movement:** Cellular automata model.

One set of rules is applied to all occupants in the model regarding their movement. Individual differences affect the person's behavior. The six parameters characterizing an occupant's ability are the following: maximum velocity (cells), patience (s), reaction (s), dawdle (%), sway (%), and inertia. Each parameter is given a minimum, maximum, and mean value and standard deviation to distribute over occupants in the simulation.

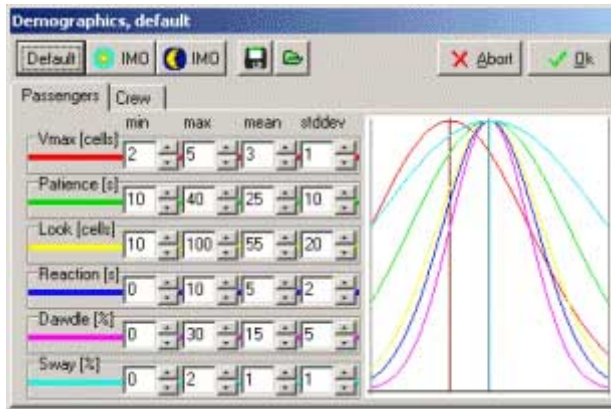

Figure A.8: Example of occupant behavior specification in PedGo<sup>24</sup>

The algorithm for the occupants' movement is presented here in Figure A.9 (below, ref 22). Each occupant is assigned a maximum walking speed which is measured in cells per time-step (which corresponds to 1 second).

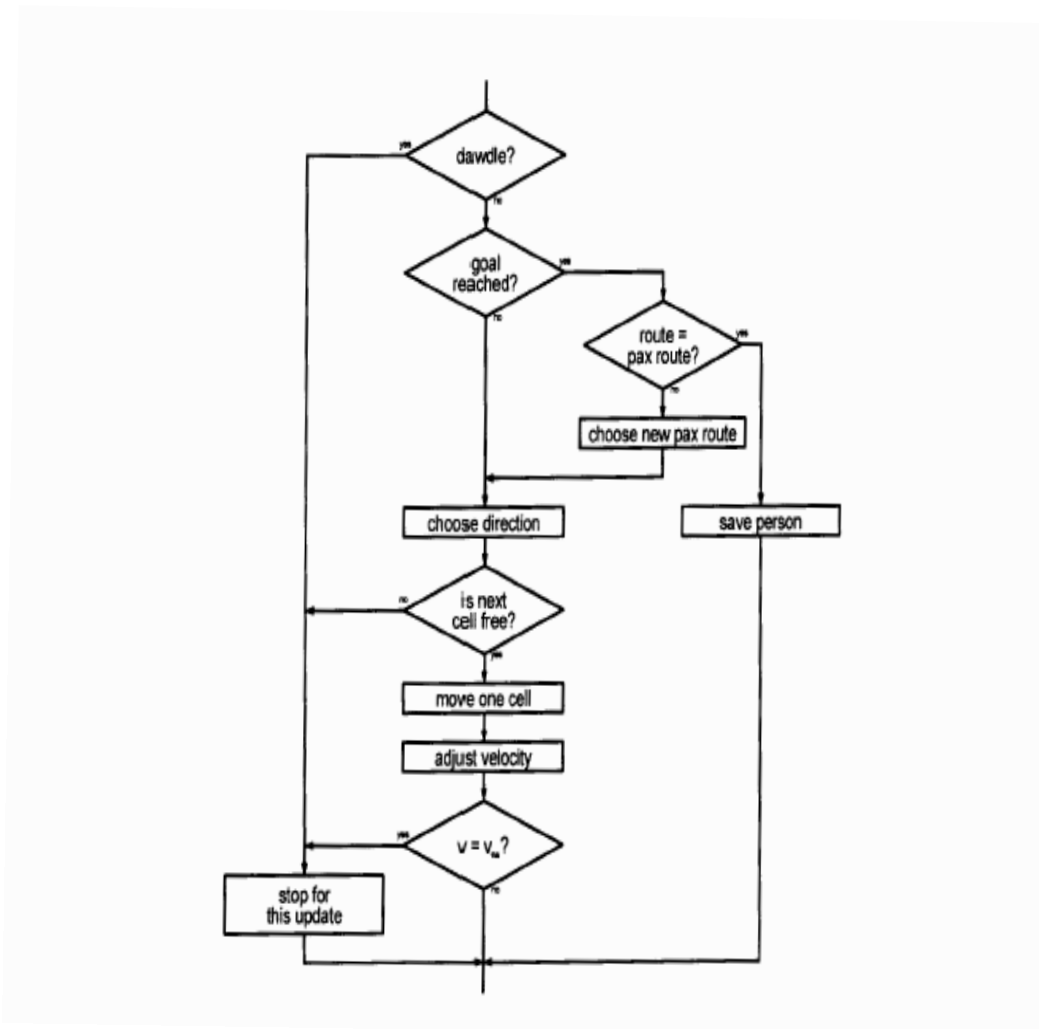

Figure A.9: Movement algorithm in PedGo<sup>22, p. 333</sup>

Any interaction between the occupants revolves around the idea that no two occupants can be in the same grid cell at the same time. In order to calculate local density, PedGo calculates the density of the three cells surrounding each individual cell (which turns out to be the ratio of the occupied cells and the area of 6.25 m<sup>2</sup>).

**Use of fire data:** None.

**Output:** According to the Traffgo website, PedGo can produce a variety of evacuation results for the user. The model can generate text files that can be imported into spreadsheet programs, pictures (bitmaps) of data plots (ex. density) or screenshots, and animations<sup>24</sup>.

**Import CAD drawings:** Yes. PedGo Editor is used for the conversion and preprocessing of floor plans into the simulation format. The editor is shown here in Figure A.10 (ref 25).

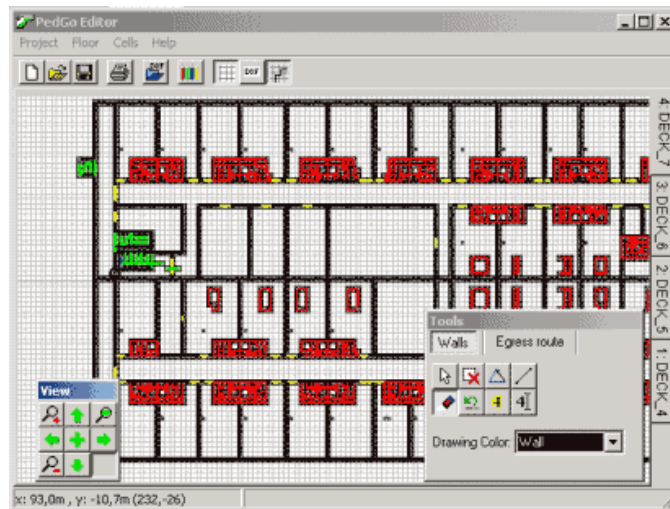

Figure A.10: Floor plan editor in PedGo<sup>25</sup>

When the user imports a dxf file, the Editor assigns colors to all of the elements on the drawing (i.e. walls, doors, stairs). Then, the Editor transforms this data into cell information. Also, the floorplan can be edited by moving, deleting or creating new elements. Passengers can be added at this step to the plans. Also, egress routes can be created and assigned to various occupants throughout the building.

**Visualization capabilities:** Yes, 2D visualization.

**Validation studies:** With fire drills and people movement trial data.

**Special features:**

*Defining groups:* Each group is assigned to a list of potentials which outlines their egress route throughout the building.



*Disabled/slow occupants:* The user can specify a slower maximum velocity for a specific individual or group of individuals.

*Pre-evacuation delays:* There is a specific input for each individual that is known as delay time. With this input, the user can specify the time period that the occupant will wait before starting to evacuate. Also, another input, referred to as “dawdling” in the evacuation model, identifies the probability with which an occupant will stop for one timestep in order to simulate breaks in the evacuation.

*Impatience/drive variables:* The input of patience is provided as an input for each individual. The input is provided in time (seconds) and the user can input information about an individual’s patience by providing a minimum, maximum, mean, and standard deviation of the times (pertaining to patience). Need more information about this.

*Route choice of the occupants/occupant distribution:* Occupants can be assigned a specific route with a probability and these routes are represented by adding information to each cell that includes the distance to the next exit, respectively. Also, in order to simulate the role of staff or crew in a building/structure, PedGo allows the user to assign certain routes to individuals (staff) which do not immediately lead to an exit, but rather into an area of the structure before exiting.

**Limitations:** Not as much documentation on this model compared with others.

## A.7 PEDROUTE and PAXPORT

Developer: Halcrow Fox Associates, UK

**Purpose of the model:** The purpose of this model is to simulate the passage of travelers through public transport stations<sup>26-32</sup>. PEDROUTE has been used to model approximately 100 underground stations in London. PAXPORT, which can model airports or railway terminals, has the capability of incorporating the movement of passengers in shopping and waiting areas in the stations. PAXPORT can model aircraft, train, bus, and passenger movements. The models can be used to show where capacity problems are likely within the stations, and to test improvements.

**Availability to the public for use:** PEDROUTE can be purchased from Halcrow Fox Associates. Or, Halcrow Fox will build a model for the client directly and test changes in-house. PAXPORT is not commercially available.

**Modeling method:** This is a partial behavioral model. It relies on speed/flow curves which have been established from past observations of stations in normal use. Also, attention is paid to usage of facilities, which is modeled in the form of occupant delays.

**Structure of model:** This is a coarse network system. The station plans are broken down into “blocks” which represent stairs, escalators, platforms, ticket halls, etc. Each block has a speed/flow curve associated with it to describe the movement of the passengers. These speed/flow curves have been established from past surveys at underground stations.

**Perspective of model:** The model views the occupants globally because instead of individually recognizing each occupant; the occupant becomes one of 16 different group types. Each group type is categorized by flight type (domestic flight, long haul, etc.) and purpose (business and leisure) and is assumed to have particular characteristics. The occupants view the building with a global perspective because passengers either travel through the station on the basis of the quickest journey time (Stochastic assignment) or the passenger flows are balanced on all routes in order to minimize the total time for all routes (optimization or equilibrium assignment). The developers suggest that occupants can be forced to follow exit signs as well, which may be considered as an individual perspective.

**Occupant behavior:** Implicit behavior is modeled.

**Occupant movement:** Occupant movement is described by speed/flow curves of each block obtained by previously observed movement in stations. Also, the model attempts to represent the delays caused by behaviors of usage of certain facilities in the station. Each group type is categorized by the flight type and purpose of the trip. The user identifies initial walking speeds and group size as input.

Each group type requires the user to supply data such as the following:

- Arrival times
- Processes followed by the passenger (i.e., check-in/security and passport control) for both departing and arriving passengers
- The possibility of escorts (with departing passengers) and greeters (with arriving passengers)
- The proportion of free time of the passenger spent in lounges, seating areas, refreshment areas, leisure, etc.
- The proportion of passengers carrying baggage or using baggage carts
- The possibility of using certain facilities, even those who visit the terminal for shopping reasons only
- Passengers can be forced to follow signage as an option

These traits are distributed throughout the group type.

**Output:** Different output forms are available to the user. The user can view the Fruin “Level of Service” for any of the blocks in the station. Other outputs available are details of peak occupancy and average delay per passenger. The model can produce journey time savings from improvements made to the station plans.

**Use of fire data:** None.

**Import CAD drawings:** Both models require a graphical input of the station layout, and this layout can be imported from CAD plans. Also, all 1-way movement areas need to be input. The user identifies the block types on a floor plan, such as passageways, moving walkways, stairs, escalator, platforms, service desks, lifts, and concourses, and also defines the coverage of the blocks by tracing over the CAD layout within the program. This defines their area (length and width) and their connections to each other.

**Visualization capabilities:** 2-D or 3-D simulation. Data of flow, service levels, occupancy and delay can be displayed for the entire terminal or sections.

**Validation studies:** For the PAXPORT model, simulations were run as representations of North Terminal at London’s Gatwick Airport. However, details of the results of this study were not found.

**Special features:**

*Defining groups* – Yes.

*Disabilities/slow occupant groups* – Yes.

*Delays/pre-movement time* – Yes.

*Route choice of the occupants/occupant distribution* – Quickest route, Optimization, or follow exit signs.

**Limitations:** No individual consideration.

## A.8 Simulex

Developer: P.Thompson, Integrated Environmental Systems, United Kingdom

**Purpose of the model:** Simulex is an evacuation model with the capability of simulating a large amount of people from geometrically complex buildings<sup>33-40</sup>.

**Availability to the public for use:** The program is available under license from IES, Integrated Environmental Solutions, Ltd in the UK. Academic licenses are also available.

**Modeling method:** This is a partial behavior model. It relies on inter-person distances to specify walking speed of the occupants. Also, the model allows for overtaking, body rotation, sideways stepping, and small degrees of back-stepping.

**Structure of model:** This is a continuous space system. The floor plan and staircase are divided up into a grid of 0.2 by 0.2 m blocks or grid cells. The model contains an algorithm that will calculate the distance from each block to the nearest exit, and labels this information on a distance map. An example distance map is shown in Figure A.11.

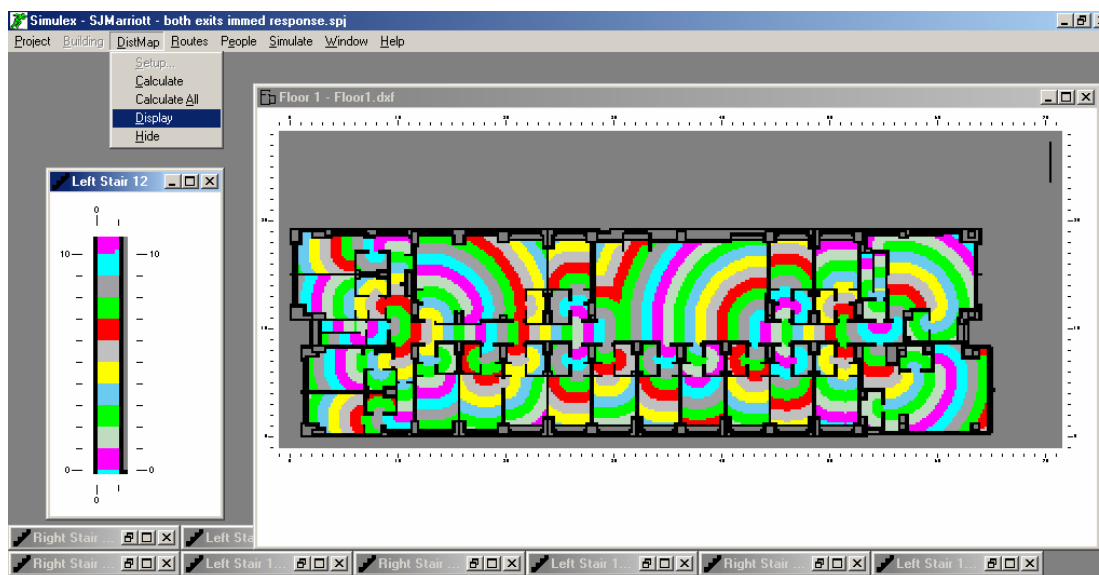

Figure A.11: Example of visualization of the distance map in Simulex

**Perspective of model:** The model views the occupants individually. The output of the model tracks the individuals' positions throughout the evacuation, as shown during the visualization. Also, the occupants have an individual view of the building because the route choice can consist of either the shortest route calculated by the default distance map or a user-defined route obtained by assigning an alternate distance map to an individual or group of occupants. The alternate distance map can block certain exits in order to force or guide an occupant to take a certain route throughout the building.

**Occupant behavior:** Implicit behavior is modeled.

**Occupant movement:** From the Simulex website<sup>41</sup>: “The algorithms in Simulex which model fluctuations in walking speed, side-stepping, body-twisting, overtaking etc. are based on a combination of the results of many video-based analyses of individual movement and the additional results of a number of academic researchers.”

As mentioned earlier, the distance maps are used to direct occupants to the closest available exit, where each person moves toward an exit by taking the direction that is at right angles to the constant-distance contours from the exit. The user can create up to 10 different distance maps in the simulation.

The occupants walking speed is a function of inter-person distance. An example of the data used for this movement is shown in Figure A.12.

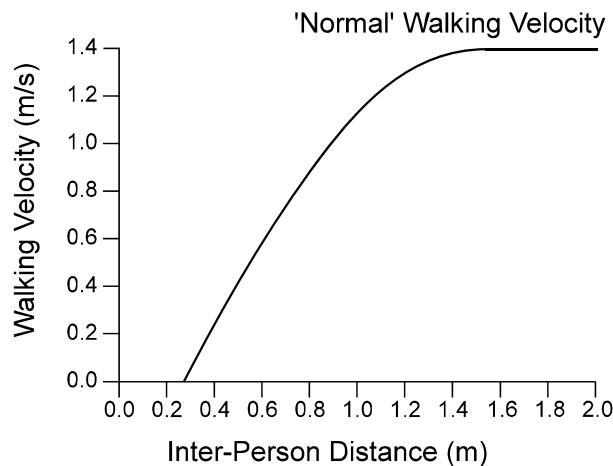

Figure A.12: Example of the velocity versus inter-person distance used for the movement algorithm in Simulex<sup>11, p. 3</sup>

The walking speed of an occupant is dependent upon the proximity (or distance away) from the people ahead. The inter-person distance is defined as the distance between the centers of the bodies of two individuals. The best-fit equation (A.3) for the graph above is shown here:

$$v = V_u \times \sin \left\{ 90 \times \left( \frac{d - b}{t_d - b} \right) \right\} \quad \text{when } b \leq d \leq t_d \quad (A.3)$$

$$v = V_u \quad \text{when } d > t_d$$

where  $v$  is the impeded walking velocity (m/s),  $V_u$  is the unimpeded (normal) walking velocity (m/s),  $d$  is the inter-person distance (m),  $t_d$  is the threshold distance (1.6 m), and  $b$  is the body depth (torso radius).

The walking velocity on stairs is restricted to 0.6 times the normal unimpeded velocity assigned to each occupant characteristic/type.

In order to calculate the velocity of the occupants (or groups of occupants) on certain building components, the occupant type must be selected by the user from the following list. The

occupant type/characteristics then correspond to a particular body size (or distribution of body sizes) and unimpeded walking speed, which is used in the velocity equation A.10. The velocities shown in Table A.4 are frequently followed by a  $\pm$  value. This indicates that a range of velocities are distributed to that specific occupant type. For instance, for an “all male” group, velocities can range from 1.15 to 1.55 m/s. The chart of occupant characteristics is shown in Table A.5.

Table A.4: Corresponding body sizes and initial velocity for various occupant types in Simulex

Occupant Characteristic / Population	% Median	% Male	% Female	% Child	% Elderly	Body Size ( $m^2$ )	Initial Velocity m/s
All Elderly	0	0	0	0	100	0.113	0.8 $\pm 0.3$
All Male	0	100	0	0	0	0.130	1.35 $\pm 0.2$
All Female	0	0	100	0	0	0.101	1.15 $\pm 0.2$
All Children	0	0	0	100	0	0.070	0.9 $\pm 0.3$
All 1.0 m/s	100	0	0	0	0	0.118	1.0
All 1.2 m/s	100	0	0	0	0	0.130	1.2
All 1.3 m/s	100	0	0	0	0	0.118	1.3
All 1.4 m/s	100	0	0	0	0	0.118	1.4
Office Staff	0	60	40	0	0	Multiple	Range
Commuters	0	50	40	10	0	Multiple	Range
Shoppers	0	35	40	15	10	Multiple	Range
School Population	0	3	7	90	0	Multiple	Range

The body sizes, shown in Table A.5 and labeled in Figure A.13, are calculated using an elliptical body size and the equation for the area of an ellipse. The length of the ellipse (the torso diameter added to 2 shoulder radii) is multiplied time the width of the ellipse (the torso diameter) which is then multiplied by  $\pi/4$ . This gives the specified body size in  $m^2$ . The table below also reiterates that each body type is assigned an unimpeded walking speed, and some of these vary during distribution among the group. For instance, the adult male body type has an unimpeded velocity of 1.35 m/s which can vary by  $\pm 0.2$  m/s when distributed among the population group.

Table A.5: Body sizes for various occupant types in Simulex

Body Type	Torso Radius Rt(m)	Shoulder Radius Rs(m)	Unimpeded mean velocity Vm(m/s)	Variation in velocity +/- (m/s)
Median	0.15	0.10	1.3	0.0
Adult Male	0.16	0.10	1.35	0.2
Adult Female	0.14	0.09	1.15	0.2
Child	0.12	0.07	0.9	0.3
Elderly	0.15	0.09	0.8	0.3
NFPA-1 m/s	0.15	0.10	1.0	0.0
SFPE-1.4 m/s	0.15	0.10	1.4	0.0
SFV-1.2m/s	0.16	0.10	1.2	0.0
SFV-1.2m/s (+jacket)	0.235	0.10	1.2	0.0

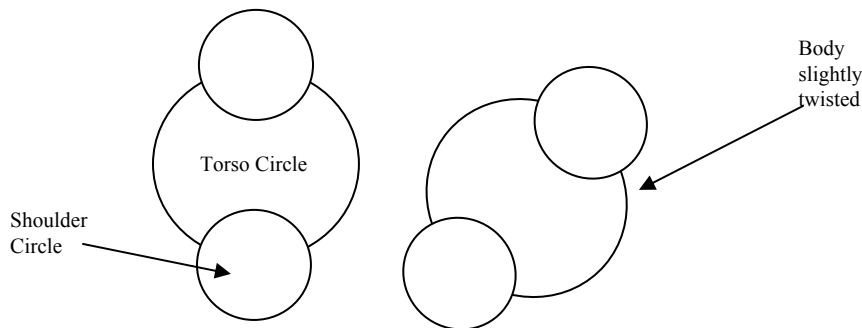

Figure A.13: Diagram of bodies used in the Simulex model

Simulex also attempts to simulate overtaking, body rotation, side-stepping, and small degrees of back-stepping as it moves occupants throughout the building.

**Output:** The output consists of a 2-D visualization of the evacuation. Also, the following is provided as output by Simulex:

- General overview of the building input: including number of floors in the building, number of created staircases, number of exits in the building, number of created links, and the number of occupants evacuating from the building.
- Floor input: initial number of occupants placed on that floor, link positions on the floor plan and connections to the corresponding staircases, and positions of the exits on that floor (if any).
- Stair input: number of occupants initially located in the stair and the link positions and corresponding connections to the floor plans.
- Overall evacuation time of all occupants reaching the exits
- Number of people passing through all exits over 5-second intervals
- Number of people through each exit (1 and 2) over 5-second intervals



- Number of people through each link created over 5-second time intervals
- Total number of occupants through each exit, based on the listing of the movement of each individual per time period.
- Exit clearing times (obtained from analysis of output)

**Use of fire data:** No.

**Import CAD drawings:** Yes, CAD drawings can be imported into the program. The program does not, however, read stair information. This must be provided by the user, such as distance and width. Also, links are specified in the program to link the floor plan with the stair section, as well as the floor plan to the exit to the outside (or area of safety).

**Visualization capabilities:** 2-D visualization.

**Validation studies:** Several validation studies are available for Simulex. One study has been completed from a supermarket as well as an examination of the flow rates through exits generated by Simulex<sup>38</sup>. Although the model developers did not have actual data from the supermarket, they compared Simulex results to that of simple hand calculations (with a velocity of 1.19 m/s) of optimal movement for populations of 1097 and 1919 people. These occupant population values resembled an occupant density of 7.0 m<sup>2</sup>/person (0.14 persons/m<sup>2</sup>) and 4.0 m<sup>2</sup>/person (0.25 persons/m<sup>2</sup>) respectively. Simulex produced evacuation times, 58.1 s for 7.0 m<sup>2</sup>/person and 105.1 s for 4.0 m<sup>2</sup>/person, that were significantly longer than the hand calculations, which produced values of 35 s and 51.3 s. It is unclear as to what this shows as to the accuracy of the model. For the simulation of flow rates, Simulex used a distribution of exit widths ranging from 0.7 to 3.0 m for a population of 100 and an occupant density of 0.25 m<sup>2</sup>/person (0.25 persons/m<sup>2</sup>). “The model was found to produce flow rates which were in good agreement with previously published data”<sup>42</sup>. The model also showed that the exits became jammed with widths smaller than 1.1 m.

Evacuation times and occupant movement were also observed in three university buildings and modeled in Simulex to compare results. Human behavior and movement of the occupants were recorded with video cameras and the total evacuation time, pre-movement times, and other evacuation behavior were noted. The three buildings consisted of a 1-story central lecture theater, an 8-story commerce building (with lecture halls, seminar rooms, computer labs, offices, etc.), and a 5-story law building (equipped with the same type rooms as the commerce building) on the University of Canterbury, Christchurch campus in New Zealand. Each of the observed evacuations took place between 10 a.m. and 2 p.m. when most of the occupants were present. The buildings were equipped with different levels of alarm, such as pre-recorded PA, live directive PA, or a siren alarm. The total evacuation times, presented in Table A.6, specified in the table below were measured from initiation of alarm until no occupants were detected in the buildings:

Table A.6: Validation study results for the Simulex model

Building	Observed Total Evacuation Time (s)	Predicted Travel Time (s)	Predicted Total Evacuation Time (s)
Lecture Theater	90	93	131
Law	170	161	188
Commerce	220	178	202

The predicted total evacuation times were obtained by adding the predicted travel times (since Simulex did not model pre-movement delays) to the observed pre-movement delays. Simulex used the following assumptions to model the three buildings:

- The occupant type used for the simulations were “office type” which specifies the walking speed and body size to be 40 % male, 30 % female, and 30 % average (this distribution was used by Simulex at the time of the validation study)
- The default distance map was used, which assumes the shortest path chosen by occupants
- Pre-movement times were not simulated by Simulex and were dealt with separately to the computer modeling.

Simulations run by Simulex<sup>43</sup> using an estimated (instead of observed) occupant load derived from the Life Safety Code Handbook<sup>44</sup> for assembly space as well as pre-movement delays as suggested by the Fire Safety Engineering in Buildings<sup>45</sup> have also been compared with observed results. The validation paper also goes on to comment on the conservative values presented in the literature, however that discussion goes beyond the scope of this review<sup>43</sup>.

The results of the study show that the simulated evacuation times were similar to the observed results (as shown in Table A.6) when Simulex used the observed pre-movement times and occupant loads. Even though it seemed that Simulex provided a conservative time for the lecture theater, it underestimated the evacuation time for the law and commerce buildings. Olssen and Regan stated that Simulex can be used “with confidence to simulate travel times for buildings” discussed previously<sup>43</sup>.

**Special features:**

*Manual exit block/obstacles* – Yes, the user can create an alternate distance map for an individual, group, or several groups in which certain exits are blocked from the population using the distance map.

*Fire conditions affect behavior?* No, the developers are currently working on importing CFAST data into their evacuation model.

*Defining groups* – Yes, groups can be defined and assigned to have a certain occupant characteristic, distance map, and distribution of pre-movement times.

*Disabilities/slow occupant groups* – Yes, the user can assign lower velocities to individuals or groups in a simulation.

*Delays/pre-movement time* – Yes, the user can choose either a triangular, random, or normal distribution for each group of occupants.

*Route choice of the occupants/occupant distribution* – Shortest distance or user-defined route.

**Limitations:** This model is limited largely by the capacity of the computer used to run the simulations. However, occupants get “stuck” in the links of the buildings during certain simulations. The user manual offers solutions to this problem.

## A.9 GridFlow

Developer: D. Purser & M. Bensilum, BRE, UK

**Purpose of the model:** The purpose of this model is to calculate egress times by representing individual occupants in building spaces on a grid network<sup>46, 47</sup>. Pre-movement time and pre-movement-travel interactions are considered central to the evacuation using GridFlow. Purser considers this model to be as informative as other sophisticated models, but uses “simple, transparent, and easily verifiable behavioral inputs, derived from empirical data or specified and justified by the user”<sup>46</sup>.

**Availability to the public for use:** This model was developed by David Purser at BRE in the UK because of the need for an in-house model that can handle pre-movement and movement times and the interaction between them. It is currently sold as part of a modeling package through BRE.

**Modeling method:** GridFlow is a partial behavior model because it relies on the density of the population to control the movement of the population and uses pre-movement time distributions observed by Purser. Occupants are also labeled with FED susceptibility and their travel speeds are affected according to the FIC due to irritant smoke, as defined by the user.

**Structure of model:** This is a continuous space system. The model overlays a grid of 0.5 by 0.5 m over the floor plan to represent the distance mapping as shown in Figure A.14. A distance map is also overlaid onto the floor plan to map the distance from every cell on the floor to all exits. This distance map is generated using a series of recursive algorithms to determine the direct distance to the exit from any point on the floor plan, while also working around obstacles present on the floor.

**Perspective of model and occupant:** The model views the occupants as individuals by giving each occupant certain characteristics, such as an xy position in the scenario as the evacuation progresses, a starting position in the simulation, a destination or exit goal, pre-movement time, unimpeded walking speed, and FED susceptibility. The occupants also have an individual view of the building during the evacuation because the occupants can either move to their nearest exit, be randomly distributed to an exit, or follow a user-defined route.

**Occupant behavior:** Implicit behavior.

**Occupant movement:** The occupants move toward the exits under the constraints of the Nelson and Mowrer chapter of the SFPE handbook<sup>8</sup>, which incorporates speed reductions based on the

**Figure A.14: GridFlow visualization of the distance mapping**<sup>46</sup>

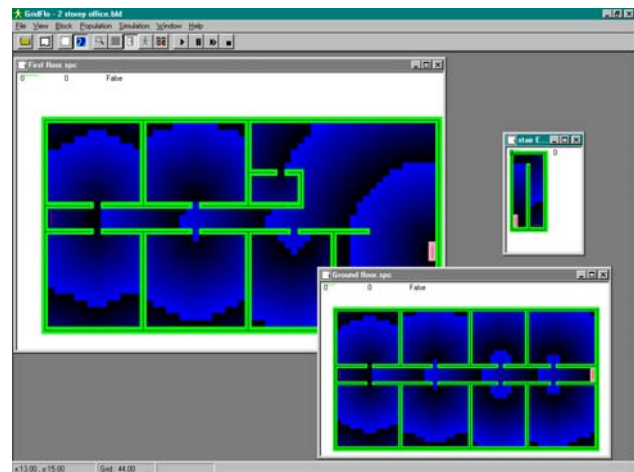

density of the space and the capacity of the doors and stairways. The unimpeded walking speed for each occupant can be specified as a single number or a distribution can be specified for the population. The default mean, taken from Nelson and Mowrer, is 1.19 m/s with a S.D. of 0.2 m/s and a minimum value of 0.3 m/s. Any specific number or distribution can be input by the user.

Any amount of occupant groups or individuals can be defined by the user. Each individual or occupant group can have a set of characteristics. The characteristics were laid out in the Perspective section above. To reiterate, the characteristics of the occupant are:

- xy coordinates of each occupant in time with the simulation
- Starting position in the simulation
- Destination/exit
- Pre-movement time
- Unimpeded walking speed
- FED susceptibility (discrete value or distribution)

Under smoke conditions, the occupants' movement speed can vary according to their FIC for the irritant smoke. Also, depending upon their susceptibility, the occupants will be given a graphical hatched pattern in the scenario when their FED reaches 0.75. When they become incapacitated, FED=1, their 2-D image will turn black and they will stop movement.

Also, overtaking of occupants can occur.

GridFlow offers multiple options for how merging flows are simulated<sup>8</sup>. The first option is the "free-flow" option, where flows are determined by the personal movement algorithms alone. When several inlets compete, the physical arrangement of the routes, widths of the links, and the crowd densities at the inlet and outlet decide the precedence. In the "controlled" flow option, additional rules are imposed on the competition. For example, when a stair with two inlets (flow from staircase above and current floor) is near or at maximum capacity, the outlet flow would balance to half from each inlet. Lastly, there is an option for assigning weights to certain links manually, so the user can control the dominance factor.

**Output:** Output data can be exported from the model into an Excel spreadsheet. The range of output include a details about the population in every space at every logging interval after each run and summarized data from a series of batched runs. The output also provides detailed aspects of the building and occupants (distributions of pre-movement, exit time, etc.).

**Use of fire data:** No, but the model allows the user to come close to this. A spreadsheet can be established for every space in the building with 3 columns; time, speed factor, and FED dose. The time column is equivalent to the time monitored in the evacuation. The speed factor gives the ability of the user to decrease the speed by a fraction as the evacuation time increases, to simulate the influence of irritant smoke. If a 0.9 factor is input by the use at t=60 s, the occupants in the specific space will decrease their individual speed by 10 %. The last column, the FED dose, allows the user to input specific FED doses at different time intervals in the simulation. For instance, if 0.05 is input at 60 s and another 0.05 is input after 80 s, the individuals in that space will obtain an FED of 0.1 by 80 s. Within the model, the user then

adjusts the FED susceptibility of each occupant or occupant group, which affects whether the person become incapacitated or can escape the building space without problem.

**Import CAD drawings:** Yes, CAD drawings can be imported into the model via another BRE program, Josephine. Or, the floor plan can be drawn using a graphical user interface (GUI) within GridFlow. The user specifies links on the floor plan that lead to the outside or another space in the building. The user is prompted to input the link width and maximum flow (persons/second) through the link.

**Visualization capabilities:** 2-D and 3-D capabilities (with Josephine).

**Validation studies:** The model developer states that GridFlow has undergone many runs of simple buildings and multi-enclosure spaces for the purpose of four aspects of validation: Component testing (routine checking of major software), functional validation (checking model capabilities and that these are compatible with intentions), qualitative testing (comparing predicted human behavior with expectations), and quantitative verification (comparison of model predictions with experimental data). The developers have performed component testing and quantitative verification, which involved simulations from simple and complex building compared against empirical data from the SFPE Handbook<sup>8</sup> and other sources. Functional validation has also been performed and limitations of the model have been identified (but not included in the Purser report). Also, human behavior has been validated by using actual pre-movement data to simulate a scenario and by comparing the model's evacuation behavior and time to the observed evacuation and Handbook data.

Purser discusses simulations used to examine the effects of delay time, travel time, and exit flow capacity for various occupancies and layouts. He outlines the results of a hypothetical building with 3 different numbers of occupants. In this work, Purser could understand graphically whether the evacuation was driven by pre-movement time, travel distributions, or exit flow capacity, depending upon the number of occupants in the building.

Lastly, a GridFlow simulation was described that was similar to an actual evacuation incident, the "Sprucefield" evacuation. This included 190 occupants evacuating from a food hall. GridFlow modeled that 99 % of the occupants would evacuate in 130 s with their similar case, when the actual time was 140 s. Purser notes that GridFlow provided reasonable results and they plan to perform direct simulations on the Sprucefield case, among others.

**Special features:**

*Counterflow* – Yes.

*Manual exit block/obstacles* – Yes, because the user can specify the destination or exit choices for each individual or occupant group, certain exits can be "hidden" (or not given as a choice) from an occupant group as if it does not exist.

*Fire conditions affect behavior?* Fire conditions are implicitly incorporated. The user imports a spreadsheet (created by the user) with speed factors and FED doses with time for each building space.

*Defining groups* – Yes.

*Disabilities/slow occupant groups* – Yes. Groups can be defined in which the user can enter a specific unimpeded walking speed and distribution of pre-movement times.

*Delays/pre-movement time* – Yes, pre-movement times can be specified as a discrete value or in the form of distributions that have been obtained from direct measurement during “monitored evacuations” or fire drills. These monitored evacuations have taken place over a span of 10 years and were taken from a range of different building occupancies.

*Toxicity of the occupants* – Yes.

*Route choice of the occupants/occupant distribution* – There are three choices; shortest distance, random, or user-defined

**Limitations:** Supports occupant populations up to 5000 (as of year 2000) and more behavioral capabilities are under development.

## A.10 ASERI

Developer: V. Schneider, I.S.T. Integrierte Sicherheits-Technik GmbH, Germany

**Purpose of the model:** The purpose of the model is to simulate egress movement in complex geometrical environments, such as railway and underground stations, airports, theatres, sports arenas, or trade fairs<sup>11, 48-51</sup>.

**Availability to the public for use:** This model is available through I.S.T. Integrierte Sicherheits-Technik GmbH. Company.

**Modeling method:** This is a behavioral model.

**Structure of model:** This is a continuous space system. The floor plan defines rooms, corridors, stairs, and refuge areas by the size and position of the doors and passageways. The model defines the instantaneous positions of every person by the coordinates which are related to a point on the floor plan or staircase. This a method allows for a 3-D representation of the building and the local modeling of people movement throughout.

Perspective of model and occupant: The model views occupants as individuals by characterizing them by a set of parameters (both fixed and conditional to the fire environment). These parameters are age, sex, fitness, incapability, social interdependencies, former experience, special knowledge about the building, response to smoke and toxic products, and the amount of information available during the evacuation (location of fire, availability of egress routes). The occupant's perspective of the building is also individual. Each person has a goal/exit, which is either the nearest exit or is prescribed by the user. The route choice is then influenced by the external impact from conditions of the building or the behavior of the other evacuees around them. Because of this, occupants can alter their behavior away from the original route (nearest or user-defined) in avoidance of smoke conditions or occupant congestion.

**Occupant behavior:** Rule-based or conditional behavior. First actions and perceiving cues can be modeled by both assigning individual alarm and reaction times or by incorporating intermediate stop positions. These positions are areas of the building that the occupant move to, wait, and then begin egress after a certain time interval. ASERI uses a matrix of estimated delay times that depends on the initial activity shown in the first column and on the corresponding action or behavior in the first row. Table A.7 is shows the delay times used by ASERI.

Table A.7: Matrix of ASERI delay times<sup>48</sup>

	Awareness	Response Time	Prepare (Dress)	Information
Watching TV	0s to 30 s	4s to 8 s	5 - 120 s	0s to 30 s
Showering	60s to TS s	4s to 10 s	30s to 300 s	0s to 60 s
Social activity	0s to TS s	4s to 10 s	5s to 240 s	0s to 60 s
Sleeping	10s to TS s	6s to 14 s	20s to 300 s	0s to 60 s
Reading/Writing	0s to TS s	4s to 8 s	5s to 120 s	0s to 45 s
Smoking	0s to 300 s	4s to 8 s	10s to 120 s	0s to 45 s



The purpose of this matrix is to model the sequence of first actions. “TS” is the time for the staff to check certain areas/rooms of the building, which depends on the communication or information events. Each corresponding behaviour/action is explained below:

- “Awareness” is the time interval beginning with the perception of the first cue to the time that the person becomes aware of the evacuation situation
- “Response Time” is the average time interval to respond to the corresponding cue. The model uses average times used by Levin which are 6 s for awake individuals and 10 s for sleeping occupants.
- “Prepare” is the time interval allowing the occupant to dress and look for valuables. This action depends on the weather and the geographical location.
- “Information” represents the time delay for occupants to seek for information and “inform others” of the event.

Individual responses to hazards in the building (actual or suspected) depend on individual specified parameters, external conditions, available information, and social relations among the occupants. Most of these parameters vary with the changing environment of the evacuation. ASERI uses Monte Carlo simulation techniques to analyze the outcome of a building evacuation by stochastically altering individual responses while leaving the initial and boundary conditions identical. By performing this type of simulation, mean egress times as well as corresponding variances and confidence limits can be obtained. Such stochastic variables include individual egress route choice and movement, the initial distribution of occupants throughout the building, and individual parameters (size, walking speed, and reaction times).

**Occupant movement:** The movement of the occupants is defined by an individual walking speed and the orientation of the corresponding velocity vector, resulting from the person’s current position and intended exit/goal. Also, obstacles and other occupants affect movement. ASERI takes note of individual body size by incorporating shoulder and chest width into the model. From this, minimum inter-person distance and boundary layer from walls and obstacles are used to move people throughout the building. Shoulder and chest width, certain behavioral conditions, and walking speeds are entered as distributions or individual input, which affect the mobility of the occupants. Different groups can be generated from these inputs, including those occupants who are disabled (simulated by, for example a lower walking speed or a larger body size to account for a wheelchair). ASERI allows the user to input persons with increased space requirement, such as occupants carrying children, briefcases, or wheelchair mobile. Because of these calculations, ASERI can model congestion, queuing, clustering, and merging of flows of occupants.

Individual movement of the occupants is driven by their global (exit or refuge area) and local (room exits, corners, etc.) goals. The local goals of the occupant change dynamically with the environment and crowd conditions. There is no grid in the model upon which the occupants move through. Instead the individual local goals of the occupants trigger movement, depending upon the geometry of the building (interior doors, obstacles, corners, etc.). The developer has explained the movement model as a sequential one with priority rules for movement. Toxic effects of the smoke components slow walking speed, alter behavioral responses, and change designated route plans. Individual incapacitation of the occupants is calculated by using

the FED model by Purser. This includes monitoring the dose of CO, HCN, CO<sub>2</sub>, low O<sub>2</sub>, and high temperature. Any obscuring effects of smoke are described by the visibility of particular spaces in the building and affect walking speed based on data from Jin<sup>52</sup>, and turn back behavior probability based on data from Bryan and Wood<sup>53</sup>.

**Output:** The output involves evacuation times plus detailed information on the structure and bottleneck/congestion situations that lead to egress delays. Because of the use of the Monte Carlo technique in specifying behavioral responses of the occupants, mean egress times along with their corresponding variances and confidence limits are obtained.

**Use of fire data:** ASERI is used in conjunction with the field model KOBRA-3D that simulates the fire and smoke spread throughout the space. Individual incapacitation can be calculated based on the FED model by Purser. ASERI includes dose-effect relations for CO, HCN, CO<sub>2</sub>, low O<sub>2</sub> and heat. Also modeled are the effects of smoke movement on visibility, speed, and exit route choice. The user can also enter time-dependent temperatures and concentrations of smoke, CO, CO<sub>2</sub>, O<sub>2</sub>, and HCN for each unit in the building. The smoke concentrations are expressed in terms of visibility.

**Import CAD drawings:** A pre-processor was intended to be available for licensees at the present time that converts standard CAD formats into ASERI input.

**Visualization capabilities:** 2-D or 3-D visualization of the movement of the evacuees, as shown in Figure A.15 and A.16.

**Validation studies:** The first validation test involves an unannounced evacuation from a theater in the City of Tampere in 1995, as shown in Figure A.16. The theater contained over 600

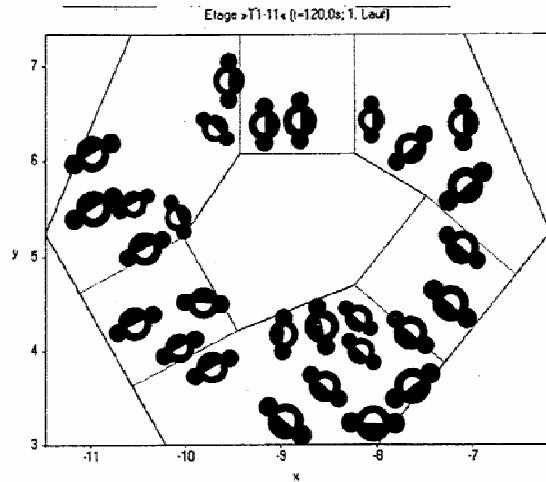

Figure A.15: ASERI visualization of a simulation<sup>48, p. 45</sup>

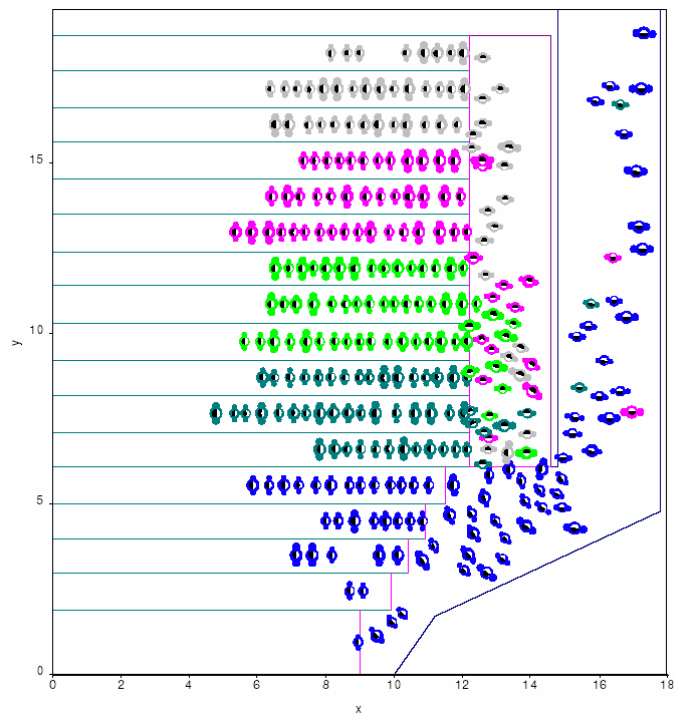

Figure A.16: ASERI visualization of the theater simulation<sup>50, p. 7</sup>

occupants. The data from this evacuation was used to assess evacuation models as well as to understand the sensitivity of the basic input parameters of the model. The simulation of the 3<sup>rd</sup> floor auditorium was restricted to half of the building due to the symmetry of the space, as shown in the ASERI diagram shown in Figure A.16. The actual pre-movement time of the theater occupants was used in the simulation as a random delay time. Also, a distribution of the individual mobility of the occupants was incorporated to produce a range of walking speeds from 0.7 to 1.5 m/s and a body size range of 0.12 m<sup>2</sup> to 0.22 m<sup>2</sup>. It was known from the original evacuation that persons with restricted mobility were present.

Figure A.17 shows the results from the actual evacuation and the simulation from ASERI.

	<b>total egress time</b>	<b>egress time auditorium</b>	<b>first person at ground floor</b>
<b>evacuation drill</b>	5:20	3:37	1:10
<b>simulation of drill</b>	5:32 ± 0:06	4:02 ± 0:06	1:15 ± 0:03
<b>danger mode</b>	4:35 ± 0:09	3:07 ± 0:08	1:14 ± 0:03
<b>homogeneous group</b>	3:27 ± 0:03	2:25 ± 0:05	1:17 ± 0:02
<b>100 % occupation</b>	6:17 ± 0:13	4: 48 ± 0:11	1:21 ± 0:06

Figure A.17: Results from the ASERI validation studies of the theater (time in min:s) <sup>50, p. 6</sup>

The first row shows the actual results from the evacuation drill of the theater building, including the evacuation time from the auditorium only (2<sup>nd</sup> column). The second row shows the results for the simulation of the drill as observed for the theater, and the third, fourth, and fifth rows are changes to the model's inputs as part of a sensitivity analysis of the model itself. The second and third rows show the effect of inputting different egress behavior (normal versus danger). The second and fourth rows show the effects of inputting different individual mobility (inhomogeneous group versus homogeneous group with unrestricted mobility – able occupants). And lastly the second and fifth rows show the difference in inputting the number of occupants into the simulation (82 % of the occupancy which was present at the time of the drill versus 100 % occupancy). The developer notes that the strongest effects on the egress time produced by the model were due to a change in mobility of the occupants. Also, the first two rows which contained the observed and simulated evacuation from the theater show very close results in all three evacuation times.

Monitored evacuation drills were conducted for three high-rise and three school buildings by the German Federal Office of Construction for the Forschungsstelle für Brandschutztechnik in cooperation with the local fire brigades. These evacuation drills were used to validate ASERI as well as used to calibrate with the Predtechenskii and Milinskii method<sup>13</sup>. After performing a range of simulations which involved changing of mobility parameters and the presence of smoke barriers in the building and comparing these to the observed evacuation drills, the developers stated that, “performing the numerical simulation with an appropriate distribution of mobility

parameters yields realistic results, as already demonstrated by the investigation of other evacuation drills.” For the tallest building, a 21-story office building with 1400 occupants, the calculated total evacuation times ranged between 616 s and 648 s, with a mean value of 627 s, while the measured evacuation time for the structure was 629 s. More information on this validation case study is provided in ASERI references.

The final case study to be discussed in this section involved the evacuation from a hotel conducted by the Norwegian SINTEF organization. The input information provided to the model for this case study involved the building layout, means of egress, geometrical staircase information, location and the sequence of the fire incident, and the communication events put in place by the evacuation plan. The evacuation case that follows the evacuation plan is called the “schedule case” and actual observation of the drill is referred to as the “actual case.” Also, information about the occupants was available such as the gender, age, room number, and activity engaged in before evacuation began. The staff was not included in the egress movement during the simulation, but was modeled to perform actions during the alarming sequence. Also, delay and response times associated with certain occupant actions were included in the simulation. The occupant total was 104, and since the available egress routes were many, the evacuation was not influenced by crowding. As mentioned earlier, runs were performed in ASERI to simulate 1) immediate evacuation of all occupants at the start of the fire alarm, 2) the scheduled case, and 3) the actual case. According to the developers, the actual case was very much in agreement with the observation of the monitored hotel drill. The only difference noted was that “the number of occupants not leaving the guest rooms or returning into the room was much larger than predicted by the simulation.” The developers relate this discrepancy to the fact that the information available was ambiguous in the drill, resulting in guests ignoring the alarm.

Additional validation studies can be found in the referenced ASERI publications.

**Special features:**

*Manual exit block/obstacles* – Yes, if smoke is very heavy.

*Fire conditions affect behavior?* Yes, the output of KOBRA-3D can be transferred to ASERI through a cut and paste method.

*Defining groups* – Yes, because of the ability to assign each individual certain mobility parameters (body size, walking speed, and behavioral conditions) as well as providing a distribution of these for a specified group.

*Disabilities/slow occupant groups* – Yes, walking speed and increased body size can be specified.

*Delays/pre-movement time* – Delays are achieved either by assigning alarm and reaction times or introducing intermediate stop positions.

*Toxicity of the occupants* – Yes.

*Route choice of the occupants/occupant distribution* – Route choice is either shortest distance or user-defined. Routes then become altered due to the building environment and the occupants' behavior during the evacuation (conditional).

**Limitations:** The number of specified levels (floors), units, passages, and obstacles is limited by computer memory.

## A.11 buildingEXODUS

Developer: E. Galea and FSEG Group, University of Greenwich, UK

**Purpose of the model:** The purpose of this model is to simulate the evacuation of a large number of people from a variety of enclosures<sup>11, 54-58</sup>. The modeling suite consists of airEXODUS, buildingEXODUS, maritimeEXODUS, railEXODUS, and vrEXODUS (Virtual reality graphics program). buildingEXODUS attempts to consider “people-people, people-fire, and people-structure interactions.” The model consists of six submodels, as shown in Figure A.18, that interact with one another to pass information about the evacuation simulation, and these are Occupant, Movement, Behavior, Toxicity, Hazard and Geometry submodels.

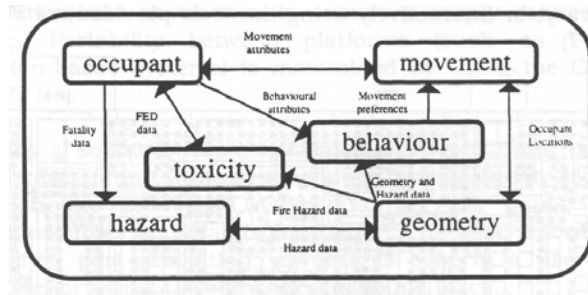

Figure A.18: EXODUS submodel interaction<sup>59, p. 46</sup>

**Availability to the public for use:** As of August 2002, buildingEXODUS version 3.01 is available for use through the University of Greenwich (FSEG).

**Modeling method:** This is a behavioral model.

**Structure of model:** This is a fine network system. The model uses a 2-D spatial grid to map out the geometry of the structure, locate exits, obstacles, etc. The grid is made up of “nodes” and “arcs.” Each node represents a small amount of space on the floor plan and the arcs connect the nodes together on the floor. Individuals use the arcs to travel from node to node throughout the building. This information is stored in the geometry submodel. Also, throughout the simulation, each node has dynamic environmental conditions associated with it, including levels of toxic gases, smoke concentration, and temperature.

**Perspective of model and occupant:** The model views the occupants as individuals by giving each occupant certain characteristics. The occupant submodel’s purpose is to describe the individual and contains such information as gender, age, maximum running speed, maximum walking speed, response time, agility, patience, drive, etc. The occupant submodel also maintains such information as the distance traveled by the occupant throughout the simulation, the person’s locations, and exposure to toxic gases. Some of these attributes are static, and some of these change with the conditions in the building.

The occupants’ view of the building is primarily individual, but includes a global level as well. An occupant’s escape strategy or route, determined by the behavioral submodel, is a product of his/her interactions with the building, other occupants, and the fire hazard in the situation. The behavioral submodel focuses on two distinct levels – a local and global, as noted by the

developers of the model. The local level (selection of a detour route) determines the occupant's response to the current or local situation and the global (which is specified by the user but can be overridden by the local level) level keeps track of the overall strategy of the occupant (such as to use the most familiar exit to leave the building). After the behavioral model has made a decision, it passes this information onto the movement submodel to move the occupant.

**Occupant behavior:** Rule-based or conditional behavior.

**Occupant movement:** The movement submodel controls the physical movement of the occupant from the current position to the next. Or, if a delay time was initiated by the user, the model holds the occupant in position. The movement model can also incorporate overtaking, side stepping, and other actions. The movement submodel determines the speed at which the occupant will move, and checks with the occupant submodel to make sure the occupant has the capability of performing specific maneuvers during evacuation (i.e., jumping over obstacles). The user can set one of six levels of walking speed for each individual occupant, randomly generated for the population, or group-defined. Those six levels are:

- Fast walk – default speed of 1.5 m/s
- Walk – 90 % of fast walk
- Leap – 80 % of fast walk
- Crawl – 20 % of fast walk
- Stairs-up (based on Fruin data<sup>60</sup> and dependent upon age and gender)
- Stairs-down (based on Fruin data and dependent upon age and gender)

The occupant “slows” due to other occupants occupying the grid cells in front of him/her. When moving to a grid cell that another occupant also wishes to occupy, the conflict resolution input assigns a certain delay time to each occupant in “conflict.” Also, the drive variable also affects which occupant will actually occupy the grid cell. If one of the occupants is assigned a higher drive value than the other, that occupant will obtain the next grid cell. However, if both occupants are assigned the same drive value, the decision is random. In short, the evacuation time of movement from grid cell to grid cell is made up of actual movement at unimpeded speed plus any conflict delays that occur along the way.

At the global level of the occupants' view of the building, the evacuation strategy is defined by the user. The default route is determined by the potential map (marking 0 as the exit and all other nodes as higher number the further away the node is from the exit), which leads people to the nearest available exit. If an exit is labeled as familiar or more attractive, this default potential map and route changes. The occupants always move onto a node with a lower potential than the one they are presently occupying. If an exit is more attractive, the potential for that exit is lowered. As mentioned earlier, the global level information is followed until an event occurs on the local level. At the local level, two behavioral options are available to the user, normal and extreme behavior. In normal behavior, the occupants' movements are determined by the potential map, and they strive to lower their potential. If the option to lower potential is not there, the occupant will move onto a node with equivalent potential. If this option is not available, the occupant will wait. In extreme conditions, occupants may act in a more extreme manner by taking a more indirect route. In this case, the occupants do not mind accepting a

higher potential for a short time during the alternative route. These actions also tie in with the patience option in the occupant submodel.

On the stairwells, the occupants view all nodes on the stairs as equally attractive, but if an occupant is within 5 nodes of the edge of the staircase, he/she will move to the edge as an attempt to use the handrails. Occupant travel speeds on stairs are based on work done by Fruin. Exiting is based on two factors, the exit width and flow rate per unit width. These values determine the maximum amount of occupants allowed to exit at the same time and the number of nodes assigned to the exit. The user specifies an upper and lower limit of flow rate at each exit.

The user can manipulate aspects of the occupant submodel, for instance, the mobility and agility attributes can be modified so that disabled or slow moving occupants can be simulated.

The toxicity submodel determines the effects of the toxic products on the occupants in the building. The effects on the occupants are given to the behavioral submodel which transfers the information to the movement submodel. To determine the effects of the fire hazard, including the newly added radiative effects, on the occupant, EXODUS uses the Fractional Effective Dose (FED) model developed by David Purser, BRE<sup>61</sup>. The FED model considers the effects of radiation, temperature, HCN, CO, CO<sub>2</sub>, and low O<sub>2</sub> to estimate the time to incapacitation. Also, other effects to occupants are staggered and slowed movement, based on data from Jin<sup>52</sup>. Occupants may choose to travel a different route when faced with a barrier of smoke, depending upon their individual characteristics<sup>53</sup>.

**Output:** In order to interpret the results, data analysis tools have been developed to use once the simulation have been completed. These tools allow for the output files to be searched and for specific data to be extracted. The program is labeled as “askEXODUS.”

**Use of fire data:** Yes, the hazard submodel determines the thermal and toxic environment. buildingEXODUS can accept data from other fire models or experimental data. A software link is established between buildingEXODUS and the CFAST model.

**Import CAD drawings:** Yes, CAD drawings can be imported into the model. In addition, the user can also input the geometry of the building via the geometry library or by interactively using the tools provided in buildingEXODUS. This information is stored in the Geometry submodel.

**Visualization capabilities:** 2-D (low detail and person shape) and 3-D capabilities (Virtual reality interface).

**Validation studies:** According to developer, the model has undergone several forms of qualitative and quantitative validation. The model developer claims that this includes direction comparison of model predictions with past experimental data, comparison of “blind” model predictions with experimental data, and comparing the nature of human behavior with expectations of the model. Although many of the validation studies are performed on airEXODUS using experimental trials from the aviation industry, the developers claim that both airEXODUS and buildingEXODUS are based on the same principles.



For validation of the airEXODUS model, the model results were compared against Cranfield Trident Three experiments (an example of past experiments). Here, people evacuated from Trident Three aircraft cabin sections and the model correctly predicted the trends in evacuation times, according to Gwynne et al. AirEXODUS results are also compared against certification trials of aircrafts, specifically the B767-304ER. These trials are performed only once and after running several runs of the model, it was shown that the performance of the certification trial was near optimal by the passengers and crew. Therefore, the optimal EXODUS predictions were compared to the trial and were within 2 % of the measured trial evacuation time.

Validations studies of buildingEXODUS<sup>42, 62</sup> using the following buildings are available: seven pavilions of the Tukuba International Expo in 1985, the Stapelfeldt experiments (evacuation of police cadets from a school gymnasium), and the Milburn House, Newcastle-Upon-Tyne, UK. Reasonable agreement was found, when looking past deficiencies in the data. The developer notes “excellent agreement between buildingEXODUS predictions and observed evacuation times.”

**Special features:**

*Counterflow* – Yes, occupants can be assigned a specific itinerary that involves traveling against the flow to a certain point in the building.

*Manual exit block/obstacles* – Yes.

*Fire conditions affect behavior?* Yes, from the Hazard submodel and CFAST.

*Defining groups* – Yes.

*Disabilities/slow occupant groups* – Yes.

*Delays/pre-movement time* – Yes, these are either provided as a user-defined distribution for different groups in the structure or by assigning specific itineraries to certain occupants.

*Toxicity of the occupants* – Yes.

*Impatience/drive variables* – Yes.

*Route choice of the occupants/occupant distribution* – Globally, the potential leads to shortest route and can be overridden by local information and events. Route choice is conditional.

**Limitations:** If users decide to purchase the level 1 option, the website notes that “Level 1 can handle multiple floors and unlimited population sizes, includes the movie player facility and the data analysis tool askEXODUS. Limitations are dictated by the capabilities of the host computer. This version does not include a toxicity sub-model and possesses a limited capability hazard sub-model.” The Level 2 option involves “As level 1 but includes a toxicity model that allows the inclusion of the fire hazards of smoke, heat and toxic gases within the simulation. An ability to import history files from CFAST V4.01 in order to define the fire atmosphere. This

level includes the movie player, data analysis tool askEXODUS and an ability to produce output capable of being read by the post-processor virtual reality software vrEXODUS. Level 2 encompasses the full capability of buildingEXODUS.”

## A.12 EXITT

Developer: B.M. Levin, NBS, U.S.

**Purpose of the model:** The purpose of this model is to simulate occupant decisions and actions in fire emergencies in small residential buildings<sup>63,64</sup>. The decision rules used by the model were designed to resemble decisions made by occupants during a fire emergency. These decision rules are based on:

- Judgment by the author
- Case studies of residential fires
- A limited number of controlled experiments

**Availability to the public for use:** This model is available for public use through the NFPA.

**Modeling method:** This is a behavioral model.

**Structure of model:** This is a coarse network system. The building is made up of nodes used to represent rooms, exits, and secondary locations within a room, and the arcs are the distances between the nodes.

**Perspective of model and occupant:** The model views occupants as individuals by assigning each individual characteristics as well as tracking their movements throughout the simulation. The occupant characteristics input into EXITT are age, sex, normal travel speed, whether or not the occupant needs assistance during the evacuation, whether or not the person is asleep, room location, and difficulty of waking up, if the person is sleeping.

The occupants also have an individual view of the building, due to their choice in exit path. The occupants' moves throughout the building are based on a shortest path algorithm included in EXITT. During each action of the occupant, the route taken to the destination is via the shortest path. This algorithm assigns penalties to certain paths due to heavy smoke or having to leave via windows. In certain circumstances, the occupant is left to choose the exit with the lowest number of penalties or demerits. Demerits work in the following way: each meter traveled is assigned 1 demerit, leaving through a window is assigned 100 demerits, and traveling through "bad" smoke is given 200 demerits. In some situations, all routes can become blocked, which will leave occupants trapped in the residence.

**Occupant behavior:** Rule-based or conditional behavior. One way that occupants make decisions is based on the optical density of the smoke in the upper layer using the equation for psychological impact of smoke,  $S$  (equivalent to the equation used in EXIT89).  $S = 2 * OD * (D/H)$  where  $OD$  is the optical density of the upper layer,  $D$  is the depth of the upper layer, and  $H$  is the height of the room. The following decision rules are incorporated into the model:

- Occupants do not move to a node where  $S > 0.5$  (or into a room where  $S > 0.4$ ) unless the  $(H-D)$  is at least 1.2 meters (the occupant can crawl)
- Occupants increase their travel speed by 30 % after they encounter smoke of  $S > 0.1$

- Occupants stop investigating if they are in a room where  $S > 0.05$ . They will stop investigating before entering a room where  $S > 0.1$
- If the occupant is in a room where  $S > 0.1$ , he/she will respond more quickly and believe the fire is more serious.
- Penalties and demerits are assigned to a route where  $S > 0.4$

The occupants are assigned certain characteristics for a simulation and those are age, sex, normal walking speed, whether or not the occupants have special needs, whether or not the person is sleeping, room location, and difficulty of waking up.

There are two types of occupants within the model, those fully capable when awake and those who are in need of assistance to evacuate the building. Decision rules apply only to the first group, and the latter group only follows those decisions and movements made by their rescuers.

Capable occupants become aware of the fire through cues, such as the sound of a smoke detector, odor of smoke, visible smoke, and visible flame. The model follows a basic equation for if and when an occupant will begin responding to a cue, and suggests the work of Nober<sup>65</sup> is the formulation of this equation. Equation A.4 is the cue equation, which assumes that the occupant's response is a function of the sum of impacts from sensory cues:

$$T = 70 - 4(C - 20) \text{ and } C = (A - N) + X_1 + X_2 + X_3 + X_4 \quad (\text{A.4})$$

where  $T$  is the delay time before beginning the first action,  $C$  is the sum of sensory impacts on the occupant,  $A$  is the sound intensity of the smoke detector as heard by the occupant,  $N$  is the background noise,  $X_1$  is the impact of an occupant seeing flame,  $X_2$  is the impact of the occupant smelling smoke,  $X_3$  is the impact of an occupant seeing smoke, and  $X_4 = 0$  if occupant is sleeping and 15 if the occupant is awake.  $X_1$  and  $X_3 = 0$  if the occupant is asleep.

EXITT normally assigns investigation as the first action of the occupant. Exceptions to this include if an occupant has completed investigation, if there is bad smoke in the room, if the occupant has been alerted by another who has seen bad smoke, or if the occupant is an adult female with an infant that needs help. The occupants have other alternative actions in the case that the exceptions apply (in this specific order) which are help an occupant in the same room, help an occupant in a different room, investigate, and egress. Occupants over age 10 act in the same way as an adult would.

Any delay time, decision time, and time to perform actions depend on the occupant characteristics, fire environment, and the impact of the fire cues onto the occupants.

An addition to the model includes the option for users to override the decision rules and study the effect of alternative decisions.

**Occupant movement:** As mentioned earlier, a normal walking speed is assigned to each occupant by the user, and throughout the simulation, speeds are altered in the following way:

- 30 % faster than normal if the occupant considers the fire to be serious

- 50 % of normal speed if the occupant assists another, and 30 % faster than this adjusted value if the occupant considers the situation to be serious.
- 60 % of normal speed of the smoke is bad ( $S > 0.4$ ) and the ( $H-D$ ) (depth of lower layer) is less than 1.5 m

**Output:** The output includes the number of occupants out of the building, those trapped, and the total evacuation time. The actions of individual occupants at all time periods throughout the simulation are also included in the output.

**Use of fire data:** EXITT is designed to import output from FAST to simulate smoke throughout the building. This assumes a 2-layer smoke distribution. EXITT also accepts input of smoke density in the upper layer and the height of the two layers in each room at each time period.

**Import CAD drawings:** No, CAD drawings of the building cannot be imported into EXITT. The building is described by providing the number of rooms, nodes, and exits, the height of each room, the room location of each node, whether the exit was a door, window, etc., and the distances between the nodes. If a window cannot be used for evacuation, it is not included into the model.

**Visualization capabilities:** The movement of the occupants can be displayed graphically on the computer screen.

**Validation studies:** None noted.

**Special features:**

*Manual exit block/obstacles* – Yes, if smoke is very heavy (which can be input by the user)

*Fire conditions affect behavior?* Yes, these can be imported from FAST or user-defined (OD and smoke layer heights) per time period.

*Defining groups* – Yes, capable and needs assistance.

*Disabilities/slow occupant groups* – Yes.

*Delays/pre-movement time* – Delays are associated with the activities during a preparation and response time.

*Route choice of the occupants/occupant distribution* – Route choice is dependent on a list of information, many of it conditional to the environment, during the evacuation as well as the familiarity with the building.

**Limitations:** This model is used only for residential buildings. Occupants respond to smoke conditions only, not toxicity or heat. Also, many of decision rules are based on author judgment.

## A.13 Legion

Developer: Legion International, Ltd., UK

**Purpose of the model:** The purpose of this model is to aid in space planning and optimization through the prediction of crowd behavior as an interaction between individuals<sup>66-68</sup>. The model can be used for a wide variety of applications (i.e. railway and metro stations, airports, and tall buildings) and needs (i.e. design, refurbishment, and operation and safety assessment).

**Availability to the public for use:** This model has been commercially available through Legion International Ltd. since May 2003.

**Modeling method:** This is a behavioral model.

**Structure of model:** The Legion model works in a vector 2D continuous space, instead of superimposing a coarse or fine grid network onto the floor plan. In addition, by providing a continuous approach to the structure configuration, the model can simulate counterflow, overtaking, people and obstacle avoidance, and negotiation through crowds. The model refers to its structure as an “unbounded choice” method. This method explores the possible moves available to the occupant in vector space which is updated constantly, instead of being constrained by a set of rules.

**Perspective of model and occupant:** The model views the occupants as individuals. Each individual in the model is considered to be a virtual person and is simulated accordingly with distinct physical and psychological characteristics and objectives.

The occupant’s view of the building is also an individual perspective. This virtual person moves in a realistic manner. Occupants determine their path based on their perception and information stored in the space.

**Occupant behavior:** Artificial Intelligence. Legion views the occupants as intelligent individuals and social, physical, and behavioral characteristics are assigned probabilistically from empirically established profiles. The social characteristics include gender, age, culture, and pedestrian type (i.e. commuter versus tourists) which Legion states shape typical movement preferences. The physical characteristics addressed are body size. And, the behavioral characteristics include memory, willingness to adapt, and preferences for unimpeded walking speeds, personal space, and acceleration. These characteristics make up a profile for each person and are based on distributions derived from video footage of actual pedestrians.

Also, Legion allows for conditional and probabilistic behavior to be superimposed on the base model.

**Occupant movement:** Occupant movement within the model is in agreement with extensive empirical research performed on the study of crowd movement and behavior. Research teams have acquired and analyzed video footage of individual and crowd behavior. Movement is based upon the “least-effort principle,” which means that each individual attempts to minimize dissatisfaction (defined as the aggregate of frustration, inconvenience, and discomfort). These

factors relate to delays, deviations and lack of comfort that individuals seek to avoid when deciding about their next step.

The decisions about each step are made according to an individual's preferences, location, objectives, and recent experience. These are also sensitive to local conditions (crowding or lack thereof), context (stairs, escalators), and projected intentions of neighbors.

Legion<sup>66</sup> claims to have overturned key assumptions on behavior and movement in crowds. They state that "people's circulation through a space is determined not only by their density but also by the specific features of the local geometry"<sup>66</sup>. Movement is affected not only by input variables chosen for each individual person, but also by factors such as knowledge of the environment and the person's state of readiness. These correspond to occupants' interaction with signage and information points throughout the building.

**Output:** Bitmap and video files and the ability to choose the data output that is of interest; graphs or detailed metrics for individual and crowd experiences. Examples of the output are the following:

- Usage maps
  - Space utilization - the extent to which different areas have been visited
  - Density and speed maps
  - Evacuation maps – how quickly areas empty
  - Inconvenience, Frustration, and Discomfort
- Graphs
  - Densities, counts, flows, time spent inside, journey time, queuing time, waiting time, speed, etc. can all be plotted as graphs, exported as pictures and/or spreadsheets and/or raw data
- Animations

**Use of fire data:** This capability is under development. Currently, the model allows for output from fire modeling software to be indirectly incorporated into the model, which converts certain areas of the building into "undesirable zones" and/or zones through which movement is difficult.

**Import CAD drawings:** CAD drawings are imported into the model. The following formats are supported by the model: .DXF, .DWG, and .DGN. Also, the user can easily change spatial configurations in the building by using the Legion software. The user also inputs the following onto the CAD drawing in Legion; entrances, exits and route options, facilities (gates, waiting areas), scheduled events (train announcements, service times), and the arrival profile of the people and their desired destinations.

**Visualization capabilities:** 2-D capabilities are part of the standard suite. Also, 3-D visualization is available through a separate module.

**Validation studies:** The following validation studies have been performed on the Legion model:

- Papers in preparation on quantitative validation based on proprietary measurements

- Qualitative reproduction of emergent crowd behavior and movement
- Comparison by a third-party against another evacuation model

**Special features:**

*Counterflow* – Yes, people can move against the flow of others.

*Manual exit block/obstacles* – Yes.

*Defining groups* – Yes.

*Disabilities/slow occupant groups* – Yes.

*Delays/pre-movement time* – Delays can be specified for certain occupants.

*Elevator use* – Yes.

*Impatience/drive variables* – Yes, the model simulates the attempt of occupants to decrease their levels of Inconvenience, Frustration, and Discomfort throughout the evacuation.

*Route choice of the occupants/occupant distribution* – Route choice is based on user input variables for each occupant such as signage and other path assumptions. Routes are used by specifying an origin-destination matrix which simulates the variations in demands over a period of time. The following routing schemes are available:

- By population type
- By percentage
- Spatial segmentation
- By most available
- By nearest available
- Priority schemes

**Limitations:** Not a significant amount of documentation available on the model.



## Models Available via Consultancy

### A.14 PathFinder

Developer: RJA Group, U.S.

**Purpose of the model:** The purpose of developing this model is to provide an analytical egress simulation tool that could be coupled with an external fire model to form a portion of hazard analysis<sup>69-71</sup>. The model is used to find bottlenecks and queues in a design. There is no specific building type specialty.

**Availability to the public for use:** The model is a proprietary software program developed and used by the RJA Group.

**Modeling method:** Movement model

**Structure of model:** This is a fine network system. The model provides a simulation of the evacuation to visually present the location of the occupants as a function of time.

**Perspective of model and occupant:** The model views the occupants as individuals. The model has the capability of tracking individuals' movements and positions throughout the simulation. The model views the population through a global view only to assess the density of certain areas of the building. The occupants, on the other hand, have a global view of the building because of their route choices. They can choose the shortest route to the exit or the shortest cue route.

**Occupant behavior:** No behavior.

**Occupant movement:** The occupants move toward the exits under the constraints of the SFPE Handbook<sup>8</sup>, which incorporates speed reductions based on the density of the space and the capacity of the doors and stairways. The primary areas of analysis focus on movement in open spaces, on stairways, and through doorways. The user specifies initial occupant loading by specifying the density in certain areas (by noting the occupancy of the room) or by giving discrete number of occupants.

**Output:** Examples of the output are the number of people that have used an exit; minimum, maximum, and average time for people to exit from a given room (monitoring the first and last person to leave); the times a room, hall, or stair becomes empty; the time a floor becomes empty; and total evacuation time.

**Use of fire data:** None.

**Import CAD drawings:** Yes, CAD drawings can be imported into the model or the user can use PathFinder to layout a floor plan.

**Visualization capabilities:** 2-D visualization

**Validation studies:** No publications on validation studies were found.

**Special features:**

*Route choice of the occupants/occupant distribution* – 2 choices: shortest distance or shortest cue

**Limitations:** None specified as to limitations on model capacity.

## **A.15 EESCAPE (Emergency Escape)**

Developer: E. Kendik, Cobau Ltd. Argentinierstr. Austria

**Purpose of the model:** The purpose of this model is to address the time sequence from the time at which people begin evacuation from the floors until they reach the outside or approved area of refuge in the building<sup>11, 72</sup>. The program allows the user to change the dimensions of the building's means of egress and the occupant load to assess the influence of the egress system variations.

**Availability to the public for use:** The model is operated by the developer for the outside user.

**Modeling method:** This is a movement model.

**Structure of model:** This is a coarse network system. The model seems to acknowledge only a corridor, stair, and exit arrangement.

**Perspective of model:** The model views the occupants globally as a single group of occupants per floor moving as a homogeneous mass to the exit. The occupants also view the building with a global perspective because there is only one exit to travel to.

**Occupant behavior:** No behavior is modeled.

**Occupant movement:** As mentioned earlier, the model considers the population to be a single group of a certain mean density on each section of the escape route. The calculated density on each component of the escape route is used to calculate the speed of the occupant through the escape route (Kendik references the work of Pauls and Predtechenskii and Milinskii). The partial flows from the floor, which are equivalent in number on each story of the building, evacuate and enter the staircase at the same time. If the partial flows from each floor interact with each other in the staircase, the model then uses calculation methods for occupant flow under (stair width is still adequate to handle merging flow) and above (congestion occurs) maximum flow on stairs. The user inputs the number of persons using the escape route.

**Output:** The output from this model is the total evacuation time.

**Use of fire data:** None.

**Import CAD drawings:** No. The user supplies the escape route configuration to the model, which is assumed to be identical on each floor of the building. Also, the number of floors is specified by the user. The user enters the length and width of the corridor leading to the stairs and door width, the length and width of the stairway, and the greatest travel distance along the corridor.

**Visualization capabilities:** None.

**Validation studies:** The model is calibrated against data from evacuation tests carried out at the University of Karlsruhe. No further information is supplied.

**Special features:**

*Route choice of the occupants/occupant distribution* – Only one choice is given to the occupants.

**Limitations:** Seems to be a simple 1-route configuration.

## A.16 Myriad

Developer: G.K. Still, Crowd Dynamics, Ltd, UK

**Purpose of the model:** The purpose of this model is to assess the spatial dynamics required for a successful evacuation<sup>73, 74</sup>. Myriad is also used to ensure compliance to codes and insurance assessment. This is a macroscopic model, and because of this, Still states that the output does not depend on assumptions about the population incorporated in the model. This collection of techniques supersedes the VEGAS and Legion systems.

**Availability to the public for use:** This model is used by Crowd Dynamics for the client.

**Ideas and Applications:** Myriad<sup>73</sup> is said to predict where congestion will occur in the building and its severity (via Level of Service<sup>60</sup> degrees), flow rates, queues, travel distances, and times in order to “optimize” design. The developer<sup>74</sup> identified three basic steps used in the analysis process using Myriad. First, Myriad measures the distance, width, ease of use, and directional changes from *all* points within the building space to the exits. This is the analysis that ensures compliance to the codes. Colors throughout the building’s egress routes are used to show evacuation aspects of the building, for instance, travel distance of various distances. The building can be assessed with and without furniture, which can ultimately affect travel distances from certain areas of the space. The occupant can enter the number of occupants within the building/space and Myriad will produce simulations, each beginning occupants at different places, in order to test building travel distances.

Second, Myriad identifies the various flow paths, interaction paths, and congestion areas. These are ultimately factored into the “delays” in the egress process. The interactions and congestion paths within the model are also identified by certain colors throughout the building in this analysis. Tables A.8 – A.11 below show the corresponding colors for each Level of Service (taken from Fruin’s data<sup>60</sup>) for each building components (walkways, stairs, queues, and platforms). The visualization software allows the client to view the density of the spaces in the building throughout the simulation. As another example of the capabilities of Myriad, through the use of hesitation maps, Myriad can highlight areas where occupants may hesitate, change routes, or require more information to direct them to a destination.

Table A.8: Fruin data and corresponding colors for density on walkways used by the Myriad model ([www.crowddynamics.com](http://www.crowddynamics.com))







Area (m <sup>2</sup> )			Flow rate	
LoS A	> 3.24	<	23 pmm	
LoS B	3.24 to 2.32		33 pmm	
LoS C	2.32 to 1.39		49 pmm	
LoS D	1.39 to 0.93		66 pmm	
LoS E	0.93 to 0.46		82 pmm	
LoS E	< 0.46	<	82 pmm	

Table A.9: Fruin data and corresponding colors for density on stairs ([www.crowddynamics.com](http://www.crowddynamics.com))







Area (m <sup>2</sup> )			Flow rate	
LoS A	> 1.85	<	17 pmm	
LoS B	1.85 to 1.39		23 pmm	
LoS C	1.39 to 0.93		33 pmm	
LoS D	0.93 to 0.65		43 pmm	
LoS E	0.65 to 0.37		56 pmm	
LoS E	< 0.37	<	56 pmm	

Table A.10: Fruin data and corresponding colors for density in queues ([www.crowddynamics.com](http://www.crowddynamics.com))





Area (m <sup>2</sup> )					
LoS A		>	1.21	Free circulation	
LoS B	1.21	to	0.93	Restricted circulation	
LoS C	0.93	to	0.65	Comfort zone	
LoS D	0.65	to	0.28	No-touch zone	
LoS E	0.28	to	0.19	The Body ellipse	

Table A.11: Fruin data and corresponding colors for density on platforms  
(www.crowddynamics.com)

Danger Level	3.59 people/m <sup>2</sup>	Red
Jam Capacity	2.15 people/m <sup>2</sup>	Orange
Desirable Max	1.08 people/m <sup>2</sup>	Green

Lastly, Myriad can be used in conjunction with Simulex to test egress rates. This is shown in figures A.19 and A.20 and allows the user to visualize movement throughout the building.

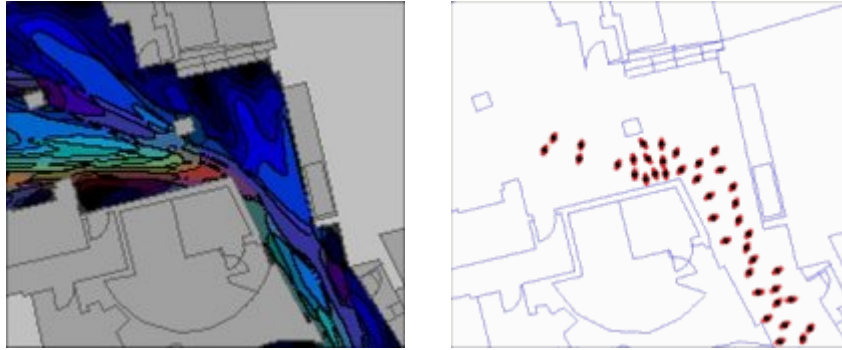

Figures A.19 and A.20: Myriad and Simulex visualization output for the same building (courtesy of www.crowddynamics.com)

In certain situations, Myriad can be used to identify the most used spaces as well as identify potential wasted spaces. This model can be applied to the design and management of different occupancies, such as car parks, road networks, people and traffic, offices, sports stadia, malls, rail stations, and other complex spaces. The key elements of Myriad as identified by Still are the following<sup>74</sup>:

- The speed that operators can produce results
- Ability to test different scenarios
- Ability to evaluate compliance with relevant building codes for both normal and emergency use.

**Output:** Myriad assesses escape routes, times, number of interactions (delays), and determines the exit capacity based on the existing building geometry.

**Import CAD drawings:** Yes, CAD drawings are used significantly with this model in producing the network, spatial and egress route analyses. Once the CAD drawing is imported into the model, the user must identify the scale of the building (this is done by clicking on two points and entering in the distance for that line).

**Visualization capabilities:** Yes, this is shown in Figures A.19 and A.20. Myriad is a set of tools able to show overall congestion/density points as well as individual persons moving through the building (with the use of tools such as Simulex and STEPs).

**Validation studies:** Validation was performed on the model through the development of Still's PhD Thesis. Also much work has been performed in third party modeling with the use of EXODUS, Simulex, etc.



## A.17 ALLSAFE

InterConsult Group ASA, Norway

**Purpose of the model:** The purpose of this model is to determine whether or not occupants are at risk depending upon input data for the building, the building use, the occupants, and the design fire scenario<sup>11, 75-77</sup>

**Availability to the public for use:** This model is available through in-house consultancy from InterConsult.

**Modeling method:** This is considered as a partial behavioral model.

**Structure of model:** This is a coarse network system. The building is input into the model through a series of nodes. For each node, the user specifies the minimum clearance width, walking distance to the next node, initial number of occupants at node, and the area of the node. The model simulates only one exit per node structure, but can simulate multiple node structures in parallel. Because of this, the occupants in each node structure head to only one exit.

**Perspective of model and occupant:** The model seems to view the occupants globally because of the statement saying that ALLSAFE assigns the behavioral characteristics to groups of occupants or the worst-case scenario group. Also, the times presented in the output are assigned to the entire population, instead of each individual.

The occupants' perspective of the floor plan and building is also global since they only have one exit to choose from.

**Occupant behavior:** Implicit. ALLSAFE assigns behavioural characteristics to groups of the population considered to be the worst-case of the evacuation scenario. The model includes such input data as background noise, social and economic barriers among the occupants, language, the fire protection system measures, and the fire scenarios. These input data affect the evacuation time by adding or subtracting times (as obtained from the database within the model). The model also incorporates time delays and time improvements due to voice alarm systems, sprinklers, compartmentation, etc. The model calculates these from tables of data. An example of suggested time effects from different variables is included in Table A.12. These effects were gathered from literatures and/or by using Delphi-panels.

Table A.12: Building/Occupant characteristics and the corresponding time effects<sup>77, p. 676</sup>

Building/Occupant Characteristics	$\Delta T_{det}^*$ (min)	$\Delta T_{rec}$ (min)	$\Delta T_{res}$ (min)	$\Delta T_{move}$ (min)
Only one available exit			2.5	
Bad layout/geometry of occupancy area				5
Bad layout/geometry of escape routes				2
Unfamiliarity to building			5	5
Not alert (sleeping and/or drunk)	5	5		
Social affiliation (family)			2	
Social role (customer, visitors, worker, etc.)		5		
Unclear visual access of exits from occupancy area			1	

\*Where “det” refers to detection, “rec” refers to recognition, and “res” refers to response.

**Occupant movement:** ALLSAFE was developed to calculate evacuation scenarios where the occupants are not aware of the fire until later in the situation. The main calculation is estimating delay time of the occupants prior to evacuation. The model also includes a function to estimate the walking time of the occupants. ALLSAFE defines the “minimum time of movement” or “unimpeded time” (no behavioral delays) and this time is determined by flow calculations. The developer admits that these calculations are simplified and also recommends the use of more advanced flow models to determine the minimum movement time whenever movement is critical. After determining the minimum movement time, an ALLSAFE database is used to add delays and subtract reduction in evacuation times due to different kinds of safety measures, such as alarm systems, staff guidance, unfamiliarity, immobility, social affiliation, signage, etc. The final result obtained from the model is the “necessary time to evacuate.”

The model developers state that the input data affects all aspects of the evacuation process, based on the study of recognized literature on the interaction of behaviour of evacuation and the fire in actual fire incidents. The developers also state that assigned delay or pre-movement times are based on real life evacuation experience. From the write-up on ALLSAFE, it seems that the functions of the model based on actual incidents were determined through studies made by SINTEF on large fire incidents. No further information is given as to the kinds of incidents studied or the evacuation knowledge gained from these studies.

**Output:** The data obtained from the output is the following (for the entire population):

- Time to fire detection
- Time to react to the fire detection by the occupants
- Time to interpret the situation by the occupants
- Time to decide where to escape by the occupants
- Time to evacuate a room or corridor
- Time to evacuate the building

**Use of fire data:** The fire scenario can be calculated by fire models, such as FAST (listed by the ALLSAFE write-up) or default values for the scenario can be chosen from ALLSAFE.

**Import CAD drawings:** No, this building is input by specifying nodes within the node structure with the following information: minimum clearance width, walking distance to next node, initial number of occupants in node, and the area of the node.

**Visualization capabilities:** Visualization of the evacuation can be accomplished by using AllsafePC. However, since the model considers the population as global, the developer referred to other advanced flow models in order to visualize evacuation.

**Validation studies:** Attempts have been made to compare ALLSAFE with other models, such as Simulex. The model developers consider the model to be better validated by the use of expert judgments which are used in tabulated values (based on accepted literature on behavior and evacuation times).

**Special features:**

*Fire conditions affect behavior?* Fire scenarios are input into the evacuation from either a fire model or from default values in ALLSAFE.

*Defining groups* – Yes, the model only recognizes groups.

*Disabilities/slow occupant groups* – This does not seem like an option.

*Delays/pre-movement time* – Yes, delays such as time to fire detection, time to react to the detection, time to interpret the situation, and time to decide where to escape are modeled.

*Route choice of the occupants/occupant distribution* – Only one route is available to the occupants for each node structure.

**Limitations:** Only one exit per node structure.

## A.18 CRISP3

Developer: J. Fraser-Mitchell, BRE, UK

*The stand-alone evacuation model is the focus of this write-up.*

**Purpose of the model:** The purpose of this model is to simulate entire fire scenarios incorporating a Monte Carlo technique<sup>11, 78-81</sup>. There is also an option to simulate an evacuation using the external or “stand-alone” evacuation model, which does not incorporate the zone fire model effects or the toxicity effects to the occupants. In this mode, the model will run in fire drill mode, but the Monte Carlo technique can still be used.

**Availability to the public for use:** CRISP is used only by BRE for in-house consultancy.

**Modeling method:** This is a behavioral model.

**Structure of model:** This is a fine network system. The model uses a 0.5 m by 0.5 m grid over the entire floor plan that is used to move occupants around the building. This grid size can be larger, but the developers warn that the larger the grid size, the lower the accuracy of the evacuation results. The occupants follow a contour map that is spread throughout the floor plan.

**Perspective of model and occupant:** The model views the occupants as individuals by giving the occupants certain behavioral roles, and in turn, certain behavioral activities that will take place during the evacuation, in a probabilistic fashion. The user also specifies the occupant’s walking speed and height (distributions), as well as probabilities for being asleep and located in certain places throughout the building.

The occupants’ view of the building is also individual because although the model defaults to move the occupants to the nearest exit, the user can alter the shortest route by indicating a high “door difficulty” for a certain exit. Also, door difficulties change and increase with the presence of smoke.

**Occupant behavior:** Rule-based or conditional behavior. The population is assigned occupational and role data, on the basis of probabilities. The occupation data determines the location probabilities, sleeping probabilities, head height, and movement speed of each group. The role data dictates actions (behaviors of the group) and associated probabilities of each behavior. Behavior is performed in the model in the form of actions, which are each associated with a delay time, degree of difficulty, and urgency level. Actions do not have to continue until they are complete, but may be interrupted by conditions within the model. In this case, another action will take place. Some example actions to choose from in the model are search rooms, rescue, investigate, escape, complete work, trapped, unconscious, asleep, etc. An example of simulated behavior of a fire fighter is explained here.

“Depending upon the conditions – the fire fighters will start off ‘safe’ which will prompt them to investigate (which has a 100 % chance of occurring). This will lead them to go begin traveling to the room of origin. Under the investigation action, there are three different conditions that will prompt another action (and

order of the conditions matters). If there is a target to rescue (injured/disabled occupant), they will rescue them. The model will take the fire fighter to the disabled person and have them escape together. If the target has been assisted during the rescue, the fire fighter will continue investigation to the fire floor. (As you can see, these actions can go back and forth.) If the fire fighter has seen fire or has completed investigation to the fire floor (reaching the fire floor and remaining there for the delay time), then the fire fighter will escape”<sup>80</sup>.

**Occupant movement:** The movement of the occupants throughout the building is based on local crowd density. Only one occupant can occupy a grid cell at the same time, which is comprised of a 0.25 m<sup>2</sup> area (or a cell sized 0.5 m by 0.5 m). When the occupant approaches a crowded area, he/she makes the decision on which grid cell to move to based on the simple algorithm “collision avoidance” or local density. The process is shown in Figure A.21.

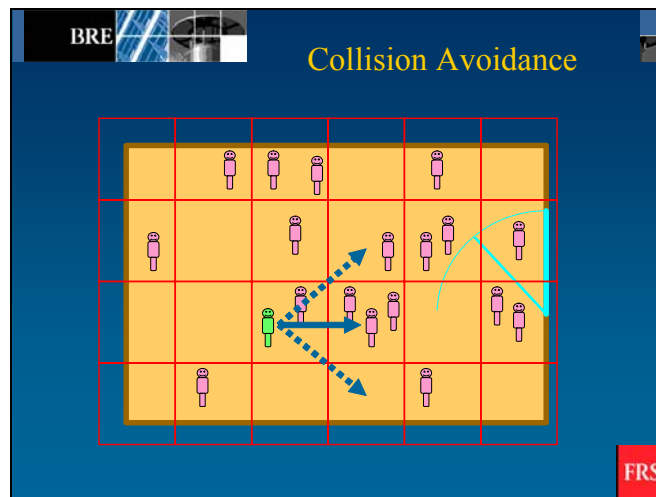

Figure A.21: Graphic of collision avoidance in CRISP<sup>80</sup>

This is a slide taken from a BRE presentation made by Fraser-Mitchell<sup>80</sup>. The solid blue line shows the preferred direction of the green occupant, but that cell already contains the maximum allowable number of people (3 people in a 0.75 m<sup>2</sup> space or 3 (0.5 m x 0.5 m spaces). Two other options are those at 45 degree angles to the green occupant’s position and are scored according to the speed of the occupant, which is a result of the density of his cell and the next potential cell. A score is calculated for each of the three possible cells. The preferred solid blue line has a score equal to the calculated speed of the occupant, and the dotted lines have a score equal to 0.7 \* speed of the occupant. An example calculation is performed for the scenario above giving an example maximum unimpeded speed of the green occupant as 1.0 m/s. For the cell following the solid blue line, the green occupant will have a speed 20 % (1-(4/5)) of the maximum speed because there are a total of 4 other occupants (5 including the green occupant) occupying the current and potential cells. If the green occupant had 2 other occupants in his cell, his speed toward the solid blue line would equal 0, because both current and potential cells would be at maximum density. As a result, the score for a move along the blue solid line would be calculated by: 1.0 m/s x 0.2 = 0.2. In order to move to the upper diagonal, the score would be 0.7 x (1.0 m/s x 0.6) = 0.42. In the upper diagonal case, there were 2 others in both the current and potential cell, other than the green man, causing the speed be 60 % (1 – (2/5)) of the

maximum value. Lastly, the lower diagonal score is  $0.7 \times (1.0 \text{ m/s} \times 0.8) = 0.56$ . In the lower diagonal case, there is only one other occupant in the current and potential cells, other than the green occupant, so the speed is decreased to 80 % of its maximum value. The highest score of 0.56 is given to the lower diagonal, so the bottom diagonal cell is chosen.

The choice of an occupant's route is influenced by both distance and the degree of difficulty specified for the doors and windows by the user. Occupants can, however, stray from the minimum distance path to avoid high crowded areas. Also, a specified behavior may lead the occupants to a specific part of the building before evacuation will begin.

**Output:** The output consists of *detailed* information about each person in the simulation at every time step. Also included is route information, fire conditions in certain rooms in the building, summary of every Monte Carlo run, evacuation time, and a pictorial output (at any time throughout the simulation).

**Use of fire data:** CRISP3 has its own zone-based fire model.

**Import CAD drawings:** Yes, CAD drawings can be imported into the model. The user must specify the heights of the floor plan and ceilings at different points on each floor plan. If CAD plans are not used, the user must create a build file which specifies the building geometry by inputting:

- x,y coordinates of the building layout, such as rooms, stairs, vents
- Height of ceiling and vents
- Connections between rooms and between stairs

The user also specifies the type and location of detection system (in the detection input file) and if the stand-alone evacuation model is used, the occupants are alerted at the start of the simulation if no delay time is added. Also, the x,y coordinates of any obstacles on each floor must be listed in a separate obstacle input file.

**Visualization capabilities:** 2-D and 3-D capabilities (Josephine)

**Validation studies:** CRISP's use has been frequently documented by BRE in such projects as office buildings, a large exhibition hall, and an airport terminal. These were done in order to conclude available safe egress time (ASET) versus required safe egress time (RSET) conditions, main factors in the evacuation (exit routes, width of doors, etc.), and worst scenarios, to name a few.

An evacuation of a 3-story office building<sup>79</sup>, housing 202 civil service staff, was performed in 1996, and subsequently modeled in CRISP to develop and improve the model for use in office buildings. Similar to validation efforts for the WAYOUT model, questionnaires were administered to the staff after the drill to obtain information on workplace, location at time of alarm, and any emergency roles and actions taken when responding to alarm. Respondents consisted of 22 designated emergency staff, one wheelchair user, and 118 staff with no emergency responsibility. In the actual evacuation of the building, all staff, except the

wheelchair user and two assistants, evacuated the building in 90 s. From this and the use of action sequences from the questionnaire, CRISP was used to model the scenario. At 90 s, all but approximately 25 occupants had evacuated the building. Differences in evacuation times (the total time given by CRISP was 240 s) may result from differences in the “investigate” action in the simulation. The responsible officers in a real situation may have worked together in a more time efficient manner to search all rooms, instead of following the CRISP algorithm ensuring that all rooms are searched. In this scenario, it was the actions of the investigation team that prolonged the evacuation time and prompted CRISP developers to take another look at action algorithms.

**Special features:**

*Counterflow* – Yes, this feature was recently incorporated.

*Manual exit block/obstacles* – Yes, by inputting an increase in the door difficulty.

*Fire conditions affect behavior?* Yes, CRISP has its own zone fire model, but if the model is used as an external fire model (in fire drill mode), there is not fire or smoke for the occupants to respond to. In fire drill mode, fire is extinguished immediately and the alarms sound at  $t=0$ .

*Defining groups* – Yes.

*Disabilities/slow occupant groups* – Yes, and the user can specify to have them “rescued” by another group of occupants (emergency personnel with a defined “rescue” action).

*Delays/pre-movement time* – Yes, these can be input by specifying a mean and standard deviation for occupant activity. For instance, if the action of “reacting” is given a 60 s delay with a specific standard deviation, the occupants will “react” for approximately 60 s, which results in the occupants remaining in place. Once the “reacting” time delay is completed, they will follow their next user-defined action, which is usually “escape.”

*Elevator use* – No, however, this feature is currently being worked on.

*Toxicity of the occupants* – Yes, if the model is NOT simulating in fire drill mode (in the external evacuation model). When  $FED=1$ , the occupant is assumed to be dead.

*Route choice of the occupants/occupant distribution* – Globally, the potential leads to shortest route. This can be overridden by local information and events.

**Limitations:** Complex input files and all behavioral activities must be input by the user. Limitations of the program involve up to 1000 rooms, up to 20 floors, and 15,000 occupants maximum. Also, the maximum grid network is 0.5 x 0.5 m grid.

## A.19 EGRESS

Developer: N. Ketchell, AEA Technology, UK

**Purpose of the model:** The purpose of this model is to determine the evacuation of crowds in a variety of situations, such as theaters, office buildings, railway stations, and ships<sup>11, 82-84</sup>.

**Availability to the public for use:** EGRESS is available only on a consultancy basis and the software is not offered for sale.

**Modeling method:** This is a behavioral model

**Structure of model:** This is a fine network system. The floor plan of a building is covered in cells that are equivalent in size to the minimum area occupied by an occupant. Instead of being square, like most grid cells, the cell is hexagonal in shape, as shown in Figure A.22. The hexagon has a height equal to  $h$  and an area of  $\sqrt{3}/2 \times h^2$ . EGRESS holds a default of 5 people per square meter, which equals a grid spacing of 0.5 m. This can be modified if occupants are expected to be carrying large objects, etc.

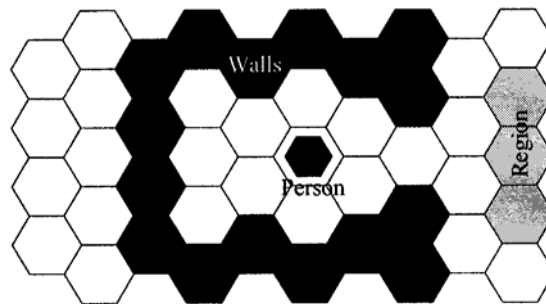

Figure A.22: Example of cells on an egress plan<sup>84, p. 2</sup>

**Perspective of model and occupant:** The model views the occupants as individuals. The movements of each occupant are carefully monitored throughout the simulation. Each individual also has certain goals and a specified time period to complete that goal.

The occupants' perspective of the floor plan is also individual. EGRESS contains a route finding algorithm that defines the shortest distance from each cell on the floor plan to each specified region or exit. Then, the behavioral modeling aids in choosing which objective the occupants moves toward.

**Occupant behavior:** The occupant behavior is conditional. As long as the objective is still possible within the time frame allotted, the individual continues to pursue the goal.

The method of behavioral modelling has become simpler since the previous method was found to cause major issues in the number of decisions made by each occupant. EGRESS provides groups of occupants with itineraries throughout the evacuation in order to alter objectives/goals, as shown in Figure A.23. Each objective (example is movement towards the fire for an



emergency personnel worker) on the itineraries is assigned a time period in which each individual of the group will attempt to reach it. If during the time period, the preferred objective is still possible, each person continues to pursue it. If the objective is no longer possible, the next objective down the list is attempted. The itinerary includes the appropriate delay times for responding and intermediate delays for decision making to pursue other options. Other ways of altering behaviour are assigning regions which are accompanied by a delay time when crossing them, regions which decrease walking speed when passing them, and regions which alter the evacuation route assessment. EGRESS can also incorporate assessing the fractional toxic doses received by the occupants in the evacuation, but the developers state that these are infrequently used due to their degree of speculation in the process of modelling such actions.

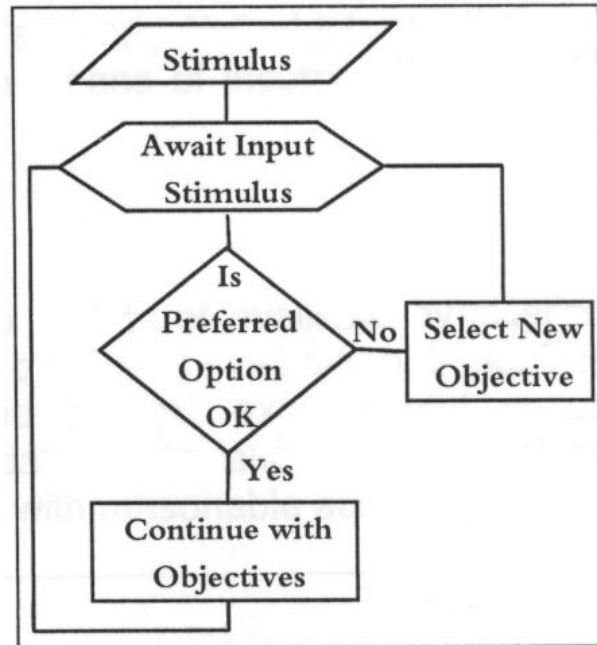

Figure A.23: Behavioral modeling in EGRESS <sup>84, p.9</sup>

**Occupant movement:**

*Route finding*

People move from cell to cell based on the “throw of a weighted die.” This can be described as a cellular automata model. The weights/probabilities of the die are calibrated against the speed and flow, as a function of the density, of the occupants to move them throughout the building. For certain cases, the model can vary these probabilities for the cells to reflect changes in the evacuation event, such as a region becoming blocked by smoke. EGRESS contains a route finding algorithm that calculates the shortest distance from each cell to each exit. With the behavioral modeling in EGRESS, the individual on any cell chooses which exit to move towards. Multiple travel routes are specified within the model by assigning each cell a potential number for each of the exits (or attractors as used by EGRESS). From these index numbers given to each cell, which one of the 6 adjacent cells surrounding the current hexagonal cell is closer, further away, or the same distance from the exit can be determined by comparison among the adjacent cells. Cells can be open spaces, occupied by a person, a portion of a wall or blockage, or an exit/region.

### *Movement algorithm*

The unimpeded mean speed of travel in a given direction is derived from the probabilities of moving in certain directions toward the goal/exit. These probabilities are set based on experimental information. The four probabilities consist of 1) the probability of moving one cell closer to the goal ( $P_1$ ), 2) the probability of moving one cell further away from the goal ( $P_{-1}$ ), 3) the probability of moving to a cell that is the same distance away from the goal ( $P_{+0}$ ), and 4) the probability of staying in the same place ( $P_0$ ). The mean speed toward an exit is given by the following equation (A.5):

$$\bar{v} = \frac{h}{\Delta t} (P_1 - P_{-1}) \quad (\text{A.5})$$

In equation (A.11),  $v$  is the velocity,  $h$  is the height of the grid cell,  $\Delta t$  is the time step, and  $P_1$  and  $-1$  are the probabilities established in the previous paragraph. EGRESS allows the user to input the unimpeded speed of a particular group as a percentage of the default movement speed, in order to simulate injured or disabled occupants. The default movement speed in EGRESS is 0.9 m/s, along with various other parameters of standard deviations for the velocity and times, based on work of Predtechenskii and Milinskii<sup>13</sup>.

### *Flow in crowds*

EGRESS models crowd movement based on the collision rule. The simplest method of applying this rule is to leave an occupant in their current cell if the proposed move is blocked by another occupant. EGRESS uses this similar rule, except that a random alternative adjacent cell is tried and if unoccupied, the person moves into that cell. The first option calculates the speed as a function of density proportional to  $(1-D)$  and the second alternative option calculates a speed as a function of density proportional to  $(1-D/5)$ . This EGRESS method of calculating flow as a function of density compares well with Predtechenskii and Milinskii walkways, Pauls, and Fruin data. Also based on work by Predtechenskii and Milinskii, EGRESS adds additional “haste factors” for speed movement of 1.5 for emergency movement and 0.6 for unconcerned crowd movement.

**Output:** Visualization of congestion points, bottlenecks, merging flows, etc. The visualization tracks the position of each individual throughout the simulation.

**Use of fire data:** EGRESS provides a way for the user to input fire scenario data. The plans for the building, which are already drawn, can be edited at different times and the results can be saved to the “scenario file.”

**Import CAD drawings:** The structure of the building to be modeled can be designed on screen, as well as the position of the occupants.

**Visualization capabilities:** 2-D visualization is possible.

**Validation studies:** In the 2002 EGRESS publication, four specific validation examples are featured. The four validation examples were the following:

- A series of competitive evacuation drills were performed using a Trident aircraft. Competitiveness stemmed from the fact that the first 30 evacuees received a monetary reward. The occupants either evacuated via the main exit (Type 2) with varying door width or through the overwing exit (Type 3).
- A double-decker bus was evacuated, and the evacuees were aware that a trial was being completed. Smoke capsules were used and the driver ordered the evacuees to leave the bus.
- Two theaters were evacuated during the Tukuba Exp in 1985. These seated 424 and 500 people.

The results are shown in Table A.13:

Table A.13: Validation results for the EGRESS model

Validation Case	Evacuation Time (s)		Variation
	Observed	EGRESS	
Trident (main)	24	33	+38 %
Using EGRESS default emergency speed		22	-8 %
Trident (overwing)	53	25	-53 %
Bus	83	65	-22 %
SU Pavilion	66	86	+30 %
SH Pavilion	160	133	-17 %

The range of error is approximately  $\pm 20\%$  to  $\pm 30\%$ , except where specific features were not modeled, according to the developer. Also, crowding was well modeled. Lastly, the Trident aircraft example provided a better result when EGRESS was equipped with the emergency speed, since the experiment was competitive in nature.

One thing should be noted is the length of the evacuation times in each comparison. They range from 0.5 min to under 3 min. With short evacuation times, a difference of 9 s, such as shown in the Trident (main) case, will give a 38 % variation. This is calculated by taking the different in the evacuation times and dividing the difference by the observed evacuation speed. If that observed speed is a lower number, even a small difference, such as 9 s, will show a significant percentage in variation. The author added this paragraph to put the last column's (Variation) values into context.

**Special features:**

*Counterflow* – Yes, the model can specify emergency personnel to move towards the fire as a goal.

*Manual exit block/obstacles* – Yes, the user can add obstructions to the building.

*Fire conditions affect behavior?* Input by the user in a scenario file allows the user to simulate fire conditions. The drawn building plans are edited at different times with hazard information.

*Defining groups* – Yes, the model only recognizes groups with different goals and movement speeds.

*Disabilities/slow occupant groups* – Yes, the user can input a percentage to be used from the default unimpeded walking speed.

*Delays/pre-movement time* – Yes, both response delays and decision making delays are simulated.

*Toxicity of the occupants* – Yes, but infrequently used.

*Route choice of the occupants/occupant distribution* – Shortest route, which can be altered due to behavioral aspects of the evacuation.

**Limitations:** The model developers state that there are few practical limits on the size of the simulations because the model can handle several thousand occupants and plan areas of many km<sup>2</sup>.

## Models Not Yet Released

### A.20 Spatial-Grid Evacuation Model (SGEM) Package

Developer: Lo, S.M. from the Department of Building and Construction, City University in Hong Kong (primary developer).

**Purpose of the model:** The purpose of this model is to make use of CAD plans to generate escape patterns from complex buildings<sup>85, 86</sup>.

**Availability to the public for use:** The model is not yet available to the public. The model has been used for some consultancy projects; however the developers are still working on the interface of the model, the CAD feature, and the simulation process.

**Modeling method:** Movement/Partial-Behavioral model

**Structure of model:** The structure of the model is ultimately a fine network model. Initially, the model resolves the building into nodes that represent spaces/zones (unprotected, partially protected, and fully protected) of the building with at least one arc (opening) between the zones, which is labeled as a coarse network. Then, each zone is divided up into a finite grid of cells each measuring 0.4 x 0.4 m in size to represent the amount of space taken up by one occupant, which is the reason that the model is labeled as a fine network model. Additionally, only one person occupies a grid cell at a time.

**Perspective of model:** Individual perspective. The model tracks individual occupants at each time step throughout the building. Also, occupants' movements throughout the building are based not only on the distance to an exit but also on other conflicts that arise during the evacuation.

**Occupant behavior:** None/implicit.

Individual behavior is simulated using a wayfinding function. The wayfinding function of the model is affected by personal characteristics of the individual (age, gender, drive, patience, etc) and the environmental stimuli in a zone (obstacles, conflicts, smoke, alarm signals, assistance of a manager, etc.). This wayfinding function ultimately adjusts the directional adjustment of individual's movement (depending on obstacles and conflicts) and the individual's speed (slowing, stopping). However, the reference for the model<sup>85</sup> then states that "at present, we merely consider three classes of behavioural effect and provide respective weightings," without going into more detail.

The route choice tendency alters the tendency of a direction an occupant takes to leave a zone. On the other hand, the wayfinding function decides the direction the occupant will actually take at each time step.

**Occupant movement:** Cellular automata model.

The movement speed of the occupants is dependent upon the surrounding density. The movement speed, according to the references for the model, is also affected by the level of hazard of the environment, personal characteristics (gender, age) and building configuration. The model allows the user to input speed adjustment for each individual, but also provides default values. Ultimately, the speed of the individual is dependent upon the crowd density, the number of nodes representing the building, the number of people in the building, and the processing time.

As crowds increase, the model determines the number of people around each individual in a pre-determined area. If there are no other occupants in a 1.12 m<sup>2</sup> area around the simulated occupants, an individual's speed is regarded as unimpeded<sup>87</sup>. However, when occupants come in contact or "conflict" with another occupant, they have three options: turn 45° to the left, turn 45° to the right or stay in their cell. The model records the number of occupants in the 1 m region around the occupant (3 cells in the forward and lateral direction forming a 1.2 x 1.2 m area).

Through exits, the model moves occupants at the front of the crowd through an exit at an unimpeded speed depending upon the exit type (revolving door, turnstile, swinging door, etc). However, the other people adjacent to these occupants near the exit move at controlled flow rates through the exit. When moving occupants from one zone to another zone through an internal exit, the model uses a balance between the number of occupants entering into a zone and occupants escaping from the previous zone.

*Formula for walking speed:*

To establish the crowd flow function for the SGEM model, the gas-lattice model (cellular automata model) was used to simulate movement of crowds through a corridor with 100 x 20 cells under the "periodic boundary condition." Each "walker" moves in a "preferential" direction (forward, downward, or upward) with no back stepping or overlapping of a single cell. "A non-dimensional drift is applied to the preferential direction for random walkers to represent the tendency of moving towards an exit." People are randomly distributed along the corridor for a specific density and for an average of 3000 runs, the mean velocity was calculated for all occupants. For movement of the occupant by the gas-lattice model, probabilities are calculated to move into certain adjacent cells, with a higher tendency for occupants to move toward the exit. For more information on how the gas-lattice model compares with other researchers in the field, the following reference should be consulted<sup>85</sup>.

From a curve fit of the gas-lattice model, the following is the crowd density versus velocity equation:

$$V = \begin{matrix} (1.4 & d \leq 0.75, \\ 0.0412d^2 - 0.59d + 1.867 & 0.75 < d \leq 4.2, \\ 0.1 & d > 4.2), \end{matrix}$$

where  $v$  is the speed of the evacuee (m/s) and  $d$  is the density in persons/m<sup>2</sup>.

**Use of fire data:** None.

**Output:** As the model captures the movement patterns of the evacuees, it provides output in the form of evacuation times of the entire building and certain building components/zones throughout the building.

**Import CAD drawings:** Yes. Part of the SGEM package involves the AutoCAD recognition module.

As part of the package, there is an Automatic Region Generator (ARG) that can capture architectural information from CAD plans and rebuilds the regions (and their topological relationships). Also, the ARG identifies the evacuation directions of the occupants at each portal. The capturing process involves three different stages:

- Formatting: The “loose” information from the CAD plans are reformatted and unnecessary information is removed.
- Recognition: The formatted information forms the regions/zones within the building
- Corrective: The user is required to redefine any unrecognized parts of the CAD plans.

**Visualization capabilities:** Yes, this is part of the SGEM package labeled as the output module. The output can be provided in 2-D by this model.

**Validation studies:** One exercise that was performed with the SGEM model to demonstrate the model’s ability to cope with difficult or complex geometries and a large population using a floor plan of a shopping mall. In addition, exercises were run with the model using the floor plans of a karaoke establishment. These exercises showed that the model recognized a change in overall evacuation time of the establishment when varying the width of the main corridor. However, with the exercises, there was no comparison made with other models or data (drill or actual)<sup>85</sup>.

A comparison of the model results to a field test was performed using a lecture theater in City University in Hong Kong<sup>86</sup>. A controlled evacuation drill was conducted and recorded at various locations in order to collect the necessary data for a comparison with the model. The purpose of the drill was to capture the overall evacuation time, the flow pattern of the occupants, and the walking speeds of the occupants at different points throughout the theater. 82 students participated in the drill and were told to evacuate via the front door at the sound of the alarm. The total evacuation time was recorded as 66 s. The input consisted of dividing the lecture theater into 9 zones and assuming a uniform speed of 0.6 m/s for occupants at the seats and 1.3 m/s through the wider areas and doorways. According to the article, the evacuation time varied with the initial positions of the 82 students among the 140 available seats in the theater. By varying initial occupant location, the evacuation time for the theater ranged from 58.4 s to 61.9 s, with an average time of 60.1 s and a standard deviation of 1.54 s. The predicted mean evacuation time (with a response time of 0) plus the few seconds of response time for the occupants in the actual event came close to the drill time of 66 s, according to the article<sup>86</sup>. The evacuation time of the theater versus the number of occupants in the theater is provided in

graphical format in the article in addition to the flow rate at the exit door at each 5 second interval during the evacuation (graphing both the model results and the evacuation drill results).

The developers stated that the model has been validated by several planned fire drill exercises. Also, a comparison has been made between the output of SGEM and STEPS. According to the developer, both validation exercises have proven to be successful, however no literature on this was provided for references<sup>88</sup>.

### **Special features:**

#### *Manual exit block*

*Counterflow:* The developers can simulate counterflow situations; however, minor adjustments are made to the computer code to simulate this feature.

*Disabled/slow occupants?* The model allows the user to input initial speed values for certain individuals, which can include a slower speed.

*Pre-evacuation times:* Delay times can be specified by the user or distributed randomly up to a maximum delay time.

*Impatience/Drive:* These options seem to be available to choose for specific individuals. It is unclear how these affect the wayfinding element of the program.

*Route choice of the occupants/occupant distribution:* Route choice is affected by two things:

1. The minimum distance to the exit region
2. Route choice tendency depending upon the individuals' familiarity, visual accessibility, directional signs, illumination of the route, etc. It is unclear of how this is simulated.

**Limitations:** None specifically noted.



## A.21 Egress Complexity Model

Developer: H.A. Donegan, University of Ulster, UK

**Purpose of the model:** The purpose of this model is to provide results on egress uncertainty related to the building and provide a measure of complexity of the building structure<sup>89,90</sup>. This is not a traditional egress model in that it does not calculate egress times for a certain population, but instead uses an entropy probability to simulate the expected information content, and in turn, the complexity of the floor plan. This model is considered to be a macroscopic model, which focuses on evacuation routes and the population as a whole, instead of individual elements (microscopic).

**Availability to the public for use:** Unknown.

**Modeling method:** This is a movement model/partial behavioral model

**Structure of model:** This is a coarse network system. Each compartment (room, stairwell, or area that can be occupied) is labeled as a node. Arcs are then drawn between the nodes on the floor plan.

**Perspective of model and occupant:** This model is not a traditional evacuation model with occupants traveling throughout the building from initial starting points in order to calculate an evacuation time. This model uses the probabilities of acquiring knowledge (or not) to calculate the complexity of the space. The model views the occupants (if at all) in more of a global manner. There are not individual characteristics given to each person that would make them unique in an evacuation.

The occupants have a semi-individual view of the building because of the fact that they can backtrack due to a lack of acquiring information. They are simulated as having an unfamiliar view of the building. On the other hand, in the basic model, the occupants only have one exit to choose from (all networks are trees).

**Occupant behavior:** The model is labeled as not simulating behavior.

**Occupant movement:** The concept of entropy is used in thermodynamics to describe a measure of disorganization of a physical system. In 1948, the name or label of entropy was adopted by Shannon as a measure of uncertainty<sup>91</sup>. Shannon entropy is expressed by the following equation:  $H(p(x) | x \in X) = -\sum p(x) \log_2 p(x)$  where the summation is over  $x$  and  $p(x)$  is the probability distribution on a finite set  $X$ . The Shannon entropy (the expected information content) which is used by this Egress Complexity model, is the equation above given that  $\sum p(x) = 1$ .

This model focuses on the concept of “acquiring knowledge with respect to egress.” Throughout the simulation, knowledge is gained by achieving positive movement along an arc from one node to another. This type of movement is used to simulate acquiring one packet of knowledge on one information step and is labeled as a positive instance. If an arc is backtracked, knowledge is

not gained, and this is labeled as a negative instance. The probabilities of acquiring or not acquiring information are shown here as Equations (A.6):

$$p^+ = \frac{n^+}{n^+ + n^-} \qquad p^- = \frac{n^-}{n^+ + n^-} \qquad (A.6)$$

In these equations,  $n^+$  is the number of positive instances and  $n^-$  refers to the negative instances.

The total entropy of the system is given by Equation (A.7):

$$H = -(p^+) \log_2 p^+ - (p^-) \log_2 p^- \qquad (A.7)$$

Assumptions used in the model are the following:

- Evacuees do not have previous knowledge of the building
- Each evacuee is treated as the only occupant in the building, ignoring influence of other occupants
- Multiple exits from any compartment are equally likely
- No signage is used throughout the building
- Evacuees do not experience panic
- All evacuees are able-bodied
- All networks are trees
- A backtrack path is equivalent to one positive and one negative instance
- A forward path resembles a positive instance.
- Each evacuee has a path memory.
- An example of the steps taken for the most basic model is shown here. This example involves a single floor, single exit and the steps that the model takes to reach an output of entropy and complexity are listed:
- Selection of a node on the network which is not an exit
- For the arcs on the path that lead directly from the node to the exit, a single-headed arrow is drawn in the direction of the exit →
- On all other remaining arcs, a double headed arrow is drawn.
- Count the number of double-headed arrows and this is the value for  $n^-$
- Count the number of single-headed arrows and this is the value for  $n^+$
- Substitute the values in for  $n^-$  and  $n^+$  to calculate the entropy value for that node
- Repeat steps 1-6 for each non-exit node
- Average all nodal entropy values together

This results in the average entropy value for each node or the overall complexity value.

The suggested improvements to the model, such as occupants with disabilities, buildings with greater than one exit, simulation of locked doors, etc. were listed but not explained as to how these would alter the simulation and results.

**Output:** The output from the model is an average entropy value for each node, which is the overall complexity value for each floor.

**Use of fire data:** None.

**Import CAD drawings:** No. Nodes and arcs are input into the Egress Complexity Model.

**Visualization capabilities:** None.

**Validation studies:** A validation study was performed which compared the Egress Complexity Model results of complexity to EVACNET+ results. The study used a network of nodes and arcs to represent a building with one fixed exit and one exit which would vary positions. The comparison consisted of improvements shown by each model (Egress Complexity would show a reduction in complexity and EVACNET+ would show a decrease in time period and an increase in flow of occupants to exits) with varying placement of the second exit. Differences in improvements were found for certain positions of a second exit between the two models.

**Special features:**

*Manual exit block/obstacles* – No, but this was an area of improvement. It is not clear if this feature has been added (by simulating locked doors).

*Disabilities/slow occupant groups* – No, all evacuees are able-bodied, but this topic was listed as an area of improvement that the model can be extended to cater for.

*Route choice of the occupants/occupant distribution* – An assumption used is that the building contains only one exit, but an improvement listed to the model was to increase the buildings to more than one exit (which gives multiple routes to the occupants).

**Limitations:** One limitation is the assumptions made by the model. This is not a traditional evacuation model, but instead a model used to measure the complexity of the structure from an evacuation point of view.

## A.22 EXIT89

Developer: R.F. Fahy, NFPA, U.S.

**Purpose of the model:** EXIT89 was originally developed to simulate large populations in high-rise buildings<sup>92-97</sup>. The developer claims that the model is capable of the following things:

- Handle large populations
- Recalculate exit paths after nodes become blocked by smoke
- Track individual occupants as they move throughout the building
- Vary travel speed as a function of population density.

**Availability to the public for use:** The program has not been released by NFPA. The model can be obtained through special arrangement with the developer. Currently, the model is not publicly for sale.

**Modeling method:** This is a partial behavior model. It relies on the density versus speed data from Predtechenskii and Milinskii for different building components, such as horizontal components, doorways, up stairs, and down stairs. It also uses conditional movement, depending upon the presence and density of smoke in the evacuation path.

**Structure of model:** This is a coarse network system. The floor plan is divided up into nodes and arcs, specified by the user of the program. The nodes require the following input from the user: the node name, the usable floor area, the height of the ceiling, maximum capacity of the node (number of people), number of people at the node when evacuation begins, the number of people at the node who are disabled, an ID that notes whether the node leads to the outside or is part of the stairway, amount of time the people at that node will delay before evacuating, and the node that occupants at that room will travel to if the user is defining the exit route. For each arc, the distance from the first node to the opening/restriction between the two nodes, the width of the opening, and the rest of the distance from the opening to the second node is specified.

**Perspective of model:** The model views the occupants individually because the output of the model tracks the individuals' positions throughout the evacuation. Also, the occupants have an individual view of the building because the route choice can consist of either the shortest route or a user-defined route for certain nodes. There is a fine line here because the individual occupants are not given a route. Instead all occupants located initially at a certain node will travel the user-defined route. If an exit is blocked manually or by smoke conditions, the occupant then chooses an alternate route based on the floor they are on, not a global view of the building. This way, the occupant may take a longer way out<sup>97</sup>.

**Occupant behavior:** Implicit behavior is modeled.

**Occupant movement:** The model emulates the "shortest route" algorithm that identifies the exit of the network and then fans out from the exit in an attempt to identify the shortest routes to all other nodes. EXIT89 calculates the shortest routes on each floor to the stairs or outside. This is

done so that if a node on the floor is blocked by smoke, only the routes on that floor and the floor above will need to be recalculated. It also allows the occupants to maintain an individual perspective of the building.

Walking speed throughout the model is a function of density, based on the observations of Predtechenskii and Milinskii<sup>13</sup>. EXIT89 allows the user to choose between three different body sizes labeled American (0.0906 m<sup>2</sup>), Soviet (0.1130 m<sup>2</sup>), and Austrian (0.1458 m<sup>2</sup>). The calculations used in EXIT89 use the specific body size to solve for the density of a stream, D, of occupants as  $D = Nf/wL$  (m<sup>2</sup>/m<sup>2</sup>) where N is the number of people in the stream, f is the area of horizontal projection of a person, w is the width of the stream, and L is the length of the stream. Predtechenskii and Milinskii report a maximum density of 0.92 m<sup>2</sup>/m<sup>2</sup>. The user can also specify whether the occupants will move in emergency or normal conditions, and the difference in calculation is shown below.

EXIT89 uses the velocity correlations for horizontal paths, down stairs and upstairs, depending upon the density calculated in each movement situation, as given by Predtechenskii and Milinskii<sup>13</sup>.

*Horizontal Paths:*

$$V = 112D^4 - 380D^3 + 434D^2 - 217D + 57 \quad (\text{m/min}) \quad (\text{A.8})$$

for density:  $0 < D \leq 0.92$

*Down Stairs (↓):*

$$V_{\downarrow} = Vm_{\downarrow} \quad (\text{m/min}) \quad (\text{A.9})$$

where  $m_{\downarrow} = 0.775 + 0.44e^{-0.39D_{\downarrow}} \cdot \sin(5.61D_{\downarrow} - 0.224)$

*Up Stairs (↑):*

$$V_{\uparrow} = Vm_{\uparrow} \quad (\text{m/min}) \quad (\text{A.10})$$

where  $m_{\uparrow} = 0.785 + 0.09e^{3.45D_{\uparrow}} \cdot \sin 15.7D_{\uparrow}$  for  $0 < D_{\uparrow} < 0.6$ ;

where  $m_{\uparrow} = 0.785 - 0.10\sin(7.85D_{\uparrow} + 1.57)$  for  $0.6 \leq D_{\uparrow} \leq 0.92$

For emergency movement, equations (A.8) to (A.9) are adjusted by equation (A.11):

$$v_e = \mu_e v \quad (\text{A.11})$$

Where  $\mu_e = 1.49 - 0.36D$  for horizontal paths and through openings

$\mu_e = 1.21$  for descending stairs

$\mu_e = 1.26$  for ascending stairs

EXIT89 uses tables of velocities (based on occupant densities) for normal, emergency, and comfortable movement along horizontal paths, openings, and stairways.

**Output:** The output consists of a complex occupant movement table that tracks the time and corresponding node position of each occupant throughout the entire simulation. Also, the total

evacuation time and the number of occupants trapped are provided in the output. Stair and floor clearing times are also included.

**Use of fire data:** Fire data can be imported from CFAST<sup>98</sup>.

**Import CAD drawings:** No. Building data is specified through the node and arc inputs.

**Visualization capabilities:** No visualization

**Validation studies:** Several validation studies are available for EXIT89. One study involves comparing results from a fire drill involving 100 occupants from a 9-story building. Both the emergency and normal evacuation speeds were used in two different simulations of the building. An error of 20 % was noted from the emergency run (5.6 min from EXIT89 and 7 min actual evacuation time), and the normal run overestimated the evacuation time by 43 %.

The second validation study was performed using a 7-story office building in Newcastle-on-Tyne in the UK. The fire brigade captured this data, and during the fire drill, challenged the occupants by blocking access to one of the stairways. The fire brigade captured information from different exits as well as surveyed occupants on their initial location, exit used, and delay times before beginning evacuation. During the fire drill, the occupants used the most direct route possible out of the building, sometimes ignoring closer exits and/or climbing stairs to get there. Fahy used EXIT89 to first send all occupants to the closest exit, and second to use the user-defined route option to mimic the occupant paths during the drill. The results are found in Table A.14 below.

Table A.14: EXIT89 validation study results from the 7-story office building

	Observed		Predicted – Shortest Route		Predicted – User Defined	
	People	Last Exit	People	Last Exit	People	Last Exit
Exit 1	2	45.9 s	2	35.0	2	35.0
2	6	48.0	6	26.0	6	26.0
3	6	90.0	107	148.0	6	36.0
4	40	105.0	124	153.0	51	104.0
5	0	-	7	72.0	7	103.0
6	23	115.0	27	109.0	26	95.0
7	0	-	0	-	-	-
8	48	190.0	6	60.0	30	120.0
9	8	90.0	11	54.0	11	54.0
10	248	220.0	91	107.0	242	162.0
Total Exited	381	286.0	381	153.0	381	162.0

The predicted results from the shortest route simulation provided a shorter evacuation and much different flow split than the actual/observed data. Fahy states that this is due to the unusual use of exits and the overwhelming use of Exit 10 by the occupants of the building. After running a user-defined simulation, the flow distributions seemed more reasonable, but the overall evacuation time of the prediction still provided results of approximately 2 min under the observed time. Fahy suggests that the reason for this discrepancy is that EXIT89 was not equipped with pre-movement or delay time capabilities at the time of this validation work.

Lastly, Fahy simulated a fire drill conducted in a major department store by the University of Ulster in the UK. 495 occupants were involved, many of whom were video taped and interviewed about their evacuation. Travel speed that would provide the longest and most conservative evacuation times (normal evacuation speed) were used, due to the lack of cues indicated an emergency. Also, the shortest route option was selected for the occupants because of the presence of staff during the evacuation. The model simulation incorporated delay times for occupants recorded on videotape, as well as mean delays times for each department and additional random delays for each occupant. Table A.15 below shows the results for the observed and simulated evacuations from the department store:

Table A.15: EXIT89 validation study results from the department store

Exit	Observed			Predicted		
	# People	First (s)	Last (s)	# People	First (s)	Last (s)
1	33	23	83	45	28	64
2	52	31	165	85	43	71
3	32	36	100	16	22	49
4	49	1	104	80	33	83
5	77	17	95	36	39	52
6	41	21	153	26	37	49
7	2	-	-	-	-	-
8	23	33	78	23	47	85
9	23	26	119	27	42	111
10	7	50	78	27	37	106
11	6	46	60	5	45	54
12	58	32	119	13	49	83
13	45	14	85	49	31	104
14	29	34	102	63	37	74
Total	495			495		

As shown, the observed evacuation ended in 2 min, 45 s and the simulation ended in 1 min 51 s. Fahy states that there was good agreement between the observed and EXIT89 results, and also noted large discrepancies for Exits 2 and 6. Fahy explained these discrepancies as delays prompted by the staff involving the deactivation of the door alarm, checking shopping baskets of evacuees, and performing final sweeps of the area for stray occupants.

**Special features:**

*Counterflow* – Yes, the user specifies what percentage of the stairwell is blocked and at what time within the simulation that this occurs. If the obstruction or counterflow disappears after some time, the user can set the node back to its original area.

*Manual exit block/obstacles* – Yes, the user enters the name of the blocked node and the time from the start of the evacuation that the blockage occurs (in s). Multiple nodes can be blocked at one time.

*Fire conditions affect behavior?* Yes, the user can enter the output from CFAST. EXIT89 uses the smoke densities and depth of the smoke layer from CFAST to calculate the “psychological impact of smoke, S.” This is done with the following equation:  $S = 2 * OD * (D/H)$  where OD is the optical density of the smoke layer, D is the depth of the upper layer, and H is the height of

the ceiling. This is the same method as is used in EXITT to calculate S. If  $S > 0.5$ , the occupant is stopped and if  $S > 0.4$ , the occupant is prevented from entering the room. Both cases allow for enough clear air in the lower layer to crawl. EXIT89 does not handle crawling, so a value of  $S > 0.5$  is used to block the node, which traps everyone currently at that node as a result.

The smoke alarm will operate when  $S=0.0015$  and the depth of the upper layer  $> 0.5$  feet. EXIT89 assumes that the notification of all occupants occurs when the level for smoke alarm activation is reached at any node. At this time, movement will begin after pre-movement delays have passed.

*Disabilities/slow occupant groups* – Yes, the user specifies the number of disabled occupants per node and then the percentage of “able-bodied” speed at which they will walk.

*Delays/pre-movement time* – Yes, the user can either specify a delay time per node or an overall distribution of pre-movement times. In the latter case, the user inputs the percentage of occupants who will be assigned additional delays, and the minimum and maximum value for delay (s) for the uniform distribution.

*Route choice of the occupants/occupant distribution* – Shortest distance or a user-defined route

**Limitations:** The limitation of the model is 89 nodes per floor and up to 10 stairways for the building. The size of the building and the number of occupants is limited by the storage capacity of the computer used. Once a person enters a stairwell, they will remain in that stairwell throughout the entire evacuation (unless stairway is blocked). EXIT89 is set to allow 1000 5-second time steps, 10,000 links, 20,000 occupants and 10,000 building locations. This is hard-coded into the program, but can be adjusted.



## A.23 BGRAF

Developer: F. Ozel, University of Michigan, U.S.

**Purpose of the model:** The purpose of the model is to simulate cognitive processes during evacuation with the use of a graphical user interface<sup>99-102</sup>. The developer recognizes the model BFIREs-2, of which this model seems to be very similar.

**Availability to the public for use:** The model is not publicly available at this time. The developer is working on putting together a CAD-based version of the model, and states that when that is finished, the model might become available.

**Modeling method:** This is a behavioral model.

**Structure of model:** This is a fine network system. Each node, similar to BFIREs, represents an x,y point on the floor plan. The preference levels are given to spaces/nodes that affect the movement of the occupant throughout the situation. “Paths” are the lines/distances that connect the nodes to one another.

**Perspective of model and occupant:** This model recognizes individuals. The model also keeps track of the position (x,y coordinates) of the occupants throughout the simulation. The properties of the occupants are both physical (walking speed, mobility, alertness, smoke tolerance, and initial location) as well as psychological. Examples of these psychological properties are the goals that the occupant sets for himself/herself and the probability of these occurring, the threshold of stress, and the familiarity.

The occupants also have an individual view of the building because the occupant travels a particular route resulting from a sequence of actions that depend on the preference levels, environment, and the other occupants in the evacuation.

**Occupant behavior:** The model attempts conditional behavior. The model incorporates an episodic structure which is similar to BFIREs. Each episode is identified by a specific goal of each occupant. When the current goal changes, a new episode begins. The decision process consists of choosing the next goal, which triggers a new set of actions for the occupant to choose from. There are also such things as goal modifiers, which are physical, social, or individual factors that can prompt a change in the current goal. Following all descriptions of the concepts is a diagram of the BGRAF system (Figure A.24).

Each portion of Figure A.24 is described below:

- *Action library:* This “library” contains likely actions of occupants during an evacuation. Action sequences are defined by the goal they serve. Examples of actions are stay in place, go to the door, go to the fire, go to the alarm, go to the exit, go to the window, go to an impaired person, turn back, open a door, ventilate a room, etc.
- *Goal modifier library:* This “library” includes the factors that influence or trigger a change in goal. The developer notes that these are obtained from studies of actual fires, but no references are included. Once an occupant reaches the threshold called “information buildup

factor,” the current goal is changed. Examples of goal modifiers are alarms, smoke detectors, usual noises, firefighter arrival, an impaired person, and smoke tolerance.

- *Goal generator*: The model is provided with goals and their probability of occurring. Then, each goal is assigned an action set from the action library. An example provided by the model developer is that if a goal of firefighting was chosen, actions such as go to fire area, fight the fire, etc. may be assigned to this goal. The same action can be assigned to more than one goal.
- *Fire event*: The user introduces information about the fire environment into the model. The information involves the location of the fire and the spread of smoke throughout the space. Subevents are scheduled into the model, such as spread of smoke to a location at the fire floor, spread of smoke to another floor, alarm goes off, fire fighters arrive, etc. While these events are scheduled, local spread rates are entered interactively during the simulation. The developer describes the simulation as interactive, allowing the user to point to areas on the screen and provide different values for the environment.
- *Physical environment*: The user also enters into the model a description of the building and the fire protection aspects, such as location of alarms, status of doors, etc. The building configuration is also sketched interactively and the output is graphical.
- *Route modifier library*: The model assigns preference levels to spaces along different routes in the building. The criteria existing for these preference levels are the following: high priority is given to spaces with “architectural and functional differentiation” because of the belief that occupants have created stronger mental images of these areas; simple paths (instead of complex) are associated with a high probability of making a rational decision; higher preference is given to exits with perceptual access; and priority is indifferent to the introduction of exit signs.
- *People characteristics*: Cognitive properties, such as preference levels, are assigned to each occupant group. Other characteristics include walking speed, asleep or awake at time of fire, and smoke tolerance.
- *Goal Initiator*: This is the central unit that checks the goal modifiers to see if a goal change is needed for each individual at each time frame. If so, the next goal is chosen stochastically. Then, the goal is passed to the action generator.
- *Action Generator*: The individual person is moved by this generator according to the action. The effect of the individual action on the fire event, building, and other individual is transferred to the goal modifiers.

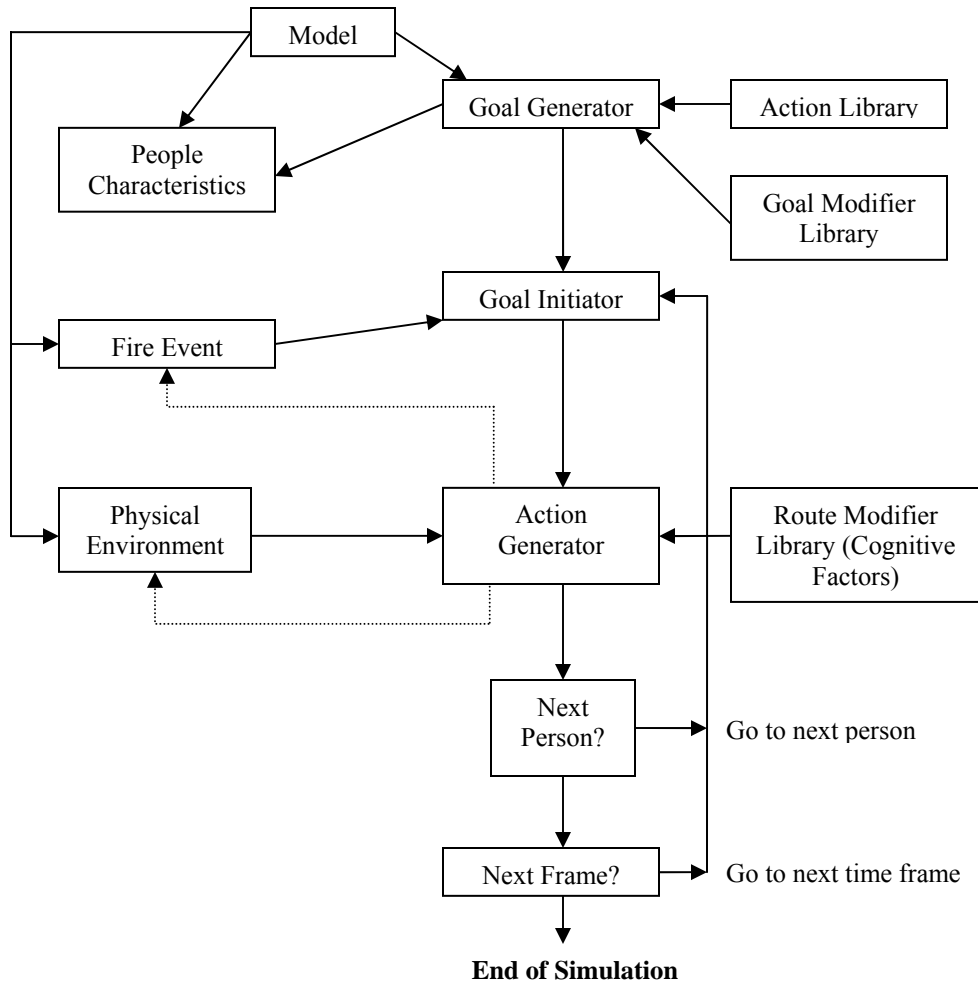

Figure A.24: Conceptual Structure of the BGRAF Model <sup>101, p. 200</sup>

**Occupant movement:** The user determines the total time that the simulation will run. The movement is not explained in detail, other than that the user specifies a specific walking speed of the individual, occupant mobility status, alertness of the occupant, smoke tolerance, and the occupant’s initial location in the building. It is not clear how congestion is modeled.

**Output:** The following output is provided by the model:

- Evacuation time
- Initial distance from exit
- Number of people that successfully escaped the fire
- Length of exposure to smoke
- Action statistics and order actions

Tabular output summarizes the goals pursued by the occupants and the actions that each occupant has taken. Also output are the distances traveled, exits used, and current locations of each occupant.

**Use of fire data:** The model can accept such user input as the start time of the fire, the area of origin, and the fire spread rate. Or, data can be imported from FAST. The fire spread is calculated and simulated for every time frame. Also, occupant decisions, such as opening or closing a door, affect fire and smoke spread throughout the building.

**Import CAD drawings:** A CAD-based version of BGRAF is in development. Currently, the user can sketch out the building geometry using the interactive interface of the model.

**Visualization capabilities:** It seems like this is an option because of the mention of an interactive simulation and high resolution output graphics.

**Validation studies:** A validation attempt was performed on BGRAF with the use of data from a Nursing home fire. Although 91 occupants were on the fire floor, the developers obtained only 22 occupants from which they gained information. These 22 occupants also were not able to supply exit times, so the validation was focused on behavioral activities and decisions. From the 10 runs performed on the nursing home, the model identified the correct proportions of occupant activities 80 % of the time with a 5 % level of significance.

**Special features:**

*Fire conditions affect behavior?* Yes, fire conditions are input by the user or from FAST

*Defining groups* – Yes, the preference level can be assigned by occupant group.

*Disabilities/slow occupant groups* – Yes, the walking speed depends on the physical status of the occupant (ambulatory versus disabled).

*Delays/pre-movement time* – Yes, the model accounts for behaviors occurring before exiting the building.

*Toxicity of the occupants* – Yes, per specified smoke tolerance factor, similar to BFIRES.

*Route choice of the occupants/occupant distribution* – Route choice is dependant upon occupant characteristics and environmental conditions.

**Limitations:** No mention of processing time or capacity of model.

## A.24 EvacSim

Developer: L. Poon, at the Victoria University of Technology, AU

**Purpose of the model:** The purpose of this model is to simulate a variety of complex human behavioral activities, deterministically, probabilistically, or both<sup>103,104</sup>. The model is capable of modeling a large population, but at the same time considers human behavior at the individual level. An occupant can be modeled to interact with the fire environment and/or other occupants, depending upon the occupant's specified level of severity.

**Availability to the public for use:** This model is not released publicly, but instead is used internally at the present time.

**Modeling method:** This is a behavioral model.

**Structure of model:** This is a fine network system. Originally the grid structure was based on zones of the building because it was designed to interface with a zone fire model. However, the user has the ability to refine the grid structure to match the intended resolution of the analysis. The developer stated that the user can "divvy up the zones [on the floor plan] into smaller zones"<sup>104</sup> and the only limit to this is the memory of the computer running the simulation.

**Perspective of model and occupant:** The model views the occupants as individuals because each is given an occupant profile which records the person's physical attribute and his/her building knowledge attribute. Typical occupant profiles are wardens, residents, visitors, and disabled. Occupants are also individually tracked by the output of the model.

The occupant's view of the building is also an individual perspective. An occupant's exit choice is based on the following factors:

- The orthogonal distance between the occupants and exit (based on L-shape approach)
- Length of the cue at the exit
- Whether or not the exit is locked
- The familiarity of the occupant with the exit
- The familiarity of the occupant with the floor plan
- Whether or not the exit is a designated exit (equipped with EXIT signs)
- Whether or not the exit is blocked by the effects of fire
- Action of the occupants (evacuating or seeking fire source, seeking another occupant, etc.)

Many of these factors are local considerations to route choice. Any additional distances traveled by the occupant (during actions, for example) are calculated from the exit points to the destination points to acquire minimum distances.

**Occupant behavior:** Rule-based or conditional behavior. Human behaviour is simulated by EvacSim. The input data for modeling human behaviour is organized in the following categories, shown in Figure A.25:

- Severity scale – Each level; typically low, medium and high, correspond to a range of occupant responses

- Physical scale – This scale is made up of a range of physical cues perceived by the occupant, such as smoke obscuration level and temperature. Each scale is divided into subranges and these ranges correspond to a particular severity level. For instance, air temperatures between 80°F and 100°F are low severity, temperatures between 100°F and 120°F are medium, and temperatures between 120°F and above are high severity.

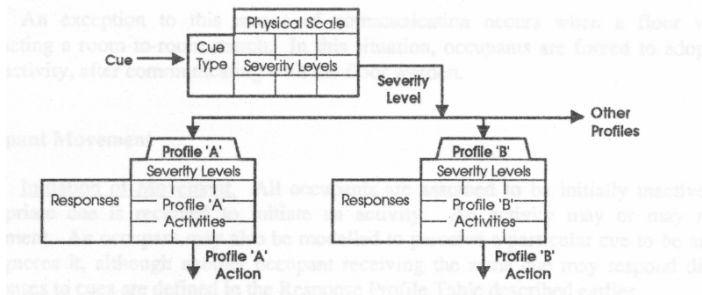

**Figure A.25: Individual occupant responses and actions**<sup>103, p. 684</sup>

Occupant responses are distributed probabilistically on the basis of the occupant’s severity level. Also, each response contains a series of activities that are probabilistically assigned. Typical responses consist of Seek, Warn, and Protect, and typical activities for the Seek response include Investigate fire source, Search for others, Get fire extinguisher, etc. Physical attributes of the occupant consist of the horizontal and stair

maximum velocities, and the area occupied by the person. If more than one response is assigned to an occupant profile, responses are weighted (to determine which one is chosen on a probabilistic basis) and also assigned repeatability (they can occur more than once). The activities can also be given these attributes as well as a preparation time and response time. If no weightings are given, the occupant will follow the line of activities as entered.

There is also an option of assigning familiarity of the building using either “exit familiarity” or “floor layout familiarity.” In the first option, the occupant will only use a familiar exit unless they are blocked, and in the second, all exits are assumed to be familiar. Building knowledge can also be shared among the occupants in the space, as well as fire knowledge.

At the exit points of the building, the model follows the flow rate information, which is a function of density, specified in the SFPE chapter<sup>8</sup> for doorways.

There is no real limit to the definition of a character’s/occupant’s profile and the corresponding response profile. All responses and activities are input by the user.

**Occupant movement:** Occupants in the simulation are static until they receive the appropriate cue to begin an activity (this activity does not have to cause movement). The travel speed of the occupants throughout the building is affected by the occupant density. EvacSim uses a variable bilinear travel speed model, similar to the invariable model proposed by Nelson and Mowrer<sup>8</sup>, based on Fruin<sup>60</sup>, Pauls<sup>105</sup>, and Predtechenskii and Milinskii<sup>13</sup>. Travel speed for disabled occupants also use the same speed model, but incorporate a different horizontal and stair maximum velocities.

Occupant movement within the enclosure adopts the Takahashi’s L-shaped approach<sup>106</sup>. This approach describes movement in an orthogonal path towards an exit due to obstacles that may be present in the space.

**Output:** The output includes lines describing actions of the occupants at all times when an action/movement occurs. A typical line of output lists the simulation time, floor level, enclosure number, occupant number, occupant location in global coordinates, population severity level, and a description of the event.

**Use of fire data:** Changes to the environment in EvacSim can be entered by the user as input into the model. The user can specify the time, the room number, and the environmental conditions. There is no limit to the amount of information that the user can enter. The conditions to be entered are usual zone model outputs, such as temperature and layer height.

**Import CAD drawings:** No, CAD drawings of the building cannot be imported into EvacSim. Instead, the wall, floor, and ceiling boundaries are defined as well as the openings in any of the boundaries (doors and windows).

**Visualization capabilities:** No visualization capabilities.

**Validation studies:** The validation of EvacSim is ongoing. One study was performed in the mid 1980s, in an attempt to use real data from a 12-story, partially-occupied building. Because of the sparse amount of occupants, the evaluation of validity was limited to behavioral activity, not evacuation times. The developer explained that the validation of EvacSim was a lengthy process and was being completed in stages.

**Special features:**

*Manual exit block/obstacles* – Yes, doors can be simulated to be locked.

*Fire conditions affect behavior?* Yes, and fire conditions are user-specified. The user specifies the time, room number, and environmental conditions (layer height, temperature, etc.) to be captured in the simulation. There is no limit to the length or detail of the input.

*Defining groups* – Yes.

*Disabilities/slow occupant groups* – Yes.

*Delays/pre-movement time* – Delays are associated with the activities, preparation and response times.

*Elevator use* – Yes, these may be used by occupants with disabilities. The following actions are taken on by an elevator during a simulation:

- Call – request to use the elevator
- Ascend – elevator travels to request
- Load – occupants get into the elevator
- Wait – doors close
- Descend – elevator travels to discharge level
- Unload – occupants get out of the elevator

- Free – elevator is idle

*Use of emergency management modeling* – The EvacSim model can take into account either a warden system or emergency warning system. The actions of fire wardens during an evacuation are determined by the user. Also, the wardens can be assigned the unique action of a “room-to-room” search on their floor level. On the fire floor, wardens relay the message to “leave immediately” to the occupants. On the other levels, the wardens hold their occupants until receiving instructions from the master warden to begin evacuation (this is the phased evacuation mode). The floors, instead of wardens, can be equipped with an emergency warning system, and the occupant’s decision to evacuate will depend on his/her defined cues (such as the information broadcast over the system).

*Route choice of the occupants/occupant distribution* – Route choice is dependent on a list of information, many of it conditional to the environment, during the evacuation as well as the familiarity with the building.

**Limitations:** According to the developer, EvacSim needs more development and a complete validation. The model is not presently modeling some behavior related to residences, and he would like to integrate a fire model.



## Models No Longer in Use

### A.25 Takahashi's Fluid Model

Developers: Takahashi, Tanaka, and Kose, Ministry of Construction, Japan

**Purpose of the model:** The purpose of this model is to predict and evaluate the evacuation time of people in a fire, mainly from a low level hazard<sup>106, 107</sup>. The assumption of this model is that people move like a fluid.

**Availability to the public for use:** According to one of the authors, the model was published for general use about 15 years ago from the Building Center of Japan and was used for a while in research and practical fire safety design of actual buildings. However, because hand calculation methods have been widely used among building designers for the estimation of evacuation time lately, the model has not become as popular in use.

**Modeling method:** Movement model

**Structure of model:** This is a coarse network system. The 6 space elements are room, path, stair, vestibule, hall, and refuge area. The two "imaginary spaces" are link and crowding.

**Perspective of model:** The model views the occupants globally as a homogeneous group with the ability to move like a fluid with a constant speed in each space element. The occupants view the building globally as well, since they are moved throughout the building through the most optimal route.

**Occupant behavior:** No behavior.

**Occupant movement:** Occupants are uniformly distributed in rooms and given delay times by the user. Takahashi's fluid program models the movement of the occupants throughout the room using two different approaches, depending on the obstacles in a room. The L-shape approach is used for rooms where obstacles are present, which allows the occupants to approach the exit in an L-shaped or indirect manner. For rooms without obstacles, the occupants approach the exit directly using the centripetal approach, as shown in Figure A.26.

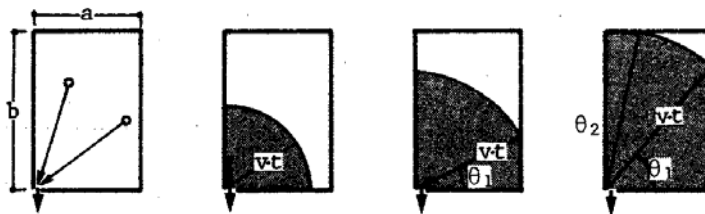

Figure A.26: Occupant movement in a room following the centripetal approach <sup>106, p. 554</sup>

For both methods, the number of evacuees arriving to the exit after a time ( $t$ ) is affected by the length and width of the room, the user specified walking speed, and the density of the evacuees in the room. Any crowding at the exits from rooms is redistributed to achieve the minimum or optimal evacuation time from each space. The fluid movement equations used for the simulation

are applied to the entire population. The assignment of equations to the entire population of a model from another field of study that can be related to human behavior in a fire, in this case fluid flow, has been referred to as a functional analogy<sup>108</sup>. The movement method of this model will be referred to as the functional analogy of fluid flow, with the underlying method of assessing the density of the space elements.

When moving from one space to another in the building (through a link), the movement is dependent upon the number of evacuees ready to move, the availability capacity of the space they would like to move into, the width of the opening, and the number of space elements combining in that link. The model incorporates all of this into overriding equations for the entire population to follow. When the evacuees reach the hall, they use the exits that would minimize egress time, taking into account crowding of the exits, the number of evacuees reaching the exits, the distance to the exits, and the rate of egress (persons/second) at each exit.

**Output:** The output from the model is the total evacuation time and a visualization presentation. The visualization shows the number of evacuees in each space element with five levels of density. When crowding forms at the doors of each space element, for example, blackened arcs can be seen surrounding the doorway to signify higher density.

**Use of fire data:** None.

**Import CAD drawings:** No. The user inputs the length and width of space elements. Not much more information is provided.

**Visualization capabilities:** 2-D visualization of the levels of density on the floor plan, as explained in the output section.

**Validation studies:** Validation studies of the fluid model were performed using measured evacuation times from the seven pavilions of the Tukuba International Expo in 1985. The egress times of the occupants in each pavilion were calculated using two different cases, 1) the L-shape approach is considered in the theater area, and 2) the theater spaces consists of space units connected by paths (rooms and paths). The results are shown below in Table A.16:

Table A.16: Validation results from the Tukuba International Expo

Pavilion #	Egress Times (s)	Average (s)	Calculation 1)	Calculation 2)
1	61, 71, 75, 60, 64	66.2	52	62
2	174, 154	164	137	275
3	71, 80, 77, 78, 79	77	50	76
4	94, 111, 102	102.3	72	89
5	70, 123, 84, 77	88.5	34	59
6	160, 152, 166, 157	158.8	100	107
7	148, 118, 130, 121, 131	129.6	70	88

**Special features:**

*Delays/pre-movement time* – Yes, the delay time is input into the model.

*Route choice of the occupants/occupant distribution* – The optimal route.

**Limitations:** The model provides estimates of the general movement pattern of the occupants.

## **A.26 EgressPro**

Developer: P. Simenko, SimCo Consulting, AU

**Purpose of the model:** The purpose of this model is to predict egress times from a deterministic time-line analysis for a single user-selected room, corridor, and stair arrangement<sup>11, 109</sup>. The model is a tool for assessing egress conditions during fire emergencies in buildings.

**Availability to the public for use:** The model was available through SimCo Consulting, although the developer has said that the model is over 6 years old and he is no longer selling it.

**Modeling method:** This is a movement model.

**Structure of model:** This is a coarse network system. The model acknowledges only a room, corridor, and stair arrangement.

**Perspective of model:** The model views the occupants globally as a certain number of occupants per floor moving as a homogeneous mass to the exit. The occupants also view the building with a global perspective because there is only one exit to travel to.

**Occupant behavior:** No behavior is modeled.

**Occupant movement:** EgressPro models the process of egress movement by following the general concepts of traffic flow. The flow of groups is based on the relationship between speed of movement and the population density in the space. The occupant density (dependent upon the use of the space) can be chosen by the user from an input table and the program will multiply the density value by the room area, which determines the initial number of people in the room. Or, the user may simply choose the number of occupant in the space.

**Output:** “Stair/Corridor Egress Time” is calculated as the output. This is the time interval from the time when the first occupant enters the stair to the time when the last occupant exits the final exit door.

**Use of fire data:** User input of a specific fire.

**Import CAD drawings:** No. The user supplies data to the model, such as each room/space geometry and egress door size. Also, the travel distance along the line of travel on the stair slope and the riser/tread geometry are entered by the user.

**Visualization capabilities:** None.

**Validation studies:** The model’s Help file is said to provide a case study that verifies EgressPro results. Access to the help file was not available.

**Special features:**

*Fire conditions affect behavior?* Yes, the program calculates the time to alarm by calculating the time to detection of a t-squared fire. The detector is assumed to be located in an area so that it is exposed to the maximum ceiling jet velocity and temperature.

*Delays/pre-movement time* – Yes, the pre-movement time is dependent upon the use of the building and the type of alarm present in the building. Delay values are obtained from DD-240 guide. From the write-up on the model, it seems that only 1 delay time is given for the entire population, instead of distributing a range throughout the population.

*Route choice of the occupants/occupant distribution* – Only one choice is given to the occupants.

**Limitations:** The model produces only a “time-line” calculation of movement throughout the room, corridor, and stair arrangement.

## A.27 BFIRE-2

Developer: F. Stahl, NBS, U.S.

**Purpose of the model:** The purpose of this model is to simulate occupants moving throughout a building as a result of decisions he makes during a period of time<sup>110, 111</sup>. The computer program is described by the developer as “modular” in form. To explain, each subroutine has a specific function as its purpose, and these functions fall into the categories of perception, cognition, and action (all relative to the environment). The subroutines are linked through the main program.

BFIRE-2 simulates a building fire as a chain of “time frames” and for each time frame, the model generates a behavioral response for every occupant in the building.

**Availability to the public for use:** Unknown, however this is an older evacuation model.

**Modeling method:** This is a behavioral model.

**Structure of model:** This is a fine network system. The floor plan is overlaid with an orthogonal grid. The spatial plan (walls, boundaries, etc) are laid out on the grid, and occupants are only permitted to occupy grid points (the intersection of the two grid lines is identified by an x,y point).

**Perspective of model and occupant:** This model recognizes individuals. The following information is provided by the user for *each* individual:

- Interruption limit
- Bystander limit
- Familiarity with the exits in the building
- Initial mobility status
- Probability of opening a closed door
- Probability of closing a door
- Initial location within the floor plan.

The model keeps track of the position (x,y coordinates) of the occupants throughout the simulation.

The occupants also have an individual view of the building because the occupant travels a particular route resulting from a “chain” of movement decisions made by the occupant. Each decision is a result of the occupant interpreting gathered information from the environment.

**Occupant behavior:** The model attempts conditional behavior. As mentioned earlier, BFIRE-2 simulates a building fire event as a chain of “time frames,” and during each time frame, a behavioral response is generated for each occupant in the building. As shown in the diagram, the generated responses for each individual are based upon their information processing. Also, building occupants act in compliance with their perceptions of the changing environment. At  $t_1$ , an occupant prepares a behavioral response by gathering information on the state of the

environment at that specific point in time (perception of the situation). Secondly in the process, the occupant interprets the information by relating it to egress goals which guide the overall behavior. This interpretation is accomplished in the following way:

- Comparing current with previous distances between the occupant, fire threat, and exit goal
- Comparing knowledge about the threat and goal locations of the current occupant with the nearby occupants.
- Taking into account locations of physical barriers (walls and doors) and other occupants

Lastly, the occupant evaluates alternative responses from the “response library” and selects an action as the response for  $t_1$ . An example of a behavioral response is to move in a direction that would minimize distance to the exit, resulting from knowledge of both the fire threat and the location of the safe exit. This is noted in Figure A.27.

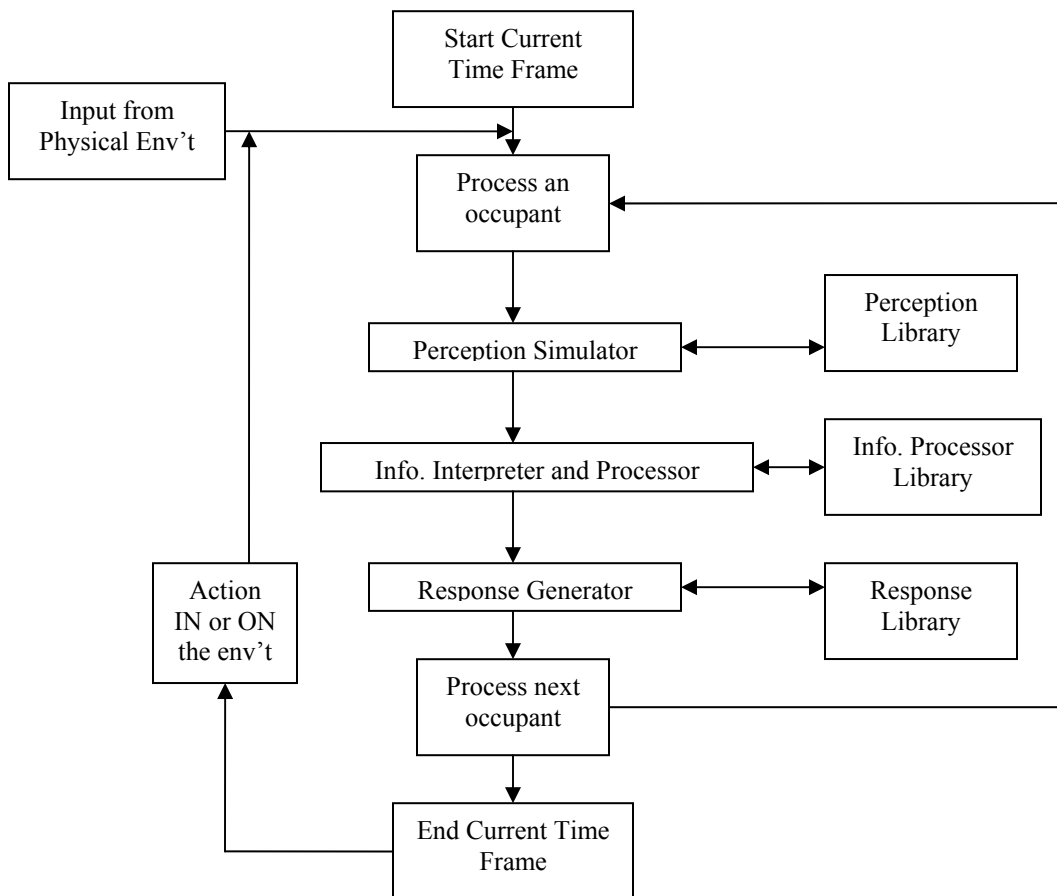

Figure A.27: Behavioral cycle for each occupant in the BFIRE model<sup>110, p. 51</sup>

Each of the processes; perception, interpretation, and response processes, are implemented as individual subroutines. Each subroutine produces an aspect of the human behavior. The two

types of subroutines consist of those which simulate perception and information gathering and subroutines which simulate information processing and decision-making. An explanation of each type is provided below:

Subroutines GROUP, OTHERS, AGREE: These subroutines consists of programs that establish the social environment as the event progresses. GROUP uses the subroutines OTHERS and AGREE to inform the occupant whether any other occupants occupy the same space as the current occupant, whether any others in the space have information unknown to the current occupant, whether others in the space are injured, and whether all occupants can agree on an effective exit route. Route choice depends upon an occupant's perception of the situation, familiarity with the building, lack of information about fire incident, etc.

Subroutine BYSTND: This subroutine will be called if an occupant is occupying a space with an injured or disabled occupant. BYSTND determines probabilistically if the occupant ignores, approaches, or stays to assist the disabled occupant.

Subroutine JAMMED: This subroutine enables the occupant to assess the degree of crowding of the area/location he/she wishes to enter. If the occupant looks ahead to the next space, he/she counts the number of occupants already there. If this number is larger than the pre-set crowding tolerance, this route is rejected from the choices of movement.

Subroutine KPOSS: This subroutine allows the occupant to "see" or scan each potential move and determine if it is physically possible to pass through. This allows the occupant to avoid paths constrained by walls or other physical barriers.

Subroutine INTRPT: This subroutine probabilistically determines whether an occupant's behavior will be interrupted during a time frame, either by remaining in place or backtracking.

Subroutine BACKUP: This allows the occupant to retrace his/her steps back toward the initial starting position. Once at this point, the occupant resumes the decision-making process.

Subroutines ASSIGN, DOORS1, and DOORS2: This model can assign a bias to the occupant's decision-making behavior. This is meant to assign probabilities to decisions made throughout the simulation, which may be more likely than others. DOORS1 controls the probability of the occupant opening a closed door during the evacuation. DOORS2 controls the behavior of whether or not the occupant will close the door behind him/her once passing through.

Subroutine EQUALZ: This is used to satisfy the condition of "no bias" or equalizing the probability values of available alternative moves.

Subroutine TBIAS: This routine establishes probabilities for moves which favor maximizing an occupant's distance from threat, such as fire or smoke.

Subroutine EBIAS: This subroutine uses probabilities that favor moves that minimize an occupant's distance from an exit.



Subroutine HBIAS: This subroutine biases an occupant's moves toward helping disabled or injured occupants.

Subroutine EVAL: This subroutine offers two alternative methods for an occupant to evacuate his/her current safety status. Previously, an occupant achieves a positive evaluation of this situation if an occupant perceives his/her safety status to improve. The two alternate methods involve 1) evaluation is constructed on the basis of the straight-line distance measured from the occupant's current location to threats, exits, or both, or 2) evaluation is constructed on the basis of egress progress (measured in time spent in a threatening environment).

**Occupant movement:** Before running the program, the user inputs the number of desired replicates, the time length of each replication (in time frames), the total number of occupants in the simulation, and a seed number for the random number generator. The program also requires the maximum number of occupants permitted in a single spatial location at any given time. Although the model description does not expand upon the actual movement of the occupants in the building, it seems that the occupant either remains at the grid coordinate or moves to another grid coordinate in a time frame. The BFIRE manual states that egress time is measured in the number of time frames it takes for the occupant to move from the initial position to the exit. The developer explains that the "problem of calibrating the program has not been dealt with in any detail, [but] preliminary simulation experiments do suggest that a "time-frame" could be construed within the range of 5-10 s of real-time"<sup>111</sup>.

Also, as stated above, the user provides the maximum number of occupants permitted in a single space in the building, which aids in deciding whether or not the occupant moves into that space, remains where he/she is, or moves to another position outside of the space. This could possibly reflect a maximum density of the space as chosen by the user.

**Output:** The following output is provided by the model for each occupant at each time frame:

- Location at beginning of frame
- Whether or not occupant experienced an interruption or bystander intervention
- Current exit/goal
- Selection of all probability values for move alternatives
- Final location

The TRACE output allows the user to track the movement of any occupant over a period of time. Also, TOTALS output keeps track of individual events for each occupant.

**Use of fire data:** The user inputs the following conditions in order to simulate fire effects: the x,y coordinates of the initial fire location, fire diffusion rate factor, and occupant's smoke tolerance factor.

**Import CAD drawings:** No, this is an older model. The input needed by the user is the following:

- Location of walls, barriers, exits, and doors (in terms of x,y coordinates)

- Boundaries of room subdivisions
- Information about the doors, such as location, manual or automatic close, and initially opened or closed
- Exit goal locations that are available for each spatial subdivision
- Initial location of the fire
- Number of exits available
- Number of spatial crowding subdivisions in the floor plan
- Number of doors in the floor plan
- Physical crowding threshold for each space in the building

**Visualization capabilities:** None.

**Validation studies:** None noted.

**Special features:**

*Manual exit block/obstacles* – Yes, for each occupant. The occupant can have a probability of 0 that he/she cannot open the door.

*Fire conditions affect behavior?* Yes, fire conditions are input by the user.

*Disabilities/slow occupant groups* – Yes, the user specifies each occupant's initial mobility or disability. This is suspected to mostly affect assistance and rescue behavior of the mobile occupants.

*Delays/pre-movement time* – Yes, the model accounts for behaviors occurring before exiting the building.

*Toxicity of the occupants* – Yes, per specified smoke tolerance factor.

*Route choice of the occupants/occupant distribution* – Route choice is dependant upon occupant characteristics and environmental conditions.

**Limitations:** A limitation of the model is very specific inputs for EACH occupant. It probably gets difficult to model a large number of people. Also, it is not clear what the limit is for modeling a certain number of occupants. This is a much older model.

## A.28 VEGAS

Developer: G.K. Still, Crowd Dynamics Ltd., UK

**Purpose of the model:** The purpose of this model is to simulate human behavioral response under stress conditions and through the fire environment, monitoring toxicity levels and physical containment<sup>73, 74, 112</sup>. All occupants and components of the building operate in “real-time” in a “virtual reality (VR) world.”

**Availability to the public for use:** Unknown. Myriad (described in Section A.28), a macroscopic evacuation model, has seemed to replace the use of the model by Crowd Dynamics, Ltd.

**Modeling method:** This is a behavioral model

**Structure of model:** This is a fine network system.

**Perspective of model and occupant:** The model views the occupants as individuals. Each occupant or “human character” is programmed to respond to the following:

- Proximity to fire/smoke/temperature
- Time from the initial alarm
- Proximity to the exit
- Behavior of their neighbors

Each occupant has intelligence and a number of choices during the evacuation.

According to Gwynne and Galea<sup>113</sup>, the user specifies a defined route to the exit, instead of modeling wayfinding capability. The route is dynamically affected by the fire environment, as shown in the VEGAS diagram.

**Occupant behavior and movement:** The occupant behavior is artificial intelligence, which involves simulating the individual thought processes. The behavior/movement processes are shown in Figure A.28.

The model can use such input as the products of combustion in the building spaces (fixtures, finishes, and furnishings), the fire growth rate, the effect of opening and closing doors, the effect of smoke, toxicity to the occupants, and smoke extraction systems to simulate the evacuation. Each occupant is programmed to respond to the proximity to the fire environment (fire, smoke, and temperature), the time from initial alarm, proximity to the exit, and the behavior of his/her neighbors. VEGAS uses a series of programmable events (by the user) to trigger the occupant respond/ignore cycle.



The exact method for applying both techniques was not expanded upon.

**Output:** Virtual reality simulation of the evacuation.

**Use of fire data:** VEGAS models fire effects, but it is unclear how the fire information is input into the model (it seems that this information can be fed in from a CFD fire model).

**Import CAD drawings:** The user can import DXF files (obtained from CAD) directly into VEGAS/VR environment.

**Visualization capabilities:** 3-D visualization is possible.

**Validation studies:** None found.

**Special features:**

*Manual exit block/obstacles* – Yes, the user can add obstructions to the building.

*Fire conditions affect behavior?* Yes, fire conditions can be simulated but it is unclear how the effects are input into the model.

*Defining groups* – Yes, group behavior is modeled.

*Delays/pre-movement time* – Yes, the assumption is that delays are incorporated in the individual checks made (proximity check, health check) as well as the ability for the occupant to investigate the situation before evacuating.

*Toxicity of the occupants* – Yes.

*Route choice of the occupants/occupant distribution* – User-defined.

**Limitations:** Some of the behavioral factors have not been calibrated with real life data.

## Model Availability Unknown

### A.29 Magnetic Model

Developers: S. Okazaki & S. Matsushita, Fukui University, Japan

**Purpose of the model:** The purpose of this model is to visualize the movement of each pedestrian in a floor plan as an animation<sup>114</sup>. This model uses the functional analogy of the motion of a magnetic object in a magnetic field.

**Availability to the public for use:** Unknown

**Modeling method:** This is considered to be a movement model because of the use of magnetism to move occupants throughout the simulation. Queuing “behavior” can be simulated on the basis of occupants in airports, railway stations, department stores, and office buildings, however, this is just a piece of the overall model. The model can simulate groups, yet, it is unclear whether this is used to model affiliation or reduce computer calculation time<sup>115</sup>. This model is on the borderline of movement and partial behavioral categorizations

**Structure of model:** This is a fine network system. Each occupant is displayed at each 0.1 second time frame at the appropriate location in the plan on the computer display.

**Perspective of model:** The model views the occupants individually, as noted above, during visual simulation. Also, the occupants have three different methods of walking throughout the building (showing an individual or local perspective of the building, depending upon the option chosen). These options are:

- Indicated route – a sequence of corner numbers (vertexes on the walls) is given by the user and the occupants walk along them
- Shortest route
- Wayfinding – an occupant does not know the route and he/she walks seeking the goal

**Occupant behavior:** This model’s behavioral capability is classified as implicit due to the incorporation of observed queuing behaviors, which is mentioned in the following movement section.

**Occupant movement:** The initial input given for each occupant includes the following: the location of the starting point, the maximum walking velocity, time to start walking, orientation to walk, method to walk, and the destination. If there are a large number of occupants, groups can be formed and the group will have a common destination, orientation, start time, and method to walk. The velocity of each occupant in the group is decided by random values which are normally distributed and the positions of the occupants are decided by uniform random variables in specific areas set to the group.

The movement of the occupants is analogous to the movement of a magnetized object in a magnetic field. A positive magnetic pole is given to the occupants, obstacles (walls, columns, etc.), and handrails. A negative magnetic pole is located at the goal or exit. In the magnetic

field of the building, the occupants move toward the goal and avoid collisions. A maximum velocity is provided by the user, because if the occupant moved to the goal simply by the force of the magnetic field, his/her velocity could increase without limit by acceleration, according to Coulomb's law.

Another force acts on an occupant to avoid collision with another occupant. The total of all forces from the goals, walls, and other occupants on each occupant decides the velocity of each evacuee at each time. If large values are given to the parameters of intensity of the magnetic loads of elements and the occupants, the intensities of the repulsive forces increase. As a result, the evacuees maintain longer distances from each other and from obstacles, decreasing the density and the flow of the evacuation. All individuals respond in the same way to the magnetic equations, as a functional analogy would.

The Magnetic model also incorporates a complex queuing system for specialized spaces. Three types of queuing behavior are used in the model, originating from observations made on the movement of occupants in airports, railway stations, department stores, and office building. These three types of queuing systems are 1) queues in front of a counter, 2) queues in front of gates, and 3) queues in front of doors of vehicles.

**Output:** The output includes total evacuation time and a visualization presentation.

**Use of fire data:** None.

**Import CAD drawings:** No. The user supplies data on the walls and openings in the floor plan. The walls are given as xy-coordinates on the plan of a building. Data on the walls also includes handrails and other objects (obstacles). Information is also given to the model on doors, exits, windows, counters, gates, and exits of vehicles (such as elevators and trains).

**Visualization capabilities:** 2-D visualization of occupant movement and areas of crowding is provided.

**Validation studies:** None specified

**Special features:**

*Defining groups* – Yes, groups can be defined if a large number of occupants are included in the simulation. Occupants are then entered as groups and occupant data is given for each group.

*Disabilities/slow occupant groups* – Yes, the user can adjust the maximum walking velocity of the group.

*Delays/pre-movement time* – Yes, the user can input the time to start the evacuation.

*Route choice of the occupants/occupant distribution* – There are three choices, indicated route, shortest route, and wayfinding.

**Limitations:** None provided in documentation.

### **A.30 E-SCAPE**

Developer: E. Reisser-Weston, Weston Martin Bragg Ltd, UK

**Purpose of the model:** The purpose of this model is to view evacuation in real time, identify bottlenecks in the building configuration, and to gain a probabilistic view of the emergency scenario by running the model several times<sup>116</sup>. This model has been compiled from studies carried out on emergency evacuation from over 30 years ago.

**Availability to the public for use:** The availability of the model is unknown at this time.

**Modeling method:** This is a behavioral model.

**Structure of model:** This is a coarse network system. Each room or area in a room is represented by a node, and the arcs connect these as well as represent the distances between the nodes.

**Perspective of model and occupant:** This model seems to view the occupants with an individual perspective. It is unclear whether or not the user inputs individual characteristics of the occupants, but it seems that the model recognizes individual responses to the evacuation environment, according to their Performing Shaping Factors (PSFs).

The occupants have an individual view of the building, because their choice of egress route is affected by the evacuation environment and PSFs. The occupants' choice of route to the exit is affected by the distance of the occupant to the exit, the frequency of use of the exit during normal situations, and the signage of the route.

**Occupant behavior:** The model attempts conditional behavior. The model incorporates the method of Hierarchical Task Analysis (HTA), which involves sorting evacuation into individual tasks and then decomposing these tasks into sub-tasks until the appropriate level of analysis has been reached. Factors of the environment determine the probability of an individual carrying out certain tasks during the evacuation. E-SCAPE recognizes the following four factors that shape an evacuation (these are known as Performing Shaping Factors – PSF):

- Structural PSF: The organization of the work environment, such as physical characteristics, rules, hierarchies
- Effective PSF: The emotional, cultural, and social factors that affect decision-making during an evacuation
- Informational PSF: The information available to occupants from direct collection or its communication
- Task and Resource Characteristics PSF: The tasks being carried out by the occupants that may in turn affect their ability to react to certain cues/stimuli.



The developers claim that these factors were successful in describing the factors in an evacuation after searching through case studies and experiments in egress. Possible tasks during an evacuation are plotted in a hierarchical chart, and an example of this is provided in Figure A.29.

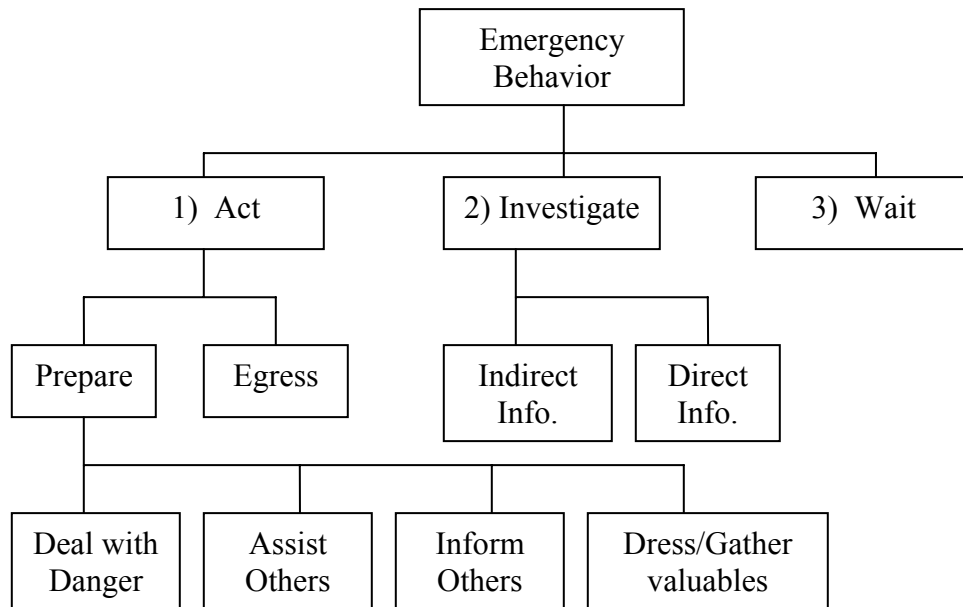

Figure A.29: Examples of possible evacuation tasks for the E-Scape model <sup>116, p. 3</sup>

The decision on whether or not to evacuate depends on how serious the occupant perceives the threat and the warning/fire cue. If the occupant believes the warning to be genuine, this results in the immediate action of acting. On the other hand, if the cue is considered to be unimportant, the occupant will wait.

To analyze the diagram further, once the decision has been made to act, the decision to carry out the preparation activity depends on the PSFs in the environment. For example, an occupant is more likely to “Deal with the danger” if 1) the location of the stimulus is known (informational), 2) the individual is male (effective), 3) the occupant has an organizational responsibility to the building (structural), and procedures are provided for such instances (task and resource characteristic). E-SCAPE accounts for the effect of performing these actions by varying the time it takes to initiate the evacuation, not the actual action. This is done to reduce the processing power of the simulation, but may take away from the accuracy of the egress times. Gwynne states that “it is not obvious as to how the individual can then have any effect on the environment within such a system, or whether the success or failure of actions is accounted for”<sup>117</sup>.

By defining the building type, a hospital for example, will prompt certain structural, effective, informational, and task and resource characteristic PSFs, which then affect the responses of the occupants and the routes chosen to evacuate the building.

The delay time of space within E-SCAPE is affected by the number of people in a node, since the model assumes that group conformity occurs at certain limits. Also, delay time is also

affected by the movement of others, the building type, smoke, and training. With the movement of others, the probability of evacuation increases as more people leave the room. Depending upon the building type, organizational responsibility may encourage occupants to tell others to leave, which in turn decreases the affect of group conformity. The presence of smoke acts in decreasing delay time and will act as an additional cue in the evacuation. Lastly, special training and fire drills have a different effect on the occupants. If the occupants have experiences both special training and fire drills, these two effects cancel each other out and the delay time remains unaffected. If only special training is received, delay time is reduced, and if only fire drills are experienced, delay time is increased.

**Occupant movement:** The occupant route choice is affected by the distance of the occupant to the exit, the frequency of use for the exit during normal hours, and the signage along the route. Depending upon the level of use of the exit, E-scape assigns a weighting which effects evacuation from the building. The weightings of each exit are then multiplied by the distance of the occupant to the exit, which determines the overall weighting for the exit for each occupant. These delay times and exit choice behaviors were combined with a dynamic movement model<sup>9</sup> to produce an evacuation model. Through the use of Pauls' model, people are moved throughout the building.

The user defines the dimensions of the building through nodes and arcs, the position of the occupants in the structure, and describes the type of structure and exit choice factors.

**Output:** The output includes the visualization of the evacuation, identification of bottlenecks, and if the model is run a number of times, a probabilistic picture of the evacuation scenario.

**Use of fire data:** Environmental conditions of the building are input by the user via the environmental conditions window. The user can specify if there is smoke in the building and if it spreads to the floor, entire building, or remains in the room of origin.

**Import CAD drawings:** No, nodes and arcs are input into E-scape.

**Visualization capabilities:** Yes, 2-D visualization is possible

**Validation studies:** None noted. The example of the offshore platform shows only that E-scape can represent the geometry.

**Special features:**

*Fire conditions affect behavior?* Yes, fire conditions are input by the user.

*Defining groups* – Yes.

*Delays/pre-movement time* – Yes, delays are incorporated by the model because it varies the time it takes to initiate evacuation.

*Route choice of the occupants/occupant distribution* – The route choice is dependent upon distance to exit, frequency of use of exit, and signage.

**Limitations:** Still some questions left unanswered about model.

## A.31 References

1. Nelson, H. E. (2003). Personal Communication
2. Deal, S. (1995). *Technical Reference Guide for FPETool Version 3.2* (Rep. No. NISTIR 5486-1). Natl. Inst. Stand. Technol.
3. Francis, R. L. & Saunders, P. B. (1979). *EVACNET: Prototype Network Optimization Models for Building Evacuation* (Rep. No. NBSIR 79-1593). Natl. Bur. Stand., (U.S.).
4. Kisko, T. M., Francis, R. L., & Nobel, C. R. (1998). *EVACNET4 User's Guide, Version 10/29/98* University of Florida.
5. Johnson, P., Beck, D., & Horasan, P. (1994). Use of Egress Modeling In Performance Based Fire Engineering Design -- A Fire Safety Study At The National Gallery of Victoria. In T. Kashiwagi (Ed.), *Fire Safety Science -- Proceedings of the 4th International Symposium* (pp. 669-680).
6. Gwynne, S. & Galea, E. R. (2004). *A Review of Methodologies and Critical Appraisal of Computer Models Used in the Simulation of Evacuation from the Built Environment* Bethesda, MD: Society of Fire Protection Engineers.
7. Harrington, S. S. (1996). *TIMTEX: A Hydraulic Flow Model for Emergency Egress*. MSci Department of Fire Protection Engineering, University of Maryland.
8. Nelson, H. E. & Mowrer, F. W. (2002). Emergency Movement. In P.J.Denno & W. D. Walton (Eds.), *The SFPE Handbook of Fire Protection Engineering* (Third ed., pp. 3-367-3-380). Bethesda, MD: Society of Fire Protection Engineers.
9. Pauls, J. (1980). Building Evacuation Research Findings and Recommendations. In *Fires and Human Behavior* (pp. 251-274). New York, NY: John Wiley and Sons, Inc.
10. Proulx, G. (2002). Movement of People: The Evacuation Timing. In P.J.DiNenno & W. D. Walton (Eds.), *The SFPE Handbook of Fire Protection Engineering* (Third ed., pp. 3-341-3-366). Bethesda, MD: Society of Fire Protection Engineers.
11. Fire Model Survey (2002). <http://www.firemodelsurvey.com/EgressModels.html> [On-line]. Available: <http://www.firemodelsurvey.com/EgressModels.html>
12. Shestopal, V. O. & Grubits, S. J. (1994). Evacuation Model for Merging Traffic Flows in Multi-Room and Multi-Story Buildings. In *Fire Safety Science -- Proceedings of the 4th International Symposium* (pp. 625-632).

13. Predtechenskii, V. M. & Milinskii, A. I. (1978). *Planning for Foot Traffic in Buildings*. New Delhi: Amerind Publishing Co. Pvt. Ltd.
14. MacDonald, M. (2003). STEPS Simulation of Transient Evacuation and Pedestrian Movements User Manual. Unpublished Work
15. Hoffman, N. A. & Henson, D. A. (1998). Analysis of the Evacuation of a Crush Loaded Train in a Tunnel. In *3rd International Conference on Safety in Road and Rail Tunnels* Nice, France.
16. Wall, J. M. & Waterson, N. P. Predicting Evacuation Times -- A Comparison of the STEPS Simulation Approach with NFPA 130. *Fire Command Studies*, (in press).
17. Hoffman, N. A. & Henson, D. A. (1997). Simulating Transient Evacuation and Pedestrian Movement in Stations. In *3rd International Conference on Mass Transit Management* Kuala Lumpur, Malaysia.
18. Hoffman, N. A. & Henson, D. A. (1997). Simulating Emergency Evacuation in Stations. In *APTA Rapid Transit Conference* Washington, DC: American Public Transit Association.
19. MottMacDonald & ARUP. (2003). Regarding the STEPS Model. Internet Communication
20. Pellissier, E. (2003). Internet Communication
21. *NFPA 130, Standard for Fixed Guideway Transit and Passenger Rail Systems, 2000 Edition* (2000). Quincy, MA: National Fire Protection Association.
22. Klupfel, H. & Meyer-Konig, T. (2003). Characteristics of the PedGo Software for Crowd Movement and Egress Simulation. In *2nd International Conference in Pedestrian and Evacuation Dynamics (PED)* (pp. 331-340). London, U.K.: University of Greenwich.
23. Meyer-Konig, T., Klupfel, H., & Schreckenberg, M. (2001). A microscopic model for simulating mustering and evacuation process onboard passenger ships. In *Proceedings of the International Emergency Management Society Conference* (.).
24. TraffGO product information - PedGo. (2005). Pamphlet
25. TraffGo Product Information - PedGo Editor. (2005). Pamphlet
26. Pedestrian Planning for the Olympic Park Railway Station, Sydney - Transport planning for the Olympic Games (2004). <http://www.arup.com/insite/feature.cfm?featureid=38> [On-line].
27. PAXPORT and PEDROUTE brochures (2004). <http://www.halcrow.com> [On-line].

28. Barton, J. and Leather, J. (1995). Paxport -- Passenger and Crowd Simulation. *Passenger Terminal '95*, 71-77.
29. Buckmann, L. T. & Leather, J. (1994). Modelling Station Congestion the PEDROUTE Way. *Traffic Engineering and Control*, 35, 373-377.
30. Clifford, P. & du Sautoy, C. Pedestrian and Passenger Activity Modeling. Vineyard House, 22 Brook Green, Hammersmith, London, Halcrow Fox. Generic
31. du Sautoy, C. (5-16-2003). Internet Communication
32. Transport Strategies Limited (2004). A Guide to Transport Demand Forecast Models: PEDROUTE & PAXPORT. <http://www.tsl.dircon.co.uk/dempedroute.htm> [On-line].
33. *Simulex Technical Reference, Evacuation Modeling Software* (2001). Integrated Environmental Solutions, Inc. (IES).
34. *Simulex User Manual, Evacuation Modeling Software* (2001). Integrated Environmental Solutions, Inc. (IES).
35. Thompson, P. A. & Marchant, E. W. (1994). Simulex; Developing New Computer Modelling Techniques for Evaluation. In *Fire Safety Science -- Proceedings of the 4th International Symposium* (pp. 613-624).
36. Thompson, P. A. & Marchant, E. W. (1995). A Computer Model for the Evacuation of Large Building Populations. *Fire Safety Journal*, 24, 131-148.
37. Thompson, P. A. (1995). *Developing New Techniques for Modelling Crowd Movement*. PhD Department of Building and Environmental Engineering, University of Edinburgh, Scotland.
38. Thompson, P. A. & Marchant, E. W. (1995). Testing and Application of the Computer Model 'SIMULEX'. *Fire Safety Journal*, 24, 149-166.
39. Thompson, P. A., Wu, J., & Marchant, E. W. (1996). Modelling Evacuation in Multi-storey Buildings with Simulex. *Fire Engineering*, 56, 7-11.
40. Thompson, P. A. (2003). Internet Communication
41. [http://www.ies4d.com/content/default.asp?page=s1\\_2\\_1](http://www.ies4d.com/content/default.asp?page=s1_2_1) (2004). [http://www.ies4d.com/content/default.asp?page=s1\\_2\\_1](http://www.ies4d.com/content/default.asp?page=s1_2_1) [On-line].
42. Gwynne, S., Galea, E. R., Owen, M., & Lawrence, P. (1998). *Further Validation of the building EXODUS Evacuation Model Using the Tsukuba Dataset* (Rep. No. 98/IM/31). London: University of Greenwich.

43. Olsson, P. A. & Regan, M. A. (1998). A Comparison Between Actual and Predicted Evacuation Times. In *Human Behaviour in Fire -- Proceedings of the 1st International Symposium* (pp. 461-468).
44. *NFPA 101, Life Safety Code Handbook* (2000). Quincy, MA: National Fire Protection Association.
45. *Fire safety engineering in buildings. Part 1. Guide to the application of fire safety engineering principles, Draft for development* (1997). (Rep. No. BSI-DD240, ISBN 0-580-27952-9). UK: British Standards Institute (BSI).
46. Bensilum, M. & Purser, D. A. (2002). Gridflow: an object-oriented building evacuation model combining pre-movement and movement behaviours for performance-based design. In *7th International Symposium on Fire Safety Science* Worcester, MA: Worcester Polytechnic Institute.
47. Purser, D. A. (5-14-2003). Internet Communication
48. Schneider, V. (2001). Application of the Individual-Based Evacuation Model ASERI in Designing Safety Concepts. In *2nd International Symposium on Human Behaviour in Fire* (pp. 41-51). Boston, MA.
49. ASERI (Advance Simulation of Evacuation of Real Individuals) A model to simulate evacuation and egress movement based on individual behavioural response (2004). <http://www.ist-net.de> [On-line].
50. Schneider, V. & Konnecke, R. (2001). Simulating Evacuation Processes with ASERI. In *Tagungsband International Conference on Pedestrian Evacuation Dynamics (PED)* Duisburg.
51. Schneider, V. (5-19-2003). Internet Communication
52. Jin, T. (1997). Studies on Human Behavior and Tenability. In *Fire Safety Science - Proceedings of the Fifth International Symposium* (pp. 3-21).
53. Bryan, J. L. (2002). Behavioral Response to Fire and Smoke. In P.J.DiNenno & W. D. Walton (Eds.), *The SFPE Handbook of Fire Protection Engineering* (Third ed., pp. 3-315-3-340). Bethesda, MD: Society of Fire Protection Engineers.
54. Gwynne, S. & Galea, E. R. (2004). *A Review of Methodologies and Critical Appraisal of Computer Models Used in the Simulation of Evacuation from the Built Environment* Bethesda, MD: Society of Fire Protection Engineers.
55. Exodus Introduction (2003). <http://fseg.gre.ac.uk/exodus/> [On-line].
56. Gwynne, S., Galea, E. R., Lawrence, P., & Owen, M. (2001). Simulating Occupant Interaction with Smoke Using buildingEXODUS. In *2nd International Symposium on Human Behaviour in Fire* (pp. 101-110). Boston, MA.

57. Gwynne, S., Galea, E. R., Lawrence, P., & Filippidis, L. (2000). *Modelling Occupant Interaction with Fire Conditions Using the buildingEXODUS Evacuation Model* (Rep. No. 00/IM/54). London: University of Greenwich.
58. Gwynne, S. (2003). Internet Communication
59. Gwynne, S. & Galea, E. R. (2004). *A Review of Methodologies and Critical Appraisal of Computer Models Used in the Simulation of Evacuation from the Built Environment* Bethesda, MD: Society of Fire Protection Engineers.
60. Fruin, J. J. (1987). *Pedestrian Planning and Design*. (Revised Edition ed.) Mobile, AL: Elevator World, Inc.
61. Purser, D. A. (2002). Toxicity Assessment of Combustion Products. In P.J.DiNenno & C. L. Beyler (Eds.), *The SFPE Handbook of Fire Protection Engineering* (Third ed., pp. 2-83-2-171). Bethesda, MD: Society of Fire Protection Engineers.
62. Gwynne, S., Galea, E. R., Owen, M., & Lawrence, P. (1998). *Validation of the buildingEXODUS Evacuation Model* (Rep. No. 98/IM/29). London: University of Greenwich.
63. Levin, B. M. (1988). *EXITT: A Simulation Model of Occupant Decisions and Actions in Residential Fires* (Rep. No. NBSIR 88-3753). Natl. Inst. Stand. Technol.
64. Levin, B. M. (1988). EXITT - A Simulation Model of Occupant Decisions and Actions in Residential Fires. In *Fire Safety Science - Proceedings of the Second International Symposium* (pp. 561-570).
65. Nober, E. H., Pierce, H., Well, A. D., Johnson, C. C., & Clifton, C. (1981). Waking Effectiveness of Household Smoke and Fire Detection Devices. *Fire Journal*, 75, 86-91.
66. Legion International, L. (2003). <http://www.legion.biz/system/research.cfm>.  
<http://www.legion.biz/system/research.cfm> [On-line].
67. Williams, A. (2005). Go with the Flow. *The Architect's Journal*.
68. Kagarlis, M. A. (2004). Movement of an autonomous entity through an environment. WO 2004/023347 A2. Patent
69. Cappuccio, J. (2000). Pathfinder: A Computer-Based Timed Egress Simulation. *Fire Protection Engineering*, 8, 11-12.
70. Caro, A. C. & Miller, J. A. (2002). Computer-Based Exiting Design.  
[http://www.rjagroup.com/rja/ecorner/caro&miller\\_std\\_0702.htm](http://www.rjagroup.com/rja/ecorner/caro&miller_std_0702.htm) [On-line].  
Available: [http://www.rjagroup.com/rja/ecorner/caro&miller\\_std\\_0702.htm](http://www.rjagroup.com/rja/ecorner/caro&miller_std_0702.htm)
71. Cappuccio, J. (4-3-2003). Internet Communication



72. Kendik, E. (1995). Methods of Design for Means of Egress: Towards a Quantitative Comparison of National Code Requirements. In *Fire Safety Science -- Proceedings of the 1st International Symposium* (pp. 497-511).
73. Still, G. K. (2004). VEgAS (Virtual Egress and Analysis System).  
<http://www.crowddynamics.com> [On-line]. Available:  
<http://www.crowddynamics.com>
74. Still, G. K. (2003). Internet Communication
75. [http://www.cibprogram.dbce.csiro.au/program/survey\\_view.cfm?S\\_ID=55](http://www.cibprogram.dbce.csiro.au/program/survey_view.cfm?S_ID=55) (2003).  
[http://www.cibprogram.dbce.csiro.au/program/survey\\_view.cfm?S\\_ID=55](http://www.cibprogram.dbce.csiro.au/program/survey_view.cfm?S_ID=55) [On-line].
76. Jensen, G. (2003). Internet Communication
77. Heskestad, A. W. & Meland, O. J. (1998). Determination of Evacuation Times as a Function of Occupant and Building Characteristics and Performance of Evacuation Measures. In *Human Behaviour in Fire -- Proceedings of the 1st International Symposium* (pp. 673-680).
78. Boyce, K., Fraser-Mitchell, J., & Shields, J. (1998). Survey Analysis and Modelling of Office Evacuation Using the CRISP Model. In T. J. Shields (Ed.), *Human Behaviour in Fire -- Proceedings of the 1st International Symposium* (pp. 691-702).
79. Fraser-Mitchell, J. (2001). Simulated Evacuations of an Airport Terminal Building, Using the CRISP Model. In *2nd International Symposium in Human Behaviour in Fire* (pp. 89-100). Boston, MA.
80. Fraser-Mitchell, J. (2003). 'CRISP' Fire Risk Assessment by Simulation. Presentation given at the University of Greenwich. Generic
81. Fraser-Mitchell, J. (2003). Internet Communication
82. Ketchell, N., Cole, S. S., & Webber, D. M. (1994). The EGRESS Code for Human Movement and Behaviour in Emergency Evacuation. In R.A. Smith & J. F. Dickie (Eds.), *Engineering for Crowd Safety* (pp. 361-370). London: Elsevier.
83. Ketchell, N., Bamford, G. J., & Kandola, B. (1995). Evacuation Modelling: A New Approach. In *ASIAFLAM '95, Proceedings of the 1st International Conference on Fire Science and Engineering* (pp. 499-505).
84. AEA Technology (2002). *A Technical Summary of the AEA EGRESS Code* Warrington, UK: AEA Technology.
85. Lo, S. M., Fang, Z., & Zhi, G. S. (2004). An Evacuation Model: the SGEM package. *Fire Safety Journal*, 169-190.

86. Lo, S. M. & Fang, Z. (2000). A Spatial-Grid Evacuation Model for Buildings. *Journal of Fire Sciences*, 18, 376-394.
87. Ando, K., Ota, H., & Oki, T. (1988). Forecasting the flow of people. *Railway Research Review*, 45, 8-14.
88. Lo, S. M. (2005). Personal Communication
89. Donegan, H. A., Pollock, A. J., & Taylor, I. R. (1994). Egress Complexity of a Building. In *Fire Safety Science -- Proceedings of the 4th International Symposium* (pp. 601-612).
90. Donegan, H. A. & Taylor, I. R. (1998). How Complex is the Egress Capability of your Design? In T. J. Shields (Ed.), *Human Behaviour in Fire, Proceedings of the First International Symposium*.
91. Shannon, C. E. (1948). The Mathematical Theory of Communication. *The Bell System Technical Journal*, 27, 379-423.
92. Fahy, R. F. (1994). EXIT89 -- An Evacuation Model for High-rise Buildings -- Model Description and Example Applications. In *Fire Safety Science -- Proceedings of the 4th International Symposium* (pp. 657-668).
93. Fahy, R. F. (1996). EXIT89 -- High-rise Evacuation Model -- Recent Enhancements and Example Applications. In *Interflam '96, International Interflam Conference -- 7th Proceedings* (pp. 1001-1005). Cambridge, England.
94. Fahy, R. F. (1999). *User's Manual, EXIT89 v 1.01, An Evacuation Model for High-Rise Buildings* Quincy, Ma: National Fire Protection Association.
95. Fahy, R. F. (1999). *Development of an Evacuation Model for High-Rise Buildings, Volume 1 of 2*. DPhil by published works School of the Built Environment, Faculty of Engineering of the University of Ulster.
96. Fahy, R. F. (2001). Verifying the Predictive Capability of EXIT89. In *2nd International Symposium on Human Behaviour in Fire* (pp. 53-63).
97. Fahy, R. F. (5-2-2003). Internet Communication
98. Jones, W. W., Forney, G. P., Peacock, R. D., & Reneke, P. A. (2000). *Technical Reference for CFAST: An Engineering Tool for Estimating Fire and Smoke Transport* (Rep. No. Tech. Note 1431). Natl. Inst. Stand. Technol.
99. Ozel, F. (1985). A Stochastic Computer Simulation of the Behavior of People in Fires: An Environmental Cognitive Approach. In *Proceedings of the International Conference on Building Use and Safety Technology*.

100. Ozel, F. (1991). Simulation of Processes in Buildings as a Factor in the Object Representation of Built Environments. In *Proceedings of Building Simulation '91* (pp. 250-256).
101. Ozel, F. (1993). Computer Simulation of Behavior in Spaces. In R.W.Marans & D. Stokols (Eds.), *Environmental Simulation: Research and Policy Issues* (pp. 191-204). New York: Plenum Press.
102. Ozel, F. (2003). Internet Communication
103. Poon, L. S. (1994). EvacSim: A Simulation Model of Occupants with Behavioural Attributes in Emergency Evacuation of High-Rise Buildings. In *Fire Safety Science -- Proceedings of the 4th International Symposium* (pp. 681-692).
104. Poon, L. S. (4-1-2003). Internet Communication
105. Pauls, J. (1980). Effective-Width Model for Crowd Evacuation Flow in Buildings. In *Proceedings: Engineering Applications Workshop* Boston, MA: Society of Fire Protection Engineers.
106. Takahashi, K., Tanaka, T., & Kose, S. (1988). An Evacuation Model for Use in Fire Safety Designing of Buildings. In *Fire Safety Science -- Proceedings of the 2nd International Symposium* (pp. 551-560).
107. Tanaka, T. (5-12-2003). Internet Communication
108. Gwynne, S. & Galea, E. R. (2004). *A Review of Methodologies and Critical Appraisal of Computer Models Used in the Simulation of Evacuation from the Built Environment* Bethesda, MD: Society of Fire Protection Engineers.
109. Semenko, P. (5-13-2003). Internet Communication
110. Stahl, F. I. (1982). BFIREs-II: A Behavior Based Computer Simulation of Emergency Egress During Fires. *Fire Technology*, 18, 49-65.
111. Stahl, F. I. (1980). *BFIREs/Version 2: Documentation of Program Modifications* (Rep. No. NBSIR 80-1982). Natl. Bur. Stand., (U.S.).
112. Still, G. K. (1993). New Computer System Can Predict Human Behavioural Response During Building Fires. *Fire*, 85, 40-42.
113. Gwynne, S. & Galea, E. R. (2004). *A Review of Methodologies and Critical Appraisal of Computer Models Used in the Simulation of Evacuation from the Built Environment* Bethesda, MD: Society of Fire Protection Engineers.
114. Okazaki, S. & Matsushita, S. (2004). A Study of SIMulation Model for Pedestrian Movement with Evacuation and Queing. <http://www.anc-d.fukui-u.ac.jp/~sat/ECS93.pdf> [On-line].

115. Gwynne, S. & Galea, E. R. (2004). *A Review of Methodologies and Critical Appraisal of Computer Models Used in the Simulation of Evacuation from the Built Environment* Bethesda, MD: Society of Fire Protection Engineers.
116. Reisser-Weston, E. (1996). Simulating Human Behaviour in Emergency Situations. In *RINA, International Conference of Escape, Fire, and Rescue*.
117. Gwynne, S. & Galea, E. R. (2004). *A Review of Methodologies and Critical Appraisal of Computer Models Used in the Simulation of Evacuation from the Built Environment* Bethesda, MD: Society of Fire Protection Engineers.