



A11106 039683

NBSIR 77-1380

NIST
PUBLICATIONS

Experimental Determinations of Temperatures and Power Losses at the Electrical Connections of Some Duplex Receptacles

G. W. Burns
M. G. Scroger
G. A. Evans

Temperature Measurement and Standards Division
National Measurement Laboratory
National Bureau of Standards
Washington, D.C. 20234

and

R. W. Beausoliel
W. J. Meese

Building Thermal and Service Systems Division
Center for Building Technology
National Engineering Laboratory
National Bureau of Standards
Washington, D.C. 20234

April 1978

Final Report

Prepared for
Office of Policy Development and Research
Department of Housing and Urban Development
Washington, D.C. 20410

QC
100
456
77-1380
1978

NBSIR 77-1380

**EXPERIMENTAL DETERMINATIONS
OF TEMPERATURES AND POWER
LOSSES AT THE ELECTRICAL
CONNECTIONS OF SOME DUPLEX
RECEPTACLES**

G. W. Burns
M. G. Scroger
G. A. Evans

Temperature Measurement and Standards Division
National Measurement Laboratory
National Bureau of Standards
Washington, D.C. 20234

and

R. W. Beausoliel
W. J. Meese

Building Thermal and Service Systems Division
Center for Building Technology
National Engineering Laboratory
National Bureau of Standards
Washington, D.C. 20234

April 1978

Final Report

Prepared for
Office of Policy Development and Research
Department of Housing and Urban Development
Washington, D.C. 20410



U.S. DEPARTMENT OF COMMERCE, Juanita M. Kreps, *Secretary*

Dr. Sidney Harman, *Under Secretary*

Jordan J. Baruch, *Assistant Secretary for Science and Technology*

NATIONAL BUREAU OF STANDARDS, Ernest Ambler, *Director*

SI CONVERSION UNITS

In view of the present accepted practice in this country for building technology, common U.S. units of measurement have been used throughout this document. In recognition of the position of the United States as a signatory to the General Conference on Weights and Measures, which gave official status to the metric SI system of units in 1960, assistance is given to the reader interested in making use of the coherent system of SI units by giving conversion factors applicable to U.S. units used in this document.

Length

$$1 \text{ in} = 0.0254^* \text{ meter (m)}$$

Temperature

$$t_{\circ C} = 5/9 (t_{\circ F} - 32)^*$$

Torque

$$1 \text{ lbf in} = 0.113 \text{ newton meter (N m)}$$

*Exactly

EXPERIMENTAL DETERMINATIONS OF THE TEMPERATURES AND POWER LOSSES
AT THE ELECTRICAL CONNECTIONS OF SOME DUPLEX RECEPTACLES

G.W. Burns, M.G. Scroger, G.A. Evans,
R.W. Beausoliel and W.J. Meese

ABSTRACT

The data presented in this report compare the reliability of power loss determinations with the reliability of temperature measurements as a means for determining the quality and adequacy of electrical connections on wiring devices used in branch circuit wiring. The basic premise for the tests presented here is that in the laboratory the determination of power loss is easier, quicker and not nearly as dependent on environmental factors as temperature. This research indicates that, if power loss at a specific current level does not exceed some set value(s), temperatures will not be excessive.

This investigation also illustrates the overheating problems associated with copper-wire electrical connections. No. 14 copper wire connections frequently showed significant rises in temperatures and significantly increased power losses when tightened to a torque of only 2 lbf·in, as compared to nominally tight connections (6 lbf·in or more).

Key words: Branch circuits; duplex receptacles; electrical connections; power loss; temperatures; thermocouples; wire.

TABLE OF CONTENTS

	PAGE
ABSTRACT.....	iv
1. INTRODUCTION.....	1
1.1 Background.....	1
1.2 Objective.....	1
1.3 Scope.....	1
2. ELECTRICAL RECEPTACLES USED IN TESTS.....	2
3. TEST PROCEDURES.....	4
3.1 Mounting of Receptacles.....	4
3.2 Electrical Connections to Receptacles.....	4
3.3 Measurement of Connection Power Losses.....	6
3.4 Measurement of Connection Temperatures.....	8
3.5 Tests Performed.....	10
3.6 Acquisition of Test Data.....	13
3.7 Reduction of Test Data.....	13
4. RESULTS OF TESTS WITH CONVENTIONAL RECEPTACLES.....	15
4.1 Group Receptacle Tests.....	15
4.2 Individual Receptacle Tests.....	17
5. RESULTS OF TESTS WITH SPLIT-BEAM RECEPTACLES.....	18
6. SOME HIGHLIGHTS OF RESULTS.....	19
7. CONCLUSIONS.....	20
8. RECOMMENDATIONS.....	21
9. REFERENCES.....	21

1. INTRODUCTION

Considerable difficulty was experienced in the evaluation of innovative electrical connections submitted as a part of the housing service systems in Operation BREAKTHROUGH. This was due to a lack of performance criteria for their acceptance. Subsequently, the U.S. Department of Housing and Urban Development sponsored a long-term research project on the evaluation of innovative electrical connections proposed for use in residential branch circuit wiring at the National Bureau of Standards (NBS). The first three publications of this project were reports on "Analysis of Current Technology on Electrical Connections in Residential Branch Circuit Wiring" [1], "A Preliminary Approach to Performance Criteria for Electrical Connections in Residential Branch Circuit Wiring" [2], and "Explanatory Study of Glowing Electrical Connections"[3]. This report involving temperature measurements and power loss determinations at the electrical connections of some duplex receptacles is the fourth in this project.

The investigation presented in this report was carried out by the Temperature Section, Heat Division, NBS, for the Building Services Section, Center for Building Technology, NBS.

1.1 BACKGROUND

A safety requirement for residential branch circuit electrical connections and wiring devices is that temperatures measured near connections must not be excessive. These measured temperatures, however, are only an indirect measure of the quality of the connection. Temperatures near connections also involve other factors such as ambient conditions, heat generated by the wire and other conducting components, heat transfer parameters, air movement in the vicinity of the device or connection, geometry of the device and connections, materials, and locations where temperatures are measured. Determination of the power loss in connections or devices appeared to be a more basic and direct means of detecting the potential for obtaining excessive temperatures.

1.2 OBJECTIVE

The primary objective of the work presented in this report was to assess the reliability of power loss data as a means for determining the quality and adequacy of electrical connections used in residential branch circuit wiring.

1.3 SCOPE

Power loss and temperature data were obtained for the wire terminations of a number of wire binding screw duplex receptacle terminations; the screws were tightened to various torques ranging from 2 to 16 lbf.in.*

*lbf.in = 0.1129848 N.m.

Power loss and temperature data were also obtained on an innovative type of electrical receptacle, referred to subsequently as a "split-beam" receptacle.

The influence of environmental factors on the data, such as the spacing between the test receptacles (representing different conditions of heat dissipation) was determined. A current of nominally 15 amperes was passed through the terminal connections of the devices during the tests. In order to determine any effects of supply voltage on the data, tests were performed using nominal 115 volt and 10 volt, 60 Hertz alternating current and using nominal 10 volt direct current. Nonmetallic-sheathed cable with #14 AWG copper conductors was used in all tests.

2. ELECTRICAL RECEPTACLES USED IN TESTS

Eighteen electrical receptacles were used in the tests. All the receptacles were duplex, two-pole, three-wire grounding-type devices rated at either 15 A, 125 V or 20 A, 125 V. The receptacles were of two general types: (1) conventional receptacles having wire-bindingscrew-terminal connections and (2) split-beam (see reference #1) receptacles having innovative electrical connections. There were five types of conventional receptacles and one type of split-beam receptacle. Three identical devices of each type were used. Table 1 gives some descriptive information about the receptacles used in the tests. Table 1 also shows the laboratory identification numbers assigned to the receptacles.

TABLE 1. DESIGNATION AND DESCRIPTION OF ELECTRICAL RECEPTACLES USED IN TESTS^{a/}

Identification Number ^{b/}	General Type	Manufacturer	Current Rating ^{c/} (A)	Terminal Screws ^{d/} Diameter of Head		Push-In Pressure Term
				Material	(in) (mm)	
7 8 9	Split Beam	A	15	e/ e/	e/ e/	No
10 11 12	Conventional	B	20	Brass	11/32 8.7	No
13 14 15	"	C	15	Steel	25/64 9.9	No
16 17 18	"	D	15	Brass	25/64 9.9	Yes
19 20 21	"	B	15	Steel	11/32 8.7	Yes
22 23 24	"	D	15	Brass	25/64 9.9	Yes

a/ All receptacles are of the grounding type. All conventional-type receptacles have wire-binding-screw terminals and circuit-isolating break-off tabs; some conventional-type receptacles also have pressure terminals of the conductor push-in type.

b/ Receptacles in a given horizontal row (e.g., receptacles 10, 11, and 12) are identical devices.

c/ Voltage rating of all receptacles is 125 V.

d/ All screws are binding-head type, No. 8-32.

e/ Not applicable; receptacles have innovative electrical connectors.

3. TEST PROCEDURES

3.1 MOUNTING OF RECEPTACLES

The test setup is illustrated schematically in Figure 1. The receptacles were mounted on a test stand that was clamped to the top of a laboratory work bench. The test stand consisted of forty-five pressed-steel outlet boxes (2 x 2 x 3 in) ganged and fastened to a 1 x 6-in pine board that was supported with wooden braces. The backs of the boxes were flush against the 1 x 6 in board and were perpendicular to the plane of the bench top. The mid-points of the boxes were located about 58 inches above the floor.

The conventional receptacles were installed in the outlet boxes by their mounting yokes and were oriented with their ground-pin slots positioned at the bottom. Since the split-beam receptacles do not require a separate box, they were fastened with wood screws along the top edge of the 1 x 6-in pine board so that all sides of the devices were completely exposed. They were oriented with their backs perpendicular to the plane of the bench top and with their ground-pin slots positioned at the bottom.

The 18 receptacles listed in Table 1 were divided into two groups for the tests. The two groups of receptacles, identified as groups 1 and 2 in this report, were mounted at the same time on the test stand, but they were tested separately. Tests with the group 1 receptacles were completed before undertaking tests with the group 2 receptacles. Group 1 consisted of receptacles No. 10, 11, 13, 14, 16, 17, 19, 20, 22, and 23; group 2 consisted of receptacles No. 7, 8, 9, 12, 15, 18, 21, and 24.

3.2 ELECTRICAL CONNECTIONS TO RECEPTACLES

For both groups the receptacle terminals were connected in a circuit, as shown schematically in Figure 1. The connections between the terminals of adjacent conventional receptacles were made with copper conductors, No. 14 AWG, that were taken from type NM (see Reference 4) cable. The interconnecting conductors were 9.75 ± 0.05 in long. The ends of conductors to be connected to wire-binding-screw terminal were carefully prepared. About $7/8$ in of the insulation was stripped away, and the conductor end was formed in a plane to have a 180-degree bend with an inside diameter of 0.21 in. The loops at the conductor ends were formed in a reproducible fashion by bending them on a special wire-forming jig.

The electrical connections to the conventional receptacles were made at the wire-binding-screw terminals, except for receptacles No. 22, 23, and 24. These receptacles had only one screw terminal; the connections were made (both black-wire and white-wire) by using one of the push-in pressure terminals (which were secured by a screw) and the wire-binding-screw terminal. The looped ends of the conductors were fastened to the wire-binding-screw terminals of the devices with the direction of the wire "wrap"

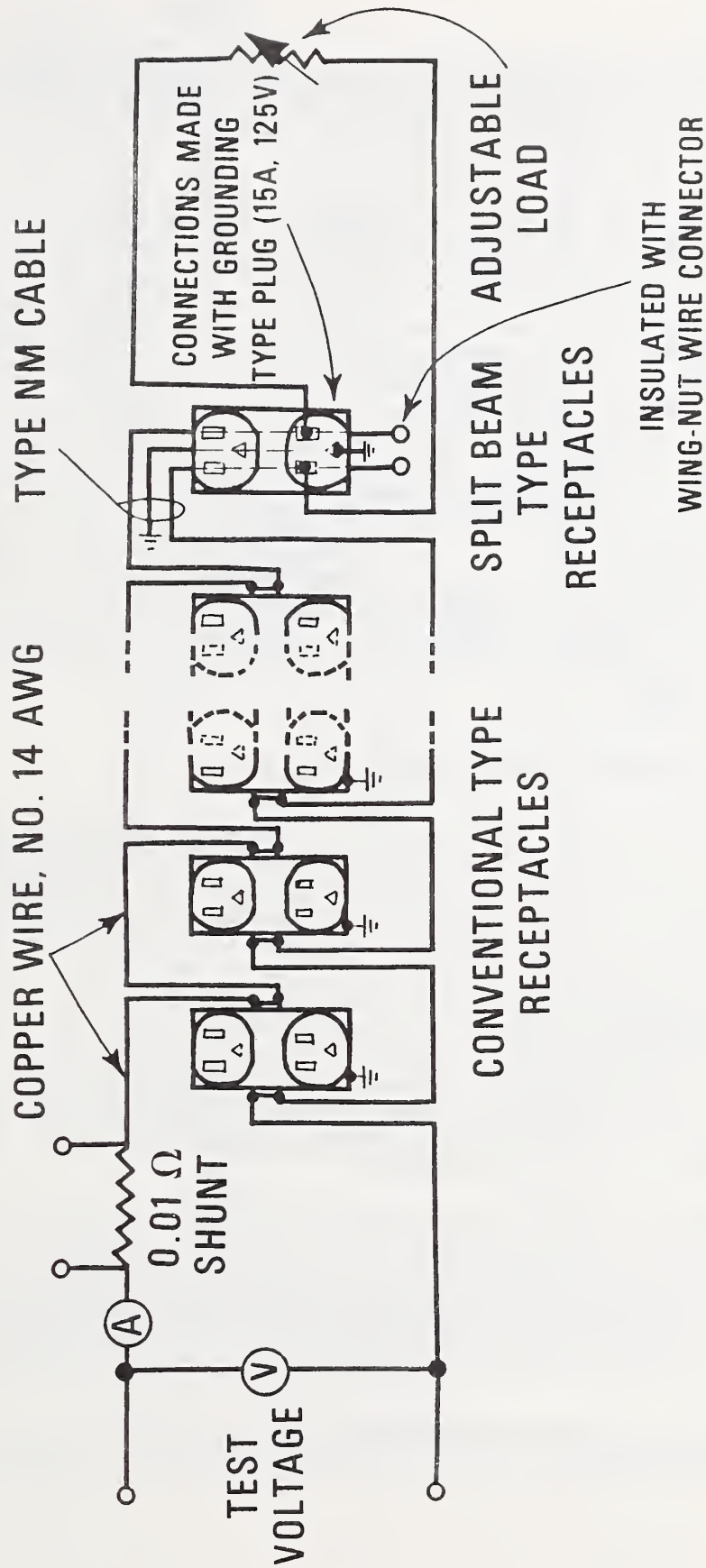

Figure 1. Schematic of test circuit.

corresponding to the direction of terminal-screw tightening, as illustrated in Figure 2. The terminal screws of all receptacles were tightened initially with a torque of 16 lbf·in to seat the looped conductors.

Electrical connections to the three split-beam receptacles (No. 7, 8, and 9) were made with No. 14 AWG, two-conductor, type NM cable. The cable was prepared with the special tool, provided by the manufacturer, that cut the outer sheath and positioned the copper conductors for proper insertion into the innovative terminal connectors of the receptacle assembly. After carefully positioning the prepared cable in the receptacle assembly, the receptacle cover was clamped into place with the special tool, thus making the electrical connections within the device. The end of the nonmetallic-sheathed cable extending from the bottom of the receptacle was cut off, and the exposed conductors were insulated with wing-nut wire connectors, as indicated in Figure 1. In making connections to split-beam type receptacles, the wire is not broken and, therefore, current does not flow through connections except when current flows through the receptacle from an attachment plug. To test this type of receptacle, a grounding type plug rated at 15 A, 125 V was inserted into the bottom outlet of each of the split-beam receptacles, and type NM cable was connected to the plugs to complete the interconnections between the receptacles, and between the last receptacle in the test circuit and the adjustable load, as shown in Figure 1.

3.3 MEASUREMENT OF CONNECTION POWER LOSSES

The power loss across the black-wire (ungrounded) side and across the white-wire (grounded) side of each receptacle was obtained by determining the voltage across input and output wiring near the connections and the current through the connection, and by taking the product of the two determinations. The conventional receptacles have two conductors secured by separate terminal screws, as illustrated in Figure 2. Measurements were of current-carrying paths which consisted of a complex combination of components that included the looped conductor ends, the two terminal screws, the terminal plate, the break-off tab, plus any other electrically conductive receptacle parts between the two terminal screws. In these experiments, the electrical connections of the conventional and split-beam receptacles are defined in terms of the measured electrical parameters, as discussed later in this section.

A calibrated* 0.01 ohm, ac-dc, current shunt was connected in series with the terminal connections of the receptacles, as shown in Figure 1. The current was determined during the tests from measurements of the voltage across the shunt. A high-precision electrodynamicometer ammeter was also included in the test circuit, but it was used only for rough monitoring of the current.

*Calibration performed by the NBS Electricity Division; uncertainty in the value of the resistance of the shunt estimated not to exceed ± 2 microhms.

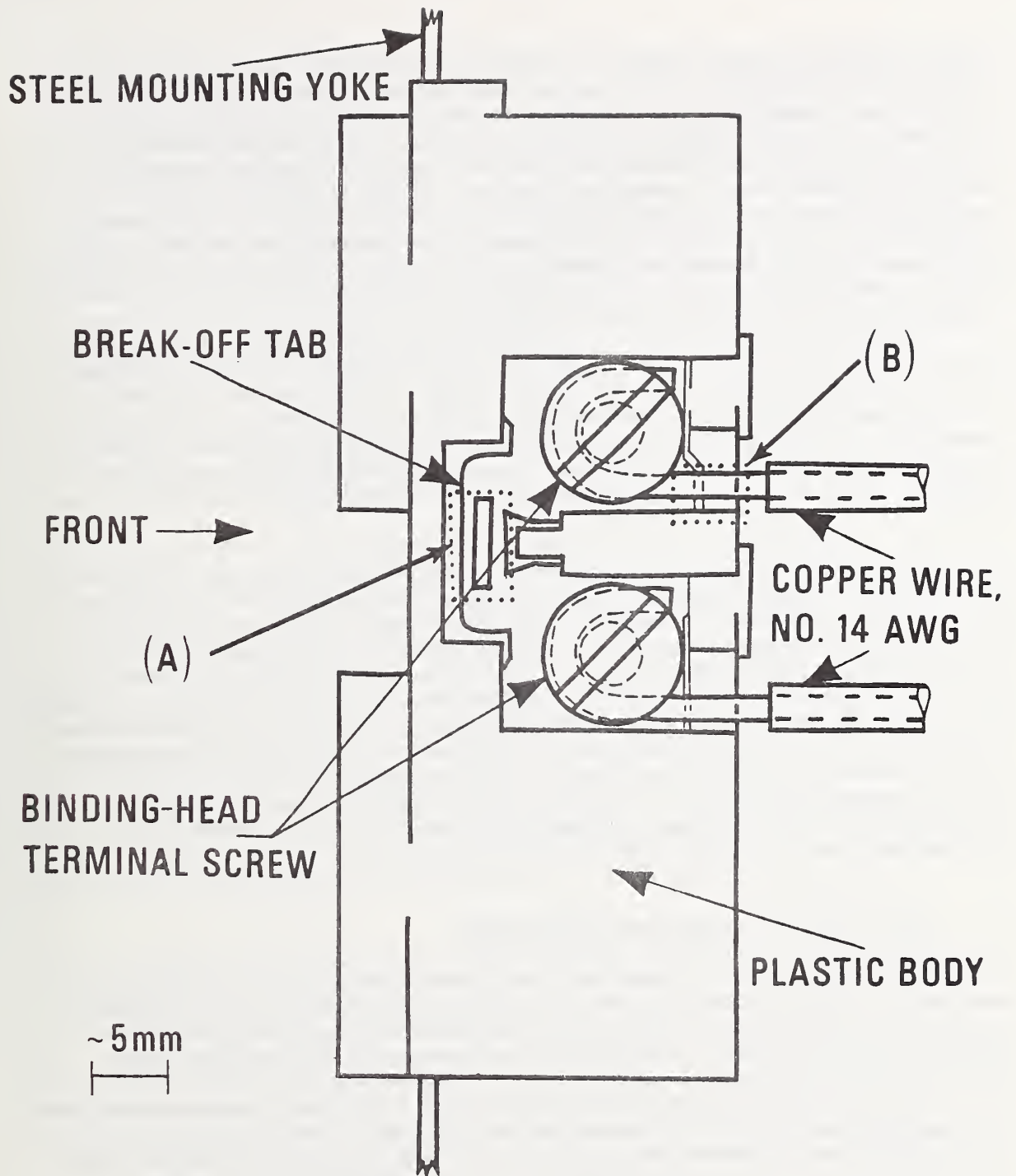

Figure 2. Side view of a conventional receptacle showing electrical connections to black-wire terminal and showing locations where thermocouple measuring junctions were attached for measuring (A) the tab temperature and (B) the wire temperature.

Vinyl insulated copper leads, No. 26 AWG, were attached at various points in the test circuit to obtain the voltages across the connections of the receptacles. The leads were attached in the same manner on both sides (black-wire and white-wire) of the test circuit. For the conventional receptacles, a No. 26 AWG wire was connected at the midpoint of each of the 9.75-in-long copper conductors that were used to make the interconnections between the receptacle terminals. About 1/8 in of the insulation was removed at the midpoints of the conductors, and the No. 26 AWG copper leads were wrapped around the conductors for several turns and were soldered in place with Sn-Pb solder. The solder joints were wrapped with several layers of vinyl plastic electrical tape.

In the case of the split-beam receptacles, the copper leads were attached in the following manner: one wire was soldered to the No. 14 AWG conductor of the type NM cable at a distance of 4 in above the terminal contact, a second wire was attached to the metal terminal parts within the receptacle assembly by soldering with Sn-Pb solder. The attachment was made at a point directly below the bottom outlet, on the metal part that makes contact with the blade of the plug.

Due to the manner in which the voltage leads were located in the test circuit, the measured voltage includes the voltage across the connection plus the voltage across a length of the No. 14 AWG conductor. Therefore, to obtain the voltage across the connection, a correction was applied to the measured voltage. The correction was determined experimentally during each test from measurements of the voltage across several 8-in-long specimens of the No. 14 AWG conductor that were connected in series with the terminal connections. For the conventional receptacles, a correction corresponding to the voltage across an 8-in length of the conductor was subtracted from the measured voltages, and for the split-beam receptacles a correction corresponding to the voltage across a 4-in length of the conductor was subtracted from the measured voltages.

3.4 MEASUREMENT OF CONNECTION TEMPERATURES

The temperatures of the connections were determined with Type K [Ni-10% Cr versus Ni-5% (Al, Si, Mn)] thermocouples fabricated from 0.012-in-diameter nylon and enamel insulated wire. All thermocouples were taken from the same spool (lot) of wire. Representative thermocouples from this spool were calibrated by comparison with a platinum resistance thermometer in the range 70 to 210 °F* and by comparison with a standard Type S thermocouple at temperatures to 300 °F. The uncertainty in the calibration was + 0.2 °F below 210 °F and it increased to + 0.6 °F at 300 °F. The calibration data were fitted with a polynomial equation that was employed for computer calculation of values of temperature from the measured thermocouple voltages. The standard deviation of the fit of a three-term function to 19 data points was 0.11 °F.

*In this report degrees F is defined as $9/5 \times ^\circ\text{C (IPTS-68)} + 32$.

For each of the conventional receptacles, two thermocouples were installed on the black-wire connection, and two themocouples were installed on the white-wire connection. For a given connection, one thermocouple was located on the break-off tab and the other thermocouple was located on the No. 14 AWG copper conductor. The locations where the thermocouple measuring junctions were attached for measuring the tab and wire temperatures are shown in Figure 2. For all connections, the thermocouple used for measuring the wire temperature was located on the top conductor, as shown in Figure 2. In the case of conventional receptacles No. 22, 23, and 24, the thermocouple was located on the conductor connected to the wire-binding-screw terminal for the black-wire connection, but for the white-wire connection the thermocouple was located on the conductor connected to the push-in pressure terminal.

For each of the split-beam receptacles, one thermocouple was installed on the black-wire connection, and one thermocouple was installed on the white-wire connection. On both connections the thermocouple measuring junction was located on the inner terminal contact.

The procedures for fabricating and installing the thermocouples follow. Eight-inch-long thermocouples were cut from the spool of calibrated Type K thermocouple wire, and the measuring junctions of the thermocouples were formed by welding with a tungsten inert gas welder. The thermocouple measuring junctions were then heli-arc welded to the breakoff tabs of the conventional receptacles and to the contacts of the split-beam receptacles (by the NBS Instrument Shops Division.) The break-off tabs of several devices were damaged during the process of installing the thermocouples, thus increasing the electrical resistance of the connection. The tabs were damaged on the white-wire connection of receptacles No. 10, 11, and 16 and on the black-wire connection of receptacles No. 10 and 12. For attachment of the thermocouple measuring junctions on the No. 14 AWG copper conductors, the junctions were first flattened by squeezing with pliers, and then they were affixed to the copper conductor with a drop of Sn-Pb solder.

Cables, made up from No. 30 AWG glass-braid-insulated Type K thermocouple wire, were joined to the 8-inch-long thermocouples by twisting the cable wires and the thermocouple wires together. Vinyl insulated copper leads, No. 26 AWG, were connected to the other end of the cable wires by soldering. The latter connections were maintained at 32 °F (0 °C) in ice baths during the tests. The difference between the emf-temperature relationship of the Type K thermocouple wire used in the cables and that of the calibrated thermocouples was determined experimentally, and a small correction (equivalent to about 0.5 °F) was applied to the measured thermocouple voltages to account for the difference.

The room temperature was also measured during each test with a thermocouple that was taken from the spool of calibrated Type K thermocouple wire. The measuring junction of this thermocouple was positioned directly underneath and near the middle of the test stand. The junction was about 10 in below the center line of the outlet boxes.

3.5 TESTS PERFORMED

Tests were conducted with the group 1 and group 2 receptacles with the devices spaced in the outlet boxes as illustrated in the three setups in Figure 3. In this report the experimental setups 1, 2, and 3 are denoted as receptacle spacings 0, 1, and 2, for purposes of clarity. The spacing numbers correspond to the number of empty outlet boxes between the receptacles.

For each of the receptacle spacings, tests were run with the terminal screws of the conventional receptacles tightened by application of torques of 2, 6, 12, and 16 lbf in. All terminal screw tightening was performed with a variable-torque type screwdriver.

Applied test voltages of nominally 10 V(dc), 10 V(ac), and 115 V(ac) were employed. A schematic of the test voltage circuit is given in Figure 4. A current of nominally 15 A was used in the tests. With a few exceptions, the current was stable during each test to within ± 0.01 A and was adjusted to be within ± 0.1 A of 15 A. Since the measured values of temperature and power loss were found, during preliminary tests, to be virtually independent of the magnitude of the supply voltage, the applied test voltage was not precisely determined or adjusted during the tests. It was measured with a multi-range voltmeter having an estimated uncertainty of about 3 percent of the voltage measured.

The tests were performed in two groups. Data for each test included the receptacle spacing, the screw torque, and the test voltage used, as well as the test current and the room temperature during the test. Unless otherwise noted, the terminal screws of the receptacles were not retightened between subsequent tests. For each combination of receptacle spacing, screw torque, and test voltage, at least two independent tests were performed. After completing the tests with the first group of receptacles, each of the conventional receptacles in that group was tested separately.

There were a number of tests conducted without energizing the test circuit. These tests were performed primarily to check for loose connections in the thermocouple circuits. However, they also provided useful information about the temperature gradients along the group of receptacles. Such tests were usually performed after changing the receptacle spacing and after changing the terminal screw torque.

The polarity of the applied 10 V(dc) test voltage was reversed for some tests. Tests with both polarities were essential in order to eliminate unwanted voltage components included in the measured voltages; namely, the IR drops across the thermocouple measuring junctions and the thermal emf's in the test circuit. The measured voltages determined during a test with forward polarity were combined (by averaging) with those determined during a test with reversed polarity. It should be pointed out that for tests in which alternating current was used, these unwanted voltage components were also present, but they were not read by the measuring instrument.

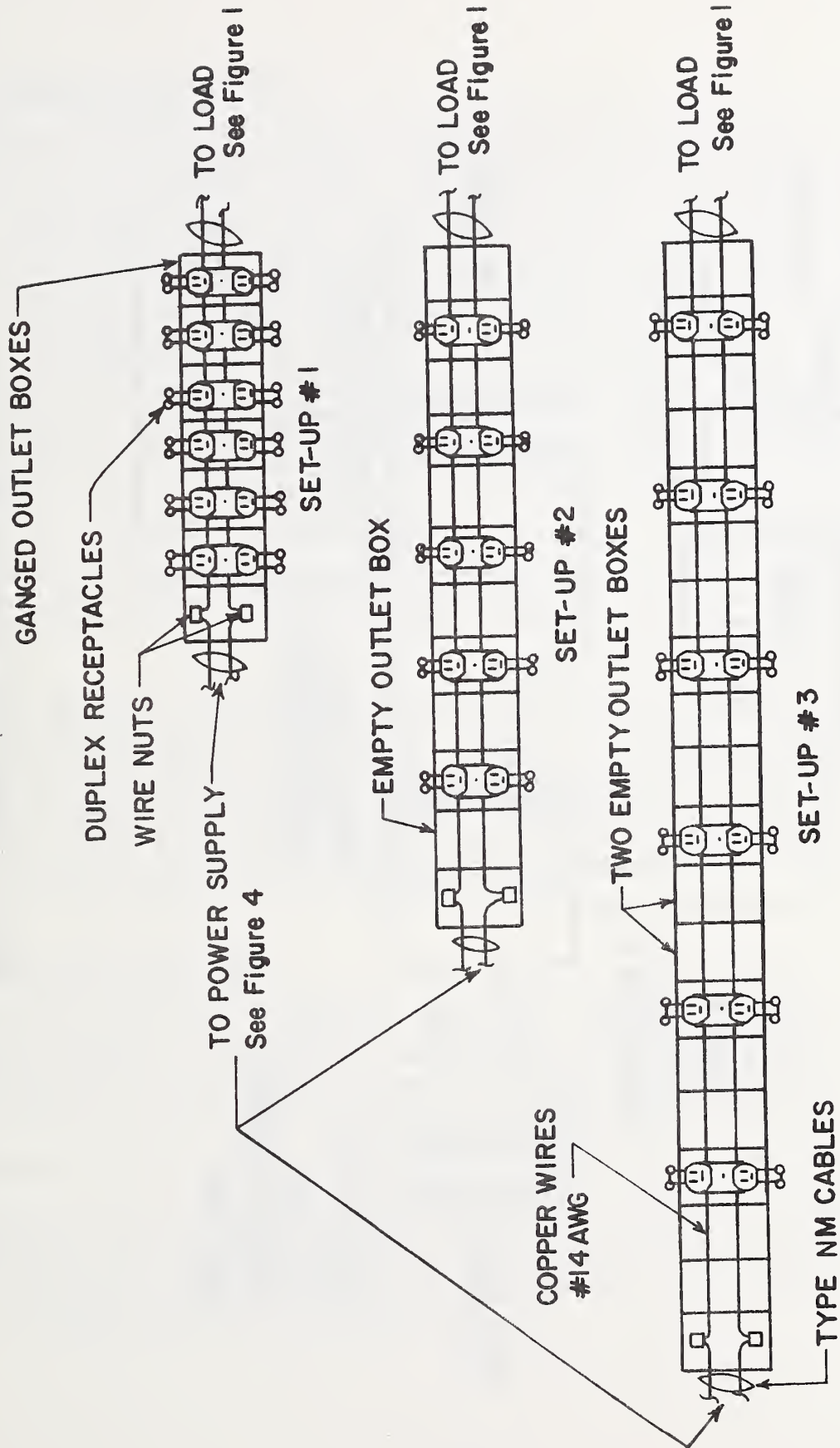

Figure 3. Receptacle spacings.

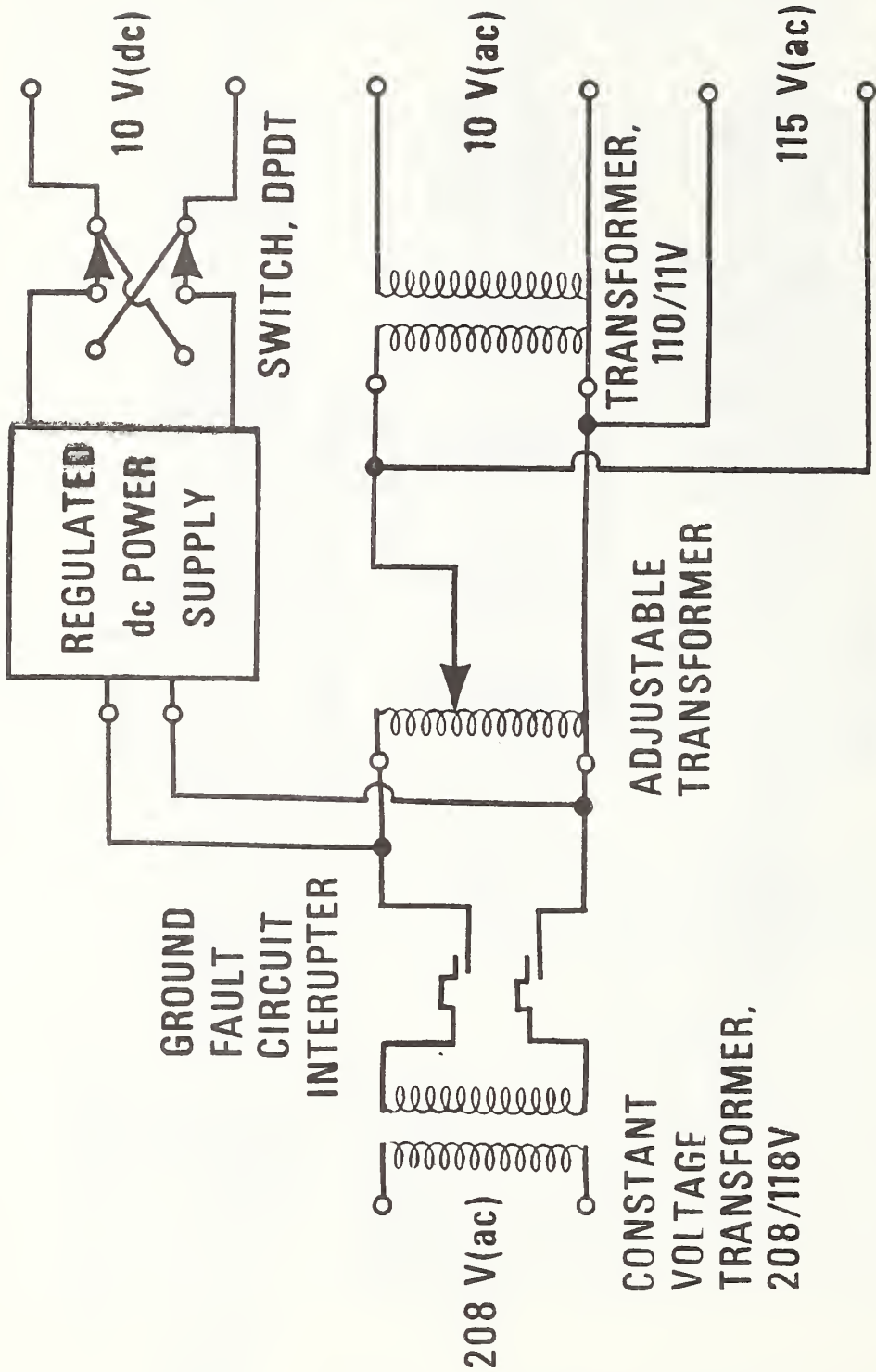

Figure 4. Schematic of test voltage circuit

3.6 ACQUISITION OF TEST DATA

An automatic digital data acquisition system was used for collecting the test data. It included a 72-channel scanner (rotary selector switch), a precision digital voltmeter (PDVM), a minicomputer, and a printer. The PDVM was of commercial design, with 5 full digits plus 60% overranging, and it had 0.1 μV resolution for dc voltage measurements and 10 μV resolution for ac voltage measurements. Its common-mode noise rejection was listed as greater than 160 dB for dc and greater than 140 dB for ac (60 Hz), and its normal-mode noise rejection at 60 Hz was listed as 80 dB, based on maximum filtering. The ac voltage calibration of the PDVM was checked by the Electrical Instruments Section of the NBS Electricity Division. The dc voltage calibration of the PDVM was checked in our laboratory by comparing the PDVM with a precision six-dial potentiometer. The PDVM was operated with a floating input to reduce errors due to common-mode currents. Nevertheless, some noise pickup was evident during the tests, particularly in the case of the ac voltage measurements. Under the conditions of test, the uncertainties in the values of voltage determined with the PDVM are estimated to be not more than \pm (0.003% of the voltage measured + 1 μV) for dc voltages of less than 10 mV; \pm (0.003% of the voltage measured + 10 μV) for dc voltages of greater than 10 mV; and \pm (0.03% of the voltage measured + 150 μV) for ac voltages of less than 1 V. The thermal emf's in the scanner and in the No. 26 AWG copper leads connected to the scanner were less than 1 μV .

The test data were collected by the acquisition system at a rather slow rate to allow sufficient time for the thermal emf's generated at the switch contacts of the scanner to decay. Typically, it took about 6 to 7 minutes to record the voltages on all 72 channels. The system computed the connection temperatures and power losses from the measured voltages and printed a hard copy of the test data after each test. The test data were also recorded on magnetic tape and were eventually transferred into the Univac 1108 computer for reduction and analysis.

3.7 REDUCTION OF TEST DATA

Final data reduction was performed on the Univac 1108 computer. A preliminary examination of the test data sorted out those tests where obvious problems occurred, and excluded the zero power test runs. Then, for each of the remaining tests, the power loss values were normalized for a current of exactly 15 A. This normalization, which requires a small correction,

was done by multiplying the power loss by $\frac{15^2}{I_m^2}$ where I_m , the measured test

current, was within a few hundredths of an ampere of 15 A for the majority of the tests. The temperature rise of the tab (and of the wire) was calculated by taking the difference between the measured tab (wire) temperature and the measured room temperature. The ratio of the temperature rise to the power loss was then calculated for all the tests.

The data were then grouped for analyses in the following manner. For consecutive tests (with the same test parameters of screw torque, receptacle spacing, and test voltage) where the power was on continuously, the values of the power loss, the temperature rise, and the ratio obtained in those tests were treated as a data set, and the average of the values and the standard deviation were computed.

For each of the three test voltages, if there was more than one data set having identical test parameters of screw torque and receptacle spacing, then the average of the average values of those data sets was obtained, the pooled standard deviation of a single measurement was computed, and the maximum and minimum values in the sets were retained. Lastly, for each of the twelve combinations of screw torque and receptacle spacing, a grand average of the data sets was obtained, again retaining the maximum and minimum values.

4. RESULTS OF TESTS WITH CONVENTIONAL RECEPTACLES

4.1 GROUP RECEPTACLE TESTS

The experimental imprecision in determining the values of connection power loss and temperature rise was calculated for each of the test parameter combinations employed in the group 1 and group 2 receptacle tests. When the terminal screws of the receptacles were tightened with a torque of 6 lbf·in or more, the experimental imprecision (one standard deviation) in measured values of the power loss and temperature rise typically ranged from 0.2 to 1 mW and from 0.2 to 0.5 °F, respectively, regardless of the test parameter combination. Comparable imprecision was also obtained in measured values for the split-beam receptacles. However, when the terminal screws of conventional receptacles were tightened at 2 lbf·in, greater variability in measured values occurred for some connections, particularly those of receptacles 10, 11, and 22, as shown later in this section.

The principal results obtained with the conventional receptacles during the group receptacle tests are presented in Figures 5 through 37. Figures 5 through 16 show the average power loss, temperature rise, and ratio for all possible combinations of screw torque and receptacle spacing. For zero receptacle spacing, each data point represents an average result containing data obtained with all three test voltages. Within the precision of these plots (about ± 1.5 °F for the temperature rise and ± 7.5 mW for the power loss), there was no observable difference in the power loss, the temperature rise, or the ratio with test voltage for terminal screw torques greater than 2 lbf·in (see Figs. 5, 8, and 11). At 2 lbf·in (Fig. 14), the large variation shown in some data points reflects the variability in the contact resistance of the connection observed at this torque, as will be discussed later. At the receptacle spacings of 1 and 2, tests were not performed using a test voltage of 10 V(dc), but both 10 V(ac) and 115 V(ac) were used at those spacings.

For terminal screw torques of 6, 12, and 16 lbf·in, the connections of the receptacles that had the damaged break-off tabs clearly exhibited power losses higher than those of the same type receptacles having undamaged tabs (see Figures 5 through 13). The tab temperature rises were not greatly different for the damaged connections, however. The black-wire and white-wire connections of receptacle No. 22 exhibited power losses higher than those observed for the connections of the other two receptacles of the same type, as shown in Figures 5 through 16. The connections for this receptacle were made using one of the push-in pressure terminals, but there is no certain explanation for its behavior. The other two receptacles of the same type showed no such variability. With these exceptions, Figures 5 through 16 show that there is no appreciable difference in the power loss, the temperature rise, or the ratio between the black-wire connections and the white-wire connections for a given type of receptacle. In addition, at high terminal screw torques, there is surprisingly little difference between the measured parameters for the various receptacle types, considering the differences in their design and in the materials used for their terminals.

All the data for zero receptacle spacing (given in Figures 5, 8, 11, and 14) are displayed in Figures 17 through 26 as a function of the terminal screw torque. Each figure displays the power loss, the temperature rise, and the ratio for the three receptacles of the same type, and the black-wire and white-wire connections are given separately. With the exception of the black-wire connection of receptacle No. 22, it can be seen that there is little difference between the values of power loss, temperature rise, and ratio for torques of 6, 12, and 16 lbf·in. At 2 lbf·in nearly all connections show an increase in the power loss and the temperature rise. The increase was especially large for the white-wire connections of receptacles No. 10, 11, and 22 and for the black-wire connection of receptacle No. 22 (see Figs. 18, 25 and 26). Values as large as 3400 mW and 110 °F were observed for the power loss and the tab temperature rise, respectively (see Figure 18).

The power loss, the tab temperature rise, and the ratio are plotted as a function of receptacle spacing in Figures 27 through 31. The data are for one terminal screw torque, 12 lbf·in, and only data obtained in tests using 10 V(ac) are used, in order to have the same bias at each spacing. The receptacles of the same type are grouped together, with data for the black-wire and white-wire connections exhibited. As expected, there is very little change in the power loss with different spacing. However, changes of 10 to 15 °F in the tab temperature rise were observed, with most of the change occurring between the spacings of 0 and 1.

Up to Figure 31, only the tab temperature rise has been displayed. When the terminal screws were tightened with a torque of 6 lbf·in or more, very little difference was observed between values of temperature determined by the tab thermocouple and by the wire thermocouple. Differences between the tab temperature and the wire temperature for the black-wire and white-wire connections of each of the conventional receptacles are shown in Figure 32. The results are for a terminal screw torque of 12 lbf·in and a receptacle spacing of 1, and are from tests that employed a test voltage of 10 V(ac). As can be seen, the tab temperature is about 8 °F higher than the wire temperature for the white-wire connection of receptacle No. 16. This difference most likely occurred because of the damaged break-off tab that existed for that connection. The tab temperature was also slightly higher than the wire temperature for each of the other connections that had damaged tabs; namely, the white-wire connections of receptacles No. 10 and 11, and the black-wire connections of receptacles No. 10 and 12. When the terminal screws of the receptacles were tightened with a torque of 2 lbf·in, larger differences between the tab temperature and the wire temperature were observed, as shown in Figure 33.

The effect of loosening the terminal screws and tightening them again with a torque of 2 lbf·in can be seen in Figures 34 and 35. These figures show the change in the power loss, the tab temperature rise, and the ratio after the second torque. Figure 34 gives the results of loosening the screws, then tightening them again without changing the receptacle spacing. Also, after performing many tests at higher torques, the terminal screws of the receptacles were loosened and again tightened with a torque of 2 lbf·in,

and the receptacles were then moved from a spacing of 2 to a spacing of 0. Figure 35 gives the difference between the data obtained in the subsequent tests and those obtained in earlier tests at the same spacing. As can be seen, some rather large differences in the power loss, the temperature rise, and the ratio occurred for the connections of receptacles No. 10, 11, and 22.

The connections of receptacles No. 10, 11, and 22 exhibited considerable variability in results, when their terminal screws were tightened with a torque of 2 lbf·in (see Figures 14 through 16). Merely cycling the electrical power on and off to these receptacles produced changes in the values of power loss and temperature rise, as shown in Figure 36. This figure gives data obtained in tests using a test voltage of 115 V(ac). The receptacles were mounted in adjacent outlet boxes and were not moved or disturbed in any way between the on-off cycles of the test current. As can be seen, substantial changes are apparent in the power loss and the temperature rise for both connections of receptacle No. 22 and for the white-wire connections of receptacles No. 10 and 11. No consistent pattern with on-off cycling is apparent, although the change in the temperature rise and the change in power loss tended to be in the same direction. The small changes shown in Figure 36 for the black-wire connections of receptacle No. 10 and 11 are typical of the changes observed for the connections of the other receptacles.

There were two series of tests specially performed with the group 1 receptacles to determine the time required to establish thermal equilibrium of the connections after energizing the test circuit. Typical data are given in Figure 37. As can be seen, the time required to establish thermal equilibrium is about 75 minutes when the receptacles are mounted in adjacent outlet boxes. The small increase in the power loss during the first 75 minutes is expected, since the electrical resistance of the connection is temperature dependent. Preliminary tests showed that the time required to establish thermal equilibrium was slightly less than 75 minutes when the receptacles were spaced one or two outlet boxes apart.

4.2 INDIVIDUAL RECEPTACLE TESTS

The results obtained in the individual receptacle tests are compared in Figures 38 and 39 with the results obtained in the group receptacle tests that were conducted with the receptacles spaced two outlet boxes apart. Figure 38 compares the results from tests using a test voltage of 10 V(ac), and Figure 39 compares the results from tests using 115 V(ac). Both figures show the differences between the average values of power loss and tab temperature rise obtained in the individual tests and those obtained in the group receptacle tests for each of the four terminal screw torques. As can be seen, for the screw torques of 6, 12, and 16 lbf·in the differences in the values of power loss and tab temperature rise are less than 50 mW and 3 °F, respectively. For the screw torque of 2 lbf·in, larger differences in the values occurred. Inasmuch as the terminal screws of the devices

were loosened and tightened many times during the individual and group receptacle tests, the differences shown in Figures 38 and 39 provide a good indication of the reproducibility of the test method.

5. RESULTS OF TESTS WITH SPLIT-BEAM RECEPTACLES

Average values of the power loss, the temperature rise, and the ratio obtained for the black-wire and white-wire connections of split-beam receptacles No. 7, 8, and 9 are plotted as a function of the time that the test circuit was energized in Figures 40, 41, and 42, respectively. As can be seen, some unexpected variations in the values of power loss occurred. The largest variations were observed for the white-wire connection of receptacle No. 9 and for the black-wire connection of receptacle No. 8. By comparison, the black-wire connections of receptacles No. 7 and 9 exhibited very little variation in power loss throughout the tests. Some flexing of the Type NM cable undoubtedly occurred when the receptacle spacing was changed. It is suspected that this flexing produced small changes in the contact resistance, thus giving rise to the variations in the values of power loss.

It can be seen in Figures 40 and 41 that during the first 40 hours the values of power loss for the white-wire connection are approximately the same as those for the black-wire connection. However, the values of temperature rise for the white-wire connection are slightly higher than those for the black-wire connection. The explanation for this inconsistency in the results was found during post-test examinations of the receptacles. It was discovered that the thermocouple measuring junction on the black-wire connection of each receptacle was improperly located on the inner terminal contact; the junction had been attached to the wrong side of the contact.

6. SOME HIGHLIGHTS OF RESULTS

- (1) From Figure 37, it can be seen that the approximate maximum power dissipation can be determined immediately after energizing the circuit, but maximum temperature required about 75 minutes to stabilize.
- (2) From Figure 37, it can also be seen that the power loss method is more sensitive than the temperature method in exposing the differences between black-wire connections and white-wire connections.
- (3) From Figures 5, 6, and 7, for receptacles with 16 lbf·in screw torque (and similar runs in Figures 8-16 at lower torques) and respectively 0, 1, 2, outlet-box receptacle spacings, it is seen that temperatures vary by nearly 20 °F as the spacing is increased, while power loss remains relatively constant. This demonstrates that the temperature is affected considerably by the configuration of the test setup, while the power loss measurement is not affected appreciably. Also, see Figures 27-31.
- (4) Figure 32 shows little difference between receptacle tab temperature and wire temperature, while in Figure 33 tab temperature is considerably different than wire temperature. This demonstrates that for loose connections, the temperature of the connection is non-uniform and, therefore, the temperature measured is dependent on the exact location of the thermocouple measuring junction.
- (5) Figures 17 through 29 show that, for #14 copper wire connection with a given receptacle spacing, temperatures and power losses are un-affected if connections are tightened with screw torques of 6 lbf·in or more.
- (6) Figures 14, 15, and 16 show that #14 copper wire connections tightened to a torque of 2 lbf·in frequently tended to overheat. Power loss measurements gave a quicker and clearer indication of poor connection quality than temperature measurements. Power losses were as high as 3400 milliwatts compared to about 200 milliwatts for a number of connections tightened with screw torques of 6 lbf·in or greater. Only when power loss becomes quite high, so that considerable heat is generated, do temperature measurements definitely indicate that there is a problem.

7. CONCLUSIONS

- (1) This research indicates that, if power loss at a specific current level does not exceed some set value(s), temperatures will not be excessive.
- (2) These tests indicate that power-loss data can be reliably employed to assess the quality of electrical connections. Defective or loose connections can be easily detected by such measurements.
- (3) Power loss determinations (and temperature measurements) of electrical connections are virtually independent of supply voltage.
- (4) The primary performance criteria to determine the quality of electrical connections should be a maximum power loss (at some specific current level) rather than a maximum temperature. Power loss provides a reliable method of determining the quality of connection, and
 - (a) measurements can be made almost immediately without waiting for temperature to reach or nearly reach equilibrium;
 - (b) environmental conditions (conditions which affect heat dissipation in the vicinity of the connection) affect power loss determinations much less than they affect temperature measurements;
 - (c) power loss measurements are less affected by placement of sensor and leads than are temperature rise measurements.
- (5) By drawing upon data obtained from this investigation, performance criteria and test procedures based on the power loss concept can be developed to evaluate the quality of electrical connections.
- (6) Copper wire terminations which are not sufficiently tight are likely to overheat. The importance of good electrical connections was illustrated in these tests.

8. RECOMMENDATIONS

- (1) Performance criteria to evaluate the quality and adequacy of electrical connections should be based on the power loss measurement concept.
- (2) Further tests should be conducted to evaluate the method under conditions where the terminal connections become oxidized or corroded. Tests should also be conducted using currents other than 15 A. Other wiring devices, aluminum wire, and other sizes of copper wire, should be used in making additional tests.
- (3) Power losses and associated temperature rises should be determined for wire terminations and other electrical connections installed in thermally insulated wall sections that comply with energy conservation standards.
- (4) Power loss criteria should be used to limit the losses of electrical connections and other wiring components for energy conservation purposes, as well as for fire safety purposes.
- (5) A portable instrumentation package should be developed for field use to measure the quality of electrical connections. This instrument could also be used to determine the power losses of other branch circuit wiring components for energy conservation purposes.

9. REFERENCES

1. Analysis of Current Technology on Electrical Connections Used in Residential Branch Circuit Wiring, Building Science Series 63, National Bureau of Standards, William J. Meese and Ramon L. Cilimberg, March 1975.
2. A Preliminary Approach to Performance Requirements and Criteria for Electrical Connections in Residential Branch Circuit Wiring, NBSIR 75-672, National Bureau of Standards, William J. Meese, Ramon L. Cilimberg, and Adolfo A. Camacho, March 1975.
3. Exploratory Study of Glowing Electrical Connections, Building Science Series 103, National Bureau of Standards, William J. Meese and Robert W. Beausoliel, October 1977.
4. National Electrical Code, 1975 edition, NFPA #70-75, ANSI, CI 1975, published by National Fire Protection Association.

{ SCREW TORQUE = 16 lbf·in }
 { RECEPTACLE SPACING = 0 }

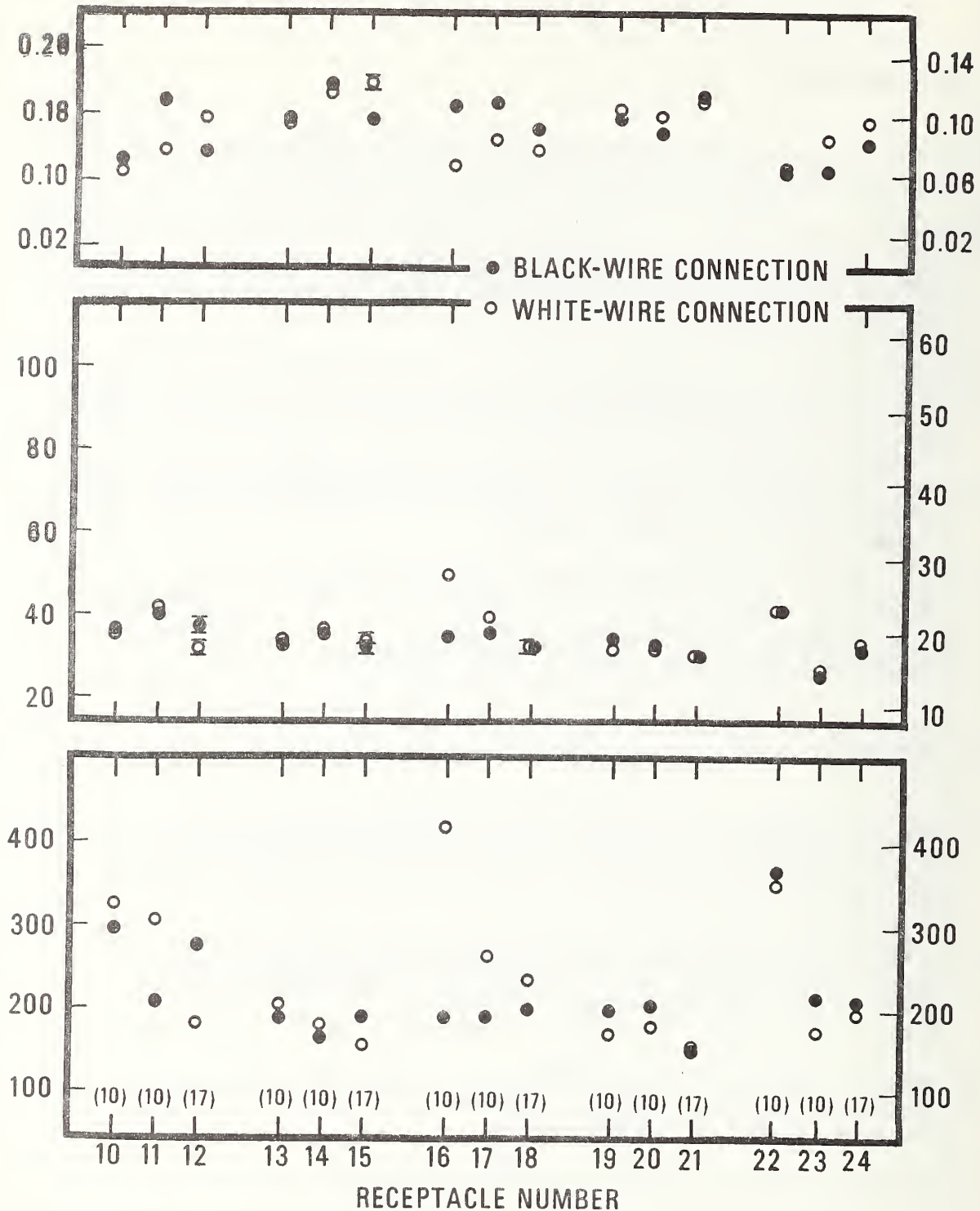

Figure 5. Values of the power loss, the tab temperature rise, and the ratio of the tab temperature rise to the power loss obtained for the black-wire and white-wire connections of the conventional receptacles during group receptacle tests: receptacles installed in adjacent outlet boxes, terminal screws tightened with a torque of 16 lbf·in. The values plotted are averages of values determined in tests employing test voltages of 10 V(dc), 10 V(ac), and 115 V(ac). The figures in parentheses indicate the number of tests used in computing the averages. The bars give the range of the values. The symbol heights are equivalent to about 15 mW, 3 °F, and 0.015 °F/mW for the power loss, the temperature rise, and the ratio, respectively.

{ SCREW TORQUE = 16 lbf · in }
 { RECEPTACLE SPACING = 1 }

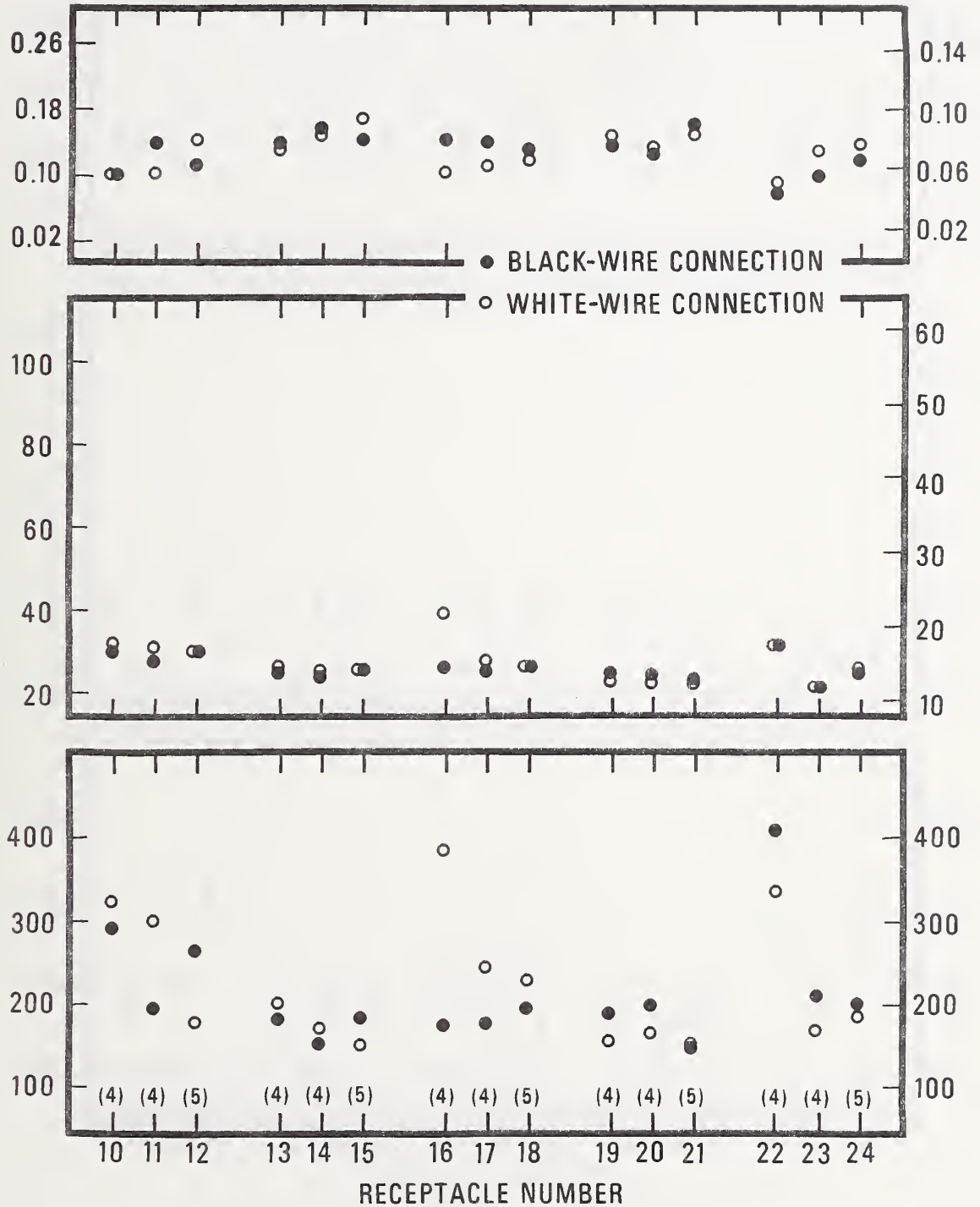

Figure 6. Values of the power loss, the tab temperature rise, and the ratio of the tab temperature rise to the power loss obtained for the black-wire and white-wire connections of the conventional receptacles during group receptacle tests: receptacles spaced one outlet box apart, terminal screws tightened with a torque of 16 lbf · in. The values plotted are averages of values determined in tests employing test voltages of 10 V(ac) and 115 V(ac). The figures in parentheses indicate the number of tests used in computing the averages. The range of the values was less than the symbol heights, which are equivalent to about 15 mW, 3 °F, and 0.015 °F/mW for the power loss, the temperature rise, and the ratio, respectively.

{ SCREW TORQUE = 16 lbf·in }
 { RECEPTACLE SPACING = 2 }

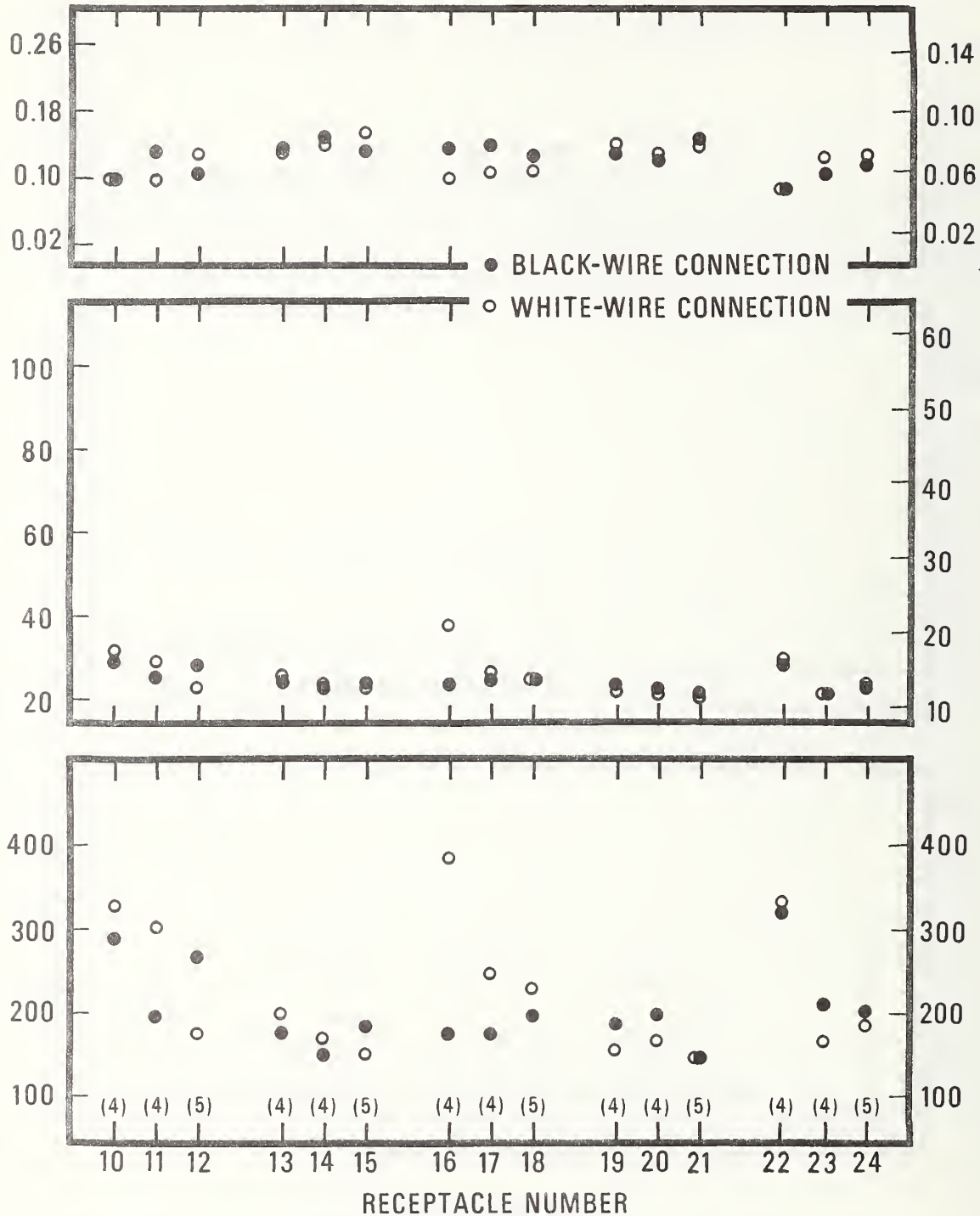

Figure 7. Values of the power loss, the tab temperature rise, and the ratio of the tab temperature rise to the power loss obtained for the black-wire and white-wire connections of the conventional receptacles during group receptacle tests: receptacles spaced two outlet boxes apart, terminal screws tightened with a torque of 16 lbf·in. The values plotted are averages of values determined in tests employing test voltages of 10 V(ac) and 115 V(ac). The figures in parentheses indicate the number of tests used in computing the averages. The range of the values was less than the symbol heights, which are equivalent to about 15 mW, 3 °F, and 0.015 °F/mW for the power loss, the temperature rise, and the ratio, respectively.

{ SCREW TORQUE = 12 lbf·in }
 { RECEPTACLE SPACING = 0 }

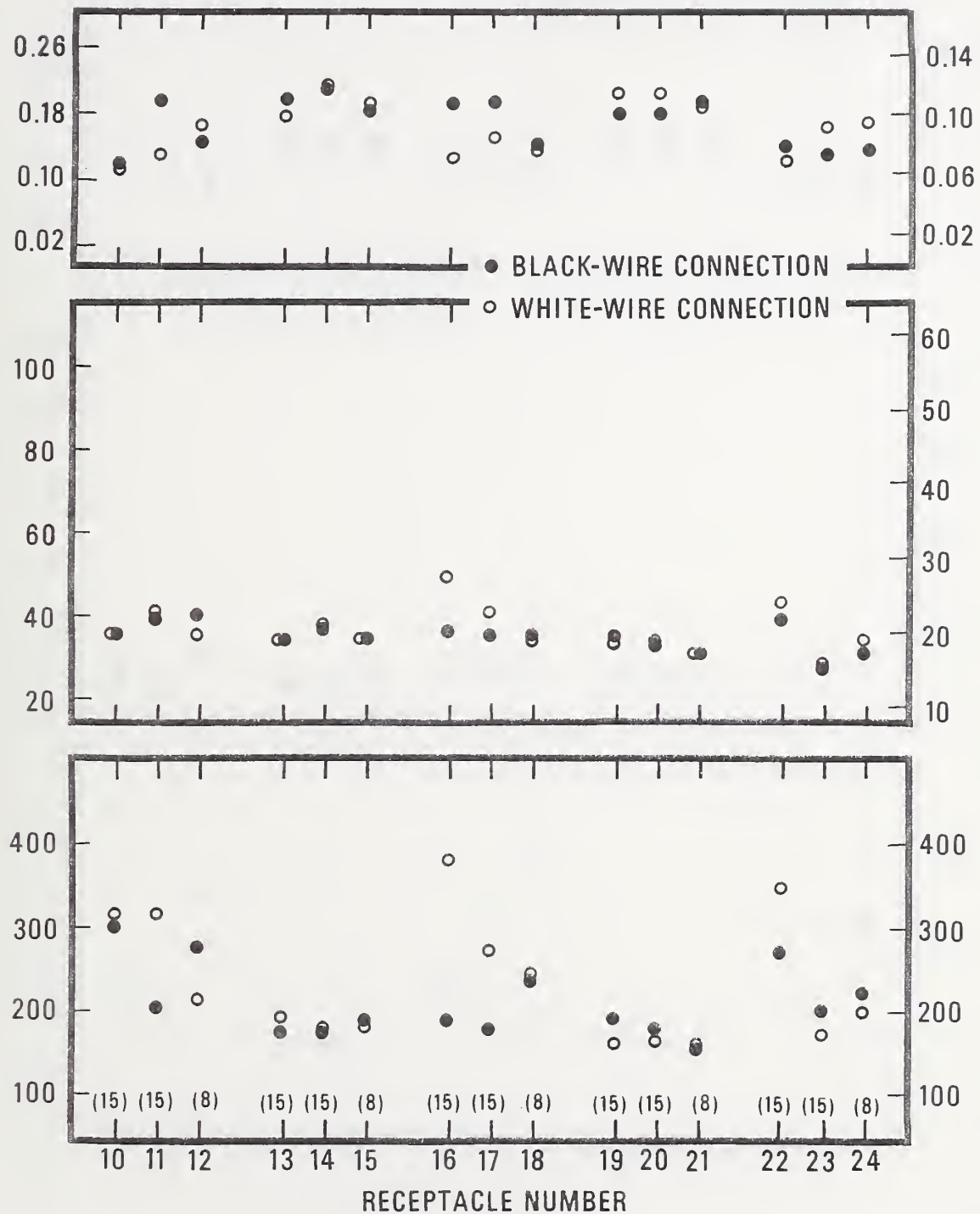

Figure 8. Values of the power loss, the tab temperature rise, and the ratio of the tab temperature rise to the power loss obtained for the black-wire and white-wire connections of the conventional receptacles during group receptacle tests: receptacles installed in adjacent outlet boxes, terminal screws tightened with a torque of 12 lbf·in. The values plotted are averages of values determined in tests employing test voltages of 10 V(dc), 10 V(ac), and 115 V(ac). The figures in parentheses indicate the number of tests used in computing the averages. The range of the values was less than the symbol heights, which are equivalent to about 15 mW, 3 °F, and 0.015 °F/mW for the power loss, the temperature rise, and the ratio, respectively.

{ SCREW TORQUE = 12 lbf·in }
 { RECEPTACLE SPACING = 1 }

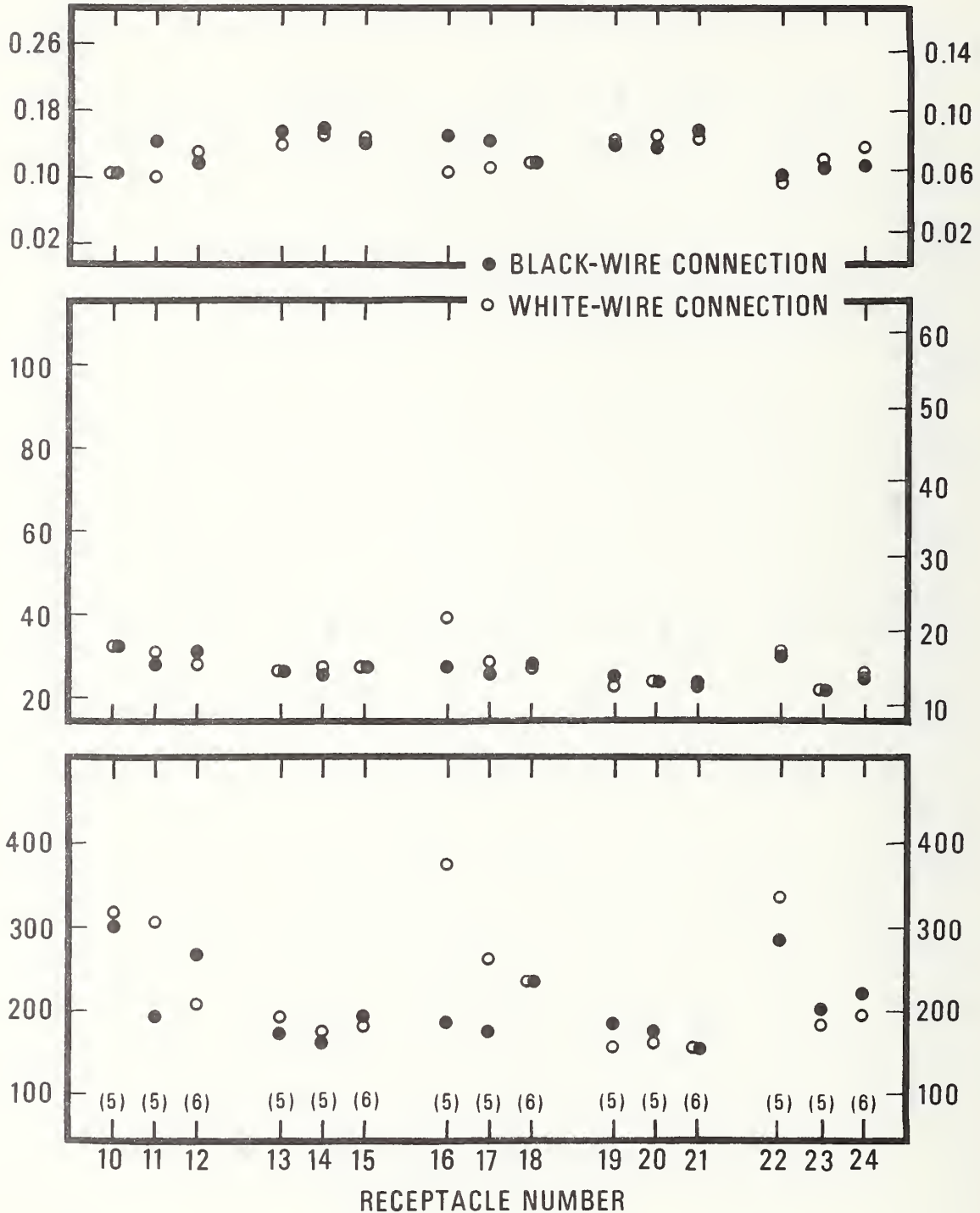

Figure 9. Values of the power loss, the tab temperature rise, and the ratio of the tab temperature rise to the power loss obtained for the black-wire and white-wire connections of the conventional receptacles during group receptacle tests: receptacles spaced one outlet box apart, terminal screws tightened with a torque of 12 lbf·in. The values plotted are averages of values determined in tests employing test voltages of 10 V(ac) and 115 V(ac). The figures in parentheses indicate the number of tests used in computing the averages. The range of the values was less than the symbol heights, which are equivalent to about 15 mW, 3 °F, and 0.015 °F/mW for the power loss, the temperature rise, and the ratio, respectively.

{ SCREW TORQUE = 12 lbf·in }
 { RECEPTACLE SPACING = 2 }

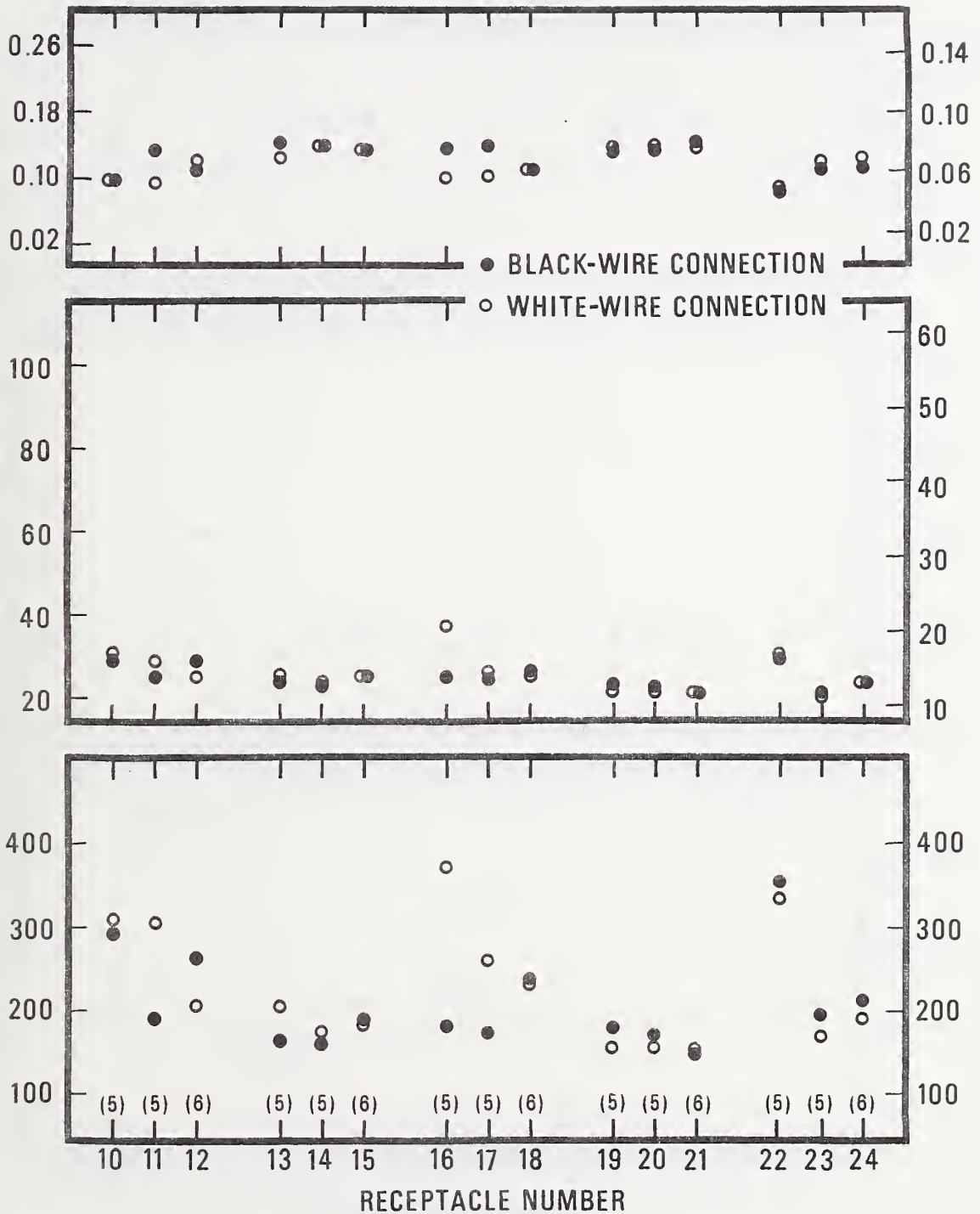

Figure 10. Values of the power loss, the tab temperature rise, and the ratio of the tab temperature rise to the power loss obtained for the black-wire and white-wire connections of the conventional receptacles during group receptacle tests: receptacles spaced two outlet boxes apart, terminal screws tightened with a torque of 12 lbf·in. The values plotted are averages of values determined in tests employing test voltages of 10 V(ac) and 115 V(ac). The figures in parentheses indicate the number of tests used in computing the averages. The range of the values was less than the symbol heights, which are equivalent to about 15 mW, 3 °F, and 0.015 °F/mW for the power loss, the temperature rise, and the ratio, respectively.

{ SCREW TORQUE = 6 lbf·in }
 { RECEPTACLE SPACING = 0 }

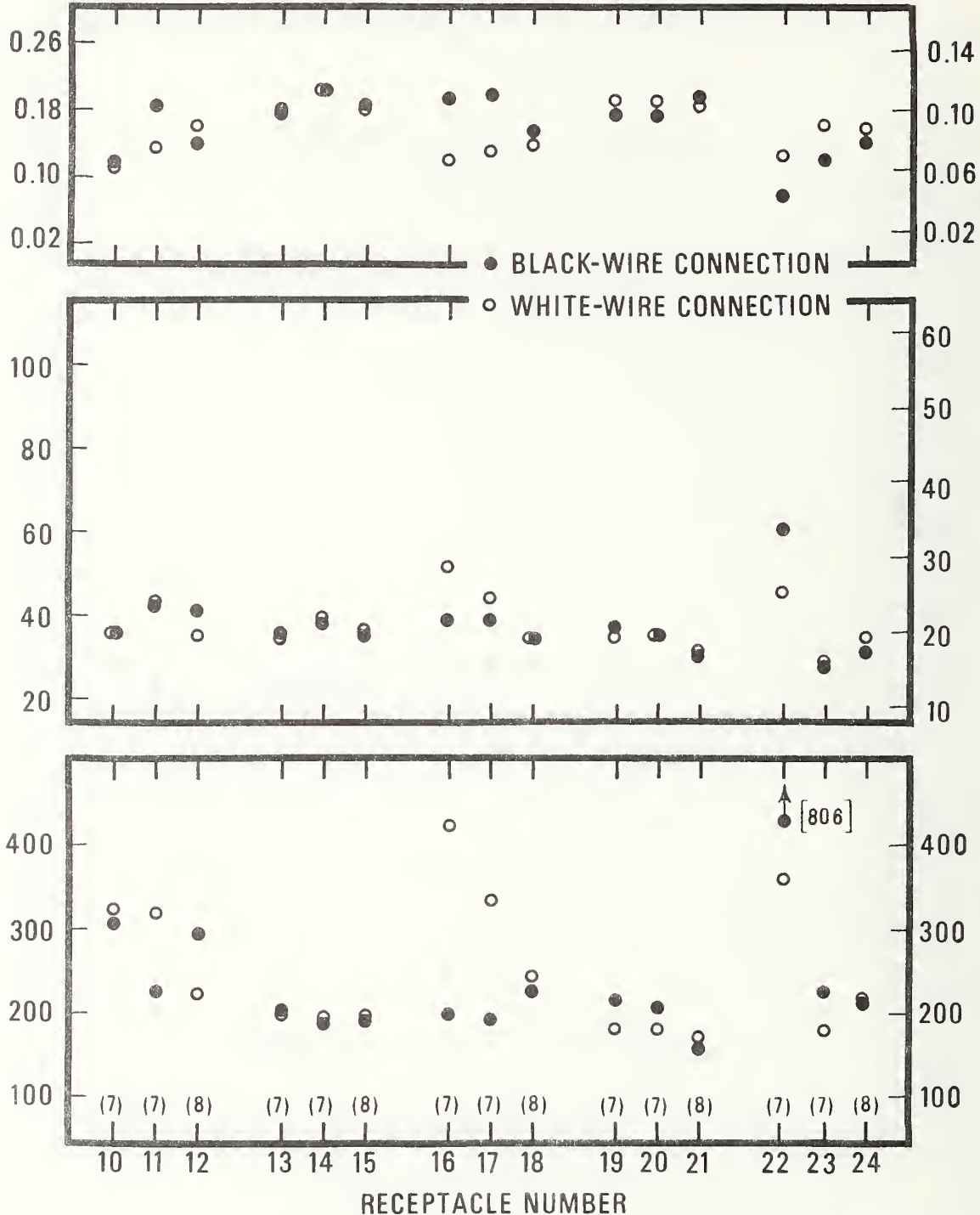

Figure 11. Values of the power loss, the tab temperature rise, and the ratio of the tab temperature rise to the power loss obtained for the black-wire and white-wire connections of the conventional receptacles during group receptacle tests: receptacles installed in adjacent outlet boxes, terminal screws tightened with a torque of 6 lbf·in. The values plotted are averages of values determined in tests employing test voltages of 10 V(dc), 10 V(ac), and 115 V(ac). The figures in parentheses indicate the number of tests used in computing the averages. The range of the values was less than the symbol heights, which are equivalent to about 15 mW, 3°F, and 0.015 °F/mW for the power loss, the temperature rise, and the ratio, respectively.

{ SCREW TORQUE = 6 lbf·in }
 { RECEPTACLE SPACING = 1 }

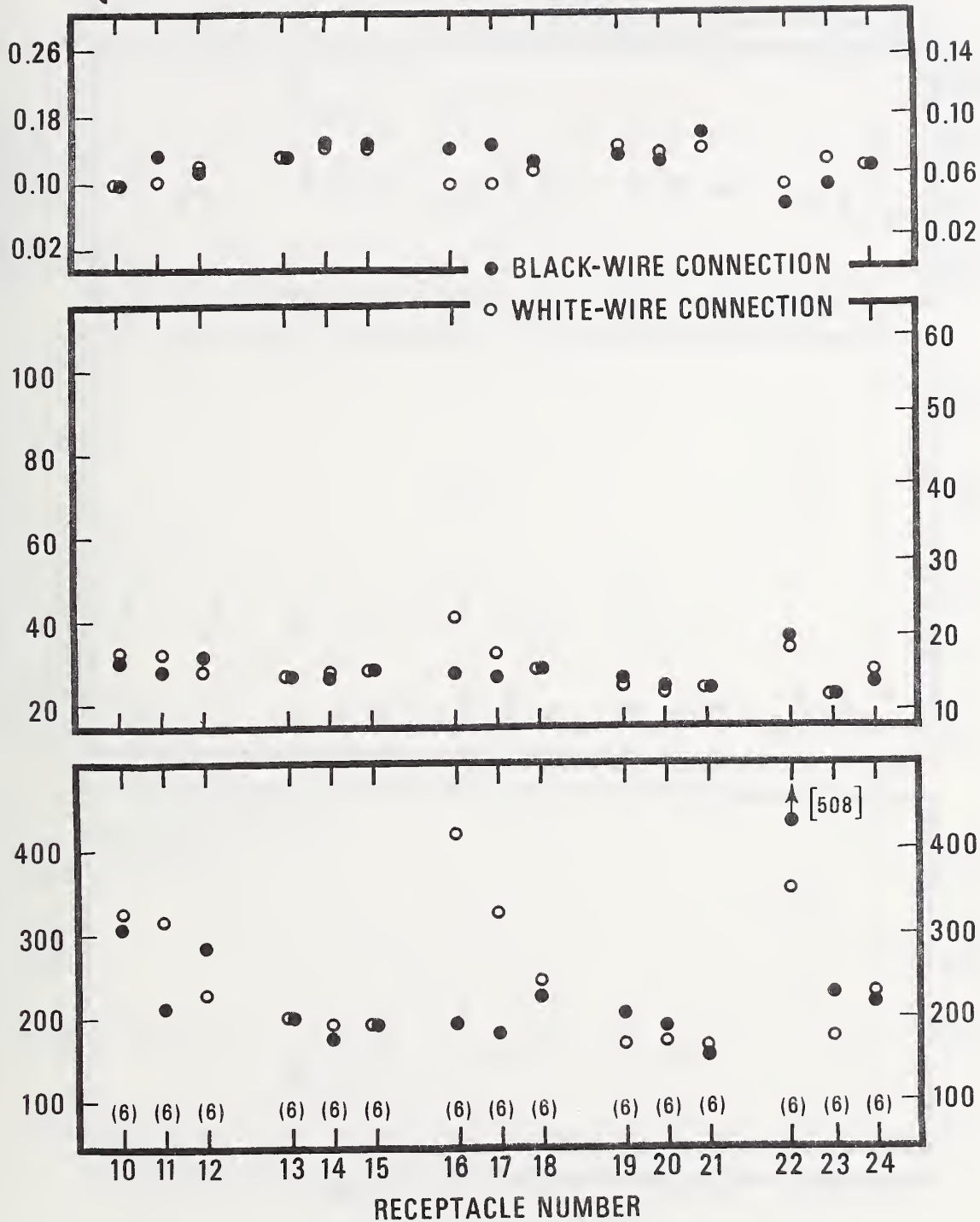

Figure 12. Values of the power loss, the tab temperature rise, and the ratio of the tab temperature rise to the power loss obtained for the black-wire and white-wire connections of the conventional receptacles during group receptacle tests: receptacles spaced one outlet box apart, terminal screws tightened with a torque of 6 lbf·in. The values plotted are averages of values determined in tests employing test voltages of 10 V(ac) and 115 V(ac). The figures in parentheses indicate the number of tests used in computing the averages. The range of the values was less than the symbol heights, which are equivalent to about 15 mW, 3 °F, and 0.015 °F/mW for the power loss, the temperature rise, and the ratio, respectively.

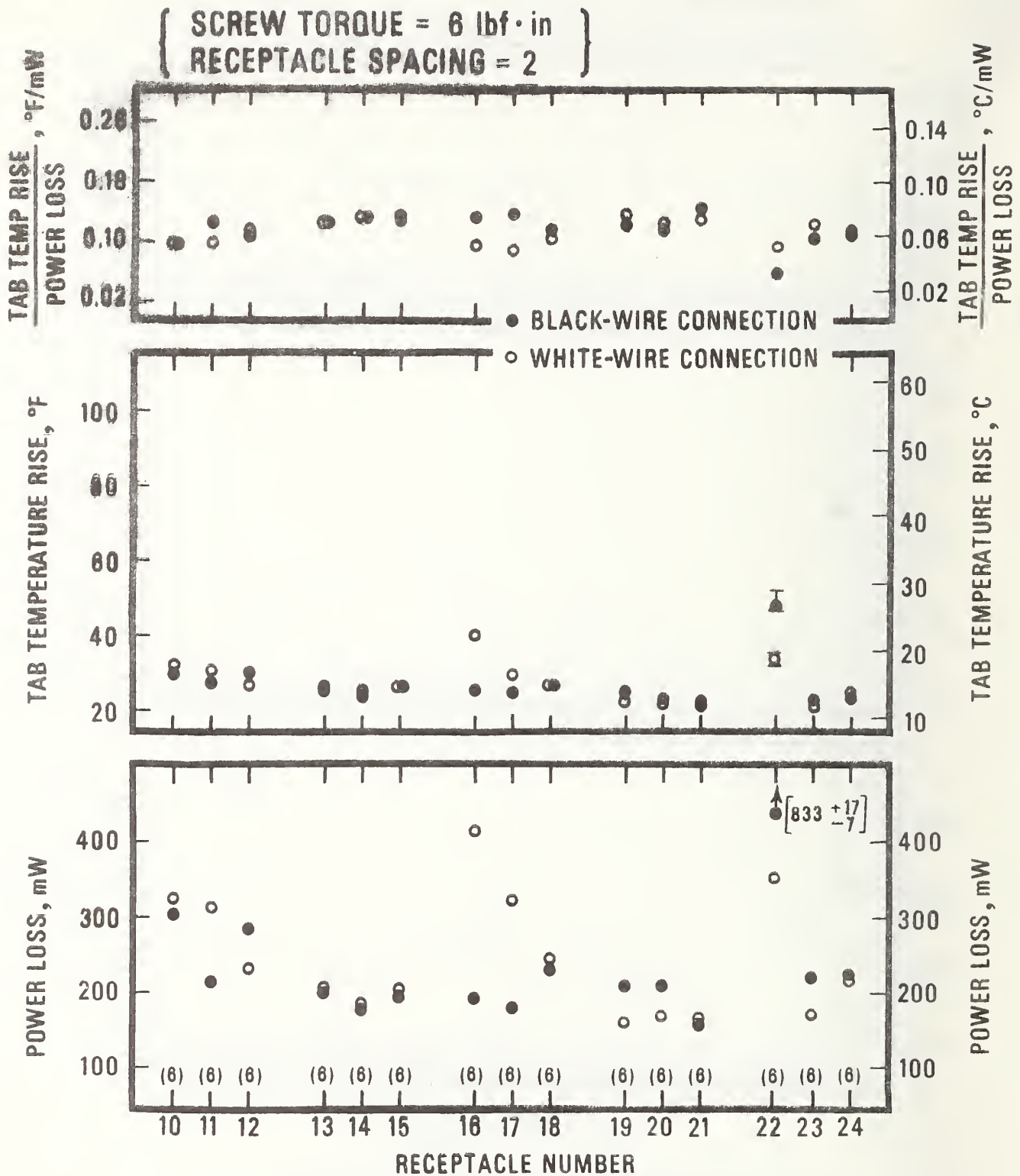

Figure 13. Values of the power loss, the tab temperature rise, and the ratio of the tab temperature rise to the power loss obtained for the black-wire and white-wire connections of the conventional receptacles during group receptacle tests: receptacles spaced two outlet boxes apart, terminal screws tightened with a torque of 6 lbf·in. The values plotted are averages of values determined in tests employing test voltages of 10 V(ac) and 115 V(ac). The figures in parentheses indicate the number of tests used in computing the averages. The bars give the range of the values. The symbol heights are equivalent to about 15 mW, 3 °F, and 0.015 °F/mW for the power loss, the temperature rise, and the ratio, respectively.

{ SCREW TORQUE = 2 lbf·in
RECEPTACLE SPACING = 0 }

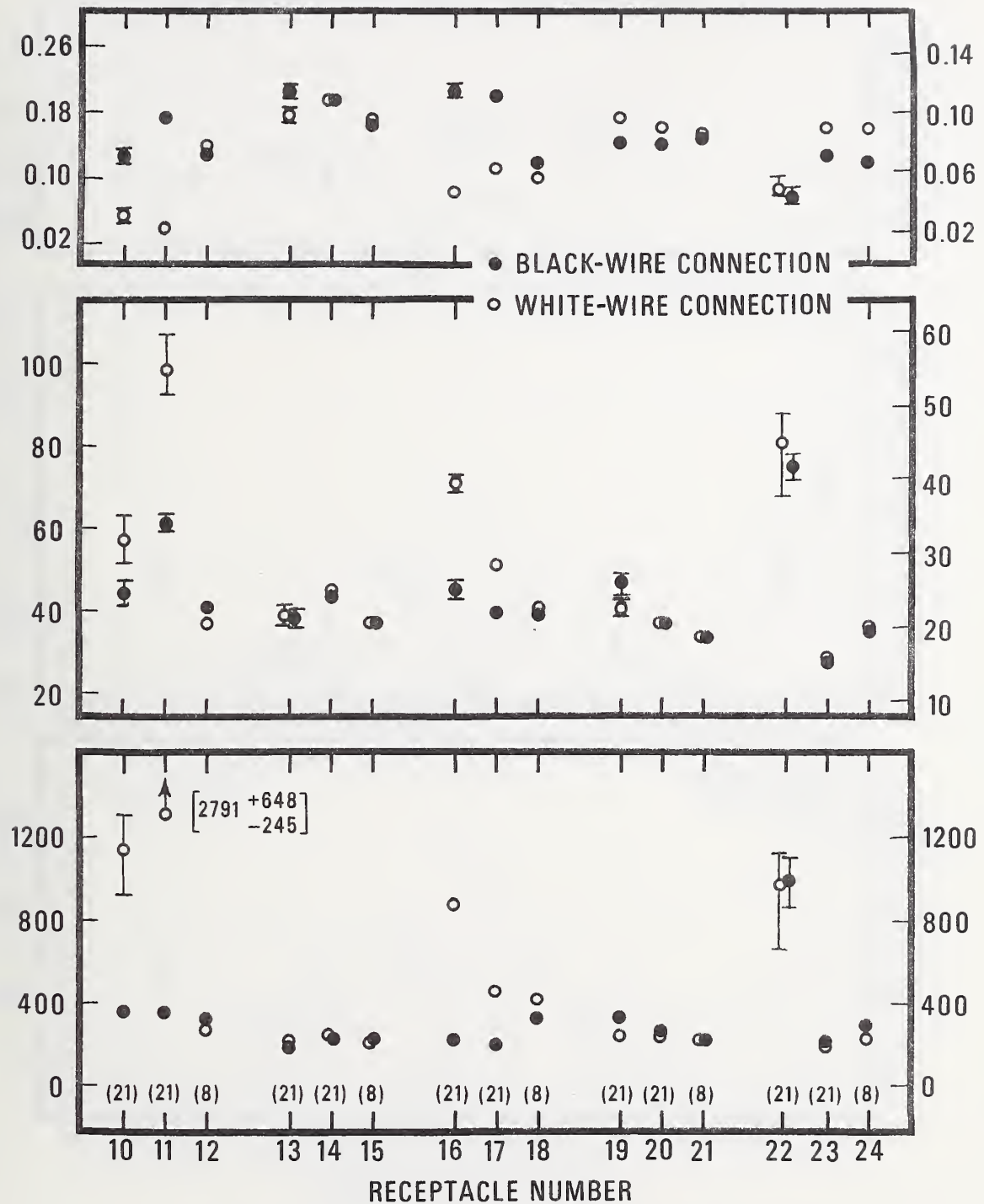

Figure 14. Values of the power loss, the tab temperature rise, and the ratio of the tab temperature rise to the power loss obtained for the black-wire and white-wire connections of the conventional receptacles during group receptacle tests: receptacles installed in adjacent outlet boxes, terminal screws tightened with a torque of 2 lbf·in. The values plotted are averages of values determined in tests employing test voltages of 10 V(dc), 10 V(ac), and 115 V(ac). The figures in parentheses indicate the number of tests used in computing the averages. The bars give the range of the values. The symbol heights are equivalent to about 60 mW, 3 °F, and 0.015 °F/mW for the power loss, the temperature rise, and the ratio, respectively.

{ SCREW TORQUE = 2 lbf·in }
 { RECEPTACLE SPACING = 1 }

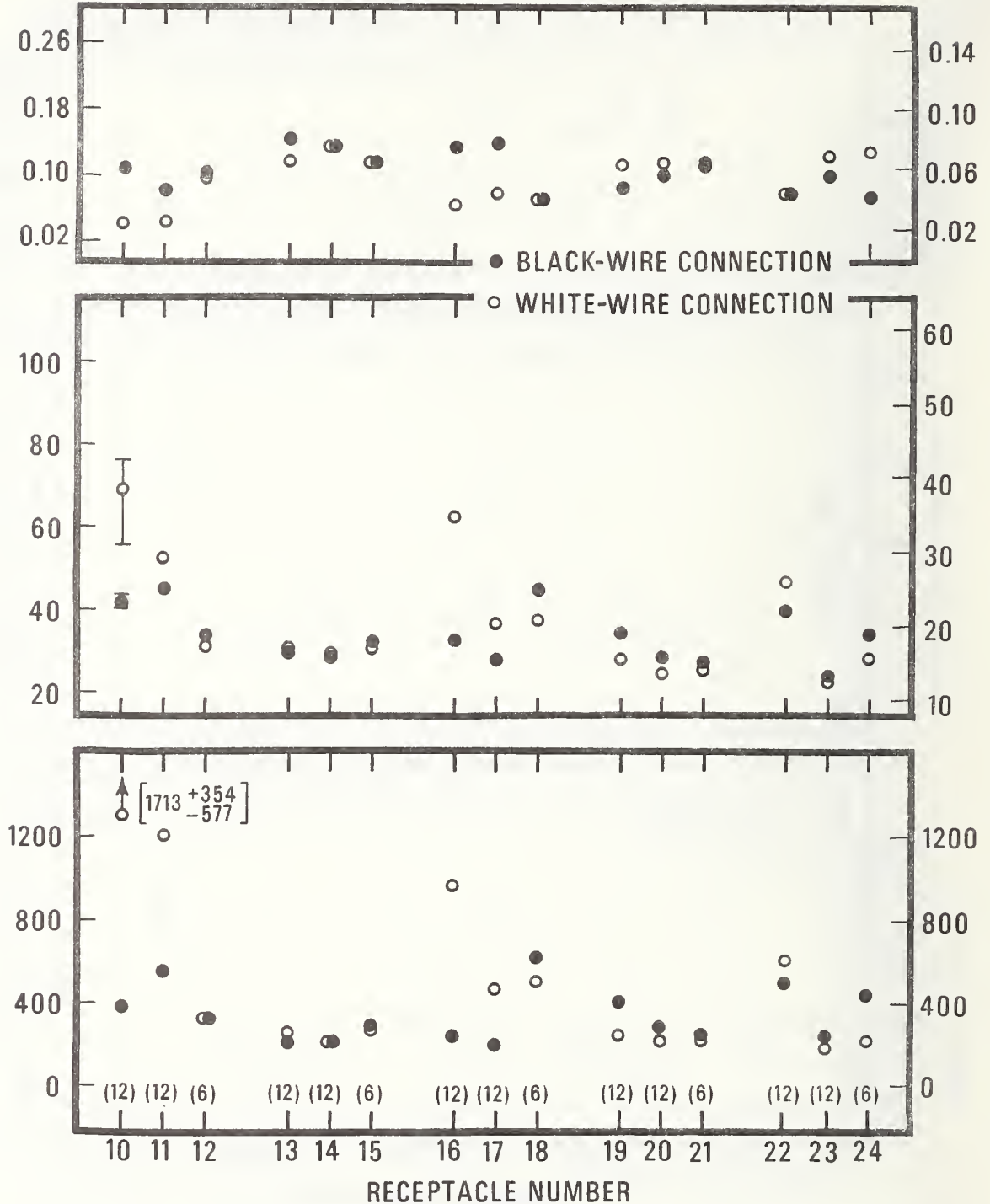

Figure 15. Values of the power loss, the tab temperature rise, and the ratio of the tab temperature rise to the power loss obtained for the black-wire and white-wire connections of the conventional receptacles during group receptacle tests: receptacles spaced one outlet box apart, terminal screws tightened with a torque of 2 lbf·in. The values plotted are averages of values determined in tests employing test voltages of 10 V(ac) and 115 V(ac). The figures in parentheses indicate the number of tests used in computing the averages. The bars give the range of the values. The symbol heights are equivalent to about 60 mW, 3 °F, and 0.015 °F/mW for the power loss, the temperature rise, and the ratio, respectively.

{ SCREW TORQUE = 2 lbf·in }
 { RECEPTACLE SPACING = 2 }

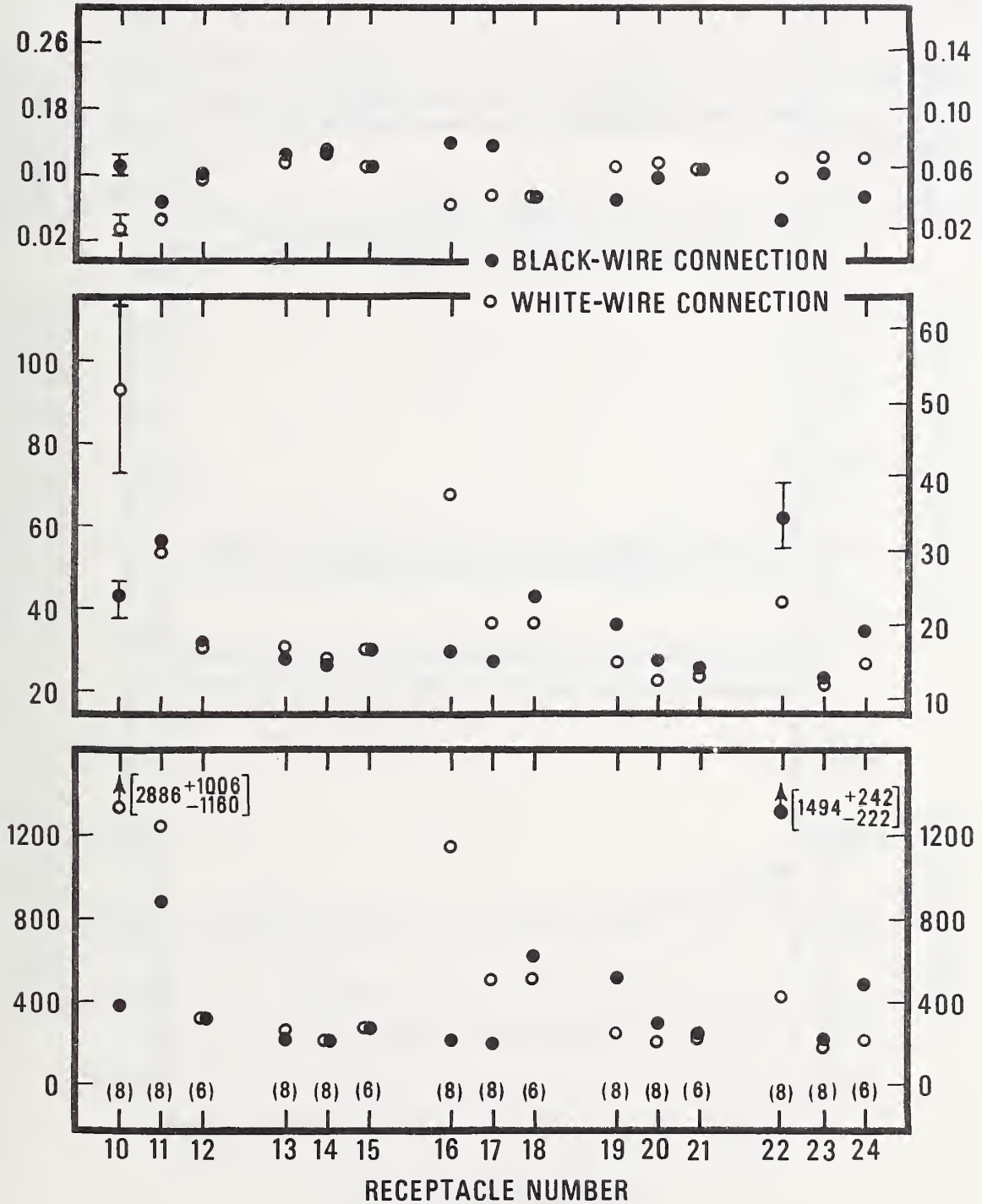

Figure 16. Values of the power loss, the tab temperature rise, and the ratio of the tab temperature rise to the power loss obtained for the black-wire and white-wire connections of the conventional receptacles during group receptacle tests: receptacles spaced two outlet boxes apart, terminal screws tightened with a torque of 2 lbf·in. The values plotted are averages of values determined in tests employing test voltages of 10 V(ac) and 115 V(ac). The figures in parentheses indicate the number of tests used in computing the averages. The bars give the range of the values. The symbol heights are equivalent to about 60 mW, 3 °F, and 0.015 °F/mW for the power loss, the temperature rise, and the ratio, respectively.

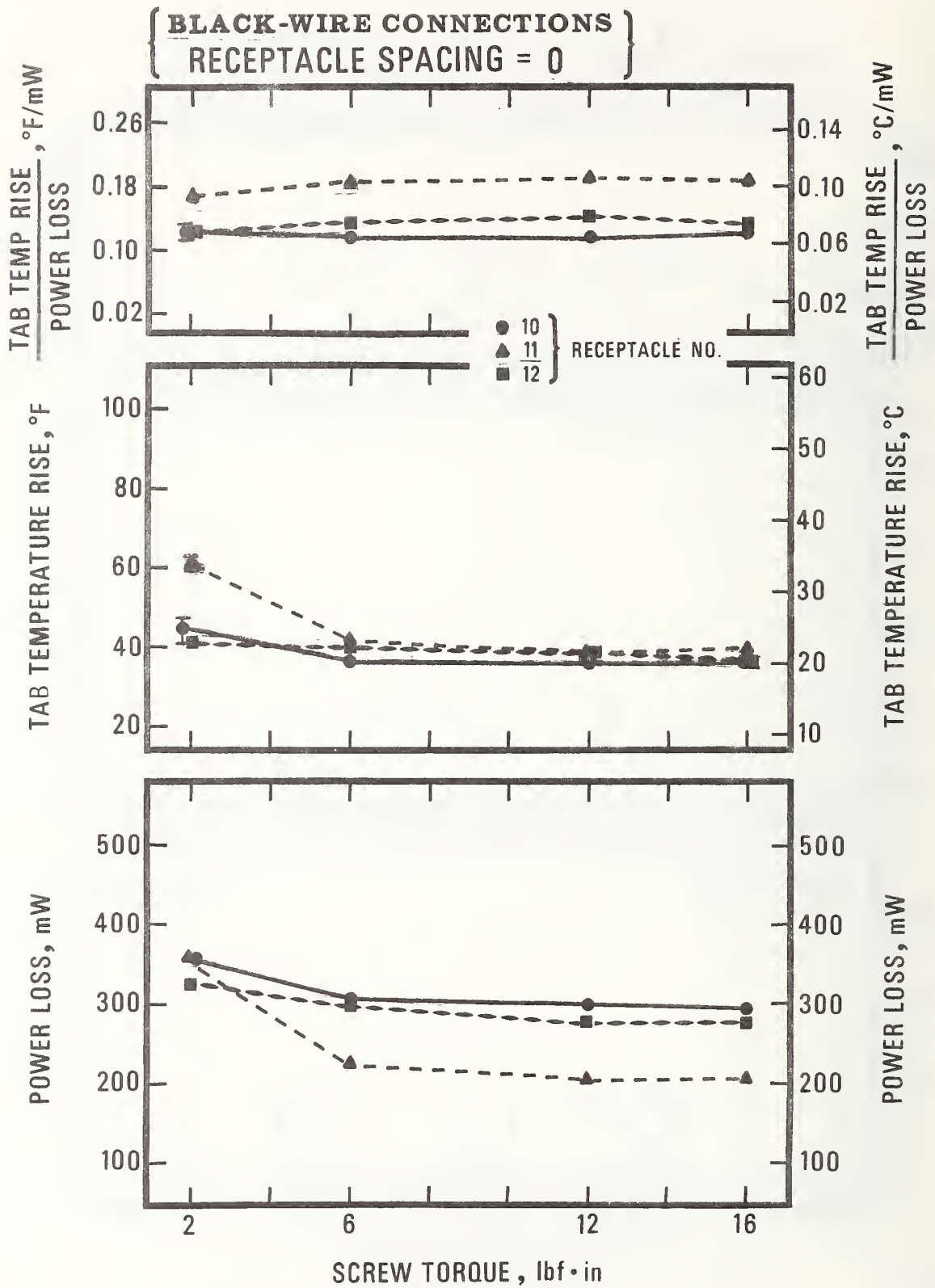

Figure 17. Values of the power loss, the tab temperature rise, and the ratio of the tab temperature rise to the power loss plotted as a function of the terminal screw torque for the black-wire connections of conventional receptacles No. 10, 11, and 12. The receptacles were installed in adjacent outlet boxes. The values plotted are averages of values determined in tests employing test voltages of 10 V(dc), 10 V(ac), and 115 V(ac). The bars give the range of the values.

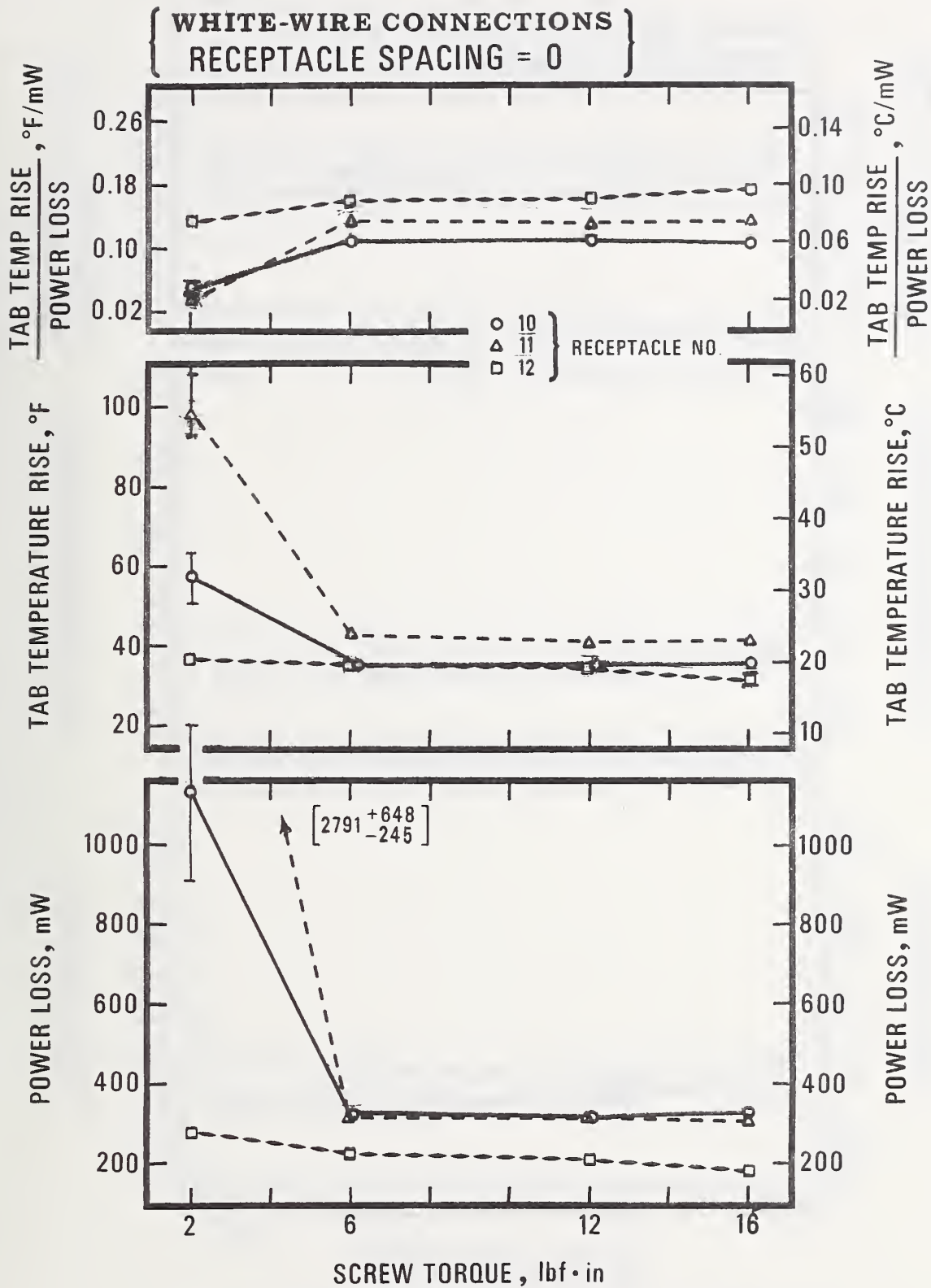

Figure 18. Values of the power loss, the tab temperature rise, and the ratio of the terminal screw torque to the power loss plotted as a function of the terminal screw torque for the white-wire connections of conventional receptacles No. 10, 11, and 12. The receptacles were installed in adjacent outlet boxes. The values plotted are averages of values determined in tests employing test voltages of 10 V(dc), 10 V(ac), and 115 V(ac). The bars give the range of the values.

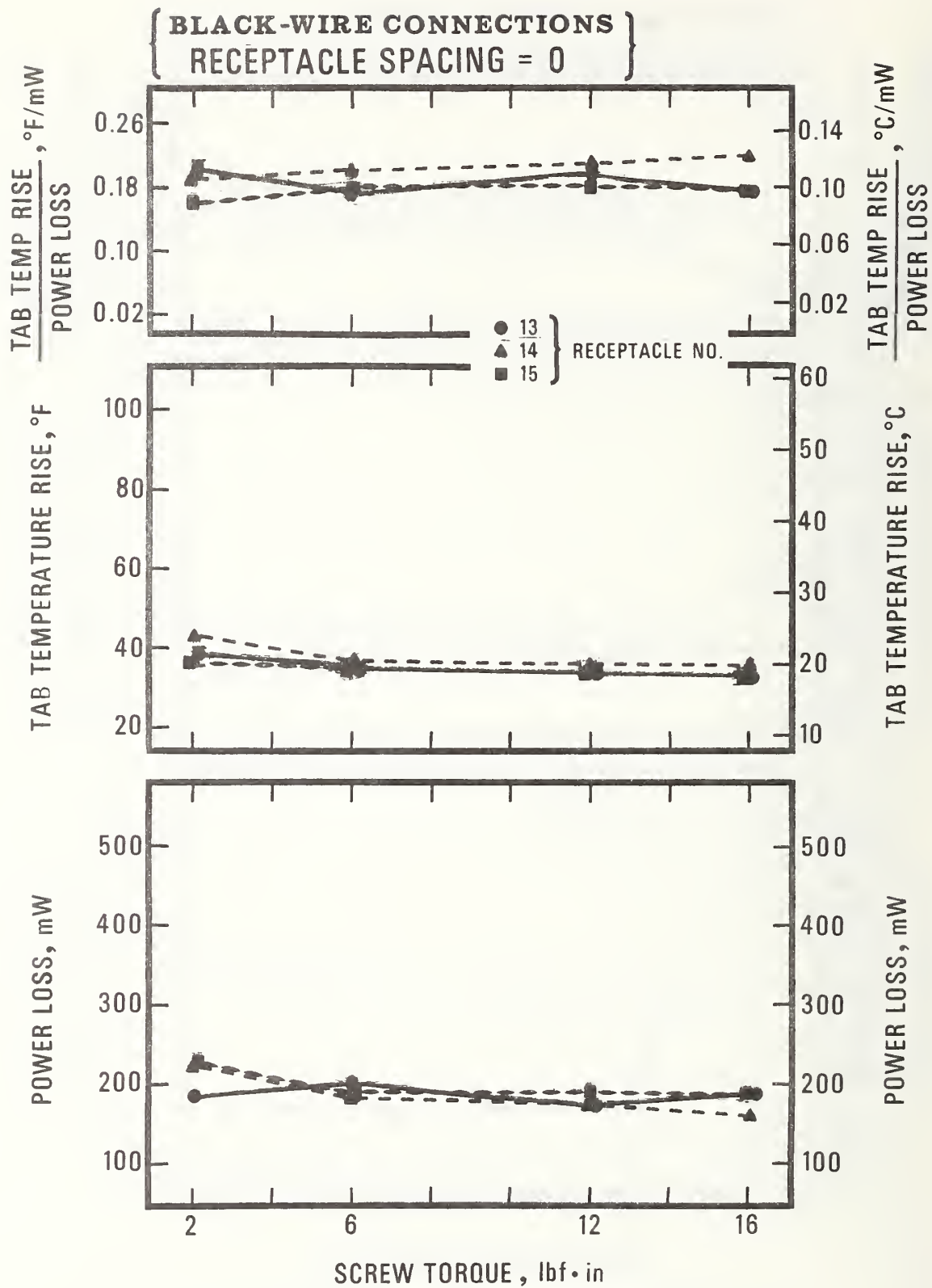

Figure 19. Values of the power loss, the tab temperature rise, and the ratio of the tab temperature rise to the power loss plotted as a function of the terminal screw torque for the black-wire connections of conventional receptacles No. 13, 14, and 15. The receptacles were installed in adjacent outlet boxes. The values plotted are averages of values determined in tests employing test voltages of 10 V(dc), 10 V(ac), and 115 V(ac). The bars give the range of the values.

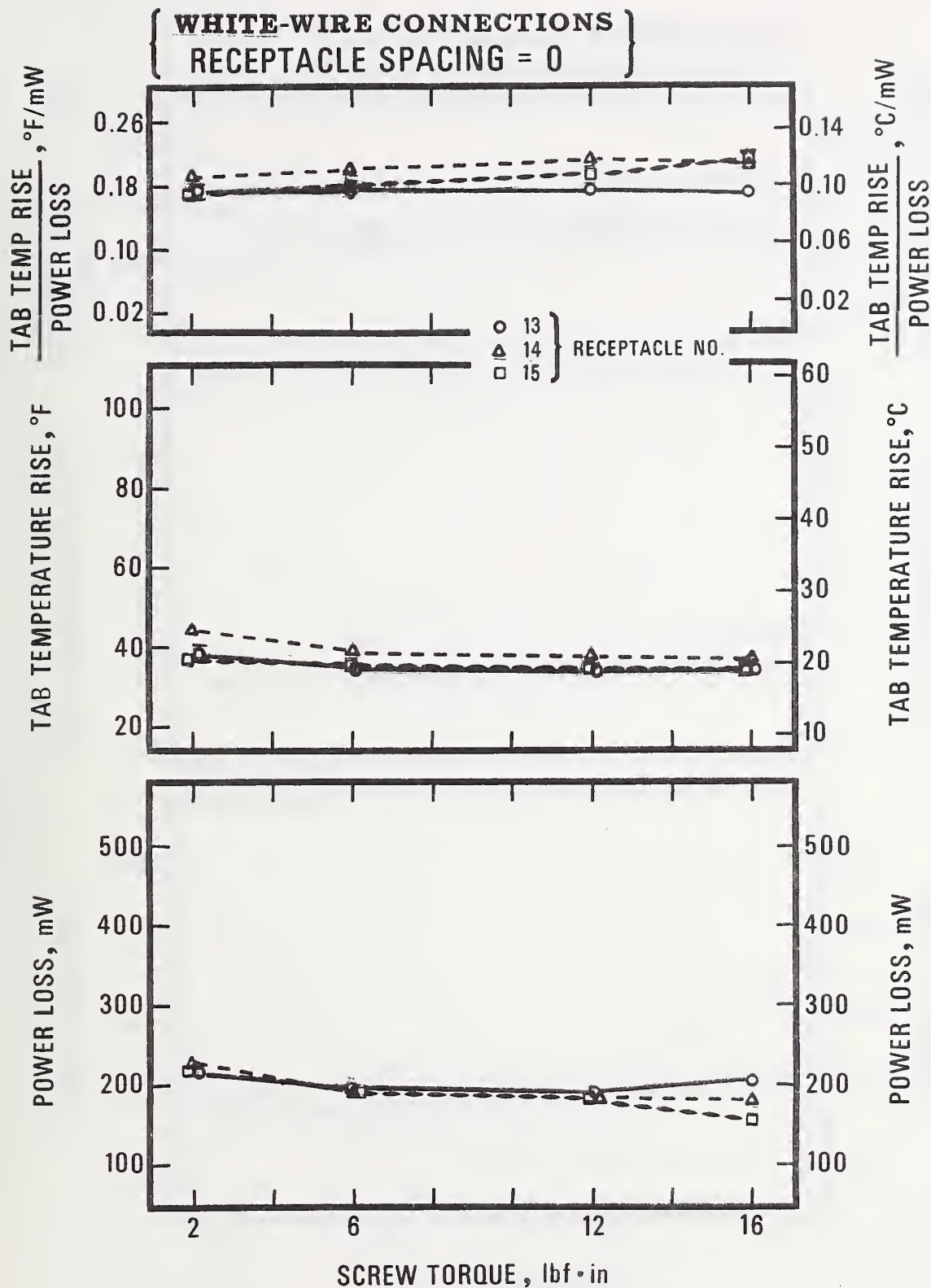

Figure 20. Values of the power loss, the tab temperature rise, and the ratio of the tab temperature rise to the power loss plotted as a function of the terminal screw torque for the white-wire connections of conventional receptacles No. 13, 14, and 15. The receptacles were installed in adjacent outlet boxes. The values plotted are averages of values determined in tests employing test voltages of 10 V(dc), 10 V(ac), and 115 V(ac). The bars give the range of the values.

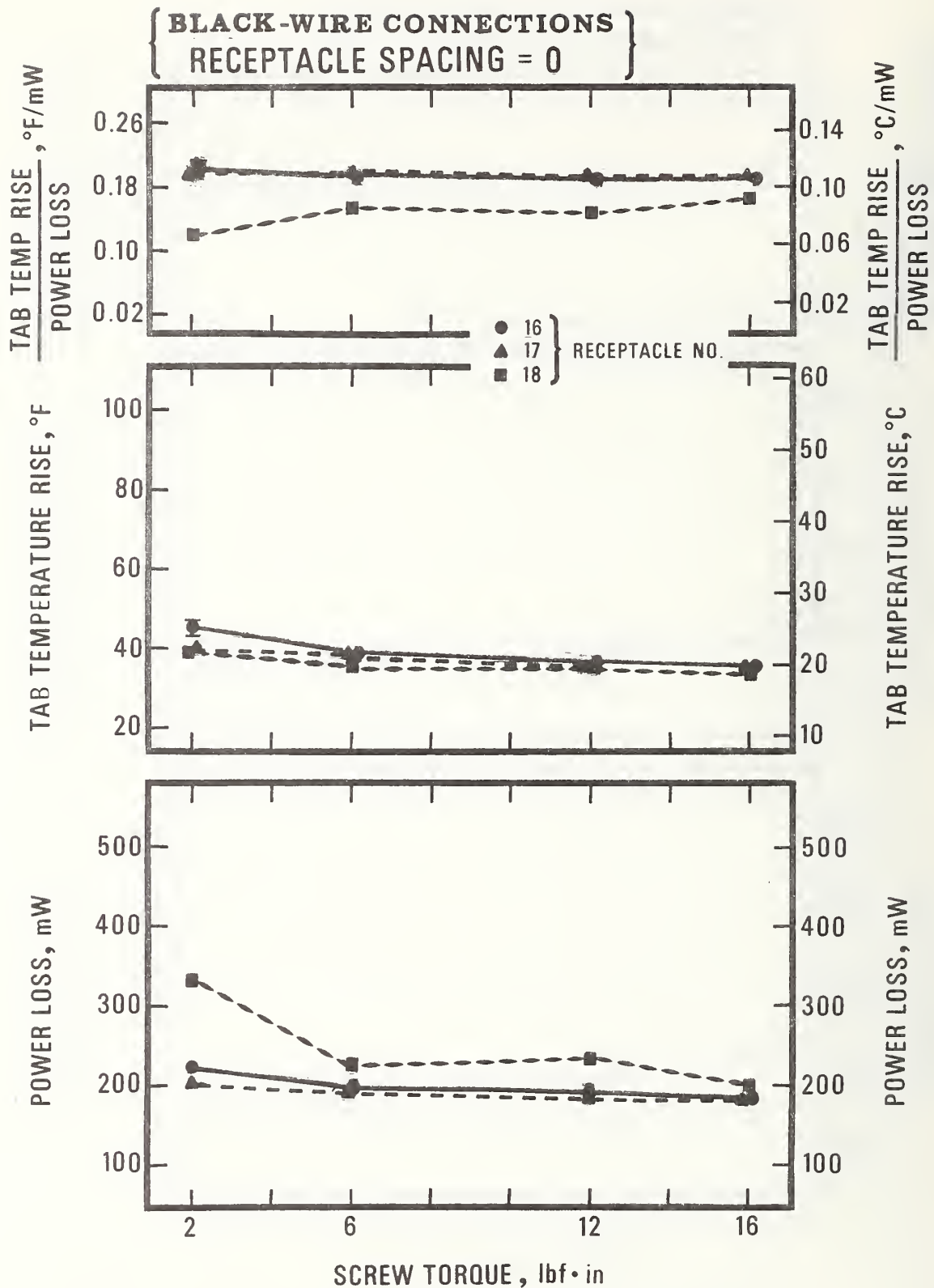

Figure 21. Values of the power, the tab temperature rise, and the ratio of the tab temperature rise to the power loss plotted as a function of the terminal screw torque for the black-wire connections of conventional receptacles No. 16, 17, and 18. The receptacles were installed in adjacent outlet boxes. The values plotted are averages of values determined in tests employing test voltages of 10 V(dc), 10 V(ac), and 115 V(ac). The bars give the range of the values.

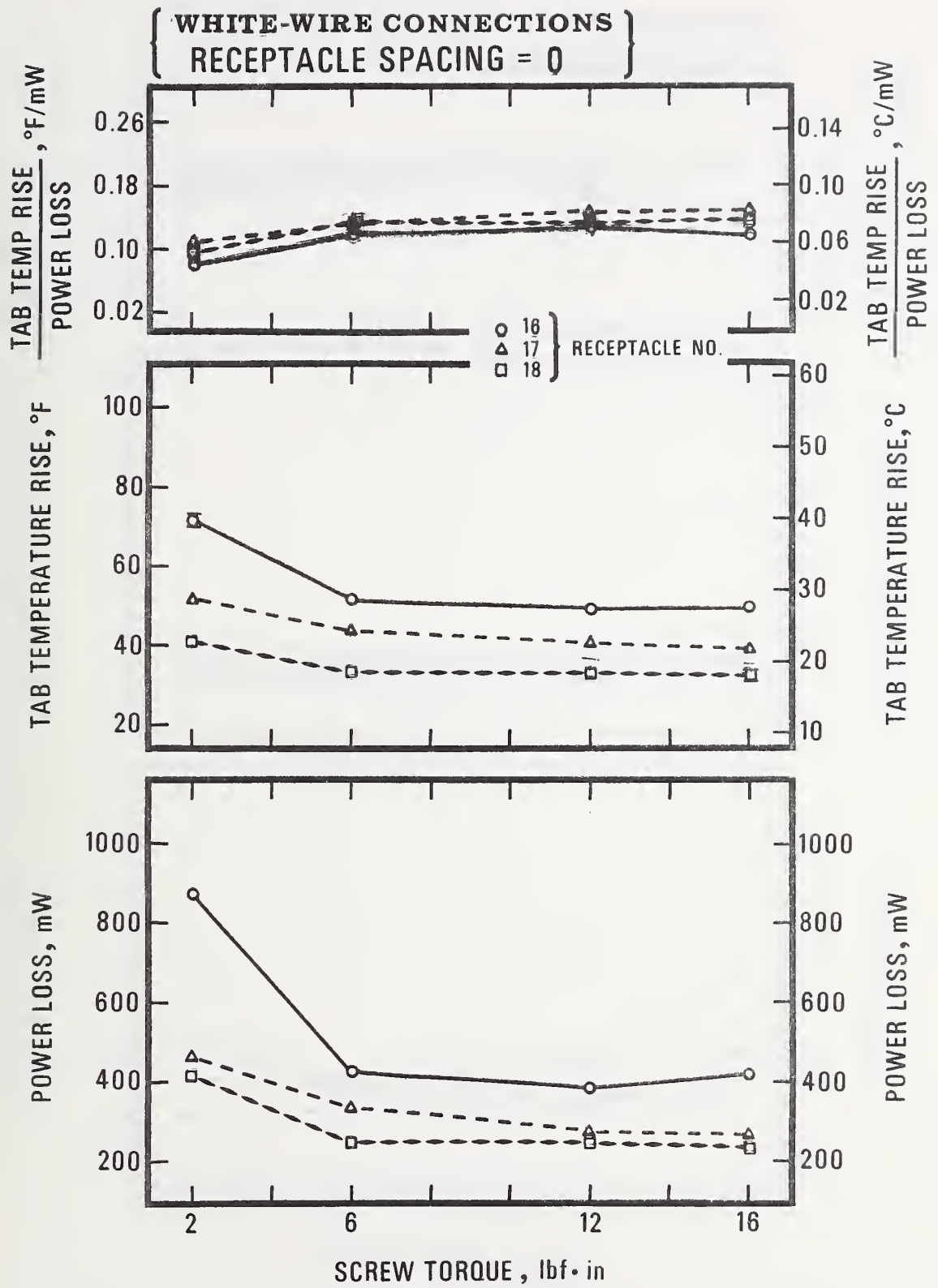

Figure 22. Values of the power loss, the tab temperature rise, and the ratio of the tab temperature rise to the power loss plotted as a function of the terminal screw torque for the white-wire connections of conventional receptacles No. 16, 17, and 18. The receptacles were installed in adjacent outlet boxes. The values plotted are averages of values determined in tests employing test voltages of 10 V(dc), 10 V(ac), and 115 V(ac). The bars give the range of the values.

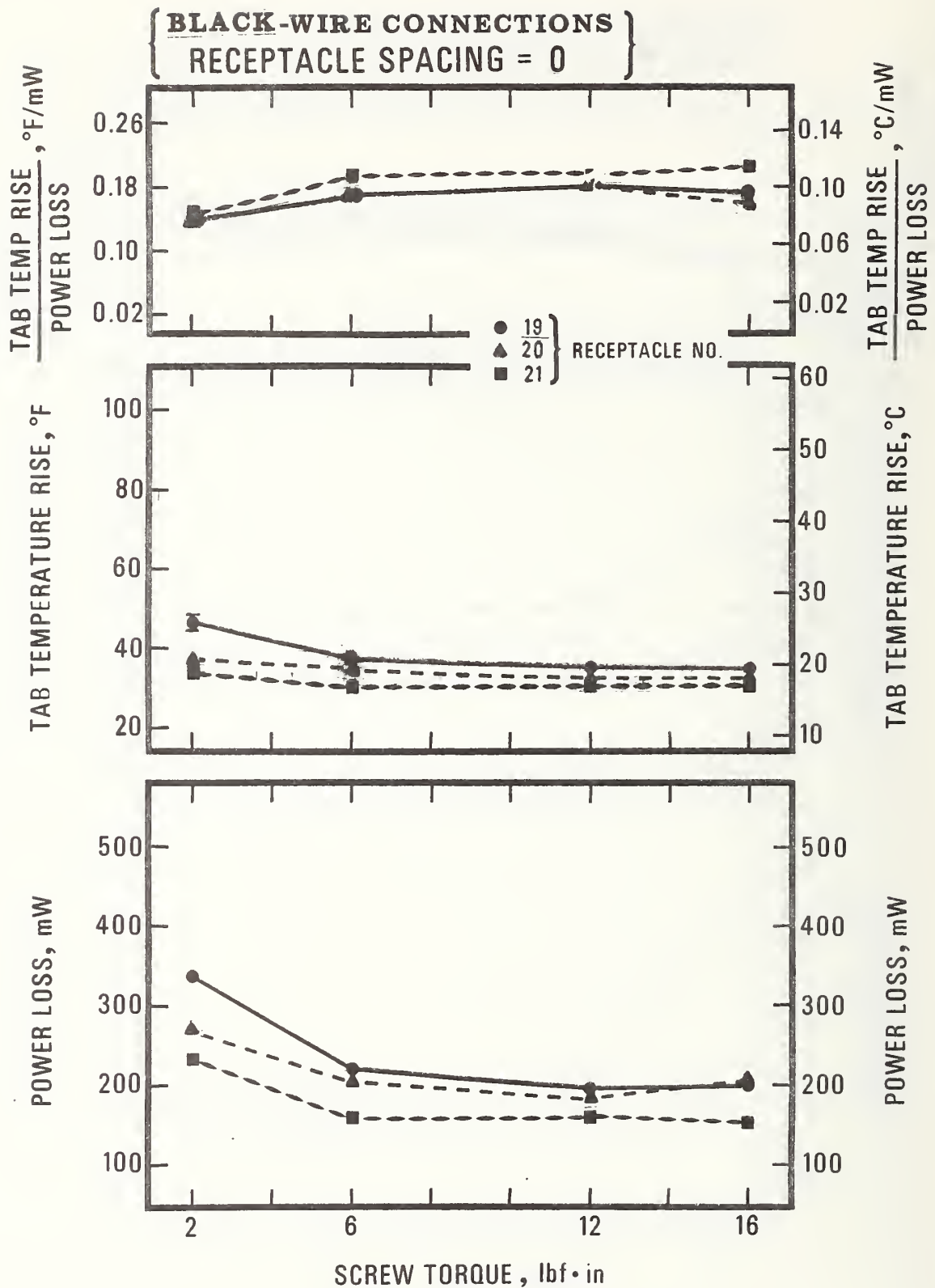

Figure 23. Values of the power loss, the tab temperature rise, and the ratio of the tab temperature rise to the power loss plotted as a function of the terminal screw torque for the black-wire connections of conventional receptacles No. 19, 20, and 21. The receptacles were installed in adjacent outlet boxes. The values plotted are averages of values determined in tests employing test voltages of 10 V(dc), 10 V(ac), and 115 V(ac). The bars give the range of the values.

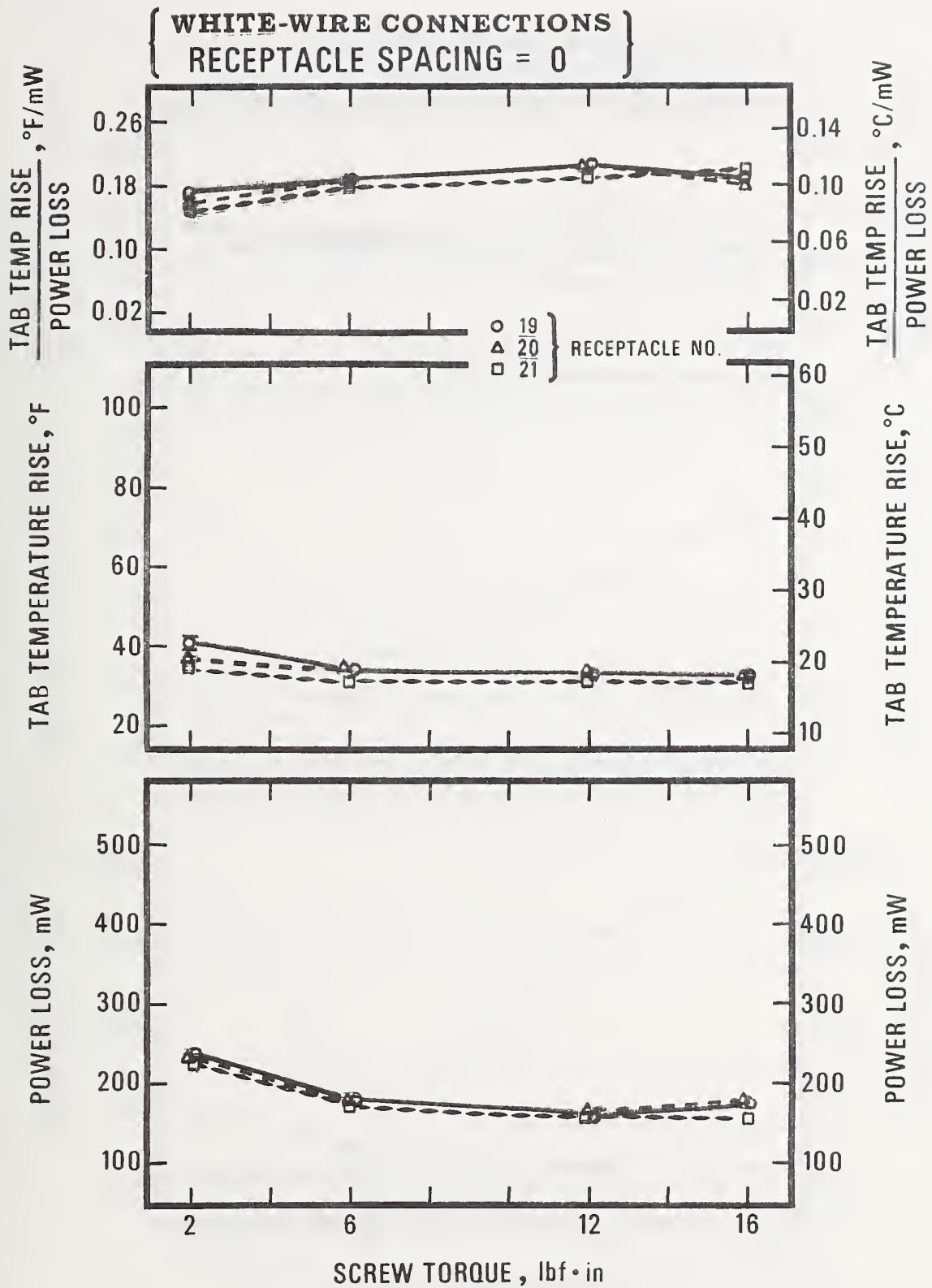

Figure 24. Values of the power loss, the tab temperature rise, and the ratio of the tab temperature rise to the power loss plotted as a function of the terminal screw torque for the white-wire connections of conventional receptacles No. 19, 20, and 21. The receptacles were installed in adjacent outlet boxes. The values plotted are averages of values determined in tests employing test voltages of 10 V(dc), 10 V(ac), and 115 V(ac). The bars give the range of the values.

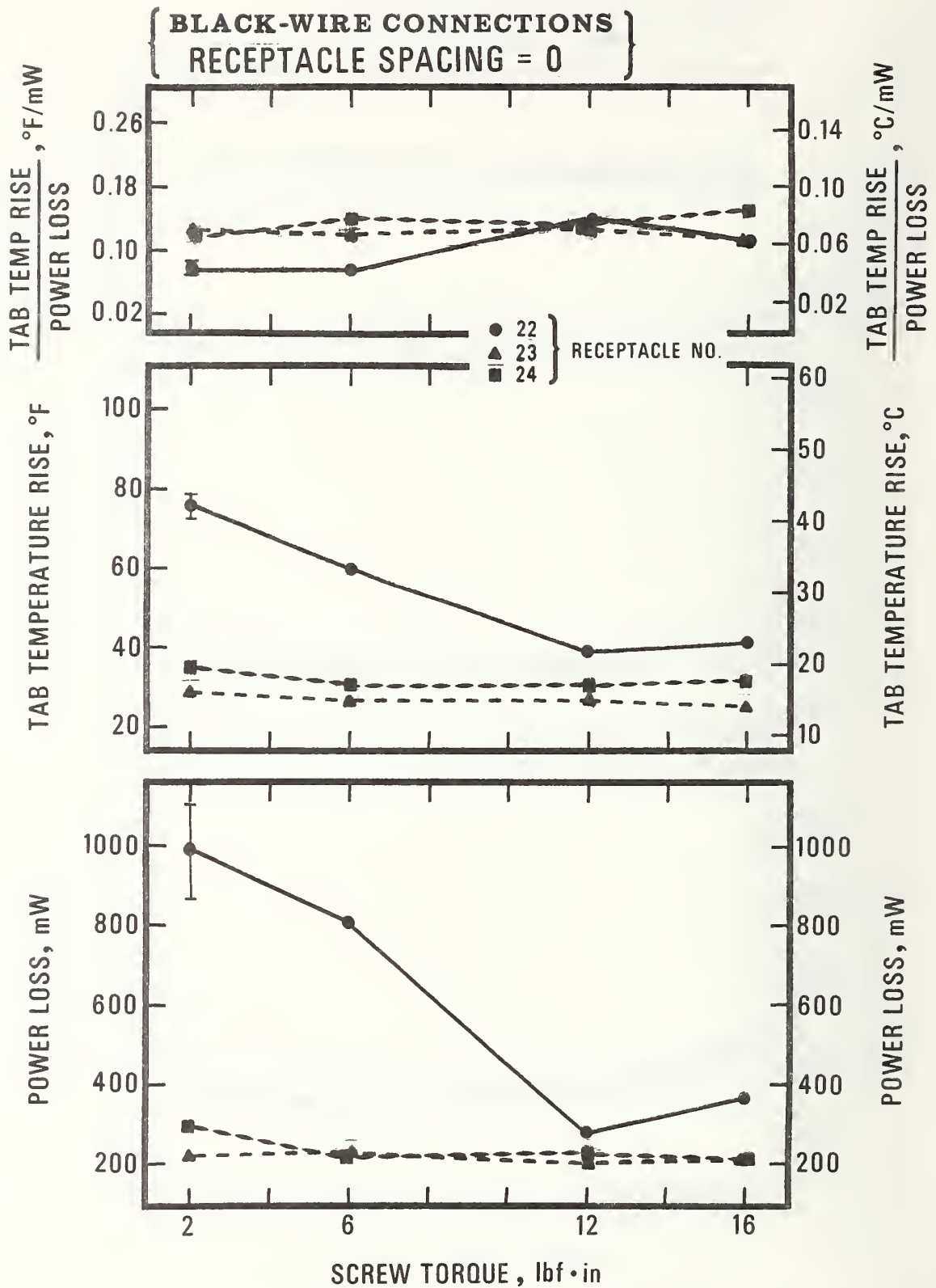

Figure 25. Values of the power loss, the tab temperature rise, and the ratio of the tab temperature rise to the power loss plotted as a function of the terminal screw torque for the black-wire connections of conventional receptacles No. 22, 23, and 24. The receptacles were installed in adjacent outlet boxes. The values plotted are averages of values determined in tests employing test voltages of 10 V(dc), 10 V(ac), and 115 V(ac). The bars give the range of the values.

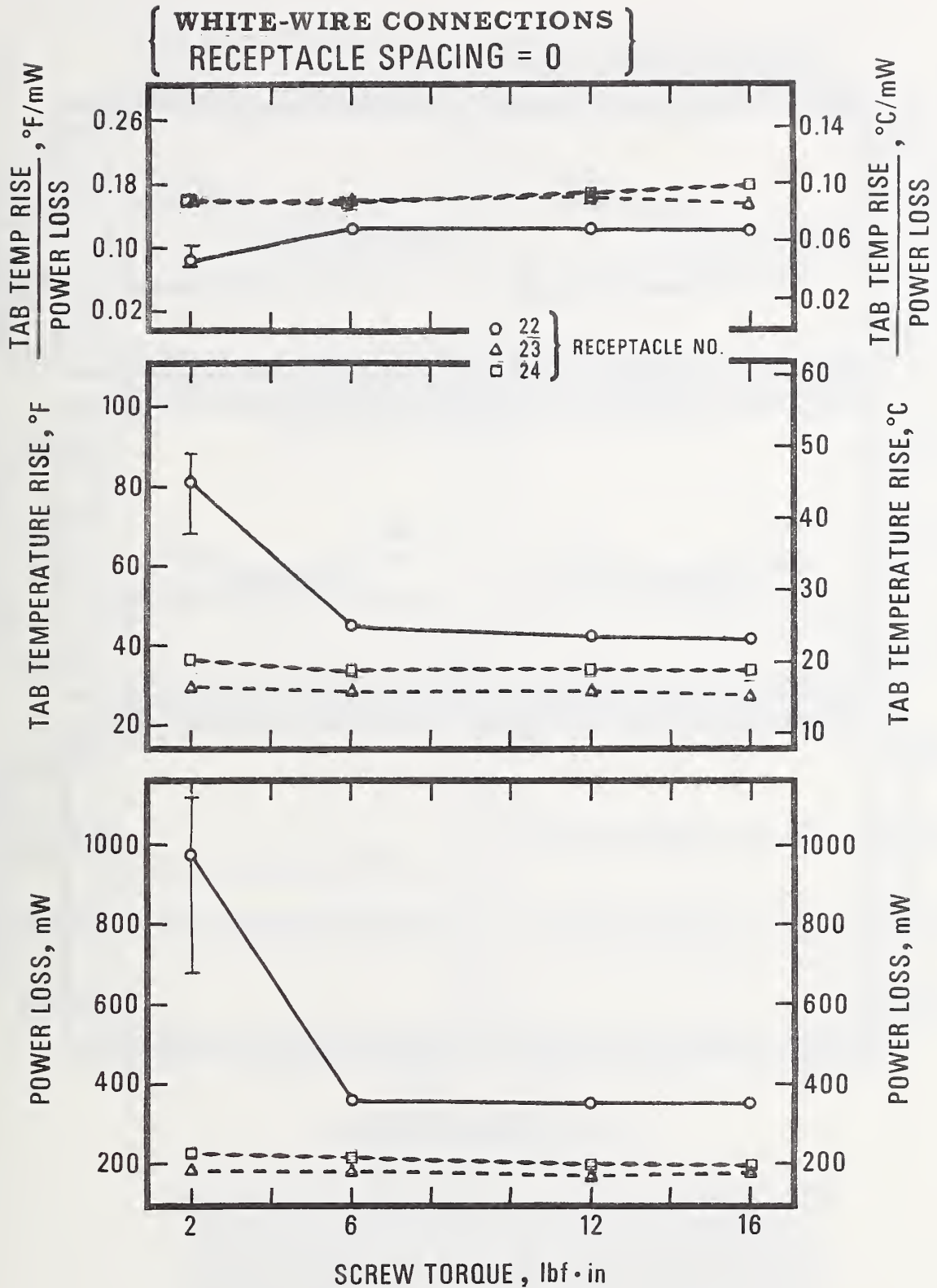

Figure 26. Values of the power loss, the tab temperature rise, and the ratio of the tab temperature rise to the power loss plotted as a function of the terminal screw torque for the white-wire connections of conventional receptacles No. 22, 23, and 24. The receptacles were installed in adjacent outlet boxes. The values plotted are averages of values determined in tests employing test voltages of 10 V(dc), 10 V(ac), and 115 V(ac). The bars give the range of the values.

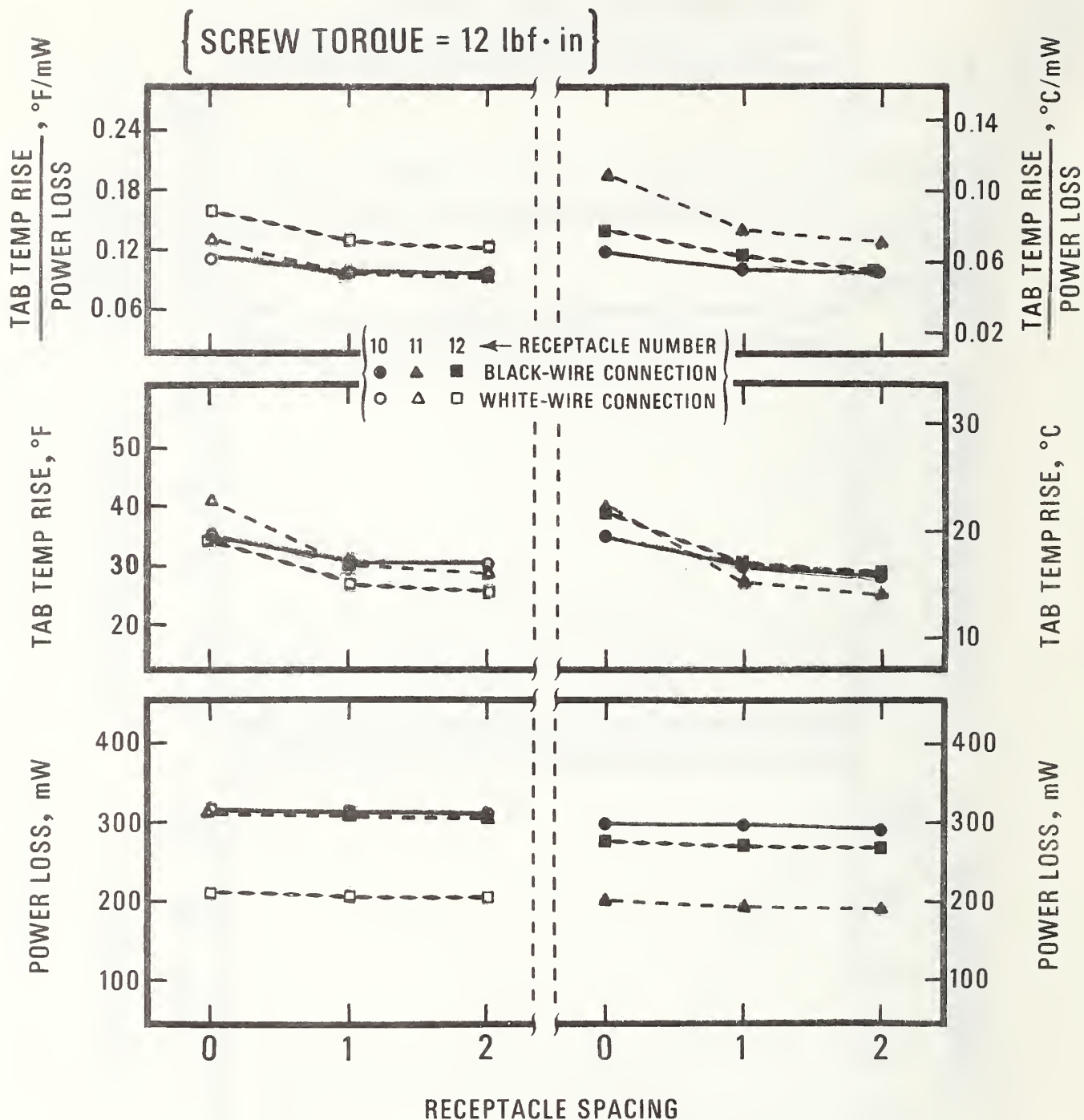

Figure 27. Values of the power loss, the tab temperature rise, and the ratio of the tab temperature rise to the power loss plotted as a function of the receptacle spacing for the black-wire and white-wire connections of conventional receptacles No. 10, 11, and 12. The terminal screws of the receptacles were tightened with a torque of 12 lbf·in. The values plotted are averages of values determined in tests employing a test voltage of 10 V(ac). The range of the values was less than the symbol height, which are equivalent to about 15 mW, 2 °F, and 0.012 °F/mW for the power loss, the temperature rise, and the ratio, respectively.

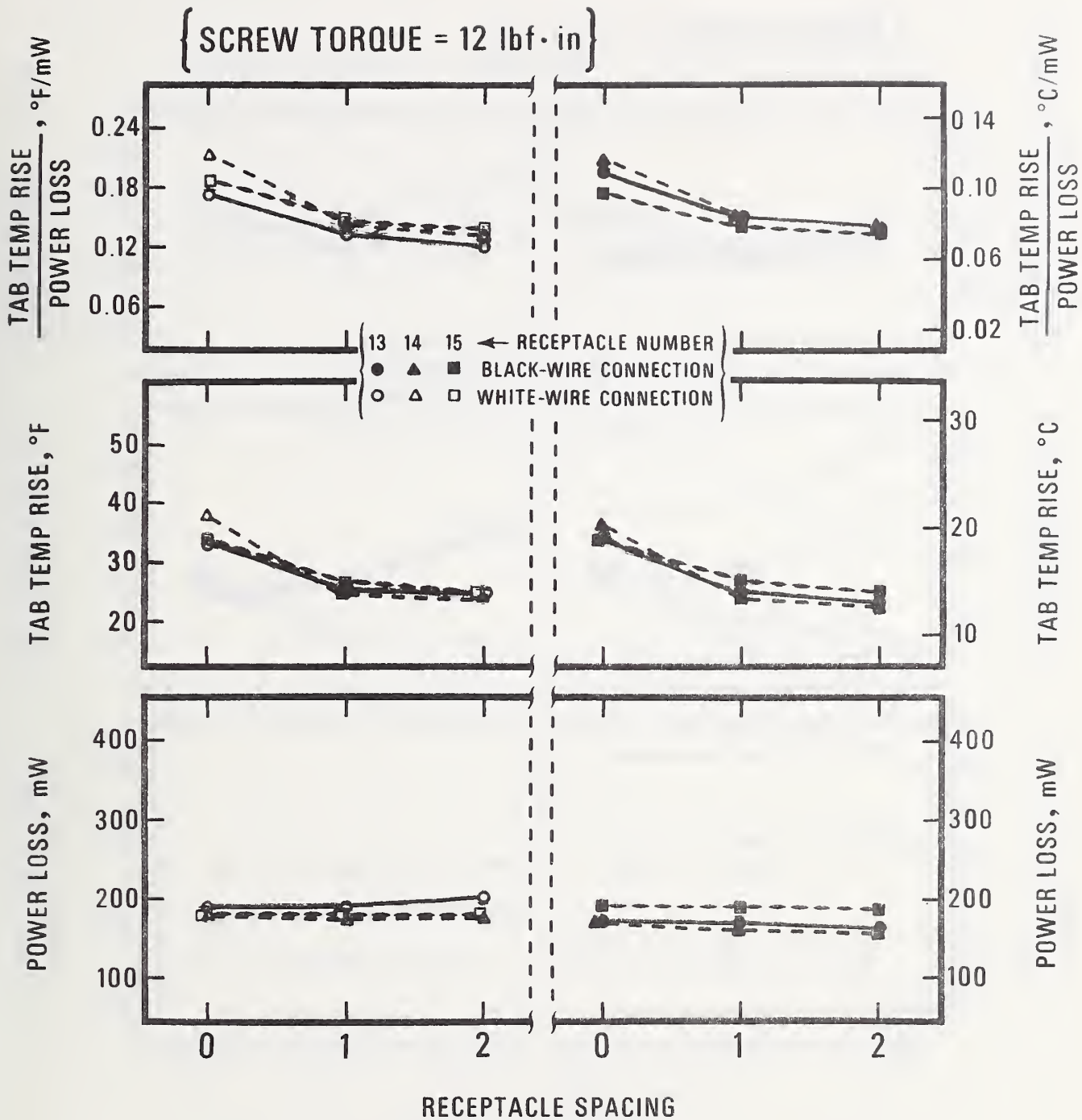

Figure 28. Values of the power loss, the tab temperature rise, and the ratio of the tab temperature rise to the power loss plotted as a function of the receptacle spacing for the black-wire and white-wire connections of conventional receptacles No. 13, 14, and 15. The terminal screws of the receptacles were tightened with a torque of 12 lbf·in. The values plotted are averages of values determined in tests employing a test voltage of 10 V(ac). The range of the values was less than the symbol heights, which are equivalent to about 15 mW, 2 °F, and 0.012 °F/mW for the power loss, the temperature rise, and the ratio, respectively.

{ SCREW TORQUE = 12 lbf·in }

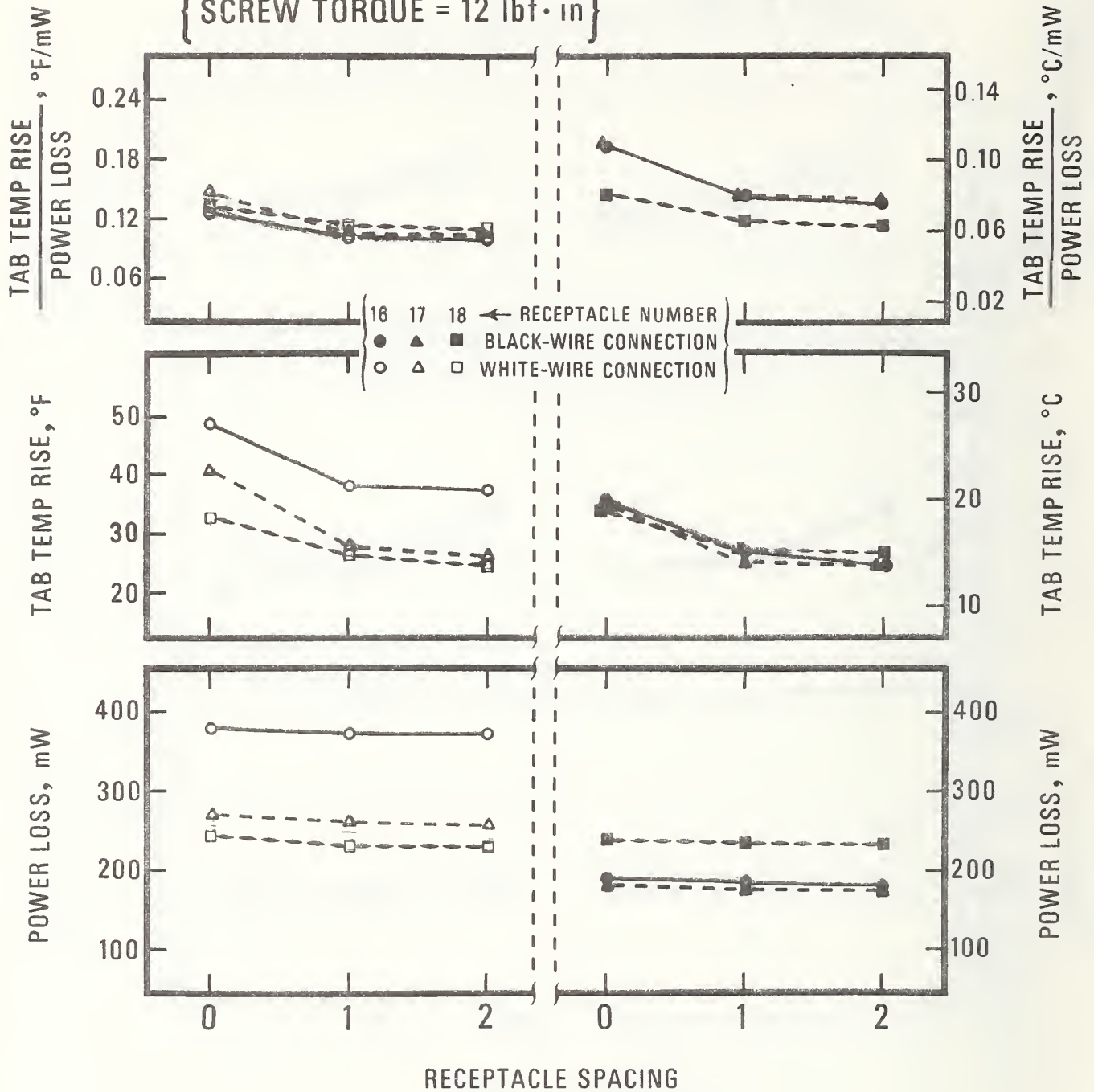

Figure 29. Values of the power loss, the tab temperature rise, and the ratio of the tab temperature rise to the power loss plotted as a function of the receptacle spacing for the black-wire and white-wire connections of conventional receptacles No. 16, 17, and 18. The terminal screws of the receptacles were tightened with a torque of 12 lbf·in. The values plotted are averages of values determined in tests employing a test voltage of 10 V(ac). The range of the values was less than the symbol heights, which are equivalent to about 15 mW, 2 °F, and 0.012 °F/mW for the power loss, the temperature rise, and the ratio, respectively.

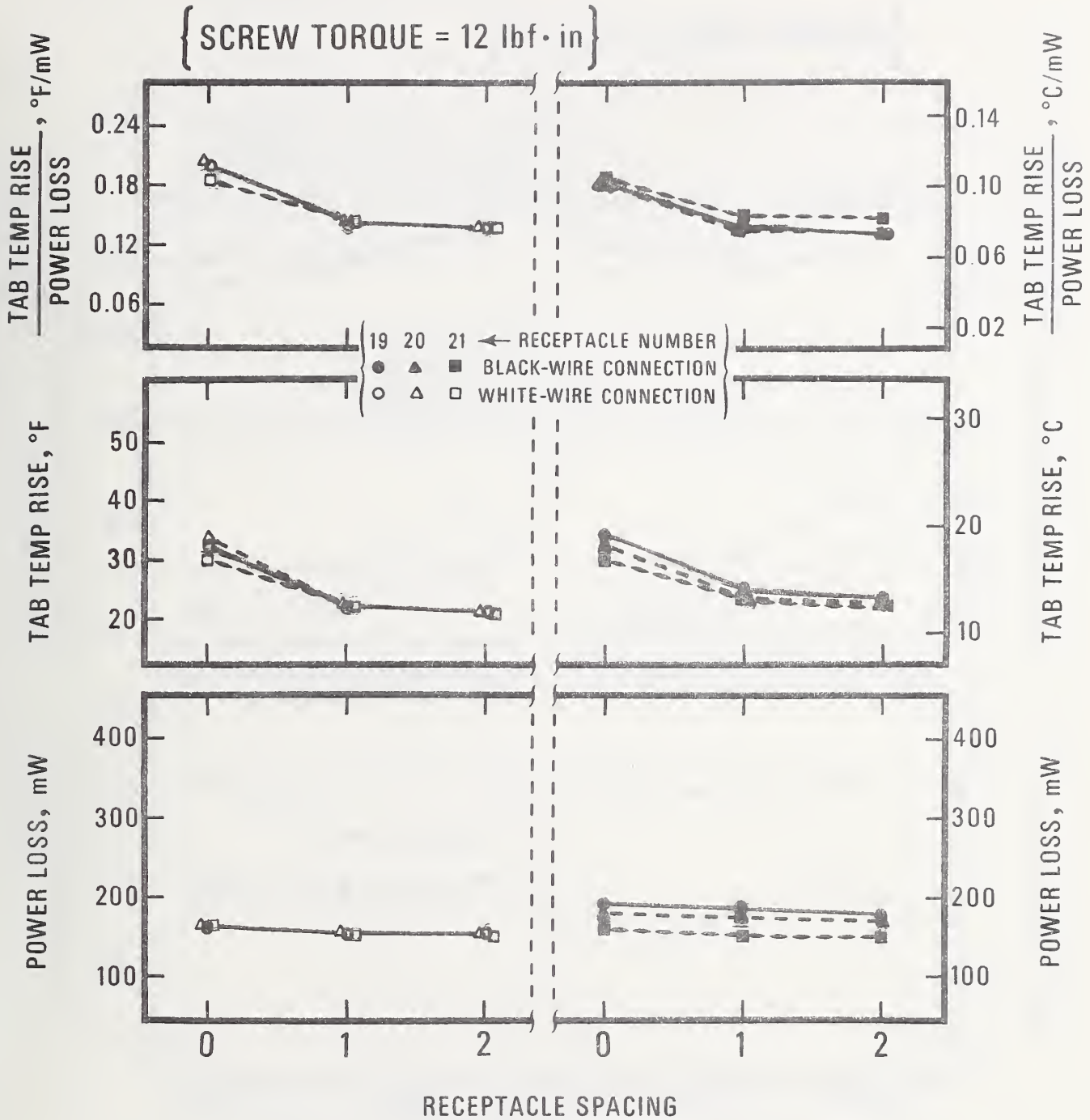

Figure 30. Values of the power loss, the tab temperature rise, and the ratio of the tab temperature rise to the power loss plotted as a function of the receptacle spacing for the black-wire and white-wire connections of conventional receptacles No. 19, 20, and 21. The terminal screws of the receptacles were tightened with a torque of 12 lbf·in. The values plotted are averages of values determined in tests employing a test voltage of 10 V(ac). The range of the values was less than the symbol heights, which are equivalent to about 15 mW, 2 °F, and 0.012 ° F/mW for the power loss, the temperature rise, and the ratio, respectively.

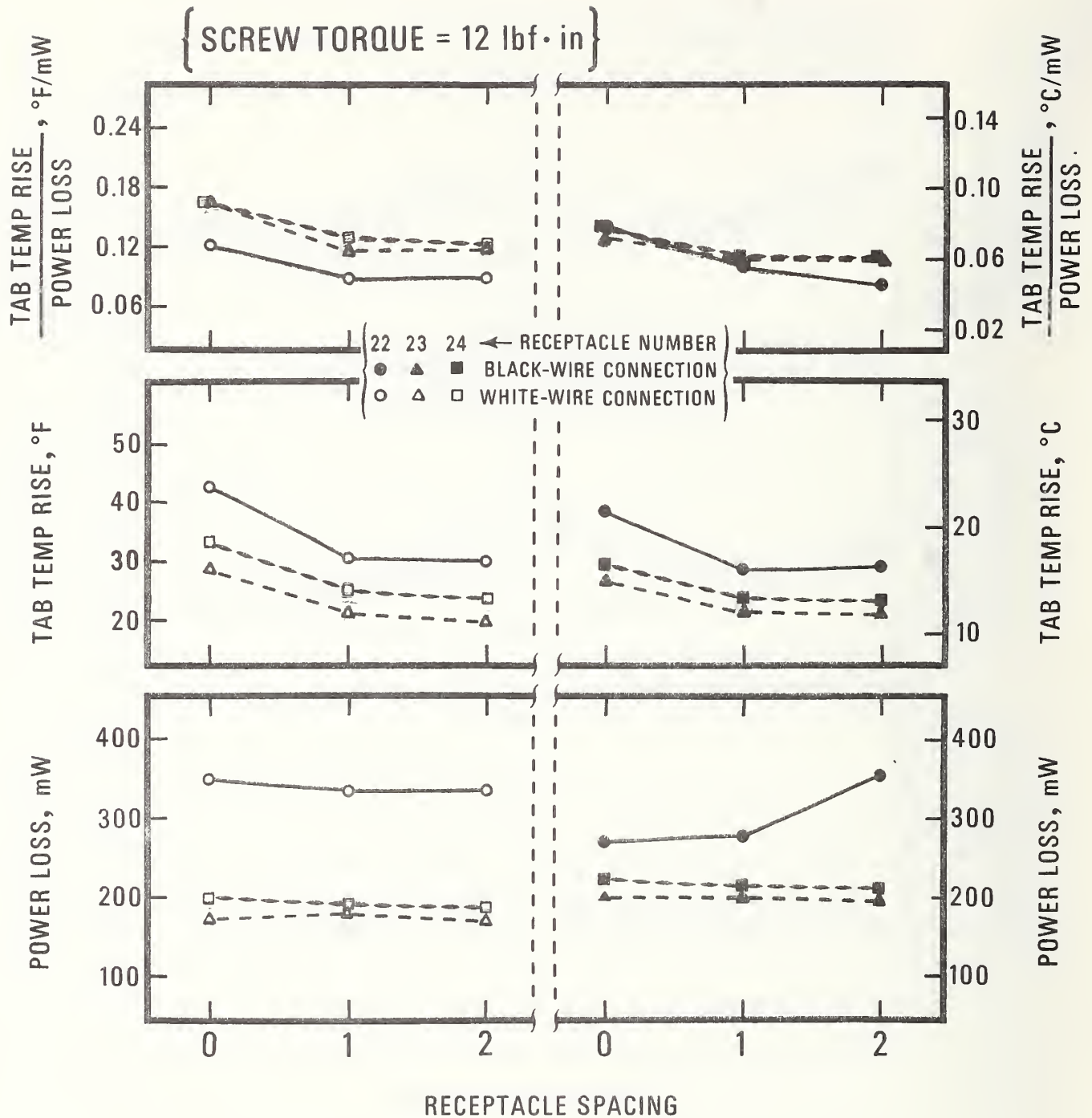

Figure 31. Values of the power loss, the tab temperature rise, and the ratio of the tab temperature rise to the power loss plotted as a function of the receptacle spacing for the black-wire and white-wire connections of conventional receptacles No. 22, 23, and 24. The terminal screws of the receptacles were tightened with a torque of 12 lbf·in. The values plotted are averages of values determined in tests employing a test voltage of 10 V(ac). The range of the values was less than the symbol heights, which are equivalent to about 15 mW, 2 °F, and 0.012 °F/mW for the power loss, the temperature rise, and the ratio, respectively.

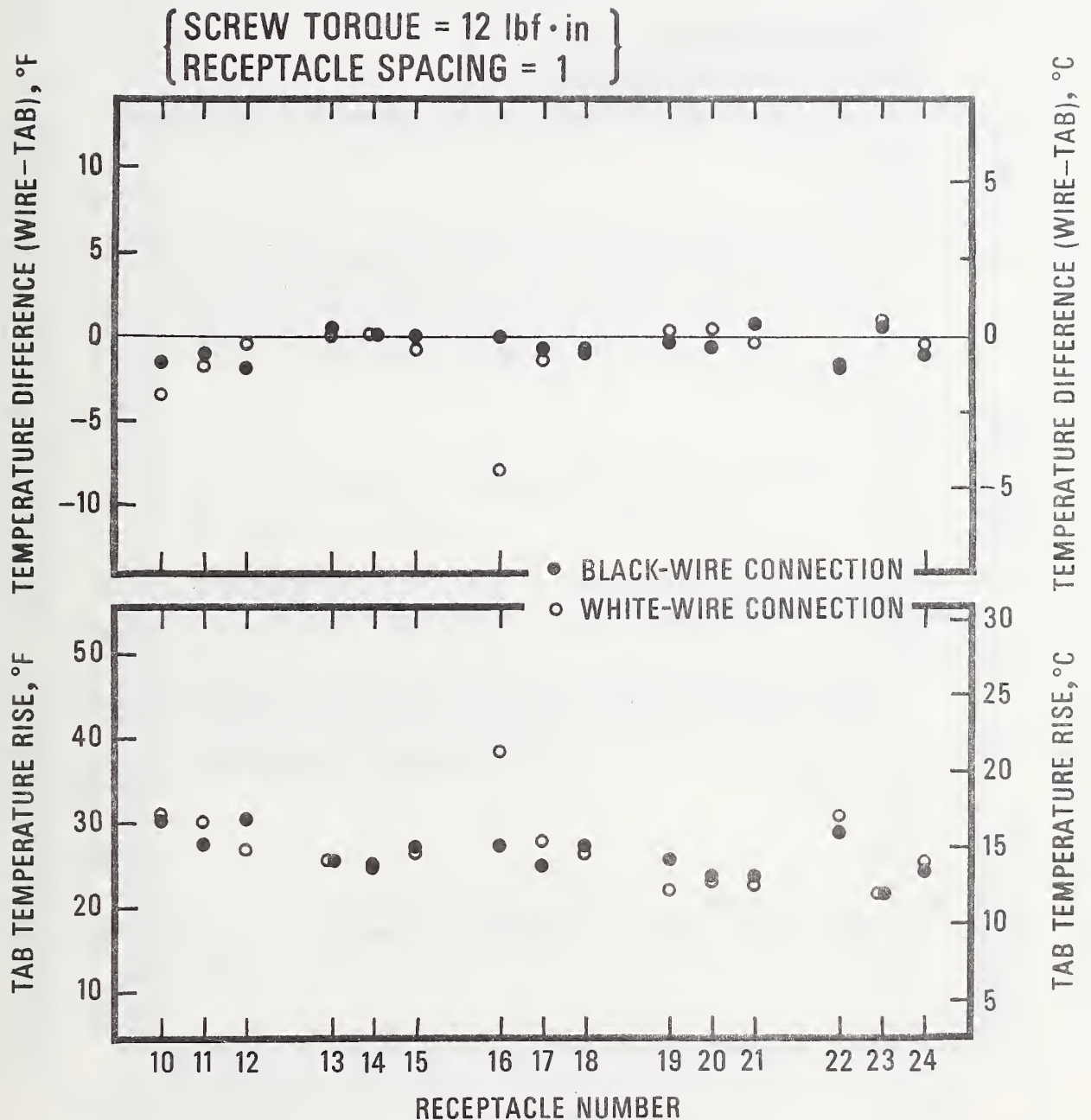

Figure 32. The tab temperature rise and the difference between the wire temperature and the tab temperature for the black-wire and white-wire connections of the conventional receptacles: receptacles spaced one outlet box apart, terminal screws tightened with a torque of 12·lbf in. The difference was calculated from the averages of values determined during three consecutive tests in which the test voltage was 10 V(ac). The 99% confidence limits for the difference between the averages are less than the symbol heights, which are equivalent to about 0.8 °F for the difference and about 1.5 °F for the tab temperature rise.

{ SCREW TORQUE = 2 lbf·in }
 { RECEPTACLE SPACING = 0 }

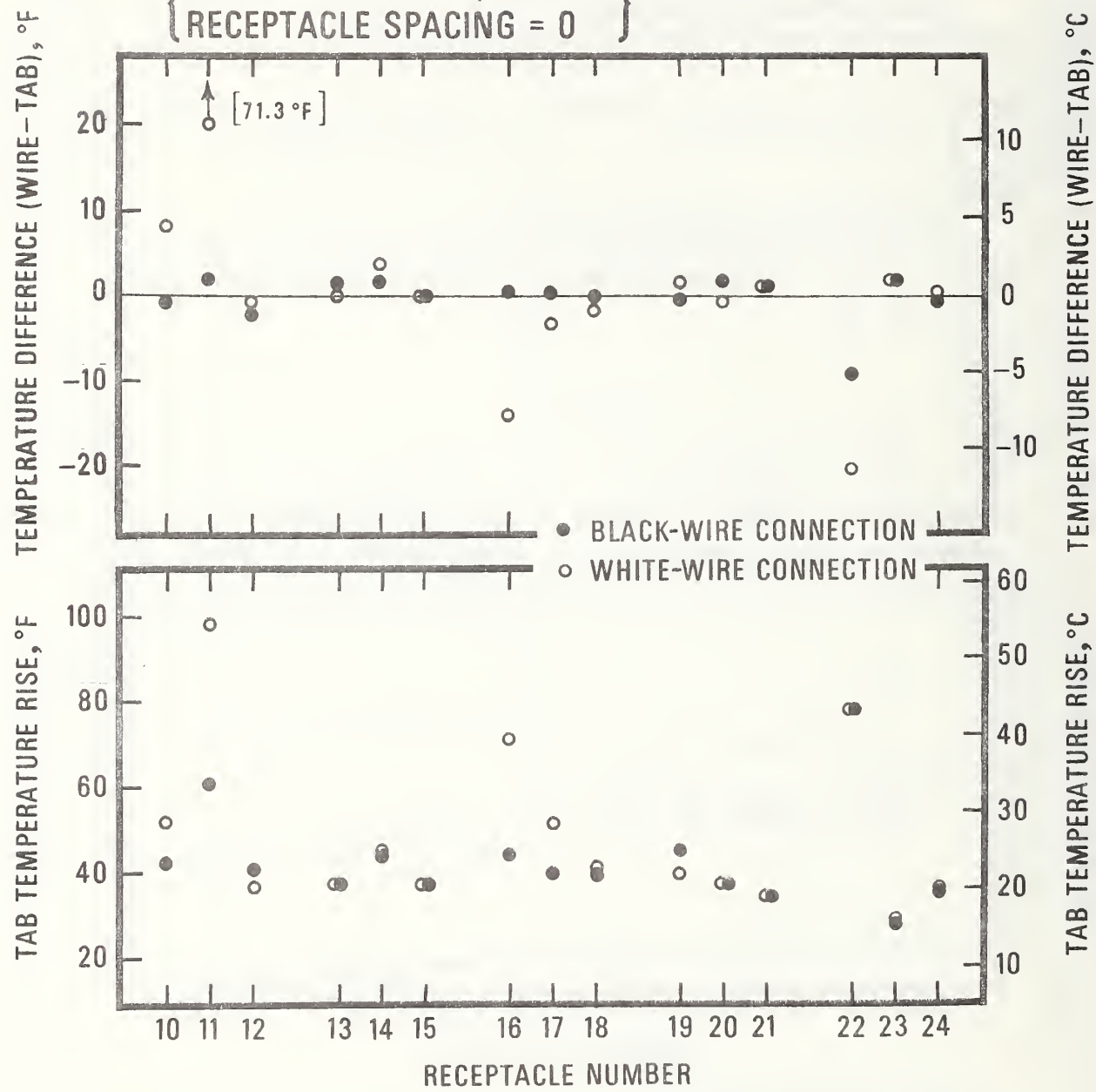

Figure 33. The tab temperature rise and the difference between the wire temperature and the tab temperature for the black-wire and white-wire connections of the conventional receptacles: receptacles installed in adjacent outlet boxes, terminal screws tightened with a torque of 2 lbf in. The difference was calculated from the averages of values determined during three consecutive tests in which the test voltage was 10 V(ac). The 99% confidence limits for the difference between the averages are less than the symbol heights, which are equivalent to about 1.5 °F for the difference and about 3 °F for the tab temperature rise.

{ SCREW TORQUE = 2 lbf · in }
 { RECEPTACLE SPACING = 2 }

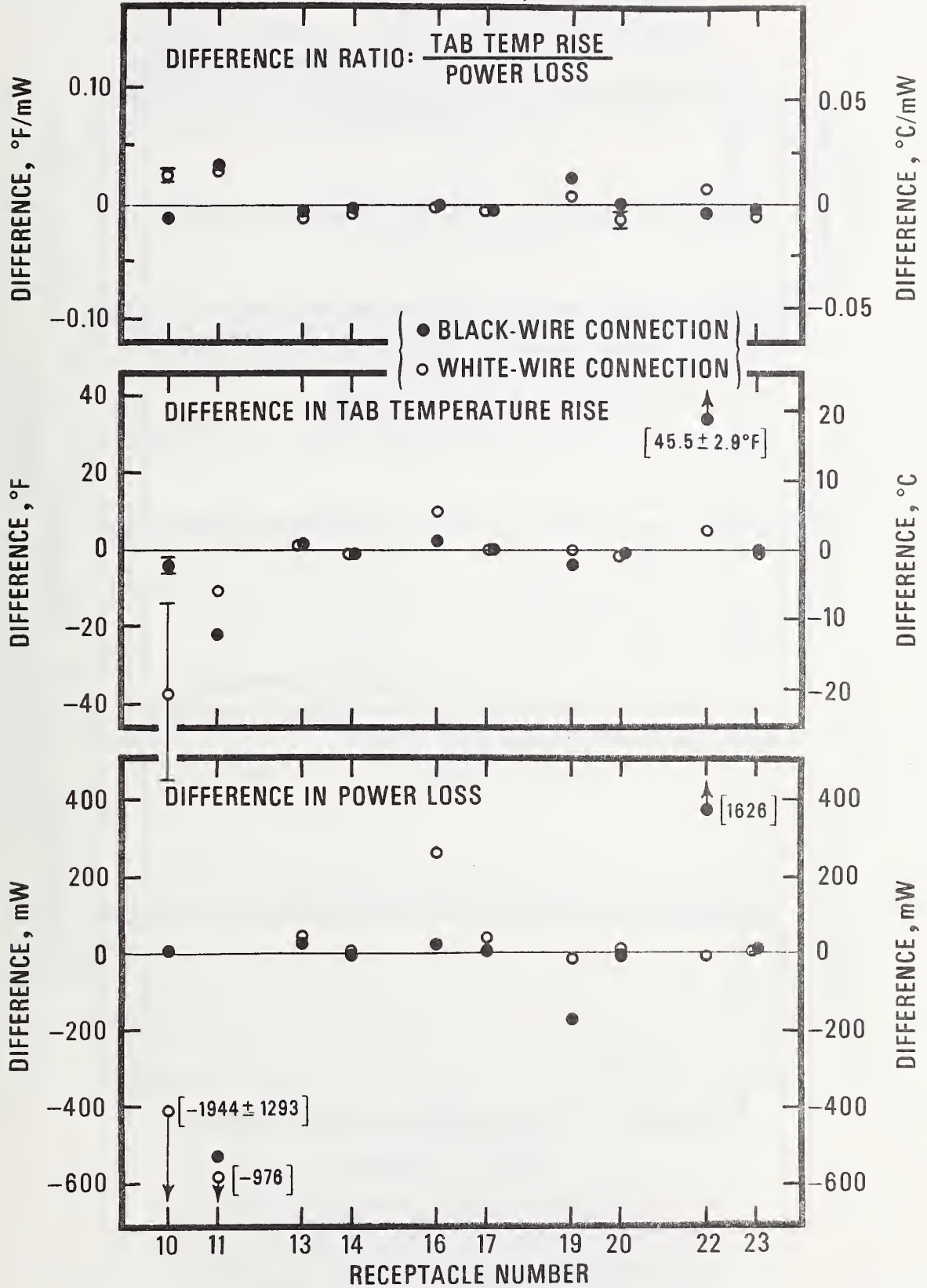

Figure 34. Change in the power loss, the tab temperature rise, and the ratio of the tab temperature rise to the power loss for the black-wire and white-wire connections of the conventional receptacles in Group 1 due to retightening the terminal screws with a torque of 2 lbf · in. Difference equals average of values obtained in tests 79, 80, and 81 minus average of values obtained in tests 69 and 70. The receptacles were spaced two outlet boxes apart, and the test voltage was 10 V(ac) for each of the tests. The bars give the 95% confidence limits for the difference between the averages.

{ SCREW TORQUE = 2 lbf · in }
 { RECEPTACLE SPACING = 0 }

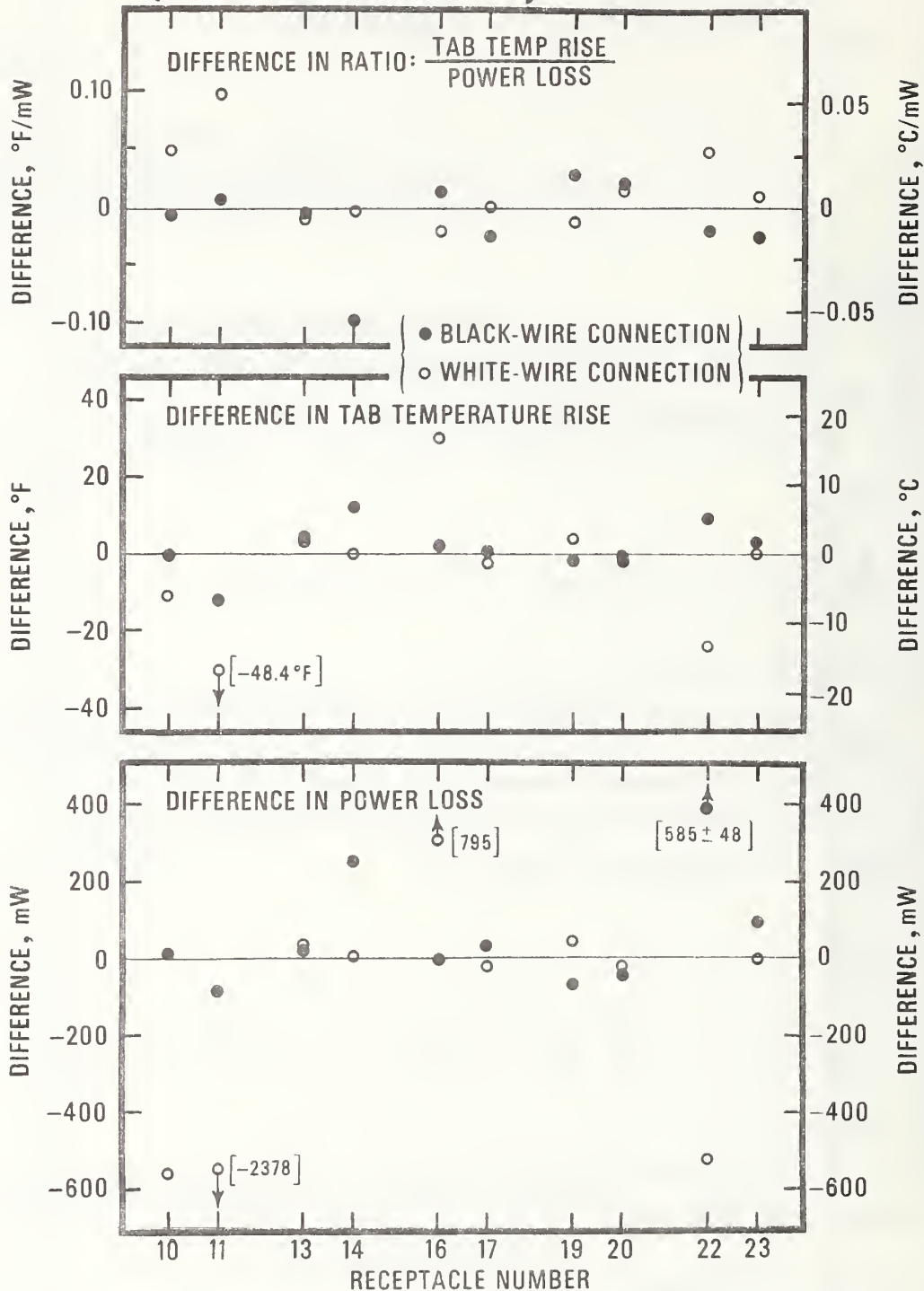

Figure 35. Change in the power loss, the tab temperature rise, and the ratio or the tab temperature rise to the power loss for the black-wire and white-wire connections of the conventional receptacles in Group 1 due to retightening the terminal screws with a torque of 2 lbf · in. Difference equals average of values obtained in tests 202, 203, 204, 205, and 206 minus average of values obtained in tests 17, 18, and 19. The receptacles were installed in adjacent outlet boxes, and the test voltage was 10 V(ac) for each of the tests. The bars give the 95% confidence limits for the differences between the averages.

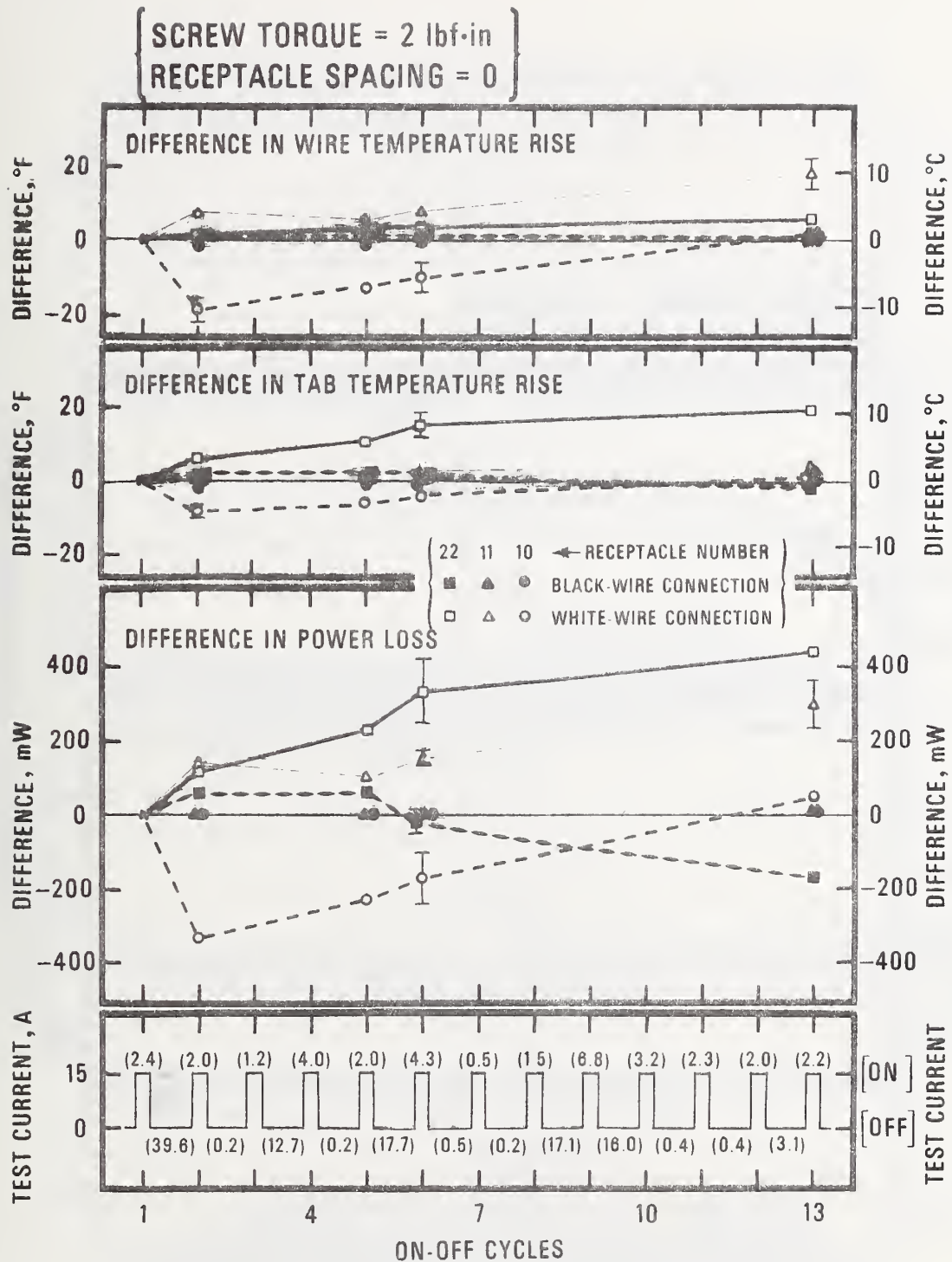

Figure 36. Change in the power loss, the tab temperature rise, and the wire temperature rise for the black-wire and white-wire connections of conventional receptacles No. 10, 11, and 22 as a function of the number of on-off cycles of the test current. The receptacles were installed in adjacent outlet boxes and their terminal screws were tightened with a torque of 2 lbf·in. The test voltage was 115 V(ac) for the values plotted. Difference equals average value during indicated cycle minus average value during first cycle. The bars give the 95% confidence limits for the difference. The figures in parentheses give the time, in hours, that the test current was on and off during each cycle.

{ SCREW TORQUE = 12 lbf·in }
 { RECEPTACLE SPACING = 0 }

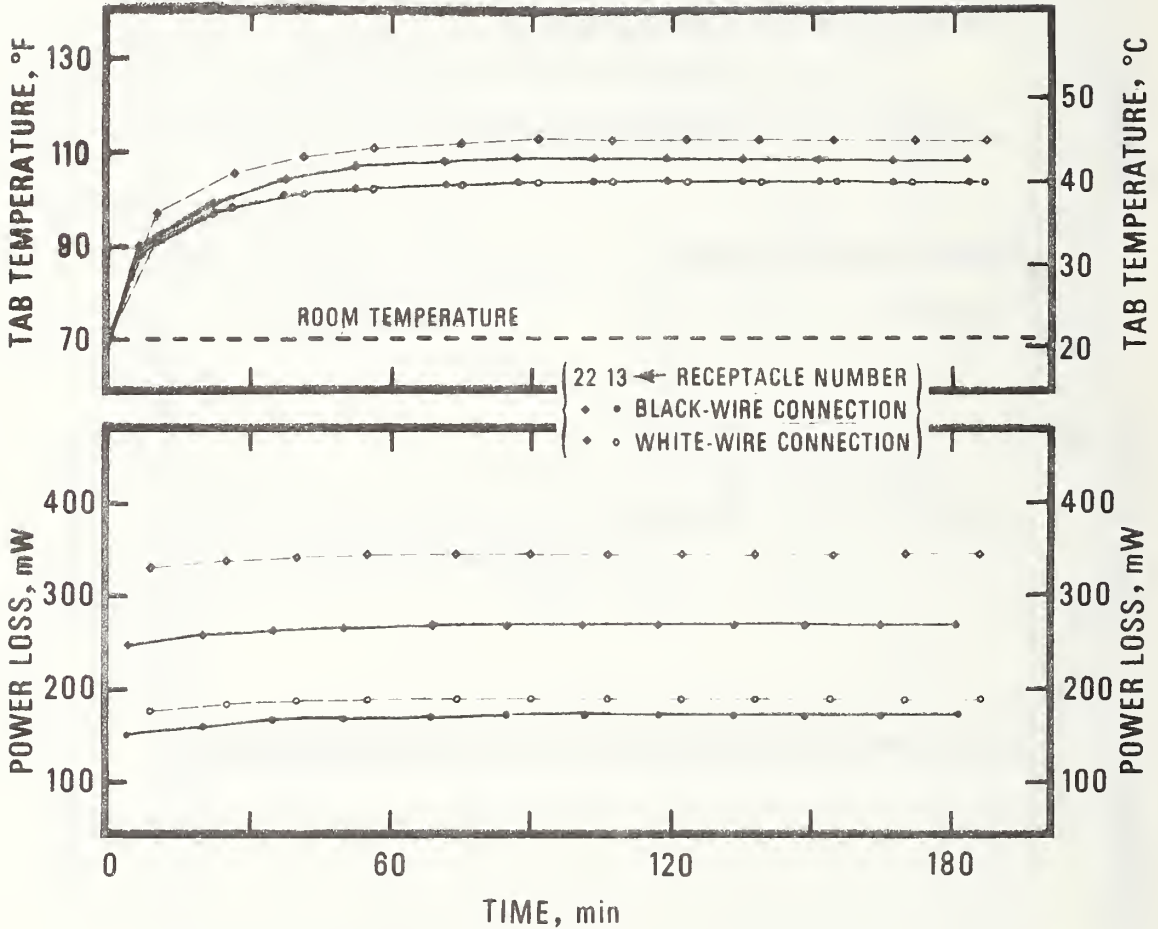

Figure 37. Power loss and tab temperature as a function of time for the black-wire and white-wire connections of the indicated conventional receptacles. The test circuit was energized at time equals 0 by applying a test voltage of 10 V(ac); the test current was maintained at 15 A. The values plotted were obtained in tests 161 through 172: receptacles installed in adjacent outlet boxes, terminal screws tightened with a torque of 12 lbf·in.

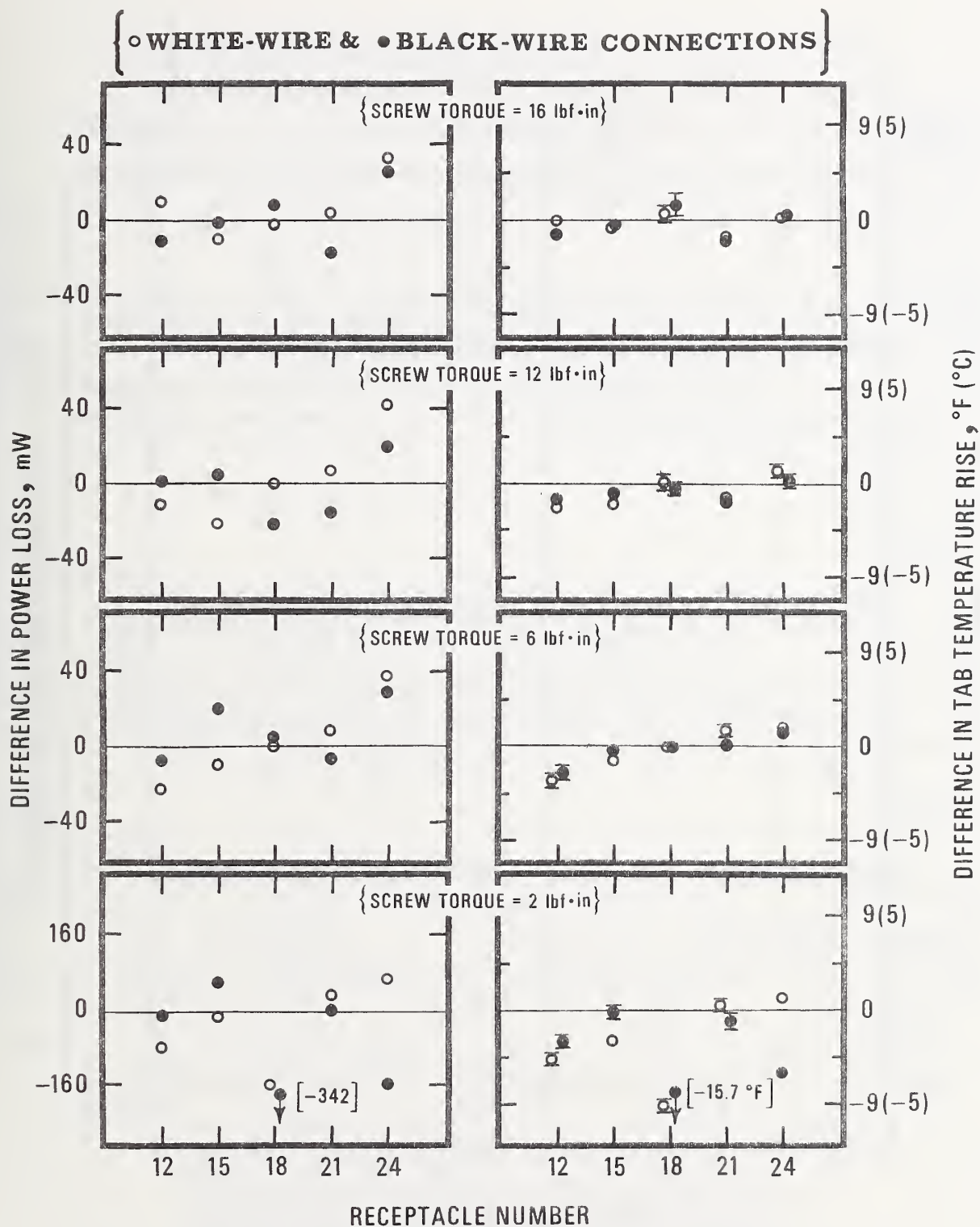

Figure 38. Difference between the values of power loss and tab temperature rise obtained in individual receptacle tests and those obtained in group receptacle tests conducted with the receptacles spaced two outlet boxes apart. Difference equals average of values obtained in individual receptacle tests using a test voltage of 10 V(ac) minus average of values obtained in group receptacle tests using a test voltage of 10 V(ac). Bars give the 95% confidence limits for the difference between the averages.

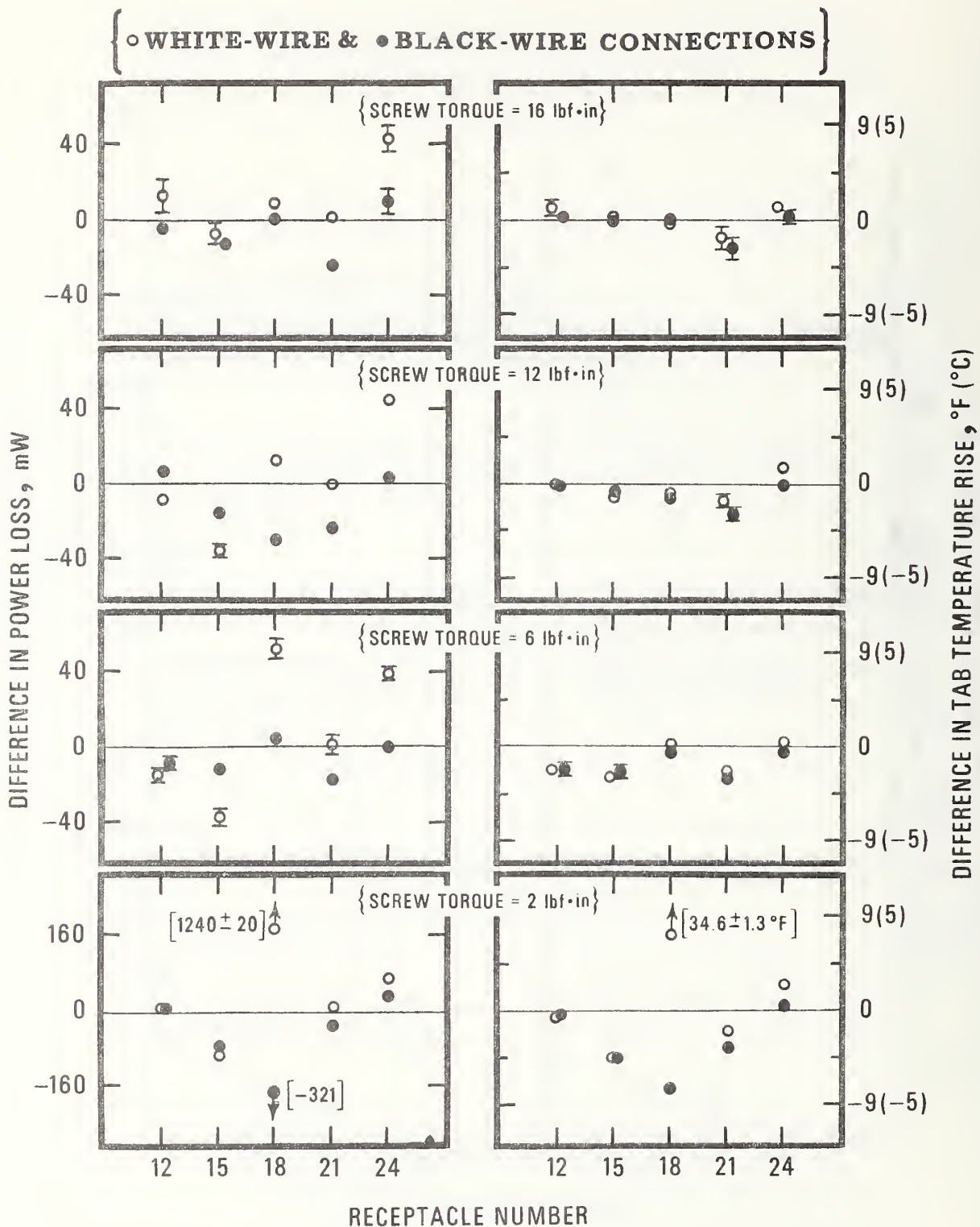

Figure 39. Difference between the values of power loss and tab temperature rise obtained in individual receptacle tests and those obtained in group receptacle tests conducted with the receptacles spaced two outlet boxes apart. Difference equals average of values obtained in individual receptacle tests using a test voltage of 115 V(ac) minus average of values obtained in group receptacle tests using a test voltage of 115 V(ac). Bars give the 95% confidence limits for the difference between the averages.

{ SPLIT-BEAM RECEPTACLE No. 7 }

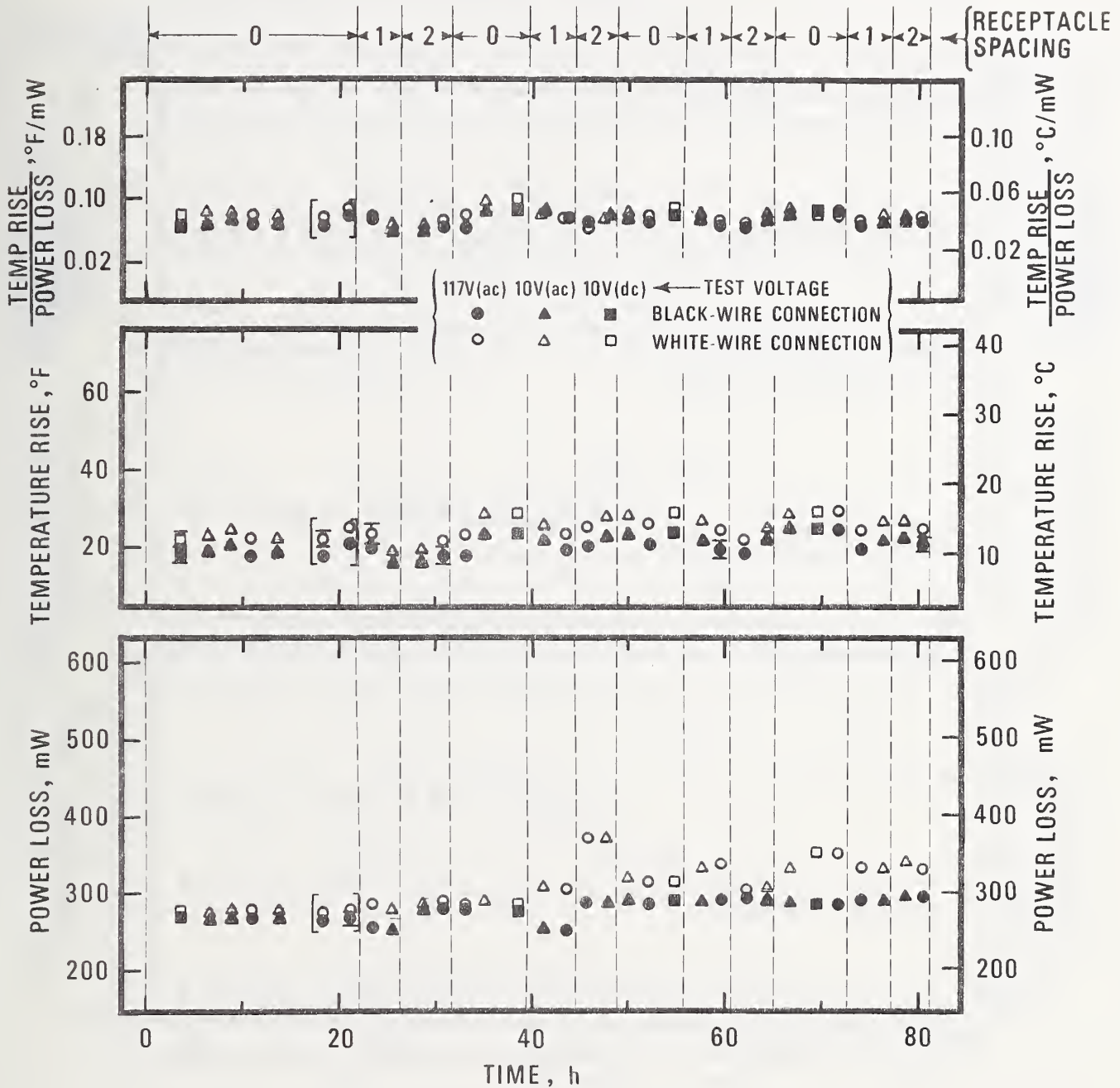

Figure 40. Values of the power loss, the temperature rise, and the ratio of the temperature rise to the power loss for the black-wire and white-wire connections of split-beam receptacle No. 7 plotted as a function of the time that test circuit was energized. Each of the data points represents the average of values obtained in several (2 to 4) tests. The bars give the 95% confidence limits for the averages. The symbol heights are equivalent to about 15 mW, 3 °F, and 0.015 °F/mW for the power loss, the temperature rise, and the ratio, respectively.

{ SPLIT-BEAM RECEPTACLE No. 8 }

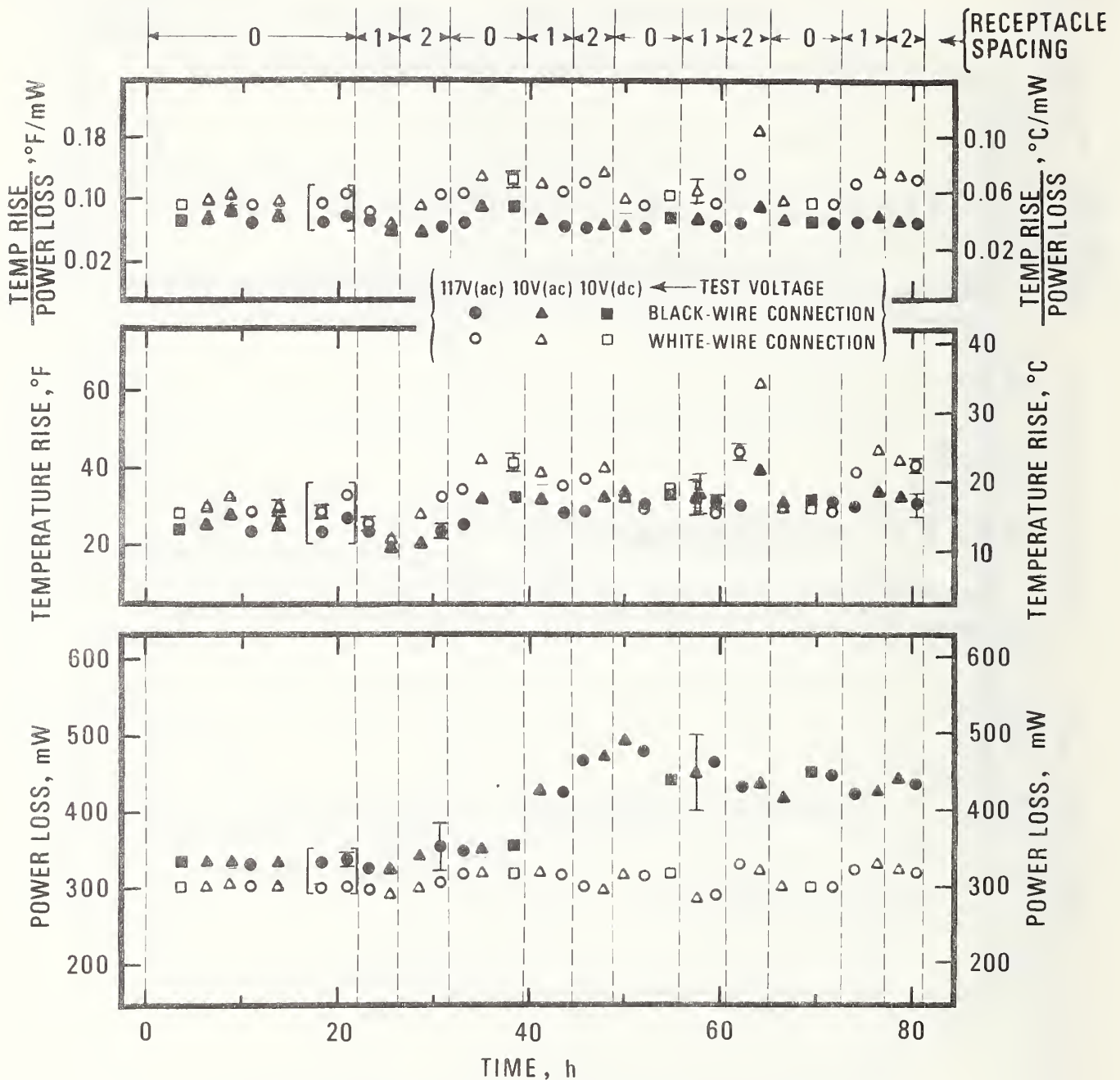

Figure 41. Values of the power loss, the temperature rise, and the ratio of the temperature rise to the power loss for the black-wire and white-wire connections of split-beam receptacle No. 8 plotted as a function of the time that test circuit was energized. Each of the data points represents the average of values obtained in several (2 to 4) tests. The bars give the 95% confidence limits for the averages. The symbol heights are equivalent to about 15 mW, 3 °F, and 0.015 °F/mW for the power loss, the temperature rise, and the ratio, respectively.

{ SPLIT-BEAM RECEPTACLE No. 9 }

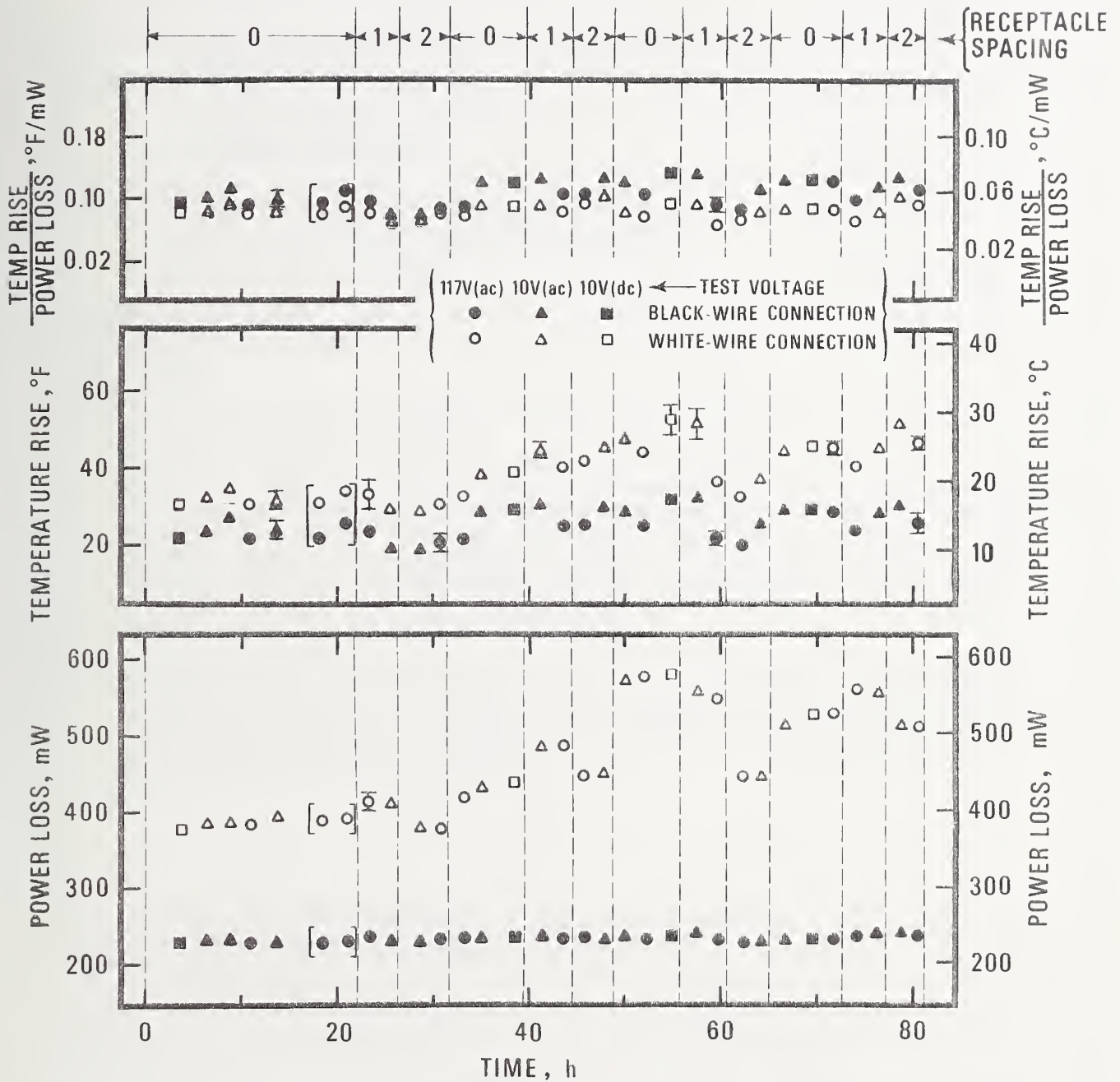

Figure 42. Values of the power loss, the temperature rise, and the ratio of the temperature rise to the power loss for the black-wire and white-wire connections of split-beam receptacle No. 9 plotted as a function of the time that test circuit was energized. Each of the data points represents the average of values obtained in several (2 to 4) tests. The bars give the 95% confidence limits for the averages. The symbol heights are equivalent to about 15 mW, 3°F, and 0.015 °F/mW for the power loss, the temperature rise, and the ratio, respectively.

{ SPLIT-BEAM RECEPTACLE No. 8 }

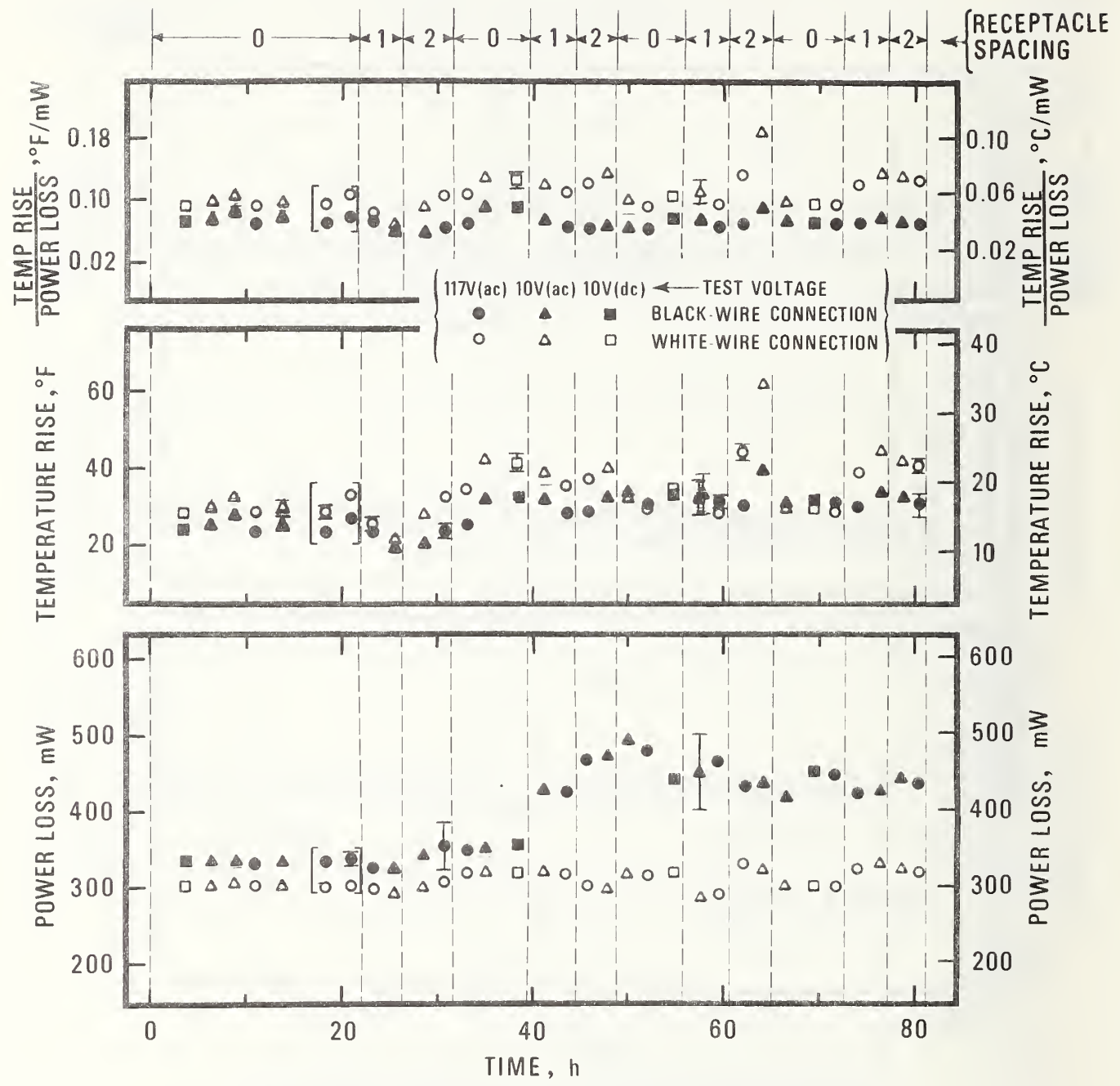

Figure 41. Values of the power loss, the temperature rise, and the ratio of the temperature rise to the power loss for the black-wire and white-wire connections of split-beam receptacle No. 8 plotted as a function of the time that test circuit was energized. Each of the data points represents the average of values obtained in several (2 to 4) tests. The bars give the 95% confidence limits for the averages. The symbol heights are equivalent to about 15 mW, 3 °F, and 0.015 °F/mW for the power loss, the temperature rise, and the ratio, respectively.

{ SPLIT-BEAM RECEPTACLE No. 9 }

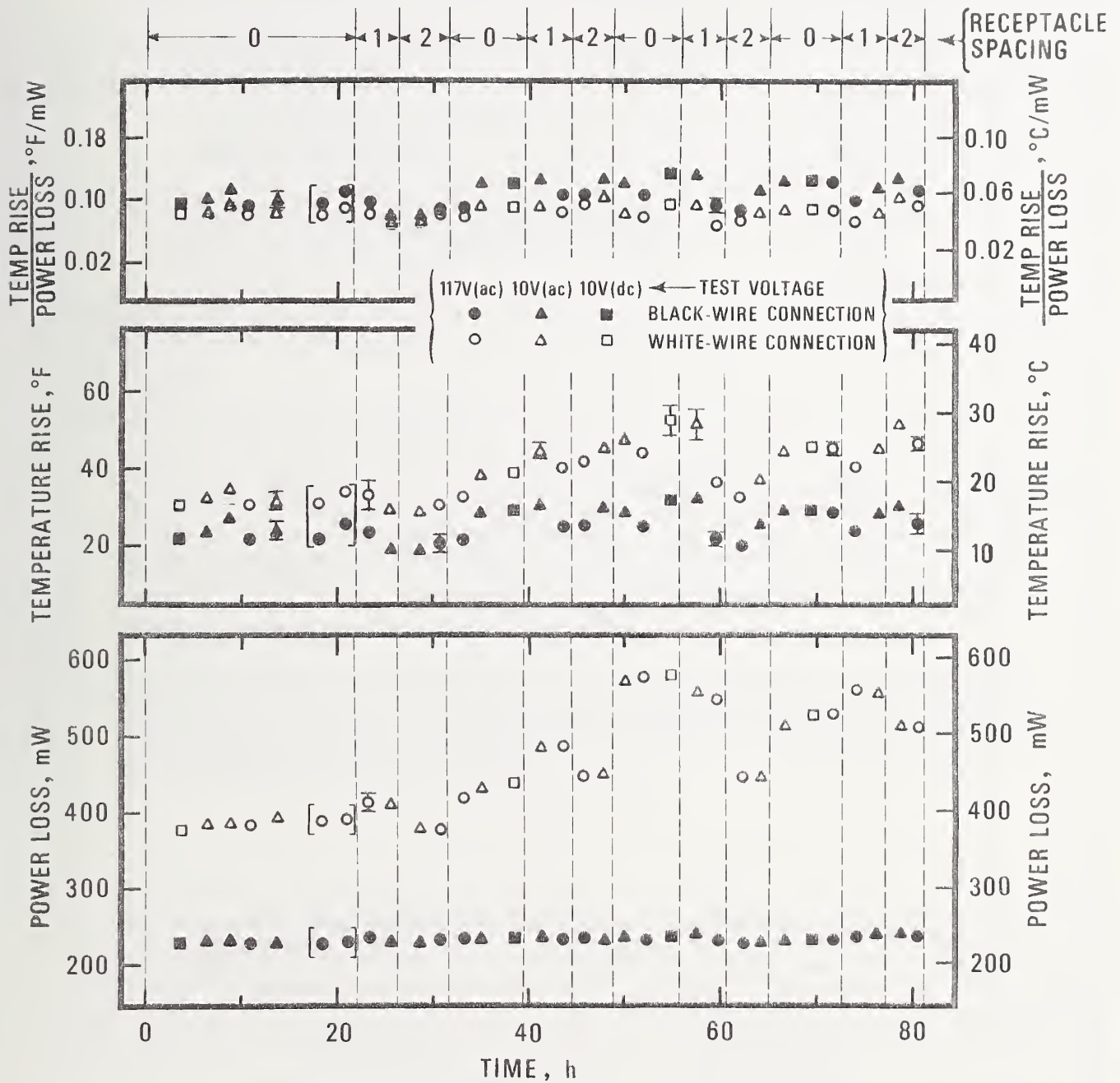

Figure 42. Values of the power loss, the temperature rise, and the ratio of the temperature rise to the power loss for the black-wire and white-wire connections of split-beam receptacle No. 9 plotted as a function of the time that test circuit was energized. Each of the data points represents the average of values obtained in several (2 to 4) tests. The bars give the 95% confidence limits for the averages. The symbol heights are equivalent to about 15 mW, 3°F, and 0.015 °F/mW for the power loss, the temperature rise, and the ratio, respectively.

U.S. DEPT. OF COMM. BIBLIOGRAPHIC DATA SHEET	1. PUBLICATION OR REPORT NO. NBSIR 77-1380	2. Gov't Accession No.	3. Recipient's Accession No.
4. TITLE AND SUBTITLE Experimental Determinations of Temperatures and Power Losses at the Electrical Connections of Some Duplex Receptacles		5. Publication Date April 1978	6. Performing Organization Code 462.03 and 221.11
		7. AUTHOR(S) G.W. Burns, M.G. Scroger, G.A. Evans, R.W. Beausoliel and W. J. Meese	
9. PERFORMING ORGANIZATION NAME AND ADDRESS NATIONAL BUREAU OF STANDARDS DEPARTMENT OF COMMERCE WASHINGTON, D.C. 20234		10. Project/Task/Work Unit No.	
		11. Contract/Grant No. IAA-H-37-73 (120)	
12. Sponsoring Organization Name and Complete Address (Street, City, State, ZIP) Office of Policy Development and Research Department of Housing and Urban Development Washington, D.C. 20410		13. Type of Report & Period Covered Final	
		14. Sponsoring Agency Code	
15. SUPPLEMENTARY NOTES One of a series of reports in a program on the evaluation of innovative electrical connections.			
16. ABSTRACT (A 200-word or less factual summary of most significant information. If document includes a significant bibliography or literature survey, mention it here.) The data presented in this report compare the reliability of power loss determination with the reliability of temperature measurements as a means for determining the quality and adequacy of electrical connections on wiring devices used in branch circuit wiring. The basic premise for the tests presented here is that in the laboratory the determination of power loss is easier, quicker, and not nearly as dependent on environmental factors as temperature. This research indicates that, if power at a specific current level does not exceed some set value(s), temperatures will not be excessive. This investigation also illustrates the overheating problems associated with copper-wire electrical connections. No. 14 copper wire connections frequently showed significant rises in temperatures and significantly increased power losses when tightened to a torque of only 2 lbf·in, as compared to nominally tight connections (6 lbf·in or more).			
17. KEY WORDS (six to twelve entries; alphabetical order; capitalize only the first letter of the first key word unless a proper name; separated by semicolons) Branch circuits; duplex receptacles; electrical connections; power loss; temperatures; thermocouples; wire.			
18. AVAILABILITY <input checked="" type="checkbox"/> Unlimited <input type="checkbox"/> For Official Distribution. Do Not Release to NTIS <input type="checkbox"/> Order From Sup. of Doc., U.S. Government Printing Office Washington, D.C. 20402, SD Cat. No. C13 <input checked="" type="checkbox"/> Order From National Technical Information Service (NTIS) Springfield, Virginia 22151		19. SECURITY CLASS (THIS REPORT) UNCLASSIFIED	21. NO. OF PAGES 65
20. SECURITY CLASS (THIS PAGE) UNCLASSIFIED		22. Price \$5.25	

