

FEDERAL EMERGENCY MANAGEMENT AGENCY



EARTH

QUAKES

EARTHQUAKES

A Teacher's Package for K-6

Acknowledgments

The Federal Emergency Management Agency (FEMA) acknowledges with gratitude the many individuals who provided teaching knowledge, experience, and classrooms in the development of the first and revised versions of EARTHQUAKES - A Teacher's Package for K-6 Grades.

The first version of the teacher's package was developed under the direction of Phyllis R. Marcussio, Director of Publications, National Science Teachers Association: Ms. Marcussio put together an excellent team of editor, illustrator, teacher-writers, subject-matter experts, and reviewers, including —

- Editor: Mary Liston Liepold, Washington, DC
- Illustrator: Forrest Plesko, Superior, WI
- Teacher-Writers: Jeffrey C. Callister, Newburgh, NY
Lenny Coplestone, Bethesda, MD
Gerard F. Consuegra, Rockville, MD
Sharon M. Stroud, Colorado Springs, CO
- Scientist-Writer: Randy Updike, U.S. Geological Survey

The revised version included teacher-writers Jeffrey Callister, Gerard Consuegra, and Sharon Stroud, along with Elizabeth Draper, Sheryl Eggers, and Molly Morrow from Portland, OR. Elizabeth, Sheryl, and Molly have participated as instructors in numerous FEMA workshops for educators on the K-6 teacher's package. Randy Updike's expanded coverage of earthquake topics remains in the Appendix.

Funding for this publication was allocated to FEMA by The United States Congress, under the Earthquake Hazards Reduction Act of 1977, as amended. FEMA hereby authorizes and encourages the educational community to reproduce this product in its entirety and to disseminate it at no cost to the recipient.

Single copies of this publication may be obtained from FEMA at no cost by contacting FEMA's Publication Warehouse at 1-800-480-2520.

Foreword to the Second Edition

The original *Earthquakes - A Teacher's Package for K-6* (FEMA 159) was developed as a joint effort of the Federal Emergency Management Agency (FEMA) and the National Science Teachers Association (NSTA) under contract with FEMA. NSTA's project team produced an excellent product. Since its publication in 1988, over 50,000 teachers have requested copies.

This revised version brought members of the original project team together with a group of teachers who had used the materials extensively in their classroom and served as teacher-educators at FEMA's Tremor Troop workshops. About 75% of the original material remains unchanged: a few activities were removed and a few added.

A major change was the addition of assessments throughout the units. The examples we provide relate to life outside the classroom and/or activities similar to those of scientists. We also added matrices linking activities to the National Science Education Standards. You'll find these matrices in the Appendix, along with a new Glossary.

Features of This Package

First of all, you do not need an education in science to use this package. Background for each unit covers all the science concepts treated in the lessons. You will have all the information you need, no matter what grade you teach and what kind of science preparation you've had. This is science made simple and fun, without sacrificing scientific accuracy.

Because young students learn best by doing, the lessons in this teaching package are primarily a series of hands-on experiences. You will need to locate simple materials for some of the lessons. Others require only things that are already in your classroom. At the end of each unit, you will find Masters ready to reproduce for transparencies, handouts, and worksheets. Masters are identified in the text by name and number.

Because students learn holistically, the lessons include methods and materials from language arts, mathematics, social studies, music, and the other fine arts, as well as physical science. Learning Links, found near the beginning of each set of activities, summarize some of these interdisciplinary connections. We also provided Scope and Sequence charts at the beginning of each unit.

Extensions, provided in each set of activities, suggest ways for your students to learn more about the topics. Use the Extensions for individual enrichment or to provide additional experiences for the entire class. Each set of activities also includes vocabulary, teaching tips, and illustrations. Matrices linking activities to the National Science Education Standards are located in the Appendix.

Organization and Overview

The Teacher's Package has five units. Each of the first four units is divided into three levels: Level 1, for grades K-2; Level 2, for grades 3-4; and Level 3, for grades 5-6. Since classes and individuals vary widely you may often find the procedures in the other levels helpful for your students. The last unit has four parts with activities for students in all grades, K-6.

Unit I, *Defining an Earthquake*, builds on what students already know about earthquakes to establish a working definition of the phenomenon. Legends from near and far encourage children to create their own fanciful explanations, paving the way for the scientific explanations they will begin to learn in this unit.

Unit II, *Why and Where Earthquakes Occur*, presents the modern scientific understanding of the Earth's structure and composition, and relates this to the cause of earthquakes.

Unit III, *Physical Results of Earthquakes*, provides greater understanding of the processes that shape our active Earth. Earthquakes are put in the context of the large- and small-scale changes that are constantly at work on the continents as well as the ocean floor.

Unit IV, *Measuring Earthquakes*, explains earthquakes in terms of wave movement and introduces students to the far-ranging effects of earthquakes.

Unit V, *Earthquake Safety and Survival*, focuses on what to expect during an earthquake; how to cope safely; how to identify earthquake hazards; and how to reduce, eliminate, or avoid them.

Units I through V are intended to be used in the order presented. When students ask questions about earthquake safety, the introduction in Unit V will help you answer their questions. You may want to take time then to do a few activities to enable students to develop quake-safe skills.

Contents

Unit I: Defining an Earthquake

Level 1. What Is an Earthquake.....	13
Level 2. People Explain Earthquakes.....	19
Level 3. Energy Waves Cause Earthquakes.....	25

Unit II: Why and Where Earthquakes Occur

Level 1. Inside Planet Earth.....	39
Level 2. Plates Going Places.....	43
Level 3. Layers, Plates, and Quakes.....	51

Unit III: Physical Results of Earthquakes

Level 1. Earthquakes Shape Our Earth.....	65
Level 2. Landscape on the Loose.....	69
Level 3. Building Up and Breaking Down.....	79

Unit IV: Measuring Earthquakes

Level 1. Earthquakes Great and Small.....	93
Level 2. Different Shakes for Different Quakes.....	99
Level 3. Sizing Up Earthquake Waves.....	103

Unit V: Earthquake Safety and Survival

Part 1. What Happens During an Earthquake.....	117
Part 2. Hunt for Hazards.....	125
Part 3. Prepare and Share.....	133
Part 4. Evacuation Drill.....	139

Appendix

Earthquake Background

Book of Legends

National Science Education Standards Matrices

Glossary

Earthquake Curriculum, K-6 List of Line Masters

UNIT I

Master 1a.	U.S. Map (without state names)
Master 1b.	U.S. Map
Master 2.	The Turtle Tale
Master 3.	Turtle Tale Pop-up Puppet
Master 4.	Turtle Dot-to-Dot
Master 5.	World Map
Master 6.	World Map with Legend Sites
Master 7.	World Map with Epicenters
Master 8.	Elastic Rebound
Master 9.	Dresser Drawers
Master 10a.	Earthquake Terms
Master 10b.	Earthquake Terms Worksheet
Master 11.	U.S. Map with Epicenters

UNIT II

Master 12a.	Layers of the Earth
Master 12b.	Earth Layers Worksheet
Master 13.	Earth Plates
Master 14a.	Earth Plate Puzzle Pieces
Master 14b.	Earth Plate Puzzle Pieces
Master 15.	A Pizza the Earth
Master 16.	Graph of the Earths Layers
Master 17.	Plate Boundaries Map
Master 18.	Convection Currents and Plate Cross Section
Master 19.	Formation and Breakup of Pangaea
Master 20a.	Pangaea Flip Book
Master 20b.	Pangaea Flip Book
Master 20c.	Pangaea Flip Book
Master 20d.	Pangaea Flip Book

UNIT III

Master 21.	Fault Movements
Master 22.	Rural Community After an Earthquake
Master 23.	Fault Model
Master 24a.	Tsunami Facts
Master 24b.	Notable Tsunami
Master 25a.	Landscape Regions Worksheet
Master 25b.	Landscape Regions of U.S.
Master 25c.	Landscape Regions Key
Master 26.	Ocean Bottom

UNIT IV

Master 27.	Shake Table
Master 28.	Modified Mercalli Scale
Master 29.	Seismographs
Master 30.	Seismogram Worksheet
Master 31.	Earthquake Magnitude and Energy
Master 32.	Seismogram Showing Amplitude
Master 33.	Earthquake Severity Worksheet
Master 34.	P-Wave Motion and S-Wave Motion
Master 35.	The S-Wave Machine
Master 36a.	KWAT Television Script
Master 36b.	Wattsville Map
Master 36c.	Wattsville Map Key

UNIT V

Master 37.	Earthquake Hazard of the U.S.
Master 38.	Earthquake Simulation Script
Master 39.	Drop, Cover and Hold
Master 40.	Coalinga Schools Report
Master 41.	Fourth Grade Classroom
Master 42.	Classroom Hazard Hunt
Master 43a.	Home Hazard Hunt Worksheet
Master 43b.	Home Hazard Hunt Worksheet
Master 43c.	Home Hazard Hunt Worksheet
Master 44.	Quake-Safe Home Checklist
Master 45.	Neighborhood Hazard Hunt
Master 46.	Safety Rules for Shoppers
Master 47a.	Community Hazard Hunt
Master 47b.	Community Hazard Hunt
Master 47c.	Community Hazard Hunt
Master 48.	Drill and Evacuation Checklist
Master 49.	Home Earthquake Safety



I



Defining an Earthquake

Earthquake Curriculum, K-6 -- Scope and Sequence Chart

Unit I: Defining an Earthquake

Level	Concept	Laboratory	Mathematics	Language Arts	Social Studies	Art
K-2	<p>An earthquake is a sudden, rapid shaking of the Earth caused by the release of energy stored in rocks.</p> <p>Legends are traditional narrative explanations of natural phenomena that evolve when scientific explanations are not available.</p>	<p>Sand and box demonstration of earthquakes</p>		<p>Vocabulary development of earthquake words</p> <p>Original earthquake legends</p>	<p>Effects of earthquakes on model buildings</p> <p>Effect of earthquakes on people</p> <p>Cultures and legend origins</p>	<p>Illustrations of legends</p> <p>Illustrations of Earth's interior</p> <p>Mural making</p>
3-4	<p>An earthquake is a sudden, rapid shaking of the Earth caused by the release of energy stored in rocks.</p> <p>Legends are traditional narrative explanations of natural phenomena which evolve, when scientific explanations are not available.</p> <p>Earthquake energy is released in the form of waves.</p>	<p>Silicone putty rocks</p> <p>Gelatin simulation of earthquakes</p>		<p>Earthquake legends</p> <p>Paragraph writing</p> <p>Class discussion</p>	<p>Map study of cultures associated with earthquake legends</p> <p>Map study of epicenters</p>	<p>Illustrations of earthquake causes</p> <p>Illustrations of earthquake legends</p>
5-6	<p>Earthquakes result from the build-up and release of energy stored in rocks.</p> <p>Earthquakes occur over much of the world and the United States.</p> <p>Various societies have produced earthquake legends to explain these natural occurrences.</p>	<p>Stick simulation of earthquakes</p> <p>Fault action game</p>	<p>Map scales to measure distances</p>	<p>Vocabulary development of earthquake words</p> <p>Earthquake legends</p> <p>Oral reading and note taking</p>	<p>Map study of earthquake locations</p> <p>Map study of cultures associated with earthquake legends</p> <p>Map study of state locations</p>	<p>Sign making</p> <p>Diagram making</p>

I

Defining an Earthquake

An earthquake is a natural phenomenon like rain. Earthquakes have occurred for billions of years. Descriptions as old as recorded history show the significant effects they have had on people's lives. Long before there were scientific theories for the cause of earthquakes, people around the world created folklore to explain them. In simple terms, earthquakes are caused by the constant motion of Earth's surface. This motion creates buildup and releases energy stored in rocks at and near the Earth's surface. Earthquakes are the sudden, rapid shaking of the Earth as this energy is released.

At half-past two o'clock of a moonlit morning in March, I was awakened by a tremendous earthquake, and though I had never before enjoyed a storm of this sort, the strange, thrilling motion could not be mistaken . . . Both glad and frightened, [I shouted]: "A noble earthquake! A noble earthquake!" feeling sure that I was going to learn something.

John Muir, 1872

Defining an Earthquake

An earthquake is a natural occurrence, like rain. Earthquakes affect almost every part of the Earth and like rain they can be either mild or catastrophic. Over the course of geological time, earthquakes, floods, and other natural events have helped to shape the surface of our planet.

An earthquake may last only a few seconds, but the processes that cause earthquakes have operated within the Earth for millions and millions of years. Until very recently, the cause of earthquakes was an unsolved mystery. It was the subject of fanciful folklore and equally fanciful learned speculation by peoples throughout the world.

In a legend from Siberian Kamchatka, a god named Tuli drives an Earth-laden sled pulled by flea-infested dogs. When the dogs stop to scratch, the Earth shakes.

Some say the Earth was fevrous [feverish] and did shake.
Shakespeare, Macbeth, III

In the mid-1960s, many scientific observations and explanations of earthquakes came together in the theory of plate tectonics. We'll be exploring that subject in later units. In this unit we consider both scientific and popular explanations for the phenomenon and look at the patterns of earthquake occurrence worldwide.

An Earthquake Is . . .

An earthquake is a sudden, rapid shaking of the Earth caused by the release of energy stored in rocks. This is a brief definition which students of all ages can master. A full definition of the term, however, would need to include a good deal more information.

Students may be surprised that we speak of rocks and rock layers, because in many places the rock material of the Earth's crust is covered by accumulations of sand or soil. Remind them that even beneath the sediment in river valleys, plains, and beach areas, some kind of rock is always present.



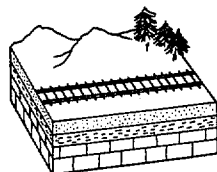

Pressure Direction

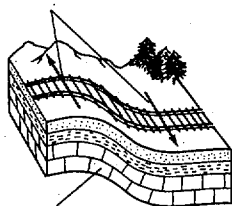

Deformed Rocks

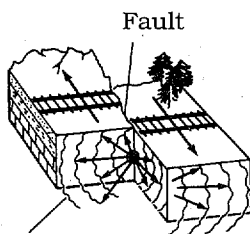

Earthquake Waves

Earthquake shaking may cause loss of life and destruction of property. In a strong earthquake the ground shakes violently. Buildings may fall or sink into the soil. Rocks and soil may move downhill at a rapid rate. Such landslides can bury houses and people.

Folklore and Scientific Theory

Because strong earthquakes have such disastrous effects, it is not surprising that people have always looked for ways to explain their origin. We find many nonscientific explanations of earthquakes in the folklore of civilizations around the world. We call these traditional narratives earthquake legends. Some of them are still being told today.

What we have learned in recent years, however, largely from the study of earthquakes, is that the Earth around us is not static, like a stage set for a play. The Earth's rock layer is broken into large pieces. These pieces are in slow but constant motion. They may slide by smoothly and almost imperceptibly.

From time to time, the pieces may lock together, and energy that accumulates between the pieces may be suddenly released. This sudden release of energy, like the snapping of a rubber band that has been stretched too far, is what we call *elastic rebound*. Energy is released and travels through the Earth in the form of waves. People on the surface of the Earth experience an earthquake.

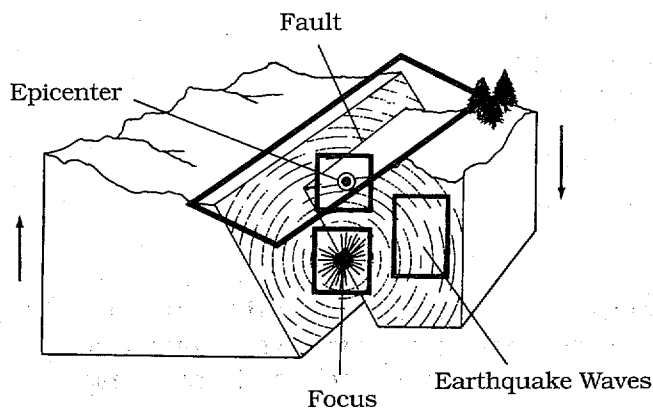

Earthquake Epicenters

The *epicenter* of an earthquake is the place on the Earth's surface directly above the focus (or *hypocenter*), the place inside the Earth where the quake originates. Earthquake foci are usually somewhere between the surface and 100 km in depth. In some areas, however, foci may be as deep as 700 km.

Even a glance at an earthquake epicenter map shows that most earthquakes have occurred in certain well-defined regions of the Earth. Because these regions tend to be relatively long and narrow, they are sometimes referred to as earthquake *belts*.

One large belt of epicenters runs through the Mediterranean Sea, Asia Minor, the Himalayan mountains, and into the eastern Indian Ocean. A second large belt runs northward through the western Pacific Ocean, the Japanese islands, the Aleutian islands, and the west coasts of North and South America. The longest belt of earthquake epicenters runs through the central regions of most ocean basins. The world epicenter map also shows some shorter belts of epicenters.

Chances are, even if your school is far from any earthquake epicenter, your students already have some ideas about earthquakes and what causes them. In the lessons that follow, you will invite them to tell you what they think.

Master 7, World Map with Epicenters. The dots represent earthquakes with magnitudes ≥ 5.0 recorded from 1980-1990 by the National Earthquake Information Center, USGS.

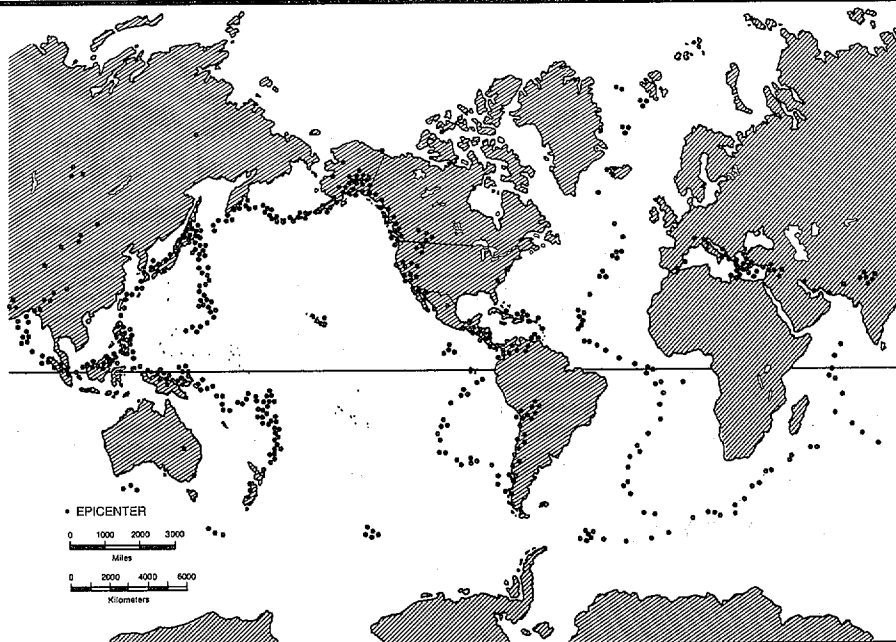

What Is an Earthquake?

Vocabulary

earthquake
legends

Content Concepts

1. An earthquake is a sudden, rapid shaking of the Earth caused by the release of energy stored in rocks.
2. Legends are traditional narrative explanations of natural phenomena that evolve when scientific explanations are not available.

Objectives

Students will

- describe personal experiences with earthquakes.
- construct an earthquake model.
- observe effects of a simulated earthquake.
- define the term *legend*, and listen to a legend.
- suggest possible causes of earthquakes.
- write and illustrate original legends.
- draw pictures to illustrate their ideas about the Earth's interior.

Assessment

Restate The Turtle Tale. Draw or tell three imaginative, non-scientific explanations for Earth movement.

Learning Links

Language Arts: Writing a description of a demonstration (older students), sharing ideas about the possible causes of earthquakes, building vocabulary, listening to a legend, creating an original legend

Art: Illustrating the legends, expressing ideas about the Earth's interior in drawing, contributing to a mural

Social Studies: Observing the effects of a simulated earthquake on model buildings, predicting the effects on people's lives, discussing a Native American legend, locating San Gabriel on a U.S. map

Activity One: Tremble Here, Tremble There

Materials for the teacher

- A small table or desk that moves easily

Materials for each small group of students

- A shallow box partially filled with sand or soil
- An assortment of paper plates, cups, and small boxes that can be stacked to represent a building.

Procedure

1. Introduce the topic with a class discussion based on the following questions:

What does the word *quake* mean?

What do we mean when we say people are “quaking in their boots”? (Invite students to imitate a person trembling.)

Have you ever been on a bridge when it shook from heavy traffic, or near the railroad tracks when a train passed over? (Invite students to demonstrate shaking and vibrating.) What do you suppose is happening to the Earth when there is an earthquake?

Has anyone here ever felt an earthquake? (Allow students time to express their observations and feelings.)

earth • quake

An earthquake is a sudden, rapid shaking of the Earth caused by the release of energy stored in rocks.

leg • ends

Legends are traditional narrative explanations of natural phenomena that evolve when scientific explanations are not available.

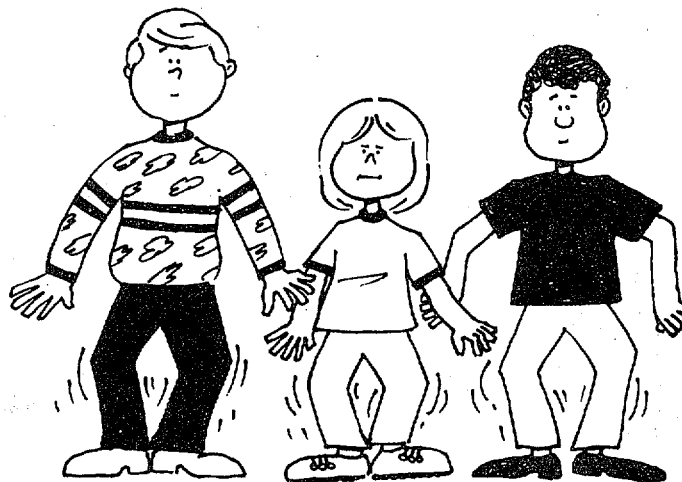

2. Tell students they are going to make a model to demonstrate what happens during an earthquake. Follow these steps:

- a. Invite a small group of students to pile plates, cups, and small boxes on top of each other in the filled box to form a tall structure. (Either have enough materials for each group to construct one model, or have the groups take turns.)
- b. Place the large box on the cart, table, or desk.
- c. Shake the cart, table, or desk until the structure topples.
- d. Ask the students to comment on what they see.

What does the sand or soil represent? (the Earth)

What do the plates, cups, and boxes represent? (a tall building)

What moves? (the Earth and the building)

What happens to the building? (various degrees of damage)

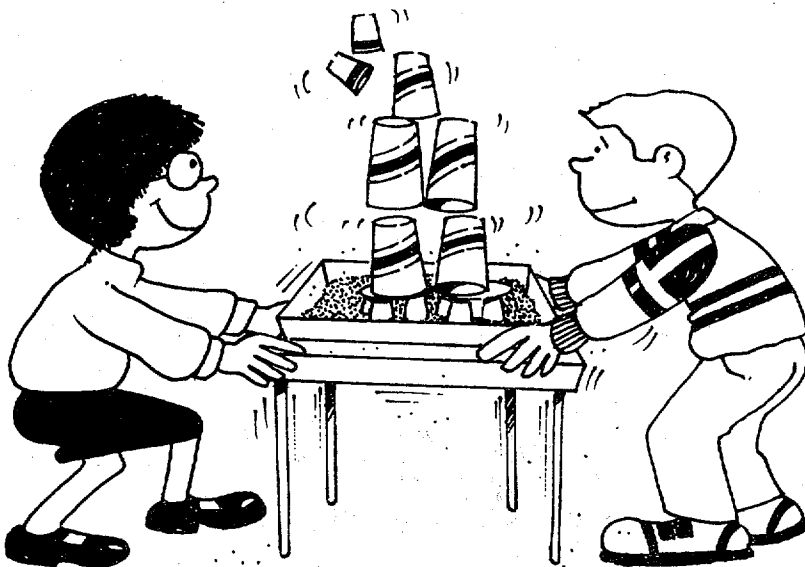

Children will enjoy simulating various levels of force and observing the results.

Activity Two: Tremors and Turtles

Materials for the teacher

- Master 1a, U.S. Map
- Master 2, The Turtle Tale

Materials for each student

- 2 small (6") paper plates
- 1 straw
- Green construction paper
- Handout from Master 3, Turtle Tale Pop-Up Puppet
- Scissors
- Markers or crayons
- Stapler

Teacher Take Note: See the Appendix, Earthquake Legends, for more tremor tales from around the world.

Procedure

1. Discuss the origin of legends.

How can we understand about earthquakes? (from science)

Yes, but earthquakes have been happening for a long time, and we have only been studying them with scientific instruments for a short time. How do you suppose people explained them before that? (with stories)

These stories are called legends.

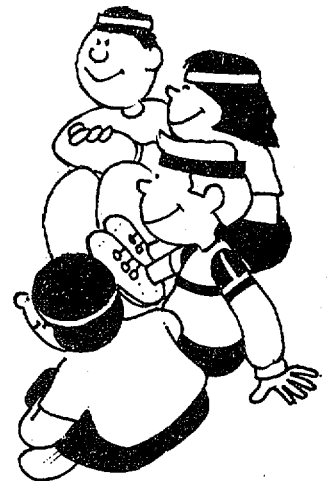
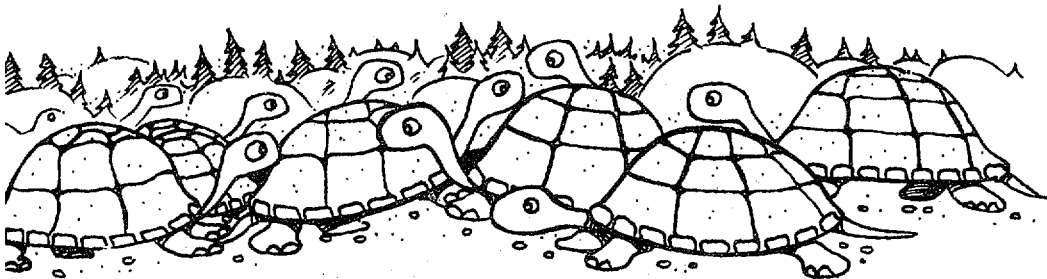

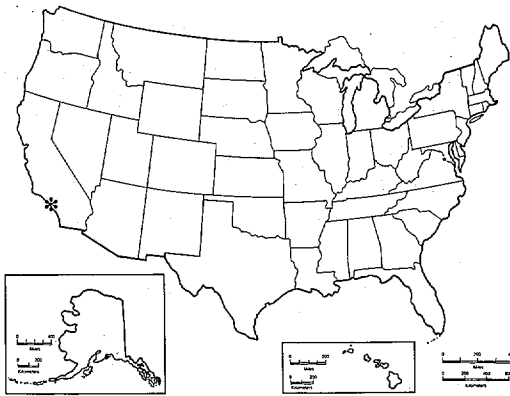

Master 1a, U.S. Map. San Gabriel is marked with an asterisk (*)

Teacher Take Note: Encourage older students to design their own puppets. Younger students may enjoy the turtle dot-to-dot exercise. (Master 4)

2. Point out the San Gabriel Valley on a U.S. map. (Indicate the southwestern part of California, in the neighborhood of Los Angeles—see map.)

3. Introduce the story on Master 2, *The Turtle Tale*, and read it aloud. This is a story that was told by a group of Native Americans who lived where earthquakes are common, in the San Gabriel Valley. People call them the *Gabrielinos* (Ga • bree • uh • leé • nos).

4. Discuss the story.

Did you enjoy the story? Why or why not?

Do you think the story is true? Why or why not? (Students will give a variety of reasons why it is not: Turtles are not that big. Turtles are not that strong. Turtles can't talk.)

Why do you think the Indians developed this story? (When an earthquake or any other frightening event occurs, people want to understand what causes it. Understanding helps them to be less afraid.)

Have you ever asked an older person to explain something that frightened you, and felt better afterwards?

5. Have students make a *Turtle Tale Pop-Up Puppet*. Distribute Master 3 (pattern) to students and give these instructions:

Staple plates together top to top creating a rounded shell for the turtle.

Copy pattern onto green construction paper.

Cut out 4 feet, 1 head, and 1 tail.

Attach feet onto shell (paper plates).

Staple tail to one end of the straw and the head to the other.

Slip straw between plates at a space between staples.

Decorate the shell.

Pull the tail to make the head go into the shell. Push the tail to make it come out again.

6. Have students act out the legend of the *Turtle Tale* with their puppets. You will need seven students to portray the turtles and one for the Great Spirit. Students can mime the action and dialogue as the teacher reads aloud.

Activity Three: Earth Mural

Materials for the teacher

- A large roll of paper for the mural

Materials for each small group of students

- Drawing paper and crayons or oil pastels
- Scissors

Procedure

1. Ask each student to draw a large circle representing the Earth and draw a picture of what there might be inside to make it move. Help students dictate or write explanations that match their drawings.
2. Create a class mural by directing the students to cut out their drawings and paste them to a large piece of paper. The explanations students have written or dictated may be displayed beside the drawings.
3. Share all the student stories and the legends. Accept all ideas without evaluation. End the lesson without providing any further information as to the actual causes of earthquakes. (Direct curious students to children's encyclopedias and other classroom or library reference materials. When the discussion resumes in the next lesson, you will find that students have gained some information on their own.

One group of first graders made these drawings of the Earth's insides.

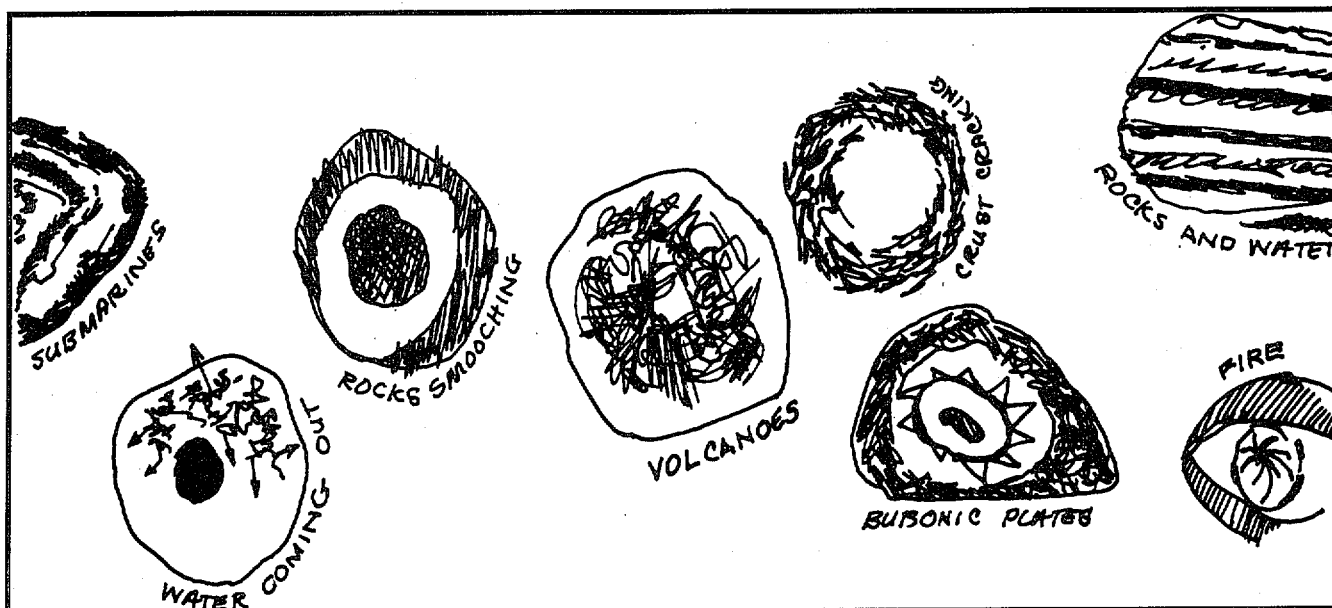

Extensions

1. Ask students to create their own legends to explain earthquakes. Have them dictate, draw, or write their stories.
2. Act out the original legends with paper bag puppets. Provide lunch bags and art materials. Give the students time to make their puppets and rehearse before the final presentation.
3. Ask the children to describe an imaginary journey to the center of the Earth. What might they find there that could cause earthquakes?

People Explain Earthquakes

Vocabulary

earthquake
legend
culture

Learning Links

Language Arts: Class discussion, writing expository paragraphs, sharing ideas

Social Studies: Locating countries on the world map

Art: Illustrating students' earthquake theories, illustrating legends

Content Concepts

1. An earthquake is a sudden, rapid shaking of the Earth caused by the release of energy stored in rocks.
2. Legends are traditional narrative explanations of natural phenomena that evolve when scientific explanations are not available.
3. Earthquake energy is released in the form of waves.

Objectives

- Students will
- describe personal experiences with earthquakes.
 - write and illustrate a paragraph about what they think causes earthquakes.
 - read and illustrate earthquake legends.
 - locate the cultures that developed the various legends on a world map.
 - compare these locations to the major areas of earthquake activity around the world.
 - state what scientists now believe is the cause of earthquakes.
 - observe the effects of a simulated earthquake.

Assessment

Explain or draw a picture of what scientists believe is the cause of earthquakes.

Activity One: Earthquake Experiences

Materials for the teacher

- Magazine or newspaper accounts of earthquakes, or books, slides, movies, and other media dealing with the subject

Materials for the students

- Drawing paper
- Crayons or markers
- Tape

Procedure

1. Begin a discussion by asking students what they think an earthquake is. List responses on the board.
2. Ask if any of your students has ever experienced an earthquake. Invite those who have to share their experiences with the class.
3. If the students do not have much personal experience to draw on, use some of the resources suggested above to provide a basis for the unit. You may also want to invite someone who has experienced an earthquake to visit the class.
4. Distribute paper and art supplies. Ask the students to make drawings illustrating what they think causes earthquakes. They may write paragraphs to accompany the pictures and combine them as a display for the wall or bulletin board. Volunteers can present their ideas to the class. Make no comments about the correctness of their ideas at this point.

earth • quake

An earthquake is a sudden, rapid shaking of the Earth caused by the release of energy stored in rocks.

leg • ends

Legends are traditional narrative explanations of natural phenomena which evolve when scientific explanations are not available.

cul • ture

A culture is the special way of life common to a group of people.

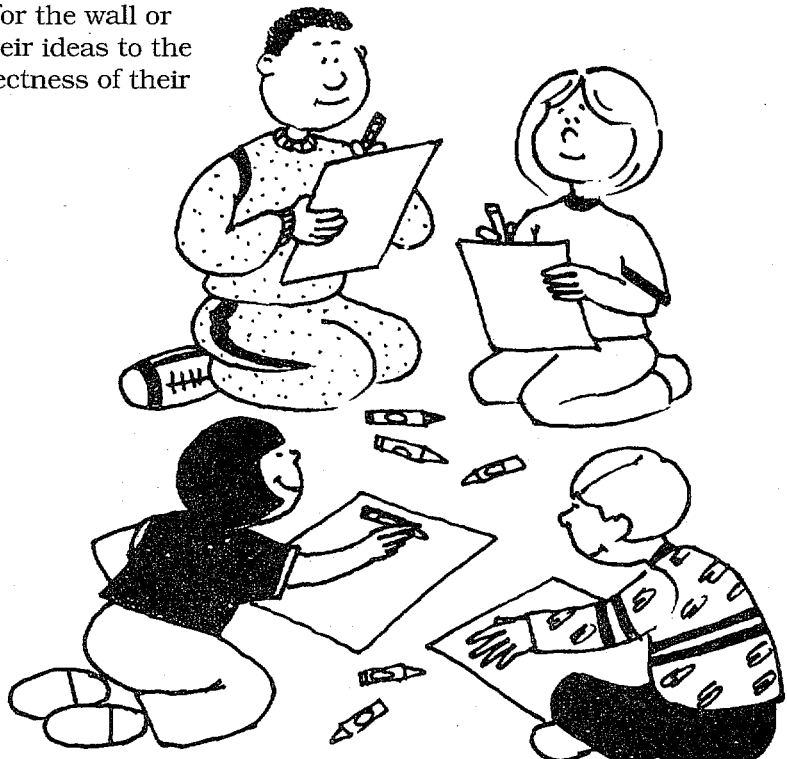

Activity Two: Earthquake Legends

Teacher Take Note: Some of these legends come from parts of the world where quakes do not occur frequently. An earthquake is a highly dramatic, memorable event. Some cultures may have borrowed oral traditions based on events outside their own geographic region. Others may have carried legends with them as they migrated from one part of the globe to another. Be prepared to find a less than exact correlation between legends and earthquake activity.

Materials for the teacher

- Large wall map of the world, or transparency made from Master 5, World Map
- Tape or pins
- Colored yarn
- Transparency made from Master 6, World Map with Legend Sites
- Transparency made from Master 7, World Map with Epicenters
- Overhead projector

Materials for each student

- Booklet of earthquake legends (See Appendix)
- Large sheets of drawing paper
- Crayons or markers

Procedure

1. Explain that earthquakes have been happening on Earth for millions of years. Scientists have understood what causes them for less than 50 years. People who experienced earthquakes developed traditional explanations that suited their *culture*, or way of life. We call these explanations *legends*.

Master 6, World Map with Legend Sites

Earthquake Legend Sites Key

1. India
2. Assam, between Bangladesh and China
3. Mexico
4. Siberia
5. Japan
6. Mozambique
7. Greece
8. Belgium
9. Tennessee USA
10. West Africa
11. Mongolia
12. India
13. Latvia
14. Colombia
15. Scandinavia
16. New Zealand
17. East Africa
18. Central America
19. Romania
20. West Africa

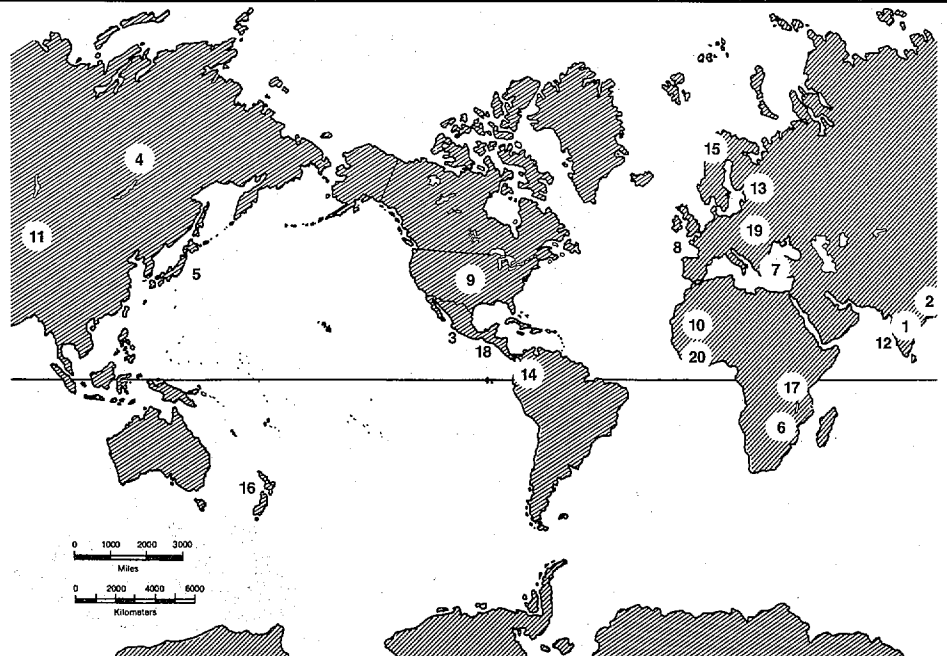

2. Distribute art materials and copies of the legends to every student. Divide the students into groups and have each group illustrate one of the legends. Label each illustration with the name of the culture or the region of the world it comes from.

3. On a world map, locate the region where each legend originated. (See Master 6. How you approach this part of the activity depends on your students' geography background.)

4. Make a wall display by having students place their illustrations on the wall surrounding the world map. Use the yarn and pins or tape to connect each illustration of a legend to the appropriate spot on the map.

5. Ask each group to read or recount their legend, and tell why they think it does or does not explain earthquakes. You may need to start the groups off by asking such questions as these, for the first story:

Are elephants big enough to hold up the world?

Could an elephant stand on a turtle without crushing it?

Did the early Hindus imagine ordinary animals in this story, or magical ones?

Do you think there are any such magical animals?

6. Project the transparency of Master 7, World Map with Epicenters. Explain that each dot shows a place where an earthquake has occurred. You may want to highlight the areas of greatest earthquake activity. Ask students if they can see a relationship between these areas and the places where the legends originated.

Teacher Take Note: You may want to read all the legends with the students before they begin to draw.

Legend Book Assembly

Copy the pages (each one has two legends) for the legend book in sequence. Be sure to copy page 2 on the back of the cover page. Repeat this process for the rest of the pages. Fold and staple in the center to form a booklet.

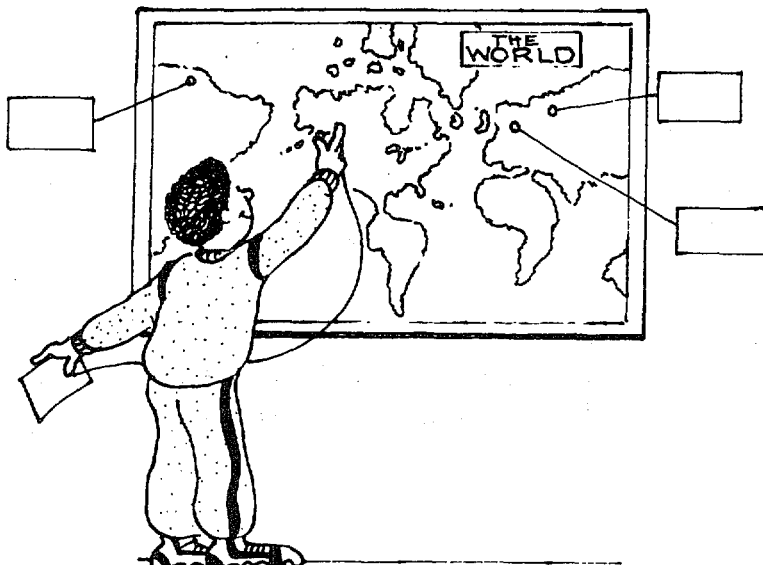

Activity Three: Tasty Quake

Materials for the teacher

- One pan of prepared gelatin dessert (see recipe)
- A fist-sized rock
- Silicone putty or "flubber" (see recipe)
- 25 coffee stirrers -- 5" (13 cm) plastic
- Scissors
- Ruler

Procedure

1. Prepare gelatin dessert in advance and refrigerate. These ingredients will make one pan. Prepare more if you wish to have several small groups performing the demonstration simultaneously.
2. Write the definition of an earthquake on the board.
3. Explain that under the soil there are rock layers. These layers are under stress because of activity within the Earth.
4. Explain that when these rocks are under extreme stress they react more like a plastic material, such as silicone putty, than like the hard rock we see above the ground. (Show rock and putty.)
5. Demonstrate with silicone putty (or flubber), or distribute several lumps so that each small group can do the activity for themselves. (The putty will be difficult to break if it has been warmed by too much handling, so work quickly.)

Gelatin Dessert

Two 170-g (6-oz) boxes of red or purple gelatin dessert
 Two one-serving envelopes of unflavored gelatin
 Four cups boiling water
 Four cups cold water
 One 23 X 30 cm (9 X 12 in.) metal baking pan
 Empty the gelatin dessert and the unflavored gelatin into the baking pan. Add the boiling water and stir until all the powder is dissolved, then add the cold water and stir to mix. Chill on refrigerator shelf at least three hours or until set.

Teacher Take Note: This recipe has been carefully tested. To transmit waves that can be seen easily, the pan *must* be metal, and it *must* be full nearly to the top with the gelatin mixture.

Flubber

Elmer's Glue™
 borax
 water
 *food color (optional)

2 bowls
 spoon
 plastic bag
 liquid measuring cup

Step 1 (Part A):

Mix 1 1/2 cups warm water with 2 cups Elmer's Glue. (Add food color now, if desired.) Mix until the glue is dissolved.

Step 2 (Part B):

Mix 1 1/3 cups warm water with 1 Tablespoon borax. Mix until borax is dissolved.

Step 3:

Add mixture B to mixture A. Knead mixtures into a smooth ball. Do Not Stir! Store in a sealed plastic bag.

Teacher Take Note: To get the best results follow the instructions for mixing ingredients in two separate bowls before combining all ingredients. Students should not eat the flubber. Students should wash their hands after handling the mixture.

a. First, stretch the putty slowly to show how rocks react to slow twisting and pulling.

b. Next, shape it back into a ball and give it a sharp tug with both hands. The putty will snap into two pieces.

c. Explain that this reaction is similar to what happens during an earthquake.

6. Explain that when rocks break in this sudden way energy is released in the form of waves. We can simulate this release of energy by watching what happens to a pan of gelatin.

7. Gently tap the side of the pan of gelatin, while holding the pan firmly with the other hand. Students should be able to see the waves traveling through the gelatin. Compare the gelatin to the ground, the tap of your hand to the rock breaking, and the waves in the gelatin to earthquake waves.

8. Ask the students to predict what happens when you tap the pan with more force. Tap the pan harder. Is their prediction confirmed? Repeat these two steps several times, and be sure that all the students have a chance to see the waves.

9. Coffee stirrers can be used to further enhance student observation of wave action. In the gelatin, insert to the bottom of the pan, four rows of stirrers parallel to the short side of the pan. (Place each row approximately 1.5" (4 cm) apart. Place each stirrer approximately 1.25" (3 cm) apart.)

10. Repeat steps 7 and 8 above (tap pan at side opposite the stirrers).

11. Ask students to compare their observations of waves in gelatin with and without stirrers. (The stirrers magnify the wave action, allowing greater visibility.) Discuss possible results of wave action on buildings (point out that stirrers could represent buildings). Ask how stirrers reacted to different amounts of force used in tapping the pan.

Extensions

1. Students could act out the legends with a few simple props.

2. Students could survey other students in the school to learn what they think causes earthquakes. Responses can be tabulated on the board or on butcher paper taped to the wall and become the basis for a class discussion.

3. In an area where earthquakes do not occur frequently, students could survey adults in the community to find out how many of them have experienced earthquakes. Small groups could divide responsibility for a set number of interviews such as ten per group and graph their results. No two students may interview the same person.

4. Instead of illustrating the legends on large sheets of paper, students may draw a small symbol for each legend, cut it out, and pin it directly onto a large wall map at the correct location. The Japanese legend, for example, could be represented by a fish.

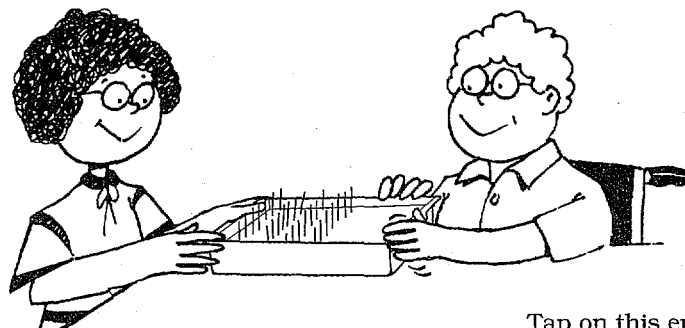

Tap on this end

Energy Waves Cause Earthquakes

Vocabulary

earthquake
 legend
 stored energy (potential energy)
 earthquake waves (seismic waves)
 fault
 fault creep
 focus
 epicenter

Learning Links

Language Arts: Discussing, oral reading, note taking, following directions

Social Studies: Map reading, correlating different types of maps, discussing effects and explanations of earthquakes in past and present societies

Math: Using map scale to measure distances

Art: Creating signs, illustrating activity

Content Concepts

1. Earthquakes result from the buildup and release of energy stored in rocks.
2. Earthquakes occur over much of the world, including the United States.
3. Various societies have produced earthquake legends to explain these natural occurrences.

Objectives

Students will

- watch one demonstration and participate in one activity on elastic rebound, and apply the principle to earthquake activity.
- demonstrate the phenomenon of fault creep, and distinguish it from earthquake activity.
- list some events that occur during an earthquake.
- locate their own state on an outline map of the United States.
- determine from the study of epicenter maps if their local area and state have experienced earthquakes.
- read and discuss earthquake legends.
- locate the place where each legend originated on an outline map of the world.

Assessment

Describe (write and/or draw) an event which releases energy and relate the results of that energy release.

Activity One: A Wet Wave Experience

Materials for the teacher

- Transparency made from Master 8, Elastic Rebound
- Overhead projector
- Strip of 1/16" wood lath the size of a ruler, or a 1/4" dried stick about 1' (30 cm) long.
- Sink or basin large enough to hold wood
- Water to fill basin
- Goggle

Procedure

1. Gather students around sink or basin filled almost to the top with water.
2. Hold the wood completely under water. With one hand on each end, bend it slowly until it breaks.
3. Ask students to describe what they see: jerky movement of the water and waves radiating out from the breaking point.
4. Explain that energy was transferred to the stick by the hand movements, stored as potential energy until the stick broke, and then transferred to the water. This concept of buildup and release of energy in rocks is called elastic rebound theory.
5. Direct students to make a drawing of the demonstration in their notebooks.
6. Ask students to explain how the demonstration relates to an earthquake.
7. Project transparency of Master 8, Elastic Rebound, and use it to illustrate that when pressure from within the Earth is exerted on rocks, they bend and store energy until they reach a certain point, like the wood.

The stored or potential energy is released, in the form of waves, in an event we call an *earthquake*. The breaking point is the focus of the earthquake. Help students to relate this explanation to the demonstration.

fo • cus

The focus is the place where an earthquake starts.

ep • i • cen • ter

The epicenter is the point on the Earth's surface directly above the focus.

fault

A fault is a crack in rock or soil along which earthquake movement has taken place.

earth • quake waves

Earthquake waves, or seismic waves, are waves caused by the release of energy in the Earth's rocks during an earthquake.

Elastic Rebound



Original position



Buildup of potential energy

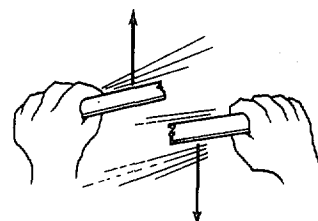

Breaking stick produces energy release

Activity Two: It's Your Fault

Materials for the teacher

- Transparency made from Master 9, Dresser Drawers
- Transparency made from Master 10a, Earthquake Terms
- Overhead projector

Materials for each student

- A sign saying either Block A or Block B (Students can make them and letter them neatly.)
- String or tape for affixing sign

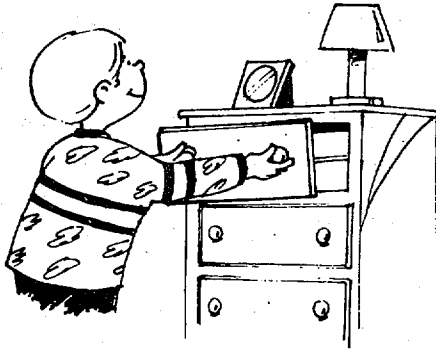

Smooth surface slides easily.

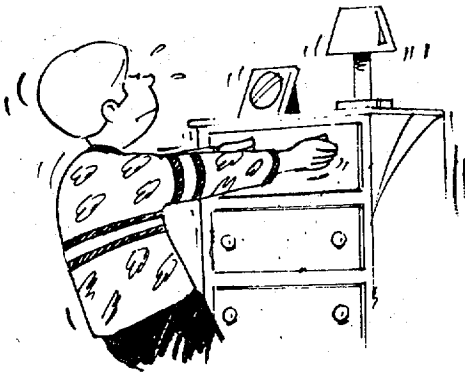

A sticky drawer opens with a jerky movement.

Procedure

1. Project the transparency made from Master 9, and explain that the pieces of Earth's crust often move past each other as smoothly as our dresser drawers move. Project Master 10a, and point out the *fault* on the Earth's surface.
2. Label the area to the left of the fault Block A and that to its right, Block B. Explain to students that they are going to demonstrate what happens when pieces of the Earth's crust move.
3. Take the students to a location in or outside the classroom where they will not hit anything but the floor if they fall.

4. Ask them to form into groups of 8 to 10 students, and divide each group into equal halves. (The teacher can participate if necessary to even the groups.)
5. Line up two groups of students facing each other, and explain that each line represents a block of Earth. The area between the two lines represents a fault.
6. Students should stretch out their arms, from both sides of the "fault," so that each is lightly touching the palms of a student on the other side.
7. Instruct students on both sides of each fault to shuffle smoothly to the students' right, keeping their palms extended. (The two lines will move in opposite directions, and students will slowly change partners.) Explain that this simulates *fault creep* movement.
8. Line the groups up as before, but this time have them lock fingers across the fault. Again instruct them to move to the right by slow steps, but keep them moving past the point where they can hold on easily. Just before they have to let go or fall, call out "earthquake!" Ask students to drop hands and stand up straight. The sudden release of energy should cause them to stumble and fall into one another. Explain that this activity simulates an earthquake.
9. Compare and contrast the two events in a class discussion, referring to the Dresser Drawers (Master 9) and Earthquake Terms (Master 10a) transparencies. Be sure that students understand the difference between the smooth movement that simulated fault creep and the buildup and sudden release of stress that caused them to stumble in the second demonstration. According to the theory of elastic rebound, it is this buildup and release of stress that causes earthquakes.

Activity Three: Visual Vocabulary

Materials for the teacher

- Movie clip, video clip, slides, filmstrip, or written eyewitness account(s) of earthquakes
- Transparency made from Master 10a, Earthquake Terms
- Overhead projector

Materials for each student

- Student handout made from Master 10b, Earthquake Terms Worksheet
- Colored pencils

Procedure

1. Ask any class members who have experienced an earthquake to describe that event to the class.
2. Use one of the media listed above (movie clip, video, etc.) to give the class some common vicarious earthquake experiences.
3. Brainstorm to create a class list of things that happen during an earthquake (rumbling noises, swaying trees, etc.) on the board or an overhead.
4. Project Master 10a, and go over the definitions of *focus*, *epicenter*, *fault*, and *earthquake waves*. Instruct students to fill in the definitions on Master 10b, Earthquake Terms Worksheet, then shade over each one in a different color: the first in red, the second in blue, the third in yellow, and the fourth in green. Finally, ask them to color the part of the diagram that each definition refers to in the same color as the definition.

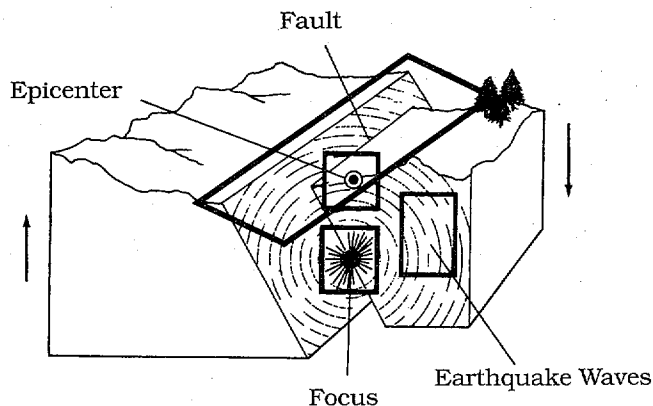

Master 10a. earthquake terms.

Activity Four: Local Legends

Materials for the teacher

- Standard classroom wall map of the world, or a transparency made from Master 5, World Map
- Transparency of Master 11, U.S. Map with Epicenters
- Transparency made from Master 7, World Map with Epicenters
- Booklet of earthquake legends (See Appendix.)
- Optional: Epicenter map of your state or area (obtain from state geological survey, U.S. Geological Survey or local college geology department)

Materials for each student

- Booklet of legends
- Worksheets made from Master 11, U.S. Map with Epicenters

Procedure

1. Using transparencies and/or student copies of the U.S. Map with Epicenters. Master 11, ask students these questions:

According to this map, which of the states experience a lot of earthquakes?

Which states experience very few or no earthquakes?

Where is our state on this map?

According to the map, does our state experience a small, medium, or large number of earthquakes?

People in states without epicenters, as shown on this map, may still experience earthquakes. How can this be? (Both seismographs and the human senses can register the effects of distant earthquakes, especially large ones. Also, this map only records quakes over a certain intensity. Some states may have quakes below those levels.)

2. Show students how to use the map scale on the U.S. Map with Epicenters to measure the distance from where they live to the nearest epicenter on the map. Use a local or state map if available.

Extensions

1. If you live in an area that has ever been affected by an earthquake, check your local library for microfilm copies of old newspapers describing the event. On August 31, 1886, for example, the effects of the Charleston, South Carolina earthquake were felt in most of the states east of the Mississippi and south of New York state.
2. Current documentation on seismic activity can be obtained through the Internet at <http://earthquake.usgs.gov>

Teacher Take Note: The terms *intensity* and *magnitude* will be discussed in later chapters.

3. Write the definition of *legend* on the board, and invite students to recount some legends they may have heard.
4. Have students read some of the earthquake legends out loud in class. Locate the origin of each on the world map before moving on the next.
5. Project the transparency of Master 7, World Map with Epicenters, and ask students if they see any correlation between the origins of the legends and the density of earthquake epicenters. (See Unit I, Level 2, Activity Two.)
6. Discuss with students:

leg • ends

Legends are traditional narrative explanations of natural phenomena which evolve when scientific explanations are not available.

Why did these legends develop? (Emphasize that they were creative attempts to explain frightening and puzzling natural occurrences.)

What real facts do these legends contain or reflect? (Siberia: that human beings and animals are interdependent; New Zealand: that the Earth is like a living organism; Romania: that human decency upholds the social world; Mexico: that the evil in the world is hard to understand; etc.)

Master 6, World Map with Legend Sites

Earthquake Legend Sites Key

1. India
2. Assam, between Bangladesh and China
3. Mexico
4. Siberia
5. Japan
6. Mozambique
7. Greece
8. Belgium
9. Tennessee USA
10. West Africa
11. Mongolia
12. India
13. Latvia
14. Colombia
15. Scandinavia
16. New Zealand
17. East Africa
18. Central America
19. Romania
20. West Africa

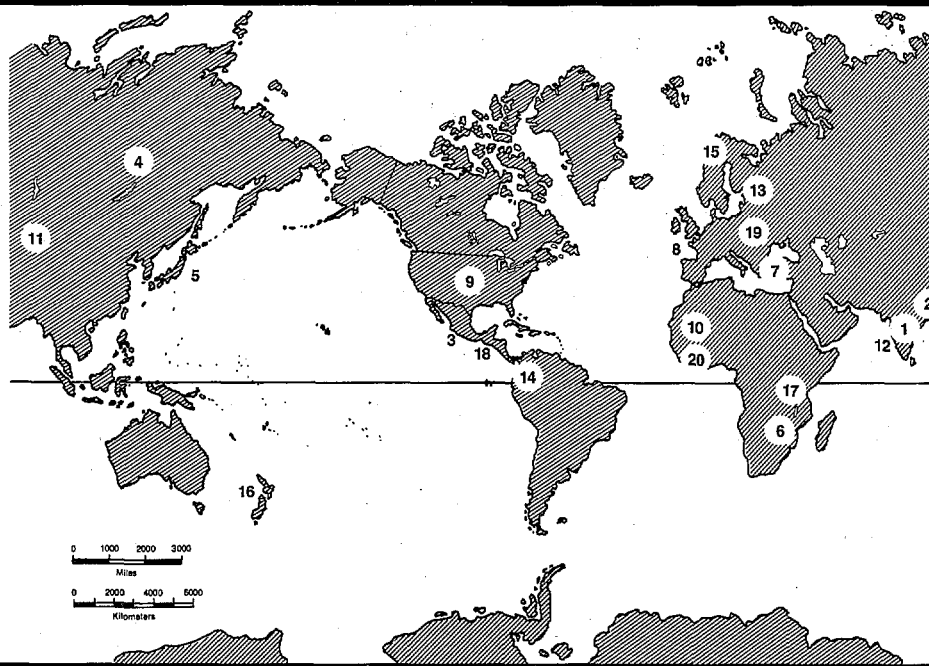

Unit I. Defining an Earthquake

Materials List

Grades K-2

audiovisual cart on wheels
shallow box
sand or soil
paper plates and cups
small boxes
green construction paper
straws
stapler
writing paper
pencil
mural paper
drawing paper
crayons
oil pastels
scissors

Grades 3-4

drawing paper
crayons
markers
tape
straight pins
colored yarn
fist-sized rock
Silly Putty™
red or purple gelatin
unflavored gelatin
boiling water
metal baking pan
overhead projector
coffee stirring sticks

Grades 5-6

wood lath or dried stick
large bowl
sink or basin
goggles
colored pencils
string or tape
overhead projector
paper clips

U.S. Map

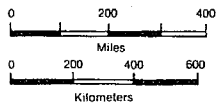
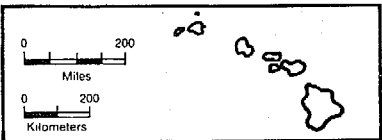
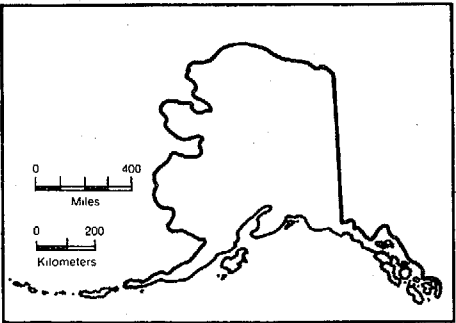
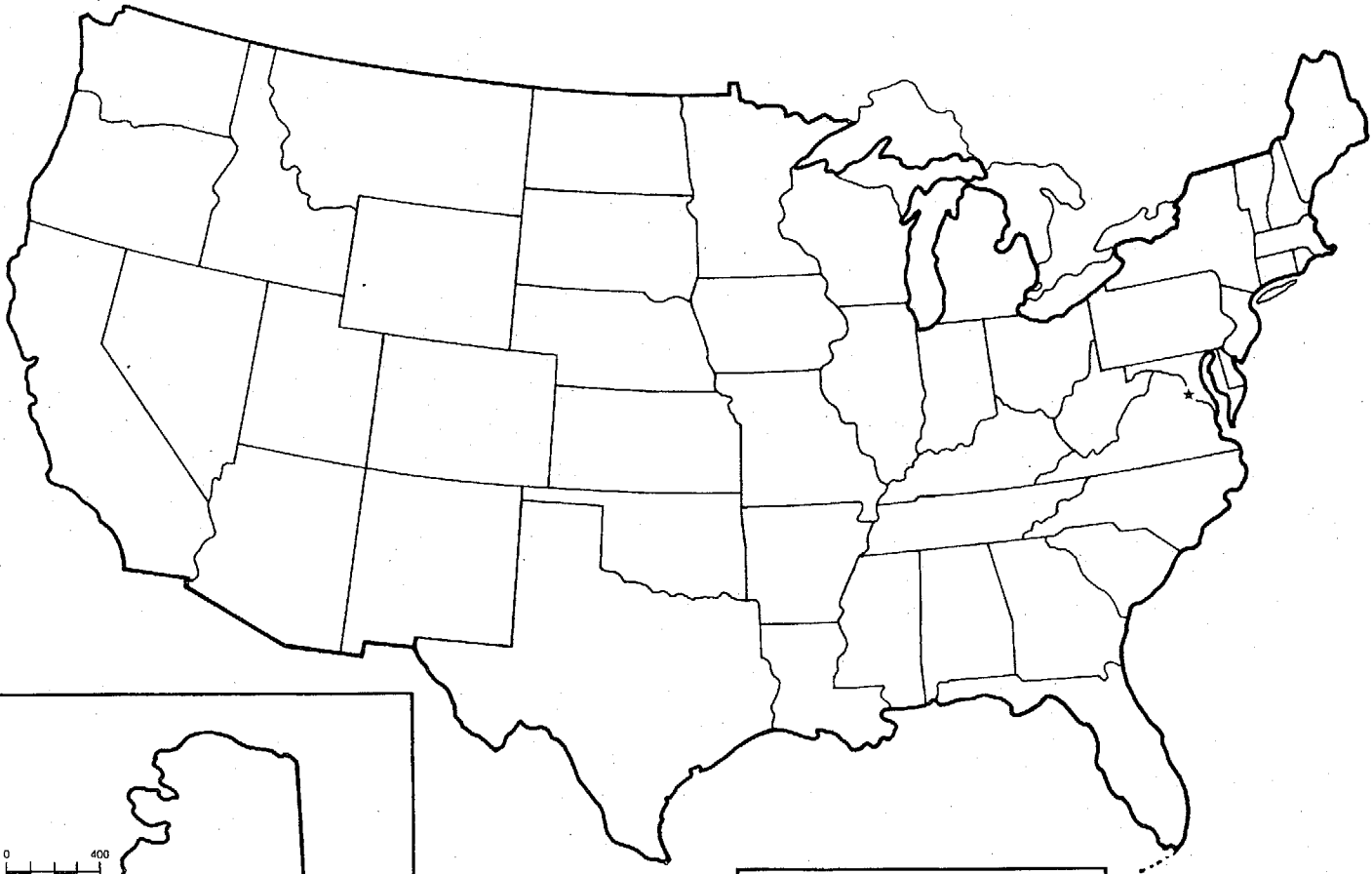

U.S. Map



The Turtle Tale

Long, long ago, before there were people, there was hardly anything in the world but water. One day, Great Spirit looked down from heaven. He decided to make a beautiful land. But where could he begin? All he saw was water. Then he spotted a giant turtle. Great Spirit decided to make the beautiful land on the turtle's back.

But one turtle was not big enough. The land Great Spirit wanted to make was very large. So he called out, "Turtle, hurry and find your six brothers."

Turtle swam to find them. It took her a whole day to find the first. It took her another day to find the next. After six days, turtle had found her six brothers. "Come," she said, "Great Spirit wants us."

Great Spirit called down. "Turtles! Form a line, all of you—head to tail, north to south. Umm—you three on the south, please move a little to the east. Hmmm. Yes, that's just right. What a beautiful land you turtles will make! Now listen! It is a great honor to carry this beautiful land on your backs. So you must not move"

The turtles stayed very still. Great Spirit took some straw from his supply in the sky. He spread it out on the turtles' backs. Then he took some soil and patted it down on top of the straw.

Great Spirit cleaned his hands on a fluffy white cloud. Then he went to work, shaping mountains and valleys and lakes and rivers. When he was finished he looked at the beautiful land he had made. Great Spirit was very pleased. But soon trouble came. The giant turtles grew restless. They wanted to stretch their legs.

"I want to swim east," said one. "This beast goes east."

"West is best. I'll swim toward the setting sun," said another.

The turtles began to argue. They could not agree which way to move. One day, four of the turtles began to swim east. The others began to swim west. The Earth shook! It cracked with a loud noise. But after a minute, the shaking stopped. The turtles had to stop moving because the land on their backs was so heavy. They had only been able to swim a little way from each other. When they saw that they could not swim away, they stopped arguing and made up.

Every once in a while, though, the turtles argue again. Each time they do, the Earth shakes.

HELP: Hands-on Earthquake Learning Package. (1983). California Edition. Environmental Volunteers. Inc.

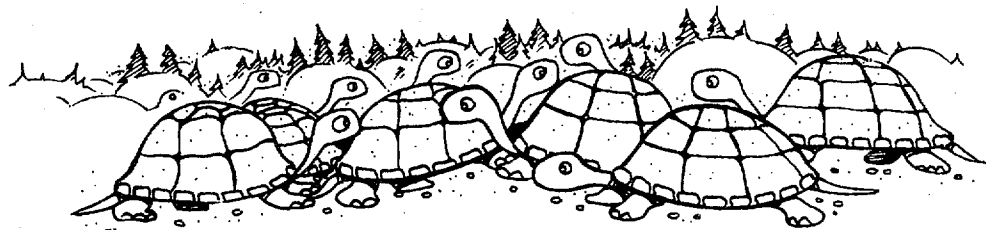

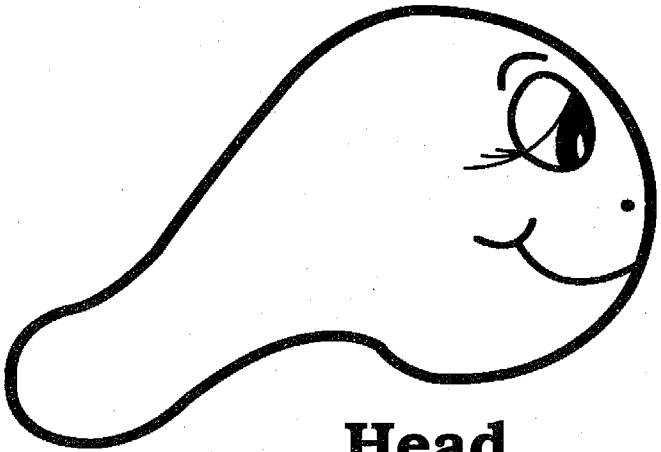

Head
(cut 1)

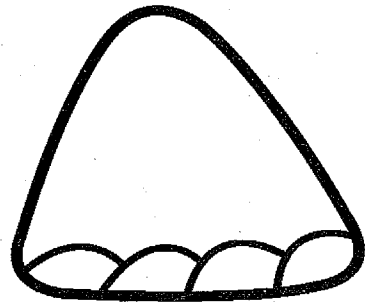

Foot
(cut 4)

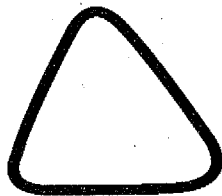

Tail
(cut 1)

Name _____

I heard a legend from the San Gabrielino Indians.

The Indians thought that big turtles carried the land on their backs. They thought that an earthquake happened when the turtles moved in different directions.

1. Connect the dots.
2. Color the turtle carrying land on its back

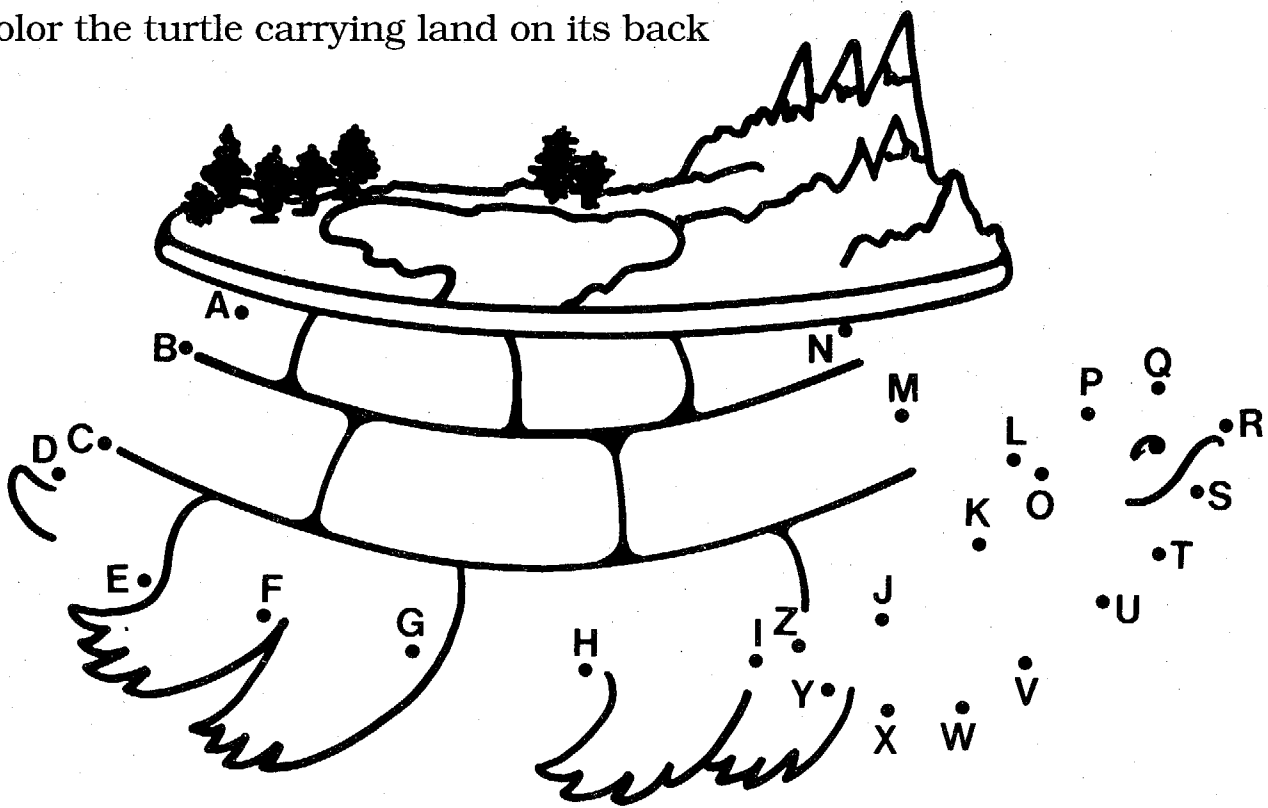

World Map

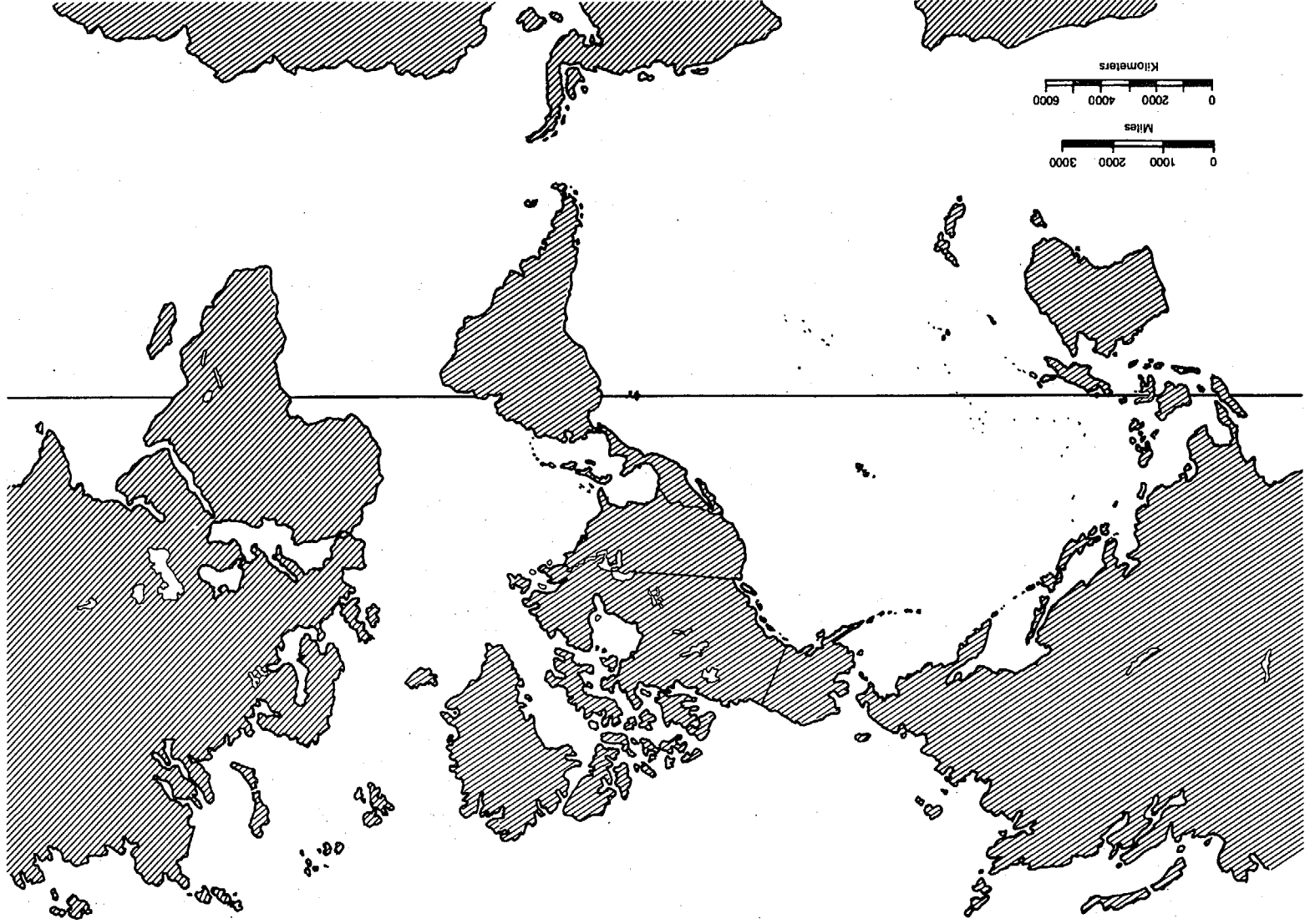

World Map with Legend Sites

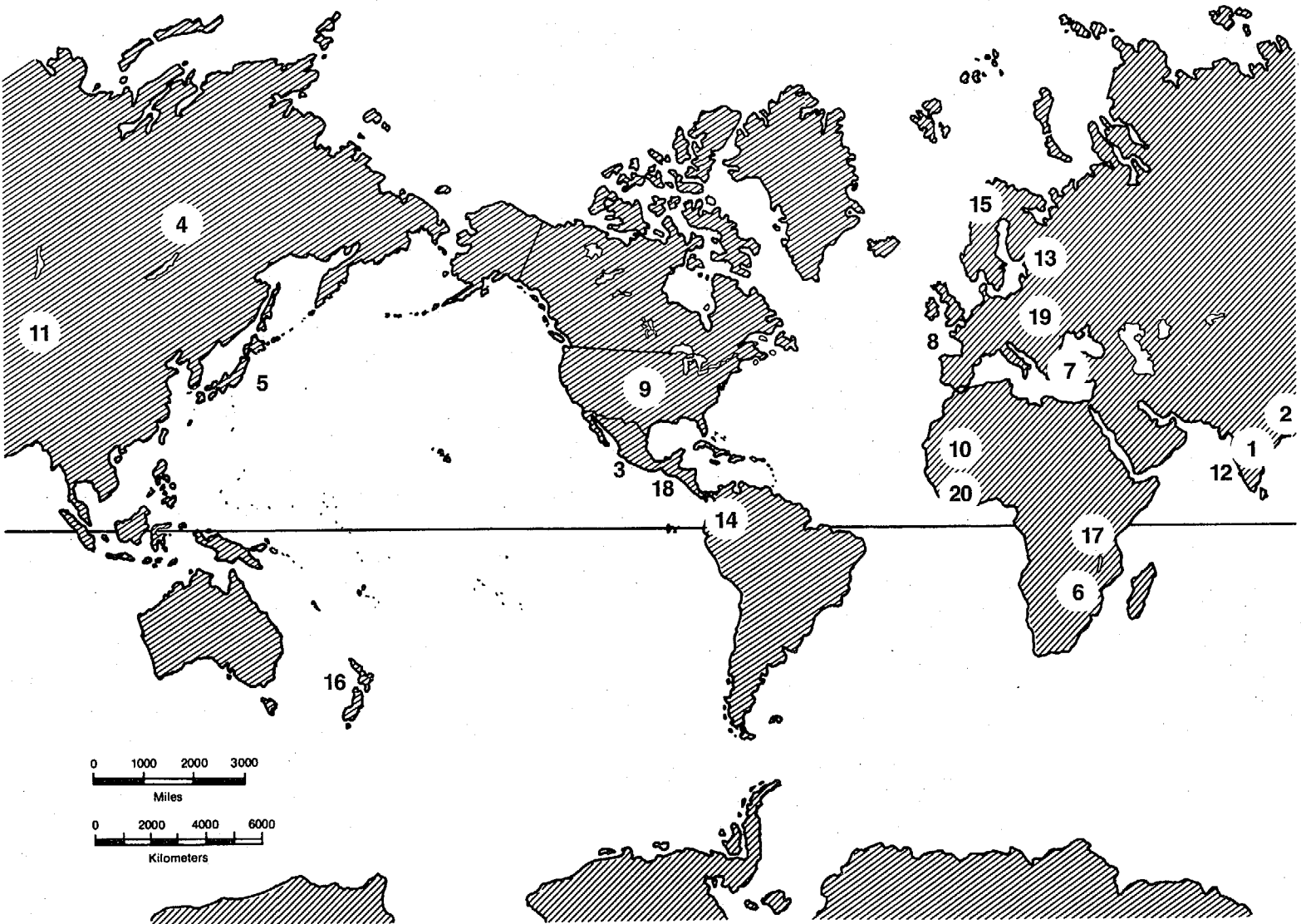

World Map with Epicenters

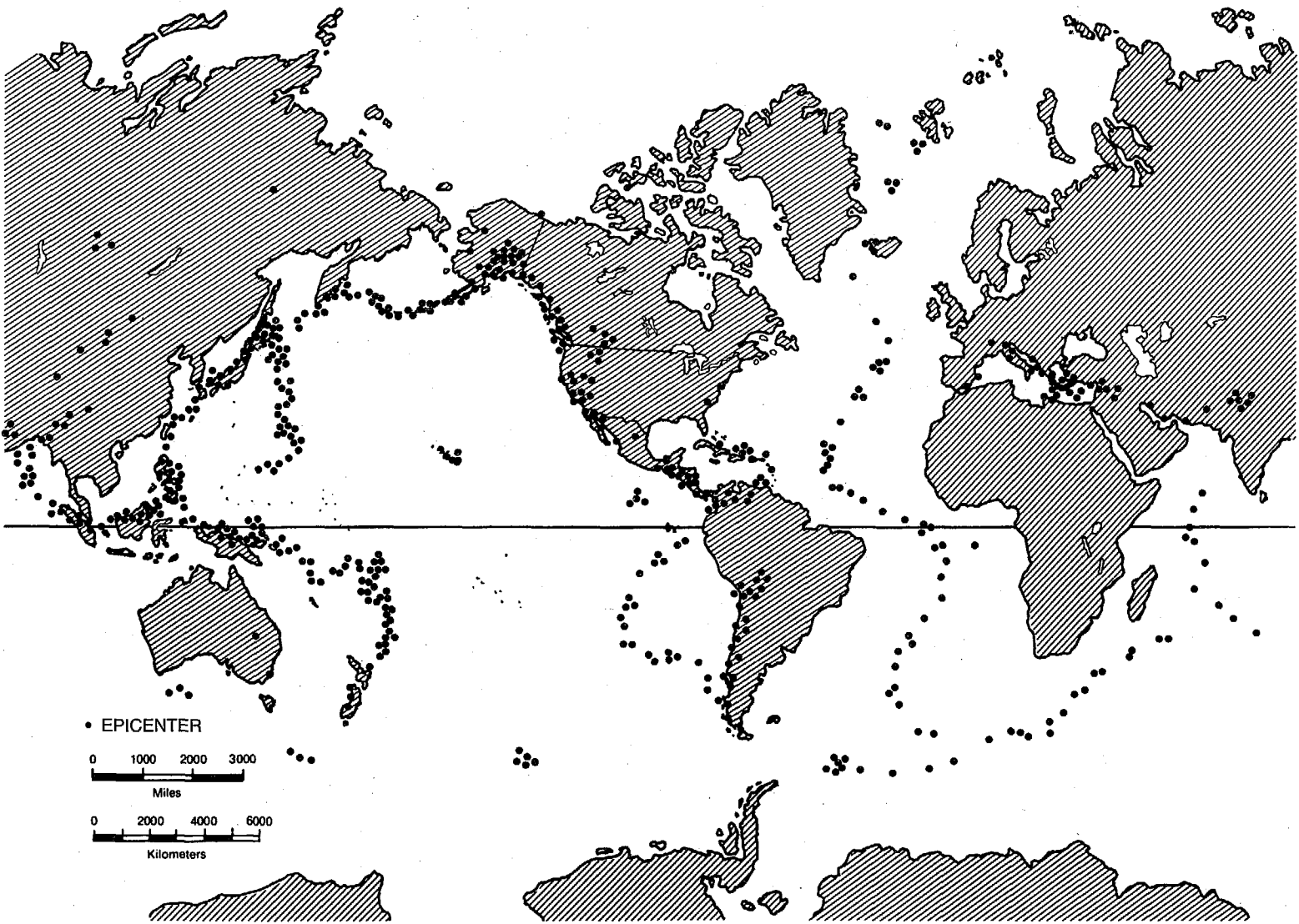

Elastic Rebound

Stick Changes

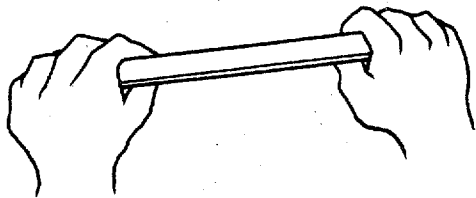

Original position with no strain on sticks and rocks

Rock Changes

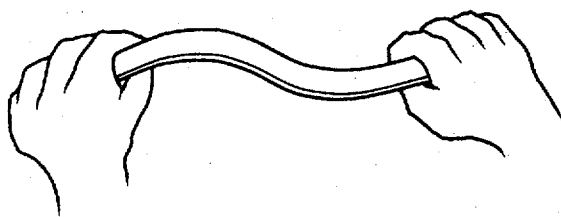
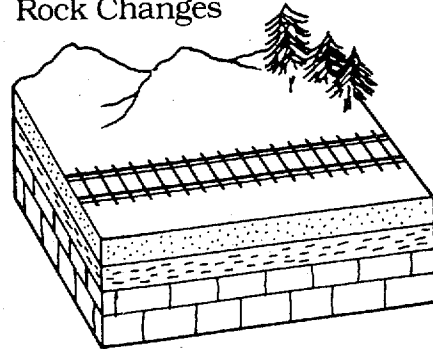

Buildup of potential energy in bent stick and deformed rocks

Pressure Direction

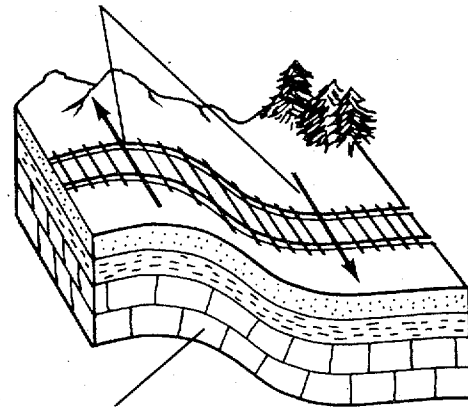

Deformed Rocks

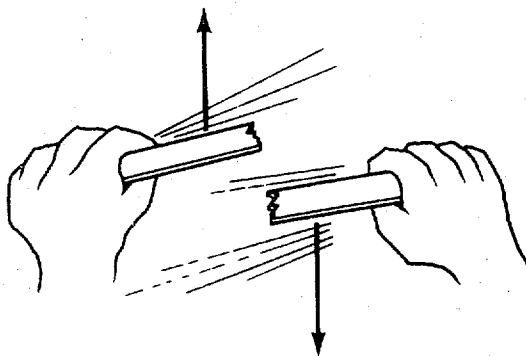

Breaking stick and rocks produces break (fault) and energy release or earthquake

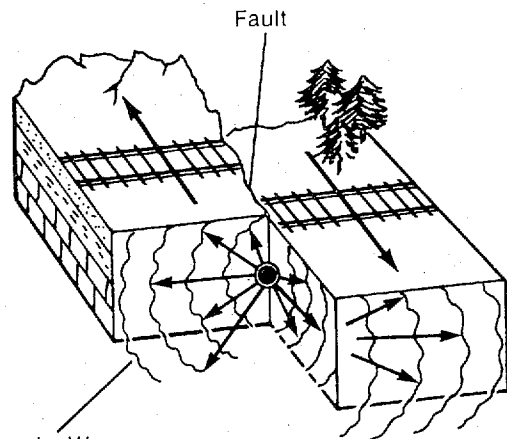

Earthquake Waves

Dresser Drawers

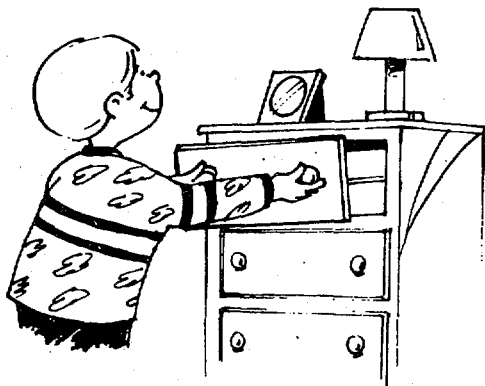

Smooth drawer surfaces
slide easily

However...

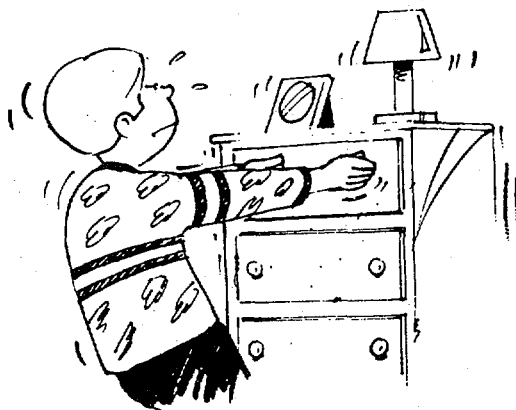

A great force is needed to move
a sticky drawer

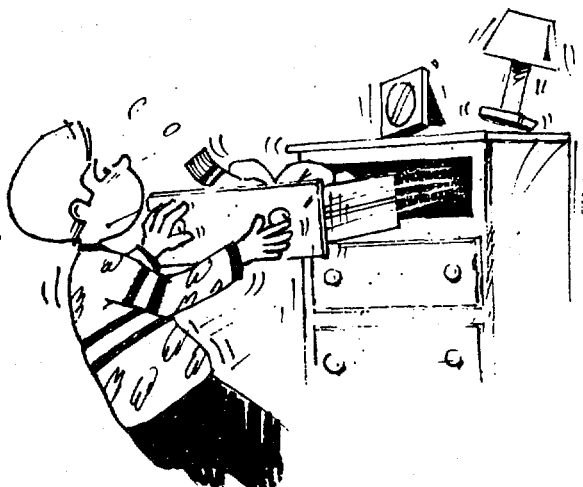

A sticky drawer opens with a
jerky movement

Earthquake Terms

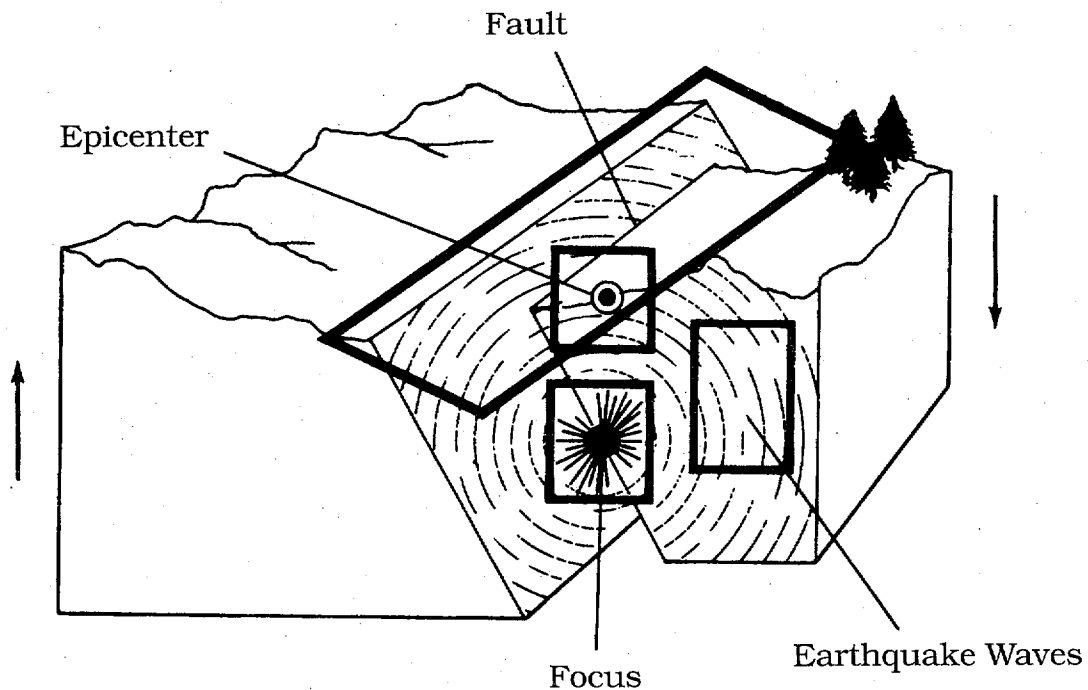

Definitions:

Focus

The focus is the place where an earthquake starts.

Epicenter

The epicenter is the point on the Earth's surface directly above the focus.

Fault

A fault is a break in the Earth's rocky surface along which the two sides have been displaced relative to each other.

Earthquake Waves

Earthquake waves are waves caused by the release of energy.

Earthquake Terms Worksheet

Name _____

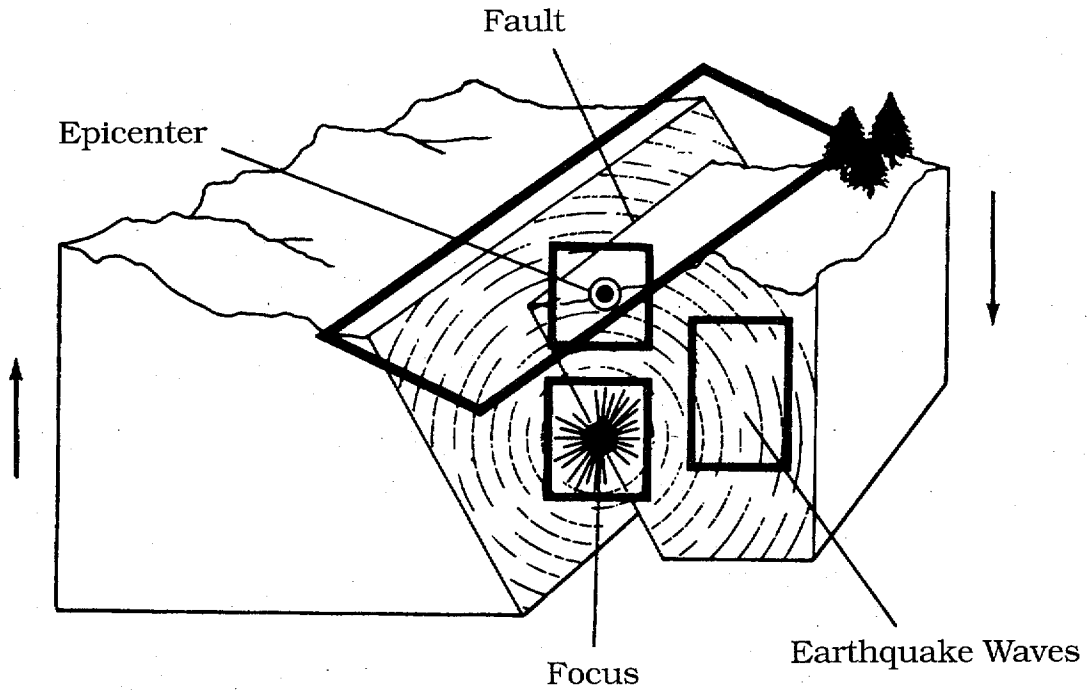

Definitions:

Focus _____

Epicenter _____

Fault _____

Earthquake Waves _____

U.S. Map with Epicenters

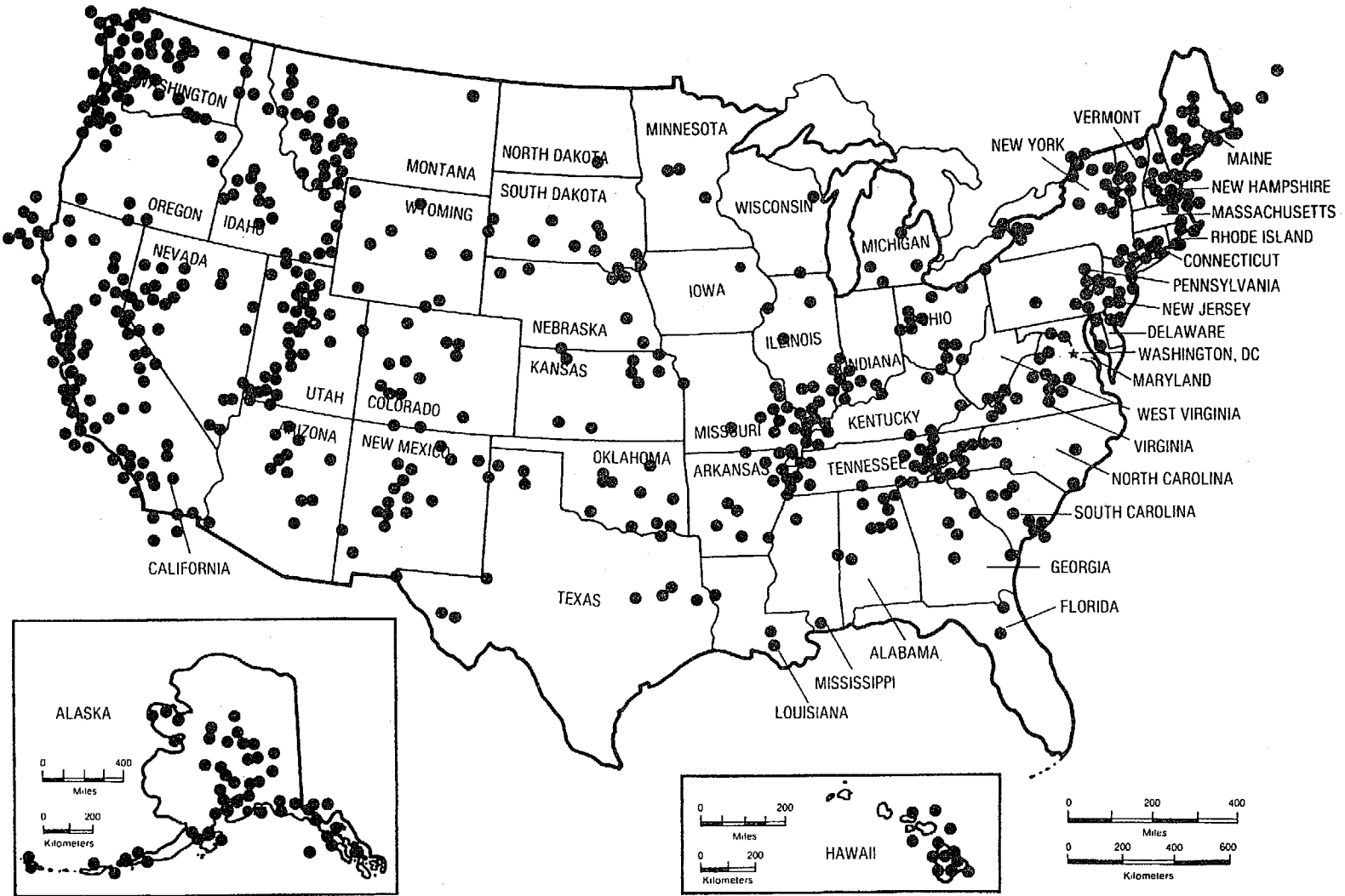

II

Why and Where Earthquakes Occur

Earthquake Curriculum, K-6 -- Scope and Sequence Chart

Unit II: Why and Where Earthquakes Occur

Level	Concept	Laboratory	Mathematics	Language Arts	Social Studies	Art
K-2	<p>The Earth is made up of layers.</p> <p>Earth's outer layer is broken into pieces called plates.</p> <p>The movement of Earth plates is the cause of most earthquakes.</p>	<p>Egg analogy of the earth layers</p> <p>Earth layer simulation game</p>		Vocabulary development of earthquake words	Map puzzle of Earth plates	<p>Color, cut, and paste Earth plates</p> <p>Shape recognition of Earth plate puzzle</p>
3-4	<p>The Earth has a layered structure.</p> <p>Earth's outer layer, the lithosphere, is broken into pieces called plates.</p> <p>Convection currents in the mantle might be the cause of plate motion which results in earthquakes.</p>	<p>Egg analogy of Earth layers</p> <p>Hand movement simulation of Earth layer motion</p> <p>Convection current demonstration</p>	<p>Scale measurements</p> <p>Bar graph of Earth layers</p>	<p>Written description of Earth's interior</p> <p>Vocabulary development of earthquake words</p>	<p>Earth size and distances</p> <p>Map study of epicenter and plate locations</p>	<p>Color in Earth layer diagram</p> <p>Three dimensional model of Earth layers</p>
5-6	<p>The Earth has a layered structure and an outer layer broken into pieces called plates.</p> <p>Three basic movements take place at the edges of the plates.</p> <p>Plate movements create special surface features near the edges of the plates.</p> <p>Convection currents in the mantle may be the cause of plate movements.</p>	<p>Models of Earth plate motions</p> <p>Convection current demonstration</p>	<p>Scale model of Earth layers</p> <p>Metric measurement</p>	Vocabulary development of earthquake words	<p>Map study of epicenter and plate locations</p> <p>Geologic features of the Earth's surface</p>	<p>Model of Earth layers</p> <p>Model of formation and break-up of Pangaea</p>

II

Why and Where Earthquakes Occur

Although our Earth feels solid as we walk along its surface, it is really only partly so. The Earth is divided into three main layers that can be visualized by using a hard-boiled egg as a model. There is a hard outer surface, a softer middle layer, and a central core. The outermost layer of the Earth is broken into irregular pieces, called *plates*, which make the Earth resemble a spherical jigsaw puzzle. These plates are in very slow but constant motion. Plates move in three different ways—colliding with each other, spreading apart, or sliding past one another. Earthquakes can release the energy stored in rocks by any one or a combination of these three kinds of movement. Today many scientists believe that the plates float on currents created in hot plastic-like material beneath the plates.

Why and Where Earthquakes Occur

In Unit I we defined earthquakes in a general way, particularly as they affect human beings. To really understand why earthquakes occur, however, we need to know something about the makeup of our Earth. Two concepts are basic to all of the lessons in this unit: that the planet we live on is composed of layers, and that its outermost layer and surface are broken into irregular pieces called *plates*.

The Layers of the Earth

The simplest way of describing the Earth's layers is to compare the globe to a hard-boiled egg. It has a crust something like the shell, a middle layer, or *mantle*, something like the white, and a core that is something like the yolk. The crust and the upper portion of the mantle are often referred to together as the *lithosphere*, or rock sphere. Scientists further divide the core into the *inner core* and the *outer core*.

Crust and Lithosphere

The Earth's crust varies in thickness from about 65 km on the continents to only about 10 km on the ocean floors. Even at its thickest, the crust is not nearly as thick in relation to the whole bulk of the Earth as the shell of an egg is to the egg. This becomes obvious when we compare 65 km to the radius of the Earth, 6,370 km.

The lithosphere is the outer solid portion of Earth that includes the crust and the uppermost part of the mantle. The lithosphere has an average depth of 100 km.

Lower Mantle and Core

Directly below the lithosphere is the *asthenosphere*, a region of the mantle with a plastic, semisolid consistency, which reaches to about 200 km below the surface. The mantle continues to a depth of 2,900 km.

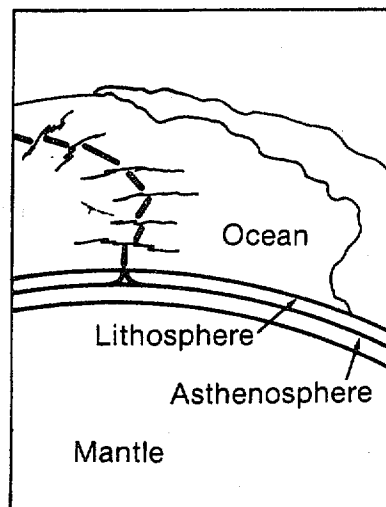

The liquid outer core, which might be compared to the outer two-thirds of an egg's yolk, reaches from 2,900 km to a depth of about 5,100 km. The solid, metallic inner core goes the rest of the way to the center of the Earth. Both are composed primarily of iron and nickel.

The oldest rocks of the crust have been dated by radioactive decay at about 4.0 billion years old. We do not know when the lithosphere began to form, but we assume that it broke into plates at this time.

The Earth's Plates

Most earthquakes are caused by large-scale movements of the Earth's lithospheric plates and occur at the boundaries between the plates. Experts recognize seven to twelve major plates and a number of smaller ones. The plates take their names from continents (the North American plate); from oceans (the Pacific plate); and from geographic areas (the Arabian plate).

Types of Plate Movements

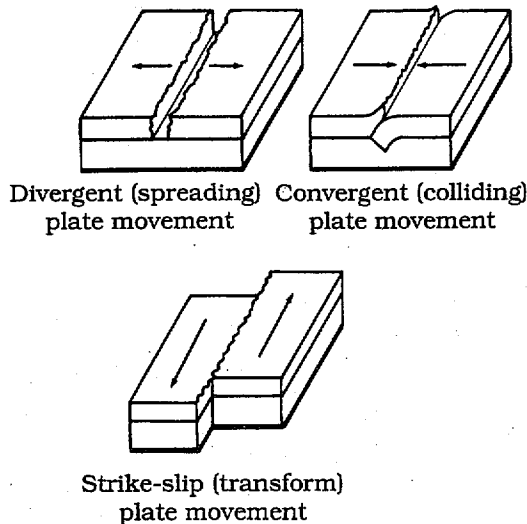

Slow and Steady Motion

The plates are in very slow but constant motion, so that seen from above, the Earth's surface might look like a slowly moving spherical jigsaw puzzle. The plates move at rates of 2 to 15 cm, or several inches, in a year: about as fast as our fingernails grow. On a human scale, this is a rate of movement that only the most sophisticated instruments can detect. But on the scale of geological time, it's a dizzying speed. At this rate, those almost-four-billion-year-old rocks could have traveled all the way around the Earth eleven times.

Three Kinds of Plate Movements

The movement of the plates is generally one of three kinds—spreading, colliding, or sliding. When plates are spreading, or separating from each other, we call their movement *divergent*. When they are colliding, or pushing each other, we call the movement *convergent*. Movement in which plates slide past each other is called *strike-slip* (or *transform*) plate movement. Earthquakes can accompany each of the three types of movement.

Plate Tectonics

Continental Drift: 1910 to 1960

The theory of plate tectonics originated early in the 20th century, although it did not gain general acceptance until the late 1960s. The German meteorologist, geophysicist, and explorer Alfred L. Wegener is now given credit for the first step in understanding the movement of the lithosphere. In the period 1910-1912 he formulated the theory called *continental drift* and collected evidence from the rocks, fossils, and climate of various continents to show that they had once been joined together. Wegener had little data on the oceanic crust, so he thought that the continents merely moved through that crust.

Plate Tectonics: 1960 to the Present

In the early 1960s, Fred Vine and Drummond Matthews showed that the ocean floor was spreading apart at the mid-ocean ridges. They and others soon realized that the continents were also moving. By 1968 a new explanation for the dynamics of the Earth's surface had been born, and christened plate tectonics.

Convection Currents

The force that drives the plates, however, is still something of a mystery. Wegener thought that centrifugal force, caused by the rotation of the Earth, was the cause of continental drift. The weight of modern scientific opinion favors convection currents—systems of heat exchange that form in the Earth's mantle.

Beneath the lithosphere the mantle is semi-molten to a depth of about 260 km. Its plastic-like material rises in response to heat and sinks when the temperature drops. You can see this kind of movement if you boil water in a clear glass pot.



Earth land masses about 200,000,000 years ago.

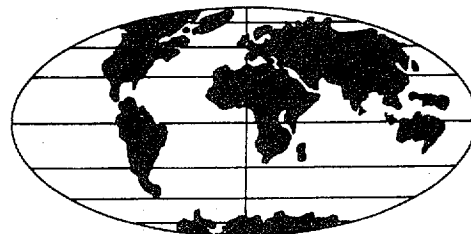

Earth land masses about 50,000,000 years into the future.

This convective movement acts as a drag on the underside of the lithospheric plates, causing them to separate where mantle material is rising and collide where it sinks. As the plates are dragged along over the mantle, like potato chips riding on honey, the leading edges of some plates are destroyed, while others pick up new material. Sometimes the edge of one plate slides under another, in the process we call subduction.

Some scientists explain the motion of plates as a downhill sliding. They are high at the mid-ocean ridges, and extend deep into the mantle at their leading edges. As a subducting plate sinks, it fractures from the stress and causes deep earthquakes. Eventually, because of the high temperature of the mantle, the subducting plate melts. Then this molten plate material rises into the crust, where it feeds volcanoes.

Somehow, these various processes maintain a kind of balance, so that the size of the lithosphere stays about the same. Remember to emphasize, with your students, the great sweep of geological time in which tectonic processes occur. Discovering the dynamic nature of this seemingly solid Earth should be exciting, but not frightening.

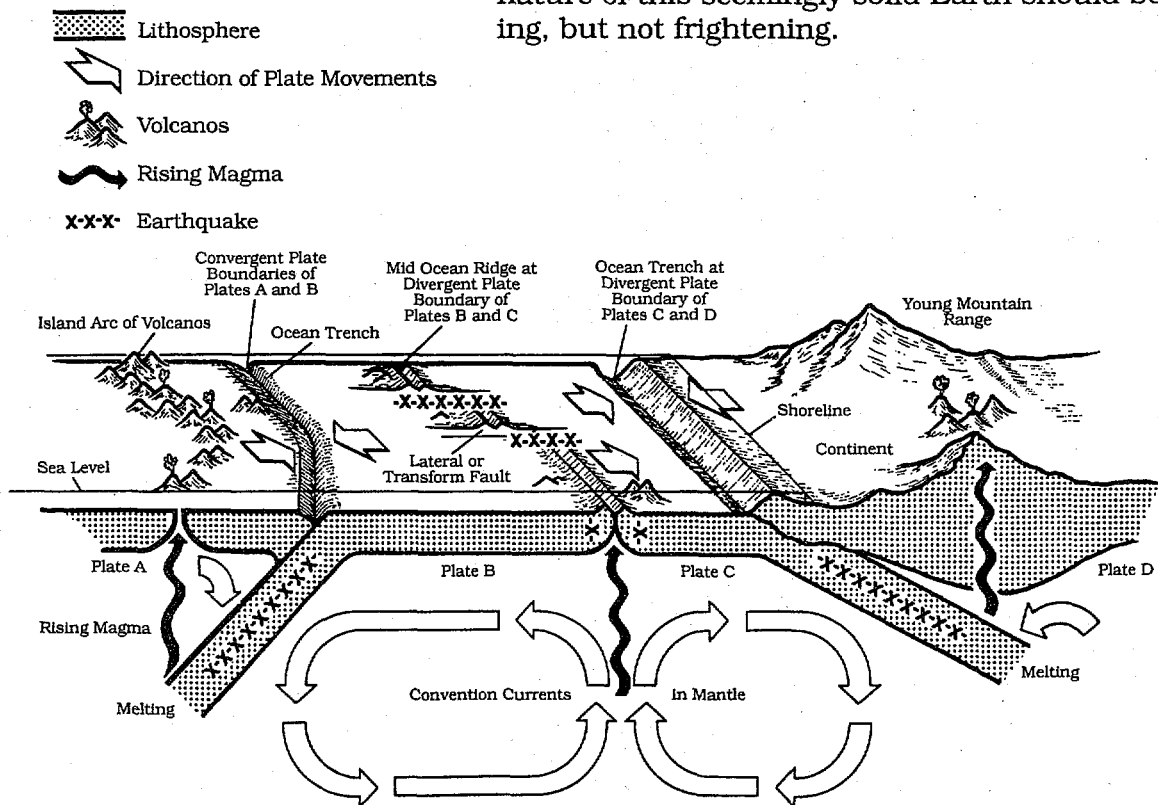

Master 18, Convection Currents and Plate Boundaries

Inside Planet Earth

Vocabulary

core
mantle
crust
plate

Content Concepts

1. The Earth is made up of layers.
2. Its outer layer is broken into pieces called plates.
3. The movement of the Earth's plates is the cause of most earthquakes

Objectives

- Students will
- name and identify layers of the Earth.
 - observe a model of the Earth's plates.
 - create a model of the Earth's layers with their bodies.
 - construct a representation of the Earth's plates with jigsaw puzzle pieces.

Assessment

Construct a scientific drawing showing layers of the Earth.

Learning Links

Language Arts: Vocabulary building, following directions

Art: Coloring, cutting, pasting, shape recognition

Social Studies: Locating plates on a world map and identifying major global features (continents and oceans)

Activity One: Earth from the Inside Out

Materials for the teacher

- Transparency made from Master 12a, Layers of the Earth
- Overhead projector
- Hard-boiled egg with the Earth's plates outlined in permanent marker (Crude markings will do.)
- Kitchen knife or dental floss

Materials for each student

- Batches of Play-Doh™, modeling medium (see recipe), or plasticine modeling clay
- Master 12b, Earth Layers Worksheet
- Small strips of yellow, blue, and red construction paper
- 3 toothpicks
- Scissors
- Paste or glue
- Dental floss or butter knife

Procedure

1. Show the transparency on the overhead projector, pointing out the three basic layers of the Earth—core, mantle, and crust—and describing each.
2. Show students the egg and point out the marks that indicate the plates.

Explain: The Earth's top layer is broken into pieces called plates. The plates are always moving, but usually very slowly—about as fast as your fingernails grow. Sometimes, when the plates move away from each other, bump into each other, or grind past each other, we experience earthquakes. Then we feel shaking, and sometimes we hear rumbling.

3. With a sharp knife, slice the egg, shell and all, and show students the layers inside. Explain that the crust is something like the shell, the white is something like the mantle, and the yolk is something like the core.
4. Prior to this activity make batches of modeling medium if Play-Doh™ or modeling clay is not available.

core

The core is the deepest layer of the Earth. It helps to heat the Earth from inside like a furnace.

man • tle

The mantle is the layer between the core and the crust. It is mostly solid. Just below its top is a semi-solid layer with a consistency something like modeling clay or gelatin dessert.

crust

The crust is the top layer of the Earth, solid and very thin compared to the other layers.

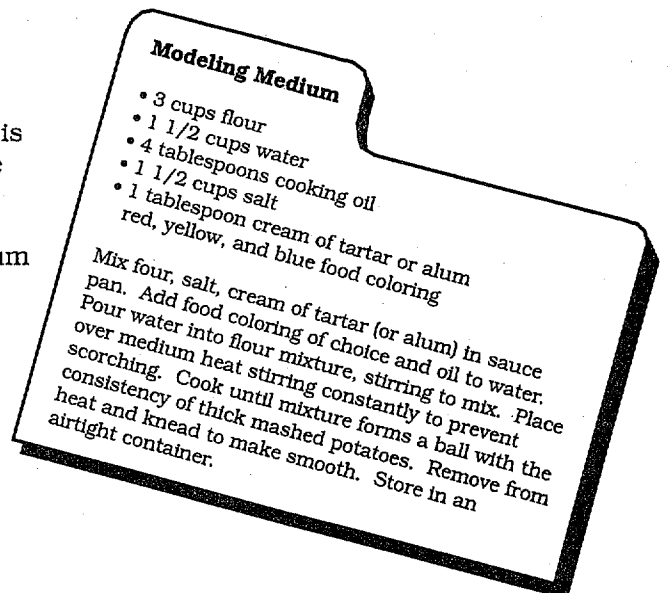

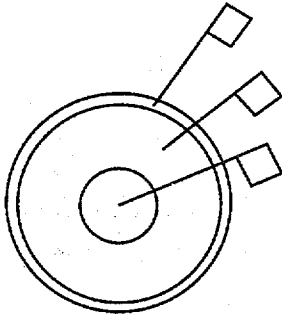

Model of inside of the Earth with labelling flags.

Toothpick flags: toothpicks with a piece of paper wrapped and glued around one end

5. Encourage students to create their own model of the inside of the Earth beginning with the core and working out to the crust.

Have students choose a small portion of red clay to represent the core of the Earth. They will need a greater portion of yellow (mantle), and then blue (crust) to create their model.

Using dental floss or a butter knife, have students cut their model in half, then label each section with a toothpick flag.

6. Distribute copies of Master 12b, Earth Layers Worksheet. Direct students to color the Earth's layers in different colors: red for the core, yellow for the mantle, and blue for the crust. Readers can cut out the labels and paste them in the correct boxes.

Activity Two: Energy Transfer

Materials for each student

- A color-coded sign saying Core (red), Mantle (yellow), or Crust (blue), perhaps on a string to hang around the neck.

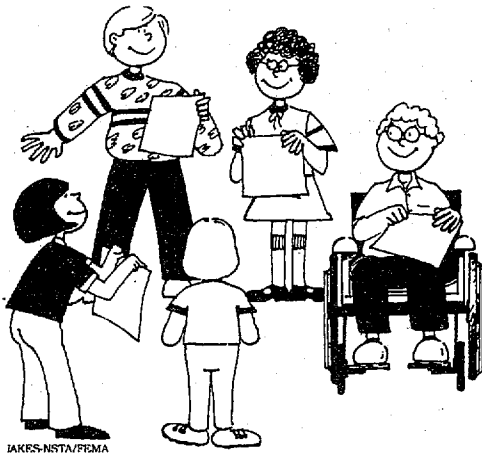

IAKRS/NSTA/FEMA

Teacher Take Note: In later grades students will also learn about the *lithosphere*, the layer to which the plates belong. For now the three basic layers are enough.

Procedure

1. Invite students to use their bodies to represent the layers of the Earth.
2. Select a small group of children (2 or 3) to represent the core, and give them red signs which say **Core**. Ask them to stand in the center of the room. Students should show that they are very hot, perhaps by mopping their brows and fanning themselves.
3. Select a larger group (8 to 10 students) to represent the mantle. Give them yellow **Mantle** signs and ask them to form a circle around the core group. Students should move very slowly around the core group.
4. Give blue **Crust** signs to about 15 more students and ask them to hold hands and surround the mantle group.
5. Tell the mantle students that when you call out "Earthquake," they are to bump into the crust students, causing them to move and break their circle. This transfer of energy from mantle students to crust students simulates roughly what happens during an earthquake.

Activity Three: Giant Jigsaw Puzzle

Materials for the teacher

- Egg model from Activity One
- World Map
- Transparency made from Master 13, Earth Plates
- Overhead projector

Materials for each student

- Handouts made from Masters 13, Earth Plates, 14a, Puzzle Pieces, and 14b, Puzzle Pieces
- Crayons
- Scissors
- Paste

Procedure

1. Repeat the egg demonstration to establish the relationship of the crust to the shell and the existing plates. Draw continents onto the egg shell, crack the egg, and gently manipulate both parts of the egg back and forth, demonstrating the movement of the Earth's plates.

2. Recall the turtle story in Unit I, and explain that the theory of plate movement gained general acceptance among scientists only in the late 1960s. Also remind students of the activity in which they represented the layers of the Earth. Ask:

- What causes most earthquakes? (The Earth plates move.)
- When one part of the crust moves, what happens to the other parts of the crust? (They move too.)

3. Display Master 13, Earth Plates, on the overhead, and compare it to the world map. Explain that the Earth's crust can be divided into major plates which fit together like the pieces of a gigantic jigsaw puzzle. Help students observe that some of the plate boundaries are under the ocean.

4. Hand out Masters 13, 14a, and 14b, and direct students in cooperative groups to color all the shaded areas on the Master 14 pages brown. These represent the Earth's major land masses. Have them leave the remaining areas blue. These represent oceans and seas.

5. Ask students to count the puzzle pieces so that they perceive the boundaries and can point to each piece. (This is important to be sure that they are interpreting positive and negative space correctly.) Point out that one plate has no land on it, and another has very little land.

6. Direct students to cut out the Master 14 puzzle pieces, and paste them on the worksheet made from Master 13, the Earth plate outlines. Be sure they understand that their diagram represents a flattened view of the Earth and its plates.

Extensions

1. Tell the turtle story from Unit One. How would you explain an earthquake if you were a modern Gabriellino who had studied about the layers of the Earth and its plates?
2. On a paper plate, draw a diagram of the layers of the Earth. Label each layer.



Some of the smaller plate regions are not cut apart into puzzle pieces on Masters 14a and 14b as they would be too small for the children to handle comfortably.

Teacher Take Note: To make a larger floor or learning center version of the puzzle, enlarge Masters 14a and 14b. Paste the enlargements onto tagboard, laminate (if possible), and cut out the pieces. Put Velcro™ on the back of each piece so you can use it on a flannel board.

Plates Going Places

Vocabulary

crust
 lithosphere
 mantle
 outer core
 inner core
 plates
 convection current
 magma
 divergent plate boundary
 strike-slip (transform) plate
 boundary
 convergent plate boundary

Learning Links

Language Arts: Participating in class discussions, writing paragraphs, following directions

Social Studies: Locating plate boundaries, locating various geographic features

Math: Interpreting a graph of the thickness of Earth's layers, observing the proportions of the layers to each other

Art: Drawing the interior of the Earth, constructing a model of the Earth's interior

Content Concepts

1. The Earth has a layered structure.
2. Its outer layer, the lithosphere, is broken into pieces called *plates*.
3. Convection currents in the mantle might be the cause of plate motion which results in earthquakes.

Objectives

Students will

- describe the structure of the interior of the Earth.
- name and identify the layers of the Earth.
- interpret a graph of the approximate thickness of the Earth's layers.
- observe a model demonstrating the layers of the Earth and its plates.
- relate earthquake epicenters to plate boundaries.
- identify 12 major plates of the Earth.
- demonstrate the motions of plates.
- observe a convection current.

Assessment

Shakequake, USA (a fictitious town), has many earthquakes. Use what you learned in this unit to explain possible causes of earthquakes in that particular area.

Activity One: What's Inside

Materials for the teacher

- A globe of the Earth
- Transparency made from Master 15, A Pizza the Earth
- Transparency made from Master 16, Graph of the Earth's Layers, colored according to the directions in 3 and 4 below
- Overhead projector

Materials for each student

- Worksheet made from Master 15, A Pizza the Earth
- Worksheet made from Master 16, Graph of the Earth's Layers
- Crayons or colored pencils
- Metric ruler

Procedure

1. Show the students the globe. Define the term diameter, then tell them that the Earth's diameter is about 12,760 km or about 7,900 miles. Put this distance in context by comparing it to a distance students are familiar with, such as the distance from their town or city to a distant, but familiar location.
2. Explore students' ideas about the inside of the Earth. Is it the same all the way to the center? Distribute art supplies and ask them to draw what they think the inside of the Earth is like, then write a paragraph describing the drawing. (This activity will help you to know what background they are bringing to the topic.)
3. Project the transparency of the transparency of Master 15, A Pizza the Earth, and distribute the matching worksheet.
 - a. Explain that the drawing is a model of the layers inside the Earth. Briefly describe each layer, and have students label the inner core, outer core, mantle, lithosphere, and crust as you speak.
 - b. Ask students to color each of the Earth's layers a different color. Color the area from the beginning of the lithosphere out to the surface yellow, then go over the outermost section with blue to indicate the crust. (The overlapping colors, which should produce green for the crust, will help students to understand that the crust is part of the lithosphere.)

con • vec • tion cur • rent

A convection current is a circular movement in a fluid in which hot material rises and cold material sinks.

lith • o • sphere

The lithosphere is the solid outer region of the Earth in which earthquakes begin. It contains the crust and the uppermost portion of the mantle.

out • er core

The outer core is the liquid portion of the Earth's core.

in • ner core

The inner core is the solid central portion of the Earth.

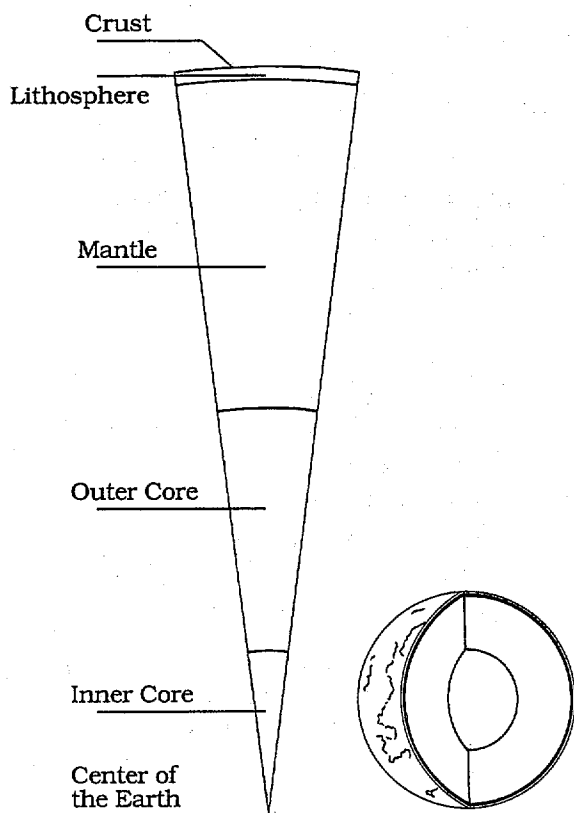

4. Distribute Master 16, Graph of the Earth's Layers. Ask students to use the following data to construct a bar graph of the thickness of the Earth's layers:

Layer	Thickness in Km
crust	40
lithosphere	100
mantle	2900
outer core	2000
inner core	1400

Remind students that a graph should contain a title, scale, and labels. Ask students to color each bar the same color they used for that layer in their Pizza of the Earth (Master 15) worksheet. Use a transparency of Master 16, Graph of the Earth's Layers, to discuss the proportions of the layers with your students.

5. (Optional) During another class period or as homework, invite students to make a three-dimensional model showing the layers of the Earth. Tell them they must label the layers and make them in correct proportion to one another. They may choose any material and manner of construction they like. You may want to display some of these models in a school display case.

Activity Two: We're All Cracked Up

Materials for the teacher

- Several hard boiled eggs
- Small kitchen knife
- Narrow permanent marker
- Free-flowing broad permanent marker

Procedure

1. Before class, cut a hard-boiled egg in half with its shell on. On one half, make a dot of color in the center of the yolk with a permanent marker to represent the inner core. Color the outside of the shell with the broad marker to represent the crust.

Rap another hard-boiled egg on any hard surface to produce a pattern of large cracks. When you have a design you like, outline the edges of the cracks with the narrow permanent marker. (This may also take several attempts. You do like egg salad, don't you?)

Teacher Take Note: It may take several tries to cut the egg neatly. A very sharp knife will help.

2. Use the marked half of the cut egg as a model to review the layers of the Earth with your students. Ask the following questions.

Which layer of the Earth does the shell represent? (The lithosphere. The color on the outside represents the crust, which is less than half as thick as the lithosphere itself.)

Which layer does the white represent? (The mantle)

Which two layers does the yolk represent? (The outer core and inner core)

3. Hold up a whole cooked egg and ask students what would happen to the shell if you rapped it on your desk. (It would develop cracks.)

4. Show them the cracked egg you prepared in advance and point out that the shell is now divided into adjoining sections. The lithosphere is similarly divided into sections, which we call *plates*. The plates of the Earth include a portion of the upper mantle as well as the crust. We use the term *lithosphere* to describe the part of the Earth to which the plates belong, from the surface down to a depth of about 100 km.

5. Explain that unlike the sections of eggshell, the plates of the Earth are in motion. They move very slowly (at a rate of only a few centimeters a year), over a portion of the mantle that has plastic properties, rather like the silicone putty or flubber we used in Unit I. This movement can cause earthquakes.

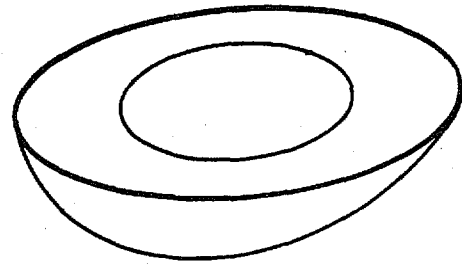

Sliced, hard cooked egg displays layers something like the Earth's (So does an avocado, if you don't like cooking.)

Activity Three: Plates of the Earth

Materials for the teacher

- Transparency of Master 17, Plate Boundaries Map
- Overhead projector

Materials for each student

- Handout made from Master 7, World Map with Epicenters
- Handout made from Master 17, Plate Boundaries Map
- Crayons or colored pencils

Procedure

1. Distribute copies of the epicenter map and the plate boundaries map.
2. Ask students what relationship they see between the locations of earthquakes and the plate boundaries. They should be able to see a correlation.
3. Point out the arrows on the Plate Boundaries Map, Master 17, which indicate the direction in which each plate is moving. Ask them to color the arrows red.

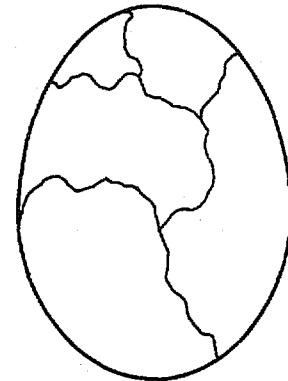

Cracked egg illustrates plates of the earth.

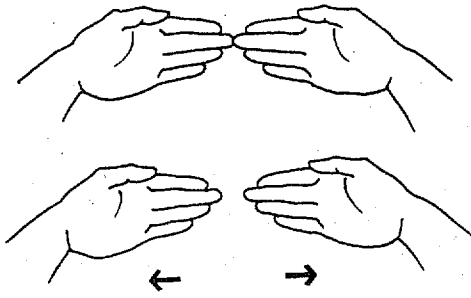

a. Divergent: Begin with fingertips and slowly pull hands apart

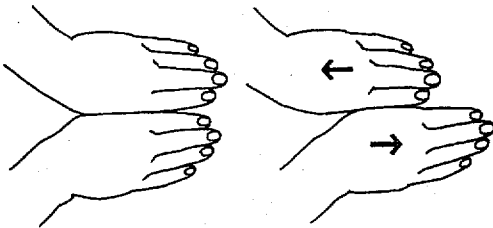

b. Lateral (transform): Begin with hands side by side. Slide one forward and the other back, so they pass by each other.

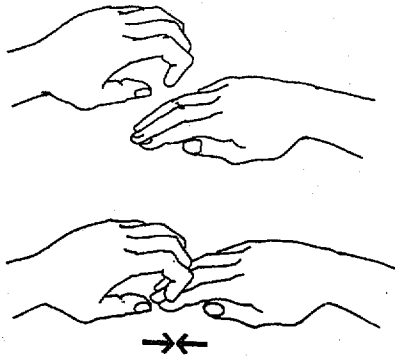

c. Convergent: Begin with knuckles facing each other. Bring hands together, letting one slide (subduct) under the other.

4. Explain that each plate has a name, and point each one out as you read its name aloud. Instruct students to put their red pencils or crayons aside and use different colors to color all of the plates—lightly, so the names and arrows can still be seen.

5. Either in a class discussion or on a worksheet followed by a class discussion, cover these points:

How many plates are there on the map? (Twelve. Explain that some experts identify twenty or more.)

Locate India. Where do you see a plate boundary in India? (on the northern border) What geographic feature do you find there? (mountains)

Locate the Atlantic Ocean. Are there any plate boundaries in that ocean? (Yes. Plate boundaries divide the ocean from north to south.)

Which large island in the Atlantic Ocean has a plate boundary going through it? (Iceland)

6. Project the transparency of the plate boundaries map.

7. Again point out the arrows which indicate plate movement, and explain that this movement is of three kinds: divergent, lateral (or transform), and convergent. Demonstrate hand motions to simulate each kind of movement, and practice them with the class as you give examples of each.

a. Divergent—Begin with fingernails pressing against each other, and slowly pull hands apart. Explain that this kind of plate movement is happening on the floor of the Atlantic and Pacific Oceans. As plates move apart, melted rock, or magma rises from the upper mantle to fill the spaces. Examples: South American plate and African plate; North American plate and Eurasian plate.

b. Lateral—Place hands side by side and slide them slowly past each other. Explain that this kind of activity is occurring right now along the San Andreas fault in California. Example: North American plate and Pacific plate.

c. Convergent—Start with hands facing each other and six inches apart. Bring them together so that one hand is forced under the other. The top hand should ride up and make a fist. Explain that converging plates may form high mountains such as the Himalayas.

As plates move together, one of the plates is pushed down (subducted) under the other: Examples: Australian-Indian plate and Eurasian plate, Nazca plate and South American plate.

Activity Four: Hot Stuff Rises and Cold Stuff Sinks

Materials for the teacher

- Clear heatproof glass baking dish, 23 cm x 13 cm x 7 cm
- Immersion heater (plug-in coil used to heat small quantities of water)
- Sandwich-size plastic bag with twist tie
- Tape
- 2 eyedroppers
- Red food coloring
- Blue food coloring
- A handful of solid paper circles from a hole puncher
- Ice cubes
- Cool water
- Transparency made from Master 18, Convection Currents and Plate Cross Section
- Overhead projector

Teacher Take Note: An immersion heater is safer than most other heat sources. You can buy one for \$3-4 at most hardware stores. It is also a handy way to heat a cup of water for tea, coffee, or broth. A larger container, such as an aquarium, could be used for better viewing.

Procedure

1. Review the concept that Earth's lithosphere is broken into pieces called *plates*. Scientists believe that the plates move because of movement inside the mantle, the way groceries move on the conveyor belts in supermarket checkout lines. This demonstration illustrates what may take place.

2. Fill the glass baking dish almost completely full of cool water.

Be sure to add the blue colored drops to the water just below the surface as drops on the surface will diffuse too quickly and not give the best effect.

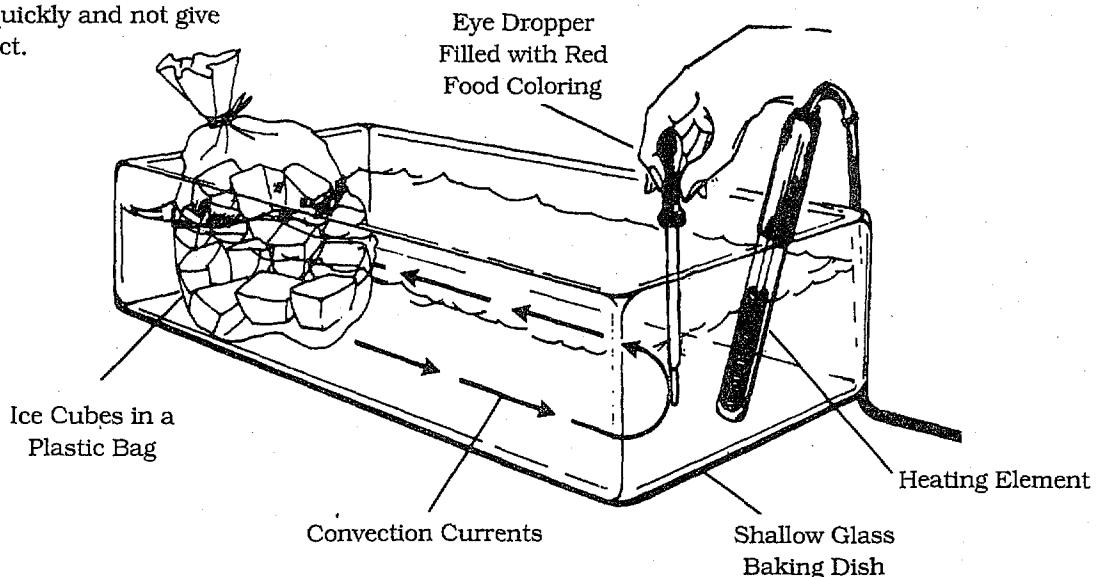

Extensions

1. Read Joanna Cole's *The Magic School Bus - Inside the Earth* or Faith McNutly's *How to Dig a Hole to the Other Side of the World* as a class activity or make it an additional reading assignment.
2. Show pictures of Icelandic rifts, the San Andreas fault, the Himalayan mountains, and other physical features of the sort that occur at plate boundaries.
3. Show the class a film, filmstrip, video, or computer animation on plate tectonics. (Because most of them were designed for older students, you may want to show just portions, or use the images and provide your own narration.)
3. Put about six ice cubes in the plastic bag and close it with the twist tie.
4. Place the bag in the water at one end of the dish and tape it to the side so it can't float away.
5. Place the immersion heater in the water at the other end of the dish and plug it in. *Warn students to stay away from the heat source.*
6. Wait about one minute for the water to heat. Then use an eyedropper to put several drops of red food coloring on the bottom of the dish near the heater. Ask students to observe what happens. (Some of the coloring will rise to the top and float toward the other end of the dish.)
7. Now use the second dropper to put a few drops of blue coloring into the water just under the surface, near the ice. Ask students to describe what they see. (The coloring will sink and move along the bottom of the water toward the other end of the dish.)
8. Put a few of the paper circles on top of the water in the warm end. Students will see them moving around on the surface of the water. Explain that the Earth's plates may move on the semi-solid layer of the mantle in a similar way, because of temperature changes in the mantle. The systems of heat exchange that cause their movement are called convection currents. Hot material rises, while cold material sinks.
9. Project the transparency of Master 18, *Convection Currents and Plate Movements*, and point out that where two convection currents are rising together, the plates are forced apart. Where two currents are sinking together, the plates are forced together. Scientists hypothesize that these movements are the cause of many earthquakes.
10. If necessary, repeat the demonstration until all the students have had a chance to observe it at close range.

Layers, Plates, and Quakes

Vocabulary

crust
 lithosphere
 mantle
 outer core
 inner core
 plate
 strike-slip (transform) plate
 boundary
 convergent plate boundary
 divergent plate boundary
 volcano
 magma

Learning Links

Language Arts: Discussion, note taking, vocabulary building, following directions

Math: Using a scale to build Earth wedge model

Art: Drawing, cutting, and taping paper models; building convection model

Content Concepts

1. The Earth has a layered structure.
2. The Earth's outer layer is broken into pieces called plates.
3. Three basic kinds of movement take place at the edges of the plates.
4. Plate movements create special surface features near the edges of the plates.
5. Convection currents in the mantle may be the cause of plate movements.

Objectives

Students will

- make a model of the layers of the Earth.
- be able to describe the composition of the layers and their interrelationships.
- model and describe activity at the three major types of plate boundaries.
- observe a demonstration of convection currents and relate the process to plate movement.
- construct a model of continental movement from ancient time through the present and into the future.

Assessment

Shakemeup, USA (a fictitious town) is located on the coast of California. Scientists know that subduction is occurring under this part of California. Describe what you think will happen to this town over the next 100 years.

Activity One: Crust to Core: A Pizza the Earth

Materials for the teacher

- Transparency made from Master 15, A Pizza the Earth
- Overhead projector
- Transparency markers

Materials for each student

- 3 sheets of unlined paper, standard size
- No. 2 pencil
- Meter stick
- Tape
- Copies of Master 16, Graph of the Earth's Layers
- Copies of Master 15 (optional)

Procedure

1. Elicit from class what they think the Earth is like below the surface. Accept various opinions. Depending on answers, class may need to use all or part of the first activity from Grades 3-4 in this unit.

2. Display the transparency of Master 15, A Pizza the Earth. Explain that the Earth is layered and that we have learned about these layers largely from the study of earthquake waves. Define *crust*, *lithosphere*, *mantle*, *outer core*, and *inner core* (see the lower-grade lessons in this unit), and ask students to write definitions of the layers in their notebooks for future reference. (Or give the students copies of Master 15, A Pizza the Earth, and have them add the definitions there.)

3. Tell the class that they are going to create a scale model of a slice of the Earth, from its surface to the center, using the following procedure:

- Attach three pieces of unlined paper by taping together the shorter sides to make a strip about 80 cm long.
- Turn paper over to the untaped side.

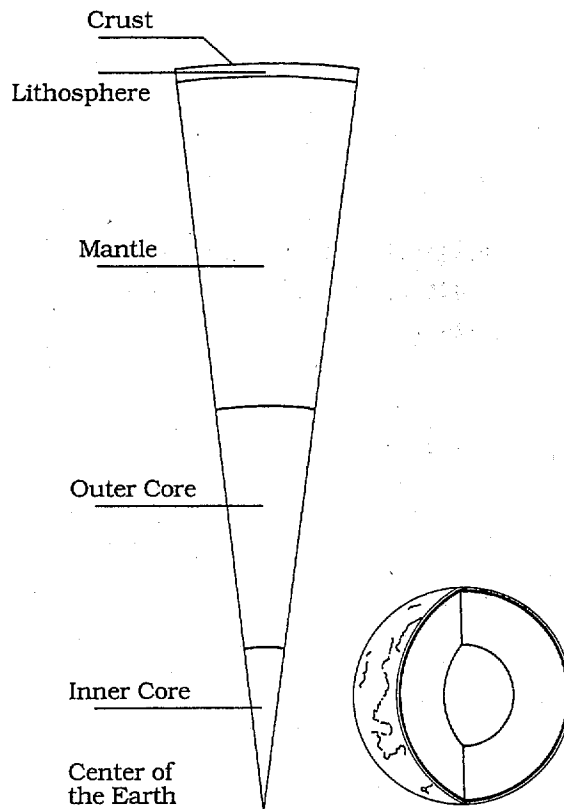

Master 15. A Pizza the Earth answers

"This Pizza the Earth sure has a thin crust"

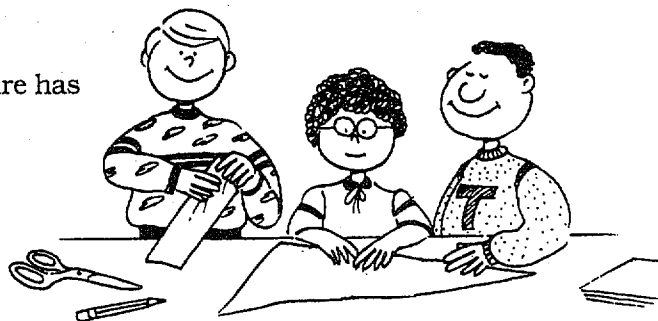

mag • ma

Magma is liquid rock beneath the Earth's surface. When it erupts it is called lava.

vol • can • o

A volcano is a mountain of erupted hardened lava or volcanic rock fragments at the surface of the lithosphere.

Extensions

1. Research how scientists have discovered about the various layers of the Earth through the study of earthquake waves.

2. To the wedge model on Master 15 add the hydrosphere (average thickness of the oceans, about 3.8 km) and the atmosphere (about 960 km thick).

c. Draw, with the aid of a meter stick, a triangle 10 cm wide on top and 64 cm on its other two sides. (This is a scale of about one millimeter for each kilometer of the Earth's radius.) Label the 10-cm side **Earth's Surface** and the opposite end (the point of the wedge) **Center of the Earth**.

d. Compute the scaled distance from the Earth's surface to the bottom of each of the layers, using the data from Master 16. Graph of the Earth's layers. (Students will have to know the scale—1 millimeter equals 10 kilometers—and the definitions of the layers to be able to perform this task correctly. Be prepared to offer help as needed.)

e. Label the layers.

4. When the wedge models of Earth are completed, ask students to answer the following questions:

Which of Earth's layers is the thickest and accounts for most of its volume? (the mantle)

On which layer or layers are the plates? (lithosphere, or crust and upper mantle)

In which layer or layers can faulting occur to create an earthquake? (again, lithosphere or crust and upper mantle)

How does the part of the Earth we live on—the crust or lithosphere—compare in thickness to the Earth's interior? (It's the thinnest part.)

Activity Two: Slide, Collide, and Separate

Materials for the teacher

- Overhead projector
- Transparency made from Master 17, Plate Boundaries Map

Materials for each student

- Copy of Master 17, Plate Boundaries Map
- 10 sheets of lined notebook paper or other 8 1/2" x 11" sheets
- One sheet of colored construction paper
- Scissors
- Transparent tape
- Metric ruler

Procedure

1. Use the transparency and student copies of Master 17, Plate Boundaries Map, to explain that different types of interactions occur among lithospheric plates at their boundaries. You may want to use the hand movements from Level 2, Activity Three, of this unit to demonstrate.

a. Lateral boundaries exist where two plates slide and grind past each other as they move in parallel or opposite directions.

b. Convergent boundaries exist where two plates collide and destroy lithosphere by compacting, or shortening, and melting. There are two major types of convergence:

When two ocean boundaries or an ocean boundary and a continental boundary collide, an ocean plate edge sinks, and melting occurs. Plate boundaries of this type are associated with ocean trenches, coastal mountain ranges (e.g. Cascades), and island arc volcanoes. The melting forms magma, which rises, creating the volcanoes of the island arcs.

When two plates that have continental areas at their convergent boundaries collide, the lithosphere crumples up and new young mountain ranges form. This is happening today where India is colliding with Asia, forming the Himalayan Mountains.

c. Divergent boundaries exist where two plates diverge or separate, as at mid-ocean ridges. Divergence results in the formation of new lithosphere and crust, because separation allows liquid rock, or magma, to rise from the mantle below, forming volcanoes and new rock.

2. Tell the class that they are going to make some simple models of two major types of plate boundaries. If the class has never done hand motions to model the activity at plate boundaries, do Activity Three from the Grades 3-4 section of this unit first.

3. Ask students to get out their notebook paper and make two stacks of five sheets each. Then give them the following directions:

- a. Using large letters, label the top sheet of one stack **Plate A** and the top sheet of the other **Plate B**. From now on, we will refer to the stacks of paper as "plates."
- b. With scissors, cut .5" (1 cm) slashes at 1" (2 cm) intervals, fringing the long side of each plate. These slashes will represent the broken-up, crushed rock at the plate boundary.

Teacher Take Note: To conserve paper use recycled paper or have students work in small groups.

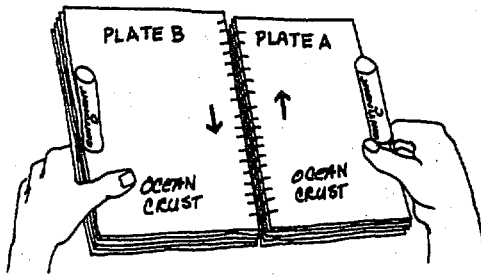

Lateral boundary: Edge slide, but sometimes catch and jerk.

- c. Hold the plates together, one in each hand, in front of you. Push one plate forward and pull the other back towards your body.

What did you feel? (sliding with frequent hitches as the slashed edges engage)

What do you think this model represents? (A lateral plate boundary. The sliding motion represents fault creep, and the jerky motion represents the buildup and release of energy in an earthquake. The San Andreas lateral boundary in California exhibits this kind of motion. Plates slide, but locking of sections occasionally results in earthquakes.)

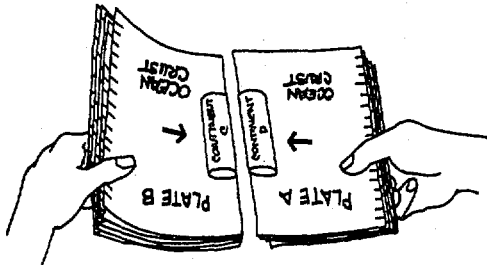

Convergent boundary with continents: Plate edge humps up, and may form mountains over time.

4. Tell students that next they will use their **Plates A and B** to model another type of plate boundary. Give these directions:

- Label the top of each plate **Ocean Crust**.
- Cut the sheet of colored construction paper in half lengthwise, and make a loop out of each section. Tape the loops closed, and press down on each one gently to flatten it.
- Label one loop **Continent C** and the other **Continent D**, or make up names and write them on the loops. These loops will represent continents or continental crust.
- Tape the middle of each loop to the short side of one of the plates with the closed side facing out.
- Hold a plate-continent combination in each hand with the continent edges facing each other. Push the two plates together and observe what happens to the continents riding on the plates.

What do you see? (The plates will hump up and the edges of the continents will rise.)

What might this represent? (The demonstration represents the convergence of two plates, the shortening or folding of the crust and the formation of mountains.)

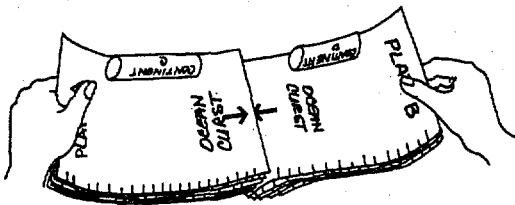

Convergent boundary with oceanic crust: One plate edge is forced under the other. This process may account for the formation of oceanic trenches.

- Turn the plates around so their plain short edges (without continents) face each other, then push those edges together.

What happened? (One of the plates slid under the other.)

What might this represent? (It represents two plates of oceanic crust converging. The depression which results represents an oceanic trench.)

5. Help students to summarize their observations, and answer any questions they may have.

Activity Three: The History of Geography

Materials for the teacher

- Transparency made from Master 18, Convection Currents and Plate Cross Section
- Transparency made from Master 19, Formation and Break-up of Pangaea
- Overhead projector
- Materials and directions from Unit II, Level 2, Activity Four
- World map or globe

Procedure

1. Ask students what they think might cause the Earth's plates to move. Accept various suggestions, then explain that the mechanism of plate movement is one of the major unsolved mysteries in Earth studies. The most widely accepted explanation is that convection currents in the Earth's mantle drive the plates. If students are not clear on the definition of *mantle*, review the definitions in Level 1.

2. Briefly describe convection currents, and project Master 18, Convection Currents and Plate Cross Section. Give several common examples of convection, such as hot air rising and cold air falling in the classroom, or warm water rising to the top and cool water sinking to the bottom in a lake or pool.

3. Discuss possible energy sources for convection and the movement of plates. (Many Earth scientists believe that heat energy is produced within the interior of the Earth, perhaps by the decay of radioactive materials like uranium and radium within the core and mantle.)



200,000,000 years ago



65,000,000 years ago

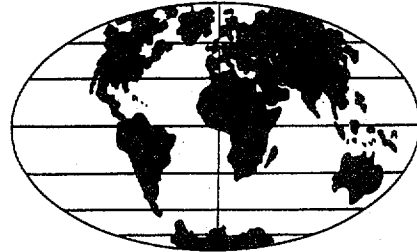

Today



50,000,000 years from now

Master 19, Formation and Breakup of Pangaea

4. Refer to a globe, a world map, or a transparency of a world map, and ask how Africa and South America could fit together, almost like parts of a jigsaw puzzle. Students may see a similar fit among Europe, North America, and Greenland. Query class for a reason for this fit, and lead up to a brief discussion of Pangaea, the supercontinent of 200,000,000 years ago.

5. Using the transparency of the breakup of Pangaea (Master 19), very briefly show how we think the supercontinent changed to become the continents of today. Be sure to emphasize that the continents move only as parts of plates, not by themselves.

6. Indicate to the class that they are going to observe a model showing how convection currents could move the plates and the continents that ride on them. This model may explain the breakup of the supercontinent Pangaea over the last 200,000,000 years.

7. Do Activity Four, "Hot Stuff Rises and Cold Stuff Sinks," from Level 2 of this unit.

8. Again direct students' attention to the transparency of Master 18, Convection Currents and Plate Cross Section. Point out and briefly discuss what happens where convection currents rise and sink.

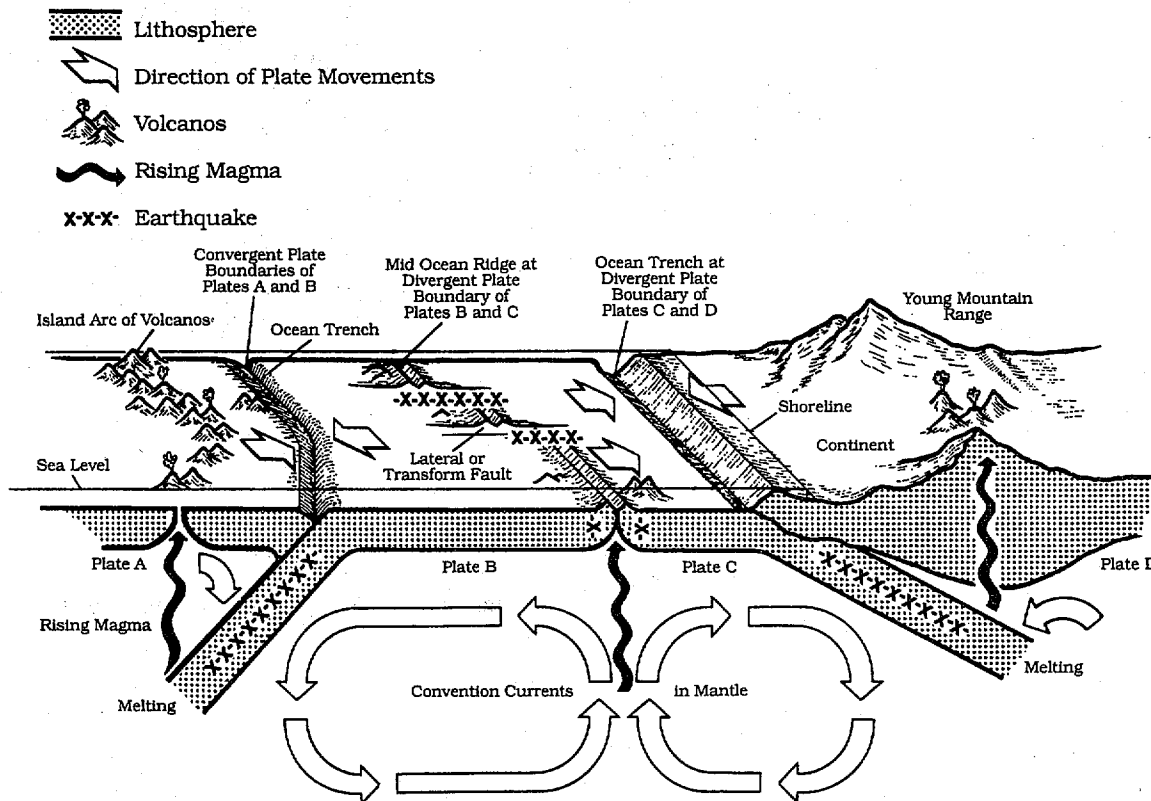

Activity Four: Flippin' through Pangaea

Materials for the student

- 1 copy of each Master 20a through 20d for each student
- Scissors
- Stapler (in classroom)

Procedure

1. Tell the students they are going to construct a flip book that illustrates the last 200,000,000 years on Earth. (You may want to show a finished book to emphasize careful cutting and to give the general idea.)
2. Direct students to very carefully cut masters 20a, 20b, 20c, and 20d apart on the straight lines. After cutting, they should stack the rectangles in sequential order. Numbered corners should be face up and in the upper left corner. The two blank ellipse panels should be on the bottom.
3. Align lower edges by tapping on a hard surface. Then align the left edges similarly. Hold the stack with both hands, having thumbs on top. Bend the stack back and forth several times until the edges on both sides are "slightly" offset. Hold the book with your right hand and staple it together (in far enough to include all the pages, about .5 cm.)
4. Ask students to describe the changes in the pictures from panel 1 to panel 22. (The large dark mass, "Pangaea," breaks apart, and the continents as we know them today are formed.) Ask students to make predictions about what will happen to the continents in the future. (There will be further movement of continents in the same direction.)
5. Direct students to draw their predictions on the last two blank ellipses. (Remind students that they should make their drawings sequential.)
6. Have students discuss their predictions and drawings.

Unit II. Why and Where Earthquakes Occur

Materials List

Grades K-2

hard-boiled egg
permanent marker
dental floss or butter knife
construction paper
toothpicks
modeling clay
paper
crayons
markers
scissors
paste or glue
overhead projector

Grades 3-4

globe
crayons
colored pencils
glass baking dish or
aquarium
immersion heater
plastic bag with twist tie
tape
eyedroppers
red food coloring
blue food coloring
ice cubes
hard-boiled eggs
small kitchen knife
overhead projector
narrow permanent marker
broad permanent marker
paper circles from hole
puncher

Grades 5-6

unlined paper
pencils
metric stick
watch with second hand
colored pencils or crayons
lined paper
colored construction paper
scissors
transparent tape
metric ruler
glass baking dish
plastic bag with twist tie
immersion heater
tape
red food coloring
blue food coloring
eyedroppers
paper hole punches
ice cubes
globe
overhead projector
transparency markers



Layers of the Earth

Name _____

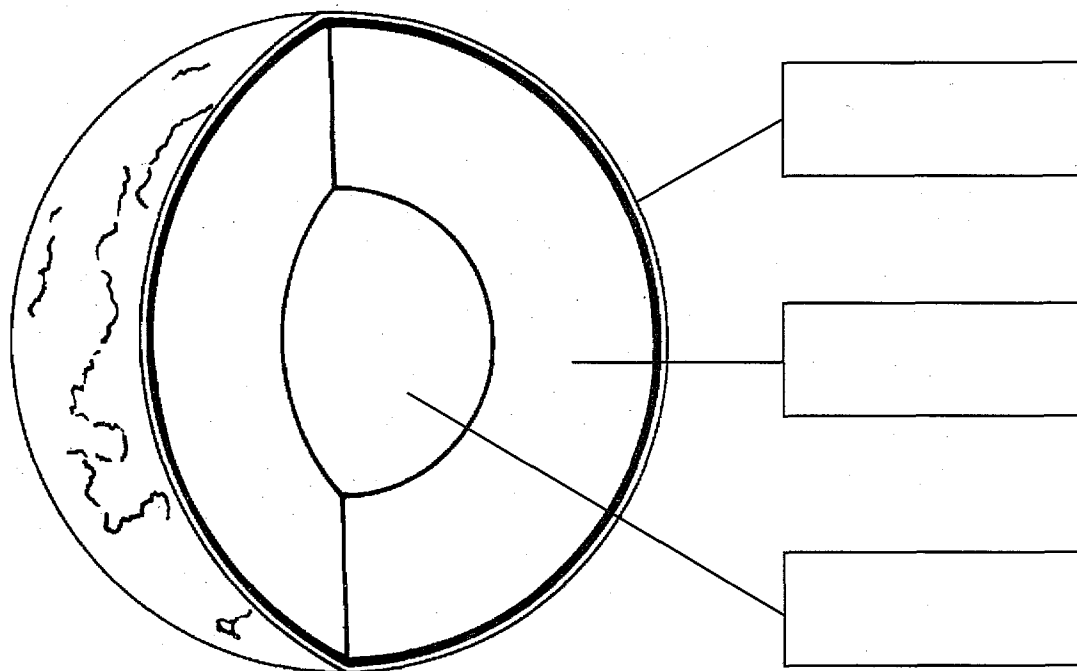

1. Color the layers of the Earth.
2. Cut out the words and paste them in the correct boxes.

Crust

Mantle

Core

Earth Layers Worksheet

Name _____

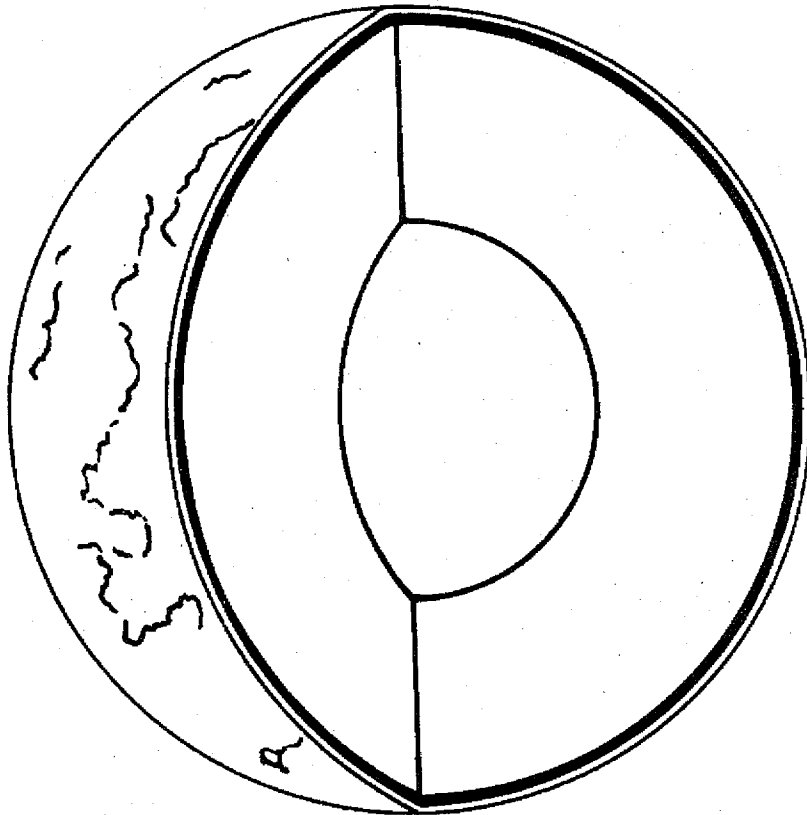

1. Color the core red.
2. Color the mantle yellow.
3. Color the crust blue.
4. Put a brown line around the very hot layer.

Earth Plates

Name _____

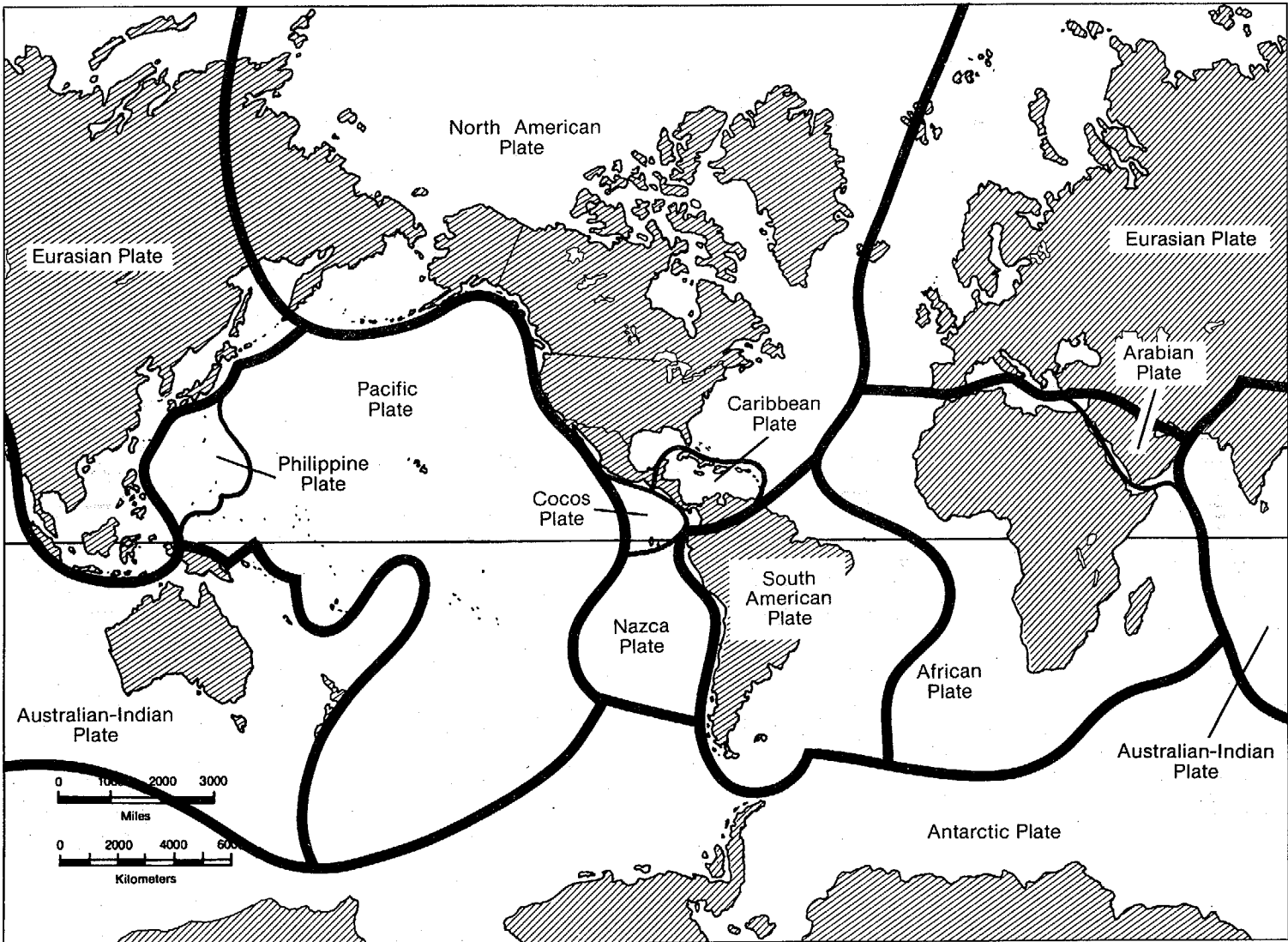

Earth Plate Puzzle Pieces

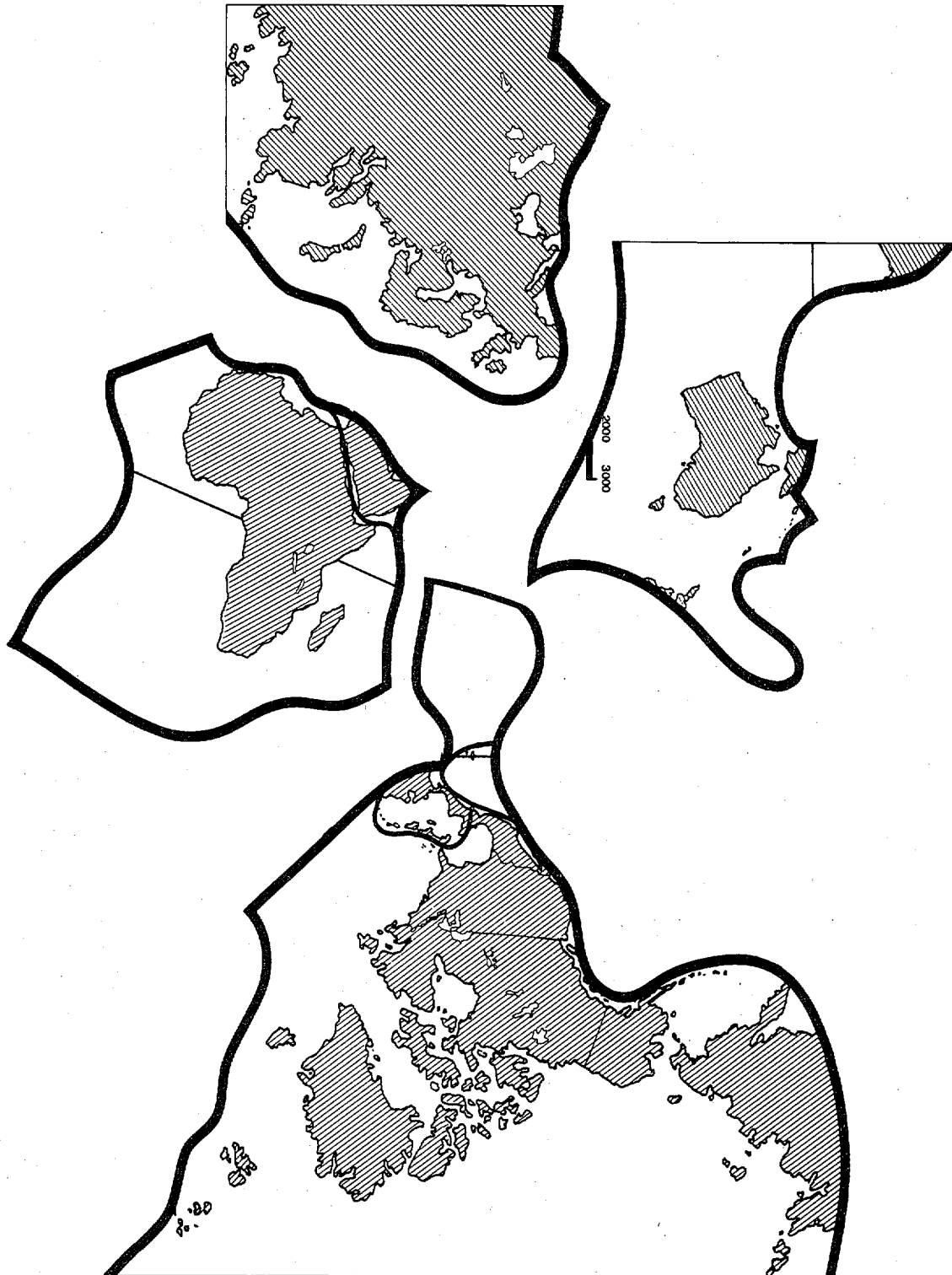

Earth Plate Puzzle Pieces

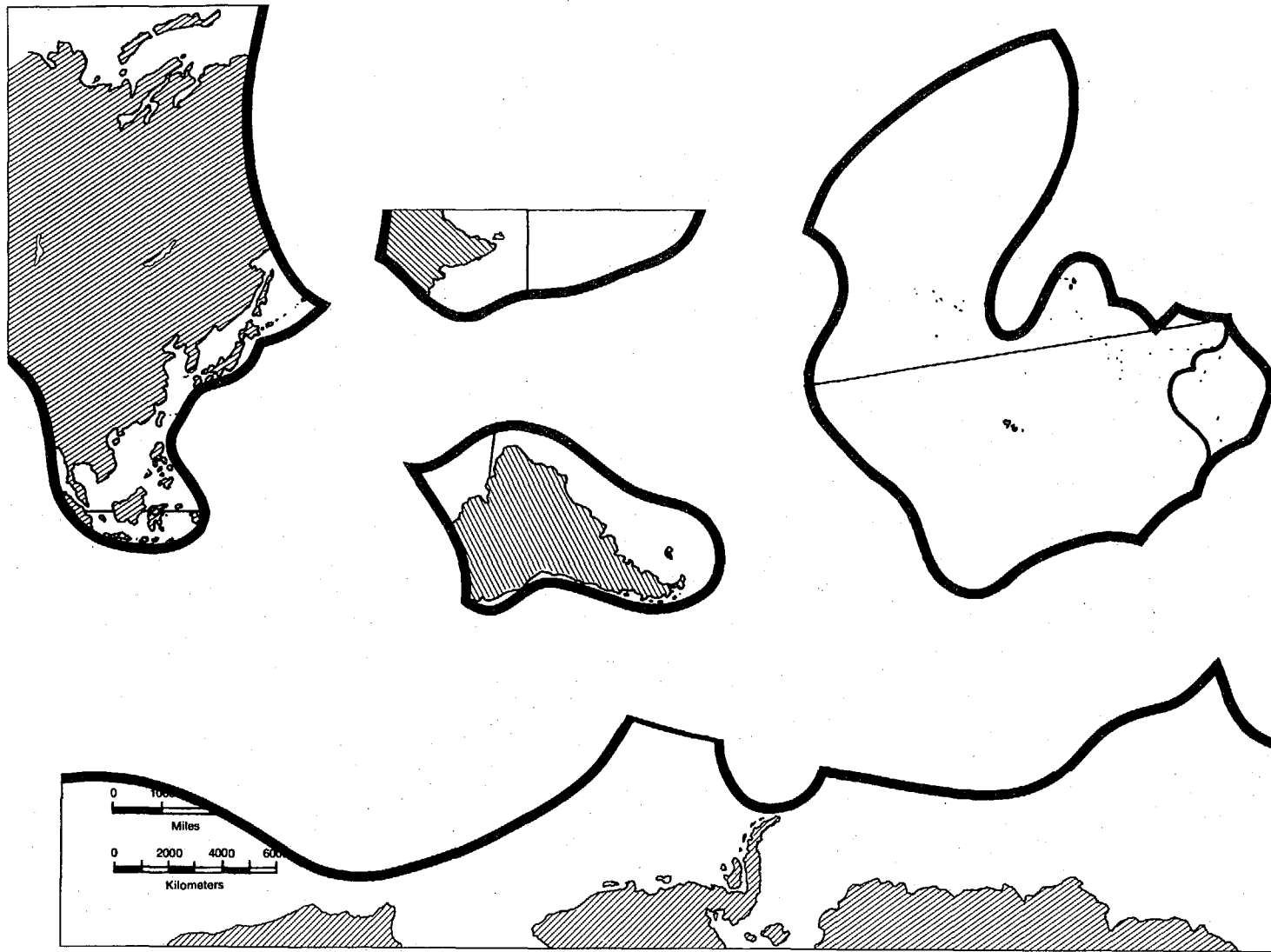

A Pizza the Earth

Name _____

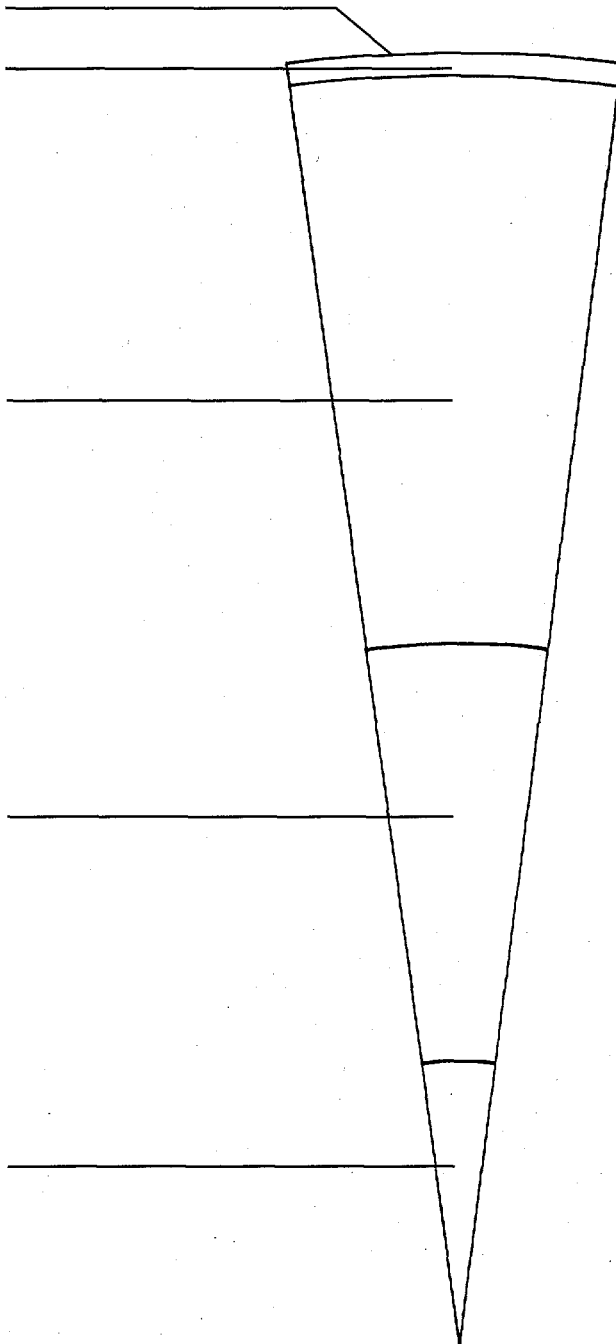

1. Label each layer.
2. Color each layer a different color.

Word Bank

- Outer Core
- Crust
- Mantle
- Lithosphere
- Inner Core
- Center of the Earth

Graph of the Earth Layers

Name _____

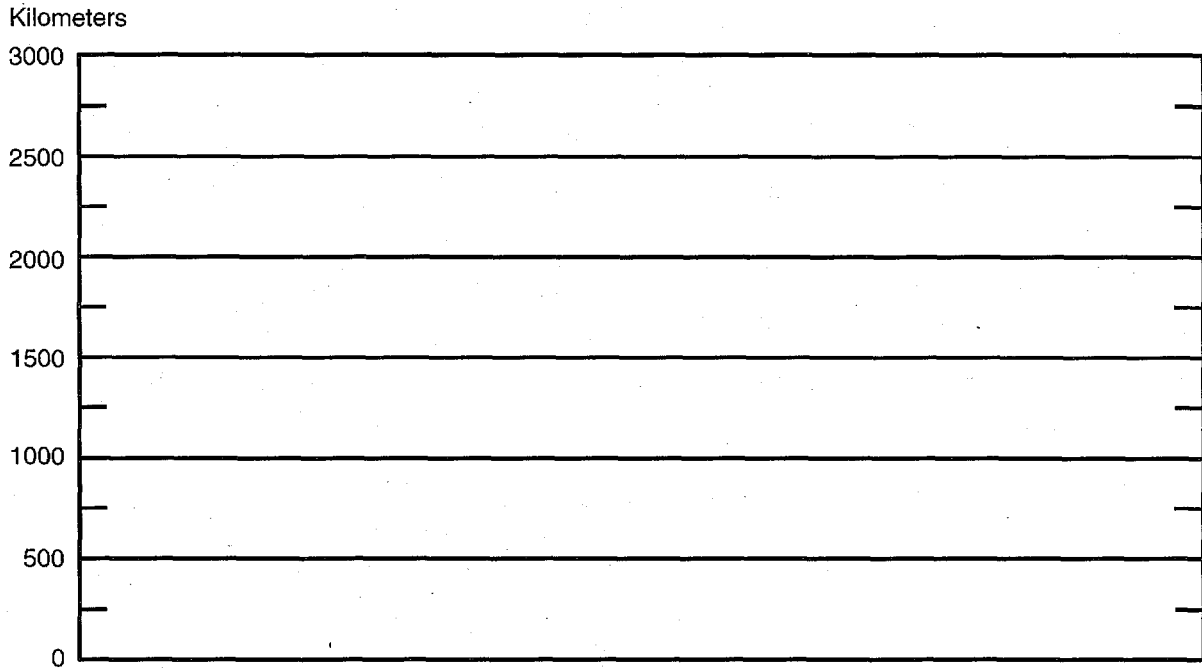

1. Use the following data to construct a bar graph of the thickness of the Earth's layers:

Layer	Thickness in Km
crust	40
lithosphere	100
mantle	2,900
outer core	2,000
inner core	1,400

2. Which layer of the Earth is the thickest?

3. Which layer of the Earth is the thinnest?

4. What is the total thickness of all the Earth's layers?



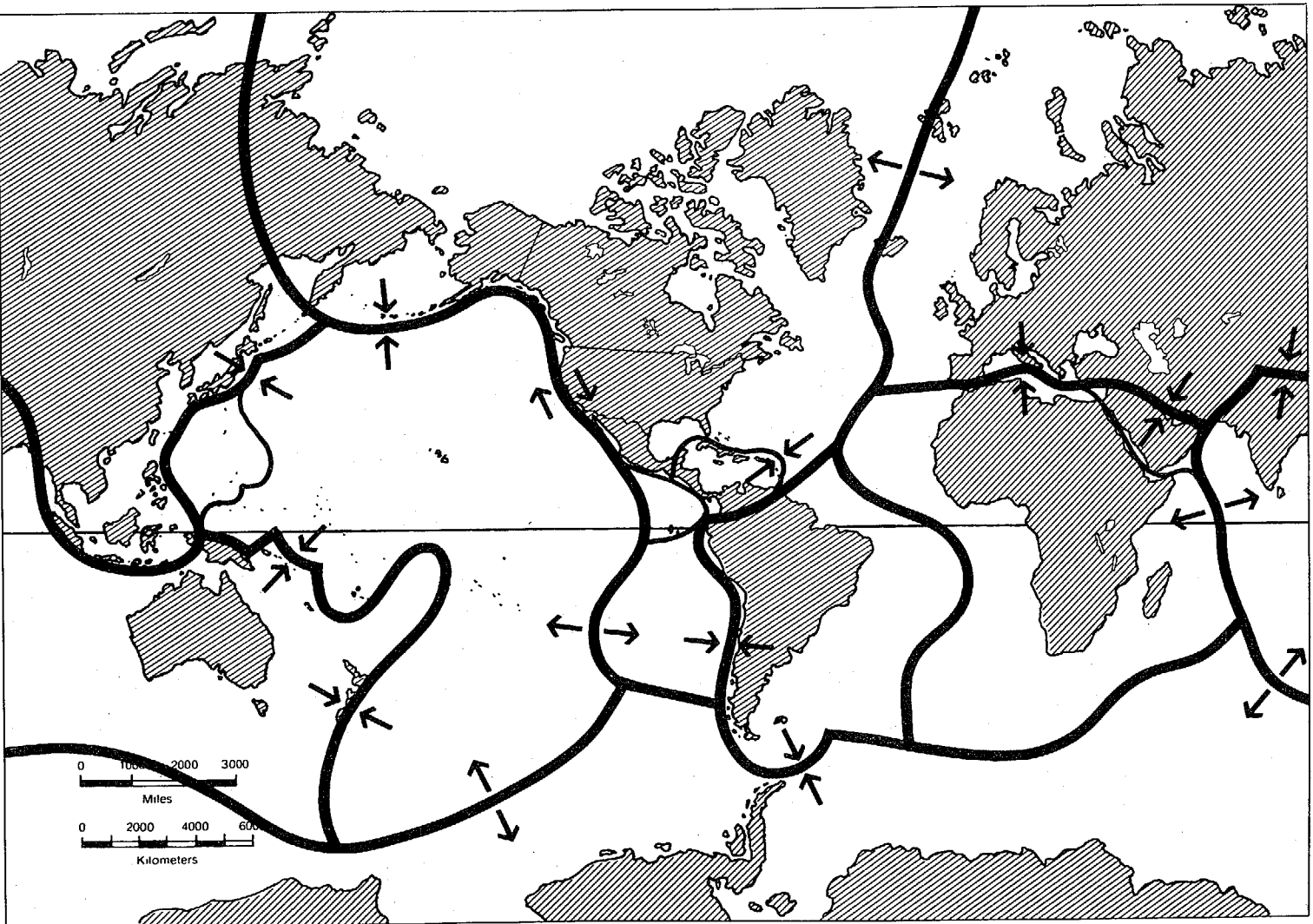

Plate Boundaries Map

Name _____

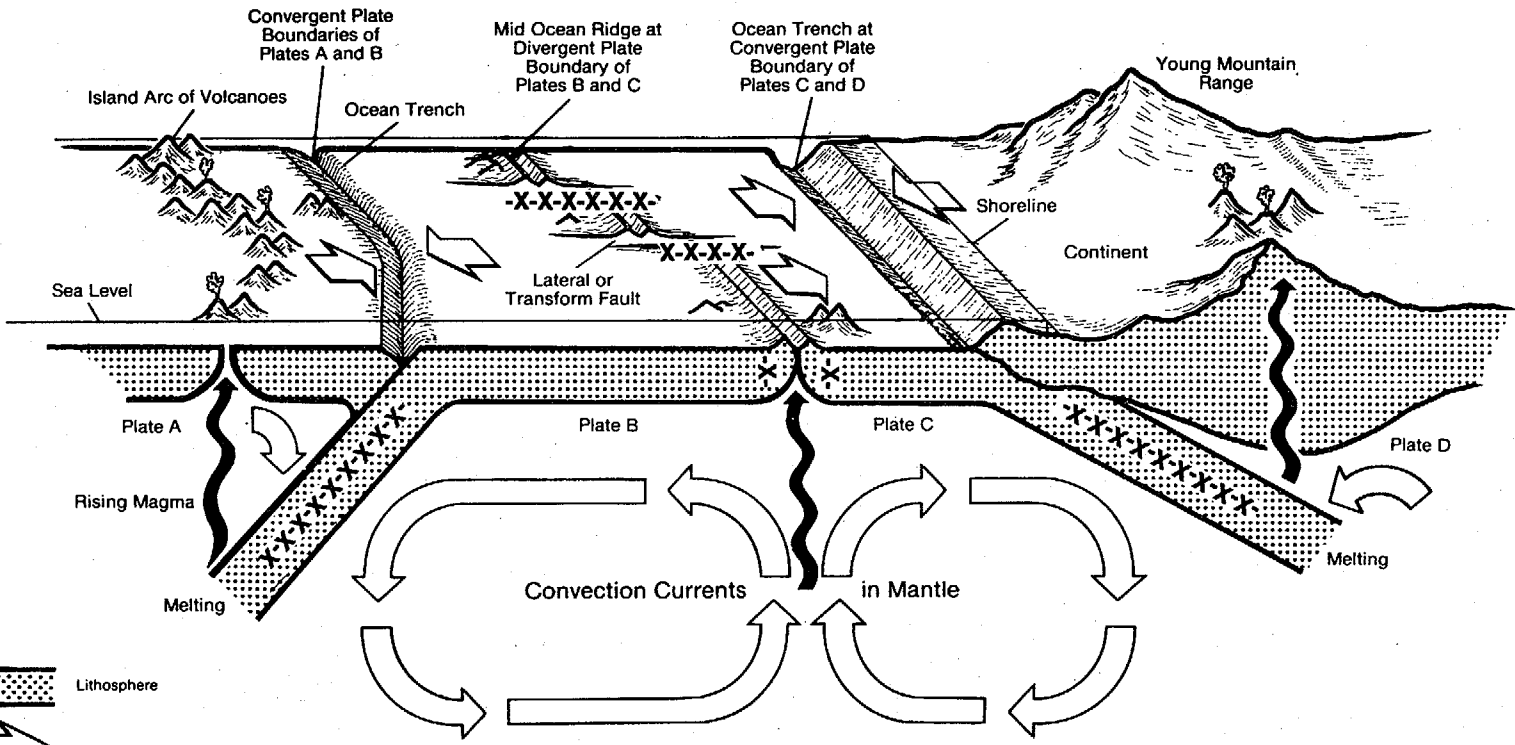

Convection Currents and Plate Cross Section

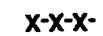

-  Lithosphere
-  Direction of Plate Movements
-  Volcanoes
-  Rising Magma
-  Earthquake

Formation and Breakup of Pangaea



Earth's land masses about 200,000,000 years ago when there was one large land mass—Pangaea, or supercontinent.

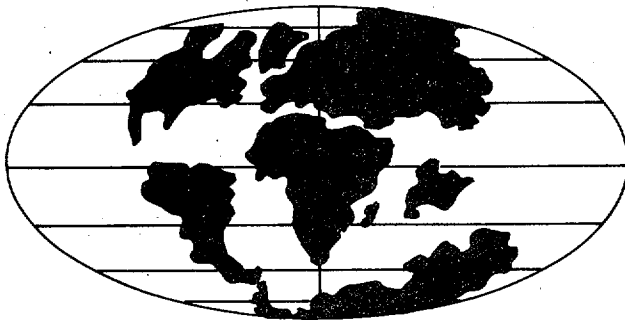

Earth's land masses about 65,000,000 years ago when the supercontinent broke up into smaller continents.

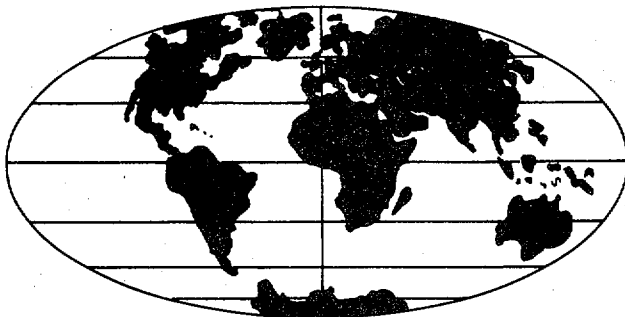

Earth's land masses today where India has collide with Eurasia. Eurasia continues to separate as the Atlantic Ocean widens.

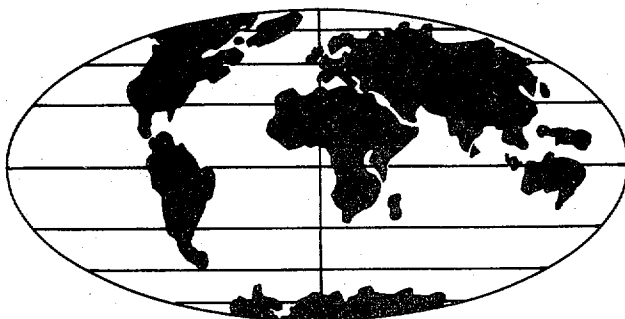

Earth's land masses about 50,000,000 years into the future.

III



Physical Results of Earthquakes

Earthquake Curriculum, K-6 -- Scope and Sequence Chart

Unit III: Physical Results of Earthquakes

Level	Concept	Laboratory	Mathematics	Language Arts	Social Studies	Art
K-2	Earthquakes cause changes in the Earth's surface	Hand movement simulation of Earth plate motion. Fault movement game Milk carton simulation of earthquake results	Math facts practice	Vocabulary development of earthquake words	Features of a community Map making	Illustration of a community Model construction
3-4	Small-scale topographic changes are associated with plate movements. Earthquake activity causes small-scale topographic changes.	Paper simulations of rock layers and models of faults Sand simulation of liquefaction Landslide simulation Tsunami simulation	Planes and angles recognition Measurement practice	Write-up of landslide activities Vocabulary development of earthquake words	Effects of faults, landslides, and fissures Geographic features locations	Fault model construction Construction of seashore environments for tsunami simulation
5-6	Tectonic movements, including earthquakes, are among the major forces which create Earth's landscape. Mountains, plains, and plateaus are the major features of the continents. Many of the Earth's most significant landscape features are under the oceans.	Paper simulation of rock layer movement Mountain building simulation Ocean turbidity current simulation		Vocabulary development of earthquake words	Map study of plate boundaries	Construction of underwater landscape

III

Physical Results of Earthquakes

Over billions of years, Earth motions and earthquakes have played a major part in shaping the physical features of our Earth, both on land and under water. Over time, small-scale changes make foothills and minor cracks; large-scale changes produce towering mountains and deep valleys. As the plates of the Earth's surface move, warping slowly up, down, and sideways in relation to each other, we may feel these movements as earthquakes. The waves of energy they release not only shake the Earth, but also alter the nature of many soils, giving them an unstable liquid-like consistency. Then structures sink, tip, and topple, and hillsides crumble.

Physical Results of Earthquakes

If there were no plate motions, our planet would not look like home. There would be no mountains, no valleys, and no plateaus. Without the uplifting of land caused by tectonic (mountain building) processes, most land above sea level would be uniformly flat, whittled down by the processes of erosion.

Earth-Shaking: Earth-Shaping

Earthquakes and other tectonic events have been occurring for as long as the Earth has existed. The changes in the landscape associated with these events range from small cracks in the soil to the raising (*uplifting*) or lowering (*downdropping*) of huge chunks (or *blocks*) of the lithosphere.

No large mountain or deep valley has been formed as the result of a single earth-shaking event. The raising and lowering of sections of the Earth generally happens gradually, in small increments. Over thousands and millions of years these increments add up to significant changes, such as fault block mountains and deep graben valleys.

Faults and Folds

As a result of plate motions, the accumulated stress and strain within the rocks of the lithosphere may cause great warps or folds in rock layers. Where rock is strained beyond its limit, it will fracture, and the rock mass on either side will move abruptly.

Up, Down, or Sideways

A fault is a fracture within the Earth's crust along which significant movement has occurred. Faults are often classified according to the direction of movement and whether movement is predominantly horizontal or vertical.

Horizontal Fault Movement

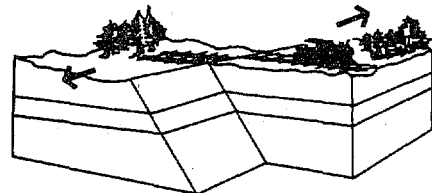

Vertical Fault Movement

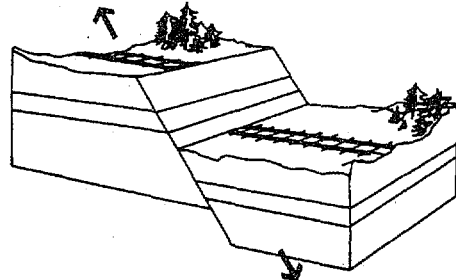

Displacement of rock along a fault can occur as a result of vertical or horizontal fault movement. Vertical fault movement changes the elevation of a rock mass on one side of the fault relative to the rock mass on the opposite side. Rock masses on one side of the fault can also shift horizontally in relation to the opposite side. Fault movement is always stated in relative terms.

Vertical fault movement may result in cliffs (scarps) along the fault line. Horizontal or lateral fault movement may cause roads and river banks to change their position. In the lessons that follow, students will use hand movements and paper models to illustrate these fault movements.

Folding Rock Layers

Folding is another way that rock layers respond to stress. They may crumple sideways, without fracturing, like wrinkles in a rug. We can see small folds in hand specimens of sedimentary rock; larger examples of folded rock layers can be seen in mountain sides and road cuts. Some mountain chains, such as the Alps or the Folded Appalachians, show primarily folded structures.



Soil Liquefaction

Although deep-down earthquake action takes place in the rocky lithosphere, much of the dollar damage that occurs in earthquakes results from the *liquefaction* of soil. When earthquake vibrations pass through soil which has a high water content, the soil loses the properties of a solid and takes on those of a semiliquid, like quicksand or pudding. The foundations of heavy buildings suddenly lose the support of the soil, and they may topple, or settle deeper into the Earth.

You have experienced liquefaction on a small scale if you have ever walked along the beach and seen water rise to the top of the sand at your every step. When liquefaction happens on a large scale, however, as it did at Nigata, Japan, in 1964, it spells disaster.

Why Land Slides

Earthquakes may trigger many landslides, particularly during the rainy season. The potential for landsliding is highest in soft sediments on steep slopes; where seasonal rainfall is high; where vegetation is shallow, rotted or sparse; where erosion is high; and where ground shaking is intense.

Underwater Earthquakes

Earthquakes on the ocean bottom may result in the up or down shifting of large blocks of the crust. Such motion can generate a special kind of ocean wave called a tsunami, or seismic sea wave. A series of these waves may travel at speeds up to 800 km/hr in the deep ocean, where they are too small to be seen. But, when they reach land, they mount to heights of tens of meters and break against the shore and its buildings. Low coastal areas can be flooded, and much loss of life can result.

It is difficult to adjust our focus wide enough, in both space and time, to recognize the geological events and structures that surround us on dry land. It is even more difficult to think about those events and structures when they occur underwater; where we cannot see them. Yet water covers about 70 percent of our planet, and the same tectonic forces are at work on the floors of the oceans as on the continents.

Although the same processes are at work, we need a new vocabulary to understand them. Mountain ranges in the ocean are called *mid-ocean ridges*; plains are called *abyssal plains*. Landslides (or submarine slides) occur as well, but we call them *turbidity currents*. The fourth activity for Grades 5 and 6 gives students a chance to model turbidity currents.

A Word to the Wise

If you can communicate the scope and magnitude of tectonic events to your students, and make them aware that earthquakes are something more than disasters on a human scale, you will have done a great deal. Enjoy these activities with them.

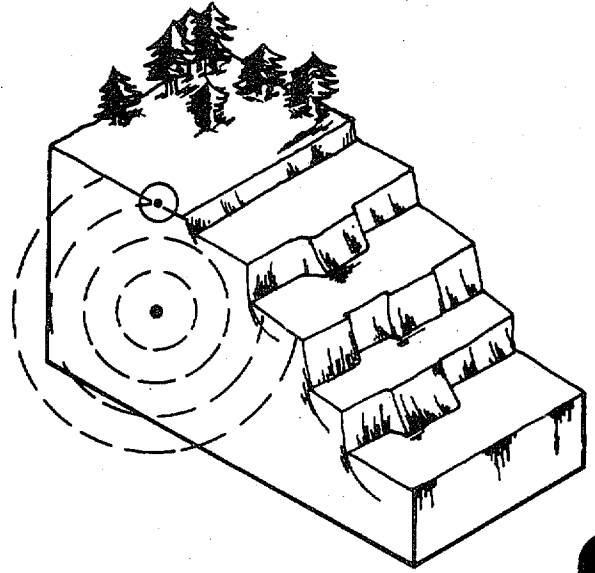

Earthquakes Shape Our Earth

Vocabulary

fault
rural

Content Concept

Earthquakes cause changes in the Earth's surface.

Objectives

Students will

- demonstrate three faulting actions.
- describe a rural community.
- draw a model of such a community.
- demonstrate the effects of earthquakes on the model community.

Assessment

Choose one kind of fault and describe its movement. If an earthquake occurred, tell what would happen to a new fence that a farmer built across that fault.

Learning Links

Language Arts: Discussing features of a rural community, describing results of earthquake simulations

Social Studies: Extending the concept of community, completing a map

Art: Drawing a diagram of a community, constructing a model

Activity One: Earth Movers

Materials for the teacher

- Overhead projector
- World map or transparency of Master 13, Earth Plates
- Transparency of Master 21, Fault Movements

Procedure

1. Review with the students the concepts that the Earth's surface is made up of plates, and that those plates have been shifting and moving over millions of years. Direct their attention to the map.
2. Explain that earthquake movement does not occur just at the edges of the plates, but also within the continents. Movements may happen at cracks in the Earth called *faults*. These movements are of two main kinds—up and down, and sideways.
3. Display Master 21, Fault Movements and point out the directions of the two movements. Demonstrate the types of faults with hand movements, and ask students to perform the movements along with you.

Up and down movements

Down movement (Normal faulting). Make your hands into fists and press the flat edges of the fingers together. Release the pressure and let one hand drop about 4 cm. The straight fingers and knuckles of the other hand will resemble a fault cliff.

Up movement (Reverse faulting). Press knuckles and fingers tightly together as before. Without releasing the pressure, let one hand slide up about 4 cm. Again, the result will look like a cliff, but students should be able to see the difference in the two processes.

Sideways movement (Lateral, or transform faulting). Press the sides of the hands together. As you release the pressure, slide your two hands past each other in a jerky motion. You will feel the vibrations and see the horizontal displacement of the two sides which occurs in this type of faulting.

Horizontal Fault Movement

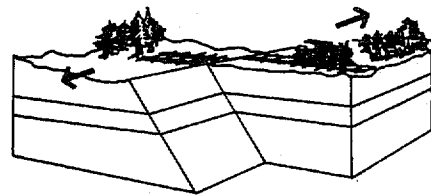

Vertical Fault Movement

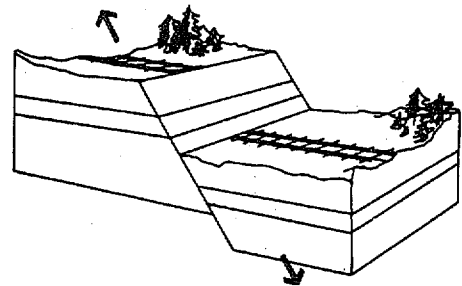

Master 21, Fault Movements

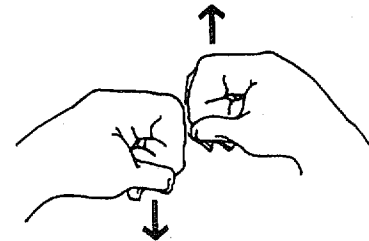

Illustrate up and down plate movement by raising and lowering fists in relation to each other.

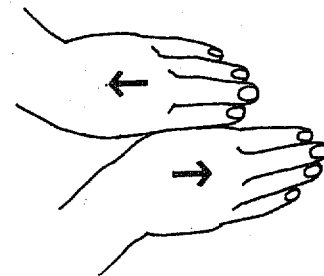

Illustrate lateral, sideways, movement by sliding one hand next to the other.

fault

A fault is a crack in rock or soil where movement has taken place.

ru • ral

A rural community is a farming community where people do not live close together as they do in cities.

Activity Two: Model Communities

Materials for the teacher

- Overhead projector
- Transparency made from Master 22, Rural Community after an Earthquake

Materials for each pair of students

- Two 1/2-gal. milk or juice cartons
- Rubberbands
- Pencils and felt markers or crayons
- Paper to cover top and sides of each carton
- Colored construction paper (strips)
- Scissors
- Masking tape or glue
- Clay, Play-Doh™
- Odds and ends (e.g., toothpicks, string, paper clips)

Procedure

1. Review faulting actions with students. Project Master 22, Rural Community, and ask students what they see. Discuss the effects of the earthquake on the rural community pictured.
2. Tell students that they are going to construct a similar community. Ask them to name some physical features of a rural community, and list them on the overhead or on the blackboard. (Do not include people or animals.) Your list may look something like this:

long fences
crops planted in rows
roads
houses

barns
bridges
trees
utility poles and wires

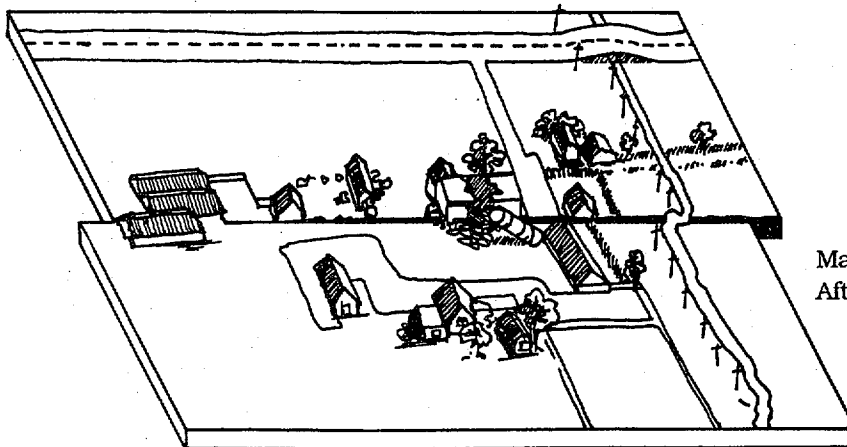

Master 22, Rural Community
After an Earthquake

3. Distribute 1/2-gal. milk cartons to each pair of students. Ask them to plan a model community and include some of the features they listed above.
 - a. Open completely one end of each carton.
 - b. Place the cartons side by side, with the open ends facing opposite direction.
 - c. Place one or two rubberbands around the middle of both cartons, locking them together.
 - d. Cover the top and side of each carton with construction paper. Wrap each carton from the long edge where the cartons meet and cover top and one side. Do not cover the ends.
 - e. Use the materials provided to construct a 3-dimensional community on the top surface of the cartons.
4. Tell students that the place where the two cartons meet represents a fault.

Direct students to use the cartons to simulate the two faulting actions from Activity One that they have demonstrated with their hands: up and down faulting, and sideways faulting. (Note: Students can place their hands in the cartons while carrying out this step.) Remind them that earthquakes result from a release of energy, and ask them to place pressure on the fault and release it rapidly each time they want to bring the cartons into a new position.

5. Ask students to observe and describe the changes to their community after each simulation.

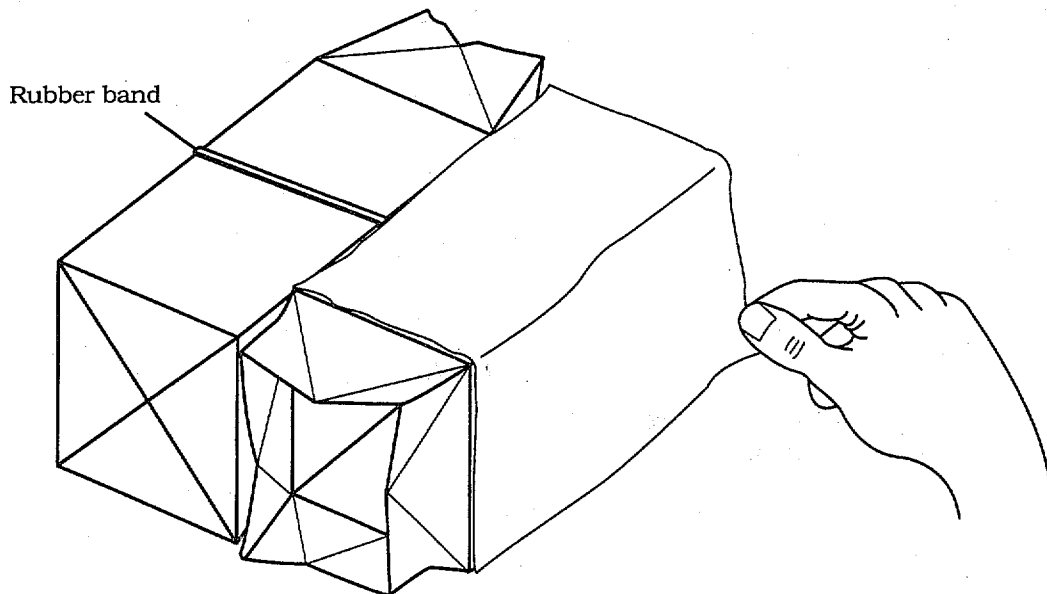

Landscape on the Loose

Vocabulary

normal fault
 reverse fault
 lateral (strike-slip) fault
 Appalachian mountains
 fault plane
 fold
 groundwater
 landscape
 landslide
 liquefaction
 tsunami

Learning Links

Language Arts: Labeling types of faults, following oral instructions, writing paragraphs

Social Studies: Locating geographic features, discussing how faults, landslides, and tsunamis affect people's lives and property

Math: Measuring materials for liquefaction demonstration

Art: Making fault models, constructing seashore environments for tsunami simulation

Content Concepts

1. Small-scale topographic changes are associated with plate movements.
2. Earthquake activity causes small-scale topographic changes.
3. Earthquakes on the ocean floor sometimes cause giant seismic sea waves, or *tsunamis*.

Objectives

- Students will
- understand that many landscape features are a result of earthquake activity.
 - construct models of three types of faults and be able to name and identify them.
 - demonstrate the formation of folded rock.
 - demonstrate liquefaction, and describe how it happens.
 - demonstrate a landslide and describe some factors that influence the results of landslides triggered by earthquakes.
 - identify tsunamis as an earthquake event, and demonstrate their mechanism and effects on shore faults.

Assessment

You visited a town that had a leaning building. Use what you know about sandy soils and water beneath the surface to explain what may have caused the building to lean.

Activity One: Up, Down, and Sideways

Materials for the teacher

- Map of U.S.

Materials for each student

- Worksheet made from Master 23, Fault Model
- Scissors
- Colored pencils or crayons
- Tape
- Paper strip 5/8 inch wide from standard size paper.

Procedure

1. Distribute worksheet with fault diagrams. Tell students that they are going to make a model to illustrate the three basic types of faults.
2. Explain that horizontal lines on sides of the diagram represent different rock layers below the surface, as we might see them exposed on the side of a cliff. Instruct students to color each layer a different color. (All layers with the same letter should be the same color.)
3. Instruct students to cut out the fault model. Fold the rock layer extensions down to form a box with the features (trees, train track, river) on the top. Taping sides together, the box will make a 3-dimensional model of the top layers of the Earth's crust.
4. The dashed line on your model represents a fault. Carefully cut along the dashed line. You will end up with two pieces.
5. Place the two pieces of your model together so that point A is next to point C. Move the two pieces so that point A is next to point B. This represents a normal fault.
 Ask students to describe how the Earth's surface has changed after the normal fault occurred. (The surface is not level. The left side of the Earth's surface along the fault line is higher than the right side.)
 Ask students to predict what might happen to the river now that the rock layers have moved. (There may be the formation of rapids or a waterfall.)

fault plane

A fault plane is a surface along which faulting movement has occurred.

lat • er • al fault

A lateral fault is a fault with edges that slip past each other.

nor • mal fault

A normal fault is a fault in which the upper block moves downward.

thrust fault

A thrust fault is a fault in which the upper block slides over a lower block.

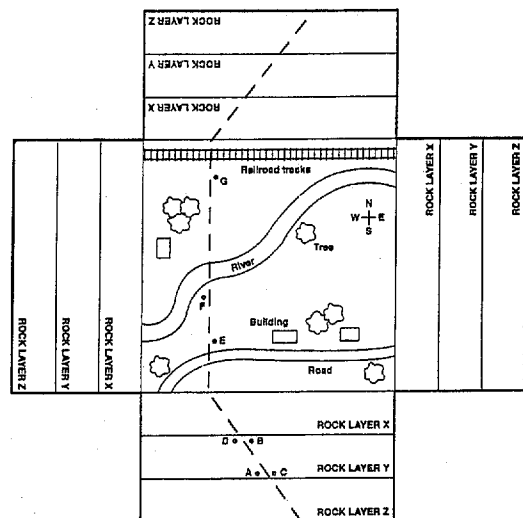

Master 23, Fault Model

6. Place the two pieces of your model together so that point A is again next to point C. Move the pieces so that point C is next to point D. This represents a thrust fault.

Ask the students to describe how the Earth's surface has changed after the thrust fault had occurred. (The right side is overhanging the left side.)

Ask students to predict how the landscape will change after the movement along the thrust fault. (The Earth's surface will erode along the overhang and fall down to the ground below. Eventually a gentler slope will result.)

7. Place the two pieces of your model back to its original position (point A and C together). Viewing the model from above, move it so that point E is next to point F. This represents a lateral fault.

Ask the students to describe how the Earth's surface has changed. (Surface features will not be aligned.)

What will happen to the flow of the river as a result of this lateral fault? (The river will change its course to follow the fault line.)

Ask students to describe how rock layers X, Y, and Z have changed as a result of the lateral fault. (The rock layers have slid horizontally past each other.)

8. Explain that sometimes, when rock layers are exposed to pressure, they do not break or fault, but fold instead. Give these directions for a simple model of folding activity.

Have students cut a narrow strip 5/8" (about 7 cm) wide from a standard sheet of paper.

Place it on top of a hardcover book, along the front edge. Hold it in place at the center with a paper clip.

Slowly push the paper from both sides toward the center. Notice the hills and valleys that form as it folds.

Point out the Appalachian Mountains on a United States map, and explain that parts of the Appalachians and other U.S. mountains were formed by the folding of rock layers.

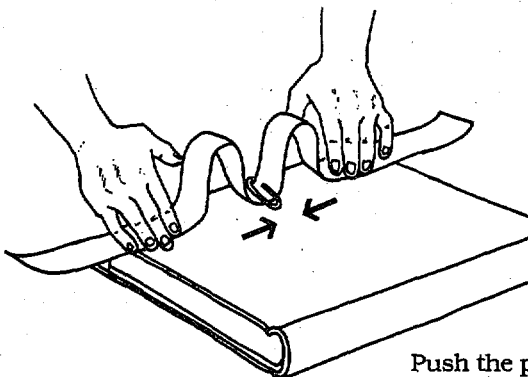

Push the paper slowly from both sides toward the middle

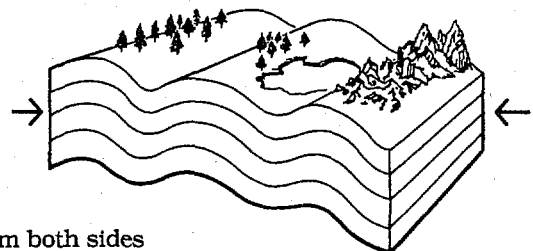

Activity Two: Liquefaction Lab

Materials for each small group

- Newspapers to cover work surfaces
- About 300 mL (1-1/4 cup) of medium- to fine-grain sand in a container (e.g., plastic margarine tub)
- About 100 mL (1/3 to 1/2 cup) of water
- Measuring cup or breaker marked in metric units

Procedure

Introduce the activity by telling students that liquefaction accounts for considerable damage to property. Define the term. Tell students they have experienced it if they have ever felt a foot sink into a patch of extremely muddy ground or in the sand along a shoreline. Give these instructions for the simulation:

1. Place about three fourths of the sand in the bottom of your container. Spread it out to form a flat, even surface. Place the container on a table or desk. This represents soil in an earthquake zone.
2. DO NOT handle your container of sand until instructed to do so. (This is very important. Containers must not be disturbed throughout Steps 3 and 4.)
3. SLOWLY add water to the sand until water just appears at the surface. Let students know that the sand needs time to absorb the water. Discuss with the students that the water they are adding represents precipitation.

liq • ue • fac • tion

Liquefaction is the process in which soil or sand suddenly loses the properties of solid material and instead behaves like a liquid.

Teacher Take Note: For this activity to work, it is very important for students not to handle their containers until instructed to do so.



Extension

A possible extension is to use weights, such as fishing weights, to model buildings sinking because of liquefaction. Plastic buildings do not have enough weight to sink.

4. Carefully sprinkle dry sand over the wet surface so that the entire top of the sand is barely dry to the touch. Press gently with your index fingertip to test for firmness, and add more sand if necessary. (Sand should be firm to the touch.)

5. Place a hand over the top of the container and rapidly slide the container back and forth on the table (the container should not come off the table top). Continue sliding until you observe standing water at the surface. (Explain that the shaking simulates earthquake waves traveling through the ground.)

6. Now press your finger into the sand. What happened? (It should sink easily because the waves of energy you produced by sliding the container have caused water to move up and liquefy the sand.) What would happen to buildings on top of the soil that was liquefied? (They would topple over or sink into the soil.)



Liquefaction of soil can cause buildings to slump and sometimes to collapse entirely.

Activity Three: A Slippery Slope

Materials for the teacher

- Newspapers to cover work surface
- Large tray (Ask your grocer for a supply of large plastic foam meat trays.)
- Local soils of various textures, or potting soil
- Builders sand
- Fine gravel
- Aluminum foil
- Water

Procedure

1. Tell your students that you are going to make a model of a hillside. Follow the directions below:
 - a. Cover your work surface with several layers of newspapers. In the meat tray, build a hill from moistened sand or soil. It may be any height or shape you choose. You may want to make one side steeper than the other.
 - b. Wrap a sheet of foil around your hill to simulate the slippery layer of rock or soil that allows outer layers to slide off during an earthquake.
 - c. Completely cover the foil with another layer of sand, soil, or gravel.
 - d. Ask students to predict the effect of an earthquake on the model. Which parts will be most affected by the earthquake?
 - e. Hold the tray on which your hill rests with both hand, and slide it back and forth sharply on your work surface to simulate an earthquake.

Teacher Take Note: Do some hill building of your own before class, to get the feel of the activity. Although this activity has been designed as a teacher demonstration, it could be done by students in small groups.



Extension

Show pictures of famous landslides caused by earthquakes, such as those that happened at Hebgen Lake in Montana, and in Alaska during the 1964 earthquake. Invite students to research and present reports on these or other landslide events.

2. After producing a landslide, conduct a class discussion including these questions:

How did the shape of the hill affect the landslide? (The steeper the slope, the more easily the material will slide down.)

How did the type of material on top of the foil affect the landslide? (Various answers are possible.)

What would have happened if less water had been used in the soil mixture? What if more had been used? (Landslides are more likely when the surface is water-logged.)

How should the potential of a site for landslides caused by earthquakes affect decisions on locating homes and other structures on or under it? (Such a site would make a poor choice unless it can be reinforced in some way.)

What are some events other than earthquakes that can cause landslides? (Heavy rains, freezing and thawing of the ground, erosion).

3. Have students in groups write a report describing how the hill was built, what they observed during the landslide, and what considerations and precautions should be taken into account when building on or near a slope.

Activity Four: Tsunami!

Materials for the teacher

- Transparency made from Master 24a, Tsunami Facts and Master 24b, Notable Tsunamis
- Overhead projector

Materials for each pair or group of students

- Glass or metal baking pan or plastic shoe box
- About 1 liter of water
- Plastic lid of the type used to reclose coffee or margarine containers
- Punching tool or drawing compass
- Scissors
- String
- Sand
- Erasers, toothpicks, popsicle sticks, and other small objects to represent shore features
- Book or block of wood to serve as wedge
- Metric ruler

Procedure

1. Ask students the following questions:

Do earthquakes occur under the ocean? (Yes)

Do earthquakes under the ocean ever affect people:
(Some students may think of tsunamis. If not, introduce the topic.)

2. Project the transparency of Master 24a, Tsunami Facts. Begin with what students already know about tsunamis, and share the information on the master. Then tell class that they are going to build a model of a tsunami.

tsu • na • mi

A tsunami is a giant ocean wave caused by movements of the ocean floor, such as earthquakes and volcanic eruptions.

Extensions

1. Read to your students:

The Magic Fan, written and illustrated by Keith Baker; *The Big Wave* by Pearl Buck; or *The Wave*, a Japanese folk tale by Margaret Hodges.

2. Use the art print of *The Wave* to initiate a critical review of the print. Discuss medium, colors, and feelings when looking at the print.

3. Divide students into pairs or small groups, distribute materials, and give these directions:

- Use the wedge to tilt the pan at an angle of about 20 degrees.
- Pour water into the pan to cover the lower end, leaving about a third of the pan at the upper end dry.
- Pack a layer of sand 1 in. (2-3 cm) thick on the dry end of the pan to simulate a beach or coastline. Use your hands to mold dunes or drifts. Draw roads parallel to the shore with a stick or your fingers. Build docks and other small, lightweight structures to complete the shore environment. Be creative.
- Punch the plastic lid on one end near the rim to make a hole, and thread it with a piece of string 8 in. (20 cm) long. Tie knots to hold the string in place.
- Gently (in order not to make waves) place the plastic onto the bottom at the deep end of the pan. Trim it to fit if necessary. The string should be next to the low side of the pan.
- Have one student use several fingers to hold the plastic down tightly on the shallow end, while another student pulls the string up at the deep end with a rapid movement. Tsunami!

4. When all groups have completed the simulation, ask them to describe what happened and discuss their observations.

5. Project the transparency of Master 24b, Notable Tsunamis. Discuss data found on overhead. Ask students where do damaging tsunamis occur? (Along any shoreline) What kind of damage is caused by tsunamis? (Property damage, crop loses, etc.) Where do the earthquakes originate that cause tsunamis? (Ocean floor. They also can be generated when large coastal landslides occur on oceanic islands.)

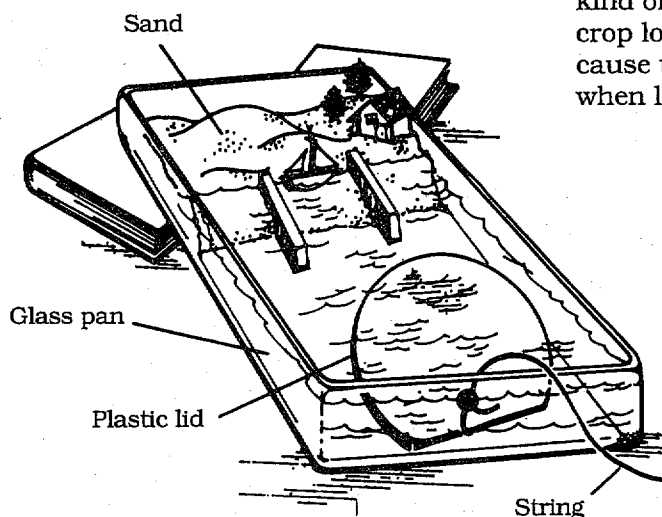

Building Up and Breaking Down

Vocabulary

mountain
 plain
 plateau
 continental slope
 abyssal plain
 underwater delta
 turbidity current

Learning Links

Social Studies: Identifying landscape regions of the United States and identifying ocean bottom features

Art: Constructing model of underwater landscape

Content Concepts

1. The major landscape features we see on the continents are mountains, plains, and plateaus.
2. Tectonic movements, including earthquakes, are among the forces which create Earth's landscapes.
3. Many of the Earth's most significant landscape features are under the oceans.

Objectives

Students will

- describe three major landscape features: mountains, plains, and plateaus.
- identify mountains, plains, and plateaus on a landscape map.
- construct models of various types of mountains and relate those models to specific places in the United States.
- identify, from observing illustrations of the Earth's surface features, which of them were created by earthquakes.
- identify abyssal plains and underwater deltas, and model their formation.

Assessment

Choose mountains, plains, or plateaus, and describe what Earth activity may have caused their formation. Illustrate your ideas.

Activity One: Mountain, Plain, and Plateau

Materials for the teacher

- Transparency made from Master 25a, Landscape Regions
- Transparency made from Master 1b, U.S. Map (with states)
- Master 25b and 25c for reference
- Overhead projector
- A variety of scenic photographs showing major Earth features—mountains, plains, plateaus, and oceans

Materials for each student

- Crayons or colored pencils
- Class notebook
- Handout made from Master 25a, Landscape Regions Worksheet



moun • tain

A mountain is a portion of the landscape that is usually higher than surrounding areas and has steep slopes with faulted, folded, or tilted rocks.

plain

A plain is an area of horizontal rocks that is generally lower than surrounding regions.

plat • eau

A plateau is an area of horizontal rocks that is higher than surrounding areas and usually has some areas of steep slopes.

Procedure

1. Explain that landscape features related to earthquakes range from major features like mountains, plains, and plateaus to smaller features like cliffs and valleys, and very small features like crushed and scratched rock along faults. This unit deals with the major features.
2. Have class members suggest some examples of mountains, plains, and plateaus in the world, the United States, and their own locality.
3. Distribute copies of Master 25a, Landscape Regions Worksheet. Project the transparency of the same master. Ask students to use a purple pencil or crayon to color in every region on their worksheets that has a **1**. These are the mountain regions. Ask them to color the areas with **2s**, the plains regions, in green; and the **3s**, the plateau regions, in brown. Direct the students to complete the key on Master 25a.
4. Project Master 1, U.S. Map, with labels. Help students locate their own state and the two or three neighboring states on their worksheet. Ask the class:
 - What kind of landscape region do you live in?
 - Where is the mountain landscape region nearest to your area?
 - Where is the nearest plains region? What about plateaus?
5. Allow students to discuss their answers until they arrive at a consensus.

Master 25a. Landscape Regions Worksheet

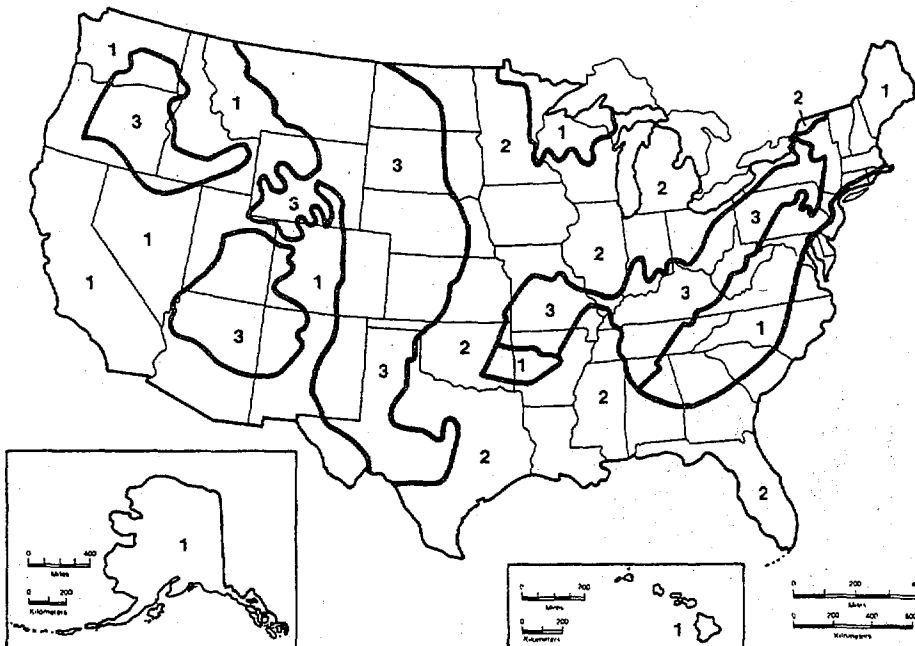

Activity Two: The Folding Mountains Mystery

Materials for the teacher

- Transparency made from Master 25b, Landscape Regions of the U.S.
- Transparency made from Master 17, Plate Boundaries Map
- Transparency made from Master 19, Formation and Breakup of Pangaea
- Overhead Projector
- A classroom map of U.S.

Materials for each small group

- Three to five hand towels or fabric scraps of approximately the same size.

Procedure

1. On a classroom map of the United States, and on Master 23b, locate the Folded Appalachians, the Ouachita Mountains, the Sierra Nevada Mountains, and the Basin Range regions of the United States. Explain that each of these regions has been molded by earthquakes or activity associated with earthquakes.

2. Tell students that the Folded Appalachians and the Ouachita Mountains were formed largely by a process called folding. Distribute three to five towels to each small group. Explain that the towels will represent rock layers of the lithosphere in the simulation they are about to do. Give these directions:

- Stack the towels.
- Hold the stack by its two ends and gently push the towels toward the center. What happened? (The towels folded into several ridges.)

If the sheets of towel were layers of rock, what would provide the push to fold them? (The pressure of earthquake movements and convergent plate movements, or the squeezing of rock layers from opposite sides)

3. Project Master 17, Plate Boundaries Map, and ask: Do you see evidence of plates converging anywhere near either the Folded Appalachians or the Ouachitas? Challenge students: How could these layers have been folded? (Do not provide any answer yet.)

4. After some discussion, project Master 19, Formation and Breakup of Pangaea, and let students observe that plate boundaries were converging in those places hundreds of millions of years ago, when these old mountains were formed.



From Master 19, Formation and Breakup of the Pangaea

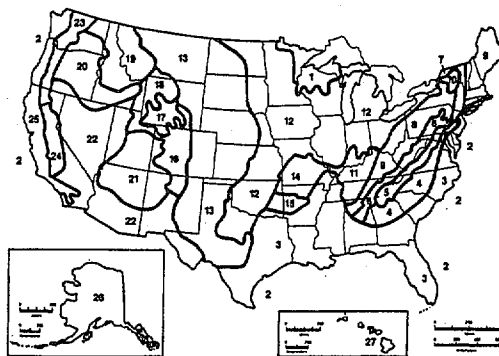

Master 25b. Landscape Regions of the U.S. See Master 25c for a complete list of the regions numbered. The four mentioned in the text include (6) Folded Appalachians, (15) Ouachita Mountains, (22) Basin and Region, and (24) Sierra Nevadas

Teacher Take Note: This procedure can be done with any of several kinds of material, but you'll want to experiment with whatever you select. You'll see what kind of cutting tool works best and know what to expect when you do the activity with your class.

Examples of mountain building action

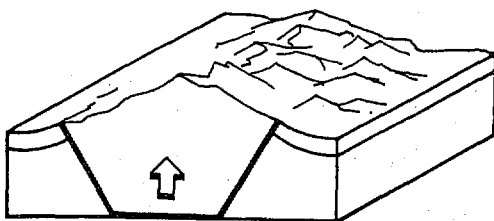

Uplifting (or upwarping) may be caused by convergence

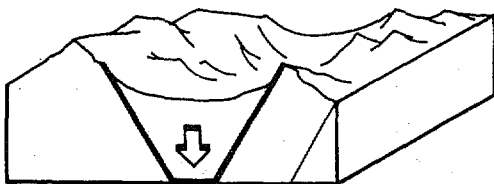

Downdropping may be caused by convergence or divergence

Activity Three: Mountain Modeling

Materials for each student or pair of students

- Dull table knife or scissors
- Rectangular block of plastic foam or furniture foam, at least 2" (10 cm) long and wide and 2" (8-10 cm) thick
- Newspapers to cover desks or work surfaces

Procedure

1. Distribute materials. Tell students that they are going to model another type of mountain building which formed the Sierra Nevadas and the Basin and Range areas of the United States. Give these directions:

a. Cut a wedge-shaped section out of the middle of the block, lift it out, and then replace it in its original position.

b. Hold the sides of the block in two hands and pull them apart slightly, allowing the inner wedge to drop.

What do the tops of the two cut surfaces represent? (faults)

What do the slopes along which the wedge slipped represent? (fault cliffs)

What could cause something like this to happen to the Earth's lithosphere? (There are several possible answers. An earthquake could cause two portions of the lithosphere to separate. Plates could be diverging. Convergence could also cause this kind of movement, however, and is a likely explanation in the case of the Sierra Nevadas and the Basin and Range mountains.)

2. Ask students to put the wedge back in its original position to prepare for another simulation. Direct them to hold the three sections together with their two hands and push on the outside, causing the wedge to move up. Ask:

What could happen in the lithosphere to cause this kind of movement? (compression resulting from the convergence of plates or convergence due to fault movement.)

How could a small movement like this result in mountains thousands of meters high? (Mountains would be formed by a series of earthquakes, or many series over many thousands of years.)

Activity Four: Underwater Avalanche

Materials for the teacher

- Transparency made from Master 26, Ocean Bottom
- Overhead projector

Materials for each small group

- A trough 50 cm to one meter long (This could be a section of PVC rain gutter or a shipping tube cut and lined with plastic. Halves of quart milk cartons would also work.)
- 2 liter container filled with water
- Trough supports (blocks of wood or old books)
- Sandy soil or mixture of sand and dry pottery clay (kaolin) to simulate sediment
- Plastic shoe box or baking pan to hold water and sediment
- Corrugated cardboard strips with the grooves exposed (Tear off the outer layer of paper.)
- Tape

Procedure

1. Project the transparency of the ocean bottom, Master 26, Ocean Bottom. Orient students by pointing out the eastern United States, the Mid-Atlantic Ridge in the Atlantic Ocean, and the abyssal areas in the underwater delta. Inform students that the abyssal areas are one of the largest landscape features of the Earth. Ask the class why they suppose there are such extensive flat areas on the ocean bottoms, and why the underwater deltas exist. Also ask why the deltas and abyssal areas are located where they are. (Accept various answers for now.)
2. Point out the angled underwater landscape of the continental slope and the rough topography near the mid-ocean ridge. Explain that earthquakes under the continental slopes can cause sediment on the ocean bottom to loosen, mix with water, and slide down the slope at speeds up to 100 km an hour. We call this movement a turbidity current.

a • bys • sal plain

An abyssal plain is a plain under the ocean between a continent and a mid-ocean ridge.

tur • bid • i • ty cur • rent

A turbidity current is a downward flow of water and sediments such as mud or sand along the ocean bottom. These swirling currents may be caused by earthquakes.



Extensions

1. Use a stopwatch to calculate the speed of the turbidity currents.
2. Tie string across the trough to represent underwater communication cables, then observe and record what happens to these model cables in a turbidity current.
3. Show some other diagrams or maps of ocean bottoms, and discuss several other features and how their origin is related to earthquakes. (Other ocean features related to earthquakes include ocean trenches, rift valleys, mid-ocean ridges, island arcs, lava flows, and volcanoes of the mid-ocean ridges.)

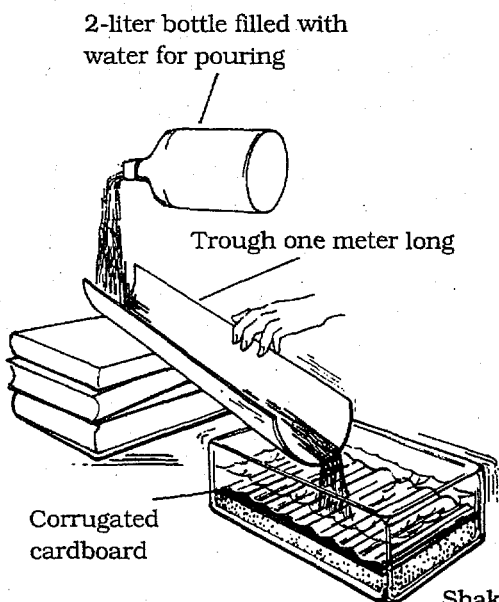

Sediments form over the corrugated ribs of cardboard as sand settles out of the sand and water mixture.

Shake the collection pan to keep sand and water in suspension.

3. Tell the class that they are going to build a model to demonstrate turbidity currents and their effects on the features of the ocean bottom. Give these directions:
 - a. Set up the trough, making sure it can hold water.
 - b. Place one end of the trough so that it overhangs the collecting pan.
 - c. Prop up the high end with books or blocks of wood, so that there is about a 10- to 20-degree slope to the trough, representing the topography of the ocean slope.
 - d. Place some corrugated cardboard in the collecting pan and tape it in place. If necessary, hold the cardboard in place during the next steps. It represents the rough landscape east of the abyssal areas on the ocean bottom. Cover the bottom of the trough with soil or sand and clay.
 - e. Slowly and continuously pour water into the upper end of the trough. While one student is pouring, another will shake the trough.

4. Have students create different kinds of turbidity currents by repeating step e above, possibly pouring at different speeds and shaking with different intensities. Ask:

What does the shaking of the trough represent? (an earthquake)

What has happened to the rough surface (corrugated cardboard) of the ocean bottom? (It has become smoother because sediments have filled it in.)

What has been produced? (An abyssal plain is produced by the deposition of sediment from the turbidity current.)

What has been formed where the trough overhangs the collecting pan? (An underwater delta has been formed. If students don't know what a delta is on land—a more or less fan-shaped land area where sediments are deposited at the mouth of a river—explain and give examples. The Nile Delta, the Mississippi Delta are good ones.)

5. To sum up, project the transparency of the ocean bottom again and reinforce the meaning and origin of abyssal plains and underwater deltas, and how they are produced (at least in part) by turbidity currents generated by earthquakes.

Unit III. Physical Results of Earthquakes

Materials List

Grades K-2

empty milk cartons
colored pencils
markers
crayons
drawing paper
masking tape
overhead projector
scissors
rubber bands

Grades 3-4

scissors
colored pencils
unlined paper
paper clips
light cardboard
glue stick
metric measuring cup/beaker
small plastic tub
sand
newspapers
foam tray
soil
overhead projector
gravel
aluminum foil
metal or glass baking pan
or plastic shoebox
plastic margarine lid
punching tool
string
metric ruler

Grades 5-6

photographs
crayons
colored pencils
construction paper
2-liter soda bottle
foam block
furniture foam
newspapers
permanent markers
PVC rain gutter, shipping
tube, or milk carton
plastic shoe box
blocks of wood
sandy soil, or sand, or clay
(kaolin)
corrugated cardboard
dull table knife or scissors
overhead projector
notebook
tape

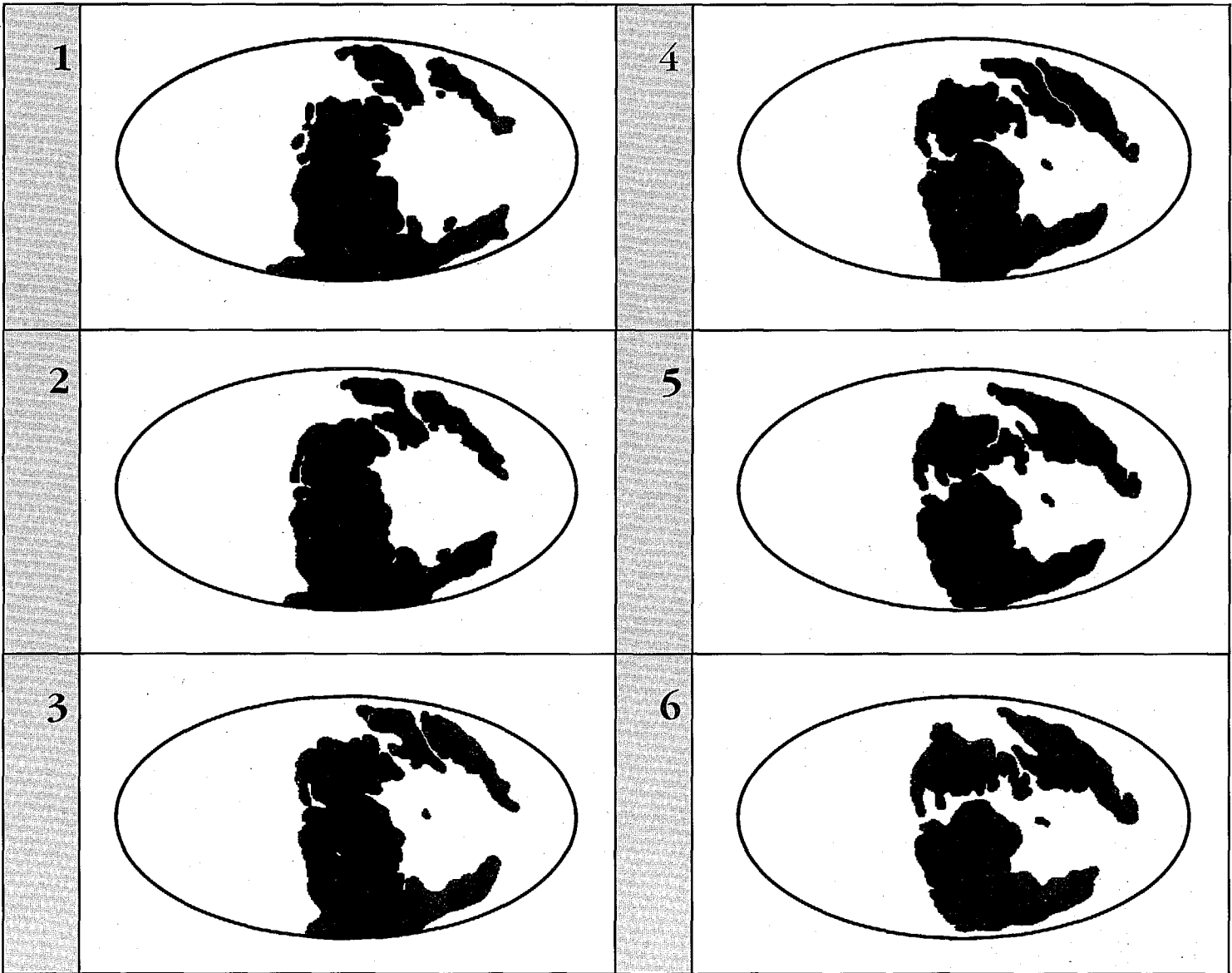



10



11



12



7



8



9



16



17



18



13



14



15

19



22



20



23

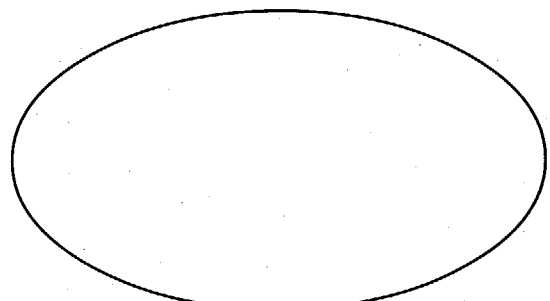

21



24

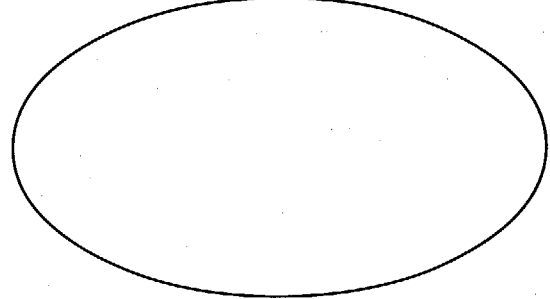

Fault Movements

Horizontal Fault Movement

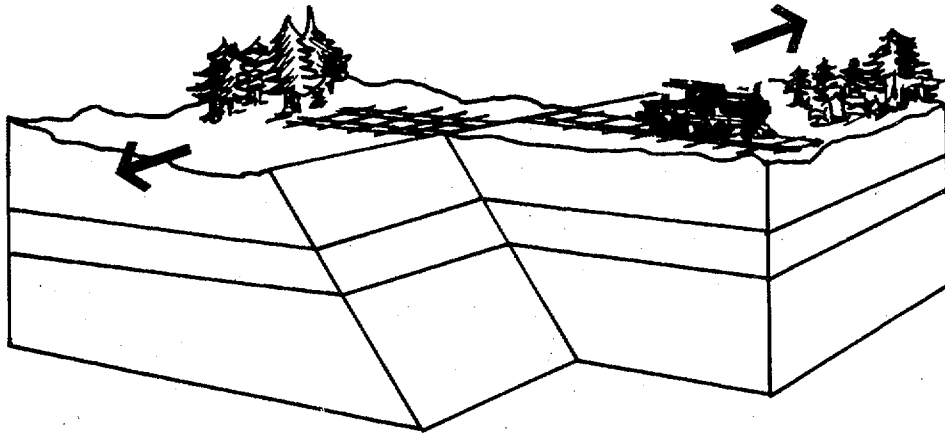

Vertical Fault Movement

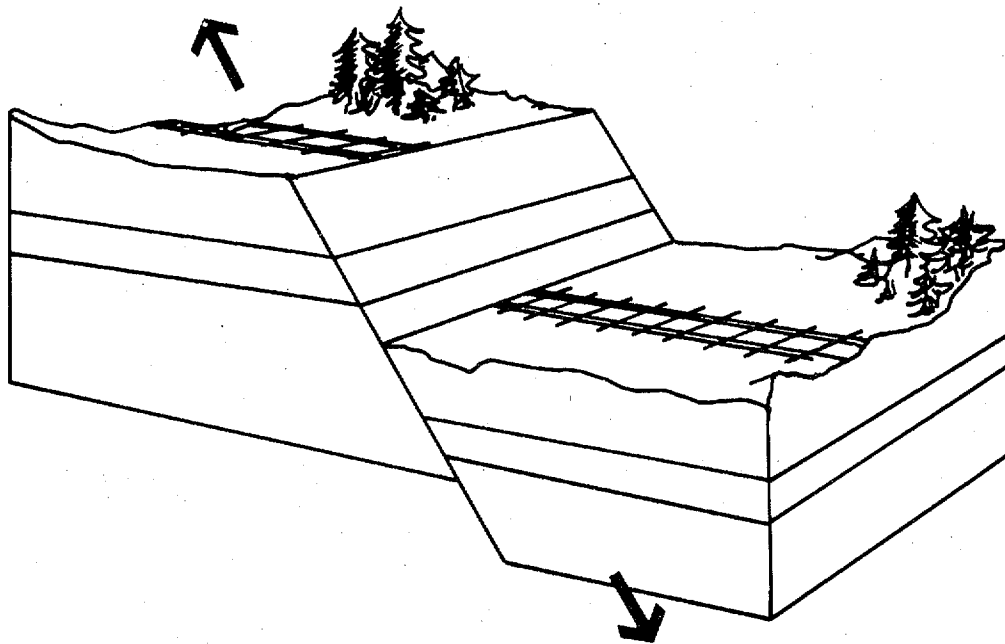

Rural Community After an Earthquake

Name _____

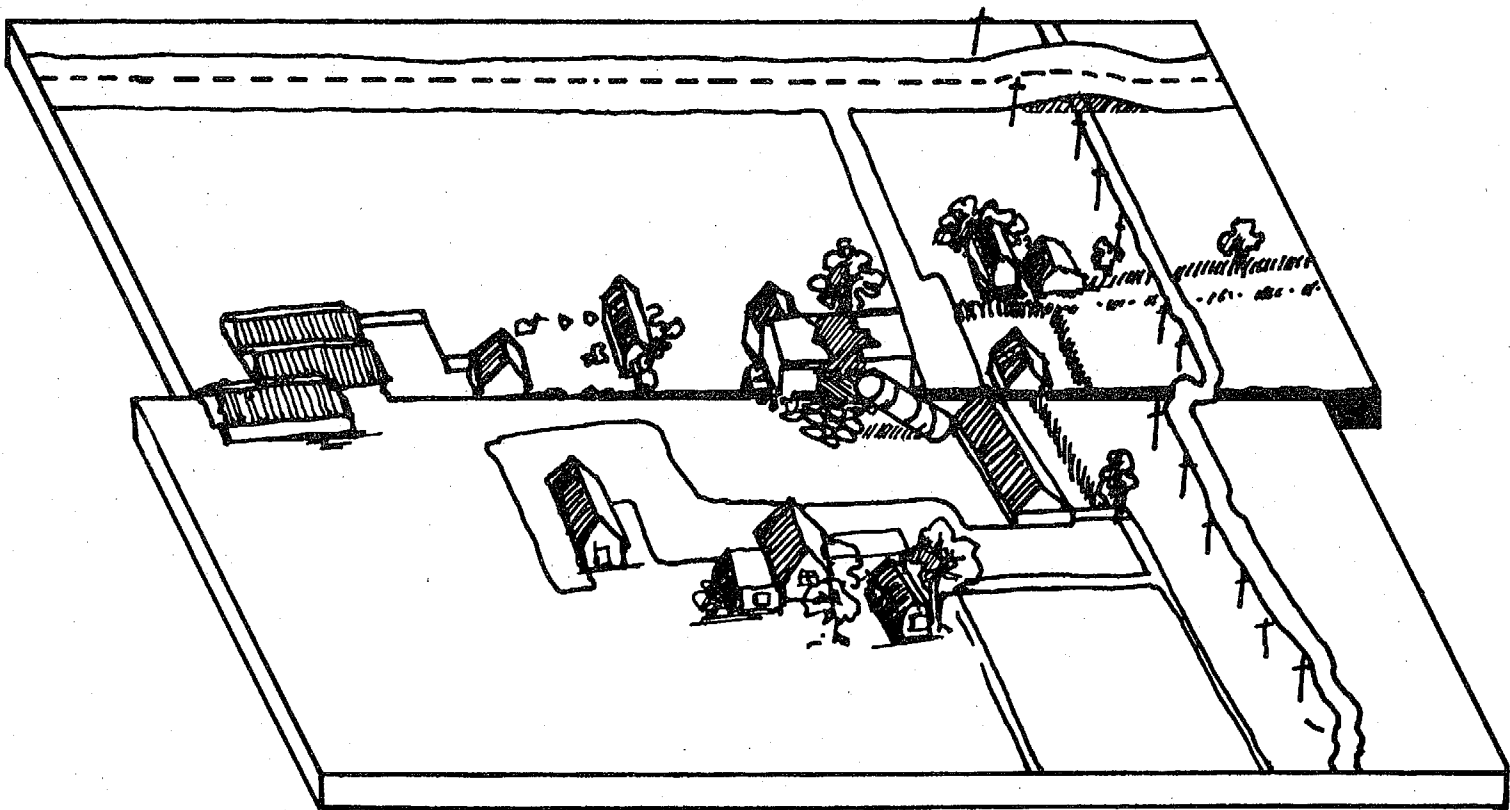

Fault Model

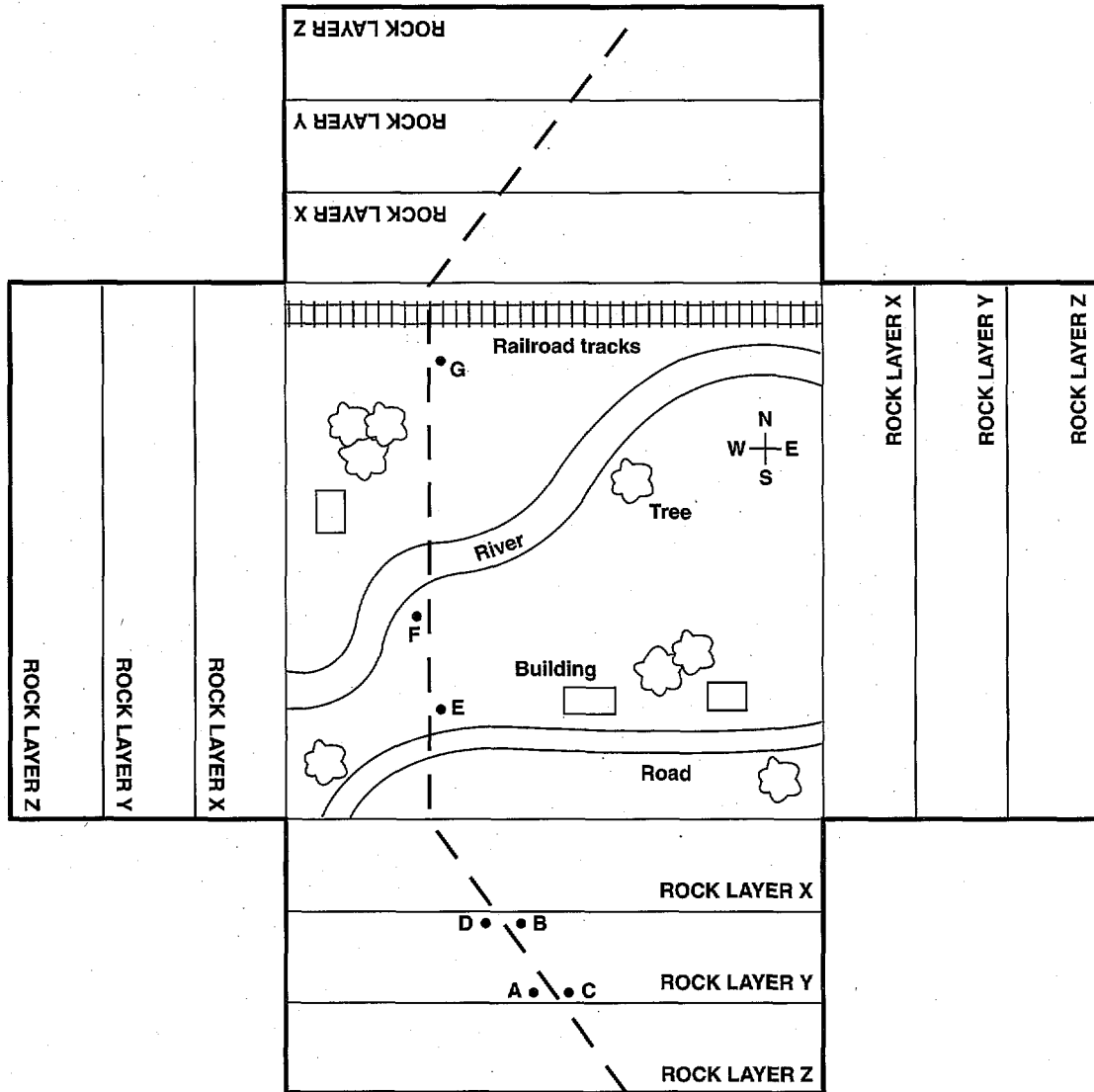

Tsunami Facts

- Tsunami**
- ◆ Japanese word
 - ◆ pronounced: soo • nah • me
 - ◆ means “wave in the harbor”
 - ◆ misnamed as “tidal waves”

- Caused by:**
- ◆ earthquake
 - ◆ other movements on the ocean floor

Travel at speeds up to 600 miles per hour

Tsunami traveling in deep water and open ocean cause no damage and are hardly noticeable.

Tsunami traveling in shallow water can batter coastlines with waves as high as 100 feet, causing considerable damage.

Tsunami Warning Centers

Post warnings when earthquake of tsunami potential occurs.

Notable Tsunami

November 1, 1755. A Lisbon, Portugal earthquake generated tsunamis that hit the west coasts of Spain, Portugal, and Morocco.

August 27, 1883. The volcanic eruption and explosion on the island of Krakatoa (west of Java in the East Indies) generated a tsunami that sent 100-foot (about 30 meters) waves crashing into Java and Sumatra, drowning 36,500 people.

March 2, 1933. An earthquake along a submarine fault in the Japan trench (subduction zone) generated a tsunami that struck the Japanese coast with wave crests as high as 25 meters, killing 3,000 people.

April 1, 1946. An earthquake on the sea bottom near the Aleutian Islands generated a tsunami that struck Hilo, Hawaii, killing 159 people.

May 22, 1960. An earthquake in Chile generated a tsunami, killing 1,000 people in Chile, Hawaii, the Philippines, and Japan.

March 28, 1964. The powerful Alaskan earthquake caused a tsunami that came ashore in many places, including Crescent City, California. It caused a total of 122 deaths and \$104,000,000 in damage, overall. Waves were 52 meters (about 170 feet) high in Valdez, Alaska.

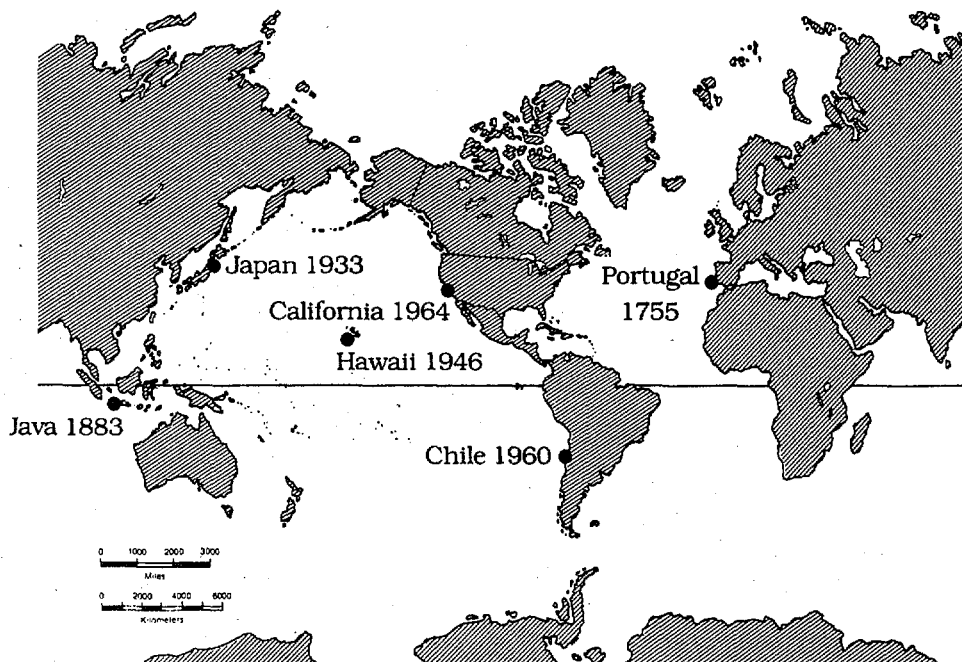

Landscape Regions Worksheet

Name _____

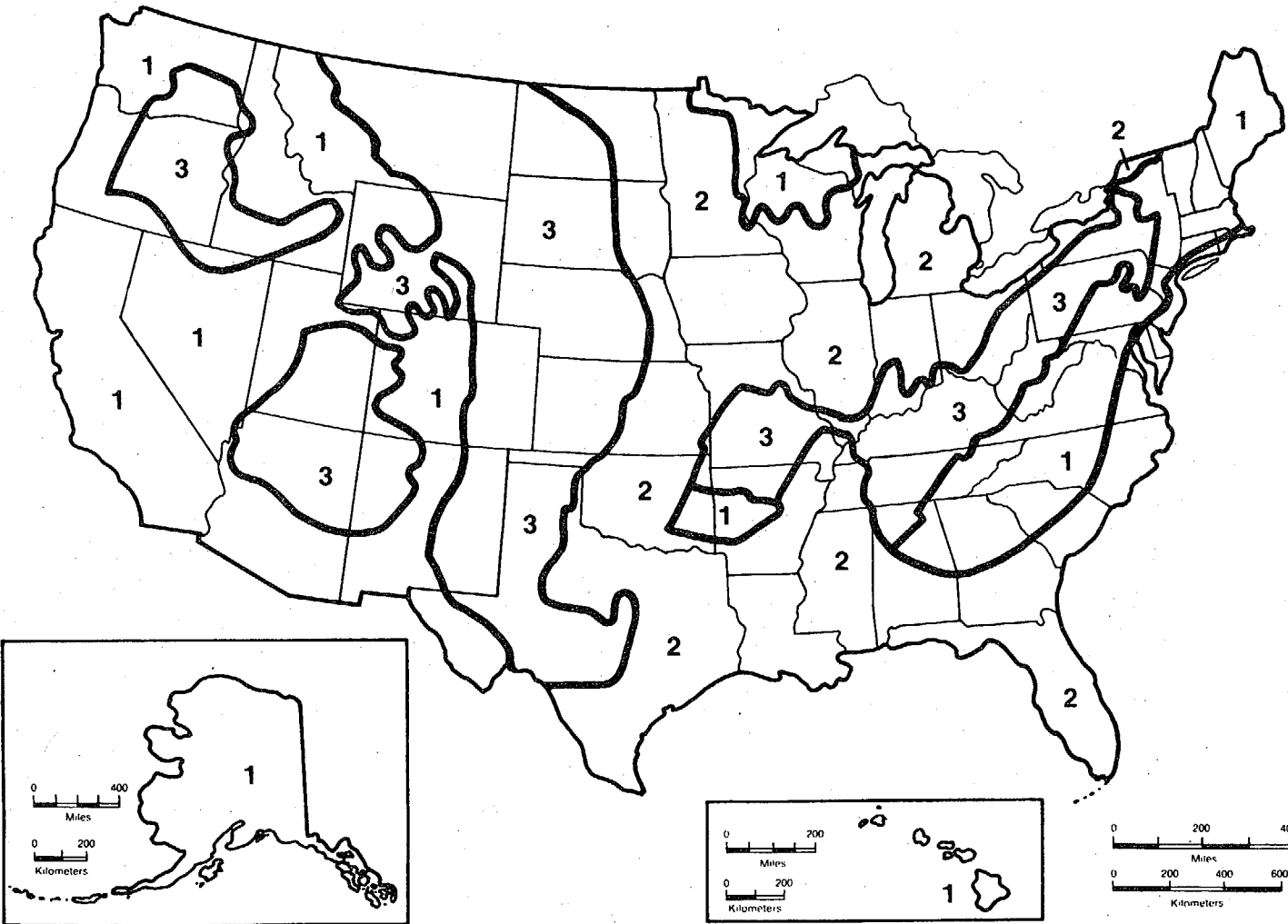

Key: _____ _____ _____

Landscape Regions of U.S.

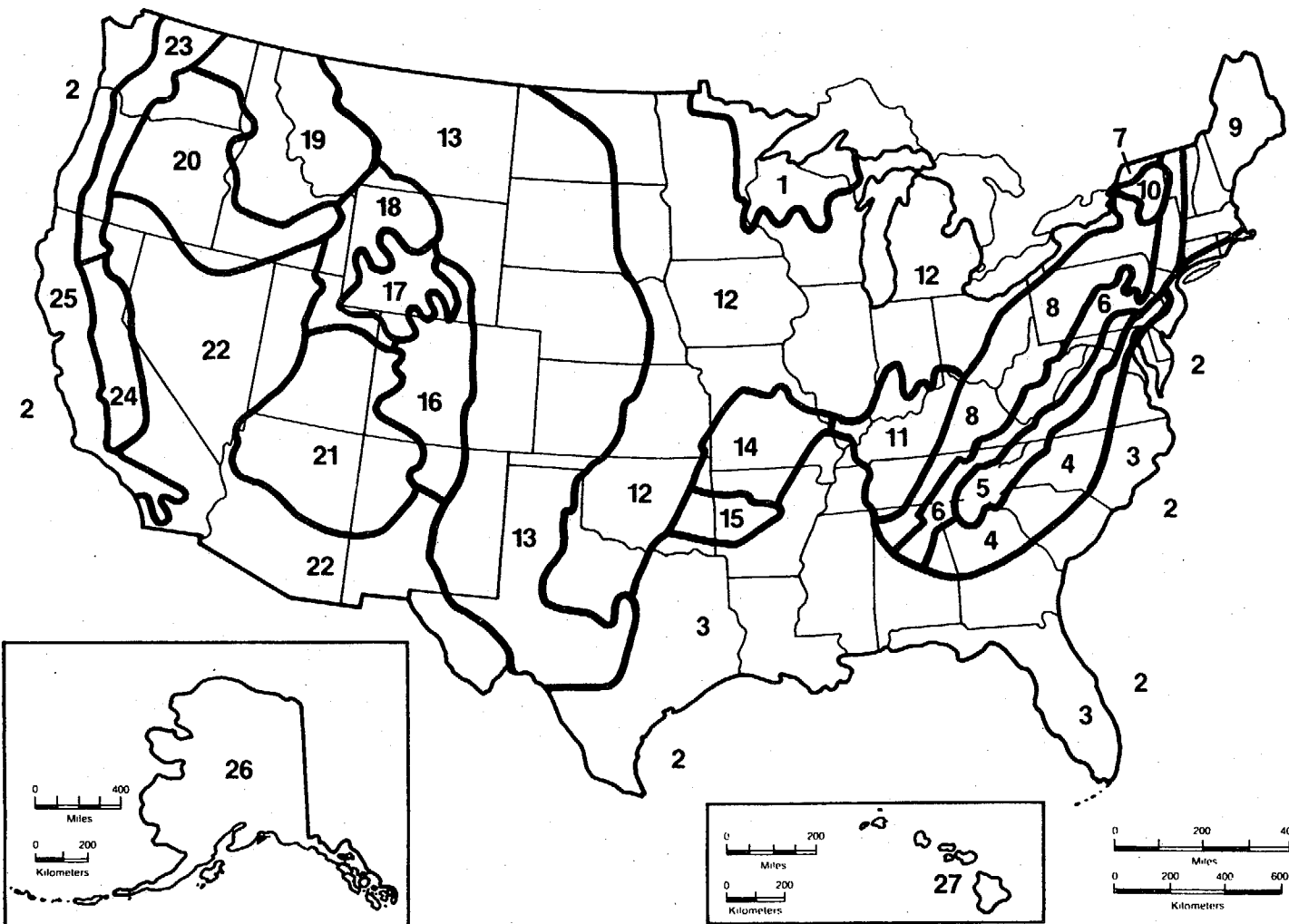

Landscape Regions Key

- 1. Superior Uplands - mountains (1)**
- 2. Continental Shelf - plains (2)**
- 3. Coastal Plain - plain (2)**
- 4. Appalachian Piedmont - mountains (1)**
- 5. Blue Ridge Appalachians - mountains (1)**
- 6. Folded Appalachians - mountains (folded) (1)**
- 7. St. Lawrence Valley - plain (2)**
- 8. Appalachian Plateaus - plateau (3)**
- 9. New England Uplands - mountains (1)**
- 10. Adirondack Mountains - mountains (1)**
- 11. Interior Low Plateaus - plateau (3)**
- 12. Central Lowlands - plateau (3)**
- 13. Great "Plains" - plateau (3)**
- 14. Ozark Plateau - plateau (3)**
- 15. Ouachita Mountains - mountains (folded) (1)**
- 16. Southern Rocky Mountains - mountains (1)**
- 17. Wyoming Basin - plateau (3)**
- 18. Middle Rocky Mountains - mountains (1)**
- 19. Northern Rocky Mountains - mountains (1)**
- 20. Columbia Plateau - plateau (3)**
- 21. Colorado Plateau - plateau (3)**
- 22. Basin and Range - mountains (fault block) (1)**
- 23. Cascade Mountains - mountains (1)**
- 24. Sierra Nevada Mountains - mountains (1)**
- 25. Pacific Coastal Ranges - mountains (1)**
- 26. Alaska (mostly mountains) - mountains (1)**
- 27. Hawaii (composed of volcanos) - mountains (1)**

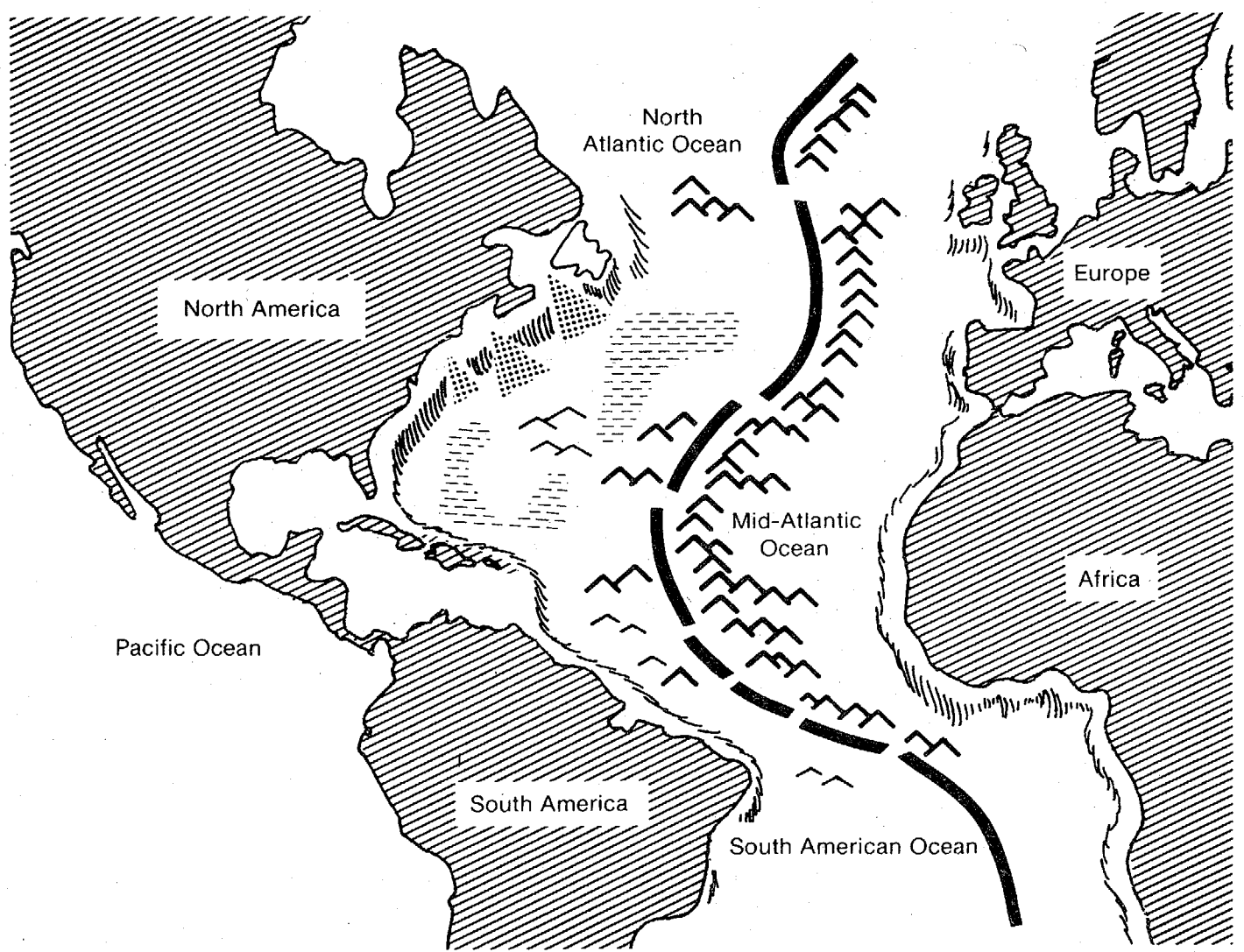

IV

Measuring Earthquakes

Earthquake Curriculum, K-6 -- Scope and Sequence Chart

Unit IV: Measuring Earthquakes

Level	Concept	Laboratory	Mathematics	Language Arts	Social Studies	Art
K-2	<p>Earthquakes have different strengths.</p> <p>Earthquakes cause different amounts of damage.</p>	Simulation of relative strengths of earthquakes.	<p>Ordinal numbers</p> <p>Concepts of most and least</p>	Vocabulary development of earthquake words	Effects of earthquakes on buildings and people	Constructing earthquake simulation model
3-4	<p>Earthquakes differ in the amount of energy they release.</p> <p>Earthquakes may be measured by their effects (intensity) or by the amount of energy they release (magnitude).</p>	Seismograph simulation	<p>Measurement of distances</p> <p>Graph of measurement data</p> <p>Roman numerals</p>	<p>Vocabulary development of earthquake words</p> <p>Written descriptions of Mercalli illustrations</p>	<p>Impact of earthquakes on society</p> <p>Biographical study of earthquake scientists</p>	Illustrations of the Mercalli scale
5-6	<p>Earthquake waves are either surface or body waves.</p> <p>Earthquake body waves are either primary or secondary.</p> <p>Earthquake waves detected by a seismograph are recorded as seismograms.</p>	<p>Slinky™ simulation of earthquake waves.</p> <p>Shoobox and rubber band simulation of earthquake waves.</p> <p>Seismograph simulation.</p> <p>Earthquake wave simulation game.</p>	<p>Ratio of earthquake wave speed</p> <p>Metric measurement of wave amplitude</p> <p>Computation, reducing fractions</p>	Vocabulary development of earthquake words	Impact of earthquakes on society	Model designing

IV

Measuring Earthquakes

Magnitude and intensity are both measures of an earthquake, but they describe different characteristics. Magnitude is a measure of the amplitude of the earthquake waves. Wave amplitude is related to the amount of energy the earthquake releases. Intensity is a measure of the effect that the earthquake had on natural and human-made structures. Each earthquake has a single magnitude and a range of intensities.

Measuring Earthquakes

With few exceptions, earthquakes occur because of the release of energy stored in the rocks of the Earth's lithosphere. In order to understand how this release of energy is measured, however, we must first understand how it occurs.

Stress and Strain

Compressional Stress

When rocks are squeezed we say that they are under *compressional stress*. The rocks will behave elastically. That is, they will absorb the stress by changing their shape, like the soles of good running shoes. This change in shape is called *strain*. But, just like rubber soles, or rubber balls that are squeezed, strained rocks will rebound to their original shapes when the stress is removed. When the rocks rebound we say that their strain energy has been released.

Tensional Stress

Alternatively, if lithospheric rocks are being pulled apart, we can say that they are under *tensional stress*. In this case the rocks will tend to stretch like a stretching rubber band. They will rebound to their original shapes when the tensional stress is removed.

Earthquake!

However, if the stress exceeds what the material can bear, the material will rupture, or break. What happens when you pull too hard on a rubber band?

When rocks are strained too much, they break, and the original pieces rebound to their original shapes. In the Earth's lithosphere this rebounding and release of strain energy is accompanied by rubbing, grinding, and crashing, as the rock masses move past each other. The result is what we call an earthquake.

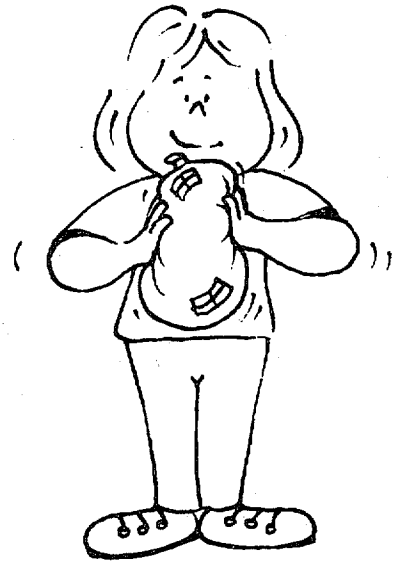

Waves and Vibrations

Regardless of the depth of the earthquake focus, vibrations from the release of strain energy travel in all directions. The earthquake vibrations are transmitted through the surrounding lithosphere, and even through the Earth's mantle and core, by a variety of wave-like motions. Earthquake waves are of two kinds, body waves and surface waves.

Body Waves

Body waves that travel through the Earth are either P- (for Primary) waves or S- (for Secondary) waves. P-waves travel faster than S-waves. The two types together are called body waves because they travel through the body of the Earth. Body waves are important because they allow us to locate the epicenters of earthquakes. They also enable us to study the structure and composition of the Earth's interior.

Surface Waves

Earthquake waves that travel at or near the surface of the Earth are called surface waves. The two main varieties are Love waves, which move sidewise, and Rayleigh waves, which have an up-and-down (rotary) motion. Surface waves spread for thousands or tens of thousands of square kilometers around an earthquake's epicenter. They are primarily responsible for the shaking of the ground and damage to buildings that occur in large earthquakes.

Two Ways of Measuring Earthquakes

The Mercalli Scale: A Measure of Intensity

Earthquake intensity is a measure of the effects of an earthquake at a particular place. Intensity is determined from observations of an earthquake's effects on people, structures, and the Earth's surface. A ten-value intensity scale which had been in use in Europe since 1883 was refined in 1902 by an Italian seismologist, Giuseppe Mercalli. The Mercalli scale we use today is a modification of Mercalli's 12-value scale developed by two Americans, H.O. Wood and Frank Neumann, in 1931. The scale uses Roman numerals from I to XII to rank relative levels of destruction, ground motion, and human impact.

The intensity (or impact) of an earthquake in a given area will depend on the type of geological structures in the area as well as the type of buildings. Houses built on rock, for example, will receive less damage than houses built on sediments at the same distance from a quake's epicenter. Poorly built houses will receive more damage than those that have been reinforced to withstand earthquakes. In general, though, the further a site is from the earthquake's focus, the lower the amount of damage it will sustain.

Far-Ranging Effects

Even though the main shock lasts for such a short time the effects of a major earthquake may reach a long way in both space and time. People hundreds of miles away from the epicenter may experience shaking or damage. This is especially true in the eastern United States, where quakes are felt over a much larger area than they are in the West.

An isoseismal map shows zones or bands where earthquake effects of the same intensity have been reported. For example, the U.S. map on the next page shows the areas that reported Modified Mercalli intensities of VI or greater for two major earthquakes. All of the areas between the isoseismal line labeled VI and the line labeled VII could experience effects of Mercalli intensity VI. The effects would be less strong in the area outside the line labeled V.

The San Francisco earthquake of April 18, 1906, and the New Madrid earthquake of December 16, 1811, had roughly the same magnitude on the Richter scale. However, the area which registered VII or above on the Mercalli scale was twenty times larger for the New Madrid quake than for the one in San Francisco.

The main shocks in the New Madrid area were followed by fifteen strong aftershocks. All were felt strongly enough to waken sleepers in Washington D.C. In the three months following the main shock, nearly 2,000 aftershocks were reported at Louisville, Kentucky, 320 km (or 200 miles) from the New Madrid fault zone.

The Charleston earthquake of August 31, 1886, had a Richter magnitude of 7 and a Mercalli intensity of X at the epicenter. Events of Mercalli intensity II to III were reported as far north as upper New York state and western New England and as far south as the tip of Florida.

The Magnitude Scale: A Measure of Size

A method of rating the size of earthquakes is by using scientific instruments to measure the amplitude of body waves and surface waves recorded on seismograms. The amplitude is the height of the wave tracing above the center line on the seismogram.

Isoseismal map of three U.S. earthquakes. Areas with lines show Modified Mercalli intensity.

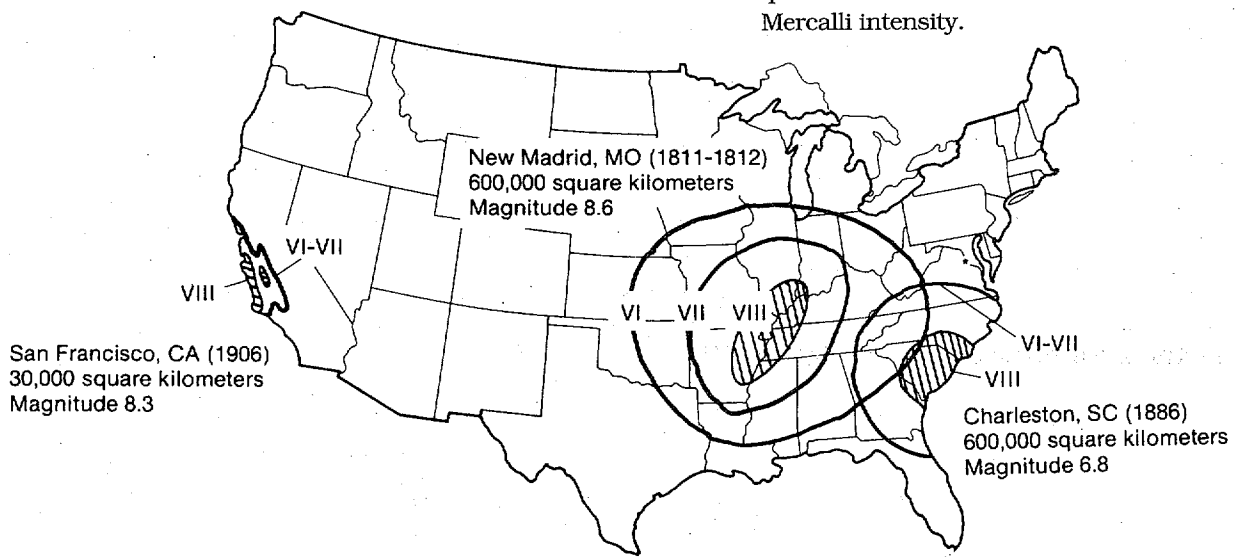

The instrument's reading indicates the amount of strain energy released by an earthquake. This measure is called the earthquake's magnitude. The greater the wave amplitude, the greater the magnitude.

A magnitude scale was devised by the American seismologist Charles Richter in 1935. It uses Arabic numerals. Richter's scale is logarithmic and open-ended; that is, there is no upper or lower limit to Richter magnitudes. Each whole-number increase in the magnitude of an earthquake represents about a thirty-fold increase in the amount of energy released.

The original Richter magnitude scale was devised to measure earthquakes in southern California. Later, over the years other types of seismographs have been developed. Precision in locating distant earthquakes and accuracy in determining their magnitudes have improved as the number and sophistication of seismograph designs have increased. Today computers are being used to analyze seismographic data—something your students may want to research on their own.

However, Richter and his colleague Beno Gutenberg devised a scale to measure distant earthquakes. This scale is based on the amplitudes of surface waves. Body waves from distant earthquakes can also be used to determine magnitude.

The Seismograph

The instrument used to record earthquakes is called a seismograph. The first seismographs were designed by British scientists working in Japan between 1880 and 1890. The most famous of these early seismographs was a horizontal pendulum model built by John Milne.

Pendulum seismographs rely on a simple principle of physics, the principle of inertia. A heavy weight that is allowed to move freely will tend to remain in its original position when the ground beneath it begins to move in response to earthquake waves.

Mechanical or electrical devices can be used to sense the motion of the ground relative to the heavy pendulum of the seismograph. Up-and-down or sideways ground motion sends a mechanical or electrical signal to a pen attached to a paper-covered drum. As the drum turns, the pen wiggles, producing an amplified recording of the ground motion. This recording is called a seismogram. Scientists use the amplitudes of earthquake waves recorded as seismograms to determine the magnitude ratings of earthquakes.

Table: Earthquake World Records

Location	Date	Magnitude
Ecuador	January 31, 1906	8.9
Assam, India	June 12, 1897	8.7
Alaska	March 28, 1964	8.6
Alaska	September 10, 1899	8.6
Southern Chile	May 21-30, 1960	8.5
San Francisco	April 18, 1906	8.2
Kwanto, Japan	September 1, 1923	8.2
Erzincan, Turkey	December 27, 1939	8.0
Indonesia	August 19, 1977	8.0
Mexico	September 19, 1985	7.9
Bolivia	June 9, 1994	8.2

From Master 29, Seismographs

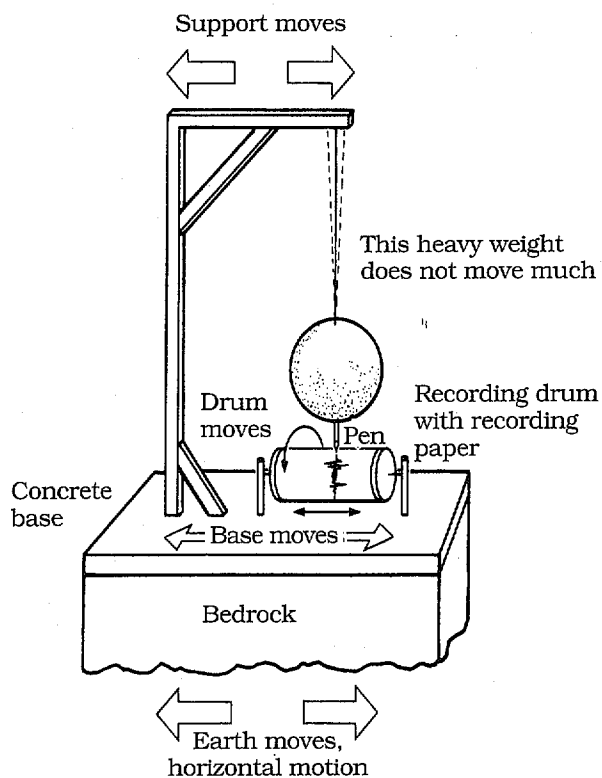

Earthquakes Great and Small

Vocabulary

energy

Learning Links

Language Arts: Discussion/oral communication, vocabulary building, reading (optional)

Social Studies: Discussing effects of earthquake damage on people and their property

Math: Using ordinal numbers

Art: Constructing earthquake simulation model

Content Concepts

1. Earthquakes have different strengths.
2. Earthquakes cause different amounts of damage.

Objectives

Students will

- demonstrate two types of energy.
- demonstrate that earthquakes have different levels of strength.
- construct a model to simulate earthquakes and earthquake damage.
- compare the movement in the earthquake model to ground movement during a quake.
- compare different levels of earthquake strength in terms of their effects on structures.

Assessment

Students will experiment with building shapes and methods of construction. Ask students to describe the effects of gentle and strong shaking on their buildings.

Activity One: Weak and Strong

Procedure

1. Conduct a class discussion on the concept of energy. Establish that energy has many forms (such as mechanical energy, heat, sound, and light) and many different strengths.
2. Have students demonstrate two familiar types of energy.
 - a. Ask them to clap their hands loudly and describe the sound; then to clap them softly and describe the sound.

Do you hear a difference? (Yes)

Why is there a difference? (Soft clapping releases a smaller amount of sound energy than loud clapping does.)
 - b. Ask them to rub their hands together slowly and describe how they feel, then rub them together quickly and describe how they feel.

How does the amount of energy change? As the amount of energy increases, what do you notice?

Why do you feel a difference? (Quick rubbing releases a greater amount of heat energy than slow rubbing does.)

Activity Two: Shakes Makes Quakes

Materials for the teacher

- A small table or desk that moves easily. See also Teacher Note and Master 27, Shake Table

Materials for each pair of students

- A shallow box partially filled with sand or soil
- Paper
- An assortment of objects for building structures:

small blocks	Legos™	penne pasta
sugar cubes	Lincoln Logs™	Play-Doh™ or flubber

Teacher Take Note: Before beginning this activity, you may want to have small groups or pairs of students construct their own shake table (Master 27).

Procedure

1. Hand out paper and materials to each pair of students.
2. On one side of the paper, have students design plans for building a few structures of different heights that would withstand an earthquake. Students should include sentences that describe what they intend to build with and why they think it would withstand an earthquake.

3. With their partner and with the materials provided, have students construct the structures they just drew and wrote about above.

4. When their structures are completed, have partners take turns testing their structures on the shake table, or desk, shaking it gently the first time. (Nothing should happen to the structures.)

5. Shake it three more times, increasing the amount of force each time so that eventually the structures will gradually disassemble.

a. Each time the table shakes, have partners discuss the observations they are making.

b. On the other side of their paper, have students draw the results of the table shaking on their structures. Include with their drawing some reflective writing as to:

What caused the buildings to fall down? (the shaking of the table)

What caused the table to shake? (the students)

What did the students give to the table? (energy)

What happened to the buildings? -- the first time? -- second time? -- third time? (They eventually broke apart.)

Are earthquakes always the same? (No. Some are weak and some are strong.)

Does it make any difference what building materials are used? (Yes. Have students look at other people's designs and models. Compare buildings made of stacking blocks with buildings made of materials that are connected to each other.)

What are some of the strongest shapes and materials used?

How did those factors affect the structures?

Summary: Different earthquakes have different amounts of energy, and cause different amounts of damage.

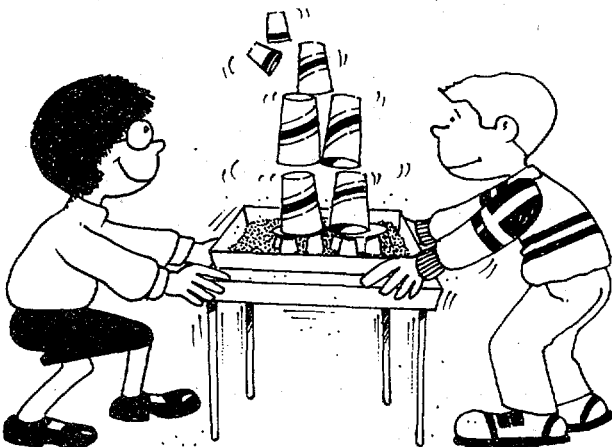

Activity Three: Shake a Minute

Materials for the teacher

- Large clock with second hand
- Blackboard and chalk

Materials for each student

- Pencils
- Paper

Procedure

1. Ask students to estimate on a piece of paper how long they think an earthquake lasts. (How long will the ground shake?)
2. Collect the estimates and list them on the board.
3. Explain to students that in most earthquakes, shaking rarely lasts for as long as a minute in any one area. Strong shaking from a major quake usually lasts for 30 to 60 seconds. The 1906 San Francisco earthquake lasted about 40 seconds. In the 1964 Alaskan earthquake, the shaking lasted 3 to 4 minutes--an extremely long time. This does not happen very often.
4. Tell students that they are going to estimate how long a one-minute earthquake is without looking at a clock. Have them break up into pairs. One of each pair will be the timekeeper and recorder, while the other is the "earthquake."
5. When you give the signal, the earthquakes are to begin shaking, and the timers are to begin timing. Ask the quakes (whose backs are to the chalkboard) to continue shaking until they think that a minute has passed.

6. Once the timing and shaking start, write the time elapsed on the board every five seconds. The timers, who can see the board, should record the last time listed when their partners stop shaking. Instruct the timers not to share the time with the earthquake students yet.

7. Ask the timers to report the actual times that each "quake" lasted. Write all the times on the board. Have the class compare the times:

How long was the shortest "earthquake"?

How long was the longest?

What was the average time for this group?

8. Have partners switch roles and repeat steps 5 and 6, then step 7. Ask the class:

Did the second group come closer to one minute than the first?

If the answer is yes, why? (Perhaps because the second pair of students had the advantage of observing the first pair.)

9. Now have everyone in the class shake for one minute at the same time. Tell them when to start and stop, but ask them not to watch the clock. Then ask:

Did the time you shook seem like more or less than a minute? (Explain that even though an earthquake is over in a short time, it usually seems much longer to those people experiencing it.)

What might happen to objects in this classroom if the ground shook strongly for a minute? (Answers will vary.) Explain that we will learn more about this in our next activity.



Different Shakes for Different Quakes

Vocabulary

energy
 earthquake wave
 amplitude
 earthquake intensity
 earthquake magnitude
 modified Mercalli scale
 seismograph
 seismogram

Learning Links

Language Arts: Reading sentences, sequencing ideas, discussing, building vocabulary, constructing paragraphs

Social Studies: Discussing the human impact of earthquakes

Math: Using Roman numerals, interpreting data

Art: Making illustrations

Content Concepts

1. Earthquakes differ in the amount of energy they release.
2. Earthquakes may be measured by their effects (intensity) or by the amount of energy they release (magnitude).

Objectives

Students will

- construct drawings to illustrate the Mercalli scale as a measure of earthquake effects on people, structures, and the Earth's surface.
- identify the magnitude scale as a measure of energy released by earthquakes.
- construct and use a seismograph to demonstrate the measurement of earthquakes.
- chart the number of earthquakes that occur each year in different damage categories, mild to severe.

Assessment

Display a seismogram and explain what it represents and how it can be used to identify earthquake magnitude.

Activity One: Measuring with Mercalli

Materials for the teacher

- Master 28, Modified Mercalli Scale
- Large Roman numerals I through XII

For each student or group

- A copy of the Mercalli scale made from Master 28, Modified Mercalli Scale
- A large sheet of drawing paper
- Art supplies-colored pencils, crayons, felt markers
- Scissors
- Tape

Procedure

1. Introduce the Mercalli scale by explaining its purpose: to measure the intensity of the damage an earthquake causes. You might want to add other information from the unit introduction. Explain that the use of Roman numerals distinguishes Mercalli measurements from those on another scale (The magnitude scale will be introduced in Activity Two.)
2. Teach or review Roman numerals.
3. Distribute copies of the Mercalli scale and have students take turns reading the descriptions aloud.
4. Divide students into groups and ask them to draw scenes illustrating the Mercalli numbers. Provide art supplies. Intensity I may only require one drawing, but the higher numbers may require more.
5. Distribute large Roman numerals I through XII around the classroom wall in order from lowest to highest. As students bring up their illustrations, the class will try to assign each to its correct numeral. Students may hang their pictures on the wall under the correct numeral.
6. Either before or after a class discussion about the social impact of each step on the scale, have students write paragraphs describing their illustrations and add them to the wall display.

Shortened Mercalli Scale

- I. Only instruments detect it.
- II. People lying down might feel it.
- III. People on upper floors of buildings will feel it, but may not know it is an earthquake.
- IV. People indoors will probably feel it, but those outside may not.
- V. Nearly everyone feels it and wakes up if they are sleeping.
- VI. Everyone feels the quake. It's hard to walk.
- VII. It's hard to stand.
- VIII. People will not be able to drive cars. Poorly built buildings may collapse; chimneys may fall.
- IX. Most foundations are damaged. The ground cracks.
- X. Most buildings are destroyed. Water is thrown out of rivers and lakes.
- XI. Rails are bent. Bridges and underground pipelines are put out of service.
- XII. Most things are leveled. Large objects may be thrown into the air.

earth • quake in • ten • si • ty

Earthquake intensity is a measure of ground shaking based on damage to structures and changes felt and observed by humans. It is expressed in Roman numerals on the Mercalli scale.

earth • quake mag • ni • tude

Earthquake magnitude is a measure of the amount of energy released by an earthquake. It is expressed in Arabic numerals on the magnitude scale.

seis • mo • graph

A seismograph is an instrument for recording the motion of earthquake waves.

seis • mo • gram

A seismogram is a recording of the wavy lines produced by a seismograph.

Activity Two: Movin' with Magnitude

Materials for the teacher

- Transparencies made from Master 29, Several Seismographs; Master 30, Seismogram Worksheet; Master 31, Earthquake Magnitudes; and Master 32, Seismogram Showing Amplitude
- Overhead projector

Materials for each small group

- Free-flowing overhead marker with fine tip for marking transparency
- Blank transparency sheet
- A light weight table or desk

Materials for each student

- Worksheet of seismogram tracings made from Master 30

Procedure

1. Place a blank overhead transparency on a light weight table or desk.
2. Have students take turns as holders and shakers. The first student holds the marker lightly with thumb, index, and middle fingers so it just touches the surface of the transparency sheet. As he or she holds the marker suspended, the other student shakes the movable object back and forth, varying the intensity of the shaking as much as possible. The markings that result will be similar to a seismogram. Show students the transparency of several types of seismographs (Master 29) and then Master 32, Seismogram Showing Amplitude.
3. Discuss the concepts of magnitude and amplitude. (Refer to the teacher background if necessary.) Explain that the amplitude of the earthquake waves (their height measured from a fixed reference line) reflects the amount of Earth movement, and therefore the magnitude of the earthquake. Magnitude is expressed as an Arabic number. Project the transparency of Master 31, Earthquake Magnitudes, and discuss.
4. Distribute the worksheets made from Master 30, and ask students to rank the seismograms from A to D, least amplitude to greatest.

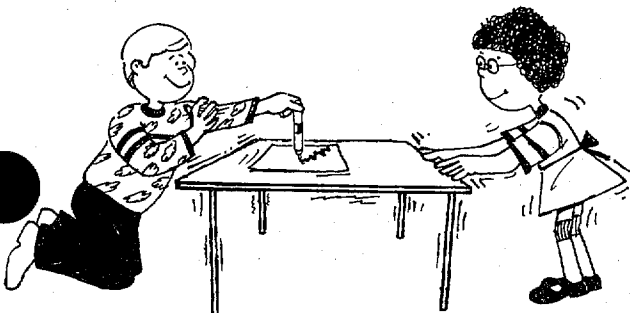

Activity Three: Little Shakes and Big Quakes

Materials for the teacher

- Overhead projector
- Transparency made from Master 33, Earthquake Severity Worksheet

Materials for each student

- Worksheet of Master 33, Earthquake Severity Worksheet
- Pencils

Procedure

1. Tell students that seismographs record over 3 million earthquakes every year. They are going to estimate how many of those cause serious damage.
2. Distribute worksheets. Have students place the numbers from the answer section at the bottom of the sheet where they think they belong in the right hand column, Estimated Number per Year.
3. Project the transparency and invite students to compare their answers with the actual figures. Discuss their reactions. Ask them to write in the correct figures on their own sheets.
4. Have students add the four lower numbers to see how many earthquakes cause slight to serious damage every year (about 15,141).

Extension

Read Steven Kellogg's "How much Is A Million?" to the class. Measure a ream of paper (500 sheets). Have students figure out how many reams it would take to get a million sheets. How tall would the stack be? If you were to type asterisks on a page, and it takes 500 asterisks to cover a page of paper, how many pages would it take to get to a million?

Master 33: Earthquake Severity Worksheet

Magnitudes	Earthquake Effects	Estimated Number Per Year Worldwide
1.0-3.0	Generally not felt but recorded.	3,000,000
3.1-4.0	Often felt, but only minor damage.	50,000
4.1-6.0	Slight damage to buildings.	15,000
6.1-6.9	Can be destructive in where people live.	120
7.0-7.9	Major earthquake. Causes serious damage.	20
8.0 or greater	Great earthquake. Total destruction to nearby communities.	1

Sizing Up Earthquake Waves

Vocabulary

earthquake wave

wave amplitude

earthquake intensity

earthquake magnitude

seismograph

seismogram

focus

epicenter

body waves

P- (primary) waves

S- (secondary) waves

expansion

compression

Learning Links

Language Arts: Discussing, following directions, taking notes

Social Studies: Discussing effects of earthquakes on people and structures; comparing effects to Mercalli intensity

Math: Metric measurement, computation, reducing fractions, computing ratios

Art: Creating models

Content Concepts

1. Earthquake body waves are either primary or secondary.
2. Earthquake waves detected by a seismograph are recorded as seismograms.
3. Scientists can use isoseismals to compare the effects of different earthquakes.

Objectives

Students will

- distinguish between primary and secondary body waves (P-waves and S-waves).
- construct a model to simulate S-wave motion.
- construct a model seismograph, and identify its parts.
- identify different amplitudes of simulated earthquake waves by using the seismograph.
- draw isoseismals on a map which includes Mercalli intensity data.
- compare and contrast P and S wave motions using their body movements

Assessment

Use knowledge about seismic waves to relate this transfer of energy to the amount of damage following an earthquake.

Activity One: Popping P-Waves

Materials for the teacher

- Transparencies made from Master 34, P-Waves Motion and S-Wave Motion, and Master 10a, Earthquake Terms
- Overhead projector

Materials for the students

- Slinky™ toys (One for every two students is ideal.)
- Sign post labeled **Focus** (Teacher or student volunteers can make it ahead of time.)
- Safety goggles

Procedure

1. Elicit from class the definition of an earthquake. Review or explain that the energy of an earthquake is released in the form of waves. (Use Master 10a, Earthquake Terms.) Point out that all the energy moves out from the focus.
2. Divide students into pairs or groups of even numbers, depending on the number of Slinkies available. Distribute Slinkies.
3. Two students will hold each Slinky, one on either end. Instruct them to stretch it to a length between 6 and 9 feet (2 and 3 meters) on the floor or a wide work surface.
4. Ask one of each pair to compress between ten and twenty coils and then release them rapidly. Both students continue to hold the Slinky during compression and release.
5. Ask students to describe what they see, and let this lead into your explanation of body waves, P-waves, and S-waves (see unit overview). Be sure to point out that the Slinky's motion simulates the expansion and compression of P-waves.
6. Place the sign post labeled **Focus** in an open area of the classroom. Have all the students compress and release their Slinkies in this one area at the same moment. This demonstration will help students to realize that earthquake waves radiate in all directions from the focus.

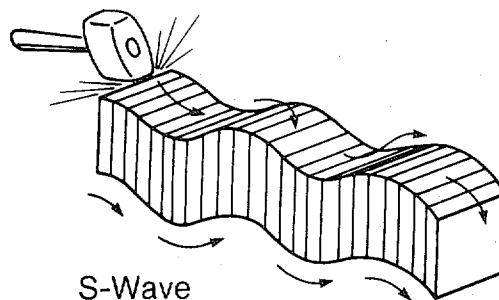
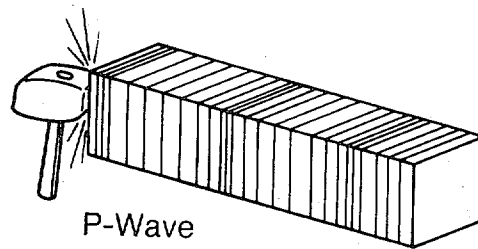

Teacher Take Note: Metal Slinkies will be more effective than plastic ones for this activity. Mark one spot on each coil with bright permanent marker or a bit of white tape, to make it easy for students to see the wave motion. Also note that P-waves vibrate in the direction in which they travel. Use the transparency of Master 34, P-Wave Motion and S-Wave Motion.

Children demonstrating compression and expansion of P-waves

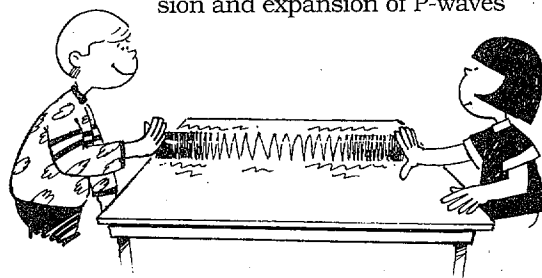

fo • cus

The focus, or hypocenter is the place inside the lithosphere where an earthquake's energy is first released.

sur • face waves

Surface waves are earthquake waves that travel only on the surface of the Earth.

bo • dy waves

Body waves are earthquake waves that travel through the body of the Earth. They are of two types, P-waves and S-waves.

P-waves

P- (or Primary) waves are the fastest body waves, which travel by compression and expansion.

S-waves

S- (or Secondary) waves are body waves which travel more slowly than P-waves, and create elastic vibrations in solid substances.

Activity Two: The S-Wave Machine

Materials for the teacher

- Handout or transparency made from Master 35, The S-Wave Machine
- Transparency made from Master 34, P-Wave Motion and S-wave Motion
- Overhead projector

Materials for each group

- 1 shoe box without its top, or a 1- or 2-qt. paper milk carton, cut as shown
- Compass point or other punching tool
- A rubber band long enough to stretch the length of the box or carton
- Scissors
- 2 metal washers 2 cm or larger
- 5 to 7 metal paper clips

Procedure

1. Gather students in pairs or small groups and distribute materials. Inform students that they are going to build and operate a device to illustrate the type of body waves called S-waves. Project Master 35 or hand out copies.

2. Instruct students to assemble their machines, referring to the projected illustration or the handout.

a. Stand box on end and punch a small hole in the top and bottom, near the center.

b. Cut open a rubber band and thread it through the top hole, tying the end to a washer to keep it from pulling through.

c. While another student holds the band stretched, thread the free end through the bottom hole and fasten it with the second washer. (The rubber band should be taut enough to twang when it is plucked.)

d. Attach 5 to 7 paper clips evenly along the length of the band so they are centered horizontally and they all face in the same direction. Allow the band and clips to come to rest.

e. Pluck the band and observe the motion of the clips.

3. Ask students to describe what they see. (They'll see paper clips swinging in all directions, at right angles to the movement of the wave up and down the rubber band.)

4. Project the wave transparency, Master 34, and explain the motion of S-waves through the Earth in terms of the demonstration. Point out that S-waves cause vibrations perpendicular to the direction of their movement. Compare this movement with the movement of P-waves.

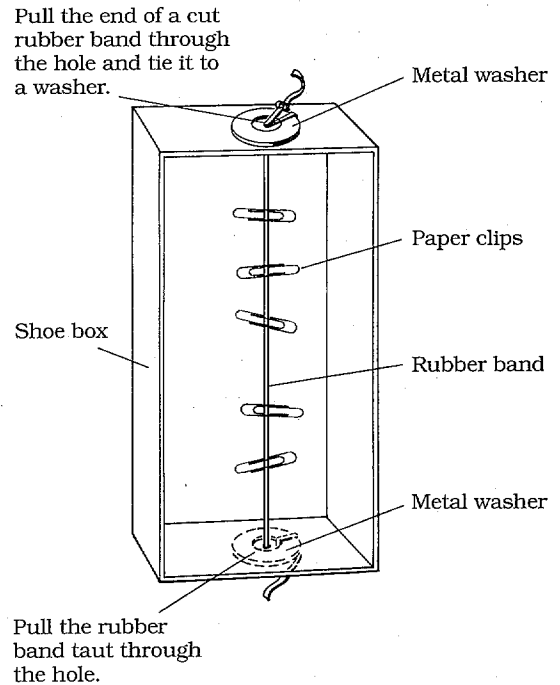

Master 35. The S-Wave Machine

Teacher Take Note: To increase visibility of wave action try these ideas: Use dark paper in the back of the box. Illuminate the box by shining a light into it (an overhead projector light works great). As a teacher demonstration, cut out the back of a box, lay the S-wave machine on the lighted overhead surface. Project the enlarged silhouette on the screen.

Activity Three: Drum Rumbles

Materials for the teacher

- A drum (any type that's portable—a coffee can will do)
- 2 posters, one labeled S-wave and one labeled P-wave
- A watch that indicates seconds (Most digitals would work.)

Materials for each student

- A pencil and a notebook



Procedure

1. Line students up single file in a long corridor indoors, or outdoors along a wall or fence.
2. Choose three volunteers: two to hold the S-Wave and P-Wave posters at a starting point (call it the focus) and one to beat the drum.
3. Students assemble in two parallel lines: S-waves on one side and P-waves on the other. The drummer will begin a steady beat of one tap per second. The P-wave line and S-wave line start walking: P-wave students take one step per second and the S-wave students take one step every two seconds for 20 seconds and stop.
4. Ask students to compare where lines ended. (P-waves travel approximately twice as far in the same amount of time. This 1:2 ratio approximates the 3:5.5 ratio of the actual P- and S-waves' traveling times.)

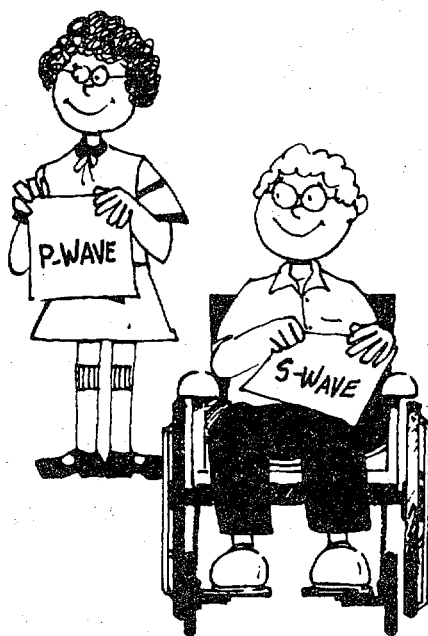

Activity Four: Set Up a Seismograph

Materials for the teacher

- Transparencies made from Master 29, Several Seismographs; and Master 32, Seismogram Showing Amplitude
- Overhead projector

Materials for each small group of students

- Three blank sheets of paper
- Thick-point felt marker
- Quart to gallon size container with handle
- Approximately 16 oz. of sand or water
- Strong string, 1 to 3 feet (depends on student height)
- Table or desk
- Tape
- Scissors
- Timing device

Procedure

1. Inform students that they are going to build and operate a simple seismograph. Display the several seismographs on Master 29. Point out the basic parts they have in common: weight, support, pen, and recording paper. Give students these directions:
 - a. Attach string to handle of container.
 - b. Pour the sand (or water) into the container.
 - c. Firmly tape the felt tip marker to the outside of the container with the tip sticking out below the bottom of the container.
 - d. Hold the sand-filled container over the desk.
 - e. Place a sheet of paper on the desk and position the container over one end of the paper with the felt marking tip just touching the end of the paper. One member of the group will hold the container in this position.

Extension

Students may wish to build other types of seismographs, such as those described in the references. Master 29 suggests some possible designs, but you might be surprised at what students can do on their own, without following a pattern.

2. While one member of the group gently shakes the table, another member gently and steadily pulls the paper under the felt marker. Use a timing device so that the pull lasts between 5 to 10 seconds.

3. Have students label the sheet of paper "Gentle Shaking," and tell students that they have made a seismogram.

4. Ask the students to make two more seismograms, shaking the desk harder each time. Ask students to number the seismograms that result from 1 to 3, with 1 being the most gentle shaking.

5. Explain and define "wave amplitude," using Master 32, Seismogram Showing Amplitude. Help students to measure the amplitude of their own seismograms and relate them to the degree of force with which they shook their desks. Ask:

How does the amplitude of the wave on the seismogram (Master 32) relate to the magnitude of the earthquake it records? (The higher the wave amplitude, the higher the magnitude.)

Which of your own seismograms would have the highest magnitude? (The one with the highest amplitude, or the one which received the hardest shaking.)



Activity Five: The Mercalli Scale - Calling Station KWAT

Materials for the teacher

- Overhead projector
- One copy of Master 36a, KWAT Television Script
- Transparency made from Master 28, Modified Mercalli Scale
- Transparency made from Master 36b, Wattsville Map Key

Materials for each small group of students

- Handouts made from Master 28, Modified Mercalli Scale
- Handouts made from Master 36b, Wattsville Map
- Handouts made from Master 36a, KWAT Television Script
- Pencil and colored pens

Procedure

1. Project the transparency of Master 28, Modified Mercalli Scale, and distribute copies to students. Review the background information about the two earthquake scales.

Explain that the magnitude scale measures the amount of energy released by an earthquake. The Mercalli scale measures the observed effects (amount of damage) caused by an earthquake. Emphasize that a single earthquake will have only one magnitude, but several measures of intensity. If some students in the class have experienced an earthquake, ask them to estimate its intensity from the Mercalli scale.

2. Ask students to compare and contrast the differences between the two types of measurements. Ask: Why do you think magnitude is more often reported than intensity? (Most earthquake-prone areas have equipment already in place to determine magnitude, so this measurement can be quickly established. Measures of intensity are sometimes not arrived at until several days later, when a full estimate of the damage can be made.)

- 3.** Tell students that in this activity they will be using data adapted from reports of an earthquake that struck California in 1989. Distribute copies of Master 36b, Wattsville Map. Appoint one student to be Jake Wilde, a television news anchor, and tell the other students that they are the citizens of Wattsville and the surrounding area. The town has just been struck by an earthquake.
- 4.** Distribute the strips cut from Master 36a, KWAT Television Script, and have students take turns reading them in order, starting with the news anchor's report. Distribute student copies of the script as well.
- 5.** As each student reads a part, have the other students locate the site of the report on their maps, scan the Modified Mercalli Intensity Scale, and mark a Mercalli intensity (using appropriate Roman numeral) in pencil next to the location on the map.
- 6.** After the last student has read, have each student use a colored pen to connect areas with equal intensity ratings to develop an isoseismal map. (They will be drawing a series of concentric lines.)

Unit IV. Measuring Earthquakes

Materials List

Grades K-2

shallow box
sand or soil
pencils & paper
small blocks
sugar cubes
Legos™
Lincoln Logs™
penne pasta
Play-Doh™ or flubber
large clock
blackboard
chalk

Grades 3-4

drawing paper
colored pencils
crayons
felt markers
scissors
tape
overhead projector
blank transparencies
overhead marker
pencils

Grades 5-6

overhead projector
Slinky™ toys
safety goggles
shoe box or 2 qt.
paper milk carton
punching tool
long rubber band
scissors
metal washers
paper clips
drum
colored paper
timing device
pencils
notebooks
paper
felt markers
quart- to gallon-size
container with handle
sand
strong string
tape

Shake Table

Materials

- Box lid or shallow box with flaps removed
- Flat piece of cardboard, 1" to 2" smaller than box
- Rubber bands (4)
- Paper clips (4)
- String, two 12" pieces
- Single-hole punch or ball-point pen

Procedure

The Shake Platform

1. Punch a hole in each corner of the piece of cardboard 1/2" from both edges.
2. Locate the center of one long side of the cardboard and punch a hole 1/2" from outside of edge.
3. Locate the center of one short side of the cardboard and punch a hole 1/2" from outside of edge. You now have a total of six holes in the cardboard.

The Shake Platform

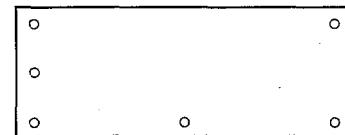

The Shake Box

4. Punch two holes in each of the short sides of the box 1" down from the top and 1" from each corner to correspond with the holes in the flat piece of cardboard. You now have four holes in the box.
5. Locate the center of one long side of the box and punch a hole 1" down from the top.
6. Locate the center of one short side of the box and punch a hole 1" down from the top. You now have a total of six holes in the box.
7. Attach rubber bands and secure them to the cardboard by feeding them through the holes in the corners and looping them through themselves.
8. Attach rubber bands -- and therefore the entire cardboard platform -- to the box by feeding the free ends of the rubber bands through the holes in the corners of the box and securing them with paper clips outside the box (see diagram). The platform now should be suspended or "floating" inside the box.
9. Tie a string to the middle hole of one short side and one long side of the platform, and feed it through the corresponding hole in the box. By pulling the strings side-to-side, lateral shaking will be simulated.

The Shake Box

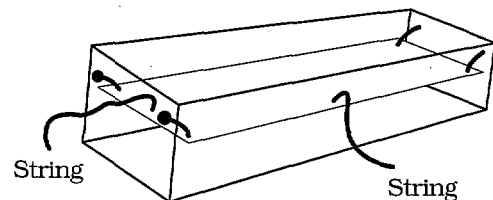

Modified Mercalli Scale

- I.** People do not feel any Earth movement.
- II.** A few people might notice movement if they are at rest and/or on the upper floors of tall buildings.
- III.** Many people indoors feel movement. Hanging objects swing back and forth. People outdoors might not realize that an earthquake is occurring.
- IV.** Most people indoors feel movement. Hanging objects swing. Dishes, windows, and doors rattle. The earthquake feels like a heavy truck hitting the walls. A few people outdoors may feel movement. Parked cars rocked.
- V.** Almost everyone feels movement. Sleeping people are awakened. Doors swing open or close. Dishes are broken. Pictures on the wall move. Small objects move or are turned over. Trees might shake. Liquids might spill out of open containers.
- VI.** Everyone feels movement. People have trouble walking. Objects fall from shelves. Pictures fall off walls. Furniture moves. Plaster in walls might crack. Trees and bushes shake. Damage is slight in poorly built buildings. No structural damage.
- VII.** People have difficulty standing. Drivers feel their cars shake. Some furniture breaks. Loose bricks fall from buildings. Damage is slight to moderate in well-built buildings, considerable in poorly-built buildings.
- VIII.** Drivers have trouble steering. Houses that are not bolted down might shift on their foundations. Tall structures such as towers and chimneys might twist and fall. Well-built buildings suffer moderate damage. Poorly-built structures suffer severe damage. Tree branches break. Hillsides might crack if the ground is wet. Water level in wells might change.
- IX.** Well-built buildings suffer considerable damage. Houses that are not bolted down move off their foundations. Some underground pipes are broken. The ground cracks. Reservoirs suffer serious damage.
- X.** Most buildings and their foundations are destroyed. Some bridges are destroyed. Dams are seriously damaged. Large landslides occur. Water is thrown on the banks of canals, rivers, lakes. The ground cracks in large areas. Railroad tracks are bent slightly.
- XI.** Most buildings collapse. Some bridges are destroyed. Large cracks appear in the ground. Underground pipelines are destroyed. Railroad tracks are badly bent.
- XII.** Almost everything is destroyed. Objects are thrown into the air. The ground moves in waves or ripples. Large amounts of rock may move.

Seismographs

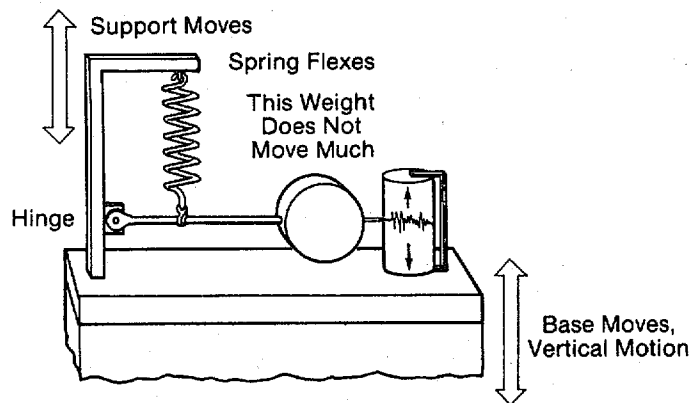
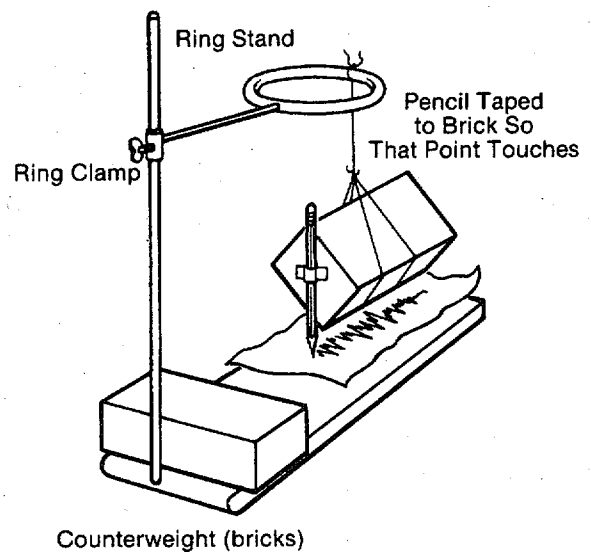
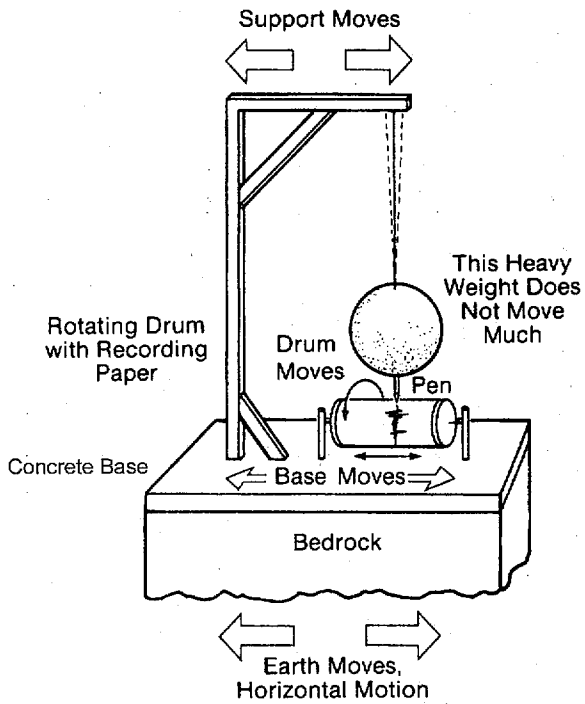

Seismogram Worksheet

Name _____

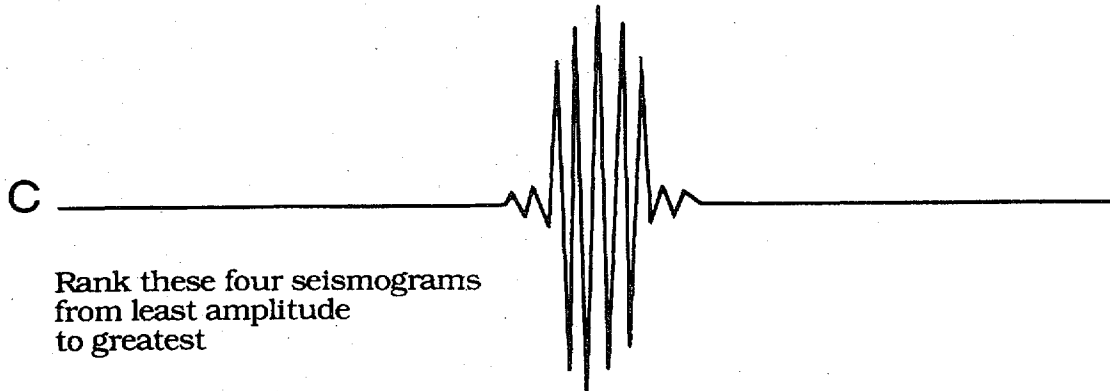

Rank these four seismograms
from least amplitude
to greatest

Least _____

Greatest _____

D 

Four seismogram
recordings of four
different earthquakes, all
100 kilometers from
the seismograph

Earthquake Magnitude and Energy

Magnitude	TNT Energy Equivalent	Example (approximate)
1.0	6 ounces	Small blast at a construction site
1.5	2 pounds	
2.0	13 pounds	Average quarry blast
2.5	63 pounds	
3.0	397 pounds	Smallest earthquake commonly felt
3.5	1,000 pounds	
4.0	6 tons	Small atomic bomb
4.5	32 tons	Average tornado
5.0	199 tons	
5.5	500 tons	Massena, NY quake, 1944
6.0	6,270 tons	
6.5	31,550 tons	Northridge, CA quake, 1994
7.0	199,000 tons	Hebgen Lake, MT quake, 1959
7.5	1,000,000 tons	Mount St. Helens eruption, 1980
8.0	6,270,000 tons	San Francisco, CA quake, 1906
8.5	31,550,000 tons	Anchorage, AK quake, 1964
9.0	199,999,000 tons	Chilean quake, 1960

Seismogram Showing Amplitude

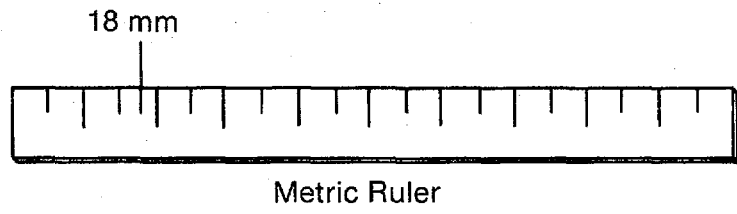
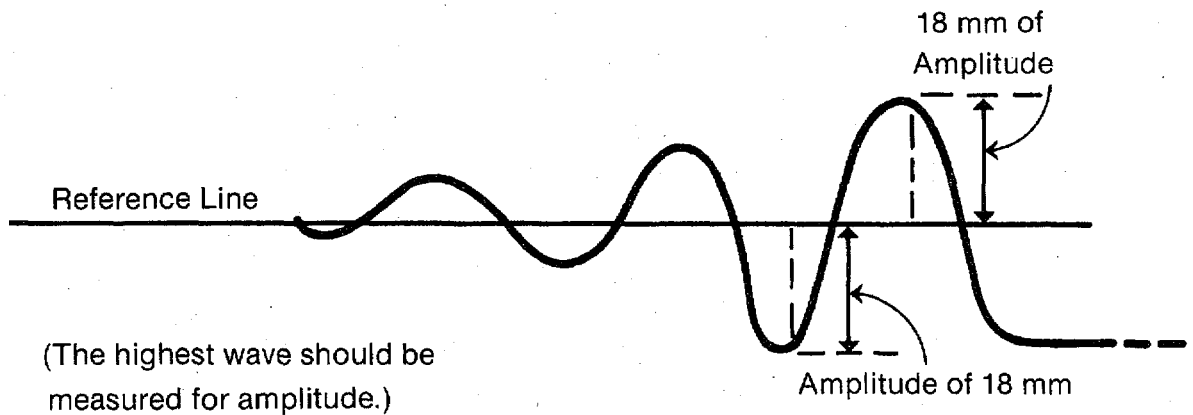

Earthquake Severity Worksheet

Name _____

Magnitudes	Earthquake Effects	Estimated Number Per Year Worldwide
1.0-3.0	Generally not felt but recorded.	
3.1-4.0	Often felt, but only minor damage.	
4.1-6.0	Slight damage to buildings.	
6.1-6.9	Can be destructive in places where people live.	
7.0-7.9	Major earthquake. Causes serious damage.	
8.0 or greater	Great earthquake. Total destruction to nearby communities.	

Choose which answers belong in the last column.

Answers:	20	15,000	3,000,000
	120	50,000	1

P-Wave Motion and S-Wave Motion

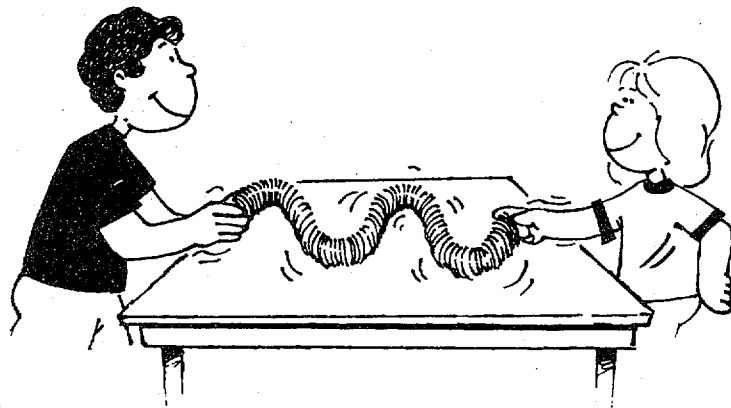
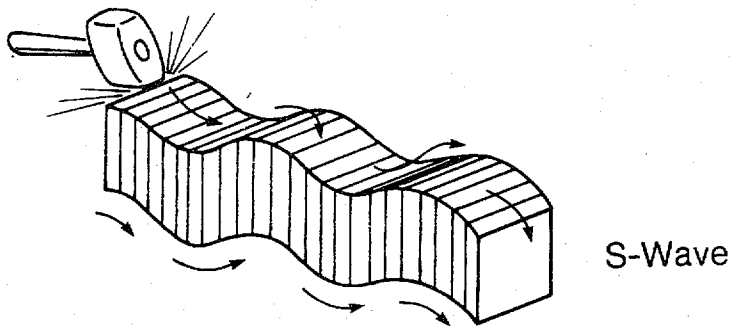
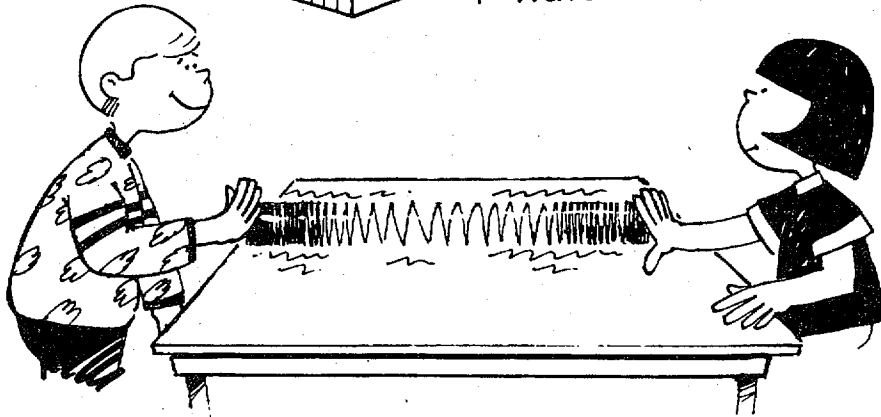
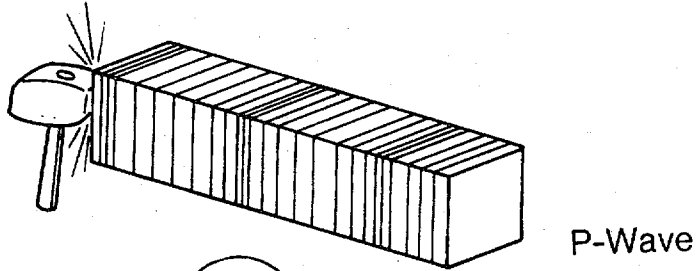

The S-Wave Machine

Pull the end of a cut rubber band through the hole and tie it to a washer.

Metal Washer

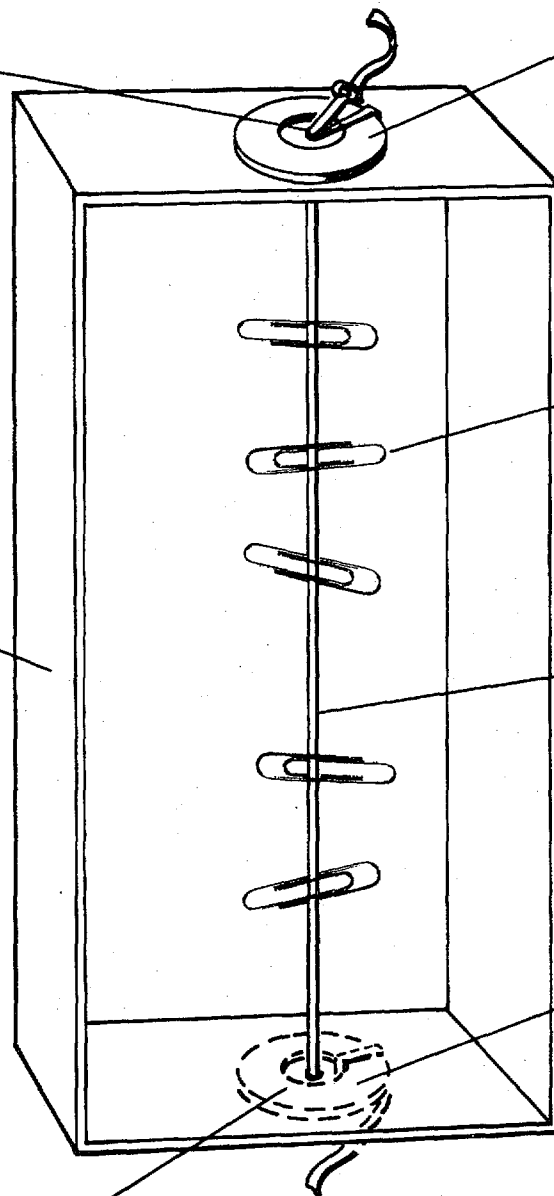

Paper Clips

Shoebox

Rubber Band

Metal Washer

Pull the rubber band taut through the hole.

KWAT Television Script

Jake Wilde: "We interrupt our regularly scheduled programming on KWAT to bring you a special bulletin. This is KWAT news anchor, Jake Wilde. Moments ago the town of Wattsville was shaken by a strong earthquake. Residents in the KWAT broadcast area are invited to call our emergency response number, 555-KWAT, and give us your name, your location, and a brief summary of what you experienced during the quake. Stay tuned for the latest reports of what your neighbors saw and felt. To report your observations, call 555-KWAT. We have caller number 1 on the line."

Caller 1: "Hi, this is Charles from the hospital. We only had slight to moderate damage in the new, well-built Children's Care building. The building containing most of our records was old and poorly built; damage there was considerable."

Caller 2: "Hello my name is Roy, and I'm calling from the RQB Ranch. We were just sitting around the kitchen table, when suddenly coffee sloshed out of all our cups. Several cabinet doors opened up and dishes fell and broke."

Caller 3: "Hi, this is Carmen at Long Valley Boutique. We have a mess here. When the quake struck, it moved all of our wall displays, and all our little ceramics fell and broke."

Caller 4: "Hi Jake, I'm Susan calling from the Faithful Church. When the earthquake struck, our bell tower collapsed."

Caller 5: "Hi. This is Jo from Southside City Junior High School. Students felt it and did the drop, cover, and hold drill. We only had slight damage to the building, just some cracked plaster in the walls. A few pictures also fell."

Caller 6: "Hey Jake, this is Hank and I'm calling from the basement of the First Bank in the center of Wattsville. This old building has partially collapsed and people are trapped down here. Please send help."

Caller 7: "Hi, this is Fernando. I work at the Sunrise Senior Center. Many of our clients were frightened. All our supplies fell off the shelves."

Caller 8: "Hello Jake, this is Debbie. We were picnicking at the Great Bend Park. When the quake struck, it woke up Granny and we saw trees and the flagpole swaying back and forth."

Caller 9: "Hi, this is Lee Quon. When the quake hit, I was at Hot Springs Ranch visiting friends. Nearly everyone felt it. All the doors that were open, slammed shut."

Caller 10: "Hi Jake, this is Ben. I was at Blue Lake Resort when all the cars in the parking lot started rocking back and forth."

KWAT Television Script (cont'd.)

Caller 11: "Jake, this is Gene at White Water Manufacturing. All the heavy furniture in the showroom was moved by the quake, and some of the plaster cracked and fell off the walls."

Caller 12: "Hi, this is Diana calling from Happy Slurps Ice Cream. Over here, we thought that a big truck had hit the building."

Caller 13: "Hi Jake, this is Ken at River City Video. Our whole collection of tapes is on the floor and all our posters fell off the walls."

Caller 14: "Hi, this is Maria and I'm calling from Plants-R-Us. During the quake, all our hanging plants were swaying and all our windows were rattling."

Caller 15: "Hi Jake, this is David from Wattsville University. Everyone in our class felt the quake, and some of the older, more poorly built buildings suffered considerable damage."

Caller 16: "Hello Jake, this is Steve from the South End Mall. All the shoppers were having a hard time standing during the quake. We had a lot of breakage, especially in our furniture shops."

Caller 17: "Hey Jake! Jed here. Over at the Roundup Truck Stop, the trucks were shaking with the quake. The drivers at the gas pumps had to hold on to the pumps to keep standing."

Caller 18: "Hi Jake, this is Jenny. When the quake struck we were mowing lawns at the West Side Subdivision. We saw trees and bushes shake and everyone was finding it difficult to walk."

Caller 19: "Hi Jake, this is Juan at White Water Pets. During the quake water sloshed out of all our small aquariums. That sure woke up any sleeping fish!"

Caller 20: "Hello Jake, this is Martha at the Cottage Motel. All our customers were frightened. Nearly all of our little cottages moved off their foundations and the water level in our well dropped at least a foot."

Caller 21: "Hi Jake, this is Marty up at Big Bear Ski Resort. The quake rattled our dishes and windows. I saw some parked cars rocking. Most folks who were outdoors, didn't feel the shaking."

This activity was adapted from FEMA 253, Seismic Sleuths - A Teacher's Package for Grades 7-12.

Wattsville Map

Name _____

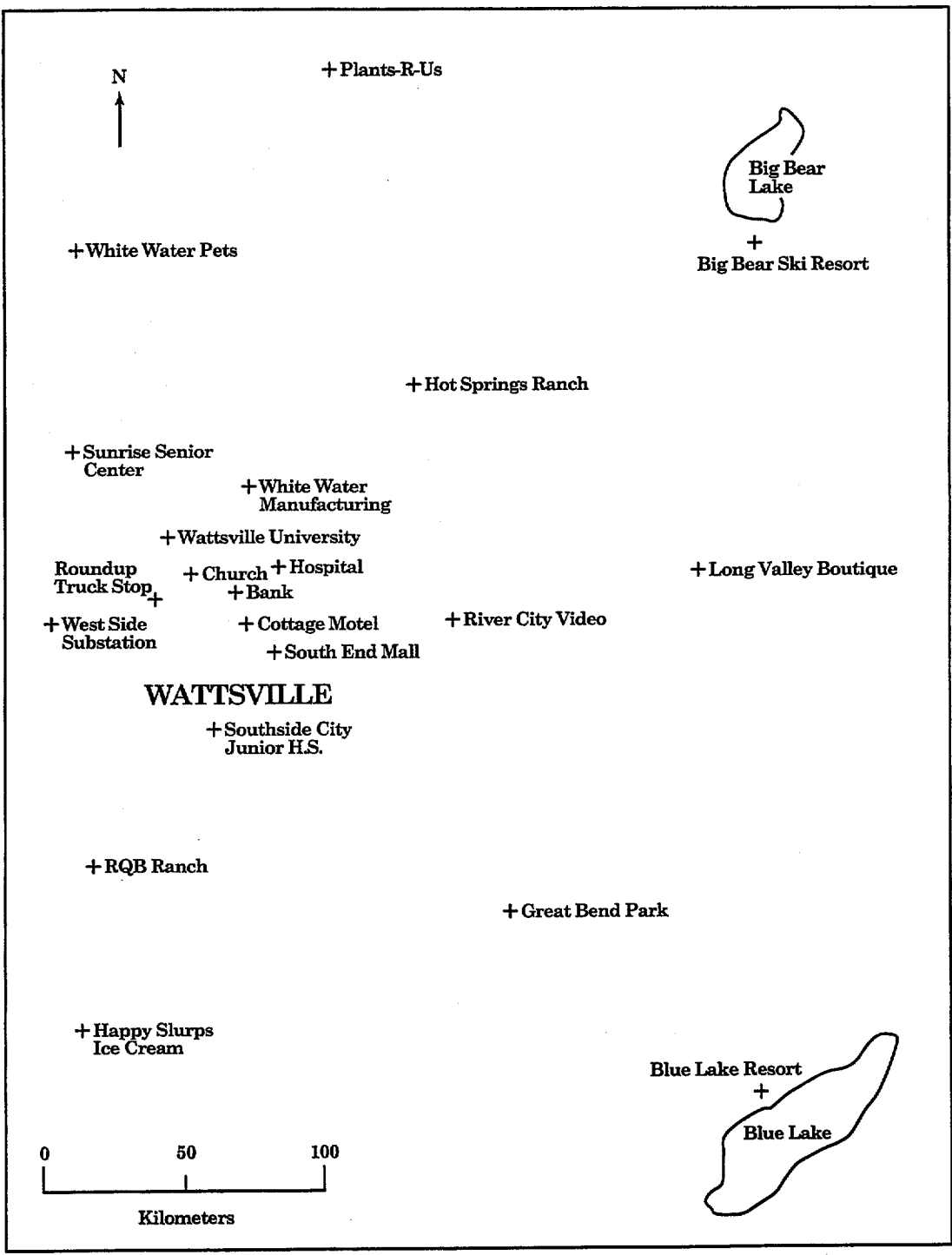

Wattsville Map Key

Name _____

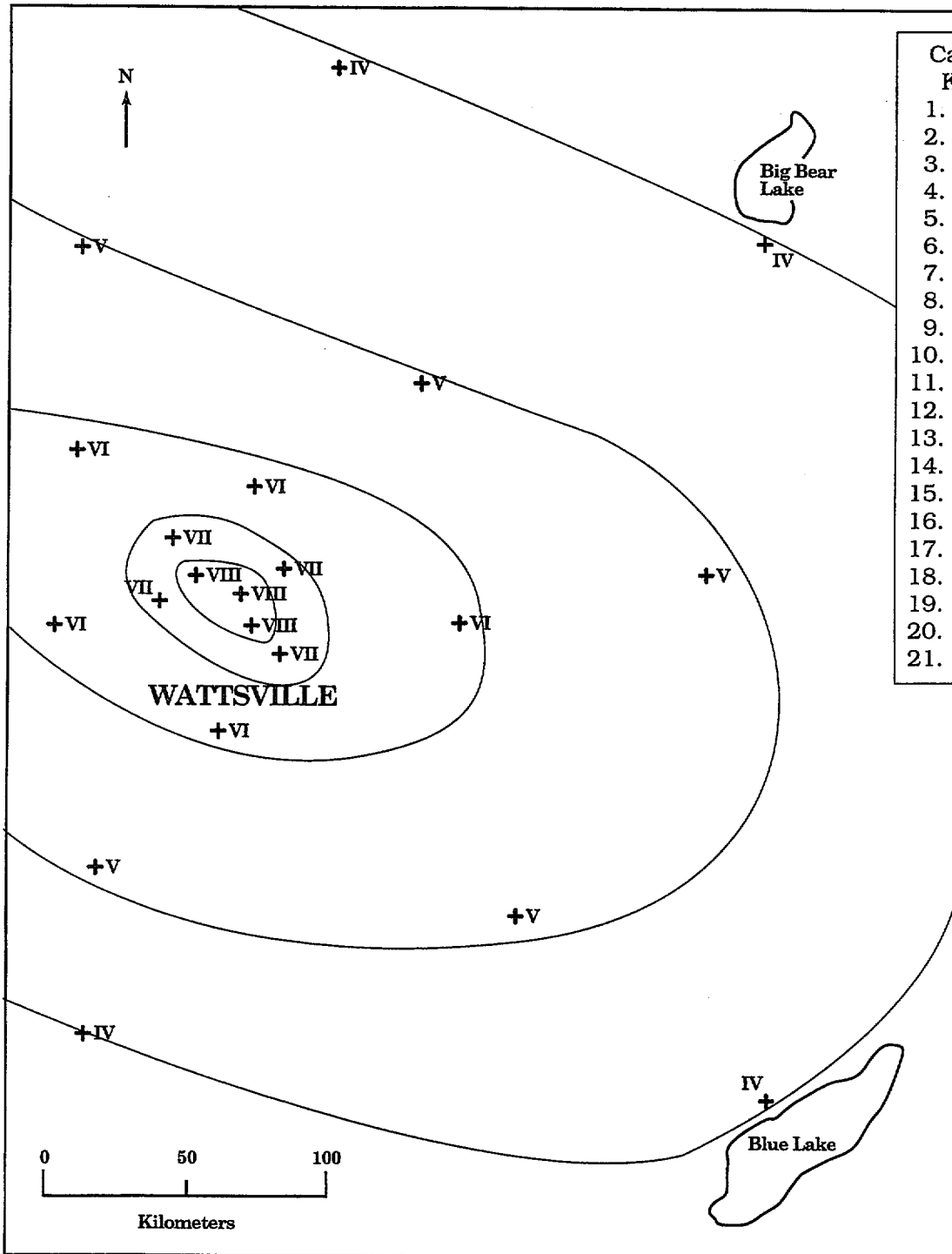

Caller Key	
1.	VII
2.	V
3.	V
4.	VIII
5.	VI
6.	VIII
7.	VI
8.	V
9.	V
10.	IV
11.	VI
12.	IV
13.	VI
14.	IV
15.	VII
16.	VII
17.	VII
18.	VI
19.	V
20.	VIII
21.	IV

Note: Isoseismal lines and locations may vary.

V



Earthquake Safety
and Survival

Earthquake Curriculum, K-6 -- Scope and Sequence Chart

Unit V: Earthquake Safety and Survival

Part	Concept	Laboratory	Mathematics	Language Arts	Social Studies	Art
1	<p>Earthquake shaking is possible everywhere in the United States.</p> <p>People may feel, see, hear, and smell the signs of an earthquake.</p> <p>Earthquakes affect people in many ways.</p>	<p>Earthquake simulation</p>		<p>Describe experiences</p> <p>Earthquake vocabulary</p>	<p>Locating states and corresponding level of earthquake hazards</p> <p>Demonstrating earthquake-safe behavior</p>	<p>Coloring an earthquake hazard map</p> <p>Drawing pictures or constructing diagrams of earthquake damage</p>
2	<p>Every environment contains potential earthquake hazards.</p> <p>Students can identify hazards and eliminate them or reduce their impact.</p>	<p>Classroom hazard hunt</p> <p>Home hazard hunt</p> <p>Community hazard hunt</p>		<p>Discussion and list making</p>	<p>Discussion of damage to buildings caused by earthquakes</p> <p>Hazard hunt and ways to reduce danger</p>	<p>Illustrations of earthquake hazards in classrooms</p>
3	<p>Students can increase their chances for survival in an earthquake by having essential supplies before they are needed.</p> <p>Students can help to assemble emergency kits of supplies for their classroom, home, and family vehicle.</p> <p>Students can help to inform others about earthquake safety and survival.</p>	<p>Safety kit preparation</p>		<p>Disseminating information to family and neighbors</p> <p>Group solutions</p> <p>Slogan writing</p>	<p>Discussion of essential items needed during evacuation</p> <p>Earthquake safety kits</p> <p>Poster distribution</p>	<p>Earthquake safety posters</p>
4	<p>Students can cope with hazards during evacuation.</p> <p>Students are responsible first for their own safety and can then help if others are injured.</p> <p>Students can cope with the disturbed environment and their own emotional reactions.</p>	<p>Evacuation drill</p>		<p>Hazard descriptions</p>	<p>Discussion of hazards during evacuation</p> <p>Giving aid to the injured</p> <p>Feelings and events after an earthquake</p> <p>Drop and cover procedures</p>	<p>Safety kit decorating</p>

V

Earthquake Safety and Survival

Scientists cannot accurately predict when and where an earthquake will occur. We can teach our students what to expect, however and how to protect themselves. Teaching our students to recognize an earthquake and take immediate positive action can help them and those around them to come through the disaster safely. Students can also learn to recognize earthquakes hazards and learn how to eliminate some and avoid others. Classroom activities and discussions provide opportunities for students to develop pride in the competency they have gained.

Earthquake Safety and Survival

All 50 states and all U.S. Territories are vulnerable to the hazards of earthquakes. Earthquakes have caused, and can cause in the future enormous loss of life, injury, destruction of property, and economic and social disruption.

Earthquake Hazards Reduction Act of 1977
(Public Law 95-124, as amended)

Part 1: What Happens During an Earthquake?

Most people caught in earthquakes have a feeling of helplessness. Especially if they have never experienced a quake before, they have no idea how long it is going to last or what will happen next. In this unit you will take your students through several steps that will help them know what to expect and what to do if an earthquake occurs.

What to Expect

The first indication of a damaging earthquake may be a gentle shaking. You may notice the swaying of hanging plants and light fixtures or hear objects wobbling on shelves. Or you may be jarred first by a violent jolt (similar to a sonic boom). Or you may hear a low (and perhaps very loud) rumbling noise. A second or two later, you'll really feel the shaking, and by this time, you'll find it very difficult to move from one place to another. A survivor of the 1906 San Francisco Earthquake compared the physical sensation to riding down a long flight of stairs on a bicycle.

It's important to take "quake-safe" action at the first indication of ground shaking. Don't wait until you're certain an earthquake is actually occurring. As the ground shaking grows stronger, danger increases. For example:

Free-standing cabinets and bookshelves are likely to topple. Wall-mounted objects (such as clocks, maps, and art work) may shake loose and fly across the room.

Suspended ceiling components may pop out, bringing light fixtures, sprinkler heads, and other components down with them.

Door frames may be bent by moving walls and may jam the doors shut. Moving walls may bend window frames, causing glass to shatter and send dangerous shards into the room.

The noise that accompanies an earthquake may cause considerable emotional stress—especially if students are not prepared to expect the noisy clamor of moving and falling objects, shattering glass, wailing fire alarms, banging doors, and creaking walls. The noise will be frightening, but a little less so if it's anticipated.

Part 2: Hazard Hunts

Contrary to popular imagination, an earthquake does not cause the Earth to open up and swallow people. Especially in the smaller earthquakes, which make up the vast majority of all quakes, most injuries and fatalities occur because the ground shaking dislodges loose objects in and on buildings.

Anything that can move, fall, or break when the ground starts to shake is an earthquake hazard if it can cause physical or emotional harm.

Classrooms, homes, and all the other places where children spend time indoors contain objects that could cause injury or damage during a quake. Because students have already learned a great deal about earthquakes in the previous lessons, they are able to identify many of these objects themselves. They make class lists of the hazards in different settings and then work with teachers, parents, and other adults to eliminate as many hazards as they can.

Students can remove objects that could fall and cause injury during earthquake shaking. Those objects that cannot be removed should be securely fastened. In the classroom these may include fish tanks and animal cages, wall maps, models, and wheeled items such as pianos and rolling carts for audiovisual equipment. At home, bookcases, china cabinets, and other tall furniture should be secured to wall studs. Hanging lamps, heavy mirrors, framed pictures, and similar ornaments should be removed or permanently fastened.

There will be some hazards in the classroom, home, and community that students will not be able to eliminate. Be sure they know how to avoid those things they cannot change.

Operation A-R-R-R

- | | |
|-----------------------------------|---------------------------------|
| <input type="checkbox"/> Anchor | <input type="checkbox"/> Refit |
| <input type="checkbox"/> Relocate | <input type="checkbox"/> Remove |

Part 3: Prepare and Share Emergency Kits

After a quake you and your students may spend several days together, cut off from many of the normal sources of community support. In Part 3 of this unit the class will devise emergency kits for several settings and make one for the classroom. Students will also make posters as a way of sharing their knowledge of earthquake preparedness.

Part 4: Earthquake Simulation and Drill

During an earthquake, the most important thing for any child or adult to remember is the Drop and Cover drill:

At the first indication of ground shaking, get under a desk or table, face away from windows, bend your head close to your knees. Use one hand to hold onto the table leg and protect your eyes with your other hand. If your "shelter" moves, move with it.

After the quake it is important to get out of the building and into a clear space, taking the emergency kit along with your roll book. In Part 4, students will point out various hazards that might occur in the course of leaving the building and discuss ways of dealing with various obstacles.

Aftershocks may occur without warning, minutes or even months after the major earthquake. Practice Drop and Cover on the way out of the building, and in as many other settings as possible, until the drill becomes second nature to you and your students.

Give your students several opportunities to ask questions and discuss their fears and concerns. They'll have plenty of "what if" questions. Don't feel that you must provide all the answers. Let your students hold problem-solving sessions. Class and group discussions provide opportunities for students not only to express their negative (and normal) feelings, but also to emphasize the positive skills they have gained.

IMPORTANT NOTE: This unit is intended to be used by all the grades, kindergarten through sixth. Feel free to modify the materials and procedures to suit your students.

Part 1: What Happens During an Earthquake?

Vocabulary

natural hazard

Learning Links

Language Arts: Describing experiences

Social Studies: Locating states and corresponding level of earthquake hazard, experiencing a simulation of an earthquake

Art: Coloring an earthquake hazard map, drawing, picture, or constructing dioramas of earthquake damage

Content Concepts

1. Earthquake shaking is possible everywhere in the United States.
2. Students might feel, see, hear, or smell the signs of an earthquake.

Objectives

Students will

- identify the earthquake hazard for their state.
- identify hazards caused by earthquakes.
- demonstrate safe behavior during an earthquake simulation.

Assessment

Explain why, when, and (demonstrate) how to Drop and Cover.

Activity One: Size Up Your State

Materials for the teacher

- Transparency made from Master 37, Earthquake Hazard Map, colored according to directions in step 3 below.
- Overhead projector

Materials for each student

- Copy of Master 37, Earthquake Hazard Map
- Crayons or colored pencils

Procedure

1. Read and discuss the definition of natural hazard. Ask: If an earthquake occurs in an uninhabited region and has no impact on human beings or their property, is it a hazard? (Not for human beings, though it may be for other life forms.)

2. Tell students that thousands of earthquakes occur in the United States each year. Most are too small to be felt by people. Only a few are strong enough to cause damage.

Allow students to speculate on the following questions: Are all regions of the U.S. likely to receive earthquake damage? What states are most likely to receive earthquake damage?

3. Tell students that earthquake shaking is possible in all 50 states and all U.S. Territories. People hundreds of miles from the epicenter of a strong earthquake may experience shaking and damage.

nat • u • ral haz • ard

Any of the range of natural Earth processes that can cause injury or loss of life to human beings and damage or destroy property.

Master 37. Earthquake Hazard Map

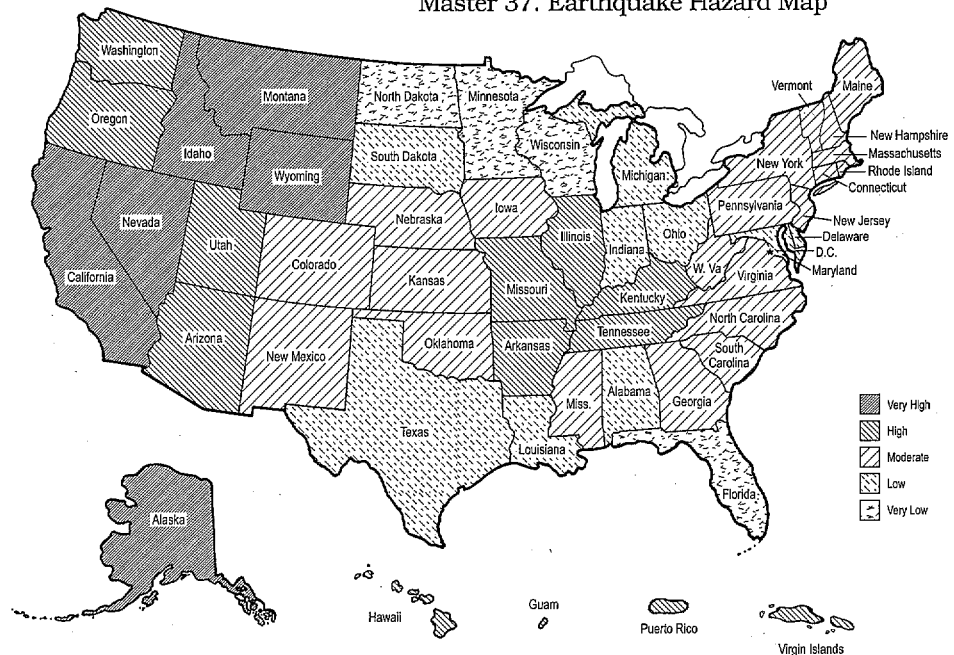

Teacher Take Note: If your school is not in a moderate to very high earthquake hazard state, help students realize that they may visit one or move to one someday. Tell them that it is important that they learn how to protect themselves.

Distribute a copy of Master 37, U.S. Earthquake Hazard Map, along with crayons or colored pencils, to each student. Give these instructions:

- a. Use green to color in the states marked with a **VL**. In the legend, use green to color in the box in front of the word Very Low.
- b. Use blue to color in the states marked with an **L**. In the legend, use blue in the box in front of the word Low.
- c. Use yellow to color in the states marked with an **M**. In the legend, use yellow in the box in front of the word Moderate.
- d. Use orange to color in the states marked with an **H**. In the legend, use orange in the box in front of the word High.
- e. Use red to color in the states marked with a **VH**. In the legend, use red to color in the box in front of the word Very High.

4. After the maps have been colored, project the overhead and conduct a class discussion around the following questions:

What is the earthquake hazard for our state?

How many states in the U.S. are believed to be totally free from earthquake hazards? (none)

How many of you have favorite places to visit (on vacation or to see relatives) that are in states with moderate to very high earthquake hazards?

Activity Two: Earthquake Simulation

Materials for the teacher

- Master 38, Earthquake Simulation Script
- Transparency made from Master 39, Drop and Cover
- Master 40, Coalinga Schools Report (teacher background only)
- Overhead projector

Materials for the students

- Desks or tables to get under
- Optional items for simulation activity (chairs to rattle; pencils, books, and other objects to drop)

Procedure

1. Explain that you are going to talk through an imaginary earthquake to help students understand what might happen during a real one. Display the transparency of Master 39, Drop and Cover, and direct students to practice the following actions:

- Get under a desk or table
- Face away from windows
- Bend your head close to your knees
- Use one hand to hold onto the table leg (approximately 6" from the floor to avoid pinching fingers) and protect your eyes with your other hand.

2. Create Special Effects. (This step is optional. If you decide to carry it out, warn your teacher-neighbors.) Appoint student helpers for the simulation. Before the simulation, describe what each helper should do according to the script.

Teacher Take Note: Do not excuse children with special needs from participating in earthquake drills. Children who are blind, deaf, or have impaired mobility especially need experiences which build confidence in their ability to avoid and cope with dangers. Plan with other teachers and the school nurse to determine quake-safe actions for these children.

It may not be possible for children with impaired mobility to get under a desk or table. They can, however, learn to react quickly and turn away from windows; move away from light fixtures and unsecured bookcases; and use their arms or whatever is handy to protect their heads.



Teacher Take Note: Once you are confident that your students have learned and practiced the skills to protect themselves, place yourself in a safe position (e.g., under your desk) during future drills. Your students need to know that you too will be safe.

3. Read the simulation, Master 38 (the first three paragraphs should take approximately 45 seconds).
4. Take time after the simulation to let students respond to the experience. Encourage them to ask questions and discuss their fears and concerns.
5. Discuss what to do in various situations.
6. Practice **Drop and Cover** in as many other settings as possible, until the drill becomes second nature to you and your students. You may want to time how long it takes to get into a safe position in a safe manner (too much haste may cause bumps and bruises).

In teaching this activity lesson, be sensitive to your students' fears and concerns, and give them chances to talk and ask questions. Let your students know that fear is a normal reaction to any danger. Remind them that they will become less afraid when they learn how to take care of themselves if an earthquake happens.

Earthquake Safety Reminders for Students

If you're outside

- Stay outside.
- Go to an open area away from hazards.

If you're inside

- Crouch under a desk or table,
- Face away from windows,
- Bend your head close to your knees,
- Use one hand to hold onto the table leg (approximately 6" from the floor to avoid pinching fingers) and protect your eyes with the other hand.

If no desk or table is nearby:

- Kneel against an interior wall
- Face away from windows,
- Bend your head close to your knees,
- Clasp hands on the back of your neck.

Activity Three: Know What Might Happen

Materials for the students

- Pencil and paper
- Crayons or colored pencils

Procedure

- 1.** Review with the students information they have learned about the different locations where earthquakes occur, emphasizing that earthquakes occurring where people live is our greatest concern.
- 2.** Tell the students that during an earthquake, the Earth beneath their feet moves like a deck of a ship. The actual movement of the ground, however, is seldom the direct cause of injuries or deaths. Most injuries and deaths are caused by falling objects and debris from damaged buildings. Point out that the Earth does not split open and swallow people and homes. Emphasize that we can avoid or reduce our chances of being hurt if we know what to expect and what to do during an earthquake.
- 3.** Review the classroom earthquake drill, call out "Drop and Cover," and ask students to demonstrate quake-safe procedures.
- 4.** Read to the class descriptions of what they might see, feel, hear, or smell if they were at home during an imaginary earthquake.
 - a.** Before you begin to describe what may happen in a living room, ask students to pretend they are in a safe place in their own living room (or that of a relative or friend).
 - b.** After you described what may happen in the living room, ask students if the place they selected would keep them safe. If some students are concerned about their safety, allow time for the class to discuss how to become quake safe.
 - c.** Repeat 4a and 4b for the bedroom and neighborhood.

Teacher Take Note: As an alternative activity to the drawings, ask student groups to design and construct a shoebox diorama of a setting that has been affected by an earthquake.

5. Ask the students to draw or write about what they saw, heard, and felt during the imaginary earthquake and share with the class. If one or more of your students had experienced a damaging earthquake, allow them to describe to the class what they saw, felt, etc.

Living Room

You might become aware of a gentle movement which grows stronger, or you might be jarred by a sudden jolt and wonder if a truck hit your home.

You would see hanging objects swing and sway, and possibly fall from their hooks. You might see tall pieces of furniture topple over. Plaster may drop, windows may shatter. Electric lights may flicker and go out.

You would hear a low rumbling noise that quickly grows louder. You might also hear creaking and grumbling from the house itself. You might smell odors from spilled food and liquids.

Bedroom

You would see pictures and mirrors fall and break. Things on shelves will topple over. Water would slosh out of aquariums. Books would fall off shelves.

You might hear the house creak and grumble. You might hear bricks tumbling from chimneys. You might hear animals make loud, excited noises.

Outside

You might see bricks come loose and tumble from buildings. Separate parts of buildings such as signs and decorations may fall and cause damage. Water pipes may begin to leak and flood the streets.

You may hear church bells ringing, cars honking, and sirens wailing. You may smell gas, or smoke from gasoline leaks and fires.

IMPORTANT NOTE: This unit is intended to be used by all the grades, kindergarten through sixth. Feel free to modify the materials and procedures to suit your students.

Part 2: Hunt for Hazards

Vocabulary

hazard
cornice
parapet

Learning Links

Language Arts: Discussing hazards and making lists, using and applying action verbs, sharing information with parents and families

Social Studies: Identifying hazards throughout the community on several levels: school, home and beyond

Art: Drawing home hazards that are not on the Home Hazard Hunt worksheet

Content Concepts

1. Every environment contains potential earthquake hazards.
2. Students can identify hazards and eliminate them or reduce their impact.

Objectives

Students will

- identify potential hazards in their classroom that may cause damage, injury, or death during an earthquake.
- list, and if possible, make changes in their classroom to reduce potential hazards.
- identify potential earthquake hazards in their homes.
- list, and, if possible, make changes in their homes to reduce potential hazards.

Assessment

List three things you have done to make yourself, your family, and/or your classmates safer from earthquake hazards.

Activity One: Classroom Hazard Hunt

Materials for the teacher

- Transparency made from Master 41, Fourth Grade Classroom
- Overhead projector
- Transparency marker

Materials for each student

- Handout made from Master 41, Fourth Grade Classroom
- Crayons or colored pencils
- Handout made from Master 42. Classroom Hazard Hunt
- Drawing paper (optional)

Procedure

1. Review with students the definition of an earthquake hazard:

Anything that can move, fall, or break when the ground starts to shake is an earthquake hazard if it can cause physical or emotional harm.

Tell students that there will be many hazards that we cannot correct, but identifying these hazards will help us to anticipate them and avoid danger and injury.

2. Invite students to conduct a hazard hunt in their classroom to identify things that might hurt them during an earthquake. Refer to Master 42, Classroom Hazard Hunt, to help students identify hazards.
3. Distribute Master 41, Fourth Grade Classroom. Have students circle or color those hazards which are found in their classroom. Ask them to make a list of any other hazards that are in their classroom but are not included in the picture, or to draw their own classroom and point out additional hazards.

haz • ard

An object or situation that holds the possibility of injury or damage.

4. Conduct a class discussion about the hazards you have identified and how they might cause harm. Use the overhead of Master 41 in your discussion.

Ask students to decide what they can do as a group to make the room safer. Actions might include tying down objects, moving hanging objects, placing objects on lower shelves, and so on. You may want to write the following action verbs on the blackboard:

move	anchor
relocate	replace
attach	remove
fasten	eliminate
secure	change
tie down	

Teacher Take Note: This activity will take about 60 to 90 minutes, or longer if students modify their classroom to make it safer during an earthquake. You may want to divide the procedure between two separate sessions.

5. If appropriate, have students spend time changing the things they can change to make their room safer.

6. Have students make a list of things that could be changed, but not without adult help. These might include putting latches on cabinets, blocking wheels on the piano, and attaching cabinets to walls.

If appropriate, have students help to make these changes. They might want to meet with the principal or work with the custodians to help make their room safer.

When changes can't be made, be sure students are aware of the remaining hazards, and know they must avoid or move away from them if an earthquake occurs.

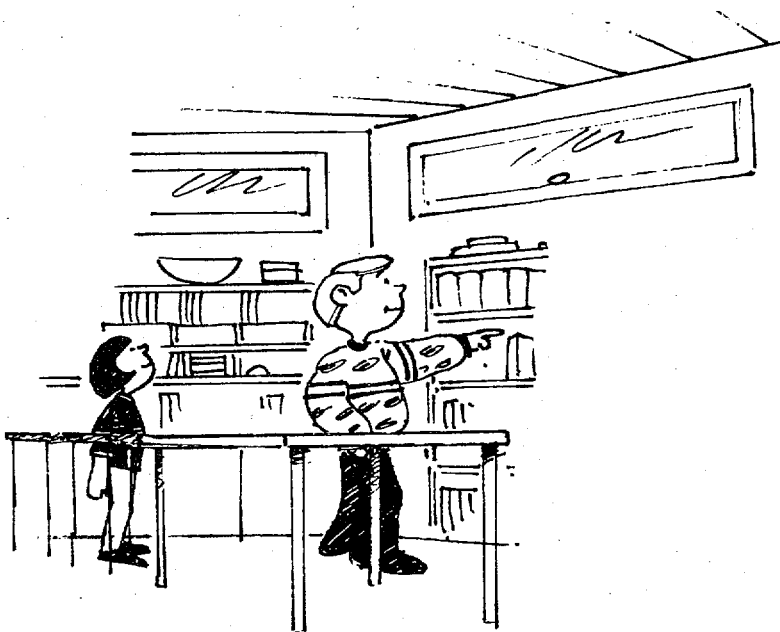

Activity Two: Home Hazard Hunt

Materials for the teacher

- Transparencies made from Master 43a, b, and c, Home Hazard Hunt Worksheets
- Overhead projector

Materials for each student

- Handouts made from Master 43a, b, and c
- Handout made from Master 44, Quake-Safe Home Checklist
- Pencil or pen

Procedure

1. Explain to students that there may be many possible earthquake hazards in their homes -- objects that can fall, break, spill, or cause damage and injury in other ways.
2. Conduct a brainstorming session with your students and see how many home hazards they can think of. List these on the board.
3. Tell students that they are going to conduct a hazard hunt at home to identify things that might hurt them or their families during an earthquake. Distribute the student worksheets. Discuss each of the pictures with the students and ask why the item pictured could be a hazard. Remind students that this sheet does not include all the possible home earthquake hazards -- just some of them.
4. Instruct students to take the worksheets home and have other children and their parents or guardians join them in looking through the house for hazards. Some hazards may exist in more than one place. Give these instructions:
 - a. Put a check in the box beneath every hazard you find in your home. (If the hazard occurs more than once, students may write a total number in the box instead of a check.)
 - b. If you can, write the name of the room(s) in which the hazard is located.

Teacher Take Note: How you use the Quake-Safe Home Checklist will depend on the grade level of your students. K-2 teachers may want to adapt this sheet.



Extension

Since homes without young children also need to be prepared for earthquakes, you and the class might explore ways of disseminating the Quake-Safe Home Checklist to other members of your community. What about grocery stores, community centers, libraries and churches? Students may have other ideas.

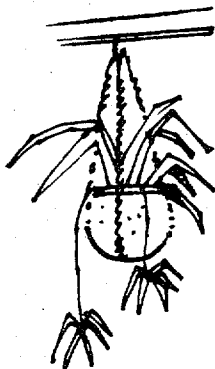

- c. On a separate piece of paper or on the back of the worksheets, list or draw any potential earthquake hazards that are found in your home but are not on the list.
- d. Bring your completed worksheets back to class.

5. Conduct a classroom discussion about the hazards that students found in their homes. Especially discuss hazards they identified that were not on the list. You may want to use transparencies of the home hazard worksheets during your discussions.

6. Explain to students that now that they have identified earthquake hazards in their homes they can take action to reduce their danger. Emphasize that there are some actions they can take which cost little or no money, while other actions will cost quite a bit and will have to be done by adults.

7. Distribute copies of the Quake-Safe Home Checklist (Master 44) to students. Discuss the items on the list. Determine which changes can be made easily and which will be more difficult. Again, emphasize that this list does not include everything that can be done to make a home safer.

8. Have students take the list home to discuss with their families. Families may decide which changes could be made immediately in their homes and which ones will have to wait. Encourage students to help their parents in any way possible to make the changes that can be made. As you did in Activity One, remind students that they will have to be responsible for avoiding the hazards they cannot remove.

9. You may want the children to bring back the completed checklists so they can have a follow-up discussion in class.

Activity Three: Community Hazard Hunt

Materials for the teacher

- Transparencies made from Master 45, Neighborhood Hazard Hunt
- Overhead projector
- Transparency marker

Materials for each student

- Handouts made from Master 45, Neighborhood Hazard Hunt
- Crayons or colored pencils
- Handouts made from Master 46, Safety Rules for Shoppers
- (Older students) Handouts made from Masters 47a, b, and c, Community Hazard Hunt

Procedure

1. Review materials from Unit Four about ways in which ground shaking from earthquakes can damage buildings. Remind students that the movement of the ground during an earthquake seldom causes death or injury. Most deaths and injuries from earthquakes are caused by falling debris from damaged buildings.

Building damage can include:

- Toppling chimneys
- Falling brick from walls and roof decorations, such as parapets and cornices. (Show pictures or draw pictures of these decorations; or if they're attached to your school building, point them out to the students.)
- Collapsing exterior walls, falling glass from broken windows.

Damage inside the building can include:

- Falling ceiling plaster and light fixtures
- Overturned bookcases (Have students mention some of the hazards they discovered in Activities One and Two.)

cor • nice

The exterior trim of a structure at the meeting of the roof and wall

par • a • pet

A part of a wall which is entirely above the roof.

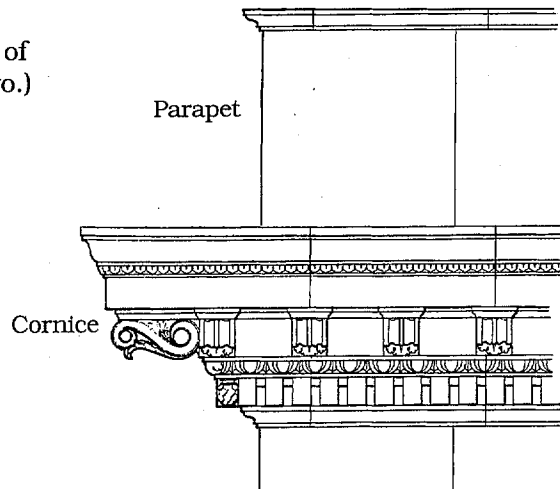

In the community, earthquake ground shaking can cause:

- Downed power lines
- Damage to bridges, highways, and railroad tracks
- Flooding from dam failures, damage to reservoirs and water towers
- Fires from spilled gasoline and other chemicals
- Liquefaction and landslides
- Water sloshing in ponds, pools, etc.
- Tsunami (in coastal areas)

2. Sum up: There are many things in our environment that could cause us harm during an earthquake. There will be many hazards that we cannot correct, but identifying these hazards will help us to anticipate them and avoid danger and injury.

3. Distribute copies of Master 45, Neighborhood Hazard Hunt.

4. Use an overhead of Master 45 and ask students to use red pencils to circle everything they see that could come loose and cause damage during an earthquake. Share and discuss answers.

5. Distribute copies of Master 46, Safety Rules for Shoppers. Discuss the rules in class then ask students to take the page home and share it with their families.

6. For older students: Distribute copies of Masters 47a, b, and c, Community Hazard Hunt. Challenge students to identify the hazards. Follow up with a class discussion.

IMPORTANT NOTE: This unit is intended to be used by all the grades, kindergarten through sixth. Feel free to modify the materials and procedures to suit your students.

Part 3: Prepare and Share

Content Concepts

1. Students can increase their chances for safety and survival in an earthquake by having essential supplies assembled before they need them.
2. Students can help to assemble emergency kits of supplies for their classroom, home, and family vehicle.
3. Students can help to inform others about earthquake safety and survival.

Objectives

Students will

- demonstrate an awareness of responsibility for their own well-being and the well-being of others during an emergency.
- list items to include in classroom, home, and vehicle emergency kits.
- list uses for the kits in emergencies other than an earthquake.
- prepare an emergency kit for their classroom.
- take home lists of suggestions for home and vehicle kits.
- make posters illustrating what they have learned, and distribute them around the school and community.

Learning Links

Language Arts: Reaching consensus in a group, copying lists of kit materials, writing preparedness slogans

Social Studies: Sharing kit lists with families, discussing ways to inform the community about quake-safe actions, distributing posters

Art: Planning and decorating the classroom kit, making safety posters

Assessment

List three things you would want in your emergency kit, and explain why you want to include them.

Activity One: Brainstorming

Materials for the teacher

- Blackboard and chalk

Procedure

1. Review the earthquake hazard hunts in Part 2 of this unit to be sure students have a clear idea of the most common earthquake hazards.
2. Remind the students that they may have to evacuate their school, home, or other location after an earthquake. If this happens, they will want to have some essential items in a convenient place, ready to pick up and take.
3. Invite students to name some things they could *not* take with them if they had to leave their houses in a hurry. Take suggestions for only about five minutes keeping the mood light. This exercise should help young children, in particular, to see the difference between essential and nonessential items
4. Now invite students to name some thing they really need to have in order to live. Write suggestions on the blackboard or overhead. After food and water have been named, there will be differences of opinion on the remaining items. Remind students to choose things that can be easily carried and have more than one use.
5. Ask the class:
Which of these things should we have ready in the classrooms? (Make a classroom list.)
Which of them should we have at home? (Make a home list.)
Which of them should we have in the family car, van, or other vehicle? (Make a vehicle list.)
6. When the class has reached agreement on a number of items, invite them to brainstorm one more list: a list of emergencies other than an earthquake for which their list of supplies would be appropriate. Accept all answers and discuss them briefly.

Teacher Take Note: Taking an active role in preparedness will help students to deal with their natural and reasonable fear of earthquakes. Nevertheless, tears and anxieties are inevitable, even among older children who have learned to hide their emotions. Express your own concerns openly, and let students know that it's normal to be afraid.

Activity Two: Create a Kit

Materials

- Inexpensive backpack or other ample container with shoulder straps
- Art supplies
- Writing paper and pencils
- Items for the kit (will vary)

Procedure

1. Tell students that they are going to assemble an easy-to-carry kit which can be kept in the classroom for emergencies. Ask them to suggest appropriate containers, or show them an inexpensive backpack obtained for this purpose.

2. Invite students to identify essential items for the classroom kit. Emphasize that the kit must be "easy to carry." Write their suggestions for a final list on the blackboard.

Essential items for the kit will include:

- bottled water and cups (Use plastic containers to cut weight, avoid breakage.)
- class roster with students names and addresses
- first aid checklist and supplies
- flashlight and spare batteries

Other items might include:

- pocket transistor radio and spare batteries
- paper and pens
- permanent marker
- colored flag to summon aid
- playing cards and pocket games
- hard candy and other compact, durable foods
- trash bags (for raincoats, ground cloths, etc.)

Teacher Take Note: Students might visit local businesses to request donations of the pack itself and its contents. This would be a way to involve the community in earthquake preparedness.

3. Divide the class into teams and assign responsibilities to each team. Roles might include:
 - a. **Decorators:** design and produce a logo or other distinctive decoration and fasten it to the kit.
 - b. **Listmakers:** copy the class list from the board or overhead (see Part 3, Activity One, Step 5) neatly and with correct spelling, and fasten it to the inside or outside of the container as a checklist. Also provide a copy to the suppliers.
 - c. **Suppliers:** decide which items on the list are already in the classroom, which will have to be purchased, and which can be brought from home. With the teacher's help, arrange for supplies to be bought or brought.
4. Invite the school nurse or someone from the Red Cross or the Fire Department to visit the classroom and discuss first aid procedures. After this visit the students may want to assemble a small medical kit and add it to their emergency supplies.
5. When the kit is completed, decide where to keep it. Explain that the teacher will carry the kit during evacuation drills or actual evacuations.

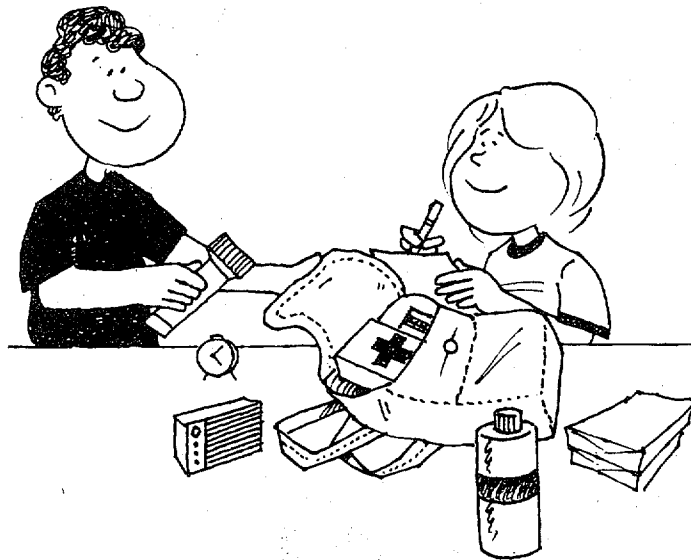

Activity Three: Poster Party

Materials for each small group

- Poster board
- Art supplies
- Pencils and scrap paper for rough drafts

Safety Chant

If inside, drop and cover.
That's where you'll be safe.
If outside, stay outside.
Find an open space.

Procedure

1. Read the chant to your class. Repeat the chant with the whole class several times, then ask students to create hand motions to accompany it. Suggest combinations of clapping, finger snapping, and patting on legs. As individual students work out their own rhythmic combinations, encourage them to demonstrate to the class so all can learn the same motions.

2. Tell students that now that they have learned a great deal about earthquakes and earthquake preparedness, they have a responsibility to share their knowledge. One way of doing this is to make a set of posters and put them in places where they will be seen. Each poster would feature the word Earthquake and a reminder of some quake-safe action. Ask them to suggest appropriate slogans. These might include:

Where's Your Emergency Kit?

Drop and Cover

If Outside, Stay Outside

Keep Calm--Self Control is Contagious

After the Quake, Evacuate

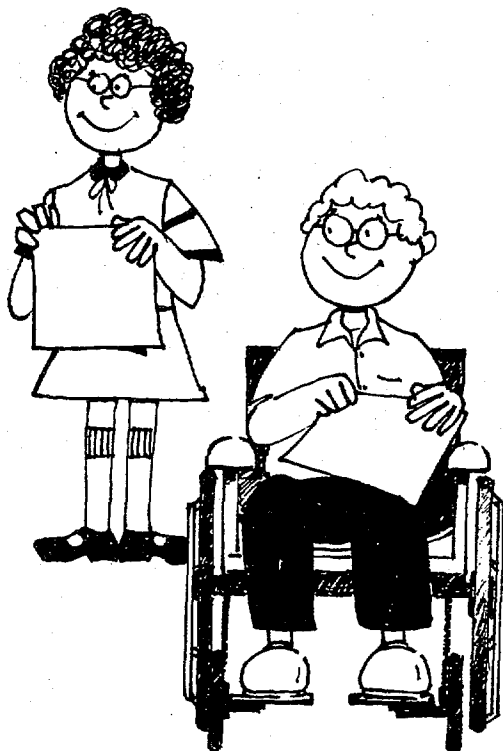

3. Divide students into small groups, and have each group agree on the slogan they want to illustrate.
4. Distribute materials. Suggest that each group work out a rough version of their poster first, allowing everyone to have input into the design. If necessary, suggest ways for group members to share the execution of the poster: perhaps one student lettering, one sketching the design in pencil, and another painting.
5. When the posters are finished, discuss places to display them other than the classroom. Placing them in the hallways or the cafeteria would spread the message to other grades.
6. Encourage students to take on the role of teacher and help their families learn how to take care of themselves. Many adults believe there is nothing they can do to protect themselves. This belief stems from lack of knowledge. We can't do anything to prevent earthquakes, but we can learn to increase our safety. We can help ourselves and others to do many things that will make our homes and schools safer.

Extension

Students might make arrangements to display some of the posters in stores, libraries, and other public places.



IMPORTANT NOTE: This unit is intended to be used by all the grades, kindergarten through sixth. Feel free to modify the materials and procedures to suit your students.

Part 4: Evacuation Drill

Content Concepts

1. Students can cope with hazards during evacuation.
2. Students are first responsible for their own safety, but also can help if others are injured.
3. After an earthquake, students can cope with the disturbed environment and their own emotional reactions.

Objectives

Students will

- identify hazards they might find during evacuation.
- describe ways of helping others who are injured during earthquakes.
- describe feelings they might have and dangers they might face after an earthquake.

Learning Links

Language Arts: Writing and reading hazard descriptions, discussing hazards and coping strategies, discussing and writing (older children) about what happens after an earthquake.

Social Studies: Practicing Drop and Cover and evacuation procedures, discussing responsibility for one's own safety in an emergency, and what can be done for others.

Assessment

Draw a person you saw doing something helpful after an earthquake.

Activity One: Get Ready, Get Set

Materials for teacher and students

- Materials and procedure for earthquake drill, Transparency of Master 39, Drop and Cover
- Overhead projector
- Index cards

Procedure

1. Review classroom earthquake drill procedures with students and have them practice **Drop and Cover**. You may choose to do the drill without using the simulation script (Master 38) this time.
2. Take the class to the cafeteria and school library and discuss quake-safe actions to take in each of these settings. Have the children demonstrate those actions.
3. Tell students that during an earthquake it's important to stay where they are and take immediate quake-safe action. After the ground stops shaking, students will check themselves and their neighbor; and listen quietly for instructions. Explain some of the hazards that may exist even after the major quake has passed, including aftershocks, fires, live electrical wires, and fumes.

Teacher Take Note: Point out to students that as they are evacuating, the most dangerous places are directly under and next to the exterior doors. Therefore, students should move swiftly beyond this area. Check to be sure your open-space assembly area is safe. It should be away from electrical wires, metal fences, buildings, underground utility lines. Your school custodian will help you locate the latter.

Earthquake Safety Reminders for Students

If you're inside:

- Crouch under a desk or table,
- Face away from windows,
- Bend your head close to your knees,
- Use one hand to hold onto the table leg (approximately 6" from the floor to avoid pinching fingers) and protect your eyes with the other hand.

If no desk or table is nearby:

- Kneel against an interior wall
- Face away from windows,
- Bend your head close to your knees,
- Clasp hands on the back of your neck.

If you're outside

- Stay outside.
- Go to an open area away from hazards.

fore • shock

A foreshock is an earthquake which comes before the main quake and is less severe.

af ter • shock

An aftershock is an earthquake which follows a major quake and is less severe.

4. Walk the class through your regular fire drill route to an open area outdoors that you have chosen in advance. Ask students to make mental notes as they go along of things that might become hazards during an earthquake, and share their ideas when you reach your designated site. Write each appropriate suggestion on an index card. The list of possible hazards may include:

- power failure (Is there emergency lighting available?)
- halls or stairways cluttered with debris (Are there lockers or trophy cabinets along hallways that could fall and block your path?)
- smoke in the hallway
- an exit door that jams and will not open
- an aftershock (Students should stop walking immediately and begin Drop and Cover.)
- bricks, glass, and debris outside the doorway
- electrical wires fallen on the ground

5. Return to the classroom. Hand one of the students an index card with a description of a hazard. Discuss this hazard and its impact on evacuation. Continue handing out the cards, one at a time, until all the hazards have been discussed. Give students an opportunity to express ideas about how they can cope with the hazards and evacuate safely.

6. Explain to the class that if there is a strong earthquake, each student's first responsibility is his or her own safety. However, every student can learn what to do to help if someone else is injured. Present some "What if" questions for discussion. What would you do if:

A student or teacher were injured? (If someone is injured and can't walk, don't move the person unless there is immediate danger of fire or flooding. Instead, place a sturdy table carefully above the person to prevent further injury. Then go for help.)

Someone was cut by shattered glass and is bleeding? (Even the youngest child can learn to apply pressure to the wound.)

Someone is hit by a falling lamp or a brick? (If the person is conscious and able to walk, take him or her to an individual in charge of first aid. Even if the person appears to be unhurt, have someone stay nearby to report signs of dizziness or nausea.)

Activity Two: Put It All Together

Materials for teachers and students

- Chairs and other objects as needed to simulate earthquake obstacles
- Classroom emergency kit
- Paper and pencils
- Master 48, Drill and Evacuation Checklist

Procedure

1. Tell students that you are going to conduct an evacuation drill. Have them help you devise a way to simulate hazards (fallen lockers/cabinets) along the hallway before the drill.

2. Back in the classroom, library, or cafeteria, call out Earthquake! Students (and you) should take quake safe positions immediately, without any further direction. Remind students that a teacher or other adult may not be with them when an actual earthquake occurs.

3. After 45 seconds, while students remain in quake-safe position, briefly review the evacuation procedure. If it's cold, and students coats are in the room, instruct them to quietly and quickly pick up their coats before leaving the room. Ask students not to put the coats on until they are outside. If an aftershock occurs along the way, they may need to place them over their heads.

4. Give the instruction **Evacuate!**, and proceed through the building evacuation route. Take along your classroom emergency kit (See Part 3, Activity 2 of this unit).

5. When the class is assembled outside, take roll. Use the Drill and Evacuation Checklist on Master 48 to evaluate the procedure. If errors were made, plan with students to correct them, and repeat the drill if necessary. But remember to emphasize the students' successes, not their shortcomings.

6. If weather permits, continue this activity outdoors: if not, return to the classroom, but ask students to pretend they're still outside. Set the stage:

We have just experienced a strong earthquake. Every one of you knew what to do to protect yourself. Some of us received a few bruises, but no one was seriously hurt. We managed to evacuate the school building. We moved slowly because it was difficult to walk through the debris in the halls [and stairwells]. Now we're safely outside and wondering what will happen next.

Teacher Take Note: Physical reactions to an actual earthquake may include nausea and vomiting, or bladder and bowel incontinence. Even the simulation may trigger physical reactions in a few children. You may want to make discreet preparations to deal with this possibility.

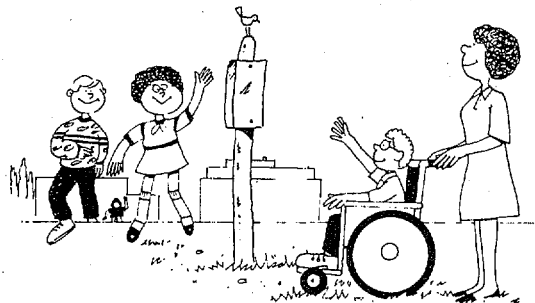

Teacher Take Note: Since we never know until the shaking has stopped which quakes are foreshocks or aftershocks and which is the main event, it is essential to Drop and Cover at the first sign of a quake.

Teacher Take Note: There is no guarantee that emergency medical or fire personnel will be available to your school immediately after an earthquake, local emergency teams will be severely overtaxed. It may be 24 to 48 hours before assistance arrives. Anticipating a delay in being reunited with their families and discussing ways of coping will help students deal with their feelings of separation and isolation.

Extensions

1. Distribute copies of Master 49, Home Earthquake Safety checklist. Encourage students to go over the list with their parents.
2. With older children, you may want to spend extra time discussing specific things they could do to assist in cleanup and repair work after an earthquake. However, be sure you also emphasize the limits to what young people can safely undertake, and the precautions they must observe, such as wearing shoes and sturdy gloves when sweeping up broken glass.

7. Lead a discussion with students which includes the following questions and considerations:

Our class is all together in the schoolyard. How do we feel? (It is normal to feel scared, worried, or physically sick, and to feel like crying or laughing. It helps to talk about how we feel.)

What could we do for ourselves and each other to help us feel better? (Take a couple of deep breaths to help ourselves stay calm. Hold hands or hug to comfort each other. Talk softly until we're asked to listen to instructions.)

Because we experienced a strong earthquake, we know there must be a lot of damage within our community. We can hear sirens from police cars, fire trucks, and ambulances. We can also hear horns honking, and imagine traffic jammed up all over town.

It may take a long time for parents to get to school. How would you feel if you had to stay at school for many hours, or even for two or three days? (Children in emergency situations worry about being separated from parents. They're concerned about their parents safety and that of their friends and pets. Allow students to discuss these concerns.)

What are some things we can do to help care for each other and keep busy? (Older students might want to help take care of younger ones from other classes. Perhaps they can think of appropriate activities.)

When you get home, what are some jobs you can do to help clean up and get things back to normal? (Discuss some of the dangers and how to work safely. Specific guidelines will be up to parents.)

How can we prepare for aftershocks? (Stress the Drop and Cover procedure once again, and review the hazard checks from Part 2 of this unit.)

8. Have students write a story or draw a picture sequence about "What I Did After the Earthquake."

Evacuation Guidelines for Teachers

The teacher makes the decision to stay put, evacuate, or delay evacuation based on the school policy and his/her evaluation of the situation. Communication systems may be out, and no one else knows the situation in the classroom like the teacher. Immediately after the ground stops shaking, the teacher makes a quick assessment of the situation in the classroom. Any of the following require immediate evacuation: fire, damage to structure, or hazardous materials spill. The teacher makes a quick assessment of injuries to students. Unless there is a fire, severe damage to structure, or hazardous materials spill, the teacher uses first aid for critical injuries. The teacher checks with his/her buddy teacher. It may be necessary to evacuate that teacher's class also. The teacher takes a quick look at the evacuation route from the classroom to be sure that it appears clear. In most cases, the teacher will wait until composure has been reached before directing the class to evacuate. The goal is a safe evacuation -- which is not necessarily the quickest possible evacuation.

In some situations, there are good reasons for either not evacuating, or delaying evacuation. For example, if there is a slight shaking with no apparent damage, it may be more dangerous to move the students outside because of severe weather.

Unit V. Earthquake Safety and Survival

Materials List

Grades K-6

crayons or colored pencils
backpack
art supplies
items for safety kit
poster board
paper
classroom emergency kit
index cards
overhead projector
transparency markers
pencils or pens



Earthquake Simulation Script

Imagine that you hear a low, rumbling sound. The noise builds, getting louder and louder. Then WHAM! There's a terrific jolt. You feel like someone suddenly slammed on the brakes in the car, or like a truck just rammed into the side of the building. You hear someone say...

Earthquake! Drop and cover.

The floor seems to be moving beneath you. You might feel like you're riding a raft down a fast river. The building is creaking and rattling. Books are falling from the bookcase. Hanging lamps and plants are swaying. Suddenly a pot falls to the floor and smashes. A windowpane just shattered, and glass is falling to the floor. The table is sliding, you hold on to it and move with it.

Pictures are moving on their nails. One just fell off the wall and crashed to the floor. The lights begin to flicker on and off... the lights just went out! Now the door swings back and forth on its hinges. Bang! It slams shut.

[a few moments of silence]

The building is still now. The alarm is still wailing. In the distance you can hear helicopters flying overhead. In the distance you hear sirens from police cars and fire engines.

Please remain quiet. You may come out from under your desk. Check yourself and your neighbor to make sure you are both unhurt.

[roll call optional]

When it is safe to leave the building, I am going to lead you outside to an open space. Stay together, and be ready to take cover again at any moment because the shaking may start again. Be prepared for after-shocks after the earthquake has stopped.

Drop, Cover and Hold

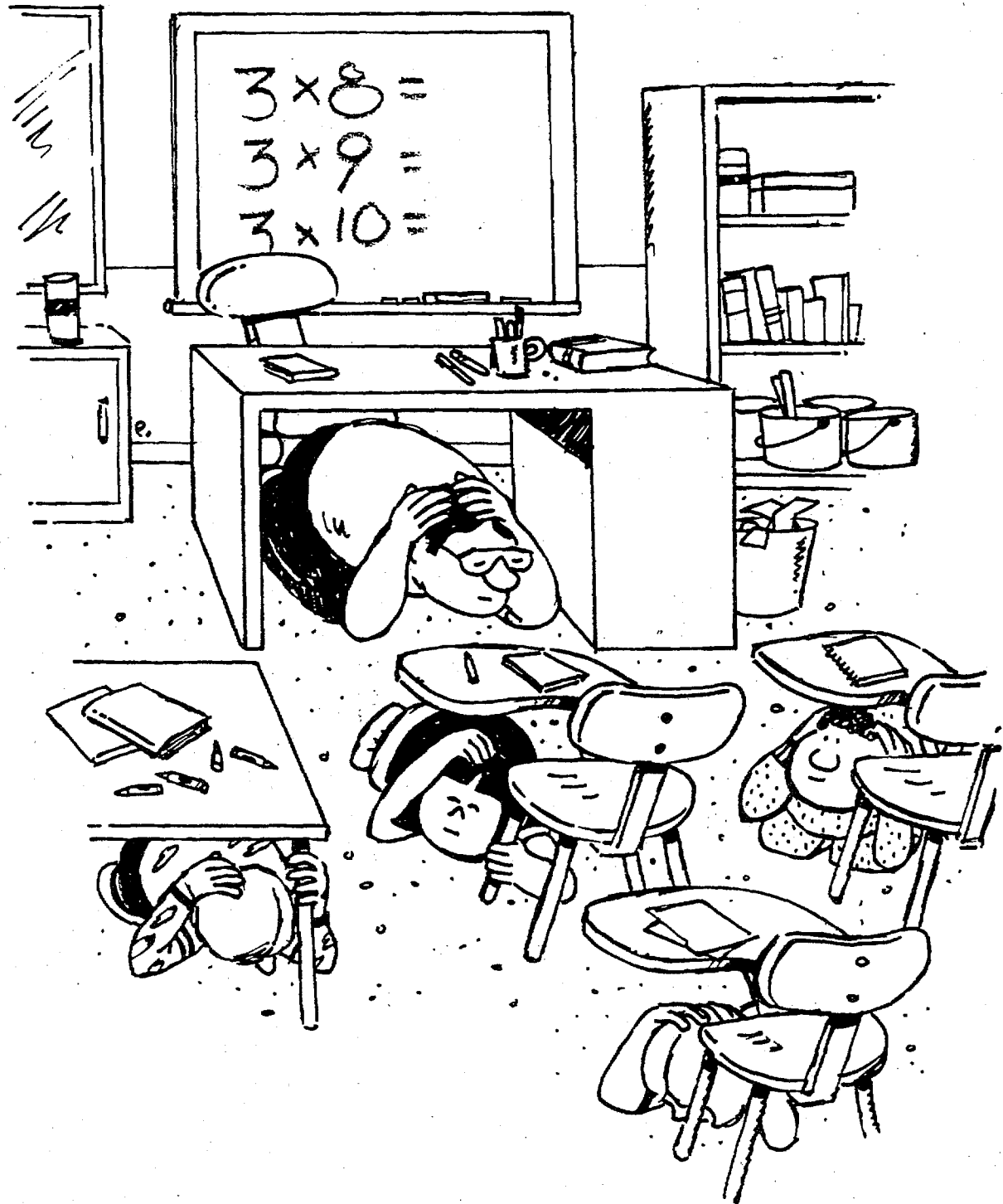

Coalinga Schools Report

At 4:42 p.m. on Monday, May 2, 1983, an earthquake registering 6.5 on the Richter scale struck the Coalinga area. Seconds later there was an aftershock of 5.0 Richter magnitude.

Coalinga has three elementary schools, one junior high, and one high school, serving approximately 1,900 students. The school buildings were constructed between 1939 and 1955. They contain 75 classrooms, plus gymnasiums, auditoriums, libraries, and multipurpose rooms.

Superintendent Terrell believes that death and serious injury would have occurred if school had been in session. The following is an account of the nonstructural damage to these schools:

Windows

Large windows received and caused the most damage. The 31-year-old junior high library had glass windows approximately 2.40 m X 3.04 m (8 X 10 ft.) on the north and south walls. The glass was not tempered. All windows imploded and littered the room with dagger-shaped pieces of glass. Floor tiles and wooden furniture were gouged by flying splinters.

Lighting Fixtures

Approximately 1,000 fluorescent bulbs fell from their fixtures and broke. All of the fixtures in the elementary schools came down, and many in other buildings. None of the hanging fixtures had safety chains. Glass in the older recessed fixtures was shaken out and broken.

Ceilings

Improperly installed T-bar ceilings came down. Glued ceiling tiles also fell, especially around vent ducting and cutouts for light fixtures.

Basements and Electrical Supply

Water pipes which came into the buildings through concrete walls were severed by the movement of the walls. Basements were flooded to five feet.

Since all electrical supply and switching mechanisms for these buildings were in the basements, all of them were destroyed by water.

Chemical Spills

In the second-floor high school chemistry lab, bottles of sulfuric acid and other chemicals stored in open cabinets overturned and broke. Acid burned through to the first floor. Cupboard doors sprang open and glass cabinet doors broke, allowing chemicals to spill. Because there was no electric ventilation, toxic fumes permeated the building.

Furnishings and Miscellaneous Items

File cabinets flew across rooms; freestanding bookcases, cupboards, cabinets, and shelves fell over.

Machine shop lathes and presses fell over.

Typewriters flew through the air.

Metal animal cages and supplies stored on top of seven-foot cabinets crashed to the floor.

Movie screens and maps became projectiles.

Storage cabinets in the high school had been fastened to the wall with molly bolts, but they were not attached to studs. They pulled out of the wall and fell to the floor with their contents.

(Based on a report prepared by E. Robert Bulman for Charles S. Terrell, Jr., superintendent for schools for San Bernadino County, California)

Fourth Grade Classroom

Name _____

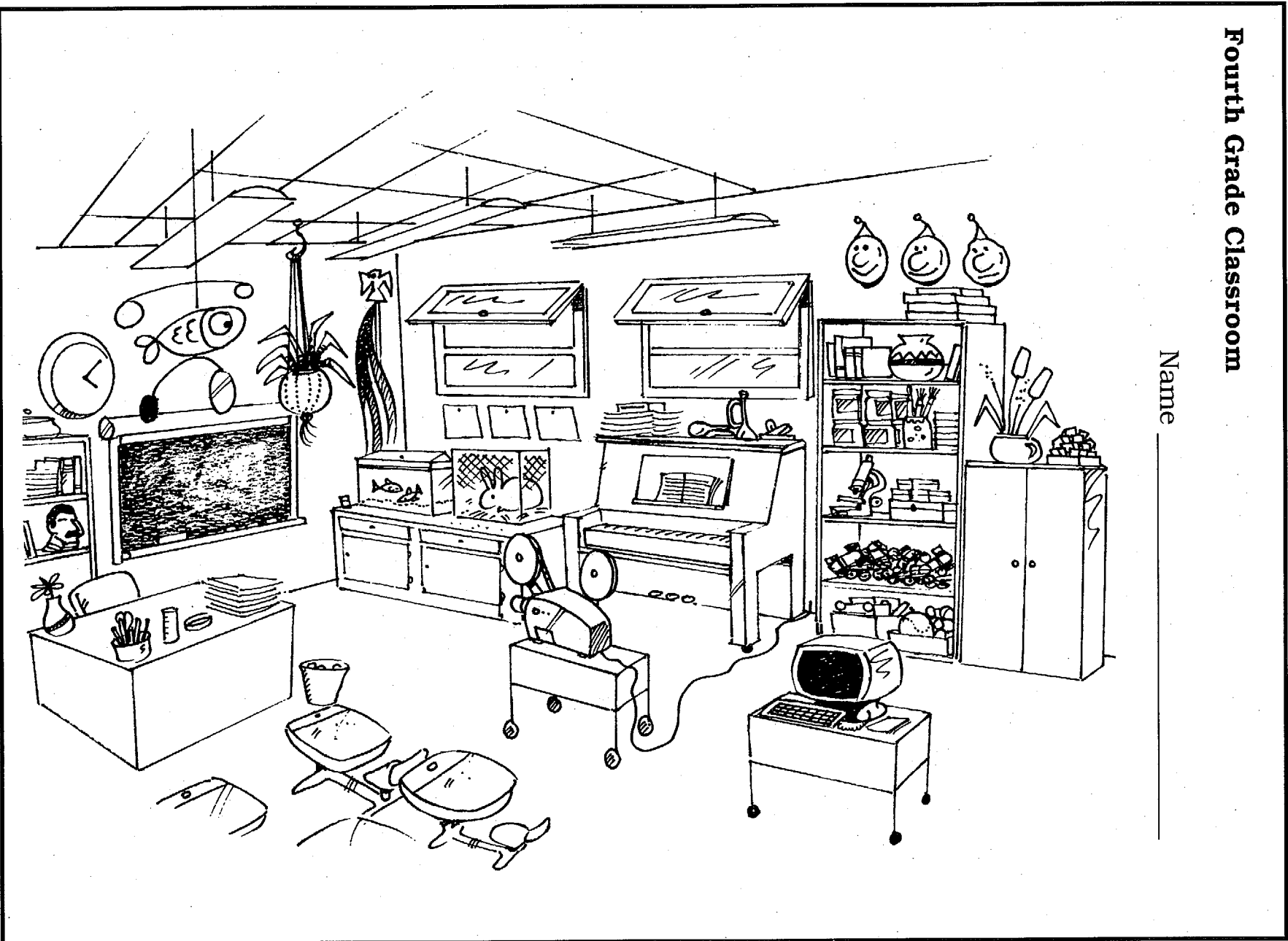

Classroom Hazard Hunt

Name _____

Check box if YES

- 1. Free-standing cabinets, bookcases, and wall shelves are secured to structural support
- 2. Heavy objects are removed from shelves above the heads of seated students.
- 3. Aquariums and other potentially hazardous displays are located away from seating areas.
- 4. The TV monitor is securely fastened to a stable platform or it is attached securely to a rolling cart with lockable wheels.
- 5. The classroom piano is secured against rolling during an earthquake.
- 6. Wall mountings are secured to prevent them from swinging free during an earthquake.
- 7. All hanging plants are in lightweight, unbreakable pots and fastened to closed hooks.

Home Hazard Hunt Worksheet

Name _____



1. china cabinet

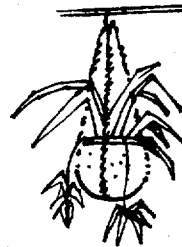

5. hanging plant

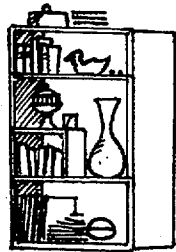

2. tall knickknack shelves



6. mirror on wall

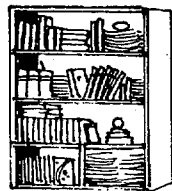

3. bookshelves



7. heavy objects on wall shelves

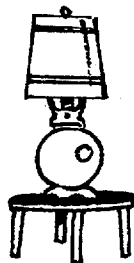

4. tall, heavy table lamp

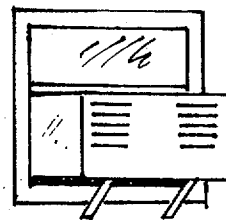

8. window air conditioner

Home Hazard Hunt Worksheet

Name _____

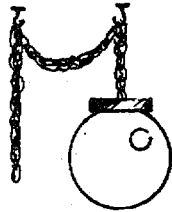

9. hanging lamp or chandelier

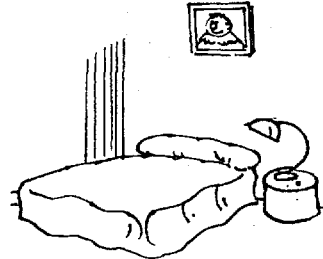

13. heavy picture above bed

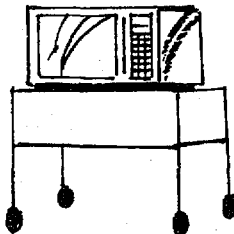

10. unsecured TV on cart with wheels

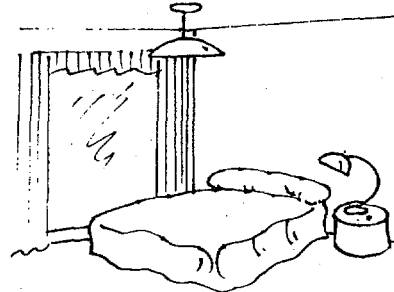

14. hanging light above bed

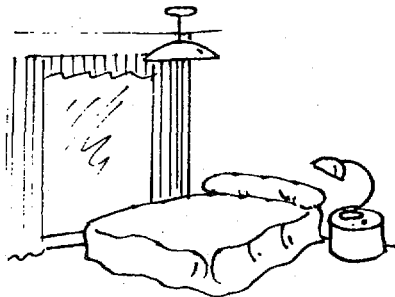

11. bed by big window

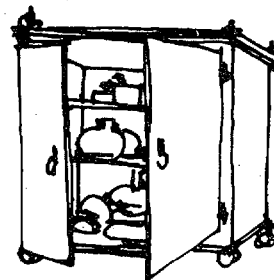

15. cabinet doors not fastened

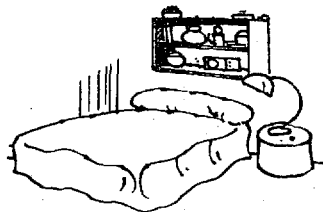

12. heavy objects on shelves above bed

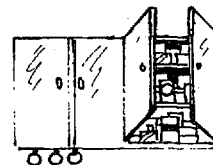

16. medicine cabinet doors not fastened

Home Hazard Hunt Worksheet

Name _____

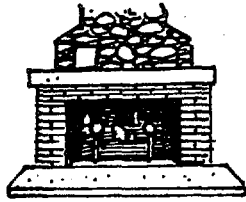

17. fireplace bricks



20. gas stove with rigid feed line



18. unattached water heater

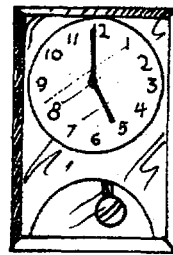

21. heavy wall clock

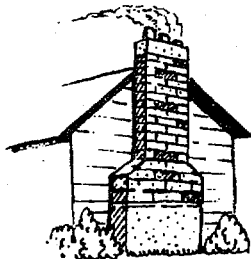

19. chimney

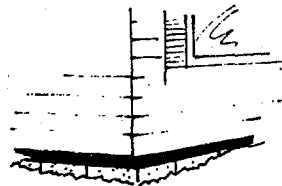

22. house not bolted to foundation

Quake-Safe Home Checklist

Name _____

- 1. Place beds so that they are not next to large windows.
- 2. Place beds so that they are not right below hanging lights.
- 3. Place beds so that they are not right below heavy mirrors.
- 4. Place beds so that they are not right below framed pictures.
- 5. Place beds so that they are not right below shelves with lots of things that can fall.
- 6. Replace heavy lamps on bed tables with light, nonbreakable lamps.
- 7. Change hanging plants from heavy pots into lighter pots.
- 8. Used closed hooks on hanging plants, lamps, etc.
- 9. Make sure hooks (hanging plants, lamps, etc.) are attached to studs.
- 10. Remove all heavy objects from high shelves.
- 11. Remove all breakable things from high shelves.
- 12. Replace latches such, as magnetic touch latches on cabinets, with latches that will hold during an earthquake.
- 13. Take glass bottles out of medicine cabinets and put on lower shelves.
(PARENT NOTE: If there are small children around, make sure you use child-proof latches when you move things to lower shelves.)
- 14. Remove glass containers that are around the bathtub.
- 15. Move materials that can easily catch fire so they are not close to heat sources.
- 16. Attach water heater to the studs of the nearest wall.
- 17. Move heavy objects away from exit routes in your house.
- 18. Block wheeled objects so they cannot roll.
- 19. Attach tall furniture such as bookshelves to studs in walls.
- 20. Use flexible connectors where gas lines meet appliances such as stoves, water heaters, and dryers.
- 21. Attach heavy appliances such as refrigerators to studs in walls.
- 22. Nail plywood to ceiling joists to protect people from chimney bricks that could fall through the ceiling.
- 23. Make sure heavy mirrors are well fastened to walls.
- 24. Make sure heavy pictures are well fastened to walls.
- 25. Make sure air conditioners are well braced.
- 26. Make sure all roof tiles are secured.
- 27. Brace outside chimney.
- 28. Bolt house to the foundation.
- 29. Remove dead or diseased tree limbs that could fall on the house.

Neighborhood Hazard Hunt

Name _____

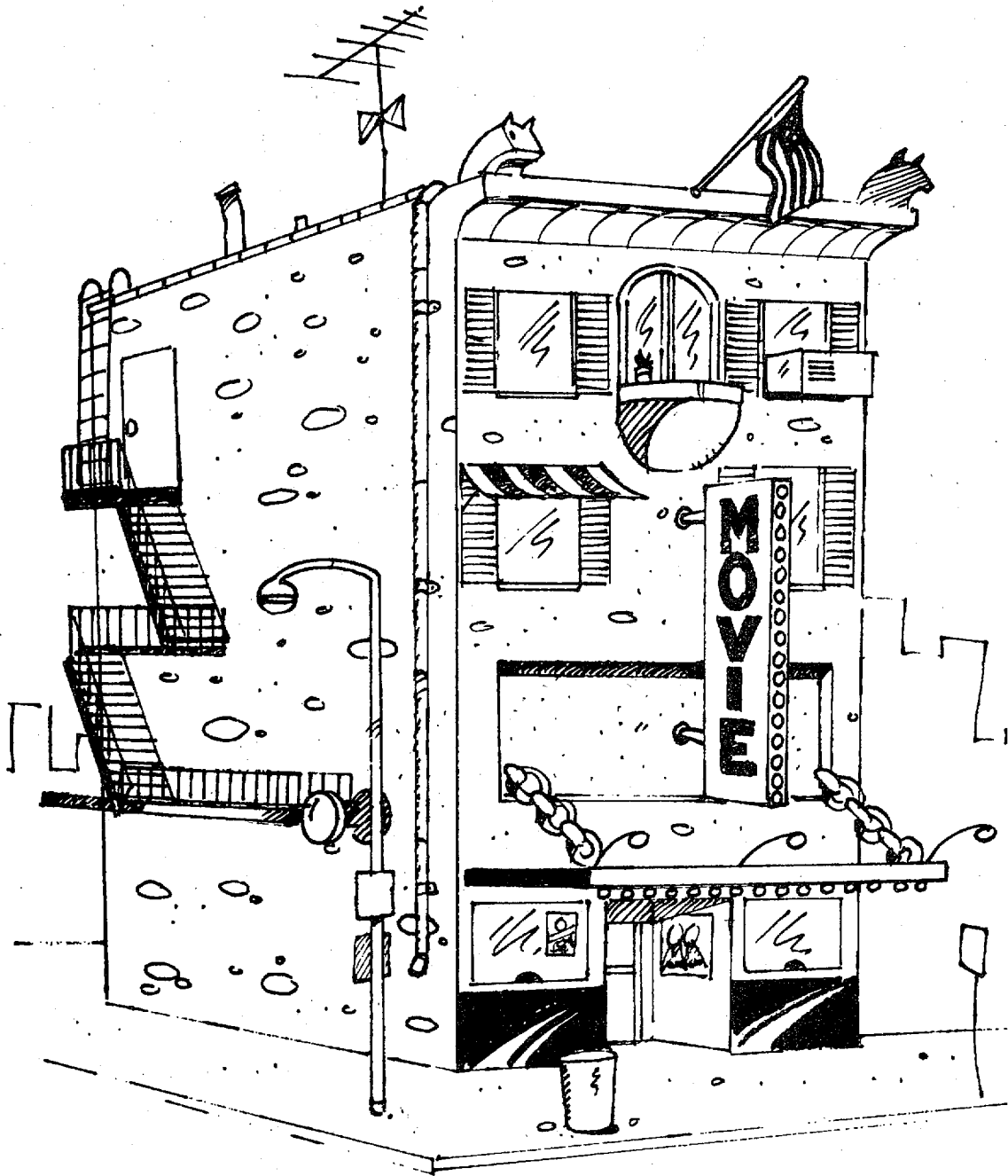

Safety Rules for Shoppers

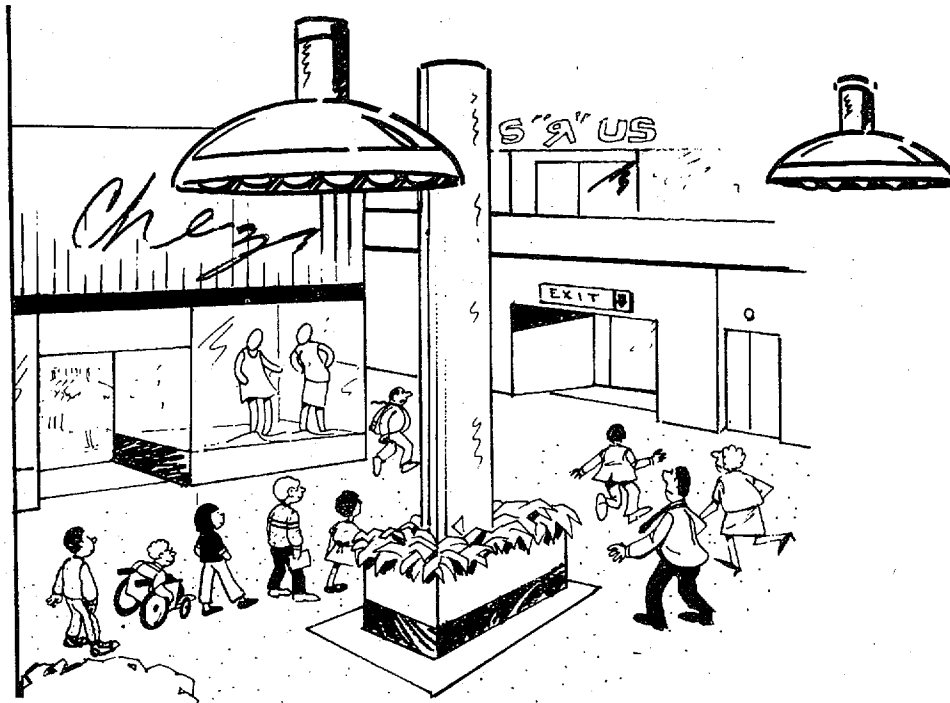

If an earthquake occurs while you are shopping:

1. Do not rush for exits or doors. Injuries occur when people panic and try to leave all at the same time.
2. Move away from windows.
3. Do not use elevators. The electricity may shut off suddenly.
4. Move away from shelves that may topple or could spill their contents when they fall.
5. Try to move against an inside wall.
6. **Drop and cover:**
Get under a table, counter, or bench.
Turn away from windows.
Put both hands on the back of your neck.
Tuck your head down.
If your shelter moves, hold onto the legs and travel with it.
7. After the shaking has stopped, calmly walk out of the building to a safe area outside, away from buildings.

Community Hazard Hunt

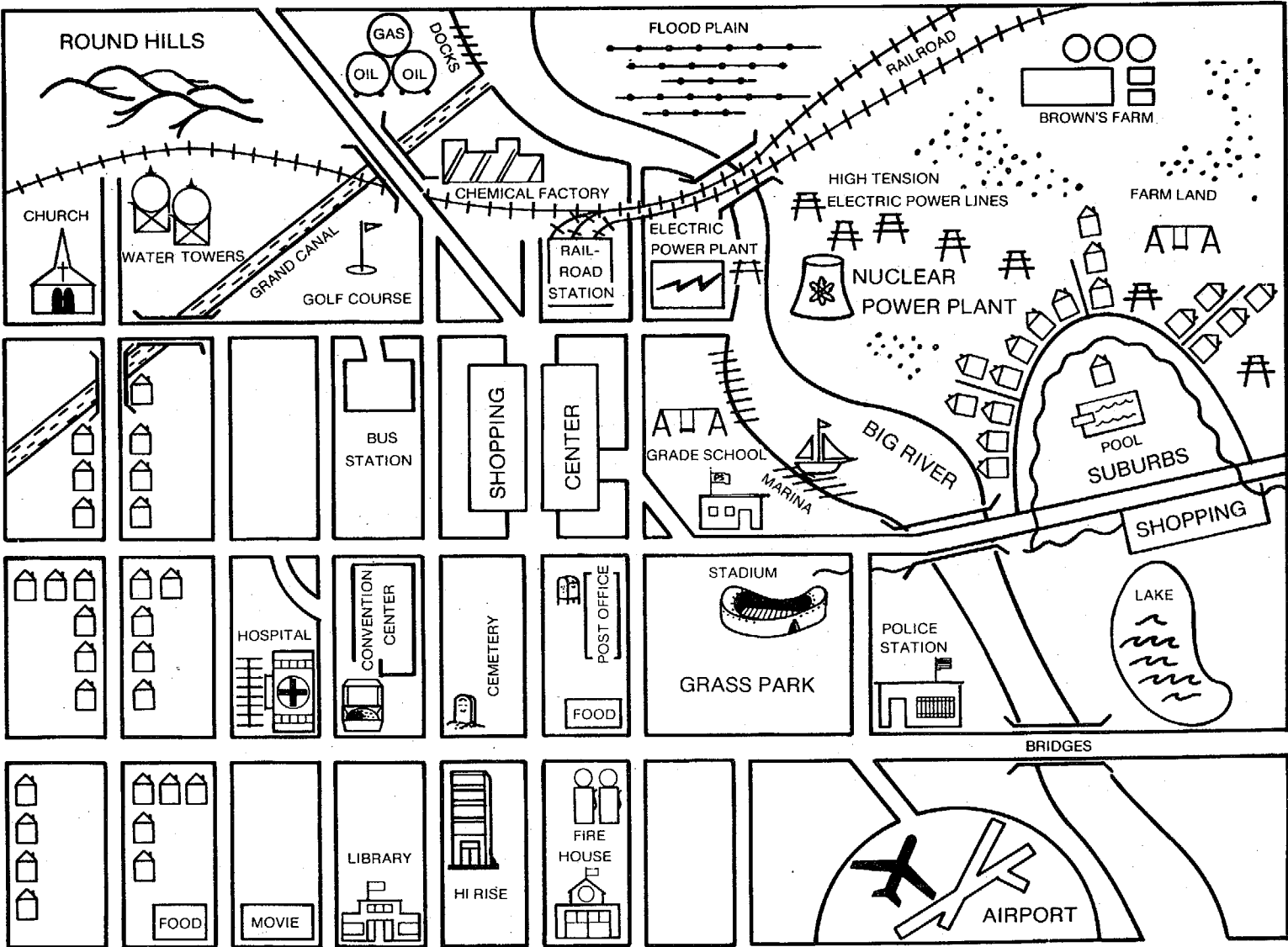

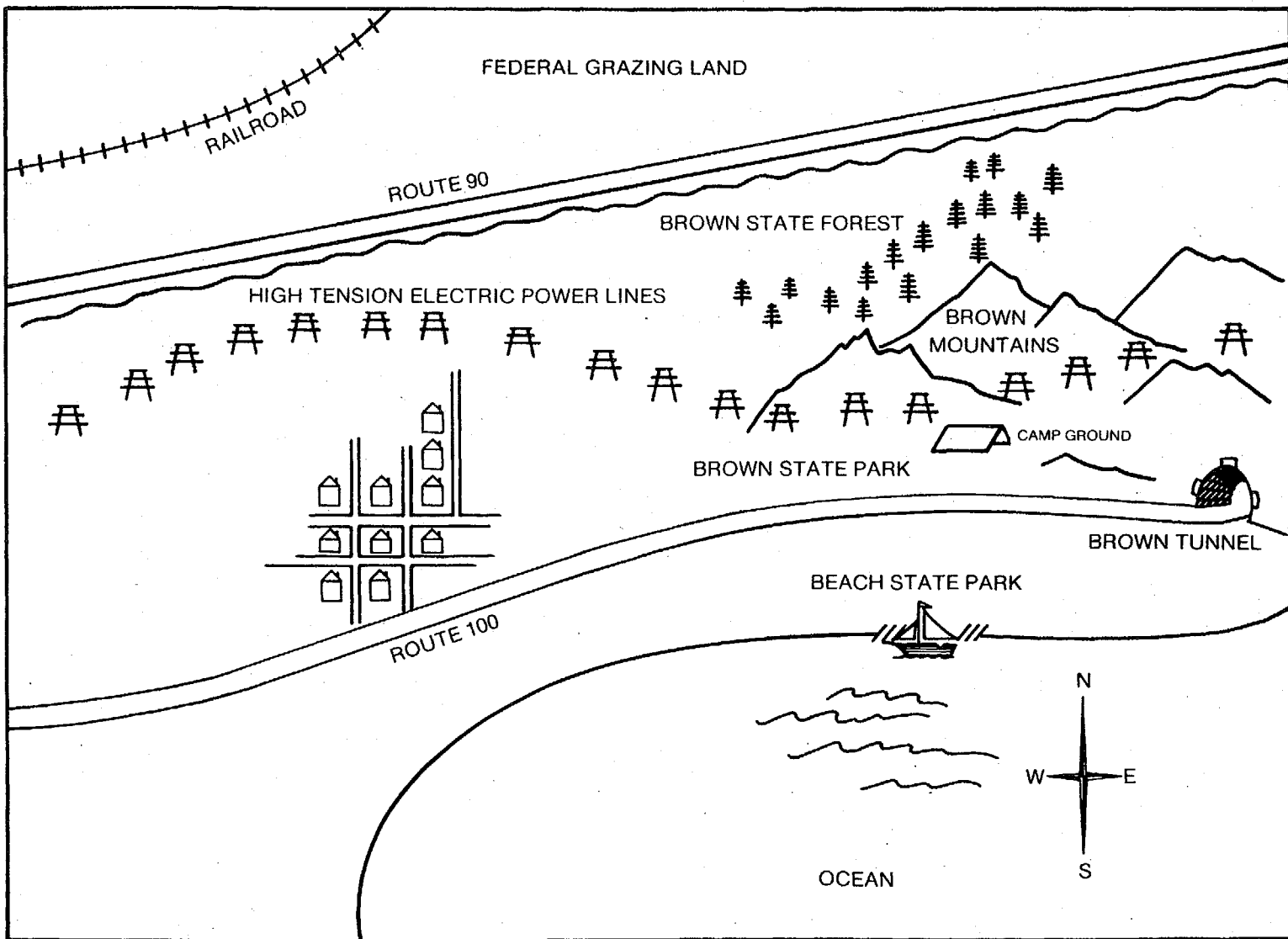



SWIMMING POOLS



FLOOD PLAIN

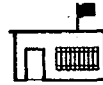

POLICE STATION



PARKING AREAS



GAS STATIONS



FOOD STORES



CAMP GROUND



STADIUM



GRADE SCHOOL



MAIN NATURAL GAS PIPE LINE



FAST FOOD

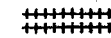

RAILROAD



OIL AND GAS STORAGE



HIGH TENSION ELECTRIC POWER LINES



LIBRARY

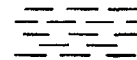

WATER CANAL



AIRPORT



BRIDGES



PLAYGROUND



HOUSES



CHURCH



FOREST

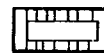

SHOPPING CENTER



WATER TOWER



FARM LAND



FIRE HOUSE



HOSPITAL

Drill and Evacuation Checklist

Check box if YES

- 1. Did everyone know what to do when told to Drop and Cover?
- 2. Did everyone follow the procedure correctly?
- 3. In the classroom, the library, or the cafeteria, was there enough space for all the students under desks, tables, or counters?
- 4. In the gym or in the hallways, were students able to take shelter away from windows, light fixtures, trophy cases, and other hazards?
- 5. Do students know how to protect themselves if they are on the playground during an earthquake? If they are in a school bus or a car?
- 6. Did everyone remain quietly in their safe positions for at least 60 seconds?
- 7. Did students with special needs participate in the drill and evacuation?
- 8. Did we remember to take our emergency kit and class roster when we evacuated the classroom?
- 9. Did everyone go to the safe outdoor area in an orderly way?
- 10. If we had to change our evacuation route to get to the safe area, did we make wise decisions?

Home Earthquake Safety

1. As a family, determine the safest spots in each room of your home: under heavy pieces of furniture such as tables or desks, in doorways (but be careful of doors slamming shut), and in inside corners.
2. Determine the danger spots in each room. These include any place near:

windows	bookcases
large mirrors	china cabinets
hanging objects	stoves
fireplaces	

If you're cooking, remember to turn off the stove before taking cover.

3. Discuss, then practice what to do if an earthquake happens while you're at home. (Children who have practiced safe procedures are more likely to stay calm during an actual earthquake.)

Drop and cover:

- Crouch in a safe place (See 1. above)
- Tuck your head and close your eyes.
- Stay covered until the shaking has stopped.

4. Determine an emergency evacuation plan for each room of your home.

Keep a flashlight with fresh batteries beside each bed, and shoes to protect feet from glass and other sharp objects.
5. Agree on a safe gathering place outside the house where all family members will meet after an earthquake.
6. Discuss as a family what needs to be done after an earthquake ends.

Reminders:

- Stay calm.
- Be prepared for aftershocks. These may be strong. Take cover if shaking begins again.

Parents Only:

- Check for injuries. Apply first aid as needed.
- Check for fires.
- Shut off electricity at main power, if you suspect damage. Don't turn on and off switches.
- Shut off gas valves, if there is any chance of a gas leak. Detect gas by smell, never by using matches or candles.
- Shut off water inside and out if breakage has occurred.

Appendix

A. Earthquake Background

B. Book of Legends

C. National Science Education
Standards Matrices

Earthquake Background

Earthquake Legends

Ancient peoples experienced the same natural disasters that can affect each of us. Among these were hurricanes, tornadoes, droughts, floods, volcanic eruptions, and earthquakes. Because they did not have scientific explanations for such catastrophes, ancient peoples invented folk narratives, or legends, to explain them. Such legends are part of the literature that we have inherited from many cultures. An examination of legends gives a small insight into the location and frequency of occurrence of major earthquakes.

Defining an Earthquake

Earthquakes are an especially noteworthy type of catastrophe because they strike suddenly, without clear warning, and can cause much panic and property damage in a matter of seconds.

An earthquake is a sudden, rapid shaking of the Earth caused by the release of energy stored in the Earth's crust. An earthquake occurs at a place, called the focus, which may be up to about 700 km deep in the Earth. The place on the Earth's surface that is directly above the focus is called the epicenter of the earthquake. It has long been known that earthquake epicenters often lie along narrow zones, or belts, of the Earth where mountain building and/or volcanic activity are also present. But earthquakes may also occur in seemingly "stable" areas like the central and eastern United States.

Plate Tectonic Theory and Earthquake Occurrence

According to the recently formulated (late 1960s) theory of plate tectonics, earthquakes occur because of the motion of the pieces of solid crust and upper mantle that form the 100 km-thick, outer rock shell of our planet. This shell, called the lithosphere, or rock sphere, is broken into major and minor pieces called plates.

There are seven to twelve major plates and a number of smaller ones. From a geophysical perspective the Earth is like a giant spherical jigsaw puzzle with its pieces in constant motion.

The reason for plate motion is unknown. Scientists speculate, however, that the internal heat of the Earth causes convection currents in the semimolten, mantle rock material beneath the plates. They suggest that this convective motion, driven by the Earth's internal heat, drives the plates. Such heat is believed to come from the decay of radioactive minerals in the mantle, which extends to a depth of 2,855 km below the Earth's surface.

Types of Plate Motion

The plates move, relative to one another, at between approximately 2 and 15 cm per year. Three types of plate motion are most important for understanding where and how earthquakes occur. Divergent plate motion occurs where the plates are moving apart. Such plate separation most often occurs along the mid-ocean ridges. As the plates separate, new ocean crust forms from mantle material by volcanic eruptions or fissure flows. Many shallow earthquakes result from separation of plates. Because these usually occur in the deep ocean, however, they are rarely of concern to humans.

Plates are moving toward each other in such places as around the Pacific Ocean basin, and the Mediterranean. This is called convergent plate motion. Where the leading edge of a plate is made of ocean crust and underlying mantle, the plate tends to sink under the edge of the opposing plate. Such motion is called subduction.

An oceanic trench is a common feature at plate boundaries where subduction is occurring, such as along the Pacific side of the Japanese or Aleutian island areas and the Pacific side of South America. As the subducting plate sinks into the mantle, it begins to melt. The resulting molten rock materials gradually rise toward the Earth's surface to form volcanoes and fissure flows of lava. Subduction results in many earthquakes with foci from near the Earth's surface to about 700 km below the surface. Some of these earthquakes are extremely violent.

Where the opposing plates are both made of continental material, their collision tends to raise mountain chains. The convergent motion of the continental masses of India and Southeast Asia began millions of years ago and continues into the present. The result is the Himalayan Mountains, which are still rising slowly and are being subjected to frequent earthquakes as the mountain building process continues.

The conservation of the area of the lithosphere is one of the important concepts that relates to the divergent and convergent activity of plates. That is, a worldwide balance exists between the creation of new lithosphere at the mid-ocean ridges and the destruction of the lithosphere along subduction zones. This allows us to picture the Earth as remaining relatively constant in size. Earlier explanations of folded and thrust-faulted mountain ranges incorrectly required that the Earth shrink in size as it cooled. The mountains were thought to rise as the lithosphere buckled, something like the shriveling of the skin on an apple as it ages.

In the third major type of plate motion, the edges of the plates slip past each other. This is called lateral (or transform) plate motion. The line of contact between the plates is a fault. The stresses involved in lateral plate motion actually cause rupturing and movement on faults some distance from the area of contact between the plates. Therefore, it is proper to speak of a fault zone when discussing rock movement caused by lateral plate.

One of the lateral faults best known in to North Americans is the San Andreas fault of California. The San Andreas and its associated faults extend from the Gulf of California to the Pacific coast north of San Francisco. Earthquakes occur frequently in the San Andreas fault zone. Some of them have caused loss of life and extensive property damage.

Mid-Plate Earthquakes

Many earthquakes occur at places far from plate boundaries. Some of them, like the New Madrid earthquakes of 1811-1812 and the Charleston earthquake of 1886, have been major historical disasters. Explaining such mid-plate earthquakes has been a challenge to the theory of plate tectonics outlined above. Recent research has shown, however, that the zones of instability within plates can produce earthquakes along intraplate fault zones which may be hidden at the Earth's surface. Because of the location of these fault zones and their infrequent activity, it is still difficult to assess the hazards they may pose.

Plate Tectonics, Faulting, and Topography

From the previous discussion, the origin of major topographic elements of the ocean floor become more apparent. Among these are the world-circling, 60,000 km-long mid-ocean mountain ranges, or mid-ocean ridges, and the trenches, whose depth below the ocean floor exceeds any chasm found on land. Plate motion also causes the folding and faulting of continental rocks and their uplift into mountains. Thrust faulting may accompany such mountain building. A thrust fault is one in which the upper block of rock slides over a lower block which is separated from it by the fault. Earthquakes occur at and near the fault surface, as the blocks of rock move relative to one another.

Normal faults occur where rock units are pulled apart allowing movement vertically under the influence of gravity. The result of normal faulting, on a continental scale, is the creation of long, deep valleys or the lowering subsidence of large pieces of coastal topography. A normal fault is one in which the upper block moves downward relative to the lower block which is separated from it by the fault. As in thrust faulting, earthquakes occur at and near the fault surface as the blocks of rock move relative to one another.

Lateral faults occur where plates are sliding past each other. A lateral fault is one in which the blocks of rock move in a predominantly horizontal direction past each other with the vertical, or near-vertical, fault surface separating them. In the ideal case, lateral faults do not cause much change in the elevation of the opposing blocks of rock. Rather, they move the existing topography to different locations. Earthquakes occur at and near the fault surface as the blocks move relative to one another.

Detecting Earthquakes

When rock units move past each other along normal, thrust, or lateral fault surfaces, or zones, the result is often an earthquake. Vibrations arise at the earthquake focus and travel outward in all directions. The vibrations travel through the upper part of the lithosphere and also penetrate the deeper shells of the Earth's structure. The waves that travel through the upper part of the lithosphere are called surface waves. Those that travel within the Earth are called body waves.

The two main varieties of surface waves are Love waves, which travel sideways in a snake-like motion, and Rayleigh waves, which have an up-and-down motion. Surface waves from a large earthquake travel for thousands to tens of thousands of square kilometers around the earthquake epicenter. They are primarily responsible for the shaking of the ground and damage to buildings that occur in large earthquakes.

Body waves are either P- (for Primary) waves or S- (for Secondary) waves. Regardless of the nature of the material through which they travel, P-waves are always faster than S-waves. The difference in the arrival times of the two types of body waves allows seismologists to locate the focus of an earthquake.

Instrumental Measurement of Earthquakes

One way to describe an earthquake is in terms of the amount of energy it releases. That energy is indicated by the strength of the surface and body waves that travel away from the earthquake focus. As simple as this principle may seem, it was not until the late 1800s that a machine (seismograph) to detect and record earthquake waves was invented by British scientists working in Japan. The most famous of these early seismographs was invented by John Milne, who returned to Great Britain to establish the field of seismology.

In modern observatories, seismograph instruments can measure the north-south, east-west, and vertical motion of the ground as the various types of seismic waves travel past. Each machine sends an electrical signal to a recorder which produces a highly amplified tracing of the ground motion on a large sheet of paper. This tracing is called a seismogram. Modern seismographs record data digitally, increasing the speed and accuracy of earthquake measurements.

The American seismologist Charles Richter used the amplitude of the body waves shown on seismograms to measure the amount of energy released by earthquakes. The scale which he created in 1935 is called the Richter Scale in his honor. It uses Arabic numerals to rate earthquake magnitudes. The scale is logarithmic and open-ended. That is, there is no lower or upper limit to the magnitude of an earthquake. However, the largest earthquake ever recorded had a Richter magnitude of 8.9. The Richter magnitude of an earthquake also can be measured from the amplitude of its surface waves.

In recent years seismologists developed a new magnitude scale called moment magnitude. The moment of an earthquake is a physical quantity (e.g., area of fault slip) which is related to the total energy released in the earthquake. Moment magnitude can be estimated in the field by looking at the geometry of the fault, or by looking at the record of the earthquake (seismogram). Moment magnitude is now preferred because it can be used to measure all earthquakes—no matter how large, small, close, or distant—at the same scale.

Intensity Measurement of Earthquakes

Even before seismographs came into common use, the effort to classify earthquakes by the damage they produce reached success through the work of the Italian seismologist Giuseppe Mercalli and other European scientists. The 1902 Mercalli scale was modified in 1931 by two American seismologists, H.O. Wood and Frank Neumann. In the Modified Mercalli scale, Roman numerals from I to XII are used to rate the damage, ground motion, and human impact resulting from an earthquake.

The intensity assigned to an earthquake is a relative measure. That is, the Modified Mercalli intensity at a given place depends on the distance from the earthquake epicenter as well as the geological structure of the area. For example, houses built on bedrock will receive less damage than similar houses built on sediment at the same distance from the earthquake epicenter. Poorly built structures will receive more damage than those reinforced to withstand earthquakes.

Earthquake Magnitude—The Size of an Earthquake

- m_L = *Local magnitude*, devised by Richter and Gutenberg to describe local (Southern California) earthquakes. This is the *Richter magnitude* reported often in newspapers.
- m_b = *P-wave or body magnitude*, determined using P-wave amplitude.
- m_s = *Surface-wave magnitude*, calculated using Rayleigh wave amplitude having a period approximately 20 seconds. The m_s is commonly-reported magnitude, superseding that of m_L .
- m_w = *Seismic moment magnitude*. Determined by taking into account rupture area, displacement, and rock strength. These values are obtained by analysis of seismograms, including wave amplitudes; and field observations.

Location and Earthquake Risk

Earthquakes tend to occur where they have occurred before. There also appears to be some periodicity to the recurrence of earthquakes, that is, some more or less regular interval between major quakes. Unfortunately, human memory and written records do not go back far enough to allow us to predict earthquakes accurately along any known fault. Of course, some faults lie hidden beneath sediment or rock cover and have not been active in recorded time. When an earthquake occurs on such a fault, it may come as a surprise to everyone.

Scientists are developing and refining techniques, such as measuring the change in position of rock along a fault, that may eventually result in an ability to predict the magnitude and date of an earthquake on a known fault. Meanwhile, it is prudent to assume that an earthquake could occur on any fault at any time. Even if an earthquake occurs on a fault that is tens or hundreds of kilometers away, the resulting vibrations could inflict serious damage in your local area.

What Should Be Done To Prepare for an Earthquake?

Weaker structures are more prone to damage than structures built to resist earthquake shaking. Luckily modern houses built with wooden framing are fairly resistant to serious damage in small to medium earthquakes. Most modern commercial buildings are now designed to resist wind forces and earthquake shaking.

Since earthquake shaking is possible almost everywhere in the United States, earthquake safety should be practiced by everyone, whether at home, at school, at work, or on the road.

After personal safety in an earthquake has been attended to, it may be necessary to lead, or join, citizen action groups that are concerned with the safety of the community infrastructure during and after an earthquake. Will the "lifelines" -- water, gas, electricity, phone and sewer lines -- survive the anticipated earthquake? Will the hospital and other emergency services be operating and adequate to handle emergencies created by the earthquake? Even California, where individuals and governments are sensitive to these questions, the answer seems to be "not completely." What is the status of earthquake preparedness where you live?

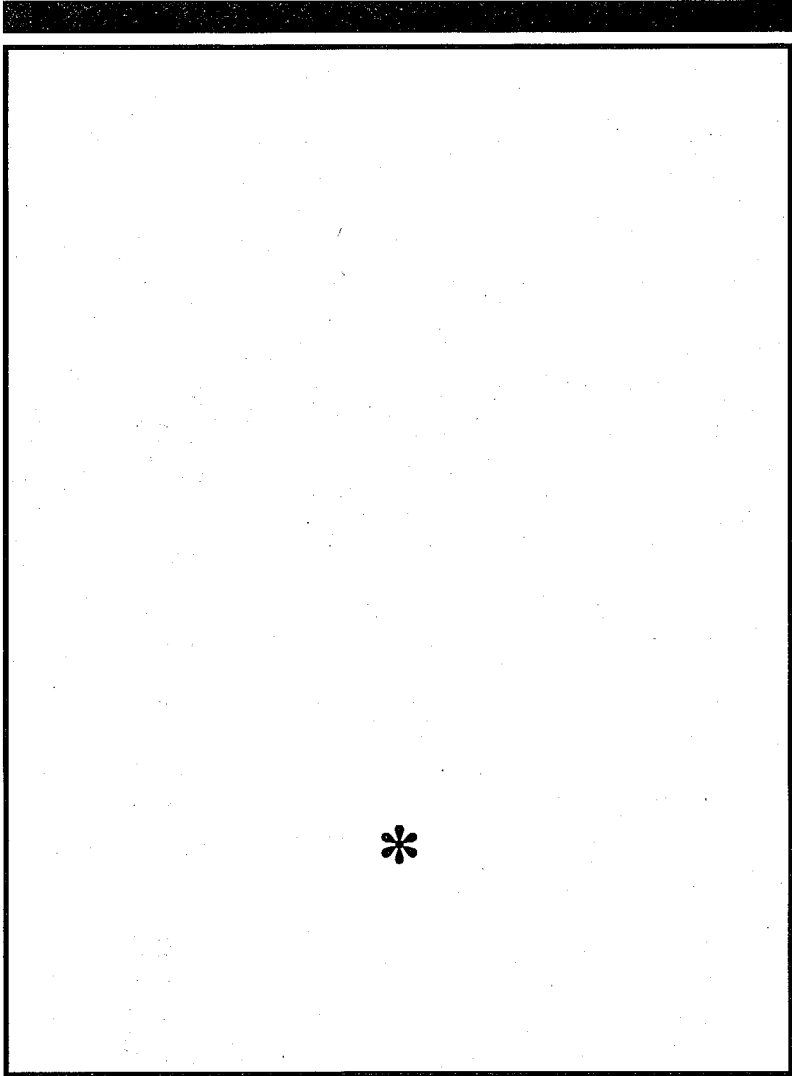

Earthquake Legends

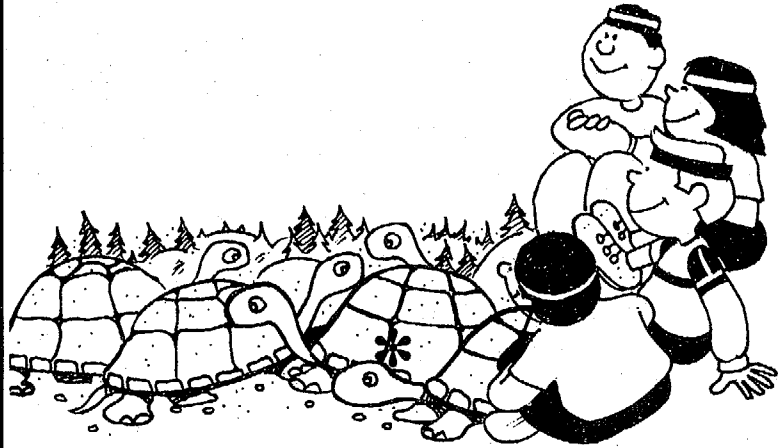

1. India

The Earth is held up by four elephants that stand on the back of a turtle. The turtle is balanced in turn on a cobra. When any of these animals moves, the Earth will tremble and shake.



20. West Africa

A giant carries the Earth on his head. All the plants that grow on the Earth are his hair, and people and animals are the insects that crawl through his hair. He usually sits and faces the east, but once in a while he turns to the west (the direction earthquakes come from in West Africa), and then back to the east, with a jolt that is felt as an earthquake.



19. Romania

The world rests on the divine pillars of Faith, Hope, and Charity. When the deeds of human beings make one of the pillars weak, the Earth is shaken.



2. Assam

(between Bangladesh and China)

There is a race of people living inside the Earth. From time to time they shake the ground to find out if anyone is still living on the surface. When children feel a quake, they shout "Alive, alive!" so the people inside the Earth will know they are there and stop the shaking..



3. Mexico

El Dia, the devil, makes giant rips in the Earth from the inside. He and his devilish friends use the cracks when they want to come and stir up trouble on Earth.



18. Central America

The square Earth is held up at its four corners by four gods, the Vashakmen. When they decide the Earth is becoming overpopulated, they tip it to get rid of surplus people.



17. East Africa

A giant fish carries a stone on his back. A cow stands on the stone, balancing the Earth on one of her horns. From time to time her neck begins to ache, and she tosses the globe from one horn to the other.



4. Siberia

The Earth rests on a sled driven by a god named Tuli. The dogs who pull the sled have fleas. When they stop to scratch, the Earth shakes.



5. Japan

A great catfish, or namazu, lies curled up under the sea, with the islands of Japan resting on his back. A demigod, or daimyojin, holds a heavy stone over his head to keep him from moving. Once in a while, though, the daimyojin is distracted, the namazu moves, and the Earth trembles.



16. New Zealand

Mother Earth has a child within her womb, the young god Ru. When he stretches and kicks as babies do, he causes earthquakes.



15. Scandinavia

The god Loki is being punished for the murder of his brother, Baldur. He is tied to a rock in an underground cave. Above his face is a serpent dripping poison, which Loki's sister catches in a bowl. From time to time she has to go away to empty the bowl. Then the poison falls on Loki's face. He twists and wiggles to avoid it, and the ground shakes up above him.



6. Mozambique

The Earth is a living creature, and it has the same kinds of problems people have. Sometimes it gets sick, with fever and chills, and we can feel its shaking.



7. Greece

According to Aristotle, (and also to Shakespeare, in the play called Henry IV, Part I) strong, wild winds are trapped and held in caverns under the ground. They struggle to escape, and earthquakes are the result of their struggle.



14. Colombia

When the Earth was first made it rested firmly on three large beams of wood. But one day the god Chibchacum decided that it would be fun to see the plain of Bogota underwater. He flooded the land, and for his punishment he is forced to carry the world on his shoulders. Sometimes he's angry and stomps, shaking the Earth.



13. Latvia

A god named Drebkuhls carries the Earth in his arms as he walks through the heavens. When he's having a bad day, he might handle his burden a little roughly. Then the Earth will feel the shaking.



8. Belgium

When people on Earth are very, very sinful, God sends an angry angel to strike the air that surrounds our planet. The blows produce a musical tone which is felt on the Earth as a series of shocks.



9. Tennessee, USA

Once a Chickasaw chief was in love with a Choctaw princess. He was young and handsome, but he had a twisted foot, so his people called him Reelfoot. When the princess' father refused to give Reelfoot his daughter's hand, the chief and his friends kidnapped her and began to celebrate their marriage.

The Great Spirit was angry, and stomped his foot. The shock caused the Mississippi to overflow its banks and drown the entire wedding party. (Reelfoot Lake, on the Tennessee side of the Mississippi, was actually formed as a result of the New Madrid earthquake of 1812.)

12. India

Seven serpents share the task of guarding the seven sections of the lowest heaven. The seven of them take turns holding up the Earth. When one finishes its turn and another moves into place, people on Earth may feel a jolt.



11. Mongolia

The gods who made the Earth gave it to a frog to carry on his back. When this huge frog stirs, the Earth moves directly above the part of him that moves: hind foot, head, shoulder, or whatever.



10. West Africa

The Earth is a flat disk, held up on one side by an enormous mountain and on the other by a giant. The giant's wife holds up the sky. The Earth trembles whenever he stops to hug her.



World Map with Legend Sites

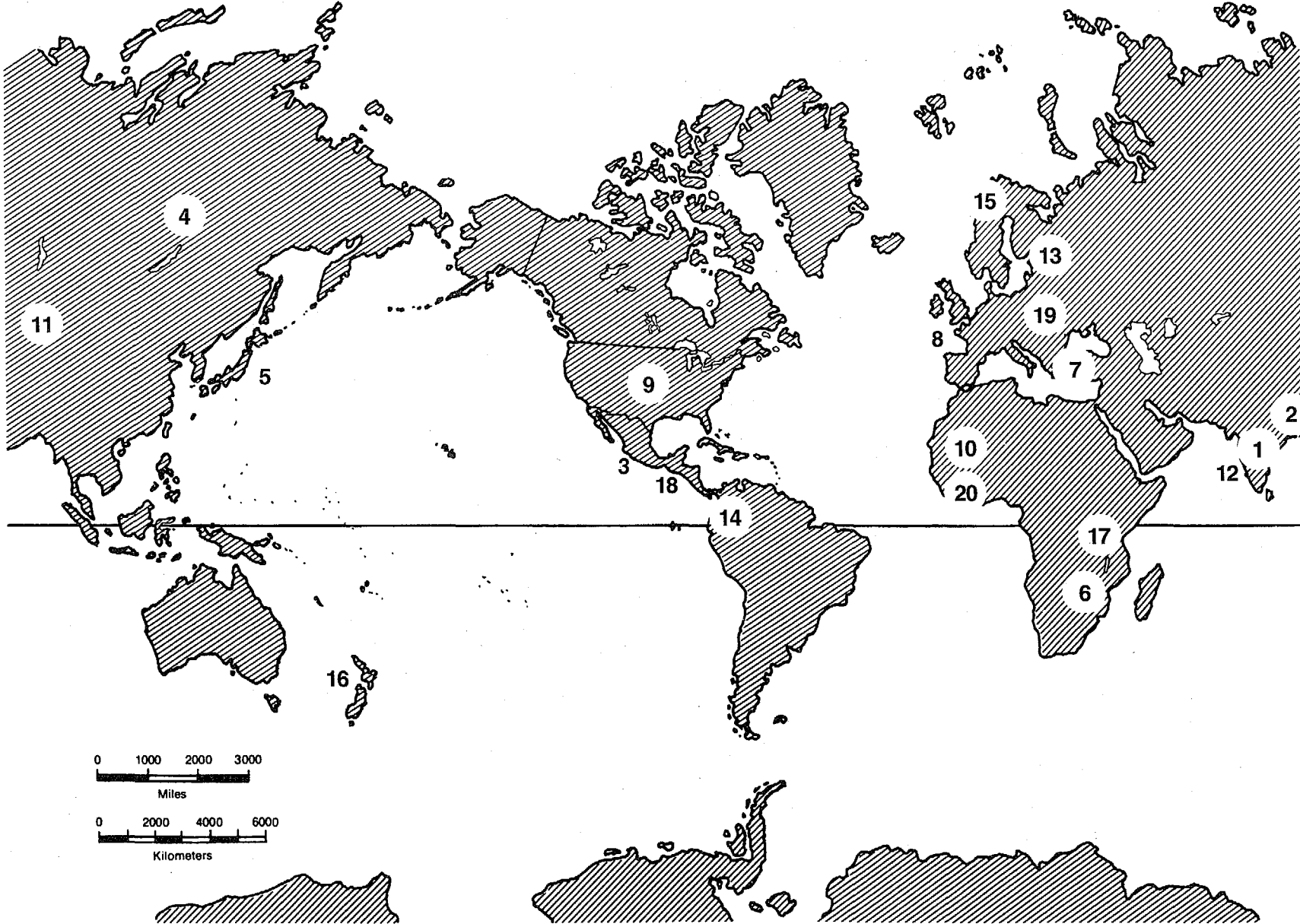

National Science
Education Standards
Matrices

Tremor Troop

Link to National Science Education Standards

Unit/ Grades	Science as Inquiry	Physical Science	Earth & Space Sci.	Science & Technology	Sci. in Personal & Social Perspectives	History & Nature of Science	Unifying Concepts & Processes
I.1	D	D	D	D	I	I	D
I.2	D	D	D	D	I	I	D
I.3	D	D	D		D	D	D
II.1	I	D	D	I			D
II.2	D	D	D	D		I	D
II.3	I	D	D		D		D
III.1	I	D	D	I	I		D
III.2	D	D	D		I		D
III.3	I	D	D			I	D
IV.1	D	D	D	D	I		D
IV.2	D	D	D	D	I		D
IV.3	D	D	D	D	I	I	D
V. Part 1		D	D	I	D		D
V. Part 2	I	D	I	I	D		I
V. Part 3				I	D		I
V. Part 4				I	D		

D = Direct Connection
I = Indirect Connection

Unit I: Defining an Earthquake

National Science Education Standards

Tremor Troop: Earthquakes	Science as Inquiry	Physical Science	Earth and Space Science	Science and Technology
<p>I.1 People Explain Earthquakes</p> <p>Students explore their personal experiences with earthquakes and observe a simulated earthquake by building an earthquake model. They also learn about earthquake legends and suggest possible causes of earthquakes and the structure of the Earth's interior.</p>	<p>Abilities related to scientific inquiry</p> <p>Understanding about scientific inquiry</p>	<p>Position and motion of objects</p>	<p>Properties of Earth materials</p> <p>Changes in the Earth and sky</p>	<p>Understanding about science and technology</p>
<p>I.2 People Explain Earthquakes</p> <p>Students explore personal experiences with earthquakes and communicate their thoughts about the causes of earthquakes. They identify and compare cultures that developed legends explaining earthquakes and learn what scientists believe cause earthquakes.</p>	<p>Abilities related to scientific inquiry</p> <p>Understanding about scientific inquiry</p>	<p>Position and motion of objects</p>	<p>Changes in the Earth and sky</p>	<p>Understanding about science and technology</p>
<p>I.3 Energy Waves Cause Earthquakes</p> <p>Students conduct investigations to simulate earthquakes and explain how they relate to events on Earth. They identify and compare locations of earthquakes and relate earthquake sites to legends and cultures.</p>	<p>Abilities related to scientific inquiry</p> <p>Understanding about scientific inquiry</p>	<p>Motions and forces</p> <p>Transfer of energy</p>	<p>Structure of the Earth system</p> <p>Earth's history</p>	

Tremor Troop: Earthquakes	Science in Personal and Social Perspectives	History and Nature of Science	Unifying Concepts and Processes	
<p>I.1 People Explain Earthquakes</p> <p>Students explore their personal experiences with earthquakes and observe a simulated earthquake by building an earthquake model. They also learn about earthquake legends and suggest possible causes of earthquakes and the structure of the Earth's interior.</p>	<p>Personal health</p> <p>Changes in Environments</p>	<p>Science as a human endeavor</p>	<p>Systems, order, and organization</p> <p>Evidence, models, and explanation</p>	
<p>I.2 People Explain Earthquakes</p> <p>Students explore personal experiences with earthquakes and communicate their thoughts about the causes of earthquakes. They identify and compare cultures that developed legends explaining earthquakes and learn what scientists believe cause earthquakes.</p>	<p>Personal health</p> <p>Changes in Environments</p>	<p>Science as a human endeavor</p>	<p>Systems, order, and organization</p> <p>Evidence, models, and explanation</p>	
<p>I.3 Energy Waves Cause Earthquakes</p> <p>Students conduct investigations to simulate earthquakes and explain how they relate to events on Earth. They identify and compare locations of earthquakes and relate earthquake sites to legends and cultures.</p>	<p>Personal health</p> <p>Natural hazards</p> <p>Risks and benefits</p>	<p>Science as a human endeavor</p> <p>Nature of science</p> <p>History of science</p>	<p>Systems, order, and organization</p> <p>Evidence, models, and explanation</p>	

Tremor Troop: Earthquakes	Science as Inquiry	Physical Science	Earth and Space Science	Science and Technology
<p>II.1 Inside Planet Earth</p> <p>Students name, identify, and observe a model of Earth's layers and plates and construct representations of each.</p>	<p>Abilities related to scientific inquiry</p> <p>Understanding about scientific inquiry</p>	<p>Properties of objects and materials</p> <p>Position and motion of objects</p>	<p>Properties of Earth materials</p> <p>Changes in the Earth and sky</p>	<p>Understanding about science and technology</p>
<p>II.2 Plates Going Places</p> <p>Students describe, name, and identify the interior and layers of the Earth. They construct models the Earth that demonstrate the way the surface is affected by interior movements.</p>	<p>Abilities related to scientific inquiry</p> <p>Understanding about scientific inquiry</p>	<p>Properties of objects and materials</p> <p>Position and motion of objects</p>	<p>Properties of Earth materials</p> <p>Changes in the Earth and sky</p>	<p>Understanding about science and technology</p>
<p>II.3 Layers, Plates, and Quakes</p> <p>Students construct models of the Earth's layers and describe the composition of the layers and the effects of activity at plate boundaries. They investigate convection as a model of plate movement.</p>	<p>Abilities necessary to do scientific inquiry</p> <p>Communicate scientific procedures and explanations</p> <p>Use mathematics in all aspects of scientific inquiry</p>	<p>Motions and forces</p>	<p>Structure of the Earth system</p> <p>Earth's history</p>	

Tremor Troop: Earthquakes	Science in Personal and Social Perspectives	History and Nature of Science	Unifying Concepts and Processes	
<p>II.1 Inside Planet Earth</p> <p>Students name, identify, and observe a model of Earth's layers and plates and construct representations of each.</p>			<p>Systems, order, and organization</p> <p>Evidence, models, and explanation</p>	
<p>II.2 Plates Going Places</p> <p>Students describe, name, and identify the interior and layers of the Earth. They construct models the Earth that demonstrate the way the surface is affected by interior movements.</p>			<p>Systems, order, and organization</p> <p>Evidence, models, and explanation</p> <p>Constancy, change, and environment</p>	
<p>II.3 Layers, Plates, and Quakes</p> <p>Students construct models of the Earth's layers and describe the composition of the layers and the effects of activity at plate boundaries. They investigate convection as a model of plate movement.</p>	<p>Natural hazards</p> <p>Risks and benefits</p>	<p>History of science</p>	<p>Systems, order, and organization</p> <p>Evidence, models, and explanation</p> <p>Constancy, change, and environment</p>	

Unit III: Physical Results of Earthquakes

National Science Education Standards

Tremor Troop: Earthquakes	Science as Inquiry	Physical Science	Earth and Space Science	Science and Technology
<p>III.1 Earthquakes Shape Our Earth</p> <p>Students demonstrate two types of faults and construct a model of a rural community to demonstrate the effect of an earthquake.</p>	<p>Abilities related to scientific inquiry</p> <p>Understanding about scientific inquiry</p>	<p>Position and motion of objects</p>	<p>Changes in the Earth and sky</p>	<p>Understanding about science and technology</p>
<p>III.2 Landscape on the Loose</p> <p>Students describe land features that result from earthquake activity and construct models of fault types. They demonstrate the formation of land features and events from earthquakes.</p>	<p>Abilities related to scientific inquiry</p> <p>Understanding about scientific inquiry</p>	<p>Properties of objects and materials</p> <p>Position and motion of objects</p>	<p>Properties of Earth materials</p> <p>Changes in the Earth and sky</p>	
<p>III.3 Building Up and Breaking Down</p> <p>Students describe and construct models of major landscape features. They relate these models to actual locations and demonstrate underwater activity that relates to earthquakes.</p>	<p>Abilities necessary to do scientific inquiry</p> <p>Communicate scientific procedures and explanations</p>	<p>Motions and forces</p>	<p>Structure of the Earth system</p> <p>Earth's history</p>	

Tremor Troop: Earthquakes	Science in Personal and Social Perspectives	History and Nature of Science	Unifying Concepts and Processes	
<p>III.1 Earthquakes Shape Our Earth</p> <p>Students demonstrate two types of faults and construct a model of a rural community to demonstrate the effect of an earthquake.</p>	<p>Personal health</p> <p>Changes in Environments</p>		<p>Systems, order, and organization</p> <p>Evidence, models, and explanation</p> <p>Constancy, change, and environment</p>	
<p>III.2 Landscape on the Loose</p> <p>Students describe land features that result from earthquake activity and construct models of fault types. They demonstrate the formation of land features and events from earthquakes.</p>	<p>Personal health</p> <p>Changes in Environments</p>		<p>Systems, order, and organization</p> <p>Evidence, models, and explanation</p> <p>Constancy, change, and environment</p>	
<p>III.3 Building Up and Breaking Down</p> <p>Students describe and construct models of major landscape features. They relate these models to actual locations and demonstrate underwater activity that relates to earthquakes.</p>		<p>History of science</p>	<p>Systems, order, and organization</p> <p>Evidence, models, and explanation</p> <p>Constancy, change, and environment</p>	

Unit IV: Measuring Earthquakes

National Science Education Standards

Tremor Troop: Earthquakes	Science as Inquiry	Physical Science	Earth and Space Science	Science and Technology
<p>IV.1 Earthquakes Great and Small</p> <p>Students demonstrate earthquake simulation of different strengths and compare damage of each. They also demonstrate the length of time associated with earthquakes.</p>	<p>Abilities related to scientific inquiry</p> <p>Understanding about scientific inquiry</p>	<p>Position and motion of objects</p>	<p>Changes in the Earth and sky</p>	<p>Abilities of Technological Design</p>
<p>IV.2 Different Shakes for Different Quakes</p> <p>Students demonstrate simulations of various earthquake strengths and describe techniques for measuring earthquakes. They demonstrate a technique for recording earthquake movement and a method used to measure earthquakes.</p>	<p>Abilities related to scientific inquiry</p> <p>Understanding about scientific inquiry</p>	<p>Position and motion of objects</p>	<p>Changes in the Earth and sky</p>	<p>Abilities of Technological Design</p> <p>Understanding about science and technology</p>
<p>IV.3 Sizing Up Earthquake Waves</p> <p>Students simulate earthquake waves and construct a model for measuring earthquake waves. They also identify events associated with earthquakes and interpret data about intensity of earthquakes.</p>	<p>Abilities necessary to do scientific inquiry</p> <p>Communicate scientific procedures and explanations</p>	<p>Motions and forces</p> <p>Transfer of energy</p>	<p>Structure of the Earth system</p> <p>Earth's history</p>	<p>Abilities of Technological Design</p> <p>Communicate the Process of Technological Design</p>

Tremor Troop: Earthquakes	Science in Personal and Social Perspectives	History and Nature of Science	Unifying Concepts and Processes	
<p>IV.1 Earthquakes Great and Small</p> <p>Students demonstrate earthquake simulation of different strengths and compare damage of each. They also demonstrate the length of time associated with earthquakes.</p>	<p>Personal health</p> <p>Changes in Environments</p>		<p>Systems, order, and organization</p> <p>Evidence, models, and explanation</p> <p>Constancy, change, and environment</p>	
<p>IV.2 Different Shakes for Different Quakes</p> <p>Students demonstrate simulations of various earthquake strengths and describe techniques for measuring earthquakes. They demonstrate a technique for recording earthquake movement and a method used to measure earthquakes.</p>	<p>Personal health</p> <p>Changes in Environments</p>		<p>Systems, order, and organization</p> <p>Evidence, models, and explanation</p> <p>Constancy, change, and environment</p>	
<p>IV.3 Sizing Up Earthquake Waves</p> <p>Students simulate earthquake waves and construct a model for measuring earthquake waves. They also identify events associated with earthquakes and interpret data about intensity of earthquakes.</p>	<p>Natural hazards</p> <p>Risk and benefits</p>	<p>Science as a Human Endeavor</p> <p>Nature of science</p>	<p>Systems, order, and organization</p> <p>Evidence, models, and explanation</p> <p>Constancy, change, and environment</p>	

Tremor Troop: Earthquakes	Science as Inquiry	Physical Science	Earth and Space Science	Science and Technology
<p>V.Part 1: What Happens During an Earthquake</p> <p>Students identify areas of risk for earthquakes in the United States. They identify and describe events that occur during earthquakes, and they demonstrate safe behavior during an earthquake simulation.</p>		<p>Position and Motion of Objects</p> <p>Motion and Forces</p> <p>Transfer of Energy</p>	<p>Changes in the Earth and Sky</p> <p>Structure of the Earth System</p> <p>Earth's History</p>	<p>Abilities of Technological Design</p> <p>Understanding about Science and Technology</p>
<p>V.Part 2: Hunt for Hazards</p> <p>Students identify potential hazards in school and home and list possible ways to reduce hazards.</p>	<p>Abilities necessary to do scientific inquiry</p>	<p>Properties of Objects and Materials</p>	<p>Properties of Earth Materials</p>	<p>Abilities of Technological Design</p> <p>Communicate a Problem, Design, and Solution</p> <p>Understanding about Science and Technology</p>
<p>V.Part 3: Prepare and Share</p> <p>Students identify and assemble an emergency kit and communicate earthquake safety information to others.</p>				<p>Abilities of Technological Design</p> <p>Communicate the Process of Technological Design</p>
<p>V.Part 4: Evacuation Drill</p> <p>Students identify hazards during an evacuation and describe ways of helping others who are injured during earthquakes. They describe feelings and dangers associated with earthquakes.</p>				<p>Abilities of Technological Design</p> <p>Communicate the Process of Technological Design</p>

Tremor Troop: Earthquakes	Science in Personal and Social Perspectives	History and Nature of Science	Unifying Concepts and Processes
<p>V.Part 1: What Happens During an Earthquake</p> <p>Students identify areas of risk for earthquakes in the United States. They identify and describe events that occur during earthquakes, and they demonstrate safe behavior during an earthquake simulation.</p>	<p>Personal Health</p> <p>Changes in Environments</p> <p>Natural Hazards</p> <p>Risks and Benefits</p>		<p>Systems, order, and organization</p> <p>Evidence, models, and explanation</p> <p>Constancy, change, and environment</p> <p>Form and function</p>
<p>V.Part 2: Hunt for Hazards</p> <p>Students identify potential hazards in school and home and list possible ways to reduce hazards.</p>	<p>Personal Health</p> <p>Changes in Environments</p> <p>Science and Technology in Local Challenges</p>		<p>Systems, order, and organization</p> <p>Evidence, models, and explanation</p> <p>Constancy, change, and environment</p> <p>Form and function</p>
<p>V.Part 3: Prepare and Share</p> <p>Students identify and assemble an emergency kit and communicate earthquake safety information to others.</p>	<p>Personal Health</p> <p>Types of Resources</p> <p>Changes in Environments</p> <p>Science and Technology in Local Challenges</p>		<p>Systems, order, and organization</p> <p>Evidence, models, and explanation</p> <p>Constancy, change, and environment</p> <p>Form and function</p>
<p>V.Part 4: Evacuation Drill</p> <p>Students identify hazards during an evacuation and describe ways of helping others who are injured during earthquakes. They describe feelings and dangers associated with earthquakes.</p>	<p>Personal Health</p> <p>Changes in Environments</p> <p>Science and Technology in Local Challenges</p> <p>Natural Hazards</p> <p>Risks and Benefits</p>		

Glossary

aesthenosphere (*aestheno means to flow*) — The aesthenosphere is a part of the mantle below the lithosphere. The upper portion of the aesthenosphere is a region with a plastic, semi-solid consistency that bends and flows in response to pressure.

aftershock — An aftershock is an earthquake which follows a major earthquake, and is of lesser magnitude.

amplitude — Amplitude is the measurement of a wave determined by measuring the distance from the top of the wave to the bottom of the wave and dividing that amount by 2.

abyssal plain — a flat region of the deep ocean floor.

body waves — Body waves are earthquake waves that travel through the body of the Earth. They are of two types, P-waves and S-waves.

convection current — A convection current is a circular movement in a fluid in which hot material rises and cold material sinks.

continental drift — Continental drift is an outdated theory, first advanced by Alfred Wegener, that Earth's continents were originally one land mass, which split up and gradually migrated to form today's continents.

convergent plate boundary — A convergent plate boundary represents the collision of two plates moving toward each other. Such collisions may generate mountain ranges and volcanoes.

core — The core of the Earth consists of two sphere-shaped bodies; the inner core is like a very hot solid steel ball, surrounded by a liquid outer core. The core is the deepest part of the Earth, and is thought to be responsible for generating the Earth's magnetic field.

crust — The crust is the very thin uppermost layer of the Earth's lithosphere.

culture — A culture is the special way of life that holds a group of people together and makes it different from all other groups.

divergent plate boundary — A divergent plate boundary represents the separation of two plates moving apart. This divergent movement is in response to forces in the Earth's mantle. Features formed at divergent boundaries include mid-ocean ridges and rift valleys.

earthquake — An earthquake is a sudden, rapid shaking of the Earth caused by the release of energy stored in rocks.

earthquake intensity — Expressed as Roman numerals on the Modified Mercalli scale, earthquake intensity is a measure of ground shaking based on damage to structures and changes felt and observed by humans.

earthquake magnitude — Earthquake magnitude is a measure of the amount of energy released by an earthquake. Expressed in Arabic numerals, it is based on several widely-used logarithmic scales.

earthquake waves — Earthquake waves, or seismic waves, are waves caused by the release of energy in the Earth's rocks during an earthquake.

elastic rebound theory — Elastic rebound was proposed by H. F. Reid in 1906 to explain earthquake generation. Reid proposed that faults remain locked while strain energy slowly accumulates in surrounding rock. When rock strength is exceeded and rocks fracture, the fault slips suddenly, releasing energy in the form of heat and seismic waves.

energy — Energy is the power to move or change things.

epicenter — The epicenter is the point on the Earth's surface directly above the focus. The focus is the place within the Earth where an earthquake's energy is released.

fault — A fault is a crack in rock or soil along which movement has taken place.

fault scarp — A fault scarp (cliff) is the topographic result of ground displacement attributed to fault movement.

fault creep — Fault creep is slow ground movement or slip occurring along a fault without production of earthquakes.

fault plane — A fault plane is a surface along which fault movement has occurred.

fissure — A fissure is an open crack in the ground.

focus — The focus, or hypocenter, is the place inside the lithosphere where an earthquake's energy is first released.

foreshock — A foreshock is an earthquake which comes before the main earthquake and is less severe.

hazard — A hazard is any object or situation which contains the potential for damage, injury, or death.

hypocenter — See focus.

lateral fault — See strike-slip fault.

legends - Legends are traditional narrative explanations of natural phenomena that evolve when scientific explanations are not available.

liquefaction — Liquefaction is the process in which soil or sand suddenly loses the properties of solid material (cohesion) and behaves like a liquid.

lithosphere (*litho means rock/stone*) — The lithosphere is the solid outer region of the Earth in which earthquakes occur. It contains the crust and the uppermost portion of the mantle.

Love waves — Love waves are surface waves that move in a back and forth, horizontal motion.

magma — Magma is liquid rock beneath the Earth's surface. When it erupts it is called lava.

mantle — The mantle is the layer of the Earth between the core and the crust. It has a semi-solid consistency and is capable of movement.

mid-ocean ridge — A mid-ocean ridge is a submarine mountain range along a divergent

plate boundary, formed by volcanic activity.

mountain — A mountain is a portion of the Earth's surface that has distorted (folded, faulted, volcanic) rocks and is higher in elevation than surrounding regions.

normal fault — A normal fault is one in which an upper block of rock, separated by a fault from a lower block, moves downward relative to the lower block.

oceanic crust — Oceanic crust is the basaltic portion of the Earth's crust that is generated at mid-ocean ridges. Most of this crustal material makes up the ocean floor. Oceanic crust is thinner and greater in density than continental crust.

oceanic trench — An oceanic trench is a long, narrow depression in the seabed which results from the bending of an oceanic plate as it descends into the mantle at a subduction zone.

P-waves — P- (or Primary) waves are the fastest body earthquake waves, which travel by compression and expansion.

plain — A plain is a flat-lying geographic area.

plate, tectonic — A tectonic plate is a large, relatively rigid segment of the Earth's lithosphere; these plates move around in relation to other plates because they "ride" on the plastic asthenosphere.

plate tectonics — Plate tectonics is a geological model in which the Earth's crust and uppermost mantle (the lithosphere) are divided into a number of relatively rigid, constantly moving segments (plates).

plateau — A plateau is an area of horizontal rocks that is higher than surrounding areas and usually has some areas of steep slopes.

potential energy — Potential energy is stored energy.

primary waves — See P-waves.

Richter scale — Richter scale is a type of measurement of earthquake magnitude. Charles Richter and Beno Gutenberg created this scale in 1935.

reverse fault — A reverse fault is one in which an upper block of rock slides over a lower block which is separated from it by the fault. A low-angle reverse fault is called a thrust fault.

risk, earthquake — Earthquake risk is the potential for loss (life, property) in the event of an earthquake.

S-waves — S- (or Secondary) waves are body earthquake waves which travel more slowly than P-waves, and create elastic vibrations in solid substances. S-waves do not travel through liquids.

secondary waves — See S-waves.

seismic sea wave — See tsunami.

seismic wave — An energy wave in the Earth generated by an earthquake or explosion.

seismogram — A seismogram is a recording of the Earth's motions produced by a seismograph.

seismograph — A seismograph is an instrument for recording the motion of the Earth in response to seismic waves.

seismologist — A seismologist is a scientist that studies the cause, measurement, and effects of earthquakes.

seismology — Seismology is the study of earthquakes.

strain, elastic — Elastic strain is the deformation or change in the shape of a body in response to stress.

stress, elastic — Elastic stress is a measure of the forces acting on a body.

strike-slip fault — Strike-slip fault is a fault along which motion is mostly in a horizontal direction.

subduction — Subduction occurs where the leading edge of a plate made of oceanic crust and underlying mantle sinks under the edge of an opposing plate made of continental crust and underlying mantle.

surface waves — Surface waves are seismic waves that travel only on the surface of the Earth.

transform fault — A transform fault is a lateral or sideways moving fault, generated along mid-ocean ridges.

thrust fault — See reverse fault.

tsunami — A tsunami is an ocean wave caused by movements of the ocean floor, such as from earthquakes and volcano eruptions.

turbidity current — A turbidity current is a dense current of sediment mixed with water that flows downslope in ocean regions. Turbidity currents are often started by earthquake shaking.

volcano — A volcano is a mountain of erupted volcanic material.