

171
5644
MHT
NO. 44

THE HAMMERED DULCIMER IN AMERICA

Nancy Groce



SMITHSONIAN INSTITUTION

SMITHSONIAN STUDIES IN HISTORY AND TECHNOLOGY / NUMBER 44

THE HAMMERED DULCIMER IN AMERICA

Nancy Groce



SMITHSONIAN INSTITUTION PRESS

City of Washington

1983

A B S T R A C T

Groce, Nancy. The Hammered Dulcimer in America. *Smithsonian Studies in History and Technology*, number 44, 93 pages, 40 illustrations, 5 appendices, 1983. — The hammered dulcimer played an important role in Anglo-American folk and popular music during the 18th, 19th, and early 20th centuries. This paper gives a brief history of its development in the Middle East and Europe, its musical use and social function in America, and how it was manufactured and marketed in 19th century America. In the appendices are given a list of United States patents granted for improvements in dulcimer design, a list of known makers, biographical information on the musicians interviewed in the course of this research, a checklist of dulcimers in the Smithsonian Institution, and a selected discography.

Copyright © Nancy Groce 1983

OFFICIAL PUBLICATION DATE is handstamped in a limited number of initial copies and is recorded in the Institution's annual report, *Smithsonian Year*. COVER: Hammered dulcimer by Ezra Durand, 1868 (Figure 23).

Library of Congress Cataloging in Publication Data

Groce, Nancy.

The hammered dulcimer in America.

(Smithsonian studies in history and technology ; no.44)

Bibliography: p.

Discography: p.

I. Dulcimer. I. Title. II. Series.

ML1041.G76 1983 787'.94 82-600259

Contents

<i>Page</i>	v	Preface
	1	Introduction
	10	Origins and Background
	22	The Dulcimer in America
	42	Dulcimer Manufacture
	72	The Current Revival
	74	Appendix A: A Chronological Tabulation of U.S. Patents Granted for Improvements to the Dulcimer
	76	Appendix B: Dulcimer Makers
	79	Appendix C: Biographical Sketches of Informants
	81	Appendix D: Dulcimers in the Collections of the Smithsonian Institution
	84	Appendix E: Selected Discography
	87	Notes
	91	Literature Cited

Preface

The hammered dulcimer once flourished in this country. By the 1930s it was nearly extinct, but in isolated areas along the Michigan-Ohio border it has survived to the present day. The author began this study in these pockets of surviving folk culture, hoping to find rich rewards in dulcimer lore and traditions, and soon discovered that the dulcimer is well remembered in many other regions of the country as well.

Brought to North America by early colonists from Europe, the dulcimer quickly became established in the Anglo-American folk tradition and grew still more popular during the 1800s. Portable, cheap, and easy to build, it answered the pioneer's need for music on the western frontier. Thousands of dulcimers were produced in American homes, shops, and factories. In the early 20th century even large mail-order houses like Sears, Roebuck, and Co. and Montgomery Ward sold dulcimers through their catalogs.

Hammered dulcimers are particularly interesting because, unlike pianos and organs, most were built in homes or small shops scattered throughout the country. Hence they reflect regional and personal tastes. The hammered dulcimer occupies that musical no man's land between the "pure folk" and "popular" traditions. Since its history in the United States has received little attention from either musicologists or folklorists, this study necessarily relies heavily on interviews with the last generation of traditional hammered dulcimer players and makers and the examination of extant instruments. Short biographical sketches are given for these informants in Appendix C; transcripts of interviews, letters, and other primary materials may be obtained by contacting the author through the Division of Musical Instruments, Museum of American History, Washington, D.C. 20560.

Some of the instruments examined in the course of this research are privately owned and were made available for study through the kindness of their owners. Many are in the collection of the Division of Musical Instruments of the National Museum of American History. A checklist of the dulcimers in the Museum's collection appears in Appendix D. Others are in

the unusually fine collection of hammered dulcimers at the Henry Ford Museum in Dearborn, Michigan. The measurements given in the text are derived from many sources and are often approximations. These are usually given in inches. Accurate measurements for the instruments in the National Museum of American History appear in Appendix D and are given in centimeters.

This study was carried out during the course of a predoctoral research fellowship administered by the Smithsonian Institution Office of Academic Affairs under the auspices of the Division of Musical Instruments in the Smithsonian's National Museum of American History. The author wishes to thank all members of the Division of Musical Instruments for their support and advice, particularly Cynthia A. Hoover, Curator, and Scott Odell, Conservator, whose assistance and guidance were vital. I am also grateful to Gary Sturm for his help on the checklist. Editorial assistance was provided by Elsa M. Bruton. Dr. Richard Crawford of the University of Michigan and Dr. Robert Eliason of the Henry Ford Museum provided invaluable advice.

It is not possible to acknowledge and individually thank the many dulcimer players with whom I spoke; I am grateful to Russell Fluharty, Paul Gifford, John McCutcheon, Herman E. Matheny, Cloise Sinclair, and especially Fern and Paul Van Arsdale, who gave freely of their time and expertise. Without their help this study could not have been completed.

THE HAMMERED DULCIMER IN AMERICA

Nancy Groce

Introduction

A century ago the dulcimer was a familiar part of the American musical scene. Today, most Americans would find it difficult to identify the instrument either by sight or by its sound. Even devotees of folk music often confuse the hammered dulcimer with the three- or four-stringed Appalachian plucked dulcimer, but the two are not closely related. Given the amount of confusion on the subject, this distinction cannot be over-emphasized. The hammered dulcimer developed in the Near East around the 10th century A.D. (see p. 11). The plucked dulcimer evolved much later from related northern European zithers, including the Swedish *hummel*, the German *sheithold*, and the French *épinette des Vosges*.

Nancy Groce, 338 East 70th Street #3B, New York, NY, 10021.

Though currently surpassing the hammered dulcimer in popularity, the plucked dulcimer was unknown in the British Isles and rare in America until popularized by the urban folk revival of the 1950s and 1960s.

The question that remains unanswered, at least for the present, is how these two unrelated instruments acquired a common name. The English word dulcimer and its cognates, the medieval French *doucemelle*, the Spanish *dulcema*, and the Italian *dolcemela* are derived from the Latin *dulce melos*, or “sweet melody.” To most Americans throughout the 18th, 19th, and 20th centuries, the term dulcimer meant the hammered dulcimer. Writing in 1925, folklorist Josiah Combs was one of the first to describe the small Appalachian dulcimer. He emphasized that “it must not be confused with the classical or traditional [hammered] dulcimer, to which it bears no resemblance.”¹ Other terms such as “lap harp” and “music box” are used by Appalachian folk musicians for the three- or four-stringed plucked instrument, and one authority believes that calling it a dulcimer “seems [to be a product] of media-encouraged tendencies for folk to adopt proper, standardized names.”² Most of the traditional hammered dulcimer players interviewed in the course of this study had only recently heard of the smaller instrument, and few remembered it having been used in their communities. A few voiced the opinion that the “little fellows” were not really serious musical instruments. The hammered dulcimer players were as mystified as anyone else about how the plucked instrument acquired the name dulcimer, although one offered his own explanation:

They do have similar sounds, and it would be easy if you were at a distance or something to say, “Well, that is a dulcimer.” Because they do have a kind of Oriental, an old-time piano [sound]—the kind they used to have in the bars, you know, that old tinny kind.³

The subject of this study is the *hammered dulcimer*; throughout the text, “dulcimer” will refer only to that instrument.

The Structure of the Dulcimer

The basic shape of the dulcimer is trapezoidal, but in America instruments were often built into rectangular bodies. During the 19th century a “parlor model” developed, for which legs and a hinged cover were added to veneered or stained rectangular bodies of increasing elegance (Figure 1). The parlor dulcimer seems to have been particularly popular in more affluent regions, especially New England and the area along the Ohio-Michigan border.

There were considerable regional and individual variations in American dulcimers, but in general they were 30–48 inches in length, 12–24 inches in width, and 2–6 inches in depth. The strings, made of brass or steel wire, were arranged in groups or “courses” of two to six strings each. The strings of each course were then tuned to the same pitch. Strings could number from as few as 40 to as many as 120; the average instrument had about 60.

The dulcimer has two sets of string courses—the treble and the bass. All of the strings run the length of the instrument (i.e., from side to side). The treble courses pass over the treble bridge, which is a carved strip of hardwood roughly 0.75–1.0 inch high. This bridge sits on top of the soundboard near the center of the instrument. The treble strings are tightened over it; thus the shorter lengths of the string on either side sound at higher pitches, usually a fifth apart. The bass courses pass through holes carved in the treble bridge and over the bass bridge at the extreme left of the soundboard. For these courses the full length of the string sounds, and they are consequently lower in pitch. The bass bridge, unlike the treble, usually does not run the full width of the instrument; it too has carved holes to allow the *treble* courses to pass through. The two sets of strings form a criss-cross pattern at the left side of the soundboard, where they are set into the hitch pins.

Instead of the long carved bridges, some dulcimers have individual turned pieces of wood set under each course of strings. This avoids the need for carved holes in the long bridges, since the



FIGURE 1.—Parlor dulcimer from 19th century America. Possibly made in the Midwest, this instrument has a rosewood body, handsomely turned legs, and a hinged cover. The two velvet pads on the soundboard served as candle rests. (Collection of the Smithsonian Institution; catalog number 299,841)

alternate courses of strings pass between these “chessman” bridges (see Figure 2).

Dulcimers were usually tuned to be playable in the keys of C, G, D, or A, a selection that probably reflects the preference for “sharp keys” so wide-spread among fiddlers. Although there were many variations, it was common to tune the right side of the treble

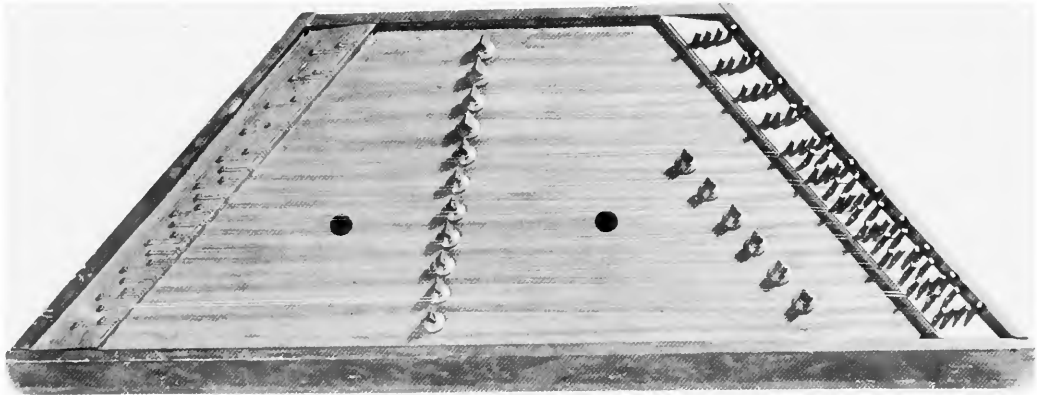

FIGURE 2.—New York State dulcimer with individual “chessman” bridges. Possibly built in Fulton County, ca. 1847. (Collection of the Smithsonian Institution; catalog number 94,871)

bridge, from the bottom to the top, C#, D, E, F#, G, A, B, C♭, D, E, F♭, G. This tuning resulted in a parallel series of notes a fifth higher on the left side of the treble bridge: G#, A, B, C#, D, E, F#, G, A, B, C♭, D (Figure 3). Bass courses were often tuned to a D major scale, beginning an octave below the second pitch on the right-hand side of the treble bridge. If there were enough bass courses to overlap the treble notes, the C# course in the bass might then be tuned to C♭ in order to increase the instrument’s chromatic possibilities. The bass courses might also be tuned a fifth below the right-hand side of the treble courses.

A few American dulcimer players placed the treble bridge farther toward the center of the sound board thus creating a fourth interval across the bridge. Chromatic tuning, with a half-step interval across the bridge, was used by many German dulcimer players. It never gained widespread popularity in America, however, though it is found on a few late 19th century factory-made instruments.

Less common among American dulcimerists was the “flat key”

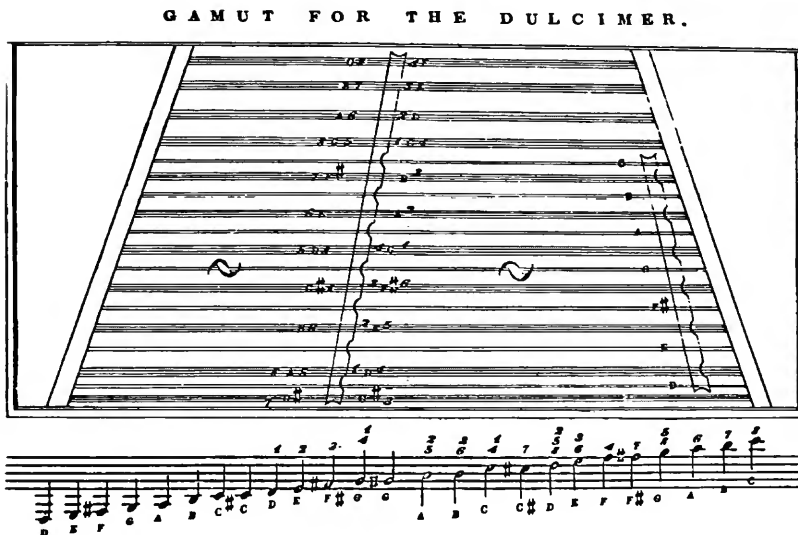

FIGURE 3.—The tuning system suggested by C. Haight in 1848 and still used by many traditional dulcimerists. Note the alternate number system. (Taken from C. Haight, *A Complete System for the Dulcimer*)

tuning, which made it possible to play in the keys of G, C, F, and B \flat . Since tuning the many strings of the instrument was a chore, players chose either the “sharp key” or the “flat key” tuning and rarely retuned.

American dulcimers usually had two toneholes on the soundboard, but some instruments had as many as six. A few were built with no toneholes at all. The number of toneholes and their design were largely matters of personal taste. Regional preferences are evident, however (see p. 59 and Figure 4).

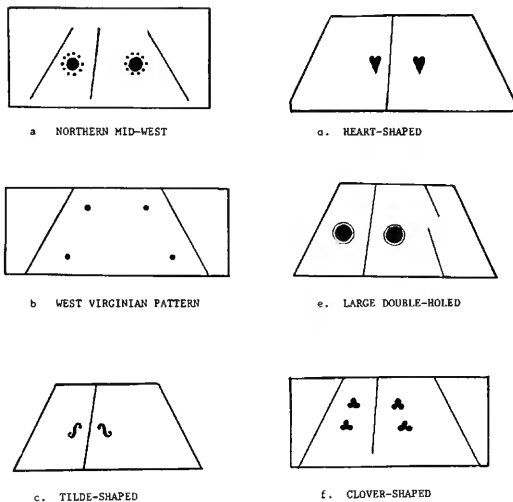

FIGURE 4.—Tonehole designs found on American dulcimers.

Because in many cases the same note could be played in more than one place on the dulcimer, and because the large number of strings could be quite confusing, many players resorted to chalking or painting the letter names of the note onto the soundboard under the appropriate courses. On shop-made dulcimers, note names often were printed on a strip of paper several inches wide which was then glued on the soundboard beneath the strings (Figure 5). Occasionally, a number or solmization system would be used in combination with, or instead of, the more common letter names.

Regardless of the type and elegance of the outer case, and despite the wide variation in their size and compass, all dulcimers are similar in design and construction. On one side of the soundboard, the strings are attached to tuning pins (Figure 6), which are mounted in a wrest plank of hardwood, usually maple, oak, or cherry. The strings are then stretched across the bridges and fastened to stationary hitch pins on the opposite side. American



FIGURE 5.—Model submitted to the Patent Office by John Low of Clinton, Massachusetts on 19 June 1860 (Collection of the Smithsonian Institution; catalog number 331,204)

dulcimers traditionally were built with the tuning pins on the right-hand side and the hitch pins on the left. (On some instruments, possibly built by left-handed players, this arrangement is reversed.) Small rectangular tuning pins were apparently manufactured specifically for the instrument during the 19th century. Often, however, players “made do” with larger piano pins, smaller square zither pins, or homemade replacements of various sizes.

Mallets (or hammers) also varied widely in design. Because they were so easily lost or misplaced, it is often impossible to know whether the hammers found with an old instrument were made by the dulcimer maker or are replacements provided years later by someone else. Most players had either two pairs of hammers or one pair with reversible heads. One pair, or one side of a reversible pair, was covered with felt or yarn, which produced a soft, warm sound; the other was covered with deerskin or leather to give a loud, bright tone. The mallet heads could be spherical or hemis-

Origins and Background

*There was myrth & melody
with harpe, getron and sautry
with rote, ribible and clokarde
with pypes, organs and bumbarde
with other mynstrelles them amonge
with sytolphe and with sautry songe
with fydle, recorde and Dowcemere
with trumpette & with claryon clere
with dulcet pipes of many cordes.*

*“The Squyr of Lowe Degre”⁵
ca. 1400 (emphasis added)*

The early history of the dulcimer is closely linked to that of the psaltery; both instruments evolved from a common ancestor. The difference between the two, in fact, is not in basic construction, but in the means of sounding the instrument: the strings of the psaltery are plucked with the fingers, while dulcimer strings are struck with small mallets or hammers. Technically, both instruments are board-zithers—that is, chordophones on which the strings are stretched horizontally across a shallow rectangular or trapezoidal box, which then acts as a resonating chamber.

The Dulcimer and its Precursors in the Ancient World

The dulcimer’s predecessor, the psaltery, probably developed from the ground-zither, a primitive chordophone constructed by stretching stings over a hole or pit in the ground, which acts as a resonating chamber. Traces of ground-zithers have been discovered at Neolithic sites, and variants are still used today by several cultures in East Africa, Indochina, and Madagascar.⁶

The earliest known representation of a zither with a soundboard is a small Phoenician ivory carving of the 8th century B.C.⁷ The Phoenician name for the instrument is unknown, but it is probably related to the Hebrew *asor*, a 10-stringed zither mentioned in the

Old Testament (Psalms 33, 92, and 144).⁸

A dulcimer is also mentioned in the Psalms, but this much-quoted reference cannot be taken as evidence of the instrument's existence in the ancient world. The Greek word translated as *dulcimer* in the King James Bible was *symphonia*, and though scholars disagree on its exact meaning, most accept the premise that it was not a single musical instrument, but rather a group of instruments playing together.

When the dulcimer's standard trapezoidal shape developed is uncertain. The earliest known account of a trapezoidal instrument dates from A.D. 963, when a Syrian lexicographer described the *quithoro*, a board-zither with 10 strings.⁹ Slightly later, the zither-like *qānūn* was mentioned in one of the oldest tales of *The Arabian Nights*. A 14th-century Persian treatise describes the *qānūn* as a trapezoidal zither with 64 strings, arranged in groups or "courses" of three strings to each pitch.¹⁰

After gaining popularity in Moorish Spain, the *qānūn* spread through Western Europe and evolved into various forms, one of which was the English psaltery. The *qānūn* is still used today in North Africa for the performance of traditional art music.

The earliest dulcimer, a Persian-Iraqi instrument called the *santir* (from the Greek *psalterion*), apparently developed from the *qānūn* around A.D. 900. The differences between the *santir* and the *qānūn* were not structural, but in the manner of playing: while the *qānūn* was plucked, the *santir* was struck with small mallets. Like other board-zithers, the *santir* was soon adopted throughout the Muslim world. Music historians generally agree that the *santir*, or dulcimer, entered western Europe around A.D. 1100 by way of Spain from North Africa, where it still played by Sephardic Jews.

The Dulcimer in Europe

Just how the dulcimer was transplanted into western Europe remains uncertain. It was probably introduced and assimilated primarily through peaceful contact with the Spanish Moors around

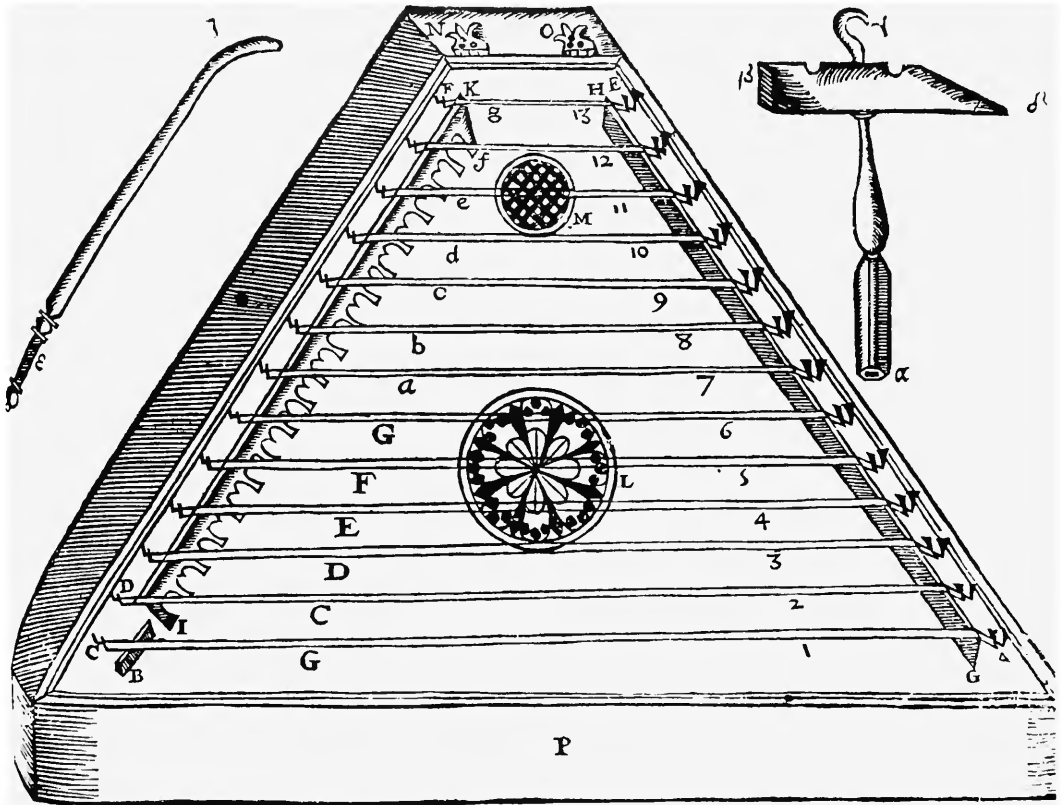

FIGURE 7.—Dulcimer with beater and tuning hammer from an illustration in Marin Mersenne's *Harmonie Universelle* (1636).

A.D. 1100. Some instruments, however, may have been brought back directly from the Middle East by returning Crusaders. In any case, the dulcimer was increasingly popular in Europe in the centuries that followed.

As early as the 10th century the word *tympanon* was generally

used for *chordophones* in France. By the 15th century the name was attached specifically to the dulcimer. This word had originally meant “drum,” and its newer usage probably is linked to the percussive nature of the dulcimer. The German dulcimer is known as a *Hackbrett*, or chopping board; the term was probably coined because of the motion of the player’s hands.

Little pictorial evidence of the dulcimer survives from the 12th and 13th centuries. The earliest known likeness of a European dulcimer may be the one on a relief carved in A.D. 1184 on the portico of the Santiago de Compostela cathedral in northwest Spain.¹¹ Detailed written descriptions of dulcimers and dulcimer playing, moreover, are scarce, even through the 15th and 16th centuries. To add to the confusion, Medieval accounts sometimes used the term *psaltery* to designate both struck and plucked zithers. As late as 1636, for example, the philosopher Marin Mersenne, in his *Harmonie Universelle*, described a “psaltery” (or “psalterium”) that was clearly a dulcimer:

It must be noted that the method of sounding this instrument is different from that of the others, inasmuch as one uses the stick . . . which one holds in the right hand by the neck or the grip . . . to strike the strings with the curved end . . . which one lets fall softly on the strings, so that it makes small bounds. . . . If one wishes to play two or more parts together on this instrument, one can have two sticks.¹²

Mersenne found it a “very agreeable” instrument and did not “doubt that one could receive as much or more satisfaction from it than from the spinet or the harp.” He illustrated it in his book (see Figure 7).

One of the earliest mentions of the dulcimer in England was in the poem, “The Squyr of Lowe Degre” (see lines quoted above), written about 1400. Here the “Dowcemere” is plainly distinguished from the “sautry.” At Coventry in 1474, Prince Edward (1470–1483) reportedly was greeted with “the ministralsie of harpe and dowsemeris.”¹³ And at Westminster Hall in 1502, it is recorded that a dozen ladies “made music on clarycordis, dulsymers, clarysymballs, and such other.”¹⁴



FIGURE 8.—Illumination from the 15th century *Breviary* of King Renee II (Duke of Lothruinger) depicts a dulcimer played with a cornetto, two trumpets, two recorders, harp and viola da braccio. (Reproduced by permission of the *Bibliothèque Nationale*, Paris)



FIGURE 9.—Martin Le Franc's illustration of the allegorical poem "Le Champion des Dames" from *The Nine Muses* (1451). The ensemble includes a dulcimer, recorder, lute, trumpet, bombard, tabor and pipe, portative organ, and a second dulcimer-like instrument, probably a *tambourin à cordes* (upper left). Both players grasp their hammers between the thumb and first finger of their clenched fists. A less awkward and more conventional (from a modern viewpoint) mode of playing is seen in Figure II; the player holds his beaters between his middle and ring fingers. (Reproduced by permission of the *Bibliothèque Municipale*, Grenoble)

Illustrations of the dulcimer began to appear more frequently during the 15th and 16th centuries (see Figure 8). The shape of the European dulcimer had not yet been standardized, but some were rectangular with a bulge on one side. As Figures 9 and 10



FIGURE 10.—Anonymous illustration from the 16th century French manuscript, *Le Livre des Echecs Amoureux*. Dulcimerist is accompanied by a tabor and pipe, cornetto, bagpipe, and singers. In the foreground are a harp, portable organ, and recorder. (Reproduced by permission of the *Bibliothèque Nationale*, Paris)

demonstrate, there was less than universal agreement on which direction the bulge should face.

The modern dulcimer developed during the 16th century, as the trapezoidal shape became standard. A central bridge was added, which divided each string into two different pitches and substantially increased the instrument's compass. The 16th-century bridgeless, bulged dulcimer shown in Figure 10 suggests that this evolution



FIGURE 11.—Detail from Jacob Cornelius Van Oostzaan's "The Birth of Christ" shows a remarkably modern-looking trapezoidal dulcimer played with cornetti and trumpets. It has two toneholes, one on either side of the clearly depicted central bridge. There now appear to be nine courses, composed of two strings each, instead of the older arrangement of a single string for each course. (Reproduced by permission of the Naples Museum)



FIGURE 12.—Illustrated by a French scribe about 1540, this Psalter depicts a trapezoidal dulcimer played in its case, accompanying a pipe and tabor, harp, and trumpet. (Reproduced by permission of the British Library Board, Royal Ms. 2A XVI, f. 98v)

was gradual. But as early as 1512, a Dutch artist depicted a remarkably modern looking dulcimer in a nativity scene (detail shown in Figure 11).

Although Renaissance artists pictured the dulcimer in courtly surroundings (see Figure 12), by the middle of the 16th century the instrument's social prestige had begun a gradual decline. Writing in 1536, the German scholar Sebastian Virdung characterized the dulcimer as an "instrumentum ignoble."¹⁵ Virdung's countryman Michael Praetorius (1571–1621), in his *Syntagma Musicum de Organographia* of 1619, classed the dulcimer (Figure 13) with the "peasant's lyra, key-fiddle, strawfiddle, little cymbals and bells, musical balls, and Basque tambourine, army kettle drums, snare drums, the anvil, and also other Muscovite, Turkish, strange and foreign instruments." He added:

Some of these justly could be called vulgar and crude instruments, or as Sebastian Virdung calls them, ridiculous instruments, since they are known to all and do not actually have anything to do with music.¹⁶

The reasons for the dulcimer's loss of status during the 17th century remain somewhat obscure. One of its standard uses was accompanying itinerant puppet shows, and this may have contributed to its decline. Or perhaps its popularity among the peasant class simply made it less attractive to the aristocracy. Two entries in Samuel Pepys's diary describe the dulcimer in decidedly unpretentious surroundings. On 23 May 1662 he wrote:

There coming much company after dinner to my Lord, my wife and I slunk away to the Opera. . . . After it was done, my wife and I [went] to the puppet play in Covent garden, which I saw the other day, and indeed it is very pleasant. Here among the Fiddlers I first saw a Dulcimore played on, with sticks knocking of the strings, and it is very pretty.¹⁷

A month later on 23 June 1662, Pepys recorded hearing another dulcimer at a London inn:

At noon . . . meeting with Frank Moore, my Lord Lambert's man formerly, he, and two or three friends of his did go to a taverne. . . . In the next room, one was playing very finely of the Dulcimer, which well played I like well.¹⁸

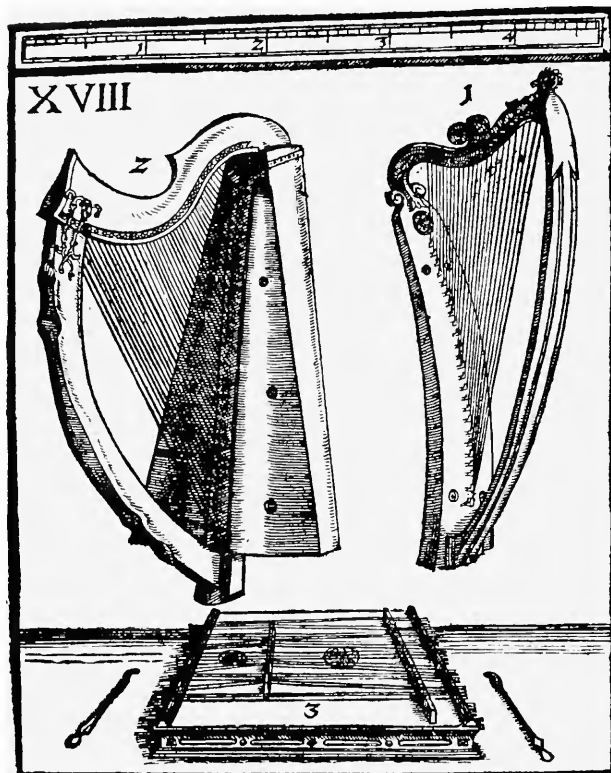

FIGURE 13.—Illustration of a 17th century German dulcimer and beaters. (From Michael Praetorius' *Syntagma Musicum de Organographia*)

1. Gemeine Harff. 2. Irkadisch Harff mit Weßlingen Saeten 3. Hochstrei'

By the end of 17th century, the European dulcimer had become for the most part an instrument of the common people, generally unacceptable for church and court use (Figure 14). Years later, this attitude was echoed by Sir John Graham Dalyell who wrote in *Musical Memoirs of Scotland* (1849) that the dulcimer, "formerly consigned to the humblest hands and rather an object of contempt . . . remained as an amusement of the populace."¹⁹ A series of



FIGURE 14.—*Cymbalschlägerin* (woman dulcimer player), an engraving by Johann Christoph Weigel (ca. 1720) reflects the instrument's increasing use by common folk.

dulcimer concerts given at Edinburgh in 1842 by the Nelson brothers of London moved Dalzell to write:

That [the dulcimer] should ever be deemed fit for introduction among polished society, or its powers adapted for exhibition to a public audience, would have certainly excited the wonder of earlier musicians. But where is there any attraction *ad captandum vulgus* spared in Britain?²⁰

There was at least one successful attempt, however, to treat the

dulcimer as a “classical” instrument. In the 1690s Pantaleon Hebenstreit (1667–1750), a young German violinist and dancing master, fled from Leipzig (and his creditors) to Merseburg, where he spent his days tutoring a pastor’s family and his nights at the local tavern. While there, he apparently was impressed by the *Hackbrett* and subsequently designed and built an improved version of this German folk dulcimer. Hebenstreit’s dulcimer was more than twice the size of the traditional folk instrument. One side of the instrument was strung with steel or brass wires for a bright, loud tone, and the opposite side with gut, for a softer sound. (The player presumably would have to reverse the entire instrument when a change in timbre was desired.) Hebenstreit also departed from the traditional diatonic tuning of the *Hackbrett*, using instead a chromatic one he invented by placing the treble bridge almost in the center of the soundboard. Although none of his instruments have survived, contemporary accounts indicate that they had over two hundred strings, and a compass of five full octaves.

Pantaleon Hebenstreit’s career was as eccentric as his instruments. During the 1690s he appeared in Berlin and Dresden and gained a regional reputation as a virtuoso. At Paris in 1704, he played for the French monarch Louis XIV; in return, the Sun King assured Hebenstreit’s place in musical history by christening the improved dulcimer a “pantaleon.” Returning to Germany in 1706, the musician was appointed dancing master to the court at Eisenach. Then, in 1714, he became chamber musician and pantaleonist to the Dresden court of August the Strong, King of Poland and Elector of Saxony. For these duties, Hebenstreit was awarded the handsome salary of 1200 thalers annually. (J.S. Bach (1685–1750), then cantor in neighboring Leipzig, was paid only 700 thalers a year for duties that included teaching, providing music each week for regular religious services, composing, and performing for weddings and funerals.)

Hebenstreit played for and influenced notable musicians and



FIGURE 15.—The late 18th century aristocrats' fascination with peasant life made the dulcimer once again fashionable among "people of quality." (Enching from Benjamine de la Borde's *Essai sur la Musique*).

composers of his era, including Kuhnau, Telemann, Fux, W.F. Bach, and possibly the great J.S. Bach. Gottfried Silbermann (1683–1753), a famous pioneer of early German piano building, also built pantaleons for Hebenstreit. In fact, the general interest aroused throughout Europe by the pantaleon and its ability to produce varied dynamics is cited by many musicologists as the inspiration that led several late 18th- and early 19th-century harp-

sichord builders to experiment with improved hammer mechanisms, which ultimately resulted in the pianoforte.

Hebenstreit's success also helped reintroduce the dulcimer at court and among the "better classes" (Figure 15). This renewed interest was sustained for a while by the fascination with which 18th-century aristocrats regarded the simple peasant life. For a few decades following Hebenstreit's death in 1750, his students continued to play and promote the pantaleon, but by the late 18th century the difficulty and cost of upkeep, combined with general public apathy, brought to an end the instrument's role in European art music.²¹

The Dulcimer in America

The first dulcimers in North America arrived among the household effects of British and other European colonists. Until the 1860s, written records of dulcimers in the United States were probably scarcer than the instruments themselves. Dulcimers were often built at home or in small wood-working shops, and documentation was haphazard rather than systematic. During the second half of the 19th century, however, we can trace the history and use of the American dulcimer through shop and factory records, patent claims, census schedules, advertisements, and interviews with the few surviving folk artists who still make and play them.

The traditional players still alive today are those who chose (or were persuaded) to learn a less and less popular instrument during the first three decades of this century. The generation born after the Civil War failed to pass many traditional skills on to their children. The World War I generation turned to the guitar, mandolin, and piano, which educators and the mass media endorsed as preferable to the old-fashioned dulcimer for popular music. From about 1930 until the folk revival of the mid-1960s there were virtually no new recruits to the instrument. Older

players continued to perform with varying degrees of talent and persistence through the 1950s, ignored by folklorists and the general public alike. These survivors of an earlier era were born between 1890 and 1920 (see Appendix C). Because of their early training and subsequent isolation from other dulcimerists, they have managed to preserve dulcimer traditions and regional playing styles that otherwise would have vanished.

The exact date of the dulcimer's arrival in the New World will probably never be established; musical instruments, especially small, homemade ones, tended to go unrecorded in our earliest annals. But undoubtedly the early colonists brought with them the instruments then popular in England and Europe. In the 17th century, these included fiddles, fifes, flageolets, flutes, harps, hautboys, jew's harps, recorders, trumpets, drums, and dulcimers.

An early reference to dulcimer music in America is found in the diary of Samuel Sewall (1652-1730), best remembered today as a judge at the Salem witch trials of 1692. His entry for 23 May 1717 reads: "To Salem, Meadford, Lodge at Cousin Porter's. See and hear the Dulcimer."²² We can speculate that the judge, a good singer with considerable musical knowledge, might have described the dulcimer had it been a new or unfamiliar instrument in New England.

Dulcimers also were being played in other parts of America during the 18th century. On 21 March 1748 "John Beals, Musick Master from London" advertised in Philadelphia's *Pennsylvania Gazette* as a teacher of

the Violin, Hautboy, German Flute, Common Flute and the Dulcimer by note. Said Beals will likewise attend young ladies, or others, that may desire it, at their houses. He likewise provides musick for balls or other entertainments.²³

Leaving Philadelphia, where he is thought to have played for the Philadelphia Dancing Assembly, Beals moved to New York City. Life was hard for itinerant musicians in colonial America, and by 1757 Beals chose to advertise himself in the *Weekly Post Boy* as a manufacturer of nets "to keep flies off horses," who would also play

for “Assemblies, at private Balls, or any other Entertainments.” Still later, Beals moved to Maryland where in 1764 he became a stocking manufacturer.²⁴ Dulcimer music was also popular in Maryland in the mid-18th century. A dulcimerist named Thomas Richison provided music for the Annapolis Tuesday Club of Baltimore, a society of rich planters, merchants, and seafarers.²⁵

Even more fortunate were colonial New Yorkers, who learned of the following entertainment through a newspaper advertisement on 27 April 1752:

This is to acquaint the Curious, That there is just arrived in this City, a famous Posture-Master, who transforms his Body into various Postures, in a surprising and wonderful Manner, with many Curious Dancings and Tumbings, exceeding any Thing of the Kind ever seen here. He also Performs the Slight of Hand, with great Dexterity, and Art; and to make the Entertainment more agreeable, the Company will be diverted with the Musick of a Dulcemer. To be shown every Evening this Week, at Mr. Beekman's at the Spring-Garden:—Price for Grown Persons One Shilling, and for Children Ninepence . . . it shall be exhibited by their very humble Servant, Richard Brickell.²⁶

This show proved so popular with New Yorkers that it was moved to the Nassau Street Theatre, where it entertained the citizenry for several more weeks.

The Dulcimer in its Prime: The 19th Century

The most persuasive evidence that the dulcimer once enjoyed great popularity is the survival of hundreds of 19th-century instruments. It is safe to assume that for every one that has survived, scores have not. A common response to the author's inquiries about dulcimers in many sections of the country was some variant of, “Ah yes, we had one in our barn, but we burned it for firewood in that terrible winter of 19—.”

The states in which the dulcimer enjoyed its greatest popularity, and where remnants of its traditions survive to this day, are those that formed the American frontier from 1810 through the 1840s:

western New York, Ohio, West Virginia, western Pennsylvania, Indiana, Illinois, Michigan, Wisconsin, and Minnesota. This geographical distribution seems to reflect frontier conditions and the need of pioneers for entertainment and recreation. The dulcimer, in many ways musically analogous to the piano, presented none of the transportation problems of its bulkier relative—a major consideration in wilderness areas settled before the coming of the railroads. Later pioneers, who settled even further west, came from the rapidly changing east coast or directly from Europe, where the dulcimer was no longer fashionable. The piano was becoming the instrument of choice, and after 1850 the expanding railroad network greatly eased transportation difficulties. The dulcimer tradition thus remained “frozen” among those who had moved “west” in the early part of the 19th century and their descendants who remained there.

Documentation is hard to find in these early frontier areas; the dulcimer, which existed outside both the “pure” classical and “pure” folk traditions of the 19th and 20th centuries, might well have been considered too commonplace an item to be mentioned by music scholars and folklorists. For example, folklorists Gardner and Chickering, in their book *Ballads and Songs of Southern Michigan* (1939), devote only a single sentence to the dulcimer, noting a player “who in former days . . . played a dulcimer which he had made.”²⁷ Yet even today, a casual survey of this area will uncover scores of extant dulcimers.

Some 20th-century musicologists have suggested that the dulcimer was popular with loggers in the Michigan woods and was known as a “lumberjack’s piano” or “whamdiddle,” but my field work failed to substantiate these names or the instrument’s use in logging camps. Chet Parker (born 1891), a traditional player from Grand Rapids who worked in several Michigan logging camps in the early part of this century, claimed that he was the only person there who played the instrument, and he could not remember ever seeing one in a camp.²⁸

Folklorist Henry Shoemaker, who documented and studied folk culture in western Pennsylvania, wrote:

No hunting shack along the Sinnemahoning in the old days or lumber camp in the Black Forest . . . was complete without musical instruments. The most numerous of these were violins, and mouth-organs; there were many accordions, and even a few dulcimers and harps. In the summer evening, after a day's work bark peeling was done, the crew would gather . . . and the song singer of the camp would begin his cycle of woodsman songs or old time ballads, while the camp's musicians would accompany him on violin, mouth-organ or dulcimer.²⁹

In his book *Mountain Minstrelsy in Pennsylvania* (1931), Shoemaker also discusses the *cimbalom*, the Hungarian version of the dulcimer, calling it "the favorite instrument of the Pennsylvanian mountain people."³⁰ While this seems unlikely, Shoemaker's description of it as a struck dulcimer establishes that he was referring to the hammered dulcimer, and not the three- or four-stringed Appalachian instrument.

Dulcimer Music and Its Social Setting

Since dulcimers in America were often used to accompany dances, most dulcimer pieces were dance or fiddle tunes, including reels, jigs, hornpipes, waltzes, clogs, and schottisches. Several 19th-century musicians and entrepreneurs published dulcimer tune books. John Low, Ezra Durand, and J.A. MacKenzie owned dulcimer shops and offered their own instructional systems, which included traditional tunes arranged for dulcimer. One method was C. Haight's *A Complete System for the Dulcimer* (1848), published in New York by William Hall & Son. Such books contain many tunes that are still played today, and which were almost certainly selected not only for their aptness as instructional pieces, but also because of their popularity among 19th-century dulcimer players. The majority were dance tunes, including "Soldier's Joy," "Durang's Hornpipe," "Devil's Dream," "Speed the Plough," "Money Musk," "Haste to the Wedding," and "The Opera Reel." Also included

were danceable minstrel songs, like “Boatman’s Dance” and “Miss Lucy Long”; popular melodies like “Yankee Doodle,” “Hail to the Chief,” and “Just Before the Battle, Mother”; and hymns like “Old Hundredth,” “Coronation,” “St. Martin’s,” and “Shall We Meet Beyond the River?” The compilers also included some “refined” pieces which they probably hoped would be more suitable to their instrument’s new role in the parlor; but selections like the “Grand March from Norma” and “Air by Rossini” never caught the fancy of most American dulcimer players.

The repertoires of surviving dulcimerists include many “nameless” tunes that they learned from their fathers and grandfathers. Cloise Sinclair, a player from Michigan reported: “So now I play them [but] I have no idea what the name of them is.”³¹ Possibly some of these now nameless tunes never had titles; most of them probably did. The younger players were too busy performing the music to worry about the name of each tune. Paul Van Arsdale recalls:

I originally played [the dulcimer] strictly for square dancing. You might sit down, and play for two or three hours steady; one square dance after another. And my main interest in those days was to learn a lot of different [tunes] so I wouldn’t have to play the same ones over and over. I succeeded in learning a lot of pieces, but I didn’t even bother to learn the names.³²

With the passing of older members of the community, the names of many tunes were lost.

Unlike England, where the “Yarmouth Hornpipe” and the “English Breakdown” are traditionally dulcimer tunes, America seems to have produced no tunes exclusive to the dulcimer.³³ H.E. Matheny remembers two, “Old Christmas Morning” and “Hughes’s River Glory,” as West Virginia dulcimer tunes, but this seems to have been traditional only within his family.³⁴

Despite instruction books and note indicators, most aspiring dulcimerists did not read music, and continued to learn just by “picking it up” from the older players. Paul Van Arsdale, a

grandson of Jesse Martin, remembers how the vaudeville star taught him to play during the 1930s:

We had two dulcimers, and we'd sit side by side. [If] he had something he wanted me to learn, why, he'd play a few bars. And then I'd play behind him and eventually [I'd] get the whole tune. Then, actually, you just play it over and over till you've got it memorized.³⁵

The vast majority of dulcimer players were men; H.E. Matheny estimates that in the late 19th century, the ratio of men to women dulcimerists in West Virginia was ten to one. This was not because the dulcimer was thought to be a particularly "masculine" instrument, but rather because the main musical function of the instrument involved playing at barn dances, and, in Matheny's words, "it just wasn't nice for a woman to play hammered dulcimer at a dance."³⁶

Traditional performers were aware of this attitude; Russell Fluharty of West Virginia explained:

There was a time when dances were frowned on, you know, especially the old square-dance kind. . . . I guess they didn't realize that it wasn't any worse kind of music than most. . . . People who are going to live that way don't need to have square-dance music to be that way.³⁷

But if playing at dances was frowned upon for women, it seems to have increased a man's status in the community. Dances provided a forum for the folk musician to show off his abilities and, at the same time, to provide a service to his friends and neighbors. It was thought a good skill for a man to possess; at least one informant candidly admitted that it was a good way to meet pretty women.

Paul Van Arsdale remembers playing in a western New York dance band during the Great Depression. Saturday night and holiday eve dances drew from 80 to 120 people; 8 to 10 sets of four couples each could dance at one time in the large finished barn. There was a charge for admission.

We had dulcimer, fiddle, and generally somebody playing accompaniment on the piano. Believe it or not, even in those days we had drums with it. . . . You'd dance what they called a "square dance," which included a jig, and then two reels. Then you'd have a round dance. . . . I guess they called it the fox trot even then. You'd start playing at 9:00 and you would play until 1:00 in the morning.³⁸

By the 1930s Van Arsdale, who was one of the few remaining dulcimer players in western New York, was often hired for the "novelty more than anything else . . . lots of people would come up and watch you play." But he enjoyed playing, and the \$2.00 or \$3.00 he earned for playing a four-hour dance was good pay for a teenager during the depression years.

Though most dulcimerists were men, some women did play, often at home for their own amusement, and sometimes in church to accompany hymns. H.E. Matheny recalled women dulcimer players "where there were no organists . . . [in] the little poor churches out in the country."³⁹ Use of the dulcimer in church services was certainly supported by the widespread belief that it had been mentioned in the Old Testament (see p. 10).

While dulcimers were played without accompaniment at home or in church, they were usually played with one or more other instruments at dances. The most common ensemble was a dulcimer played with a fiddle and a double bass or guitar (Figure 16), but other instruments like banjos, mandolins, guitars, pianos, melodeons, drums, saxophones, and tubas were also used. An advertisement that appeared in 1868 stated that the minstrel show "circus" of Messrs. Howes and Co., consisted of "dulcimer, banjo, tambourine, and bones."⁴⁰

Things Hawaiian, including Hawaiian music, fascinated Americans around the turn of the century. After 1915, when the Panama-Pacific Exposition opened in San Francisco to celebrate the completion of the Panama Canal, the fascination became a veritable craze. The dulcimer was included in the fashion at least by association; several



informants recall the unlikely combination of dulcimer and Hawaiian guitar in the 1920s. During that decade Jesse Martin's vaudeville act included Mrs. W.H. Biers of Erie, Pennsylvania, on the Hawaiian guitar.

One traditional player thought the ideal string band should consist of a dulcimer, two fiddles, and a rhythm guitar.⁴¹ None of the older players could remember seeing two or more dulcimers played together in the same group.

Dulcimers were also played at parties, picnics, town and school board meetings, county fairs, taverns, clubs, and contests—in short, any event at which rural or small-town people were likely to gather. One unusual place where a hammered dulcimer player worked was the Red Onion Saloon in Parkersburg, West Virginia. This den of iniquity was known to locals as “Baghdad on the Kanawha.” For years it supported a barrel dulcimer player whose dedication to his art is still remembered with admiration:

That was around the turn of the century. An Irishman ran the Red Onion, and it was bad. The police would never go down there, that was off limits.

Anyhow, there was a man, an old West Virginia hillbilly, went down there one day. He had a hammered dulcimer . . . and said he'd like to play there [at] night . . . for what little bit the customers would give.

And they said, “Well, we'd like for you to play, but they have a standing rule here. . . . Anyone can come in and play, but you're not allowed to stay the entire evening.” (That's these toughs' rules, to show them who is boss.)

“Well,” he said, “if you let me stay, I'd like to play a long time; I can do it.” So late that evening, here he came, down Market Street, his hammered dulcimer under one arm, [and] rolling a barrel with the other.

He asked the bar tender where he could set his barrel up, and he said, “over there in the corner.” He put the dulcimer on top of it—of course, that amplifies it—and started playing. Finally, one of these men started over toward him. [The dulcimer player] reached in his boot and pulled out a big knife, and he just stuck it in the side of the barrel and kept on playing.

He played [there] for twelve years, and no one ever bothered him.⁴²

FIGURE 16.—Dulcimerist Curtis O. Render (1874–1950), guitarist Lewis Dunlap and fiddler Otis Fish. Their group was photographed at Midland, Michigan, in March 1899. (Photo courtesy of F.E. Render)

Regional Playing Styles

The dulcimer was a folk instrument; hence, there was no single “right way” to play it. Although each performer had a personal style, certain techniques were definitely more common in one region than in others.

Players in Michigan, northern Ohio, and Indiana favored a playing style called chording, which involved sounding a series of arpeggiated chords. Because the instrument had no damping devices, this resulted in a continuous flow of sound and created an effect not unlike that of a piano played with the *sostenuto* pedal. The melody was then played on another instrument, usually a fiddle.

Many players only chorded, but a few good players took pride in their ability to play lead. Cloise Sinclair of Sheridan, Michigan, recalled that his father Eugene (ca. 1867–1925) was able to play melody, and “in those days, anybody that could lead on the dulcimer, that was something else.”⁴³

West Virginia dulcimer players had a fairly straightforward melodic style. They generally used much less arpeggiation than did most players from Michigan, and what they did use tended to be embroidered around a clearly defined melody. Long notes were often sustained by repeated attacks with alternating hammers. Modern West Virginia players seem to have been heavily influenced by syncopated banjo styles—naturally enough, since all those interviewed admitted to being avid fans of country, western, and bluegrass music. One player, Russell Fluharty from Mannington, included a much higher proportion of lyric songs and ballads in his repertoire than did dulcimer players from other regions, who usually preferred instrumental dance or fiddle tunes. He is also one of the few players to use the dulcimer to accompany his own singing. It is not known, however, whether this reflects a regional style or was simply a personal preference.

Another style existed in western New York State. There dulci-

merists usually played a complex melody line, which they frequently embellished by the addition of non-arpeggiated harmony notes. Parallel harmony in fifths was the most common, probably because parallel “sticking” across the instrument’s treble bridge resulted in this interval.

The New York dulcimer style featured a wide dynamic range, with polished touches like crescendos and diminuendos. Much of the information on New York state players, however, is drawn from the playing of Paul Van Arsdale, an exceptionally talented player who was taught by his maternal grandfather, the vaudeville dulcimer star Jesse Martin. How closely his playing reflects that of the average dulcimer player of 80 years ago is not clear. There may also have been a regional playing style on Long Island, New York, but unfortunately the last known local performer died before he could be recorded.

Little is known of the playing style in the Piedmont region of North Carolina. Piedmont players, of whom Virgil Craven (1903–1981) of Cedar Falls and Harvey Jones (born ca. 1913) of Coleridge are best known, have a style somewhat reminiscent of the West Virginia players. Although Piedmont players have bass courses on their dulcimers, they use them only occasionally. Craven’s repertoire included selections like “Chapel Hill Serenade,” “Little Darling,” and “Mississippi Sawyer.”⁴⁴ In general, chording was played with less syncopation than in West Virginia, and was less important than in the midwestern tradition.

Decline in Popularity: 1890–1930

Despite all the dulcimer building and playing in 19th-century America, enthusiasm for the instrument had begun to wane by the 1890s, and even earlier in New England. Though there were several causes for the decline, the major factor was social rather than musical. During the mid-19th century the dulcimer never achieved the level of social prestige enjoyed by the piano. With the

improvement of American shipping and land transportation after the Civil War, the fact that the dulcimer was so much more portable than the piano lost its former importance. At the same time, the price of pianos dropped during the late 19th century to a point where even country school buildings and grange halls could afford to have one.

The dulcimer, moreover, was thought to lack some of the extra-musical qualities of taste and refinement then attributed to other instruments, particularly the violin and piano. This view was fostered by partisans of “scientific” European classical music and a group of American music educators, led by Lowell Mason (1792–1872). Because of his influence, music education was introduced into the public schools in the 1830s. Teachers trained by his methods sought to elevate the general public’s taste in music above the level of indigenous folk forms. They also believed the “great European masters” could not be understood by ordinary Americans, and consequently substituted simpler, “harmonically correct” compositions of their own design. Their diligent efforts, many believe, succeeded in alienating much of America from its own traditional music and similar attitudes continue to inflict insipid songs and instrumental pieces upon American school children today. Instruments like the dulcimer, which had no place in European classical music, aroused little support or interest in the field of music education. Many genteel parents felt that their child’s mediocre performance on the piano or violin was preferable to excellence on a folk instrument.⁴⁵

Paul Van Arsdale, a traditional player from upstate New York, advanced the interesting theory that the dulcimer’s decline was also due in part to the difficulty in tuning it:

If you went someplace where there would be a piano, they’re not going to [re]tune . . . you’d have to tune your dulcimer. [This dulcimer] takes half an hour to tune . . . [unlike] a fiddle; five minutes, and in tune.⁴⁶

The decline was reflected commercially by the large mail order



FIGURE 17.—Joseph Edward Matheny (1879–1972), winner of the dulcimer contest at the 1895 Ritchie County Fair. (Photo courtesy of H.E. Matheny)

houses. Sears, Roebuck and Co., for example, stopped advertising dulcimers about 1903, although it was still possible to obtain strings and parts for several years thereafter. Smaller dulcimer-making shops went out of business entirely.

Russell Fluharty of West Virginia was typical of this World War I generation who thought the dulcimer “old-fashioned.” His uncle finally badgered him into learning it; but today, more than fifty years later, Fluharty still remembers how glad he was, as a young

man, to carry the instrument home early on a cold, dark winter's morning, without being seen by his neighbors.

In the 1890s dulcimers were still popular enough in West Virginia for the Ritchie County fair to hold an annual "dulcimer contest." In 1895, the winner of this county-wide competition was fifteen-year-old Joseph "Eddie" Matheny, who swept to victory on an instrument built by his uncle, Reuben Matheny, Jr., of Harrisville. In a picture taken immediately after the contest (Figure 17), Eddie reflects the pride that many other dulcimer players took in their venerable instruments.

Matheny saw the dulcimer fade and virtually disappear in his lifetime. Before his death in 1972 at age 93, however, it had been rediscovered by a small but dedicated new generation of folk musicians.

Twentieth Century Survival

The 1920s and 1930s were not totally bleak decades for the dulcimer in America. Though few new instruments were being built and very few youngsters bothered to learn to play, a few elderly performers still made occasional appearances, and there was at least one attempt to renew public interest in the instrument. Auto magnate Henry Ford, an enthusiastic country dancer, sincerely believed that old-fashioned dancing promoted old-fashioned morality. To further this cause, he established Henry Ford's Early American Orchestra in 1924 (Figure 18). Composed of a violin, double bass or tuba, dulcimer, and *cimbalom*, it played regularly for the square dances held at the company's headquarters at Dearborn, Michigan. All company executives were expected to attend. Because the dances were an attempt to reestablish the old virtues among the staff, alcohol, tobacco, and improper dress were banned. (Tradition maintains that stronger refreshments were available in a back room—without Ford's knowledge, of course.)

At first, Ford recruited musicians from among his plant's em-



FIGURE 18.—Henry Ford's Early American Orchestra included (left to right): William Hallup, *cimbalom*; Clayton Perry, violin; Gino Caporali, string bass; and Edwin Baxter, dulcimer. (Collection of Henry Ford Museum and Greenfield Village, Dearborn, Michigan)

ployees; before long, however, outside performers like Mellie Dunham, a champion fiddler from Lewiston, Maine, and Benjamin Lovett, a dancing master from Boston, were also invited. The dulcimer was one of Ford's favorites. He fondly remembered the playing of his Michigan schoolmate, Al Rice, and personally auditioned several dulcimer players for his Early American Or-



FIGURE 19.—Jesse R. Martin (1854–1939) received national attention when he auditioned for Henry Ford in 1925. (Photo from *New York Times*, 20 December 1925, Rotogravure section, p. 1)

chestra. He eventually hired Edwin Baxter (1881–1949), a player from near Cheboygan, Michigan, who could not read music. With the group's many dances and radio appearances the ability to learn new tunes quickly was indispensable; so Ford also hired William Hallup, a Hungarian immigrant who could read music and play the *cimbalom*. Hallup was able to help Baxter learn new tunes by playing through them until Baxter had memorized them.⁴⁷ The Early American Orchestra was active until Ford's death in 1947.

One of the dulcimer players who auditioned for Ford's Early American Orchestra in 1925 was Jesse R. Martin (1884–1939), a septuagenarian from Frewsburg, New York (Figure 19). Martin did not get the job, but this did not stop the retired cabinet maker from

launching a second career as a vaudeville artist. Billing himself as “Ford’s dulcimer entertainer,” Martin played for dances, grange and Kiwanis meetings, silent movies, and early radio broadcasts in the area around Fredonia, New York, and Erie, Pennsylvania. Martin played by himself as a “Musical Novelty Act,” with Mrs. William H. Biers of Erie, who accompanied him on Hawaiian guitar, or as a member of “Martin’s Old Time Dance Orchestra,” whose members also included a piano player, bass, guitar, banjo, and two callers.

Martin claimed to be one of only six remaining players of this “extremely rare” instrument. Though this claim obviously was exaggerated during the 1920s when scores of players were still alive, he quite possibly was one of America’s half-dozen best players at that time. Much of Martin’s repertoire, including unusual tunes like “Baker’s March,” “Waltz of Woes,” and “Jumping Jack,” has been preserved in the playing of his grandson, Paul Van Arsdale.⁴⁸

Records and Radio

Even before Ford’s campaign to revive the dulcimer, inventor Thomas Edison managed to record the performances of two fine 19th-century dulcimer players on Edison Cylinders. The first dulcimer recording artist seems to have been Roy Gibson, who in April 1901 cut three tunes: the “Gibson March” (EC# 7769), “Rosetzky March” (EC# 7770), and “7th Ohio Regiment March” (EC# 7771). In October of the same year, Gibson returned to the studio to record “March Arcadia” (EC# 7933). In June 1902 Edison recorded dulcimerist William A. Moriarty playing “Ain’t Dat a Shame” (EC# 8021). Moriarty returned in April 1904 to record “Llewellyn March” (EC# 8665).⁴⁹ Aside from the fact that they made these recordings, nothing is known about Moriarty or Gibson, though judging from the latter’s choice of material, it is possible that he was from Ohio.

Henry Ford's Early American Orchestra made some recordings during the 1920s, and their 1926 release, "A Medley of Reels," featured dulcimerist Edwin Baxter in "Wake Up Susan," "Pigtown Fling," "Mountain Hornpipe," "Flowers of Edinburg," and "Farewell to Whiskey." This seems to have been the last record featuring the dulcimer to be released for the next forty years.

Dulcimer players also occasionally appeared on early radio programs. The first to be broadcast was probably Fred D. Kunz (born 1892) of Long Island, New York. Kunz, who claimed to play a "Long Island" style of dulcimer that has since vanished, performed on a WNYC program, "The Voice of New York City," in 1922.⁵⁰ Jesse Martin appeared on several stations around Lake Erie in 1926 and 1927, including WKBN Youngstown, WLBD and WJPW Erie, and WMBW (location unknown).⁵¹ John S. Donald and his mother played on WIBA in Wisconsin during March 1927.⁵²

The radio performer with the largest audience, however, must have been Mrs. Cora Cline of Westmoreland, Tennessee, who drove over 100 miles round-trip to Nashville each week to appear on WSM's Grand Old Opry. Beginning in 1928 as a duet with her relative, Edgar Cline, a fiddler, Mrs. Cline was soon asked back as a solo act. She received one dollar for a minute of air time and played pieces like "Chippie Get Your Hair Cut," "Airplane Ride," and "Lexington." Uncomfortable about the weekly drive to Nashville, she eventually retired from the Opry.⁵³

Other Dulcimer Traditions in America

Although this monograph is devoted primarily to the use of the dulcimer in the Anglo-American tradition, there are several other types of dulcimer in 20th-century America that should be mentioned briefly.

Best known of these is the Hungarian *cimbalom*, a descendant of

the Turkish variant of the dulcimer that was played throughout the Ottoman Empire. Originally a folk instrument, the *cimbalom* was modified and mass-produced by the Schunda firm of Budapest during the 1870s. Brought to America by Eastern European immigrants around 1900, the *cimbalom* is still popular, but its use remains confined to the Hungarian-American community where it is frequently played in “gypsy orchestras.”

Another Eastern European type of dulcimer is found in Ellis County, Kansas, where it is played by descendants of the German-Russian refugees who immigrated there in the 1870s.⁵⁴ These dulcimers are trapezoidal, have 14 to 17 four-string courses, and a nearly equal number of treble and bass strings. They are distinguished from Anglo-American dulcimers by their large, carved toneholes (Figure 4). Though their use is declining somewhat in Ellis County, they are still played, usually with a fiddle and cello accompaniment, at *Hochzeits*, or wedding dances.

More recent has been the use of the Chinese *yang ch'in* in America. The *yang ch'in* (foreign zither) was introduced to China from the West during the 16th or 17th century. Similar to the Arabic *santir*, the *yang ch'in* enjoyed widespread popularity in China as a classical or “art” instrument, and is played in classical ensembles today in Chinese-American communities.

The most widespread dulcimer tradition in this country, other than the Anglo-American, has been that of the German-American *Hackbrett*. It was probably brought to America as early as the 18th century, although the earliest reference this author has seen is in the work of Lewis Miller (1796–1882), a German-American folk-artist from York, Pennsylvania, who painted his memory of a dance held there in 1808 (Figure 20). Included in this picture, which he captioned, “Stepfan, und Dar Hackbret, 1808, Dancing at the house of John Glessner,” is the explanation, “Stepfan a good violin player and his companion a German, playing on the indulcior, or barbiton nent, lyricum, ein hackbret.”⁵⁵ Miller was apparently unsure about the English equivalent of *Hackbrett*.



FIGURE 20.—Lewis Miller's memory of a dance held in the German-American community of York, Pennsylvania, in 1808. (Courtesy of The Historical Society of York County, Pennsylvania)

The *Hackbrett* and dulcimer apparently merged in German-American communities. It is probably significant that those areas where the Anglo-American dulcimer has survived longest, particularly northern Ohio, southern Michigan, Indiana, western New York, and North Carolina, are also regions with large and well-assimilated German-American populations.

Dulcimer Manufacture

Dulcimers were often built at home by the same people who played them, but many instruments were made commercially. For purposes of this discussion, we will consider dulcimer manufacture in three categories: factories, small shops, and folk-craftsmen.

The term factory applies here to firms employing several dozen

or more workers and producing hundreds or perhaps thousands of instruments annually. Although there may have been several such establishments, we know with certainty of only one: Lyon & Healy of Chicago. Shops, on the other hand, rarely employed even a dozen workers, and few produced more than 100 instruments a year. Unlike folk-craftsmen, shop workers were employed year-round, and building dulcimers was their main source of income. Shop owners were frequently entrepreneurs, quick to patent improvements in design, write and publish instruction books, and advertise their products in the hope of increasing sales and profits. Shop dulcimers were also much more likely to be labeled with the maker's name than were those made by folk-craftsmen.

Folk-craftsmen undoubtedly were the earliest American dulcimer builders. They worked in or near their homes, making instruments in their spare time for themselves or members of their communities. But because the earliest existing documents on dulcimer manufacture are those left by 19th-century shops, our history will begin there.

Dulcimer Shops

The first United States dulcimer patent was granted on 19 June 1860 to John Low (born 1816), who owned a dulcimer shop in Clinton, Massachusetts. Low's improvement consisted of placing the treble bridge "in such a manner as to cause that part of each string which is upon one side of said bridge to give a tone a half note higher than that part of it which is upon the other side."⁵⁶

In other words, Low's dulcimer, like that of Pantaleon Hebenstreit, (see p. 20) had a chromatic interval across the treble bridge. This, he assured the Patent Office, would be a "more harmonious action" than the fifth interval arrangement of the "common dulcimer"⁵⁷ (Figure 5). Low and his partner Albion Gibbs, asked \$15 for their standard dulcimer, and as much as \$35 for their fanciest model.⁵⁸ How long their shop operated in Clinton is not known, but they

were probably in business as early as 1858 when *The Dulcimer Instructor* (edited by J. Low) was advertised as “an instructor for the dulcimer: containing airs, marches, waltzes, schottisches, horn-pipes, and etc., also directions for tuning.”⁵⁹ *The Dulcimer Instructor* cost 50¢ and was published by Oliver Ditson and Company of Boston.⁶⁰

A few years later, on 31 December 1867, Ezra Durand of Norwich, Connecticut, received United States Patent No. 72,824 for dulcimer improvements which consisted of a “perforated sounding-post (E), perforated soundingboard (C), and perforated center bridge (I) . . . for the purpose of allowing the vibrating air to pass through, thereby increasing the softness and distinctions of the sounds.” To this was added a notched bass bridge (G), to elevate and separate the bass and treble strings⁶¹ (Figures 21, 22, and 23).

If this arrangement sounds familiar, it is because Durand seems simply to have patented the traditional folk construction. Ezra Durand was an entrepreneur whose dulcimer shop operated in Norwich from 1867 until 1869.⁶² Little is known about Durand’s life, but like John Low, he published a dulcimer instruction book to promote the sale of his instruments. In his book *Dulcimer without a Master*, which contained “Elements of Music, and Complete Instructions” in addition to a “Choice Selection of Popular Music Adapted to the Instrument,” Durand exuded unbounded optimism for his version of the instrument.

Durand’s Improved Dulcimer is a musical instrument that is coming into universal use, and is certainly getting to be an indispensable piece of furniture for the parlor or music room. It is nearly as large as a piano-case melodeon, and is finished in a rich rosewood case. It is strung with the same kind of strings as a piano, and has very much the same sound, only a much sweeter and softer tone. It is played with conveniently shaped hammers, which are covered with prepared wool. . . . When therefore, we consider the beauty of finish and richness of tone, and with what ease the knowledge of playing is acquired, how can we wonder that they have met with such rapid sale.⁶³

Lest the prospective virtuoso think that Durand’s Improved

Ezra Durand's Imp^d Dulcimer

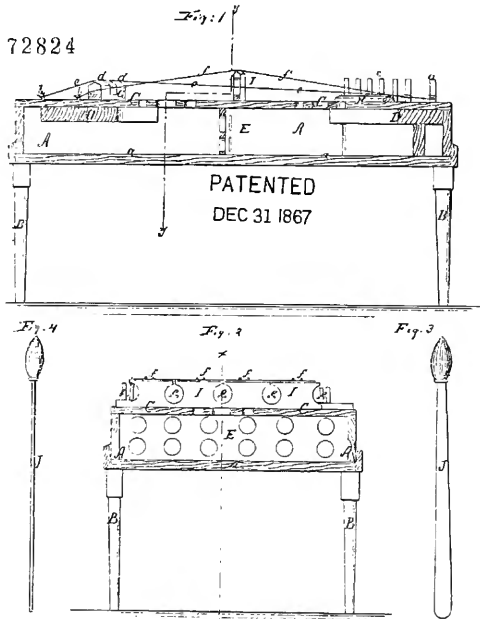

Witnesses
Geo. Smoker
J. C. Brown

Inventor
Ezra Durand
Per Munn & Co
Attorneys

FIGURE 21.—Ezra Durand's patent for an "improved dulcimer" was granted 31 December 1867.

Dulcimer was indestructible, the entrepreneur also included a postscript to his book on "How to Preserve the Instrument:"

The instrument should stand level on the floor or carpet, and should be covered with a woolen spread when not in use.

It should be kept as far from the fire as possible and care should be taken that the sun does not shine through the window on it, as it is very injurious to the wood, and is very apt to affect the varnish. . . .

To remove rust from the strings, use alcohol and brick-dust; rub it on the strings

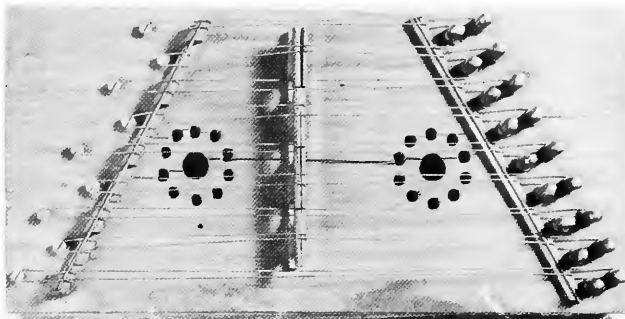

FIGURE 22.—This crude model was submitted by Durand to support his patent claim. (Collection of the Smithsonian Institution; catalog number 332,224)



FIGURE 23.—This instrument was produced by Durand's shop in Norwich, Connecticut, ca. 1868. (Collection of the Smithsonian Institution; catalog number 94,872)

with a piece of cotton flannel; but never use oil of any kind, as it will gum up the strings and prevent a clear vibration.

Anything lying loose on the soundboard, such as pins, buttons, nut shells or pencil, will cause a rattle, and is very disagreeable.⁶⁴

William Vogel, another Norwich resident and probably one of Durand's employees (since Durand was named assignor to Vogel's patent) claimed the invention of a pedal damping device that could be attached to parlor-model dulcimers. His patent, No. 84,027, was granted on 10 November 1868. There is no evidence that Vogel's invention was ever added to an American dulcimer, but his claim is notable since it antedated a similar but better-known device that Joseph V. Schunda, a Hungarian instrument builder, added to the *cimbalom* in the 1870s (see Appendix A).

Although the larger entrepreneurs like Durand and Low were located in New England during the 1860s, Chautauqua County in western New York had become the center of American dulcimer production during the preceding decade.

In the early 1850s, Morgan H. Sackett (1827–1919), from Dutchess County, New York, and his brother, Hiram B. Sackett (born 11 November 1824)⁶⁵ opened a small dulcimer shop in Irving (Figure 24). Like many other dulcimer makers, Morgan Sackett already played the instrument and had been trained in carpentry and cabinet building. Sackett dulcimers were of the “parlor” type, with a handsome cherry-wood case, and twenty-four courses of two strings each. Instead of the usual four legs, however, the instrument was supported by a single central pedestal of turned wood, which was steadied by three splayed feet. The instrument's two soundholes were covered by a round piece of wood veneer, from which a star design had been cut, and removable wooden overlays, found only on instruments from this shop, were fitted over either side of the dulcimer box to cover the tuning pins.

The Sacketts' shop apparently operated until the early 1860s, when Hiram married and moved to Kansas and Morgan sought outdoor work on the advice of his doctors. The Sackett shop was very small; family tradition maintains that only seven instruments



FIGURE 24.—Morgan H. Sackett (1827–1919) owned and operated a small dulcimer shop in Irving, Chautauqua County, New York during the 1850s. (Photo courtesy of Richard Sackett)

were manufactured and only six of these were sold. It is notable, however, because it was the earliest of the Chautauqua County dulcimer shops.⁶⁶

In 1855, Harrison S. Wade (born 1828 in Harmon, New York; died 1900, in Warren, Pennsylvania) and his brother Lewis (no available dates) moved from Pennsylvania to nearby Stedman, New York, and established a dulcimer shop. According to the 1855 manufacturing census the shop employed six men, and the Wades expected to produce 500 instruments that year for a profit of \$4,000.

Their rectangular dulcimers sold for \$12 to \$15, instruction book included. Veneered with curly maple, mahogany, or rosewood, they had tilde-shaped toneholes and eighteen courses: eleven

treble courses of four strings each, and seven bass courses of two strings each.⁶⁷ More expensive models of Wade dulcimers, “inlaid with rosewood, having a cover, with a plate glass mirror on the inside of the lid, and mounted on harp legs,”⁶⁸ sold for as much as \$50 according to Floyd L. Darrow, a local historian. The instruments were marketed by salesmen who traveled through Ohio, Pennsylvania, Kentucky, Missouri, Canada, and even the West Indies, demonstrating and selling their wares. In the Midwest, Wade salesmen were said to have bartered dulcimers for cattle, which they then drove overland to Chicago and sold for cash before returning to New York.

The end of the dulcimer factory that Darrow believed had made Stedman more widely known than any other hamlet in the States came in 1860 when a fire

destroyed the hotel, store, dwelling house and storage room. This store had been used as a finishing room in fashioning the dulcimers, and in the upper chamber many costly woods from Central America, such as rosewood and mahogany, and curled maple from this country had been placed. Such woods had been used for inlaying and veneering the instruments.⁶⁹

The loss had been uninsured and was followed closely by the outbreak of the Civil War when “the boys demonstrating [Wade dulcimers] in the South were obliged to leave hastily.”⁷⁰

The last Chautauqua County dulcimer shop was that of Henry Ransom (1809–1863), which opened on East Main Street, in Sherman, New York, in 1856. Among Ransom’s employees were his two sons, Martin and Monroe, expert dulcimer players who traveled through the South demonstrating and selling the instruments.⁷¹

The firm’s dulcimers, like the Wades’, seem to have sold well in Ohio and the South. Probably because of this, Ransom moved his shop to Newport, Kentucky (a suburb of Cincinnati), in 1860. According to the census of that year, Ransom had already invested \$3000 in his enterprise, plus an additional outlay of \$1565 for “miscellaneous articles.” He employed three male workers, probably his two sons and himself, at an average monthly cost of \$105, and foresaw producing \$4730 worth of dulcimers during that first

J. A. McKENZIE.
DULCIMERS AND SIMILAR MUSICAL INSTRUMENTS
No. 171,031. Patented Dec. 14, 1875.

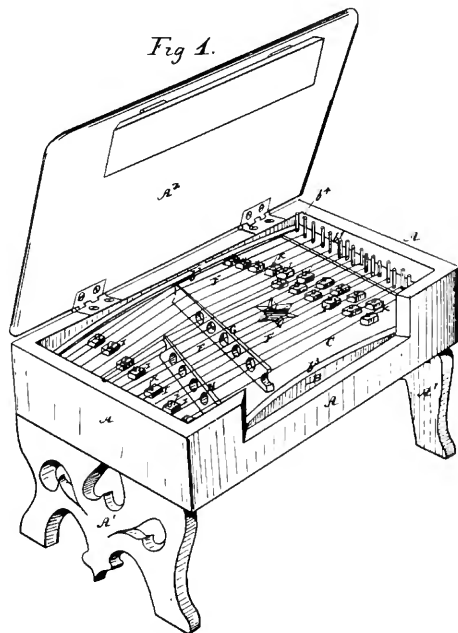

WITNESSES:
Collonne Brooks
AB Canaga

James A. McKenzie
INVENTOR.
per Rob. V. Atkey
ATTORNEY.

J. A. McKENZIE.
DULCIMERS AND SIMILAR MUSICAL INSTRUMENTS
No. 171,031. Patented Dec. 14, 1875.

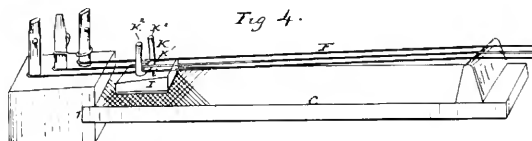
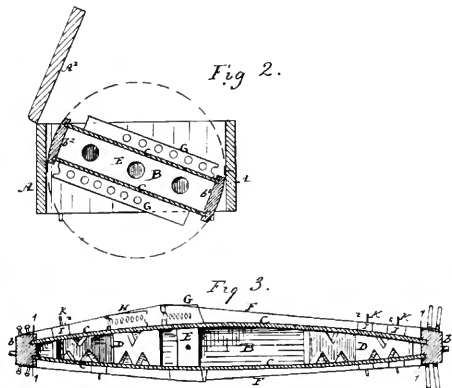

WITNESSES:
Collonne Brooks
AB Canaga

James A. McKenzie
INVENTOR.
per Rob. V. Atkey
ATTORNEY.

FIGURES 25, 26. — MacKenzie's first patent. His invention consisted of a dulcimer that had two usable sides and could be rotated in its case.

year.⁷² Ransom listed himself as a “piano-dulcimer manufacturer” in the 1861 *Newport City Directory*, and his sons, J.M. and Martin, were listed as “dulcimer dealers” at the same address on York Street. The Ransoms’ shop does not seem to have continued after its founder’s death in 1863.

Perhaps the most colorful dulcimer entrepreneur in 19th century America was James A. MacKenzie (1845–1905) of Minneapolis, Minnesota.⁷³ Born in Ogle County, Illinois, to Scottish immigrant parents, he was raised in Hutchinson, Minnesota, during the 1850s. The MacKenzies were known locally as a musical family, which was high praise in a town founded by the Hutchinson Family Singers. Family tradition claims that young James earned the money for his first musical instrument, a violin, by trapping an otter and selling its pelt. After an Indian uprising in 1862, the MacKenzies moved to Minneapolis, where young James worked for a while as a traveling musical instrument salesman.

In 1875, James MacKenzie was granted the first of his three patents for dulcimer improvements. With this patent, No. 171,031, he claimed the invention of a dulcimer with strings “mounted above and below the soundboard.” The entire instrument could then be turned upon end pivots, and the strings “on both sides utilized.”⁷⁴ The alternate sides would, of course, be tuned to different scales to increase the instrument’s range (Figures 25 and 26). While this idea is reminiscent of Hebenstreit’s pantaleon (see p. 19) there is no reason to assume that MacKenzie knew of the German’s invention. MacKenzie’s descendants maintain that the instrument was exhibited at the 1876 Centennial Exposition in Philadelphia; if it was, it was not listed among the prize-winning entries.

In 1880, MacKenzie married his fifteen-year-old protégée, Eva Skinner, already a trained singer. From that year until 1891, they toured the country together, demonstrating and selling his improved dulcimer (Figure 27). During this period, MacKenzie seems to have been fairly prosperous; his descendant Floyd Cohoes



FIGURE 27. — MacKenzie demonstrating his piano-harp. (Courtesy of Floyd Cohoes)

of Forest Lake, Minnesota, reports that he also owned a fashionable resort hotel on Lake Calhoun, Minnesota, at that time.

On 11 November 1890 MacKenzie was granted a second patent, No. 440,601, in which he claimed the truly novel idea of supporting the dulcimer's sounding-board with a "longitudinally-arched" cast iron frame, "in which the pins for the strings are set."⁷⁵ For business purposes alone, it would not do to let his creation share a name with the common folk instrument. MacKenzie seems to have been well aware of this marketing problem when he wrote:

My instrument may be called an “improved dulcimer”; but I have given it a new name of “piano-harp.” This name is more appropriate than dulcimer as defining the invention, because first, it may be played with hammers, and when so played it yields the full, deep tones of the piano-forte, and not the thin wiry tones of the old dulcimer; secondly, having placed each group of strings (giving the different tones) one-third closer to each other than they are on the ordinary dulcimer, the player is able to reach an octave of strings with the fingers, as upon the piano-forte, so that when playing with the hammers (one in each hand) the fingers may also be brought into play in the same strain of music either alternately or without breaking the time, thus giving the results of both piano and harp.⁷⁶

In this passage, MacKenzie makes it clear that he conceived of his instrument primarily as a dulcimer, and not, as some modern performers have contended, as a plucked instrument like the psaltery.

In 1891, MacKenzie reached the peak of his career. On 27 October of that year, he received his third and last patent, No. 461,915. In it he completely avoided the term “dulcimer” in describing his new chromatic instrument of a “double harp-like contour”⁷⁷ (Figures 28, 29). Like his second patented invention, this new piano-harp also had a cast metal frame, but he added to this the novel concept of constructing separate sounding chambers under each bridge, and then building the instrument into an upright piano-like case.

Like other entrepreneurs before him, MacKenzie also wrote and published an instruction book to promote the sale of his invention. The *Piano Harp Book* (?1891) was based on his own copyrighted “method of music notation,” which he claimed was so simple that even “Children Learn who Know Their A.B.C.’s”⁷⁸ (Figure 30).

According to family tradition, MacKenzie left Minneapolis in November 1891 with his wife and two young daughters, bound by train for New York City, where he planned to form a large stock company to help underwrite the expenses entailed in expanding his piano-harp venture. Possibly he intended to travel on from there to Washington, D.C., to copyright his instruction book and notation system. At Toledo, Ohio, however, their stopped train

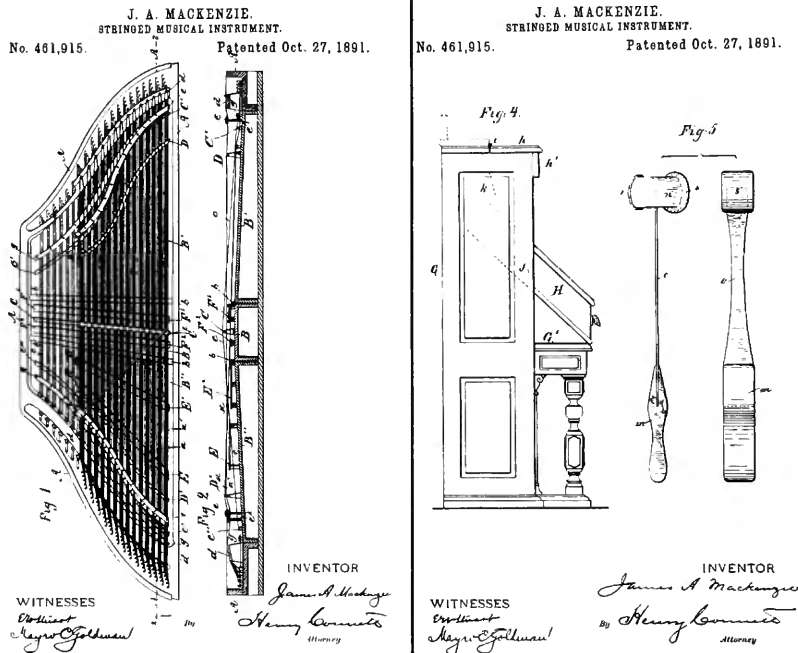

FIGURES 28, 29.—MacKenzie's third patent for a "new" instrument of a "double harp-like contour." Notice its separate sounding chambers (B^{xx}, B, and B^x), and the use of an upright piano case.

was rammed by a locomotive, and the resulting boiler explosion fatally scalded Eva and her two daughters.

The tragedy temporarily diminished MacKenzie's will and ambition. Several years later, however, he again organized a touring musical troupe and married one of its members. He continued to make dulcimers in his shop; from 1895 to 1898 he was listed in the *Minneapolis City Directory* as a "harp manufacturer." Unfortunately, bad luck persisted; his wife deserted him, and his shop, reported

6

THE DEVILS' DREAM.

ARRANGED BY J. A. MACKENZIE FOR THE PIANO HARP. IN HIS NEW COPYRIGHTED SYSTEM OF LETTER NOTATION.

F	A	G	A	F	A	G	A	F	A	G	A	E	F	F	D	C	D	F	F	D	F	F	D	F	F	A	G

F	F	A	G	A	F	A	G	A	E	A	G	A	E	F	F	D	F	D	F	E	D	C	A	R	A	A	A

F	C	E	E	C	E	E	C	E	E	F	F	D	C	D	F	F	D	F	F	D	F	F	A	G		

F	E	C	E	F	C	E	E	F	F	D	C	D	F	E	D	C	A	R	A	A	A					

JENNY LIND POLKA.

F	A	G	B	A	F	F	F	E	F	F	F	D	D	D	F	F	F	E	F	F	F	D	F	D	

D	B	R	B	B	A	F	F	F	F	G	E	E	E	F	D	D	D	A	F	F	F	F	G	E	E	E	D	F	D

FIGURE 30. — MacKenzie's copyrighted letter notation from his *Piano Harp Book*.

to have contained over 100 instruments at the time, was destroyed by fire. He married a third time, but was again widowed, and finally died by his own hand on 4 May 1905.⁷⁹

MacKenzie's notation system was quickly forgotten. Though some piano harps survived and a few are still played, their production and promotion ended with his tragic death.

Factories and Mail Order Merchandisers

Although small shops produced dulcimers throughout the 19th century, larger dulcimer factories appeared only during the 1870s. Actually, there was only one such firm whose operations we can document with certainty: the Lyon and Healy Co. of Chicago, Illinois, which manufactured dulcimers for sale through mail

order houses like Sears, Roebuck and Co. and Montgomery Ward.

Ward's spring-summer catalog for 1895 gave the following description of Lyon and Healy's "Perfection Dulcimer":

American made. Imitation rosewood, neatly decorated body, finely finished, chromatic, can be perfectly tuned in all keys; in short it is the most complete, carefully made instrument of its kind produced. \$16.00⁸⁰

The instrument's design was unusual in that it had two separate bass bridges (see Figure 31). The catalog's claim notwithstanding, however, it did have a standard fifth interval across the treble bridge; hence it was "chromatic" only in the sense that it could be retuned into various keys. To play "chromatically," the performer would have to be a virtuoso with the tuning hammer.

That catalog also offered dulcimer beaters with flexible handles and felt-covered heads for 35¢ a pair; dulcimer wire for 40¢ a quarter pound; and "dulcimer pins, steel blue with square or oblong heads," for 12¢ a dozen.⁸¹ The \$16.00 that Ward's asked for its dulcimers was quite expensive; only the deluxe models of banjos and violins sold for more. Sears offered the same Lyon and Healy "Perfection Dulcimer" several years later for only \$13.85; this was a real bargain since Sears's price included "one pair of

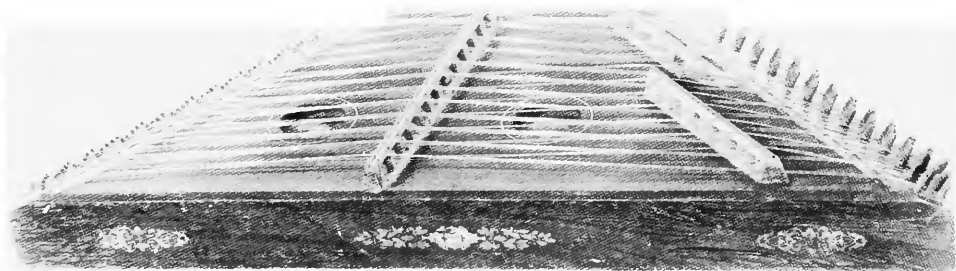
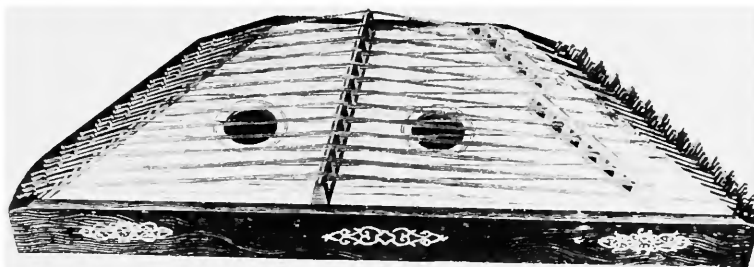

FIGURE 31.—Lyon and Healy's "Perfection Dulcimer" had two separate bass bridges. (Collections of Henry Ford Museum and Greenfield Village, Dearborn, Michigan; accession number 25.1391)

DULCIMERS.
OUR OWN MANUFACTURE.



No. 12.

Finely Finished Imitation Rosewood and Neatly Decorated Body, Chromatic, can be Perfectly
Tuned in all Keys; the most complete, carefully made Instrument of the kind produced \$42.50

FIGURE 32.—Advertisement from the Lyon and Healy catalog from the 1890s. The price was typically inflated to allow for negotiating with purchasers.

beaters and complete instruction book⁸² (see Figure 32).

The history of two other “factories,” if in fact they ever existed, is much hazier. One of these was the Joseph E. Stroehlein Company of Brooklyn, New York. Stroehlein’s trapezoidal instruments were painted a rich shade of gold and profusely decorated with two large clusters of eight small toneholes and four smaller six-hole clusters (Figure 33). Two American eagle decals adorned either side of the centrally placed chromatic bridge, and the name “Stroehlein” was stenciled in the lower right hand corner of the instrument. Stroehlein’s dulcimers had fourteen courses of six strings each, and lacked a bass bridge. On some instruments, a decal located in the lower left corner advised the purchaser that a prize had been awarded to the dulcimer manufacturer at the National Exhibition at Philadelphia in 1876. (Stroehlein is not listed among the prize-winners in the Centennial Exhibition cata-

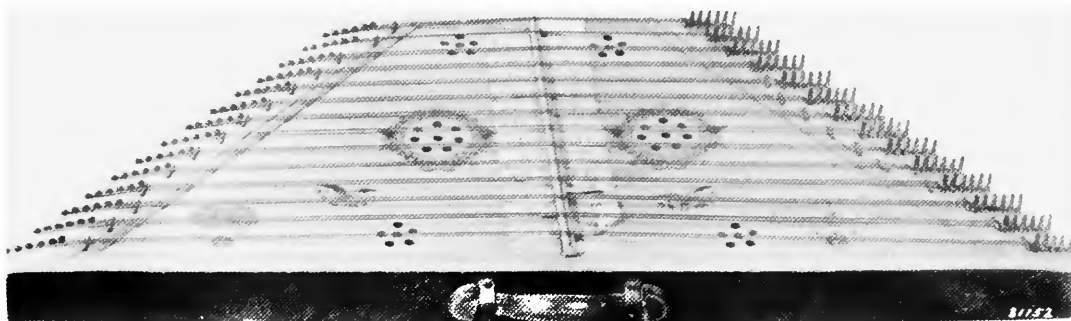

FIGURE 33.—Stroehlein's chromatic dulcimer, Brooklyn, New York, ca. 1876. (Collections of Henry Ford Museum and Greenfield Village, Dearborn, Michigan; accession number 00.4.1717)

log, and no record of a “National Exhibition” has surfaced.) Based on the serial numbers of extant Stroehlein dulcimers, the firm seems to have manufactured several thousand instruments during the 1870s; yet oddly, it is not listed in the *Brooklyn City Directory* for that decade.

Also unclear is the connection between Stroehlein's firm, and the Stonitsch Company, also of Brooklyn. The latter sold instruments almost identical to those marketed by Stroehlein, and seems to have been in business at about the same time. It is conceivable that neither company manufactured their dulcimers, but rather bought premade dulcimers, and simply added their own names and decorations. (This was a widespread practice among 19th-century musical instrument purveyors and continues even today.) Indeed, the central chromatic bridge of the Stroehlein and Stonitsch instruments suggests that they might have been imported from Germany.

Wires, pins, and tuning hammers could also be obtained through large piano supply houses. Even today, the American Piano Supply Company of New Jersey lists several sizes of wire as

“dulcimer gauge;” as if to underscore the instrument’s modern obscurity, these items are now suggested for use in cheese cutters.⁸³

Folk-Craftsmen and Their Regional Styles

Those who did not want or could not afford mass-produced dulcimers often chose to make their own. Construction of a playable instrument required only some wood, pegs and wire (which could be ordered through the mail), and a modicum of skill.

There was no formal apprenticeship system to train folk-instrument builders. They usually learned some carpentry by watching family members or neighbors, and applied that skill to building dulcimers. The instruments they made were for their own use or to sell to neighbors and relatives, almost always on the advance order of the prospective buyer. Unlike shop and factory workers, they did not rely on instrument building as a primary source of income. Many were farmers, cobblers, or carpenters, making dulcimers in their spare time to bring in a few extra dollars. Their output rarely exceeded two or three instruments a year; indeed, some probably built no more than two or three in an entire lifetime.

These craftsmen printed no instruction books, patented no improvements, and advertised only by word of mouth. Folk-craftsmen rarely signed their instruments. Members of their communities already knew who had made what instrument; besides, signing seemed to some makers inappropriate. As one informant explained, “If a man buys my instrument, that’s his. Why should I stick my name in his instrument?”⁸⁴ Those who are remembered, either because they did sign a piece of their work, or because their descendants still speak of them, are only a small percentage of the hundreds whose unsigned, anonymous instruments recall their existence.

Dulcimer shops can be discussed chronologically, but folk-craftsmen, strongly influenced by regional features and local traditions, are more easily classified according to the four major

geographical styles of dulcimer construction that have thus far been identified; New England, the Piedmont region of North Carolina, West Virginia, and the northern Midwest.

NEW ENGLAND.—Paradoxically, it is in New England, where Judge Sewall wrote of seeing a dulcimer in the early 18th century and where dulcimer shops abounded in the 19th, that documentation of the dulcimer's use as a folk instrument is hardest to find. Perhaps this is because this instrument's popularity began to fade in the face of growing public concern with the "reform" of music during the early 19th century. Although this reform movement ultimately spread to other regions of the country, its impact was first felt in New England. Lowell Mason (1792–1872), the Boston Handel and Haydn Society (est. 1815), and the forces of "scientific music" had by the mid-19th century already succeeded in stamping out much of the region's traditional music (see p. 34). Since much of the information about any folk or popular instrument comes from personal recollections, the early decline of the dulcimer in New England seems to explain why it is not remembered there today, even by elderly informants.

There are not enough extant New England folk dulcimers to allow many generalizations about regional construction styles. If the shop-built dulcimers made in Massachusetts and Connecticut are typical, the people of this region preferred rectangular instruments with two single-piece bridges and approximately twice as many treble courses as bass courses (Figure 23).

Yet a dulcimer built in the workshop of Charles "Henry" Bryant at Wolfeboro, New Hampshire, in 1898, differs in every respect from the region's shop-built instruments (Figure 34). It is trapezoidal in shape, with individual "chessmen" bridges; it has an almost equivalent number of treble and bass courses, hand-forged "fish-tailed" pegs, and two triangular, cloth-covered toneholes built into the back of the instrument. While most shop-built New England dulcimers were stained or veneered a dark wood color, Bryant chose to paint his dulcimer orange. Henry Bryant (ca. 1840–1923)

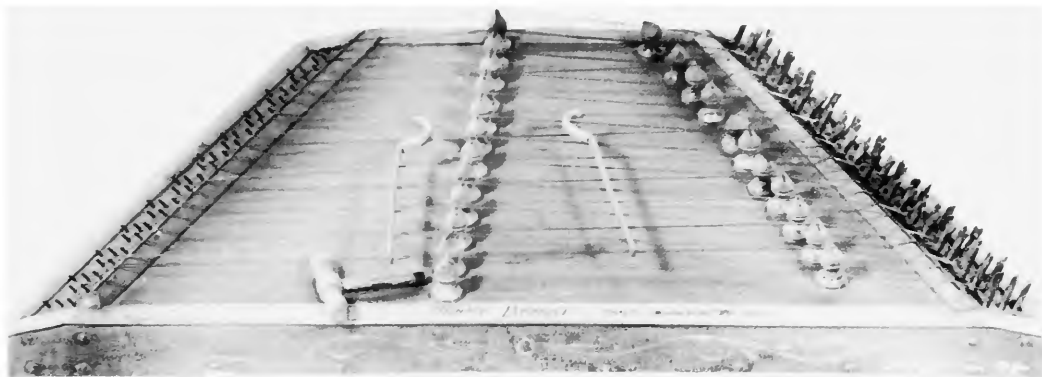

FIGURE 34.—Built by Charles “Henry” Bryant at Wolfeboro, New Hampshire, in 1898, this dulcimer has individual turned bridges and handmade fishtail-shaped pegs. Toneholes are in the back. (Collections of Henry Ford Museum and Greenfield Village, Dearborn, Michigan; accession number 00.3.13111)

was a farmer and a cabinet maker who was well known for building fiddles.⁸⁵ What inspired him to build a dulcimer, and whether this surviving example is typical of a regional or local folk style, remain unknown.

Another New England builder about whom little is known was Milo Skiff, a shingle-maker who made rectangular dulcimers decorated with black paint in Sharon, Connecticut, during the mid-19th century.⁸⁶

PIEDMONT, NORTH CAROLINA.—The Piedmont region of North Carolina yields a great many homemade dulcimers built during the 19th century. Dulcimers from this area tended to be trapezoidal with individual “chessmen” bridges and unusually deep bodies. Walnut and white oak were used in construction, and most Piedmont dulcimers were heavily braced.

Piedmont dulcimers had both treble and bass bridges, and two large circular toneholes seem to have been preferred. Some modern Piedmont dulcimer players substitute a single-wound guitar

string for each bass course, but it is uncertain when this practice originated or how widespread it was.

As in other areas, the names of only a few Piedmont folk-craftsmen are remembered. Harvey Jones, a traditional maker from Coleridge, recalled being taught to build dulcimers in the 1950s by Fred Phillips, a furniture maker from Asheboro. Phillips, in turn, had been taught by Mann Scott of Ramseur, who learned the art from a man named Robbins who was active around the turn of this century.⁸⁷ Many dulcimers survive in the area around Asheboro, particularly in the Uwharrie Hills, but much research remains to be done on the makers and players of this region.

WEST VIRGINIA.—In no area of the United States was the folk-craftsman's regionalism more pronounced than in the area that is today West Virginia. Unlike other northern and eastern states, West Virginia had no large dulcimer shops or factories to establish or influence stylistic development. The unique design used in the region is in many ways the farthest removed from European antecedents. It seems to have evolved quite early among local folk-craftsmen.

The typical West Virginia dulcimer was built of yellow poplar wood and had an extremely shallow rectangular body, often only three inches in depth. Each of the nine treble courses had an individual bridge, usually unturned and triangular in shape; there were no bass courses. The soundboard had four round, inch-wide, augured toneholes.

An excellent example of a West Virginia dulcimer is owned by the well-known traditional musician Russell Fluharty. His instrument, made near Mannington possibly as early as the 1840s, is 44 inches long, 15 inches wide, and 3 inches deep. Because of the thickness of the yellow poplar boards, there is only about an inch and a half of resonance space within the instrument (Figure 35). Flat-headed screws were used in lieu of iron pegs for the tuning pins, and the pitch is adjusted with a small screwdriver. The original hammers were eight inches long and made of white oak

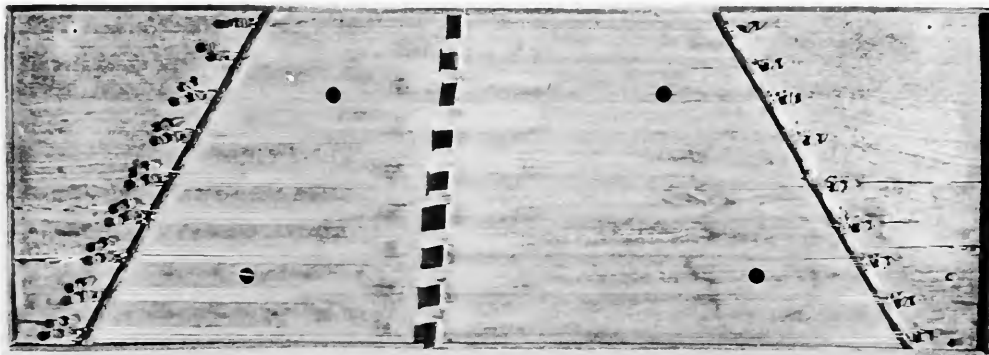

FIGURE 35.— This typical West Virginian dulcimer, made of yellow poplar, has a shallow rectangular body, an unusual tonehole arrangement, and lacks a bass bridge. It was made near Mannington, ca. 1840. (Photo courtesy of Russell Fluharty)

splints (or splits) that had been steamed and bent into shape.

The construction of Fluharty's dulcimer is typical for the region; its tuning, however, is unusual. Instead of the standard interval of a fifth across the treble bridge, the pitches on the right-hand side are a fourth lower than those on the left. The notes G, A, B, C, D, E, G, A, and B are found to the right side of the treble bridge, and the notes C, D, E, F, G, A, C, D, and E to the left. This arrangement seems to have been quite rare.

The craftsmen who built folk dulcimers were no less concerned than were small shop entrepreneurs about the overall aesthetic quality of their instruments. Their options, however, were much more limited. To finish and decorate their dulcimers, West Virginia craftsmen often turned to traditional local materials. According to Herman Matheny, the pokeberry was such a source:

Those people didn't have money to go out and buy everything they wanted, so they squeezed the pokeberry juice—which was very red—and they stained their hammered dulcimers with pokeberry juice, that's called “poke finish.”⁸⁸

The same informant described a finish made of buttermilk mixed with red clay. It gave the wood a distinctive reddish hue; like most of these finishes, it was also used for furniture. Matheny also recalled a potato finishing technique used to enhance plain wood:

If you have wood that's very uninteresting, especially soft wood . . . that's going to come out very plain, and you don't like that.

They'd take a piece of raw potato and rub it into the wood; you know, make designs, whatever they'd want on the wood. Then they put a coat of clear varnish on it. And then, wherever that potato touches, why, that will stay light . . . and the rest [becomes] dark.⁸⁹

Other commonly used natural dye materials were the outer hulls of walnuts, which produced a brown finish, and “madder” weed for a reddish hue.

Even such normally mass-produced items as tuning pegs could be made within the rural community; Cloise Sinclair of Michigan recalled:

They didn't have pegs like they got now. The blacksmith made them. To make a hole through . . . he took a chisel and he cut a notch in the side of the pin, and then he made a lip . . . He'd lay something in there, and then hammer the lip back over so there'd be a little hole to put the wire into. And [then] he made a key to tune it.⁹⁰

In West Virginia, as elsewhere, only a few folk craftsmen are remembered by name. Raymer Price, who worked around the turn of the century, and William Varner (1858–1937) built dulcimers for the people around Mannington. Varner's instruments reportedly sold for \$1.50. Price's were remembered as having a painted star around each of the toneholes. Other makers in the area included: Thomas J. Doolittle (born 18 July 1853) of Marion County; Morgan Matheny (working in the early 1900s) of Lubeck; Joseph Price (born 1856) of Metz; Ira Mayfield (1886–1972), and his father, Ira Mayfield, Sr. (born 1865) of Tyler County.⁹¹



FIGURE 36.—Reuben Matheny, Sr. (1809–1877) brought his dulcimer-building family to Harrisville, West Virginia, in the 1860s. (Photo courtesy of H.E. Matheny)

Perhaps the largest clan involved in dulcimer making was the Matheny family of Harrisville, and later of Waverly, West Virginia. Reuben Matheny, Sr. (1809–1877), a part-time Union spy during the Civil War, brought his family to the newly formed state of West Virginia after surviving a lynching attempt in Highland County, Virginia (Figure 36). The family's trade was shoemaking but the youngest son, Reuben Matheny, Jr. (1857–1936), learned how to make dulcimers from his father and built a few in this spare time in the room above the family's cobbler shop in Harrisville. He was occasionally helped in this part-time undertaking by his brothers,



FIGURE 37.—Reuben Matheny, Jr. (1857–1936).
(Photo courtesy of H.E. Matheny)

Thomas Marion (born 1839), Archibald (born 1841), Conrad (born 1849), and Decatur (born 1852). They did not think of themselves as instrument builders. “Dulcimer making wasn’t a living; [it] was as a sideline. They were shoemakers . . . when there were no shoes to repair, they made dulcimers.”⁹²

In 1880 Reuben Matheny, Jr. moved to Waverly, West Virginia, where he opened a barber shop (Figure 37). Between customers, he built dulcimers, and when his shop burned in 1890, he moved again to Parkersburg, West Virginia. Herman Matheny, a descendant, recalled how Reuben marketed his instruments:

He charged \$8.00 apiece. . . . That was an enormous amount then; that was eight days’ wages. But he sold them on time . . . a dollar down and a dollar a month. He

traveled around over the country [collecting his payments], and if he got \$3 he was satisfied. Sometimes the people would pay him the full \$8 and sometimes they wouldn't pay him anything. But he charged \$8 because he wanted \$3.⁹³

THE NORTHERN MIDWEST.—In this region, comprised of western New York State, Pennsylvania, Ohio, Michigan, and Indiana, dulcimer shops produced handsome rectangular “parlor” instruments. The area’s folk-craftsmen, however, preferred smaller trapezoidal dulcimers, with 11–14 treble courses and 6–8 bass ones. Treble courses usually had more strings than did bass courses; both treble and bass strings were tightened over one of the two single-piece, perforated bridges. The most common tonehole design was a single large circle surrounded by an outer ring of eight to ten smaller holes (Figure 4). Dulcimer design varied considerably within this large region, and dulcimers matching this general description were also made in other parts of the country. There are, nonetheless, a great many dulcimers from this area with these general features, which seems to indicate a coherent regional style. Possibly this type of dulcimer developed in western New York and was brought westward to the newly opened Northwest Territory during the first half of the 19th century. A story in a 1927 Madison, Wisconsin, newspaper mentioned a “young cabinet-maker named Orrin Sweet who came from New York state to make and sell [dulcimers] to the pioneers of Dane County [Wisconsin] in 1857.”⁹⁴ The fact that many of the remaining traditional dulcimer players in Michigan and Ohio claim descent from early New York settlers would also tend to support this theory. Still, the theory of origin and dispersal remains only speculative.

From mid- to late-19th century, there were scores of folk-craftsmen in this area. Typical of Ohio builders were the Hackett brothers, (born in Dryden, New York), Joseph “Wheel” (1834–1908) and Gene (no available dates), who built dulcimers at their home on Maple Street in Liberty Center, Ohio, during the 1890s.⁹⁵ Their trapezoidal instruments usually had twelve quadruple-strung treble courses and five double-strung bass courses; measured 42 inches in length at the bottom and 20 inches at the top, 15 inches wide, and

4 inches deep; had individual bridges; and came complete with a lid.⁹⁶

As elsewhere, it is not easy to discover names of 19th-century Midwestern dulcimer makers or details about their activities. This author has found only a few names. Martin Bates reportedly built beautiful parlor model instruments in Mount Effrum, Ohio, during the 1850s.⁹⁷ Perry Wight (1825–1900) of South Alabama, Genesee County, New York, built dulcimers for himself and many of his relatives during the mid-19th century.⁹⁸

New England, West Virginia, the Piedmont region of North Carolina, and the Northern Midwest all produced instruments in distinctive regional styles during the 19th century, but the dulcimer was not limited to these areas. There have been reports of dulcimers in Alabama, Florida, Texas, Missouri, Oklahoma, Arkansas, California, and many Canadian provinces. The Hulan brothers built and sold dulcimers outside of Nashville, Tennessee, during the 1880s and 1890s. It is not known if their instruments were typical of that region's style, because not enough Tennessee-made dulcimers have yet been identified. The author hopes that eventually enough examples will surface to permit generalizations about the folk-craftsmen of this and other areas.

VARIANTS.—Occasionally one comes upon a dulcimer that does not resemble any known style, or an otherwise standard folk dulcimer that has been “improved” by its maker. The folk-craftsman, in his attempt to build a slightly better instrument, often created somewhat eccentric examples. While the 19th-century entrepreneur probably would have patented these inventions, the folk-craftsman rarely left more than the instrument itself, or stories told by his skeptical neighbors, to let the modern world know what he had accomplished.

Take for example the anonymous inventor of the “barrel-dulcimer” (Figure 38) described by Herman Matheny. He claimed that this was once quite common in West Virginia (a contention as yet uncorroborated) and described it as “an instrument to play dances

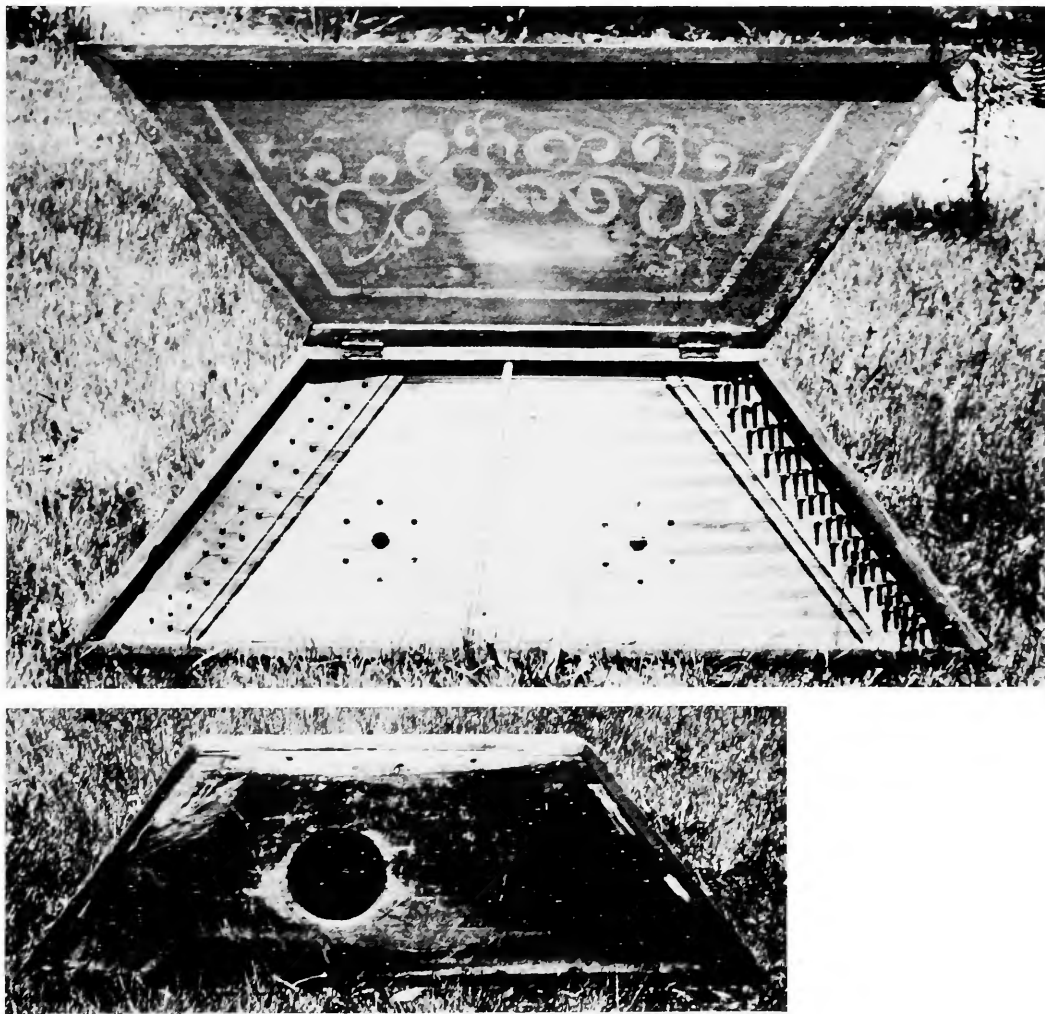

FIGURE 38.—Front and back of a "barrel dulcimer." (Photos courtesy of H.E. Matheny)

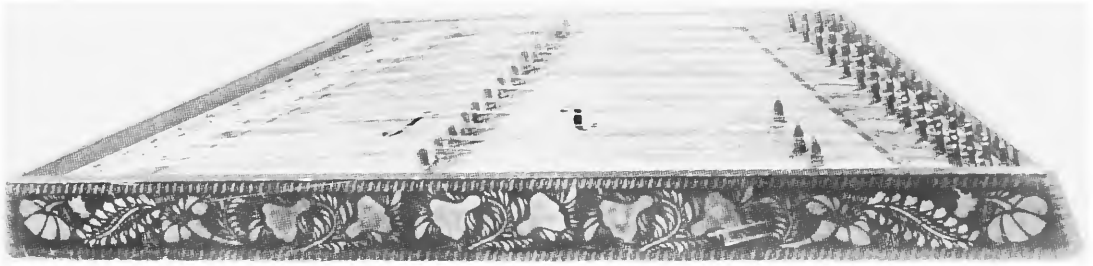

FIGURE 39. — Stencil-decorated dulcimer, possibly from the Midwest, ca. 1880. (Collections of Henry Ford Museum and Greenfield Village, Dearborn, Michigan; accession number 33.73.1)

and things like that. They'd cut a big hole in the back end of [a dulcimer]; they just put it on an empty [sugar] barrel. That amplified it, you can hear that thing a mile! [The] hole was cut off-center to keep away from [the instrument's] internal cross bracing."⁹⁹

Another West Virginian remembered seeing what — for want of a better term — might be called a “cabin model” dulcimer:

One time I went over to visit a man that had a dulcimer in a little community close to here called Jimtown [West Virginia]. And the man there had a dulcimer [that] had four holes in the corners of it. . . . He said, “At home in the old house, we put a rope through each one of those holes, and up over a pin over the joist” (that were old logs up over head that went over to the corner of the house) “and we had a weight on it over there that would just balance the dulcimer.” And I said, “Why'd you do that?” and he said, “Well, the main thing was to keep it away from the kids.”¹⁰⁰

Even this informant thought the counterbalanced dulcimer was an unusual arrangement, but added that the man who had shown him the instrument seemed to think it was important.

Some instruments were unique simply because their makers took the time and trouble to make them into beautiful examples of folk

art. For example, the dulcimer in Figure 39 is a well-crafted but hardly unusual example of the northern Midwest style of construction. What makes this instrument unusual is the handsome fruit and vine motif that someone has carefully stenciled in reds and yellows on its black outer case.

Another beautiful instrument, made by a man named Grill near Lansing, Michigan, around the turn of the century, shows what could be done by an enthusiastic and exacting folk craftsman (Figure 40). Grill decorated the case with herringbone veneer and inlaid bone. When the two round-grooved disks above the soundboard are removed, they reveal velvet-lined pockets in which the player could store hammers and extra wire.

The Grill instrument represents a high point of dulcimer construction by the folk-craftsman, but it also marks the end of an era. After the close of the 19th century, the dulcimer declined in

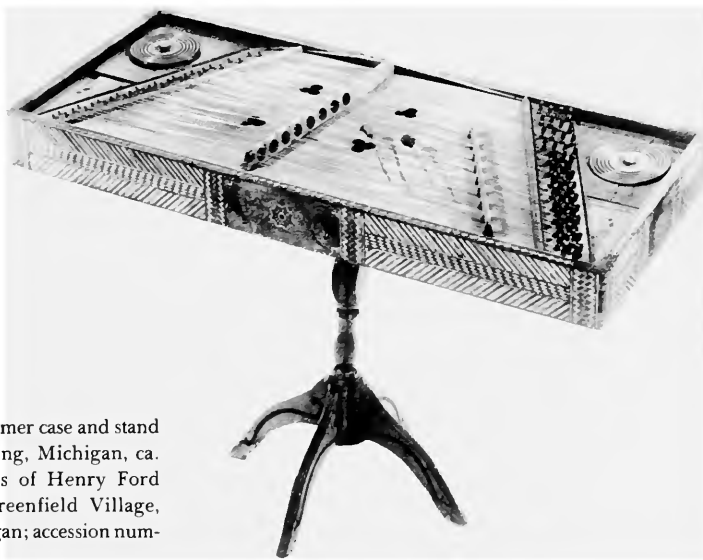

FIGURE 40.—Dulcimer case and stand by Grill of Lansing, Michigan, ca. 1890. (Collections of Henry Ford Museum and Greenfield Village, Dearborn, Michigan; accession number 33.4021)

popularity to such an extent that its use in America practically ceased by the early 1930s.

The Current Revival

In recent years the dulcimer has enjoyed a modest revival. Some claim this was sparked by Elgia C. Hickok (1894–1967), a traditional player from Sears, Michigan, who appeared at the 1964 Newport Folk Festival. Hickok returned to Michigan and, with the help of Chet Parker (1891–1975), another traditional player from Grand Rapids, organized the “Original Dulcimer Players Club.” (The term “original” was chosen by the founders to distinguish the hammered dulcimer from the then more popular plucked Appalachian dulcimer.) The club still meets regularly under the leadership of Eugene and Esther Cox, and it has been largely responsible for a revival of dulcimer playing in Michigan and Ohio.

Another traditional performer who has been important to the dulcimer’s revival is Russel Fluharty of Mannington, West Virginia, who in 1971 organized the Mountain Dulcimer club. Howard H. Mitchell of the Washington, D.C., area was one of the first revival players, and his instruction record and book, *The Hammered Dulcimer: How to Make It and Play It* (1972) introduced the instrument to a new audience.

In the last 10 years a growing number of dulcimer makers and performers have brought the instrument to the public’s attention. Today dulcimers are featured at folk festivals and concerts, and modern dulcimer recordings are occasionally played on the radio. This sometimes comes as a surprise to older traditional players who assume they are the last remaining dulcimerists anywhere in the country. Most are delighted to find fellow players, but as traditional and revival performers meet, trade tunes, and purchase each other’s recordings, dulcimer music can not help changing.

With this renewed interest many of the distinct regional styles, which have survived so long because of their isolation, will begin to disappear. Eventually, several regional styles might merge to form a unified "American" dulcimer style, but this will probably require many years to develop. Although the fading of local playing styles and regional dulcimer designs might be viewed with some trepidation by traditionalists, it does ensure the survival of the dulcimer in America for years to come.

Appendix A

A Chronological Tabulation of U.S. Patents Granted for Improvements to the Dulcimer

- (Patent number. Date granted, inventor, residence; assignor. Claim.)
- 28,811. 19 June 1860, John Low, Clinton, Worcester Co., Massachusetts; Nathan Bruce (1792–1876, Southboro, Massachusetts).
Chromatic half step across treble bridge; bass bridge placed to left of treble bridge.
- 72,824. 31 December 1867, Ezra Durand, Norwich, New London Co., Connecticut.
Perforated soundpost and bridges.
- 84,027. 10 November 1868, William Vogel, Norwich, New London Co., Connecticut; Ezra Durand.
Iron bridges, perforated braces; damping pedal operated by a foot lever.
- 171,031. 14 December 1875, James A. MacKenzie, Minneapolis, Hennepin Co., Minnesota.
Separate sets of strings on opposite sides of reversible dulcimer body; adjustable fret blocks.
- 440,601. 11 November 1890, James A. MacKenzie, Minneapolis, Hennepin Co., Minnesota.
Longitudinally arched metal frame and braces for soundboard support.
- 461,915. 27 October 1891, James A. MacKenzie, Minneapolis, Hennepin Co., Minnesota.
Piano harp with 3 sounding chambers in an upright piano case.
- 479,323. 19 July 1892, Ignatius D. Bagasarian, Cambridge, Massachusetts (subject of the Sultan of Turkey).
Individual bridges; placement of hitch- and tuning pins on side of instrument (similar to Turkish dulcimer).
- 582,537. 11 May 1897, Jesse Merrill, Kanopolas, Ellsworth Co., Kansas.
Improved bridges; lifting rod arrangement to adjust playing level.

- 625,663. 23 May 1899, Roland William Everton and William Frost, Troy, Rensselaer Co., New York.
Offset wrest plates.
- 808,374. 26 December 1904, Edwin G. James, South Milwaukee, Milwaukee Co., Wisconsin.
Metal auxiliary frame, tension rods anchored in the pinblocks; hollow tubular metal bridges.
- 871,463. 19 November 1907, Ferdinand Wagner, New York, New York.
Improved *cimbalom* dampers.

Appendix B

Dulcimer Makers

Listed below are the names of the traditional dulcimer builders whose instruments the author has seen or heard about during the course of this study. Also included are the names of those inventors granted United States Patents for dulcimer improvements, although it is likely that several of them never produced working models of their claims.

The current revival of interest in the dulcimer has inspired a new, large, and often talented generation of craftsmen-builders. Since the emphasis of this monograph is on the history of the dulcimer, the prerevival year of 1960 has been chosen as a cut-off point for inclusion in this list.

An asterisk indicates that a patent was granted to the maker.

Maker	Location	Dates
*Bagdasarian, Ignatius D.	Cambridge, Massachusetts	ca. 1892
Bates, Martin	Mt. Effrum, Numa Center, Ohio	ca. 1850
Bogges, George Washington and his son, Jerry	McFarland, West Virginia	late 19th– early 20th
Bryant, Charles Henry	Thornston, New Hampshire	1870s
	Wolfsboro, New Hampshire	1898
Campbell, Ralph (1905–?)	Mannington, West Virginia	mid-20th
Delano, Mortimer (1823, Henrietta, N.Y.–?); Oscar F., Edwin, and Myron E.	Oxford, Michigan	1870s
Doolittle, Thomas J. (18 Jul 1853–?)	Marion County, West Virginia	1870s–1880s
*Durand, Ezra	Norwich, Connecticut	1867–1869
*Everton, Roland William	Troy, New York	ca. 1899
Evislizer, Otis	Ypsilanti, Michigan	? ca. 1870

Fluharty, Russell (1907-)	Mannington, West Virginia	20th
*Frost, William	Troy, New York	ca. 1899
Grill, ?	Lansing, Michigan	? 1890s
Hackett, Eugene, and Joseph "Wheel" (1834-1908)	Liberty Center, Ohio	1890
Hulan, Sam, George, and Minor	near Nashville, Tennessee	ca. 1885-1900
*James, Edwin G.	South Milwaukee, Wisconsin	ca. 1905
Jones, Harvey (1912-)	Coleridge, North Carolina	ca. 1950- present
Koleszar, John	New York, New York (<i>cimbalom</i> s)	? early 20th
*Low, John (16 Sep. 1816-?)	Clinton, Massachusetts	late 1850s- 1860s
Lyon and Healy	Chicago, Illinois	late 19th- 1903
*MacKenzie, James A. (1845-4 May 1905)	Minneapolis, Minnesota	? 1875-1905
Martin, Jesse (1854-1939)	Frewsberg, New York	late 19th- early 20th
Matheny, Morgan	Lubeck, West Virginia	late 19th- early 20th
Matheny, Reuben, Sr. (1809-1877)	Harrisville, West Virginia	
Matheny, Reuben, Jr. (1857-1936)	Waverly, West Virginia	ca. 1880
	Parkersburg, West Virginia	ca. 1890
Mayfield, Ira, Sr. (1865-?) and his son, Mayfield, Ira, Jr. (1886-1972)	Tyler County, West Virginia	late 19th- 20th
*Merrill, Jesse	Kanopolos, Kansas	ca. 1897
Parker, Chet (1891-1975)	Grand Rapids, Michigan	early 20th
Phillips, Fred	Asheboro, North Carolina	early-mid- 20th
Price, Joseph (1856-?)	Metz, West Virginia	late 19th
Price, Raymer(?)	Mannington, West Virginia	? 1890-1910
Ransom, Henry (1809-1863)	Sherman, New York	1856-1860
	Newport, Kentucky	1860-1863
Robbins, ?	North Carolina	? late 19th
Sackett, Hiram (1824-?) and Morgan (1827-1919)	Irving, New York	1850s

Scott, Mann	Ramseur, North Carolina	? early 20th
Skiff, Milo	Sharon, Connecticut	? mid-19th
Stonitsch, ?	Brooklyn, New York	1870s
Stroehlein, Joseph E.	Brooklyn, New York	? late 1870s
Sweet, Orrin	Verona, Dane County, Wisconsin	ca. 1857
Thomas (family)	Pea Ridge, Arkansas	1870s
Thurston, William	Farmington, Michigan	1860s
Varner, William (1858-1937)	Mannington, West Virginia	ca. 1880- 1937
*Vogel, William	Norwich, Connecticut	ca. 1868
Wade, Lewis S., and Harrison (1828-1900)	Stedman, New York	1855-1860
*Wagner, Ferdinand	New York, New York	ca. 1907
Wight, Perry (1825-1900)	South Alabama, Genesee County, New York	mid- to late 19th
Wooten, ?	Porum's Landing, Porum, Oklahoma	? early 20th

Appendix C

Biographical Sketches of Informants

(Biographical information on informants who have been quoted extensively in the course of this monograph.)

CAFORALI, GENO.—Born Florence, Italy. The only surviving member of Henry Ford's Early American Orchestra. Played string bass with the orchestra at night and worked in the auto plant during the day. After the group disbanded, worked as a security guard at Henry Ford Museum and continued to play dances as a freelance musician. (Interviewed at the Henry Ford Museum, summer 1975. No transcript available.)

FLUHARTY, RUSSELL.—Born 1907, Mannington, West Virginia. An old-time traditional musician who plays "anything with strings on it." Learned dulcimer from his uncle; played in local dance bands and traveling medicine shows. One of the very few performers who continued to perform publicly from the 1940s through the 1960s. Earned his living as a potter before his retirement. President of the Mountain Dulcimer Club. (Interviewed at his home outside of Mannington, West Virginia, 28 June 1977. Further conversation October 1977.)

MATHENY, HERMAN E.—Born 1910, Fargesberg, West Virginia. A descendant of the 19th century Matheny clan of dulcimer makers in Harrisville; claims his lineage can be traced back to 16th century Huguenot instrument makers. Retired security guard for Goodyear Tire and Rubber Company. Builds reproductions of ancient musical instruments, and collects information on instrument builders. (Interviewed at his home in Uniontown, Ohio, 29 June 1977. Further correspondence, 1977 and 1978.)

SINCLAIR, CLOISE.—Born ca. 1905, Sheridan Township, Michigan. Learned to play by watching his father, Eugene Sinclair. After the latter's early death, laid music aside for many years. Farmed in Sheridan. Has recently begun to perform again with his brother Harley. Plays mostly at social gatherings and festivals; feels that the dulcimer was meant to play hymns and old-time music, but not dances. (Interviewed at the Original Dulcimer Players Meeting at Ewart, Michigan, 22-24 July 1977.)

VAN ARSDALE, PAUL.—Born 1920, Warren Co., Pennsylvania. Learned to play dulcimer from his maternal grandfather, the vaudeville star Jesse Martin, who lived with Paul's family during the 1920s and 1930s. Learned from him a large repertoire of unusual and beautiful dulcimer tunes; also composes. Has recently begun to

perform outside his family circle again after many years. Works as tool grinder at an aerospace plant. (Interview conducted at his home in North Tonawanda, New York, 30 June 1977. Additional conversation October 1977 [no transcript available]. Further conversations and correspondence 1977 and 1978.)

Appendix D

Dulcimers in the Collections of the Smithsonian Institution

Catalog number (accession number); negative numbers of available photographs.

Provenance.

Acquisition information.

Physical data (shape; measurements in cm; number of courses/number of strings per course).

Remarks.

94,868 (23,744); 8,222. Maker unknown; ?Italian; 18th century.

Gift of Edward P. Mason, Boston, Massachusetts, December 1890.

Trapezoidal; length 40.0 (top) 71.4 (bottom), width 29.0, depth 7.9; 20/4.

Carved molding around soundboard; 2 circular toneholes; gesso; gilded; floral painted design on case sides.

94,871 (23,822); 8,222, 78-4918. Maker unknown; ?Fulton Co., New York; ca. 1847.

Gift of F.S. Hawley, Broadalbin, Fulton Co., New York, 1890.

Trapezoidal; length 47.4 (top) 107.0 (bottom), width 39.5, depth 9.1; 11/4 and 6/2.

Grained sides; chessman bridges; 2 small circular toneholes (see Figure 2; detailed technical drawing available from the Division of Musical Instruments, National Museum of American History, Smithsonian Institution).

94,872 (23,894); 8,222. Made by Ezra Durand; Norwich, Connecticut; 1868.

Rectangular parlor model; length 111.1; width 52.2; depth 13.8, height 78.4; 22/2.

Even number of bass and treble courses; rosewood case with 4 curved legs, rounded corners, 2 circular toneholes each surrounded by 10 smaller holes, blue velvet lamp stands (see Figure 23).

95,049 (25,819). Maker and date unknown.

Purchased from Leopoldo Franciolini, Florence, 1900.

Trapezoidal; length 46.0 (top) 78.2 (bottom), width, 34.5, depth 7.3; 24/4.

Painted; gilt paper around both toneholes; originally 6 strings per course; 3 sets of bridges (low bass on the left); 4 short legs.

95,289 (26,256); 8,222. Maker unknown; ?Florence; late 19th century.

Purchased from Leopoldo Franciolini, Florence, 1900.

Trapezoidal; length 41.0 (top) 76.0 (bottom), width 32.2, depth 7.9; 10/4 and 14/3.

- Painted landscape with cherubs and coat of arms; 2 gilded rosettes; faked worm holes; painted hinged outer case.
95,290 (26,265); 8,222, 5,790-F. Maker unknown; ?Florence; ?late 19th century.
Purchased from Leopoldo Franciolini, Florence, 1900.
Trapezoidal; length 38.2 (top) 69.4 (bottom), width 31.6, depth 7.7; 12/3 and 10/4.
Painted with cherubs and wreaths; 2 gilt parchment rosettes; 3 short knobbed feet; faked worm holes.
- 95,291 (26,256); 8,222. Maker unknown; ?Florence; ?late 19th century.
Purchased from Leopoldo Franciolini, Florence, 1900.
Trapezoidal; length 39.2 (top) 67.0 (bottom), width 28.8, depth 7.3; 21/4.
Top painted in muted colors with floral and cherub design; sides blue with scroll motif; chessman bridges; 2 gilded parchment rosettes; painted hinged outer case.
- 95,318 (26,256); 8,222. Maker unknown; ?Italy; late 18th or early 19th century.
Purchased from Leopoldo Franciolini, Florence, 1900.
Trapezoidal; length 54.0 (top) 115.7 (bottom), width 57.5, depth 12.2; 36/3.
Large instrument decorated with painted scene of 11 figures in classical or biblical scene; lacks a back; no tonehole.
- 96,464 (30,688). Maker unknown; Poltava, Malo Russia; 19th century.
Acquired from Lubny Museum, Poltava, Malo Russia, 1896.
Trapezoidal; length 57.0 (top) 78.6 (bottom), width 24.3, depth 6.9; 11/4 (?).
Tsimbaldi, folk dulcimer of Malo Russia; painted dark brown; has 2 carved rosettes in soundboard and large oval hole in side.
- 288,325 (58,852); 72-1352. Maker unknown; ?Pennsylvania; ?1870s.
-
- Rectangular; length 99.6, width 41.8, depth 9.7; 12/3 and 7/2.
Burl walnut veneered box with spruce (?) soundboard; two 7 cm tilde-shaped toneholes; with plain case.
- 299,841 (61,285); 56,344, 56,344-A (top view). Maker unknown; American; ca. 1860.
Gift of Hugo Worch, 1917.
Rectangular parlor model; length 109.0, width 48.3, depth 11.7, height 78.1; 22/2.
Rosewood veneered case with square corners; four turned legs and hinged cover; 2 circular toneholes surrounded by 10 smaller holes; blue velvet lamp stands (see Figure 1).
- 331,204 (28,811); 78-4920. John Low; Clinton, Massachusetts; 1860.
-
- Rectangular; length 30.5, width 12.7, depth 5.1; 21/2.
Patent model; separate hitch pins for bass and treble bridges (see Figure 5).
- 332,324 (94,380); 78-4924. Ezra Durand; Norwich, Connecticut; 1967.
-
- Rectangular; length 30.1, width 14.6, depth 5.4; 9/2.
Crude patent model (see catalog number 94,872; Figures 22, 23.)

60.1407 (2682.38 B2). Maker unknown; German or German-American; early 20th century.

Trapezoidal; length 68.6 (top) 106.3 (bottom), width 43.7, depth 7.5; 20/4 and 2/3 (low bass).

Two sets of *cimbalom*-type dampers activated by hand-operated levers; gold paint; jigsaw-cut bird rosettes (formerly in Cooper Union Collection).

1982.0530. Maker unknown, ?American, late 19th century.

Trapezoidal; length 48.4 (top) 105.0 (bottom), width 38.2, depth 7.2; 27/4.

Painted pine; gilt mouldings on soundboard edge; hand-forged pins; round brass fittings in each tonehole.

78.7 (1978.0614); 78-8907. John Palanuk; Springfield, Oregon; 1974.

Trapezoidal; length 89.0 (top) 123.0 (bottom), width 44.5, depth 8.5; 19/5.

Ukrainian folk dulcimer made in America; spruce soundboard with birch case sides and plywood bottom; single bridge and two slotted toneholes.

1981.0530.06; 81-16679, 81-16680. Maker unknown; ?New England; mid-19th century.

Purchased at auction of the Clifford Allanson collection.

Rectangular; length 97.7, width 38.4, depth 10.0; 11/3 and 7/2.

Yellow-brown varnished body ornamented with stencil-cut rosewood veneer; with weathered, unhinged, crude pine case.

Appendix E

Selected Discography

- Austen, Seth, and Madeline MacNeil
N.d. Ye Banks and Braes. Roots and Branches Recordings RBR 002. [Available from Front Hall Records, RD1, Wormer Road, Voorheesville, NY 12816.]
- Carawan, Guy
1976. Green Rocky Road. June Appal 021. [Available from June Appal Recordings, Box 743, Whitesburg, KY 41858.]
1979. Jubilee. June Appal 029. [Available from June Appal Recordings.]
- Carter, Dorothy
N.d. Troubador. Celeste Records 1003. [Available from Front Hall Records.]
- Collins, Mitzie
1976. A Sampler of Folk Music. Sampler Records 7601. [Available from Front Hall Records.]
1979. The Leaves of Life. Sampler Records 7902. [Available from Front Hall Records.]
- Cook, Russell
N.d. Red-Haired Boy. Sword and Shield Recordings 9201. [Available from Front Hall Records.]
- Cooper, Billy
N.d. Bocastle Breakdown. Topic Records 12T40 (British).
- Daglish, Malcolm, and Grey Larsen
1977. Banish Misfortune. June Appal 016. [Available from June Appal Recordings.]
1979. The First of Autumn. June Appal 026. [Available from June Appal Recordings.]
- Fluharty, Russell
N.d. West Virginia Heritage. Page Records 601. [Available from Russell Fluharty, RD#3, Box 119, Mannington, WV 26582.]
- Gillett, Lilah, and Harvey Prinz
1978. Prairie Wild Flowers. Audio House AHKBA27F78. [Available from Front Hall Records.]
- Gardner, Worley
N.d. Mountain Melodies: Tunes of the Appalachians. OL-3-7-2 (stereo). [Available from Worley Gardner, 1332 Cain St., Morgantown, WV 26505.]
- Herrmann, Sam, with the Critton Hollow String Band.
1979. Poor Boy. Yodel-Ay-Hee 108327. [Available from Front Hall Records.]

Looman, Patty, and Russell Fluharty

N.d. Dulcimore. Page Records 602. [Available from Front Hall Records.]

Maxson, Charles, and Karen Skidmore

N.d. From the Heart of West Virginia. Peaceable Records. [Available from Peaceable Records, Box 77038, Los Angeles, CA 90007.]

MacKenzie, Tom

1980. Finally Tuned. Rooster Recordings 104. [Available from Front Hall Records.]

McCutcheon, John, et al.

1975. How Can I Keep from Singing. June Appal 003. [Available from June Appal Recordings.]

1977. The Wind That Shakes the Barley. June Appal 014. [Available from June Appal Recordings.]

1982. Fine Times at Our House. Greenhays GR710. [Available from Front Hall Records.]

McCutcheon, John, with Rye Straw

1978. From Earth to Heaven. June Appal 028. [Available from June Appal Recordings.]

Michael, Walt, and Tom McCreesh

1978. Dance, Like a Wave of the Sea. Front Hall Records FHR 017. [Available from Front Hall Records.]

Michael, Walt, Tom McCreesh, and Harley Campbell

1980. The Host of the Air. Front Hall Records FHR 023. [Available from Front Hall Records.]

Mitchell, Howard W.

1970. The Hammered Dulcimer: How to Make It and Play It (book and record). Folk-Legacy FSI-43. [Available from Folk Legacy Records, Sharon CT 06069.]

Original Dulcimer Players Club, The

1981. The American Hammered Dulcimer. Traditional Records TR-006. [Available from Front Hall Records.]

Parker, Chet

1966. The Hammer Dulcimer Played by Chet Parker. Folkways FA2381.

Rey, John

N.d. Drops of Brandy. Topic Records 287 (British).

N.d. Irish Music on the Hammered Dulcimer. Topic Records 373 (British).

Rizzetta, Sam

1982. Bucks and Does. Flying Clouds Music FCM-3. [Available from Front Hall Records.]

Round, Jay, et al.

1974. The Hammered Dulcimer Album. Turnaround 4054. [Available from

- Jay Round, 6470 Eighth Ave., Grandville, MI 49418, or from Front Hall Records.]
1977. One Time Friend. Turnaround 5003. [Available from Jay Round or Front Hall Records.]
1980. Don't Get Around Much Any More. Turnaround 5004. [Available from Jay Round or Front Hall Records.]
- Round, Jay, with the Williams Family
1975. Columbus Stockade Blues. Turnaround Records 5002. [Available from Jay Round or Front Hall Records.]
- Smith, Jerry Read, and Tom Fellendaum
1981. The Strayaway Child. Song of the Wood Records 01. [Available from Front Hall Records.]
- Spence, Bill, with Fennig's All-Star Band
1973. The Hammered Dulcimer. Front Hall Records FHR-01. [Available from Front Hall Records.]
1975. Saturday Night in the Provinces. Front Hall Records FHR-05. [Available from Front Hall Records.]
1977. The Hammered Dulcimer Strikes Again. Front Hall Records FHR010. [Available from Front Hall Records.]
1981. Fennigmania. Front Hall Records FHR-204. [Available from Front Hall Records.]
- Trapezoid (Sam Rizzetta, Paul Reisler, Pete Vigour, and Paul Yeaton)
1975. Trapezoid. Troubadour Records TR-1.
1978. Three Forks of Cheat. Rounder Records 0113. [Available from Front Hall Records.]
1980. Now and Then. Flying Fish Records 239. [Available from Front Hall Records.]

Notes

(Full references in Literature Cited)

1. Josiah Combs, *Folk-Songs of the Southern United States*, page 95.
2. J. Scott Odell, conversation with the author, Washington, D.C., 1978.
3. Russel Fluharty, interview with the author, Mannington, West Virginia, 28 June 1977, see transcript, page 4 and Appendix C.
4. Paul Van Arsdale, conversation with the author, North Tonawanda, New York, October 1977.
5. Sibyl Marcuse, *A Survey of Musical Instruments*, page 177.
6. *Ibid.*
7. Curt Sachs, *The History of Musical Instruments*, page 118.
8. *Ibid.*, page 188.
9. *Ibid.*, page 257.
10. Sir George Grove, *Grove Dictionary of Music and Musicians*, volume VI, page 1027.
11. This is antedated by a dulcimer on the ivory bookplate of the Egerton Codex, a 12th century Byzantine artifact now in the British Museum. That instrument is of the Turkish type, however, and hence falls outside the scope of this study. See Marcuse, *Survey of Musical Instruments*, page 223.
12. Marin Mersenne, *Harmonie Universelle: The Books on Instruments*, pages 225–226.
13. Quoted by Francis W. Galpin, *Old English Instruments of Music; Their History and Character*, page 64. Galpin also argues that an 8th century Irish instrument called the *timpan* or *tympanum* was originally a psaltery that later evolved into a dulcimer. If so, it would antedate the earliest known European board-zither by several centuries. See Galpin, *A Textbook of European Musical Instruments*, pages 67–70.
14. Quoted in Marcuse, *A Survey of Musical Instruments*, page 224.
15. *Ibid.*
16. Michael Praetorius, *Syntagma Musicum de Organographia*, volume II, page 79.
17. Samuel Pepys, *The Diary of Samuel Pepys*, volume III, pages 90, 198.
18. *Ibid.*, page 248.
19. Sir John Graham Dalyell, *Musical Memoirs of Scotland*, page 260.
20. *Ibid.*, page 260.
21. Sarah E. Hanks, "Pantaleon's Pantaleon: An 18th Century Musical Fashion," pages 215–228.
22. Percy A. Scholes, *The Puritans and Music in England and New England: A Contribution to the Cultural History of Two Nations*, page 42.

23. Oscar Sonneck, *Francis Hopkinson and James Lyon*, page 17.
24. Norman Arthur Benson, "The Itinerant Dancing and Music Masters of Eighteenth Century America," page 231.
25. Lubov Keefer, *Baltimore's Music: The Haven of the American Composer*, page 19.
26. *New-York Gazette Revived in the Weekly Post-Boy*, 27 April 1757.
27. Emelyn Gardner and Geraldine Chickering, *Ballads and Songs of Southern Michigan*, page 7.
28. Patrick R. Murphey, "The Hammered Dulcimer Played by Chet Parker," record notes.
29. Henry Wharton Shoemaker, *Mountain Minstrelsy of Pennsylvania*, page 7.
30. *Ibid.*, page 199.
31. Cloise Sinclair, interview with the author, 22 July 1977.
32. Paul Van Arsdale, interview with the author, 30 June 1977; see transcript, page 11.
33. David Kettlewell, "The Dulcimer and Related Instruments with Particular References to Traditional English Music," page 132.
34. Herman Matheny, interview with author, Uniontown, Ohio, 29 June 1977; see transcript, page 12.
35. Paul Van Arsdale, interview; see transcript, page 16.
36. Matheny, interview; transcript, page 8.
37. Fluharty, interview; transcript, page 11.
38. Van Arsdale, interview; transcript, page 11.
39. Matheny, interview; transcript, pages 8 and 11.
40. Hans Nathan, *Dan Emmett and the Rise of Early Negro Minstrelsy*, page 149.
41. Van Arsdale, interview; transcript, page 17.
42. Matheny, interview; transcript, pages 7–8.
43. Cloise Sinclair, interview with the author, Ewart, Michigan, 22–24 July 1977; transcript, page 1.
44. *Greensboro Daily News*, "Hammered Dulcimer Virtuoso," 18 May 1977, section B, page 1.
45. H. Wiley Hitchcock, *Music in the United States: A Historical Introduction*, pages 62–65.
46. Van Arsdale, interview; transcript, page 8.
47. Gino Caporali, conversation with the author, Dearborn, Michigan, summer 1975.
48. The author is indebted to Paul Van Arsdale and his family for access to the scrapbook of newspaper clippings kept by his grandfather, Jesse Martin. Unfortunately, most of the notices about Martin's performances are undated.
49. Allen Koenigsberg, *Edison Cylinder Records, 1889-1912; with an Illustrated History of the Phonograph*, page 14.
50. Fred Kunz. Correspondence with Cynthia Hoover, Division of Musical Instruments, National Museum of American History, 16 December 1964.

51. Jesse Martin, scrapbook.
52. *Capital Times* (Madison, Wisconsin), 22 March 1977.
53. Charles K. Wolfe, *The Grand Old Opry: The Early Years, 1925-1935*, page 8.
54. S.J. Sackett, "The Hammered Dulcimer in Ellis County, Kansas," pages 61-64.
55. Lewis Miller, *Sketches and Chronicles; The Reflections of a Nineteenth Century Folk Artist*, page 66.
56. United States Patent Number 28,811. Granted 19 June 1860 (see Appendix A).
57. *Ibid.*
58. Correspondence with Elizabeth Alden, The Clinton Historical Society, Clinton, Massachusetts, 22 December 1977.
59. *Boston Public Library Dictionary Catalogue of the Music Collection*, volume 6, page 26.
60. Board of Music Trade of the U.S.A., *Complete Catalogue of Sheet Music and Musical Works, 1870*, page 73.
61. United States Patent Number 72,824. Granted 31 December 1867.
62. *Norwich City Directory*, Norwich, Connecticut, 1867, 1868, 1869.
63. Ezra Durand, *Dulcimer Without a Master*, page iii.
64. *Ibid.*, page 49.
65. Charles H. Weygant, *The Sacketts of America: Their Ancestors and Descendants, 1630-1907*, page 266.
66. The author is indebted to Richard Sackett and his family of Bethesda, Maryland, for access to family papers and information.
67. Paul Gifford, "Development of the Hammered Dulcimer," pages 19-23.
68. Floyd L. Darrow, *History of the Town of North Harmony, Chautauqua County, New York*, volume 2, pages 80-81.
69. *Ibid.*, page 81.
70. *Ibid.*, volume 1, page 130.
71. Elizabeth L. Crocker, *Yesterdays in and around Pomfret, New York*, volume V, pages 41-42.
72. United States Census of 1860, "Manufacturing Schedule, Campbell County, Kentucky."
73. MacKenzie also spelled his name "McKenzie" and "Mckenzie."
74. United States Patent Number 171,031. Granted 14 December 1875, page 1.
75. United States Patent Number 440,601. Granted 11 November 1890, page 2.
76. *Ibid.*
77. United States Patent Number 461,915. Granted 27 October 1891, page 1.
78. There is no record at the Library of Congress of this book actually having been copyrighted.
79. *Minneapolis Tribune*, Sunday, 7 May 1905, page 7, column 3. The author is indebted to Floyd Cohoes of Forest Lake, Minnesota, and Mrs. R. Thorsenson of the Hennipin County Historical Society for information on MacKenzie's life and work.

80. *Montgomery Ward and Company Catalog for Spring and Summer 1895*, reprinted edition, page 244.
81. *Ibid.*, page 244.
82. *Sears, Roebuck and Company Catalog, 1902*, page 208.
83. *American Piano Supply Company Catalog, 1974*, page 72.
84. Matheny, interview, transcript, page 17.
85. Harry Bryant's son, Oliver H. "Ole" Bryant (1873-1940), later operated one of Boston's finest violin shops, O.H. Bryant and Sons from 1910 to 1940. Information on Harry Bryant was supplied by his granddaughter, Mrs. Helen Treanor of Washington D.C., October 1977.
86. Information supplied by Evelyn Hamlin of the Sharon, Connecticut, Historical Society. Conversation with the author, May 1978.
87. *Greensboro* (North Carolina) *Daily News*, undated clipping (1977?). The author thanks Coleman Emerson of Salisbury, North Carolina, for contributing information on Piedmont instrument makers.
88. Matheny, interview; transcript, page 7. The informant had not personally tried these folk finishes and there is no guarantee they would work.
89. *Ibid.*, page 7.
90. Sinclair, interview; transcript, page 6.
91. The author is indebted to H.E. Matheny and Russell Fluharty for the names and dates of these dulcimer makers.
92. Matheny, interview; transcript, page 5.
93. *Ibid.*, page 11.
94. *Capital Times* (Madison, Wisconsin), 22 March 1927.
95. Mrs. Edna Rigal, Liberty Center (Ohio) Public Library. Correspondence with the author, 1 March 1978. Letter deposited in Division of Musical Instruments, National Museum of American History, Smithsonian Institution.
96. Gifford, "Development of the Hammered Dulcimer," page 21.
97. Ralph and Lydia Muncy of Ann Arbor, Mich.; conversation with the author.
98. The author thanks Virginia Barons of the Genesee County, New York, Department of History for information about Wight. Letter deposited at the Division of Musical Instruments, National Museum of American History.
99. Matheny, correspondence with the author, 1 March 1978, and interview; transcript, page 7.
100. Fluharty, interview; transcript, pages 6-7.

Literature Cited

- American Piano Supply Company Catalog, 1974.* Hoboken, New Jersey, 1974.
- Benson, Norman Arthur. "The Itinerant Dancing and Music Masters of Eighteenth Century America." Doctoral dissertation, University of Minnesota, 1963.
- Board of Music Trade of the U.S.A. *Complete Catalogue of the Sheet Music and Musical Works, 1970.* New York: De Capo Press, 1973.
- Boston Public Library Dictionary Catalog of the Music Collection.* Volume 6. Boston: G.K. Hall, 1972.
- Capital Times.* (Madison, Wisconsin). 22 March 1927.
- Combs, Josiah. *Folk-Songs of the Southern United States.* Edited by D.K. Wilgus, Austin: University of Texas Press, 1967. [American Folklore Society, Bibliographical and Special Series, No. 19. French original published in Paris, 1925, *Folk-Songs du Midi des Etats-Unis.*]
- Crocker, Elizabeth L. *Yesterdays in and around Pomfret, New York,* volume V. Pomfret: Privately printed, 1964.
- Darrow, Floyd L. *History of the Town of North Harmony, Chautauqua County, New York.* 2 volumes. North Harmony: Privately printed, 1953, 1955.
- Dalyell, Sir John Graham. *Musical Memoirs of Scotland.* 1849. Reprint edition, Norwood, Pennsylvania: Norwood Editions, 1973.
- Durand, Ezra. *Dulcimer without a Master.* Boston: Oliver Ditson & Company, 1867.
- Galpin, Francis W. *A Textbook of European Musical Instruments.* New York: John de Graff Inc., 1937.
- _____. *Old English Instruments of Music: Their History and Character.* London: Methuen & Co., 1910.
- Gardner, Emelyn, and Geraldine Chickering. *Ballads and Songs of Southern Michigan.* Ann Arbor: University of Michigan Press, 1939.
- Gifford, Paul. "Development of the Hammered Dulcimer." *Mugwumps Magazine,* volume 3, number 5 (September, 1974), pages 19–23.
- Gottesman, Rita. *The Arts and Crafts in New York, 1726-1776.* 3 volumes. New York: New-York Historical Society, 1938–1965.
- Greensboro* (North Carolina) *Daily News.* 18 May 1977; undated clipping.
- Grove, Sir George. *Grove Dictionary of Music and Musicians.* Fifth edition, Eric Blom, editor, volumes VI, VII. New York: St. Martin's Press, Inc., 1959.
- Haight, C. *A Complete System for the Dulcimer.* New York: William Hall & Son, 1848.
- Hanks, Sarah E. "Pantaleon's Pantaleon: An Eighteenth Century Musical Fashion." *Musical Quarterly,* volume XV, number 2 (April 1969), pages 215–228.
- Hitchcock, H. Wiley, *Music in the United States: A Historical Introduction.* Englewood Cliffs, New Jersey: Prentice-Hall, 1974.

- Keefer, Lubov. *Baltimore's Music: The Haven of the American Composer*. Baltimore, Maryland: J.H. Furst, 1962.
- Kettlewell, David. *The Dulcimer and Related Instruments with Particular References to Traditional English Music*. B.M. thesis, University of Surrey, Guildford, 1973.
- Koenigsberg, Allen. *Edison Cylinder Records, 1889-1912; with an Illustrated History of the Phonograph*. New York: Stellar Productions, 1969.
- MacKenzie, James A. *Piano Harp Book: The Piano Harp is Here Played by Sight Without a Teacher by Using Letters*. [Minneapolis, 1891.]
- Marcuse, Sibyl. *A Survey of Musical Instruments*. New York: Harper & Row, 1975.
- Mersenne, Marin. *Harmonie Universelle: The Books on Instruments*. Two volumes, Paris: 1636, 1637. Reprint edition, Rodger E. Chapman, translator. The Hague: Martinus Nijhoff, 1957.
- Miller, Lewis. *Sketches and Chronicles; The Reflections of a Nineteenth Century Pennsylvanian Folk Artist*. Introduction by Donald A. Shelly. York: The Historical Society of York County, 1966.
- Minneapolis Minnesota City Directory*. 1895, 1896, 1897, 1898.
- Minneapolis Tribune*. 7 May 1905.
- Mitchell, Howard M. *The Hammered Dulcimer: How to Make It and Play It (After a Fashion)*. Huntington, Vermont: Folk Legacy Records, 1966 (record and booklet).
- Montgomery Ward and Company Catalog for Spring and Summer of 1895*. Reprint, New York: Crown Publications, 1973.
- Mugwumps Magazine*, "The Hammer Dulcimer Compendium." Silver Spring, Maryland: MIH Publications, 1977.
- Murphey, Patrick R. "The Hammered Dulcimer Played by Chet Parker." Liner notes. New York: Folkways Recordings, 1966 (Album No. FA2381).
- Nathan, Hans. *Dan Emmett and the Rise of Early Negro Minstrelsy*. Norman: University of Oklahoma Press, 1962.
- Newport City Directory*. Newport, Kentucky: 1861.
- New-York Gazette Revived in the Weekly Post Boy*. 27 April 1757.
- New York Times*. 20 December 1925, Rotogravure Section, page 1.
- Norwich City Directory*. Norwich, Connecticut: 1867, 1868, 1869.
- Odell, J. Scott. "Folk Instruments." *Arts in Virginia*, Fall, 1971.
- Pepys, Samuel. *The Diary of Samuel Pepys, 1660-1662*. R. Latham and W. Matthews, editors, volumes I-IV, (1660-1663). Berkley: University of California, 1970.
- Praetorius, Michael. *Syntagma Musicum de Organographia*, volume II. Wolfenbuttel, 1620. Reprint edition, Harold Blumenfeld, translator. New Haven: Yale University, 1949.
- Ripin, Edwin M. *The Instrument Catalog of Leopoldo Fanciolini*. Hackensack, New Jersey: J. Boonin, 1974.
- Sachs, Curt. *The History of Musical Instruments*. New York: W.W. Norton & Company, Inc., 1940.

- Sackett, S.J. "The Hammered Dulcimer in Ellis County, Kansas." *Journal of the International Folk Music Council*, volume XIV (1962), pages 61-64.
- Scholes, Percy A. *The Puritans and Music in England and New England: A Contribution to the Cultural History of Two Nations*. Oxford: Clarendon Press, 1934.
- Sears, Roebuck and Company *Catalog, 1902*. Chicago: 1902.
- Shoemaker, Henry Wharton. *Mountain Minstrelsy of Pennsylvania*. Philadelphia: N.F. McGirr, 1931.
- Sonneck, Oscar. *Francis Hopkinson and James Lyon*. New introduction by Richard Crawford. New York: Da Capo Press, 1966.
- United States Census of 1860. "Manufacturing Schedule: Products of Industry." Campbell County, City of Newport, Kentucky.
- Weigel, Johann Christoph. *Musikalisches Theatrum*. 1720. Reprint edition, Barenreiter Kassel: 1961.
- Weygant, Charles H. *The Sacketts of America: Their Ancestors and Descendants, 1630-1907*. Newburgh, New York: 1907.
- Wolfe, Charles K. *The Grand Old Opry: the Early Years, 1925-1935*. London: Old Time Music, 1975.

